

UC-NRLF



B 4 564 344

Cambridge
Physical Series

CONDUCTION OF ELECTRICITY
THROUGH GASES

LIBRARY

**UNIVERSITY OF
CALIFORNIA
SANTA CRUZ**

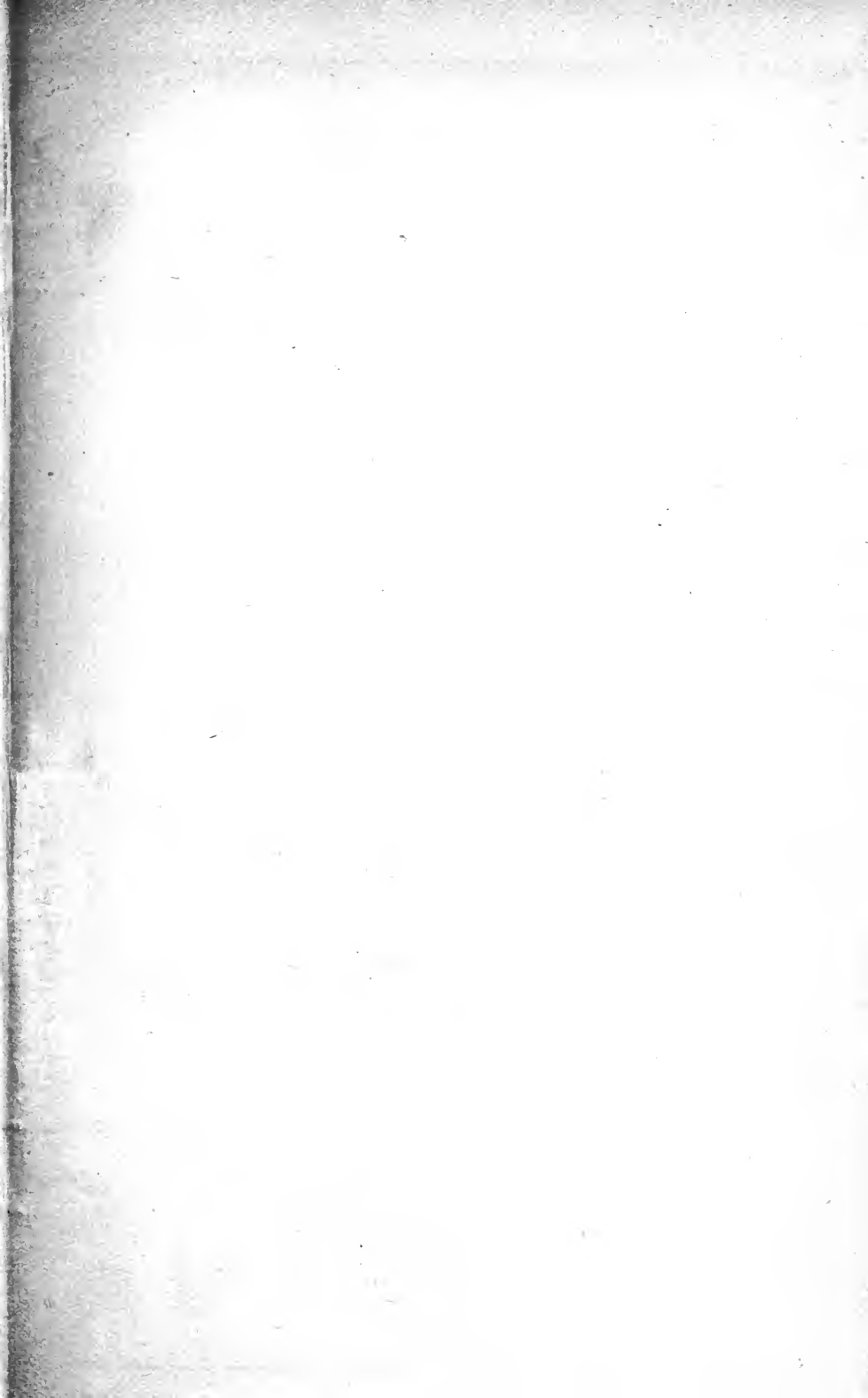

Digitized by the Internet Archive
in 2007 with funding from
Microsoft Corporation

CAMBRIDGE PHYSICAL SERIES.

CONDUCTION OF ELECTRICITY
THROUGH GASES

CAMBRIDGE UNIVERSITY PRESS WAREHOUSE,

C. F. CLAY, MANAGER.

London: FETTER LANE, E.C.

Glasgow: 50, WELLINGTON STREET.



ALSO

London: H. K. LEWIS, 136, GOWER STREET, W.C.

Leipzig: F. A. BROCKHAUS.

New York: G. P. PUTNAM'S SONS.

Bombay and Calcutta: MACMILLAN AND CO., LTD.

[All Rights reserved]

CONDUCTION OF ELECTRICITY THROUGH GASES



BY

J. J. THOMSON, D.Sc., LL.D., Ph.D., F.R.S.

FELLOW OF TRINITY COLLEGE, CAMBRIDGE

CAVENDISH PROFESSOR OF EXPERIMENTAL PHYSICS, CAMBRIDGE

AND PROFESSOR OF NATURAL PHILOSOPHY AT THE ROYAL INSTITUTION, LONDON

SECOND EDITION

12555

CAMBRIDGE:
AT THE UNIVERSITY PRESS

1906

First Edition 1903.
Second Edition 1906.

QC
711
T5
1906

PREFACE.

I HAVE endeavoured in this work to develop the view that the conduction of electricity through gases is due to the presence in the gas of small particles charged with electricity, called ions, which under the influence of electric forces move from one part of the gas to another. My object has been to show how the various phenomena exhibited when electricity passes through gases can be coordinated by this conception rather than to attempt to give a complete account of the very numerous investigations which have been made on the electrical properties of gases; I have therefore confined myself for the most part to those phenomena which furnish results sufficiently precise to serve as a test of the truth of this theory. The book contains the subject-matter of lectures given at the Cavendish Laboratory where a good deal of attention has been paid to the subject and where a considerable number of physicists are working at it.

The study of the electrical properties of gases seems to offer the most promising field for investigating the Nature of Electricity and the Constitution of Matter, for thanks to the Kinetic Theory of Gases our conceptions of the processes other than electrical which occur in gases are much more vivid and definite than they are for liquids or solids; in consequence of this the subject has advanced very rapidly and I think it may now fairly be claimed that our knowledge of and insight into the processes going on when electricity passes through a gas is greater than it is in the case either of solids or liquids. The possession of a charge by the ions increases so much the ease with which they can be

TABLE OF CONTENTS.

CHAP.		PAGE
I.	Electrical Conductivity of Gases in a normal state . . .	1
II.	Properties of a Gas when in the conducting state . . .	9
III.	Mathematical Theory of the Conduction of Electricity through a Gas containing Ions	84
IV.	Effect produced by a Magnetic Field on the Motion of the Ions	104
V.	Determination of the Ratio of the Charge to the Mass of an Ion	117
VI.	Determination of the Charge carried by the Negative Ion.	150
VII.	On some Physical Properties of Gaseous Ions	163
VIII.	Ionisation by Incandescent Solids	188
IX.	Ionisation in Gases from Flames	228
X.	Ionisation by Light. Photo-Electric Effects	250
XI.	Ionisation by Röntgen Rays.	291
XII.	Rays from Radio-active Substances	332
XIII.	Power of the Elements in general to emit ionising radiation.	410
XIV.	Ionisation due to Chemical Action, the bubbling of air through water, and the splashing of drops	420
XV.	Spark Discharge	430
XVI.	Discharge through Gases at Low Pressures.	528
XVII.	Theory of the Discharge through Vacuum Tubes	585
XVIII.	The Electric Arc	604
XIX.	Cathode Rays.	621
XX.	Röntgen Rays	644
XXI.	Properties of Moving Electrified Bodies	650
	INDEX	665

CHAPTER I.

ELECTRICAL CONDUCTIVITY OF GASES IN A NORMAL STATE.

1. A GAS in the normal state conducts electricity to a slight, but only to a very slight, extent, however small the electric force acting on the gas may be. So small however is the conductivity of a gas when in this state, and so difficult is it to eliminate spurious effects, that there have been several changes of opinion among physicists as to the cause of the leakage of electricity which undoubtedly occurs when a charged body is surrounded by gas. It was thought at first that this leakage took place through the gas; later, as the result of further experiments, it was attributed to defective insulation of the rods or threads used to support the body, and to the dust present in the gas; quite recently however it has been shown that there is a true leak through the gas which is not due to the dust or moisture the gas may happen to contain.

2. The escape of electricity from an insulated charged body has attracted the attention of many physicists. Coulomb*, whose experiments were published in 1785, came to the conclusion from his investigations on the loss of electricity from a charged body suspended by insulating strings, that after allowing for the leakage along the strings there was a balance over, which he attributed to a leakage through the air. He explained this leakage by supposing that the molecules of air when they come into contact with a charged body receive a charge of electricity of the same sign as that on the body and are then repelled from it, carrying off some of its charge. We shall see later on that this explanation is not tenable.

* Coulomb, *Mémoires de l'Académie des Sciences*, 1785, p. 612.

Matteucci* experimenting on the same subject in 1850 also came to the conclusion that there was a leakage of electricity through the gas; he was the first to prove that the rate at which this leak takes place is less when the pressure of the gas is low than when it is high. He found also that the rate of leak was the same in air, carbonic acid and hydrogen. On the other hand Warburg† found that the rate of leak through hydrogen was only about half of that through air and carbonic acid; he agreed with Matteucci with regard to the equality of the rate of leak through these gases and could detect no difference between the leaks through dry and moist air; he confirmed Matteucci's observations on the effect of pressure on the rate of leak. Warburg seemed inclined to suspect that the leak was due to dust in the gases. The belief in dust being the carrier of the electricity was strengthened by an experiment made by Hittorf‡ in which a small carefully insulated gold-leaf electroscope was placed in a glass vessel filled with filtered gas; the electroscope was found to have retained a charge even after the lapse of four days. We know now from recent experiments that the smallness of the leak observed in this case was due to the smallness of the vessel in which the charged body was placed rather than to the absence of dust.

Further experiments on this subject were made by Nahrwold§ and by Narr|| who showed that the rate of leak from a charged hollow sphere was not increased when the temperature of the sphere was raised by filling it with hot water. Boys¶ made an experiment which showed very clearly that, whatever the cause of the leak might be, it was not wholly due to want of insulation in the supports of the charged body; in this experiment he attached the gold leaves of an electroscope first to a short and thick quartz rod and then to a long and thin one, and found that the rate of leak of electricity from the gold leaves was the same in the two cases; if the leak had been along the supports it would have

* Matteucci, *Annales de Chimie et de Physique*, xxviii. p. 390, 1850.

† Warburg, *Pogg. Ann.* cxlv. p. 578, 1872.

‡ Hittorf, *Wied. Ann.* vii. p. 595, 1879.

§ Nahrwold, *Wied. Ann.* v. p. 460, 1878; xxxi. p. 448, 1887.

|| Narr, *Wied. Ann.* v. p. 145, 1878; viii. p. 266, 1879; xi. p. 155, 1880; xvi. p. 558, 1882; xxii. p. 550, 1884; xlv. p. 133, 1892.

¶ Boys, *Phil. Mag.* xxviii. p. 14, 1889.

been much greater in the first case than in the second. Boys also confirmed Warburg's observation that the rate of leak was the same in dry as in moist air.

3. The subject of the electric conduction through air is evidently of considerable importance in relation to Meteorology and Atmospheric Electricity. Experiments especially bearing on this point were made by Linss* on the loss of electricity from charged bodies placed in the open air; he found there was an appreciable loss of charge which, as control experiments showed, was not due to leakage along the supports of the charged body.

An extensive series of open air measurements were made by Elster and Geitel† in many different localities and in different states of the weather. They found that the rate of leak varied much from time to time and from place to place, that it was very much smaller in mist or fog than when the weather was bright and clear, that it was greater at high altitudes than at low ones, and that on the tops of mountains the rate of escape of negative electricity was much greater than that of positive. This is doubtless due to the negative charge on the earth's surface, a mountain top being analogous to a sharp point on a conductor, and thus a place where the earth's electric force tending to move away any negatively electrified body is much greater than it is on the flat. In plains they found the rate of leak to be the same for plus and minus charges. These points are brought out by the results of the observations given in Tables I. and II. Table I. gives the results of experiments made at Wolfenbüttel at different times. Table II. contains observations at different places.

TABLE I.

Weather	Rate of leak for + charge	Rate of leak for - charge
Fog, wind S.E.	2.77	2.64
Clear, air very transparent.....	8.58	9.82
Fine rain, mist	3.18	3.02
Sky half overcast, air very transparent...	13.67	13.83

* Linss, *Meteorol. Zeitschr.* iv. p. 352, 1887; *Elektrotechn. Zeitschr.* i. 11, p. 506, 1890.

† Elster and Geitel, *Ann. d. Physik.* ii. p. 425, 1900.

TABLE II.

Place and altitude	Weather	Rate of leak + charge	Rate of leak - charge
Brocken, 1140 m.	Sunshine, hazy	6.67	10.28
Weissbad, 800 m.	Sunshine, air clear	9.66	9.52
Säntisgipfel, ... 2500 m.	Sunshine, air very clear	8.95	35.04
Gornergrat, 3140 m.	Sunshine, air very clear	3.28	31.26
Zermatt Valley, 1620 m.	Sunshine	21.02	20.78
Wolfenbüttel, ... 80 m.	No clouds, air clear	8.45	9.20

Ebert* made a series of balloon ascents and observed the rate of leak at different altitudes up to about 4000 metres. He found the rate of leak to increase with the altitude. The excess of the leak from a negatively over that from a positively electrified body reached a maximum at a height between 2000 and 3000 metres. At the highest altitudes there was but little difference between the two leaks.

4. Further experiments on the rates of leak from a charged body placed in a closed vessel filled with air were made almost simultaneously by Geitel† and by C. T. R. Wilson‡. The apparatus used by Wilson for this purpose is represented in Fig. 1. Since

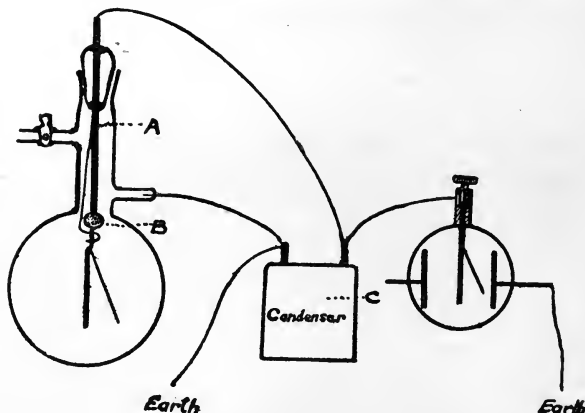

Fig. 1.

* Ebert, *Annalen der Physik*, v. p. 718, 1901.

† Geitel, *Physikalische Zeitschr.* ii. p. 116, 1900

‡ C. T. R. Wilson, *Proc. Camb. Phil. Soc.* xi. p. 32, 1900; *Proc. Roy. Soc.* lxxviii. p. 151, 1901.

the quantity of electricity which escapes from the charged body is very small it is necessary that the capacity of the instrument used to measure it should be small; this condition makes it advisable to use a small gold-leaf electroscope rather than a quadrant electrometer. To prevent the leakage from the supports of the gold leaves vitiating the experiments, the brass strip which carries the gold leaf is attached to and insulated from a metal rod *A* by a piece of sulphur *B*, *A* being insulated by a plug of sulphur from the vessel containing the gas under examination, and connected with a condenser *C* formed of parallel plates of metal imbedded in a block of sulphur. The brass strip and gold leaf are initially charged to the same potential as the rod by making momentary contact between the rod and the strip by means of a moveable wire; the rod being connected with a large capacity remains at almost constant potential, and thus if there is any leakage of electricity along the sulphur supporting the brass strip and gold leaf, it will tend to keep them charged and not to discharge them. The position of the gold leaf is read by means of a microscope provided with an eye-piece micrometer scale. The brass strip and gold leaf are used as the charged body and the rate at which the image of the gold leaf moves across the micrometer scale is a measure of the rate of leak through the gas. The following results were obtained by both Geitel and Wilson—the rate of escape of electricity in a closed vessel is much smaller than in the open and the larger the vessel the greater is the rate of leak. The rate of leak does not increase in proportion to the difference of potential between the gold leaves and the walls of the vessel; the rate soon reaches a limit beyond which it does not increase however much the potential difference is increased; provided of course that this is not great enough to cause sparks to pass.

Assuming that the maximum leak is proportional to the volume of the vessel, Wilson's experiments, which were made with vessels less than 1 litre in volume, showed that in dust-free air at atmospheric pressure the maximum quantity of electricity which can escape in one second from a charged body in a closed space whose volume is V cubic centimetres is about $10^{-8} V$ electrostatic units. Rutherford and Allen* working in Montreal obtained results in close agreement with this.

* Rutherford and Allen, *Physikalische Zeitschr.* iii. p. 225, 1902.

As the result of a series of experiments made at pressures ranging from 43 to 743 millimetres of mercury, Wilson came to the conclusion that the maximum rate of leak is very approximately proportional to the pressure, thus at low pressures the rate of leak is exceedingly small: this result is illustrated in a striking way by an observation of Crookes* that a pair of gold leaves could retain an electric charge for months in a very high vacuum. More recent experiments have shown that it is only in small vessels that the maximum rate of leak is proportional to the volume and to the pressure. With large vessels the rate of leak per unit volume is considerably less than in small vessels. The rate of leak also depends upon the nature of the walls of the vessel. The rate of leak is about the same in the dark as it is in the light, it is thus not due to light, and that it can be wholly due to some invisible form of radiation coming from outside is rendered improbable by the observations of Rutherford and Cooke†, Cooke‡, McClennan and Burton§ that though the leak inside a closed vessel can be reduced by about 30 per cent. by surrounding the vessel with thick lead yet the diminution reaches a limit when the lead is about 2 inches thick, after this no diminution in the leak is produced by increasing the thickness of the lead. The rate of leak in a closed vessel is the same when the vessel is inside a railway tunnel as when it is outside; in the former case any radiation reaching the gas from outside must have travelled through many feet of solid rocks. Wilson|| has recently investigated the greatest rates of leak through different gases and has obtained the following results:

Gas	Relative rate of leak	Relative rate of leak
		Specific gravity
air	1.00	1.00
H ₂	.184	2.7
CO ₂	1.69	1.10
SO ₂	2.64	1.21
CHCl ₃	4.7	1.09
Ni(CO) ₄	5.1	.867¶

5. Geitel (*loc. cit.*) made the very interesting observation that the rate of leak in a closed vessel increases, after the refilling of

* Crookes, *Proc. Roy. Soc.* xxviii. p. 347, 1879.

† Rutherford and Cooke, *Phys. Rev.* 16, p. 183, 1903.

‡ Cooke, *Phil. Mag.* 6. 6, p. 403, 1903.

§ McClennan and Burton, *Phys. Rev.* 16, p. 184, 1903.

|| Wilson, *Proc. Roy. Soc.* lxix, p. 277, 1901.

¶ Jaffe, *Phil. Mag.* 6. 8, p. 556, 1904.

the vessel with fresh air, for some days, when it reaches a constant value at which it remains for an indefinitely long time. The most obvious explanation of this result is that it is due to the settling down of the dust, as Elster and Geitel (*loc. cit.*) have shown that the presence of dust, fog, or mist diminishes the rate of leak. This explanation is however rendered untenable by some later experiments* made by the same physicists, in which they found that the period required for the gas to attain its maximum conductivity was not appreciably diminished by filtering the dust out of the air by sending it through water, or by extracting the moisture from the gas: thus if the increase in the rate of leak is due to the settling down of some foreign matter from the gas, this matter must be something which can not be got rid of by filtering the gas through water traps or plugs of glass-wool.

6. Another aspect of this phenomenon is the very interesting fact discovered by Elster and Geitel* that the rate of leak in caves, and cellars where the air is stagnant and only renewed slowly, is very much greater than in the open air: thus in some experiments they made in a cave—the Baumannshöhle in the Harz Mountains—they found that in the cave the electricity escaped at seven times the rate it did in the air outside, even when this was clear and free from mist. They found too that in a cellar whose windows had been shut for eight days the rate of leak was very considerably greater than it was in the air outside. These experiments suggest that something producing abnormally great conductivity slowly diffuses from the walls surrounding the gas, and that this diffusion goes on so slowly that when fresh gas is introduced it takes a considerable time for the substance from the walls to again diffuse through the volume. The reader will find the explanation of these effects given in a later chapter.

The experiments we have described show that the rate of leak of electricity through gas in a normal state is influenced by a great variety of circumstances, such as the pressure of the gas, the volume of gas in the electric field, and the amount of dust or fog held in suspension by it; all these effects receive a ready explanation on the view to which we are led by the study of the effects shown on a larger scale by gases whose conductivity has been increased by artificial means, and we shall return to the

* Elster and Geitel, *Physikalische Zeitschr.* ii. p. 560, 1901.

subject of the leak through normal air after studying the properties of such gases. We may however at once point out that the increase of the rate of leak with the size of the vessel containing the charged body shows that the conduction is not due, as Coulomb thought, to particles of gas originally uncharged striking against the charged body and receiving a charge which they deliver up to the sides of the vessel; if this were the method by which the electricity escaped the rate of leak would not increase with the size of the vessel.

CHAPTER II.

PROPERTIES OF A GAS WHEN IN THE CONDUCTING STATE.

7. THE electrical conductivity of gases in the normal state is so small that, as we have seen, the proof of its existence requires very careful and elaborate experiments. Gases may however in various ways be put into a state in which they conduct electricity with so much facility that the detection and investigation of this property becomes a comparatively easy matter; as the study of the properties of a gas when in this state is of the highest importance from the light which it throws on the general phenomena of electric discharge through gases we shall find it useful to discuss the subject at some considerable length.

8. There are many ways in which gases may be made to possess considerable conductivity or, as we shall express it, be put into the conducting state. They are for instance put into this state when their temperature is raised above a certain point; again, gases drawn from the neighbourhood of flames, electric arcs or glowing metals or carbon, or which have diffused from a space through which an electric discharge is passing or has recently passed, are in this state. A gas is put into the conducting state when Röntgen, Lenard or cathode rays pass through it, the same effect is produced by the rays from uranium, thorium, or the radioactive substances, polonium, radium, actinium, obtained from pitch-blende by Curie, Curie and Bemont and Dèbierne respectively, and also as Lenard has recently shown by a very easily absorbed kind of ultra-violet light. E. Wiedemann has shown that electric sparks give out rays, called by him *Entladungstrahlen*, which produce the same effect. Air which has passed over phosphorus or which has bubbled through water is also in this state and remains so for some time after it has left the phosphorus or

water. We shall have later on to discuss the action of each of these agents in detail, but we shall begin by studying some of the general properties possessed by a gas when in this state, the experimental methods by which these properties may be investigated, and a theory of this state by which they may be explained.

9. A gas when in the conducting state possesses characteristic properties. In the first place it retains its conductivity for some little time after the agent which made it a conductor has ceased to act; its conductivity however always diminishes, in some cases very rapidly, after the agent is removed, and finally it disappears. The persistence of the conductivity may be shown very simply by taking a charged electroscope covered with a cage made of wire-gauze so as to screen off the region exposed to the rays from the electrostatic field due to the electroscope. If the air is still, the electroscope will retain its charge even when the rays are in action, but if we blow some of the air traversed by the rays towards the electroscope, the latter will begin to lose its charge, showing that the air has retained its conductivity during the time taken by it to travel to the electroscope from the place where it was exposed to the rays. A somewhat more elaborate form of this experiment, which enables us to prove several other interesting properties of the conducting gas, is to place the electroscope in a glass vessel *A* in which there are two tubes, one leading to a water-pump while the end of the other *C* is in the region traversed by the Röntgen rays. The tube used to produce the rays is placed in a

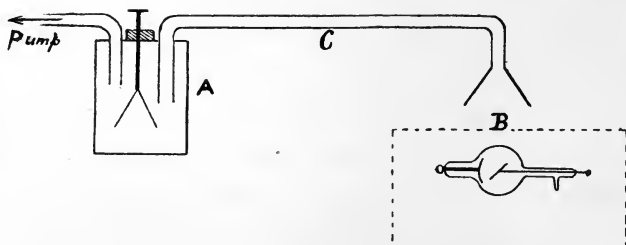

Fig. 2.

box which with the exception of a window at *B* to let the rays through is covered with lead: this shields the electroscope from

the direct action of the rays: if the water-pump be worked slowly so as to make a slow current of air pass from the region traversed by the rays into the vessel *A* the electroscope will gradually lose its charge whether this be positive or negative: if the pump be stopped and the current of air ceases, the discharge of the electroscope will cease.

The conducting gas loses its conductivity if it is sucked through a plug of glass-wool or made to bubble through water*. This can readily be proved by inserting in the tube *C* a plug of glass-wool or a water-trap and working the water-pump a little harder so as to make the rate of flow of air through the tube the same as in the previous experiment; it will now be found that the electroscope will retain its charge, the conductivity has thus been taken out of the gas by filtering it through glass-wool or water. The conductivity is very much more easily removed from gases made conducting by the various rays, Röntgen, Lenard, cathode, &c., than from the conducting gases derived from flames and arcs; the latter as we shall see require a great deal of filtering to remove their conductivity. If we replace the tube *C* by a metal tube of fine bore we shall find that the gas loses some of its conductivity when it passes through it, and the finer the bore the more rapidly does the conductivity disappear. The conductivity may also be removed from the gas by making it traverse a strong electric field so that a current of electricity passes through it†. To show this, replace the glass tube *C* by a metal tube of fairly wide bore and fix along the axis of this tube an insulated metal wire; if there is no potential difference between the wire and the tube, then the electroscope in *A* will leak when a current of air is sucked through the apparatus; if however a considerable difference of potential is established between the wire and the tube, so that a current of electricity passes through the gas during its passage to *A*, the leak of the electroscope will cease, showing that the conductivity of the gas has been removed by the electric field.

10. The removal of the conductivity by filtering the gas through glass-wool or water and by transmission through narrow metal tubes shows that the conductivity is due to something mixed

* J. J. Thomson and E. Rutherford, *Phil. Mag.* xlii. p. 392, 1896.

† *Ibid.*

with the gas, this something being removed from the gas in the one case by filtration, in the other by diffusion to the walls of the tube. Further, the removal of the conductivity by the electric field shows that this something is charged with electricity and moves under the action of the field; since the gas when in the conducting state shows as a whole no charge of electricity, the charges removed must be both positive and negative. We are thus led to the conclusion that the conductivity of the gas is due to electrified particles mixed up with the gas, some of these particles having charges of positive electricity, others of negative. We shall call these electrified particles ions, and the process by which a gas is made into a conductor the ionisation of the gas. We shall show later on how the masses and charges of the ions may be determined, when it will appear that the ions in a gas are not identical with those met with in the electrolysis of solutions.

11. The passage of a current of electricity through a conducting gas does not follow Ohm's law unless the electromotive force acting on the gas is small. We may investigate the relation between the current and potential difference by taking two parallel metal plates *A* and *B* (Fig. 3) immersed in a gas, the gas between the

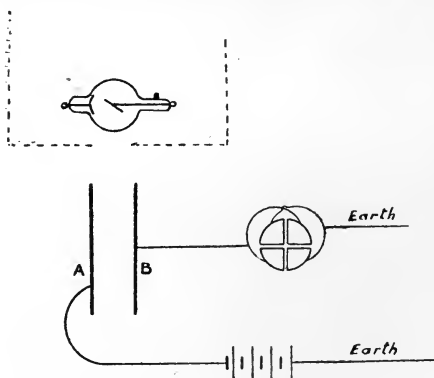

Fig. 3.

plates being exposed to the action of some ionising agent such as Röntgen rays or the radiation from a radioactive substance. One of the plates *A* is connected with one of the pairs of quadrants of an electrometer, the other pair of quadrants being put to earth. The other plate *B* is connected with one of the terminals of a

battery of several storage cells, the other terminal of the battery being connected with the earth; initially the two pairs of quadrants of the electrometer are connected together, then the connection between the quadrants is broken, as a current of electricity is passing across the air space between *A* and *B*, the plate *B* gets charged up and the needle of the electrometer is deflected; the rate of deflection of the electrometer measures the current passing through the gas. By making a series of observations of this kind we can get the means of drawing a curve such that the ordinates represent the current through the gas and the abscissæ the potential difference between the plates: such a curve is represented in Fig. 4*.

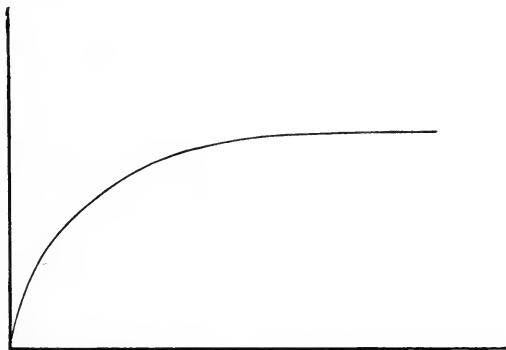

Fig. 4.

curve is approximately a straight line, in this stage the conduction obeys Ohm's law; the current however soon begins to increase more slowly than the potential difference and we reach a stage where there is no appreciable increase of current when the potential difference is increased: in this stage the current is said to be saturated. When the potential difference is increased to such an extent that the electric field is strong enough to ionise the gas, another stage is reached in which the current increases very rapidly with the potential difference; curves showing this effect have been obtained by von Schweidler† and by Townsend‡, one of these is shown in Fig. 5. The potential gradient required to reach

* J. J. Thomson, *Nature*, April 23, 1896.

† von Schweidler, *Wien. Bericht*, cviii. p. 273, 1899.

‡ J. S. Townsend, *Phil. Mag.* vi. 1, p. 198, 1901.

this stage depends upon the pressure of the gas, it is directly proportional to the pressure; for air at atmospheric pressure it is

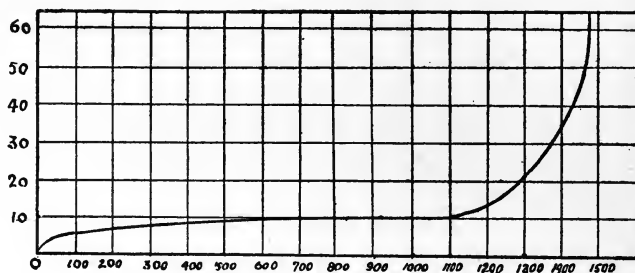

Fig. 5.

about 30,000 volts per centimetre, so that in air at a pressure of one millimetre a potential gradient of about 40 volts per centimetre would be sufficient to reach this stage.

12. The saturation current between two parallel plates of given area depends upon the amount of ionisation between the plates; if the ionisation takes place throughout the whole volume of gas between the plates, then the greater the distance between the plates the greater is the saturation current, so that if we use potential differences large enough to produce saturation, then with a constant difference of potential the greater the distance between the plates the larger is the current. Thus the behaviour of the conducting gas is very different from that of a metallic or liquid electrolytic conductor, for if such conductors were substituted for the gas the greater the distance between the plates the smaller would be the current. Under very small potential differences however the three classes of conductors would behave in the same way.

13. The peculiarities shown by the conduction through gases are very easily explained on the assumption that the conduction is due to ions mixed with the gas. Let us for example take the case of saturation. Suppose that in the gas between the plates the ionising agent produces in one second q positive and q negative ions and let e be the magnitude of the electric charge on an ion, then if an electric current i passes between the plates, i/e positive ions are driven against the negative electrode, and the same number of negative ions are driven against the positive electrode in one

second; thus in each second i/e positive and negative ions are taken out of the gas by the current. When the gas is in a steady state the number of ions taken out of it in a given time cannot be greater than the number of ions produced in it in the same time, hence i/e cannot be greater than q , and thus i cannot be greater than qe : qe is thus the value of the saturation current. If the ions are produced uniformly throughout the gas, and if q_0 is the number of ions produced in one second in unit volume, and V the volume of gas between the plates (Fig. 3), then the number of ions produced in the gas per second is q_0V and the saturation current q_0eV . Since V is equal to the area of one of the plates multiplied by the distance between the plates the saturation current is proportional to this distance. This relation between the saturation current and the distance between the plates has been verified by measurements of the saturation currents through gases exposed to Röntgen rays*.

14. Even when there is no current of electricity passing through the gas and removing some or all of the ions, the number of ions present in the gas does not increase indefinitely with the time which has elapsed since the gas was first exposed to the ionising agent; the number of ions in the gas and therefore its conductivity acquire after a time steady values beyond which they do not increase however long the ionising agent may act. This is due to the recombinations that take place between the positive and negative ions; these ions moving about in the gas sometimes come into collision with each other and in a certain fraction of such cases of collision the positive and negative ions will remain together after the collision, and form an electrically neutral system the constituents of which have ceased to be free ions. The collisions will thus cause the ions to disappear, and the steady state of a gas which is not carrying an electric current will be reached when the number of ions which disappear in one second as the result of the collisions is equal to the number produced in the same time by the ionising agent. Starting from this principle it is very easy to investigate the relation between the number of free ions when the gas is in a steady state, the strength of the ionising agent, the rate at which the ions increase on the first exposure to the ionising

*J. J. Thomson and E. Rutherford, *Phil. Mag.* v. 42, p. 392, 1896.

agent and the rate at which they die away when the ionising agent is cut off.

For let q be the number of ions (positive or negative) produced in one cubic centimetre of the gas per second by the ionising agent; n_1 , n_2 the number of free positive and negative ions respectively per cubic centimetre of the gas. The number of collisions per second between positive and negative ions is proportional to $n_1 n_2$. If a certain fraction of the collisions result in the formation of a neutral system the number of ions which disappear per second in a cubic centimetre will be equal to $\alpha n_1 n_2$, where α is a quantity which is independent of n_1 and n_2 ; hence if t is the time which has elapsed since the ionising agent was first applied to the gas we have

$$\left. \begin{aligned} \frac{dn_1}{dt} &= q - \alpha n_1 n_2 \\ \frac{dn_2}{dt} &= q - \alpha n_1 n_2 \end{aligned} \right\} \dots\dots\dots(1).$$

Thus $n_1 - n_2$ is constant, so that if the gas is uncharged to begin with n_1 is always equal to n_2 . Putting $n_1 = n_2 = n$ the preceding equation becomes

$$\frac{dn}{dt} = q - \alpha n^2 \dots\dots\dots(2),$$

the solution of which is, if $k^2 = q/\alpha$, and $n = 0$ when $t = 0$,

$$n = k \frac{(\epsilon^{2kat} - 1)}{\epsilon^{2kat} + 1} \dots\dots\dots(3);$$

n_0 the value of n when the gas is in a steady state is obtained by putting t equal to infinity in equation (3) and is given by the equation

$$n_0 = k = \sqrt{\frac{q}{\alpha}}.$$

We see from equation (3) that the gas will not approximate to a steady state until $2kat$ is large, *i.e.* until t is large compared with $1/2k\alpha$, that is with $1/2n_0\alpha$ or $1/2\sqrt{q\alpha}$. We may thus take $1/2\sqrt{q\alpha}$ as the measure of the time taken by the gas to reach the steady state under exposure to the ionising agent; as this time varies inversely as \sqrt{q} we see that when the ionisation is feeble it may take a very considerable time for the gas to reach the steady state.

Thus at some distance, say a metre, from an ordinary Röntgen bulb it may require an exposure of a minute or two to bring the gas into a steady state.

We may use equation (2) to determine the rate at which the number of ions diminishes when the ionising agent is removed; putting $q = 0$ in that equation we have

$$\frac{dn}{dt} = -\alpha n^2 \dots\dots\dots(4),$$

hence
$$n = \frac{n_0}{1 + n_0 \alpha t} \dots\dots\dots(5),$$

where n_0 is the value of n when $t = 0$. Thus the number of ions falls to one-half its initial value in the time $1/n_0\alpha$. We may regard equation (4) as expressing the fact that a free ion lasts for a time which on the average is equal to $1/\alpha n$.

15. Equation (4) has been verified by Rutherford for gases exposed to Röntgen rays* and to the radiation from uranium†, by McClung‡ for gases exposed to Röntgen rays, and by McClelland§ for the case of gases drawn from the neighbourhood of flames and arcs. Two methods have been employed for this purpose. In one method air exposed to rays at one end of a long tube is slowly sucked through the tube, and the saturation currents measured at different parts along the tube. These currents are proportional to the value of n at the place of observation, and knowing the velocity of the air and the distance of the place of observation from the end of the tube, we know the time which has elapsed since the gas was ionised; we can thus find the values of n corresponding to a series of values of t ; values determined in this way were found by Rutherford to agree well with those given by equation (5). This method can only be used when a large quantity of gas is available. Another method also used by Rutherford can be employed even for gases of which only small quantities can be procured. In this method gas confined in a vessel is exposed to the action of an ionising agent such as the Röntgen rays. Inside the vessel are two parallel metal plates

* Rutherford, *Phil. Mag.* v. 44, p. 422, 1897.

† Rutherford, *Phil. Mag.* v. 47, p. 109, 1899.

‡ McClung, *Phil. Mag.* vi. 3, p. 283, 1902.

§ McClelland, *Phil. Mag.* v. 46, p. 29, 1898.

A and *B*, between which the ionisation is to be measured (in some of Rutherford's experiments one of these plates was replaced by the case of the vessel, which was made a conductor by lining it with wire-gauze, the other plate was replaced by an insulated wire running down the middle of the vessel). One of these plates *A* can be connected with an electrometer, the other *B* with one terminal of a large storage battery, the other terminal of which is kept to earth. A pendulum interrupter is arranged so that as a heavy pendulum swings it strikes against levers, and by this means makes or breaks various connections. While the vessel is under the influence of the rays *A* and *B* are connected together and to earth, then *A* is disconnected from both earth and electrometer and left insulated, and *B* is disconnected from the earth; the pendulum is then let go: as it falls it first breaks the current going through the primary of the induction coil used to excite the rays, it thus stops the ionisation, then after an interval *t* (which can easily be varied) it strikes against another lever which has the effect of connecting *B* with the high potential pole of the battery, thus producing a strong electric field between the plates *A* and *B*: this field, if *B* is charged positively, drives in a very small fraction of a second all the positive ions which exist between *A* and *B* against *A*, so that *A* receives a positive charge proportional to *n*; the pendulum in its swing then goes on to disconnect *B* from the battery and connects it to earth. The plate *A* is now connected with the electrometer the needle of which is deflected by an amount proportional to the charge on the plate *A*, *i.e.* to *n*. By adjusting the apparatus so as to alter the time which elapses between cutting off the rays and connecting *B* with the battery we find a series of corresponding values of *n* and *t*; these were found by Rutherford to fit in well with the relation indicated by equation (5). The following table shows the rate at which the ionisation dies away in a special case, the rate of course

Time in seconds after stoppage of rays	Deflection of Electrometer
·004	184
·08	183
·45	106
2	37
4	19

depends upon the intensity of the ionisation, the figures may however serve to give an idea of the order of magnitude of the rate of decay in air under strong Röntgen radiation.

Thus after 4 seconds there was still a very appreciable amount of ionisation in the gas. The duration is still more marked in the following example when the radiation was much weaker. The electrometer was not equally sensitive in the two series of experiments.

Time	Deflection
·004	174
·45	139
2	107
4	54
8	30
16	16

Thus after 16 seconds in this case the gas retained more than 10 per cent. of its ionisation.

Rutherford measured the rate of decay in various gases exposed to Röntgen rays of as nearly as possible the same intensity. The results are shown in the following table; the first column contains the name of the gas, the second T the time taken for the ionisation to sink to one-half of its original value; we have seen that $T = 1/n_0\alpha = 1/\sqrt{q\alpha}$; the third column contains relative values of q , and the fourth column the relative values of α calculated from the values of T and q .

Gas	T	q	α
Hydrogen	·65	·5	4·8
Air.....	·3	1	11
Hydrochloric acid gas	·35	11	·75
Carbonic acid gas.....	·51	1·2	3·3
Sulphur dioxide	·45	4	1·25
Chlorine	·18	18	2

16. Rutherford showed that the value of T was very much diminished when any dust was present in the gas, the dust did not however affect the saturation current. Thus for example when chlorine was first admitted to the testing vessel the value of T was

·19 second, after standing for an hour T rose to about ·3 second although there was no change in the saturation current. Again for air which had been standing overnight T was about 1 second, when a little dusty air was blown into the vessel T fell to ·15 second, rising to about ·5 second in about 10 minutes; it took several hours for T to rise to its original value. Again, T was found to be increased by filtering the gas through cotton-wool. The effect produced by dust is easily explained, as the dust particles are in all probability very large compared with the ions; thus if a positive ion strikes against a dust particle and sticks to it, it forms a large system which is much more likely to be struck by a negative ion and neutralised than if the positive ion had remained free; in this way the presence of dust will facilitate the recombination of the ions. The presence of dust in Rutherford's experiments probably explains the discrepancy between his results and those of Townsend, who used dust-free gases and determined α by the first of the methods described, care being taken that the tubes through which the ionised gases were sucked were so large that the loss of ions from diffusion to the sides of the tube could be neglected in comparison with those lost by recombination. Townsend found that for air, oxygen, carbonic acid, and hydrogen α had the values, $3420e$, $3380e$, $3500e$, and $3020e$, where e is the charge on the ion in electrostatic units. We shall see that e is about $3\cdot5 \times 10^{-10}$, so that α for air, oxygen, and carbonic acid is about $1\cdot2 \times 10^{-6}$, while for hydrogen it is about 15 per cent. less. In Rutherford's experiments the value of α for air was about three times that for carbonic acid, but it is probable that the gases in this case were not really dust-free.

17. Variation of α with the pressure of the gas. Preliminary experiments made some time ago by Dr Nabl in the Cavendish Laboratory showed that down to pressures of about $\frac{1}{4}$ of an atmosphere the value of α in air was independent of the pressure. Careful determinations of the values of α over a large range of pressures have been made by M^cClung* and Langevin.

The method used by M^cClung was as follows: the ionised gas was contained in a cylinder divided up by diaphragms made of

* M^cClung, *Phil. Mag.* vi. 3, p. 283, 1902.

very thin aluminium foil, the alternate diaphragms were connected together by metallic connections; a large potential difference could be established between the two sets of diaphragms so that the electric field in the space between two adjacent diaphragms was large enough to saturate the current. The gas was ionised by Röntgen rays which passed along the axis of the cylinder and thus traversed the diaphragms. When the gas was exposed to the rays all the diaphragms were kept at one potential, the rays were then cut off and the strong electric field applied at various intervals after the stoppage. This field drove all the positive ions existing at the time of its application to one set of diaphragms, all the negative to the other; the charge communicated to these diaphragms was measured. In this way a series of values of n for different values of t , the interval after the stoppage of the rays, was determined; these values were found to lie on the curve indicated by the theory, *i.e.* the curve whose equation is

$$n = \frac{n_0}{1 + n_0 \alpha t}.$$

This equation was verified for pressures varying from .25 to 3 atmospheres. The absolute value of α was not however deduced from this equation, but was determined as follows. The saturation current was measured with the rays on; from this we can determine Q , the number of ions produced by the rays per second; in the next place N , the number of ions in the gas, was determined by allowing the gas to get in a steady state under the action of the rays when no electric field acted on the gas; the rays were then cut off and a strong electric field immediately applied; this drove all the free ions of one sign to one of the electrodes; by measuring the charge given to the electrodes n could be determined. Since $q = \alpha n^2$ where q is the number of ions produced by the rays per sec. per c.c. and n the number of free ions per c.c., we have, if l is the distance between the plates and A the area of a plate, $Q = lAq$, $N = lAn$, hence $\alpha = lA \frac{Q}{N^2}$. M^cClung by using this method found that α was independent of the pressure for pressures from .25 to 3 atmospheres. Langevin, who used a different method, which will be described later (see p. 64), found little change in α between 1 and 3 atmospheres, and his values agree very closely with M^cClung's; at pressures less than an

atmosphere he found considerably smaller values; the relative values of α are given in the following table:

Pressure in atmospheres	α
$\frac{1}{5}$	·05
$\frac{1}{2}$	·12
1	·27
2	·30
3	·26
5	·18

In M^cClung's experiments the rays passed through the aluminium; we shall see that when these rays pass through or strike against metals, secondary radiation starts from the metal, producing very intense radiation close to the surface. It is easy to see that the effect of this would be to make the method used by M^cClung give too large values for α . For suppose we have a thin layer in which the ionisation is very intense, let l_1 be the thickness of this layer, q_1 the rate of ionisation, and n_1 the number of free ions, l_2 the thickness of the remaining layer, q_2 the rate of ionisation, and n_2 the number of free ions in this layer, then

$$\begin{aligned} Q &= A (l_1 q_1 + l_2 q_2) & q_1 &= \alpha n_1^2 \\ N &= A (l_1 n_1 + l_2 n_2) & q_2 &= \alpha n_2^2, \end{aligned}$$

hence

$$\begin{aligned} (l_1 + l_2) \frac{AQ}{N^2} &= \alpha (l_1 + l_2) \frac{(l_1 n_1^2 + l_2 n_2^2)}{(l_1 n_1 + l_2 n_2)^2} \\ &= \alpha \left(1 + \frac{l_1 l_2 (n_1 - n_2)^2}{(l_1 n_1 + l_2 n_2)^2} \right). \end{aligned}$$

The right-hand side of this equation is always greater than α unless $n_1 = n_2$, hence if there is any inequality in the ionisation, the values of α got by using the formula $(l_1 + l_2) \frac{AQ}{N^2} = \alpha$ will be too large. The error will increase as the pressure diminishes, for the ionisation due to the primary rays will diminish with the pressure; the total ionisation due to the secondary rays need not however do so, as these are so easily absorbed that they may not be able to reach from one plate to another even at the lower pressure. Thus the secondary ionisation will be more important at low than at high pressures, and the error introduced by using the uncorrected formula correspondingly greater. Aluminium, the metal used by M^cClung, gives less secondary radiation than any metal hitherto tried, but it is possible that this radiation may have produced an

effect at low pressures. This effect might not be appreciable on the curves representing the connection between n and the time elapsed since the rays were stopped, for in the thin layer of intense ionisation close to the metal the rate of recombination is so rapid that the effect of it would die away almost as soon as the rays were stopped. Ions would also be lost by diffusion to the diaphragms and unless this was allowed for the values found for α would be too large. The correction for diffusion would be greater at low pressures than at high and would vary inversely as the square of the distance between the diaphragms.

18. Effect of temperature on the value of α . This has been investigated by M^cClung*, who used the method he had previously applied to determine the variation of α with the pressure. He verified the relation $n = \frac{n_0}{1 + n_0 \alpha t}$ for a number of temperatures ranging up to 270° C. He found a very considerable increase in α with the temperature, his results being shown in the following table :

Temperature	α
15° C.	35
90	45
135	65
180	100
270	280

These experiments make the value of α at 270° C. eight times the value at 15° C. At the highest temperature the density of the gas is only $\frac{1}{2}$ of its density at 15° C., and since at small densities there is as we have seen a discrepancy between M^cClung's and Langevin's results, the values obtained by the latter observer being considerably less than M^cClung's, it is desirable that further experiments by some different method should be made on the effect of temperature on α , especially as we shall see that it is very difficult to reconcile other properties of the ions with such a large temperature coefficient of α .

19. The values of α found by the preceding method afford a good deal of information as to the way in which the ions recombine. We have seen that the number of recombinations per sec. per cubic centimetre is in air at atmospheric temperature about $10^{-6} n^2$. The kinetic theory of gases shows however that at this temperature the total number of collisions between the molecules of a gas

* M^cClung, *Phil. Mag.* vi. 6, p. 655, 1903.

per sec. per c.c. is for air $1.2 \times 10^{-10} n^2$, for hydrogen $2.4 \times 10^{-10} n^2$, and for CO_2 $1.4 \times 10^{-10} n^2$. Thus the number of collisions resulting in recombination between ions is about 10,000 times the whole number of collisions between the same number of molecules of a gas in its normal state. We shall see that the difference between the size of a molecule and of an ion is not nearly large enough to account for the enormous difference in the number of collisions, the difference is due to the electrical charges on the ions; the attraction between oppositely charged ions drags these ions into collision when if it had not been for the charges they would never have come near each other, it is to this effect that the large number of collisions between ions is to be attributed.

20. Value of α given by the kinetic theory of gases. If we suppose that the charged ions possess the same average kinetic energy as is possessed by the molecules of all gases at the temperature of the ions, the ions will be moving with very considerable velocity. Consider now two ions, one positively, the other negatively electrified, they will attract each other with a force varying inversely as the square of the distance between them; we know from the theory of central forces that if when these bodies are at a distance r apart their kinetic energy is greater than e^2/r (where e is the charge on either particle), the particles will not describe closed orbits round each other but will separate until they get an infinite distance apart, they will therefore not recombine. If, however, the kinetic energy T is less than e^2/r the particles will revolve round each other and will recombine. Thus for recombination to take place the ions must approach to a distance r such that $T < \frac{e^2}{r}$ or $r < \frac{e^2}{T}$ and when the particles approach within this distance they will recombine. Since T , the kinetic energy, only depends upon the temperatures the limiting distance will be the same for all ions. As T is the kinetic energy of *two* ions, we have by the kinetic theory of gases if N is the number of molecules in a cubic centimetre of a gas at a pressure p ,

$$p = \frac{1}{3} NT; \text{ thus } T = 3p/N \text{ and } e^2/T = Ne^2/3p.$$

Now at atmospheric pressure and 0°C .

$$p = 10^6; \quad Ne = 1.22 \times 10^{10}; \quad e = 3.5 \times 10^{-10}.$$

Thus, $Ne^2/3p = r = 1.4 \times 10^{-6} \text{ cm}$.

Hence for recombination to take place between two ions they must approach to a distance of 1.4×10^{-6} cm. of each other. This distance is exceedingly small compared with the average distance between the ions in any known cases of ionisation. To find how long an ion will be before it comes within this distance of an oppositely charged ion let V be the average velocity of translation of the ion, relative to an oppositely charged ion; in the time t the ion will describe a path Vt , and for every point inside the cylinder whose volume is $\pi p^2 Vt$ the perpendicular from the point on the line of motion of the moving ion will be less than p . If all directions of relative motion are equally probable the mean value of this perpendicular is $\frac{\pi}{4} r$, where r is the distance of the moving ion from the point. Thus if $p = \frac{\pi}{4} \times 1.4 \times 10^{-6}$ and if there are n positive and n negative ions per unit volume the ion in the time t will come within combining distance of $n\pi p^2 Vt$ oppositely charged ions. Thus the average free life of an ion will be $1/n\pi p^2 V$, and the number of recombinations in unit volume per unit time will be $n/1/n\pi p^2 V$ or $\pi p^2 V n^2$. Thus $\alpha = \pi p^2 V$, or substituting the value of p , $3.9 \times 10^{-12} V$. If the ions in hydrogen had the same mass as a hydrogen molecule V at 0°C . would be $\sqrt{2} \times 1.8 \times 10^5$, and α therefore $.97 \times 10^{-6}$; this is the right order of magnitude for α , as we have seen that at atmospheric pressure α for hydrogen, air, and carbonic acid is about 10^{-6} . We should expect that the value of α given by the equation $\alpha = 3.9 \times 10^{-12} V$ would be too small, for in deducing that equation we have neglected the effect of the surrounding gas on the motion of the ions; this gas would act like a resisting medium and would cause some ions to fall together which would have escaped from each other's action if their motion had not been retarded by the gas through which they were moving. We should expect the effect of the gas would be greater at high pressures than at low ones, so that α would diminish with the pressure, a result shown very clearly in Langevin's experiments. Since the value of α got on the supposition that the mass of the ion is equal to that of the molecule is of the right order of magnitude, we infer that the mass of the ion is not a large multiple of the mass of the molecule.

Let us now find the rate at which a charged molecule would combine with an uncharged one to form a complex ion containing

two molecules. In order to get numerical results we shall assume that both the charged and uncharged molecules are conducting spheres of radius a . If c , the distance between the centres of the spheres, is a considerable multiple of a , then the work required to separate the charged and uncharged spheres to an infinite distance is approximately $\frac{1}{2} \frac{e^2 a^3}{c^4}$; and if the particles are to remain together this must be greater than the kinetic energy. We have seen, however, that the kinetic energy of the two molecules, mV^2 , at 0°C . is equal to $\frac{e^2}{r}$ where $r = 1.3 \times 10^{-6}$; hence for union to take place c must be less than $\{\frac{1}{2} a^3 r\}^{\frac{1}{4}}$. If p is the least distance between the particles if they were to move along straight lines undisturbed by their mutual attractions $p = c \sin \theta$, where θ is the angle between c and the direction of relative motion of the two particles. If all directions of relative motion are equally probable the mean value of $p = \frac{\pi}{4}$ (mean value of c). So that for combination to take place p must be $< \frac{\pi}{4} (\frac{1}{2} a^3 r)^{\frac{1}{4}}$. Let us denote $\frac{\pi}{4} (\frac{1}{2} a^3 r)^{\frac{1}{4}}$ by p_0 . Then if the charged and uncharged molecules pursued their undeflected paths, the number of pairs consisting of an uncharged and a charged particle for which p is less than p_0 occurring in time δt is $\pi p_0^2 V N \delta t$, where N is the number of uncharged molecules per unit volume and V the relative velocity of the charged and uncharged molecules. If we put $a = 10^{-8} \text{cm.}$, $p_0 = \frac{\pi}{4} \times 2.7 \times 10^{-8}$ approximately. The corresponding quantity for a pair of oppositely charged ions is $\frac{\pi}{4} \times 1.4 \times 10^{-6}$; thus the factor πp_0^2 in the number of combinations between the charged and uncharged ion is about $1/2.5 \times 10^3$ of its value in the case of two oppositely charged ions. The smallness of this factor when one particle is uncharged is however far more than compensated by the enormously greater number of molecules than of ions. Thus it would be exceedingly strong ionisation if the ions were $1/10^{12}$ of the molecules, hence the factor N for the case of the ion and the uncharged molecule will at least be 10^{12} times the factor for the oppositely charged ions, so that the number of combinations between a charged and uncharged molecule will in a given time

be at least 5×10^8 the number of combinations between oppositely charged ions; hence at the very beginning of its career the charged molecule will unite to form a more complex ion, so that a charge will be carried during practically the whole of its existence as a free charge by a complex ion.

21. Limit to the size of a gaseous ion. After the charged molecule has increased in size by attracting another molecule, the work required to drag an additional uncharged molecule away from it, starting from a given distance, will be less than the work required to drag an uncharged molecule away from a single molecule. The more complex the ion becomes, the less the work required to drag an uncharged molecule away from it, and at a certain stage of complexity the work required to drag an uncharged molecule from an ion with which it is in contact is less than the kinetic energy the system possesses in virtue of its temperature; when this stage is reached the ion will cease to attract fresh molecules.

The work required to separate an uncharged sphere of radius a from a charged sphere of radius b , the spheres being infinitely nearly in contact, is (see Maxwell's *Electricity and Magnetism*, vol. I. p. 275)

$$\frac{1}{2} \frac{e^2}{a+b - \left\{ 2\gamma + \psi\left(\frac{b}{a+b}\right) + \psi\left(\frac{a}{a+b}\right) \right\}} - \frac{1}{2} \frac{e^2}{b},$$

where

$$\gamma = .57712,$$

$$\psi(x) = \frac{d}{dx} \log \Gamma(1+x).$$

Tables by which we can calculate $\psi(x)$ are given in De Morgan's *Differential and Integral Calculus*, p. 587.

From these tables I find the following expressions for the work w :

$$a = b. \quad w = .14 \frac{e^2}{a}.$$

$$2a = b. \quad w = \frac{1}{40} \frac{e^2}{a}.$$

$$3a = b. \quad w = \frac{1}{156} \frac{e^2}{a}.$$

Now the process of aggregation will stop at the stage where w becomes less than the kinetic energy of the system which we have seen at $0^\circ \text{C.} = \frac{e^2}{r}$ where $r = 1.4 \times 10^{-6}$.

Thus if $a = 10^{-8}$, the work required to separate a molecule from an ion whose radius is $2a$ is greater than e^2/r , but the work required to separate a molecule from an ion whose radius is $3a$ is less than e^2/r , hence in this case the radius of the ion cannot exceed three times the radius of the molecule.

If $a = 10^{-7}$, the work required to separate a molecule from an ion of radius $2a$ will be less than e^2/r , hence in this case the radius of the ion cannot exceed twice the radius of the molecule, and we see that the larger the molecule the smaller will be the ratio of the size of the ion to the size of the molecule; with very large molecules it is probable that the ion and the molecule are identical. The ions in different gases will thus not differ so much in size as the molecules of the gases. Since the kinetic energy is greater at a high temperature than a low one the process of aggregation of molecules will stop at an earlier stage the higher the temperature, so that the ions will be simpler at high temperatures than at low ones.

22. The velocity of the negative ion in an electric field is greater than that of the positive; the investigation given above shows that even though the negative ion starts as a corpuscle and has in this stage of its existence a very high velocity, the duration of this stage is so short compared with the life of an ion that the high velocity of the corpuscle could hardly affect the average velocity of the ion. Again, if this were the cause of the high velocity of the negative ion as compared with that of the positive the ratio of the velocities ought to depend upon the intensity of the ionisation, for while the intensity of the ionisation does not affect the duration of the corpuscular stage, it has a great effect upon the life of an ion, the weaker the ionisation the longer the life of the ion; thus if the effect we are considering were the cause of the excess of the velocity of the negative ion, the ratio of the velocity of the negative ion to that of the positive ought to be smaller when the ionisation is weak than when it is strong. I am not aware that any such result has been observed. If however the negative ions behaved like metals exposed to ultra-violet light and rapidly lost their negative charge, which leaving the ion as a corpuscle soon finds another home on a fresh molecule, then the period during which the negative charge existed as a corpuscle would be much longer than if the corpuscle remained

permanently attached to the molecule with which it had first combined, and the period of its corpuscular existence would be proportional to the period during which it existed as an ion so that the ratio of the velocity of the negative ion to that of the positive would be independent of the intensity of the ionisation. The fact that at very high temperatures the ratio of the velocity of the negative ion to that of the positive is very much greater than at 0°C . is in favour of some such view, for we shall see that when the temperature is high, bodies, at any rate solid bodies, give out corpuscles with great facility; if this property is possessed by the molecules of a gas as well as of a solid then we can easily explain the great increase with temperature of the ratio of the velocity of the negative to that of the positive ion. This view would also explain the increase of this ratio when the pressure is diminished, for if we diminish the pressure we increase the time in the corpuscular state, since the number of molecules for the corpuscle to strike against is diminished; on the other hand there does not seem much ground for supposing that when once a corpuscle gets attached to a molecule, the period for which the combination lasts should depend much, if at all, on the pressure of the gas, it would do so if the corpuscle was detached from the ion by the bombardment with other molecules, but there does not appear to be any reason for supposing that this is the case, as the phenomena attending the omission of corpuscles from hot bodies seem to indicate that the rate of emission depends only upon the temperature. We could test the truth of this view by an experiment of the following kind: suppose we have a vessel containing at the bottom a little carbonic acid gas, while the upper part is filled with hydrogen, suppose now that we only ionise the lower layer and by means of an electric field drive the negative ion from the CO_2 into the hydrogen, if the corpuscle is continually changing its habitation, then in the hydrogen the negative ion will behave like a hydrogen ion, while if the corpuscle always remains attached to the same molecule the negative ion will behave like a carbonic acid ion. If we measured the velocity of the ion through the hydrogen we could decide which of these statements represented the facts.

Diffusion of Ions.

23. In addition to the loss of ions arising from the recombination of the positive and negative ions there will be a further loss due to the diffusion of ions to the sides of the vessel. Thus suppose the ionised gas is contained in a metal vessel, then when the ions come in contact with the sides of the vessel their charges are neutralised by the opposite charge induced on the metal and they thus cease to act like ions: the layer of gas next the sides of the vessel is thus denuded of ions, which exist in finite numbers in the gas in the interior; a gradient in the concentration is thus established and the ions diffuse from the interior to the boundary. The problem is closely analogous to that of the absorption of water vapour in a vessel whose sides are wet with sulphuric acid. We shall begin by considering the theory of a very simple case, that of ionised gas contained between two parallel metal plates at right angles to the axis of x . Let n be the number of positive ions per cubic centimetre, q the number of ions produced by the ionising agent per second in a cubic centimetre of the gas, D the coefficient of diffusion of the positive ions through the gas, m the number of negative ions per cubic centimetre, then we see that in consequence of diffusion the rate of increase in the number of positive ions per cubic centimetre is equal to $D \frac{d^2n}{dx^2}$: assuming that the surfaces of equal density of the ions are planes at right angles to the axis of x . Thus taking recombination and external ionisation into account as well as diffusion we have

$$\frac{dn}{dt} = q + D \frac{d^2n}{dx^2} - \alpha nm,$$

and when things are in a steady state,

$$q + D \frac{d^2n}{dx^2} - \alpha nm = 0.$$

Let us consider the special case when the plates are so near together that the loss of ions from diffusion far exceeds that from recombination, then we have

$$q + D \frac{d^2n}{dx^2} = 0 \dots\dots\dots(1).$$

If we take the plane midway between the metal plates as the plane $x=0$, and if l is the distance between the plates, then the conditions to be satisfied by n are $n=0$ when $x=\pm l$; the solution of equation (1) with these conditions is

$$n = \frac{1}{2} \frac{q}{D} (l^2 - x^2) \dots\dots\dots(2).$$

The total number of free positive ions between the plates is equal to

$$\int_{-l}^{+l} n \, dx,$$

and this by equation (2) is equal to

$$\frac{2}{3} \frac{q}{D} l^3.$$

We see from this result how we can measure D . For, if we cut off the rays and apply a strong electric field between the plates, we shall drive all the positive ions against the plate at the lower potential, so that this plate will receive a charge of electricity equal to $\frac{2}{3} \frac{q}{D} l^3 e$, where e is the charge on an ion: if this plate is connected with an electrometer we can measure its charge, which will be proportional to the deflection δ_1 of the electrometer. If the rays are kept on and the field is intense enough to produce the saturation current, the charge received by the plate in one second is equal to $2ql_e$, hence if δ_2 is the deflection of the electrometer in one second in this case, we see that

$$\delta_1 = \frac{1}{3} \frac{l^2}{D} \delta_2,$$

an equation which enables us to determine D .

We have in this investigation neglected the effect of recombination; it is necessary to find the condition that the plates should be sufficiently close together to make this justifiable. An easy way of doing this is as follows: the total number of ions on the hypothesis that the only source of loss of ions is recombination is equal to $2l \sqrt{q/\alpha}$ (see p. 16); the number on the assumption that the loss is entirely due to diffusion is as we have just seen $\frac{2}{3} \frac{q}{D} l^3$, hence if $\frac{2}{3} \frac{q}{D} l^3$ is small compared with $2l \sqrt{q/\alpha}$ the loss of ions from

diffusion will be large compared with the loss by recombination, and we shall be justified in neglecting the latter.

24. The coefficients of diffusion of the ions in air, oxygen, hydrogen, and carbonic acid gas have been determined by Townsend* by a different method; ionised air being sucked through very narrow tubes and the loss of ions suffered in passing through a known length of tubing determined. The theory of the method is as follows: ionised gas is sent through a metal tube the axis of which is taken as the axis of z , the gas moving parallel to z and being free from the action of any ionising agent in its course through the tube. Consider the state of things in a small volume $ABCDEFGH$: this volume loses ions by diffusion, and gains them by the gas entering the volume through the face $ABCD$

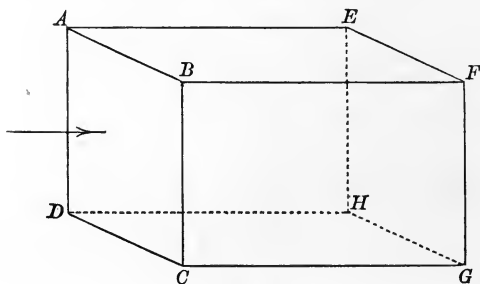

Fig. 6.

being richer in ions than that leaving it through the face $EFGH$, when the gas is in a steady state the rates of loss and gain of ions must be equal. If n is the number of ions per cubic centimetre, D the coefficient of diffusion of the ions through the gas, the rate of loss of ions from diffusion is equal to

$$-D \left(\frac{d^2n}{dx^2} + \frac{d^2n}{dy^2} + \frac{d^2n}{dz^2} \right).$$

If v is the velocity of the gas, the rate of gain of ions from the second cause is equal to

$$-v \frac{dn}{dz},$$

or, since v does not depend upon z , to

$$-v \frac{dn}{dz}.$$

* Townsend, *Phil. Trans. A*, 193, p, 129, 1900.

Hence equating the loss and the gain we get

$$D \left(\frac{d^2n}{dx^2} + \frac{d^2n}{dy^2} + \frac{d^2n}{dz^2} \right) = v \frac{dn}{dz} \dots\dots\dots(1).$$

In the experiments the term $D \frac{d^2n}{dz^2}$ was very small compared with $v \frac{dn}{dz}$; $\frac{1}{n} \frac{dn}{dz}$ being of the order 1/20, v of the order 100 and D about .03 so that vn was about 70,000 times $D \frac{dn}{dz}$. Neglecting $D \frac{d^2n}{dz^2}$ and taking the case of a cylindrical tube of radius a symmetrical about the axis

$$\frac{d^2n}{dx^2} + \frac{d^2n}{dy^2} = \frac{d^2n}{dr^2} + \frac{1}{r} \frac{dn}{dr},$$

where r is the distance of a point from the axis of the tube. Now $v = \frac{2V}{a^2}(a^2 - r^2)$, where $V\pi a^2$ is the volume of gas passing per second through each cross-section of the tube; substituting these values in equation (1) and neglecting d^2n/dz^2 we get

$$\frac{d^2n}{dr^2} + \frac{1}{r} \frac{dn}{dr} - \frac{2V}{Da^2}(a^2 - r^2) \frac{dn}{dz} = 0 \dots\dots\dots(2).$$

The conditions to be satisfied by n are that $n = 0$ when $r = a$ for all values of z , and that if the ionised gas enters the tube at $z = 0$, $n = n_0$ a constant, when $z = 0$, for all values of r .

To solve this equation put $n = \phi \epsilon^{-\frac{\theta Da^2 z}{2V}}$ where ϕ depends only upon r and θ is a constant to be subsequently determined; substituting this value of n in equation (2) we get

$$\frac{d^2\phi}{dr^2} + \frac{1}{r} \frac{d\phi}{dr} + \theta (a^2 - r^2) \phi = 0 \dots\dots\dots(3).$$

Put $\phi = 1 + B_1 r^2 + B_2 r^4 + B_3 r^6 + \dots$, and we get from (3)

$$\begin{aligned} 4B_1 + \theta a^2 &= 0, \\ 16B_2 + \theta a^2 B_1 - \theta &= 0, \\ 36B_3 + \theta a^2 B_2 - \theta B_1 &= 0, \\ \dots\dots\dots \end{aligned}$$

thus the first three terms in ϕ are

$$1 - \frac{\theta a^2}{4} r^2 + \frac{1}{16} \left(\theta + \frac{\theta^2 a^4}{4} \right) r^4 \dots\dots\dots(4).$$

We have to choose such values of θ that $\phi = 0$ when $r = a$; let these values be $\theta_1, \theta_2 \dots$ and let ϕ_1, ϕ_2 be the values of ϕ when these values of θ are substituted in equation (4); then we may write

$$n = c_1 \phi_1 \epsilon^{-\frac{\theta_1 D a^2 z}{2V}} + c_2 \phi_2 \epsilon^{-\frac{\theta_2 D a^2 z}{2V}} + c_3 \phi_3 \epsilon^{-\frac{\theta_3 D a^2 z}{2V}} + \dots \dots (5).$$

To find the values of $c_1, c_2, c_3 \dots$ we have the condition $n = n_0$ a constant when $z = 0$. Hence

$$n_0 = c_1 \phi_1 + c_2 \phi_2 + c_3 \phi_3 + \dots \dots \dots (6).$$

Now from the differential equation (3) we can easily prove the following relations:

$$\int_0^a \phi_n \phi_m (a^2 - r^2) r dr = 0 \text{ when } n \text{ and } m \text{ are different } \dots (7),$$

$$\int_0^a \phi_n^2 (a^2 - r^2) r dr = a \left[\frac{d\phi_n}{d\theta_n} \frac{d\phi_n}{dr} \right]^{r=a} \dots \dots \dots (8),$$

$$\int_0^a \phi_n (a^2 - r^2) r dr = -\frac{a}{\theta_n} \left[\frac{d\phi_n}{dr} \right]^{r=a} \dots \dots \dots (9).$$

Multiplying both sides of equation (6) by $\phi_n (a^2 - r^2) r$ and integrating from $r = 0$ to $r = a$ we obtain by the aid of equations (7), (8) and (9)

$$c_n = -\frac{n_0}{\theta_n \left[\frac{d\phi_n}{d\theta_n} \right]^{r=a}},$$

hence

$$n = -n_0 \left\{ \frac{\phi_1}{\theta_1 \left[\frac{d\phi_1}{d\theta_1} \right]^{r=a}} \epsilon^{-\frac{\theta_1 D a^2 z}{2V}} + \frac{\phi_2}{\theta_2 \left[\frac{d\phi_2}{d\theta_2} \right]^{r=a}} \epsilon^{-\frac{\theta_2 D a^2 z}{2V}} + \dots \right\} \dots \dots (10).$$

The number of ions which pass across the section of the tube when $z = 0$ is $n_0 \pi a^2 V$, the quantity which pass across a section of the tube at a distance z from the origin is equal to

$$\int_0^a n \frac{2V}{a^2} (a^2 - r^2) r dr,$$

this by equations (7), (9) and (10) is equal to

$$\frac{4\pi V n_0}{a} \left\{ \frac{1}{\theta_1^2} \left[\frac{d\phi_1}{dr} \right]^{r=a} \frac{d\phi_1}{d\theta_1} \epsilon^{-\frac{\theta_1 D a^2 z}{2V}} + \frac{1}{\theta_2^2} \left[\frac{d\phi_2}{dr} \right]^{r=a} \frac{d\phi_2}{d\theta_2} \epsilon^{-\frac{\theta_2 D a^2 z}{2V}} + \dots \right\}.$$

The two smallest roots of the equation $\phi = 0$ were found by Townsend to be $\theta_1 a^4 = 7.313$ and $\theta_2 a^4 = 44.56$, corresponding to these roots we have

$$\frac{1}{\theta_1 a^3} \left[\frac{d\phi_1}{dr} \right]^{r=a} = .1321; \quad \frac{1}{\theta_2 a^3} \left[\frac{d\phi_2}{dr} \right]^{r=a} = .0302;$$

$$\frac{1}{a^4} \left[\frac{d\phi_1}{d\theta_1} \right]^{r=a} = .0926; \quad \frac{1}{a^4} \left[\frac{d\phi_2}{d\theta_2} \right]^{r=a} = .0279.$$

Hence substituting these values we find that the ratio of the number of ions which pass a cross-section of the tube at a distance z from the origin to the number which pass through the tube at the origin is equal to

$$4 \left\{ .1952\epsilon^{-\frac{7.313Dz}{2a^2V}} + .0243\epsilon^{-\frac{44.56Dz}{2a^2V}} + \dots \right\}.$$

If c_1 is the saturation current through the gas after leaving a tube of length l_1 , c_2 that after leaving a tube of length l_2 , then since the saturation currents are proportional to the numbers of ions given to the gas per second, we have

$$\frac{c_1}{c_2} = \frac{.1952\epsilon^{-\frac{7.313Dl_1}{2a^2V}} + .0243\epsilon^{-\frac{44.56Dl_1}{2a^2V}}}{.1952\epsilon^{-\frac{7.313Dl_2}{2a^2V}} + .0243\epsilon^{-\frac{44.56Dl_2}{2a^2V}}} \dots \dots \dots (11).$$

Now c_1/c_2 can be determined by experiment, and hence from equation (11) the value of D can be determined. The method used by Townsend to solve this equation was a graphical one; putting $y = c_1/c_2$, $x = \frac{7.313Dl_1}{2a^2V}$, the curve representing the relation (11) between y and x was drawn by calculating a number of corresponding values: when this curve had been obtained the value of $7.313Dl_1/2a^2V$ corresponding to any value of c_1/c_2 obtained by experiment could be found, and hence D determined as l , a and V are known.

The apparatus used to measure the value of c_1/c_2 is represented in Fig. 7. A is a brass tube 50 cm. long, 3.2 cm. in diameter, provided with an aluminium window W through which the Röntgen rays which ionise the gas pass. C is another brass tube 17 cm. long fitting accurately into A and able to slide along it. E is an electrode which is connected to a metal rod F passing through an ebonite plug. A series of fine wires were soldered parallel to one another and 2 mm. apart across the end of the

tube *C*. The gas entered the apparatus through the glass tube *G* and then before reaching the electrode passed through the tubes *T*.

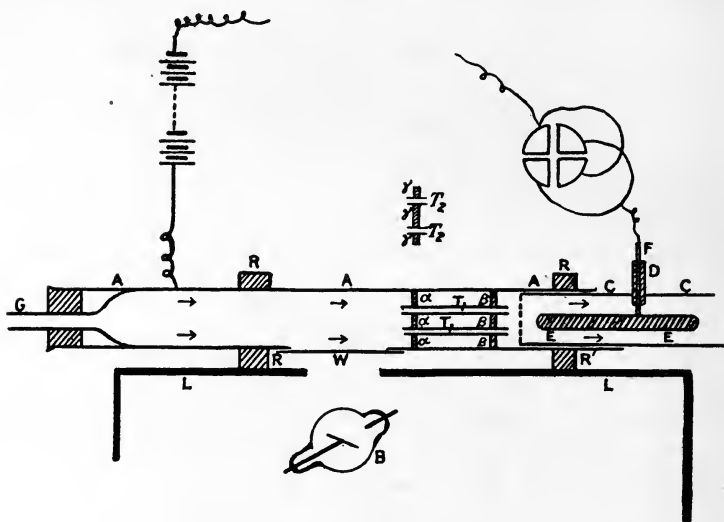

Fig. 7.

These were twelve tubes 10 cm. long and .3 cm. in diameter, arranged at equal intervals and all at the same distance from the axis of the tube *A*; they were soldered into holes bored into two brass discs α and β which fitted so closely into *A* that gas could not pass between the disc and the tube. Another set of twelve tubes only 1 cm. long and .3 cm. in diameter were fused into another disc γ . The tube *A* was insulated by the two ebonite rings *R*, *R'*. The potential of the tube was raised to 80 volts by connecting it with one of the terminals of a battery of small storage cells, the other terminal of which was connected with the earth. The electrode *E* was connected with one pair of quadrants of an electrometer, the other pair of quadrants being kept to earth. A uniform and measurable stream of gas was supplied by a gasometer, this gas was ionised by the Röntgen rays as it passed through the tube; some of the ions were lost by diffusion to the sides, all the positive ones which escaped were driven against the electrode *E*; thus the charge on the electrometer measured the number of positive ions which got through the tubes. By charging the tube *A* up negatively, the negative ions could be driven against the electrode, and the number of those which get

through the tubes determined. After a series of measurements had been made with the long tubes, these were replaced by the short ones, and a similar series of measurements gone through. These measurements, as was explained in the preceding theory, give us the data for calculating the coefficient of diffusion of the ions. For gases other than air, a somewhat different form of apparatus was used, for a description of which we must refer to the original paper.

The loss of ions even in the narrow tubes is not entirely due to diffusion to the sides of the tube, a part, though only a small part, of the loss will be due to the recombination of the ions. To estimate how much was due to this effect, the small tubes *T* were removed and the deflection of the electrometer observed when the tube *C* was placed at different distances from the place where the gas is ionised; in a wide tube such as *A* the loss from diffusion to the sides is negligible, and the smaller deflection of the electrometer when the electrode *E* is moved away from the place of ionisation is due to the loss of ions by recombination. By making measurements at different distances and knowing the velocity of the gas we can measure in this way the amount of recombination taking place in a given time and hence determine the value of α , the constant of recombination. It was in this way that the values of α given on page 20 were determined. Knowing α it is easy to calculate the loss of ions from recombination in their passage through the narrow tubes, and then to apply a correction to the observations so as to get the loss due to diffusion alone.

The following tables give the velocities of the coefficients of diffusion on the c.g.s. system of units as deduced by Townsend from his observations.

TABLE I. COEFFICIENTS OF DIFFUSION IN DRY GASES.

Gas	<i>D</i> for + ions	<i>D</i> for - ions	Mean value of <i>D</i>	Ratio of <i>D</i> for - to <i>D</i> for + ions
Air.....	·028	·043	·0347	1·54
Oxygen.....	·025	·0396	·0323	1·58
Carbonic acid ...	·023	·026	·0245	1·13
Hydrogen.....	·123	·190	·156	1·54

TABLE II. COEFFICIENTS OF DIFFUSION IN MOIST GASES.

Gas	D for + ions	D for - ions	Mean value of D	Ratio of D for - to + ions
Air	·032	·035	·0335	1·09
Oxygen	·0288	·0358	·0323	1·24
Carbonic acid ...	·0245	·0255	·025	1·04
Hydrogen	·128	·142	·135	1·11

We see from these tables that the coefficient of diffusion for the negative ions is greater than that for the positive, the difference being much more marked in dry than in damp gases. The superior mobility of the negative ions was first observed by Zeleny*, who measured by a method which we shall shortly describe the velocity of the ions when placed in an electric field, and found that the negative ions moved faster than the positive ones. The more rapid diffusion of the negative ions explains why in certain cases ionised gas, originally electrically neutral, acquires a charge of positive electricity. Thus, for example, if such a gas is blown through metal tubes, the gas emerging from the tubes will be positively electrified, as in the passage through the tubes it has lost more negative than positive ions. Zeleny (*loc. cit.*) has shown that this effect does not occur with carbonic acid gas in which the velocities of the two ions are very nearly equal. Some experiments made by Rutherford† seem to show that in addition to the effect produced by diffusion, there is a specific effect due to the metal, as he found that the excess of positive over negative ions was greater when the ionised gas passed through zinc tubes than when it passed through copper. The difference in the rate of diffusion of the positive and negative ions causes a certain amount of electrical separation to take place when a gas is ionised; as the negative ions diffuse more rapidly than the positive ones, the region where ionisation takes place will have an excess of positive ions and be positively electrified, while in consequence of the diffusion of the negative ions the surrounding regions will have an excess of these ions and will therefore be negatively electrified.

* Zeleny, *Phil. Mag.* v. 46, p. 120, 1898.

† Rutherford, *Phil. Mag.* v. 43, p. 241, 1897.

The results given in Tables I. and II. show that the excess of the velocity of diffusion of the negative ions over that of the positive is much greater when the gas is dry than when it is moist; the effect of moisture on the velocity of diffusion is very remarkable, the results quoted in the table show that with the exception of ions in carbonic acid (where there is but little difference between the velocities of diffusion of positive or negative ions in either wet or dry gas) the effect of moisture is to produce a very considerable diminution in the rate of diffusion of the negative ions, while on the other hand it tends to increase the rate of diffusion of the positive ions, though the change produced in the positive ions is not in general as great as that produced in the negative. We shall see later on that water vapour condenses more readily on negative ions than on positive ones, so that it is probable that the negative ions in a damp atmosphere get loaded with moisture and so are retarded in their movements through the surrounding gas.

The preceding experiments relate to ions produced by the Röntgen rays. Townsend* subsequently applied the same method to the determination of the coefficients of diffusion of ions produced by radio-active substances, by ultra-violet light and by discharges from electrified needle points; the results of these experiments are shown in the following table.

COEFFICIENTS OF DIFFUSION OF IONS PRODUCED IN AIR BY
DIFFERENT METHODS.

Method	Dry Air		Moist Air	
	+ ions	- ions	+ ions	- ions
Röntgen rays	·028	·043	·032	·035
Radio-active substances ...	·032	·043	·036	·041
Ultra-violet light.....		·043		·037
Point Discharge	·0247	·037	·028	·039
	·0216	·032	·027	·037

From these numbers we conclude that the ions produced by Röntgen rays, by radio-active substances and by ultra-violet light

* Townsend, *Phil. Trans. A*, 195, p. 259, 1900.

are identical, a conclusion which we shall find confirmed by several other courses of reasoning.

Townsend* also investigated the coefficients of diffusion of ions produced by radio-active substances at a series of pressures ranging from 772 millimetres of mercury to 200 mm. and found that within this range the coefficient of diffusion was inversely proportional to the pressure; the Kinetic Theory of Gases shows that this would be true in a system where the diffusing systems do not change character with the pressure; as this result holds for ions we conclude that down to a pressure of at least 200 mm. the ions do not change. We shall see that at very low pressures the negative ions are very much smaller than at these high pressures.

25. It is of interest to compare the rates of diffusion of ions through a gas with those of the molecules of one gas through another. In the following table, taken from Winkelmann's *Handbuch der Physik*, vol. I. pp. 645, 647, the coefficients of diffusion into each other for hydrogen, air, carbonic acid, and carbonic oxide, and for some vapours are given; it appears from the table that the gases diffuse very much more quickly than the ions, but that there are vapours whose coefficients of diffusion are of the same order as those of the ions.

Gas	D cm. ² /sec.	Gas	D cm. ² /sec.	Gas	D cm. ² /sec.
CO—CO ₂	·13142	CO—O ₂	·18717	ether—CO ₂	·0552
air—CO ₂	·13433	H ₂ —O ₂	·66550	isobutylic } —H ₂	·1724
O ₂ —CO ₂	·13569	H ₂ —air	·63405	amide }	
H ₂ —CO ₂	·53409	ether—H ₂	·296	„ —air	·0426
air—O ₂	·17778	ether—air	·0775	„ —CO ₂	·0305

If the ion consisted of a single molecule carrying a charge of electricity we could find by the principles of the Kinetic Theory of Gases the rate at which the ions would diffuse through a gas. The coefficient of diffusion of D_{12} of a gas A through another gas B is given by the equation

$$D_{12} = \frac{\pi}{8N} (N_1 L_2 \Omega_2 + N_2 L_1 \Omega_1) \dagger,$$

* Townsend, *Phil. Trans. A*, 195, p. 259, 1900.

† See O. E. Meyer, *Kinetische Theorie der Gase*, 2nd Edition, p. 261.

where N_1, N_2 are the number of molecules per unit volume of A and B , $N = N_1 + N_2$; Ω_1, Ω_2 the average velocities of the molecules of A and B respectively, L_1, L_2 the mean free paths of these molecules through the mixed gases. In the case when one of the gases, say A , consists of ions, N_1 will be infinitesimal compared with N_2 ; putting $N_1 = 0$ we have

$$D_{12} = \frac{\pi}{8N} (L_1 \Omega_1);$$

now if the ion is a single molecule, Ω_1 will be equal to the mean velocity of the molecule of a gas, and if the charge does not affect the length of the mean free path L_1 will be the mean free path of the molecules.

For hydrogen at atmospheric pressure and 0°C . $L = 1.8 \times 10^{-5}$, $\Omega = 1.7 \times 10^5$, hence D_{12} would be 1.2: the actual value for the positive ion is as we have seen .123.

For oxygen $L = 1.02 \times 10^{-5}$, $\Omega = .425 \times 10^5$, hence $D_{12} = .17$: the value for the positive ion is .025.

For CO_2 $L = .65 \times 10^{-5}$, $\Omega = .361 \times 10^5$, hence $D_{12} = .092$: the value for the positive ion is .023.

Thus in all these cases the value of D_{12} is considerably greater than the velocity of diffusion of the ions, hence we conclude that one or both of the assumptions that the mass of the ion is the same as the mass of a molecule, and that the charge does not affect the free path must be erroneous. We shall return to this point when we consider the velocity with which an ion moves in an electric field.

The most probable explanation of the slow diffusion of the ions seems to be that the charged ion forms a nucleus round which the molecules of the gas condense, just as dust collects round a charged body, thus producing a complex system which diffuses slowly: this explanation is supported by the fact discovered by McClelland* that the coefficients of diffusion of the ions in the flame gases depend very much on the temperature of the flame and the distance of the ions from it; a comparatively small lowering of temperature producing a great diminution in the rate

* McClelland, *Camb. Phil. Soc. Proc.* x. p. 241, 1899.

of diffusion of the ions, as if precipitation had occurred upon them. The view is also supported by the ability of the ions to act as nuclei for the precipitation of water vapour. It must be remembered also that an ion differs from an ordinary molecule in being charged with electricity and thus being surrounded by a strong electric field.

Rutherford* has recently shown that the vapour of alcohol or ether, like that of water, produces a great diminution in the mobility of the negative ion.

Velocity of the Ions in an Electric Field.

26. The coefficient of diffusion of the ions through a gas is directly proportional to the speed with which the ions travel through the gas under the action of an electric field of given strength. The connection between this speed and the coefficient of diffusion can be established as follows. From the definition of the coefficient of diffusion D it follows that if n is the number of ions per cubic centimetre, the number of ions which in unit time cross unit area of a plane at right angles to x is equal to $D \frac{dn}{dx}$. We may thus regard the ions as moving parallel to the axis of x with the average velocity $\frac{1}{n} D \frac{dn}{dx}$. The ions being in the gaseous state will produce a partial pressure p which when the temperature is constant is proportional to the number of ions, we see therefore that the average velocity of the ions parallel to x is equal to $\frac{1}{p} D \frac{dp}{dx}$. Now dp/dx is the force acting parallel to the axis of x on unit volume of the gas, we may thus interpret the preceding expression as meaning that when the force acting parallel to the axis of x on the ions in unit volume is unity, the ions move parallel to the axis of x with a mean velocity of translation equal to D/p . Suppose now that the ions are placed in an electric field when the electric intensity parallel to the axis of x is equal to X , then the force on the ions in unit volume is equal

* Rutherford, *Phil. Mag.* vi. 2, p. 210, 1901.

to Xen , hence if u is the average velocity of translation of the ions parallel to the axis of x

$$u = Xen \frac{D}{p}.$$

Now n/p is the same for all gases at the same temperature, hence if N is the number of molecules of air in a c.c. at this temperature and at the atmospheric pressure Π , since $n/p = N/\Pi$, we have

$$u = XeD \frac{N}{\Pi},$$

or u_0 the velocity of the ions in a field of unit intensity is given by the equation

$$u_0 = D \frac{Ne}{\Pi}.$$

Thus u_0 is directly proportional to D , so that a knowledge of one of these quantities enables us at once to calculate the other.

27. Measurements of the velocity of the ions under an electric field were made some time before those of the coefficients of diffusion. The earliest systematic measurements of the velocity of the ions in an electric field were made in the Cavendish Laboratory in 1897 by Rutherford*. Two different methods were used in these experiments. The first method is as follows: suppose that the current is passing through ionised gas between two parallel plates A and B ; then if there are n positive ions and n negative ions in each cubic centimetre of the gas and u_1, u_2 are respectively the velocities of the positive and negative ions, the current i passing through each unit area of cross-section between the plates is given by the equation

$$i = n(u_1 + u_2)e,$$

where e is the charge on an ion. Now i can easily be measured if one of the plates A is connected to one pair of quadrants of an electrometer, the other pair of which is connected to earth, and if the other plate B is connected to one terminal of a battery of known electromotive force, the other terminal of which is to earth. For if the quadrants are at first connected together and then disconnected, i will be the charge communicated in one second to the plate connected with the electrometer.

* Rutherford, *Phil. Mag.* v. 44, p. 422, 1897.

The value of ne can be determined in the following way: after the gas has been exposed to the ionising agent, say Röntgen rays, sufficiently long for it to get into a steady state, the rays are suddenly cut off, and simultaneously with the extinction of the rays a large electromotive force is suddenly switched on between the plates; then if B is the positive plate all the positive ions between the plates are driven against the plate A before they have time to recombine with the negative ions, and thus A receives a positive charge equal to that on the whole of the positive ions between the plates, *i.e.* each unit area of A receives a charge of positive electricity equal to nle , where l is the distance between the plates. This charge can be measured by the electrometer; let it equal q ; then since $i = n(u_1 + u_2)e$, we have

$$\frac{i}{q} = \frac{u_1 + u_2}{l} \dots\dots\dots(1),$$

a relation which enables us to determine $u_1 + u_2$. Now let E be the potential difference between the plates when the current is i . Then $u_1 + u_2$ is the sum of the velocities of the ions when the electric intensity is E/l ; hence, since as we shall see the velocity of an ion is proportional to the electric intensity, the sum of the velocities of the positive and negative ions when the electric intensity is unity is $(u_1 + u_2) l/E$, or $l^2 i/Eq$. For this method to give accurate results, the ionisation and the electric field must be uniform between the plates; this condition requires, as the investigation in Chapter III. shows, that the current should be so small that the conduction is in the stage represented by the first part of the curve, Fig. 4, when the curve is straight and the current is proportional to the electric intensity. Again, when the ionisation is produced by Röntgen rays or the rays from a radioactive substance, the rays should be arranged so that they pass tangentially between the plates and do not strike against them; the reason for this precaution is that when the rays strike against a metallic surface, there is an abnormally great ionisation of the gas close to the surface of the plates and the ionisation between the plates is not uniform.

The values for the sum of the velocities of the positive and negative ions under a potential gradient of one volt per centimetre obtained by Rutherford by this method are given in the following table.

Gas	Sum of velocities of + and - ions	Gas	Sum of velocities of + and - ions
Hydrogen	10 cm./sec.	Carbonic acid.....	2.15 cm./sec.
Oxygen	2.8 cm./sec.	Sulphur dioxide...	.99 cm./sec.
Nitrogen	3.2 cm./sec.	Chlorine	2 cm./sec.
Air	3.2 cm./sec.	Hydrochloric acid	2.55 cm./sec.

In these experiments the gases were not specially dried.

28. The method in this form can only be used when there is a considerable volume of gas between the plates and when the ionisation is large, in other cases the deflection of the electrometer obtained when the large electromotive force is applied between the plates is so small that accurate determinations of q are not possible; thus if the distance between the plates is 3.2 cm. we see from equation (1) that the deflection of the electrometer, when the large electromotive force is applied, is only that produced in one second by the steady leak caused by a potential difference of 3.2 volts between the plates; this with a fairly sensitive electrometer and not very weak ionisation, would often not exceed 2 or 3 scale divisions, while the percentage error with such small deflections would be very large. I have used a modification of this method

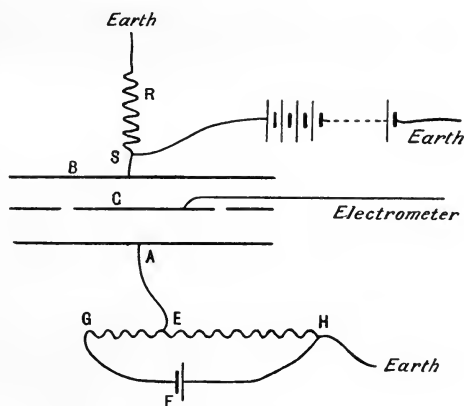

Fig. 8.

which is not subject to these disadvantages. The arrangement is represented diagrammatically in Fig. 8. C is the plate con-

nected with the electrometer; it is provided with a guard ring so as to avoid difficulties connected with irregularities in the electric field: this plate is placed between two parallel plates *A* and *B* and the whole region between *A* and *B* is exposed to the ionising agent. The plates are adjusted so that the rate of leak to the plate *C*, when *A* is charged to a potential *V* and *B* connected with earth, is the same as that to *C*, when *B* is charged to the potential *V* and *A* is connected with earth.

A is connected to a point *E* in a high resistance *GH* which is traversed by the current from the voltaic cell *F*, *H* is connected with earth, and by moving the point of attachment *E* the plate *A* can be raised to any potential from zero up to the electromotive force of the battery; if *G* is the positive pole of the battery positive electricity will flow into the plate *C* (this plate is initially connected with earth). *B* is connected with the earth through a large resistance *R*, the point *S* is touched at regular intervals by a rotating brush which connects it for a very short time with the negative terminal of a large battery of small storage cells the other terminal of which is to earth. The contact lasts long enough for the electric field to drive all the negative ions between *B* and *C* on to the plate *C*, but not long enough for any appreciable quantity of fresh ions to be produced while the field is on. The plate *C* is thus receiving positive ions from one side and negative from the other, and by moving the point *E* about we can make the positive charge balance the negative so that there is no deflection of the electrometer. When this is the case we can easily prove by the same reasoning as before that $u_1 + v_1$, the sum of the velocities of the positive and negative ions when the potential difference between the plates *A* and *C* is equal to that between *E* and *H*, is equal to ml , where l is the distance between the plates *B* and *C*, and m is the number of contacts per second made by the rotating brush with *S*. As in this case the experiment may be made to last while a large number of contacts occur, the method is much more sensitive than when only one contact is made.

To prevent the potential of *C* changing appreciably in the interval between the contacts, *C* is connected with one of the plates of a parallel plate condenser of large capacity. When the final test is made as to whether *C* has or has not received a charge

the plates of the condenser are pulled apart so as to diminish its capacity and thus increase the deflection of the electrometer due to any charge that might be on the plate *C*. Care must be taken to allow sufficient time to elapse between successive contacts at *S* to permit of the gas getting into a steady state before the next contact is made. When the ionisation is very weak it may require an interval of several seconds for this condition to be fulfilled.

29. Another method used by Rutherford* is represented in Fig. 9. Two large metal plates *A* and *B* were placed parallel to

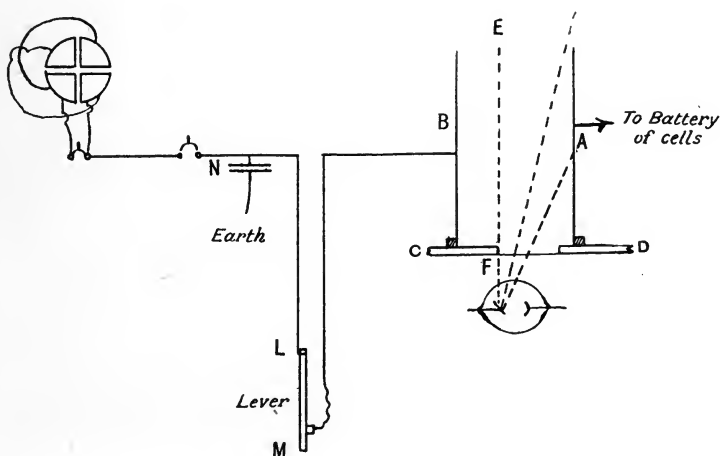

Fig. 9.

one another and 16 cm. apart on the insulating blocks *C* and *D*. The Röntgen rays were arranged so as to pass through only one half of the gas included between the plates, thus no direct radiation reached the air to the left of the line *EF* which is half-way between the plates. The plate *A* was connected with one terminal of a battery of a large number of small storage cells giving a potential difference of 220 volts, the other terminal of the battery being connected with the earth. The plate *B* was connected through a contact lever *LM*, mounted on an insulating block, to one pair of quadrants of an electrometer, the other pair being connected with the earth.

* Rutherford, *Phil. Mag.* v. 44, p. 422, 1897.

A pendulum interrupter was arranged so as first to make the current in the primary of the induction coil used to produce the rays, then after a known interval to break the electrometer circuit by knocking away the lever LM , and then to break the battery circuit shortly afterwards. N is a condenser connected to the electrometer to increase its capacity. With this arrangement the ions have to travel over a distance of 8 cm. before they reach the plate B , and the object of the experiment was to find the time occupied by the rays in passing over this distance. It was found that there was only a very small deflection of the electrometer when the interval between putting on the rays and breaking the electrometer circuit was less than $\cdot 36$ sec., but when the interval exceeded this value the deflection of the electrometer increased rapidly. Thus $\cdot 36$ sec. was taken as the time required for the ions to pass over a distance of 8 cm. under a potential gradient of $220/16$ volts per centimetre. This corresponds to a velocity $1\cdot 6$ cm./sec. for the gradient of a volt per centimetre, and no difference was detected between the velocities of the positive and negative ions. This makes the sum of the velocities of the positive and negative ions in air under a potential gradient of a volt a centimetre equal to $3\cdot 9$ cm./sec., which is exactly the velocity found by Rutherford using the first method.

30. The difference between the velocities of the positive and negative ions was discovered by Zeleny*, who has made very valuable determinations of the velocities of the ions in an electric field. The method by which he discovered the difference of the velocities was by finding the electric force required to force an ion against a stream of gas moving with a known velocity parallel to the lines of electric force. Thus suppose A and B , Fig. 10, represent two parallel plates made of wire gauze and that between these plates we have a stratum of ionised gas, let the gas be moving through the plates from A to B with the velocity V , and let the potential gradient between the plates be n volts per centimetre, B being the positive plate. Then if the velocity of the positive ion under a potential gradient of 1 volt per centimetre be u , the velocity of the positive ion in the direction from B to A is $nu - V$ and this is proportional to the number of ions giving up their charges

* Zeleny, *Phil. Mag.* v. 46, p. 120, 1898.

to A in unit time. Suppose now that we make B the negative plate, then if the potential gradient between the plates is n' volts

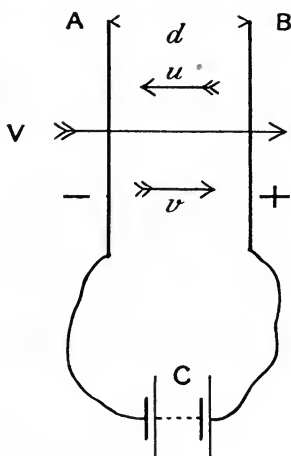

Fig. 10.

per centimetre and the velocity of the negative ion under a potential gradient of 1 volt per centimetre is v , the velocity of the negative ion from B to A is $n'v - V$, and this is proportional to the number of negative ions giving up their charges to A in unit time. If we adjust the potential gradients so that the rate at which A receives a positive charge when B is positive is equal to the rate at which it receives a negative charge when B is negative, we have

$$nu - V = n'v - V,$$

or

$$\frac{u}{v} = \frac{n'}{n}.$$

Thus from the measurement of the potential gradients we can determine the ratio $u : v$.

The apparatus used by Zeleny for carrying out this method is shown in Fig. 11. P and Q are brass plates 9 centimetres square. They are bored through their centres, and to the openings thus made the tubes R and S are attached, the space between the plates being covered in so as to form a closed box; K is a piece of wire-gauze completely filling the opening in the plate Q ; T is an

insulated piece of wire-gauze nearly but not quite filling the opening in the plate *P* and connected with one pair of quadrants of an

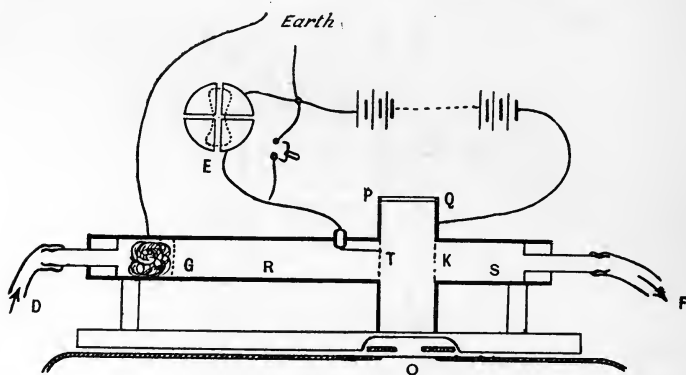

Fig. 11.

electrometer *E*. A plug of glass-wool *G* filters out the dust from a stream of gas which enters the vessel by the tube *D* and leaves it by *F*; this plug has also the effect of making the velocity of flow of the gas uniform across the section of the tube. The Röntgen rays to ionise the gas are produced by a bulb at *O*, the bulb and coil being in a lead-covered box fitted with an aluminium window through which the rays passed. *Q* is connected with one pole of a battery of cells, and *P* and the other pole of the battery connected with earth. When the rays are entering *PQ* and the ions are travelling in opposite directions in the box the charges they give to *P*, *Q* and *K* are conducted to earth, while those they give to *T* gradually change its potential at an approximately uniform rate, as long as this potential is small compared with that of *Q*. When the distribution of free charges in the gas has assumed a steady state all the changes in the potential of *T* are due to the charges given up by the ions striking against it.

The nature of the readings obtained with this apparatus are indicated by the curves shown in Fig. 12, where the ordinates represent the deflection of the electrometer in a given time and the abscissæ the potential difference in volts between the plates *P* and *Q*. Curve I. is for the case when the negative ions, Curve II. when the positive ions, are driven against the plate. It will be seen that after a point about *B* the curves are for some distance

straight lines, but that there is a curved portion to the left of *B*, indicating that some ions are delivered up to the gauze under smaller

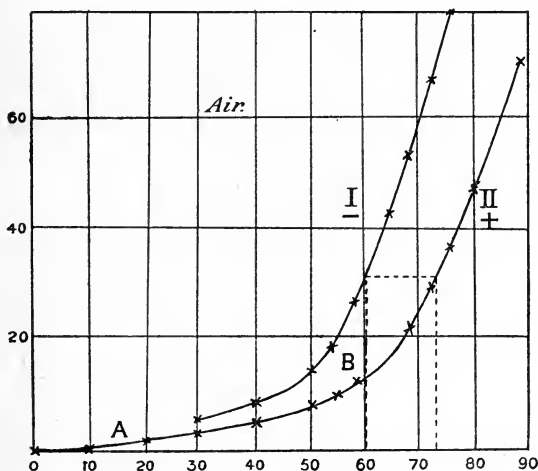

Fig. 12.

voltages than we should expect. This may possibly be explained by irregularities in the air blast, the deflections corresponding to the part of the curve about *A* arriving in the lulls of the blast. One way of treating the observations would be to produce the straight portion of the curves until they cut the horizontal axis; in the figure this would happen for Curve I. at about 50 volts and for Curve II. at about 60; we might then take 50 volts as the potential difference between the plates which would give to the negative ions a velocity equal to that of the blast, while 60 volts would be required to give the same velocity to the positive ions, so that under fields of equal strength the velocity of the negative ion would be to that of the positive as 6 to 5. The method actually adopted was different; the curves were regarded as merely a preliminary part of the experiment indicating about the values of the potential differences to employ in the final observations. Thus from the curves in Fig. 12 it is clear that to get the same deflection with the positive ions, as is got with the negative ions for a potential difference of 60 volts, would require a potential difference of between 72 and 74 volts; a careful series of measurements with differences of potential between these values is taken and the true

value of the potential difference found by interpolation. When this value, suppose for example 73·2, had been found, the ratio of the velocities of the negative to the positive ions was taken as 73·2 : 60.

The potential gradient between the plates was found to be not quite uniform owing to the accumulation of ions between the plates. The actual potential gradient was measured and a correction applied for the want of uniformity, this correction amounted to about 2 per cent. The results obtained by Zeleny are given in the following table.

RATIO OF VELOCITIES OF IONS.

Gas	$\frac{\text{Velocity of negative ion}}{\text{Velocity of positive ion}}$
Air	1·24
Oxygen	1·24
Nitrogen	1·23
Hydrogen	1·14
Coal gas.....	1·15
Carbon dioxide.....	1·00
Ammonia	1·045
Acetylene	0·985
Nitrogen monoxide ...	1·105

Thus acetylene is the only gas in which the velocity of the negative ion is less than that of the positive, and here the difference is so small that it is within the limits of error of the experiment. The gases in this experiment were not specially dried; we have seen that moisture has a great effect in reducing the velocity of the negative ion.

31. In some later experiments Zeleny* has determined the absolute values of the velocity of both the positive and negative ions. The method he employed was a blast method, though in these experiments the blast was at right angles to the lines of electric force instead of along them. A method similar to the one just described was tried for a considerable time (it is evident that if we know the velocity of the blast and the points where

* Zeleny, *Phil. Trans. A*, 195, p. 193, 1900.

the straight portions of the Curves I. and II. cut the horizontal axis we can deduce the velocity of both the positive and negative ions), but it had to be abandoned owing to the disturbance in the distribution of the velocity of the blast caused by the wire-gauze which in this method has to be used for the electrodes.

The theory of the method finally used is as follows. A stream of gas flows between two concentric metal cylinders which are kept at different potentials, the gas at one place is traversed by a beam of Röntgen rays at right angles to the axis of the cylinder; the ions thus produced are carried by the stream of gas parallel to the axis of the cylinder, while a velocity at right angles to this axis is imparted to them by the electric field. Let CC' , Fig. 13, represent a section of the outer cylinder, DB that of the inner one,

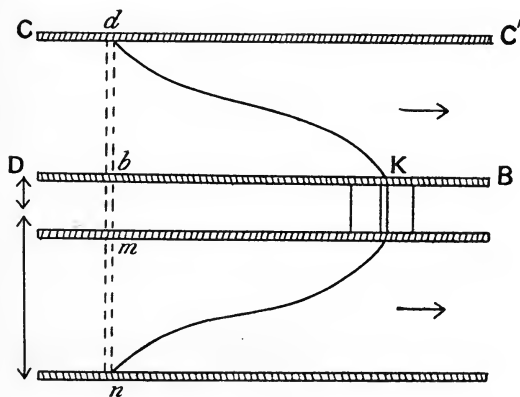

Fig. 13.

$dbmn$ the beam of Röntgen rays ionising the gas. If CC' is at a higher potential than DB , then a positive ion starting from d will move along a curved path between the cylinder, finally reaching the inner cylinder at a point K whose horizontal distance from d is one of the quantities measured in these experiments. This distance, X , can easily be expressed in terms of the velocity of the ion under unit electric force. For let b and a be respectively the radii of the outer and inner cylinders, A the potential difference between the cylinders, then the radial electric force R at a distance r from the common axis of the cylinder is given by the equation

$$R = \frac{A}{r \log_e (b/a)};$$

thus if v is the velocity of the ions under unit electric force, then on the assumption that the velocity is proportional to the electric force we have, if V is the radial velocity of the ion at a distance r from the axis of the cylinders,

$$V = \frac{Av}{r \log_e (b/a)}.$$

If u is the velocity of the gas parallel to the axis of the cylinders, which we shall take as the axis of x , the differential equation to the path of the ion is

$$\begin{aligned} \frac{dx}{dr} &= \frac{u}{V} \\ &= \frac{\log_e (b/a) ur}{Av}; \end{aligned}$$

hence X the horizontal distance from d at which the ion strikes the inner cylinder is given by the equation

$$X = \frac{\log_e (b/a)}{Av} \int_a^b ur dr.$$

Now $2\pi \int_a^b ur dr$ is the volume of gas which passes in unit time between the cylinders. We shall denote this quantity, which is easily measured, by Q , then we have

$$X = \frac{\log_e (b/a) Q}{2\pi Av},$$

or
$$v = \frac{\log_e (b/a) Q}{2\pi AX} \dots\dots\dots(1).$$

Thus if we know X we can easily determine v . The time T taken by the ion to pass from one cylinder to the other is given by the equation

$$\begin{aligned} T &= \int_a^b \frac{dr}{V} = \frac{\log_e (b/a)}{Av} \int_a^b r dr \\ &= \frac{\log_e (b/a)}{2Av} (b^2 - a^2) \\ &= \pi \frac{(b^2 - a^2) X}{Q} \dots\dots\dots(2). \end{aligned}$$

These equations apply to ions starting from the inner surface of the outer cylinder. In practice the production of ions is not

confined to the surface of the cylinder but extends throughout a layer db reaching from one cylinder to the other. The ions which start from a point in db , nearer to the surface of the inner cylinder than d , will evidently not be carried so far down the tube by the stream as an ion starting from d . Thus the preceding equations give us the position of the furthest point down the inner cylinder which is reached by the ions. In order to determine this point the inner cylinder is divided at K into two parts insulated from each other, the part D to the left being connected with the earth, while the part B to the right is connected with one pair of quadrants of an electrometer. If a constant stream of gas is sent between the cylinders, then when the potential of CC' is above a certain value, all the ions from the volume dd which move inwards will reach DB to the left of K and will not affect the electrometer. By gradually diminishing the potential of CC' we reach a value such that the ions starting from the outer edge of d reach DB just to the left of K ; when this stage is reached the electrometer begins to be deflected. If then in equation (1) we put for A the difference of potential corresponding to this stage and for X the horizontal distance of K from d , we shall be able to deduce the value of v .

Corrections. In consequence of the diffusion of the ions, all the ions starting from d will not follow exactly the line dK , and some of the ions will be found to the right of the line. The consequence of this is that the electrometer will begin to be deflected even when the potential difference A is theoretically sufficient to bring all the ions to the left of K ; thus the observed potential difference when the deflections begin is slightly too large, and therefore the values of v determined by equation (1) are a little too small. Similar effects to those due to diffusion will be produced by the mutual repulsion of the ions. It is evident that the magnitude of these effects will depend upon the time it takes the ion to travel between the cylinders; if this time were zero, neither diffusion nor repulsion would have time to produce any effect; thus the longer the time taken by the ions to travel between the cylinders, the smaller would be the value of v as determined by this method. The time T , as we see from equation (2), depends upon the velocity of the air blast and the strength of the field; by altering these quantities it is possible to determine the values of v for a con-

siderable range of values of T ; the values so found decrease, as was to be expected, slightly as T increases, the relation between v and T being found by experiment to be a linear one. Curves in which the ordinates were the ionic velocities and the abscissæ the time T were drawn, and the curve (which was found to be a straight line) prolonged until it cut the line $T=0$; the corresponding value of v was taken as the ionic velocity. An example of such curves is given in Fig. 14, the o 's and x 's are the points determined by

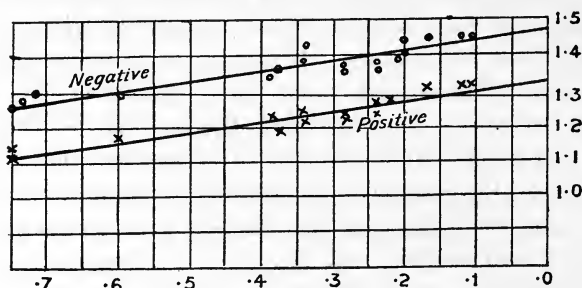

Fig. 14.

actual experiments. The points at which the lines intersect the line $T=0$ give 1.48 cm./sec. for the velocity of the negative ion and 1.34 for the velocity of the positive, when the potential gradient is one volt per cm.

Smaller corrections have to be applied for the disturbance in the electric field produced by the presence of an excess of ions of one sign over those of the other in different parts of the field. It was proved by direct experiment that the effects due to surface ionisation were not appreciable.

The apparatus used to carry out this method is represented in section in Fig. 15. AA' was the outer cylinder; it had an internal diameter of 5.1 cm. and a total length of 142 cm. The parts to the right of V' and to the left of V were made of brass tubing; the part between VV' was aluminium tubing of the same diameter; this piece was inserted so as to permit the Röntgen rays to pass through. The tubes were fastened together by air-tight joints and placed on insulating supports.

The inner cylinder BB' was an aluminium tube; in one set of experiments it was 1 cm. in diameter, in another it was 2.8 cm.;

the ends of this tube were closed by conical pieces. The tube was divided at *C* and the two portions separated by .5 mm. and

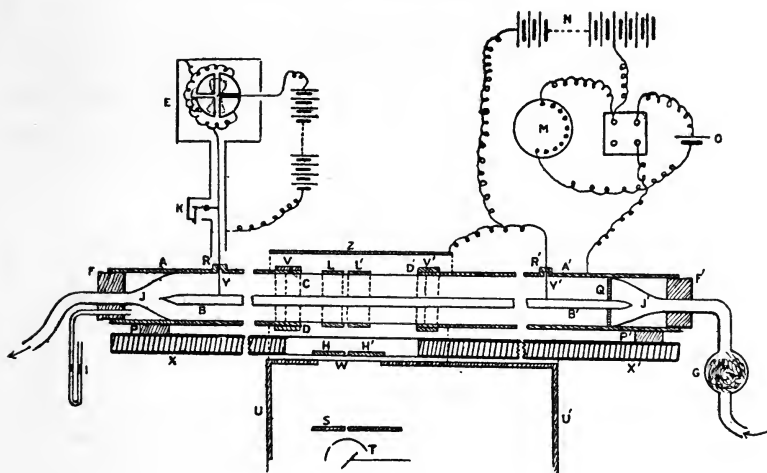

Fig. 15.

insulated by ebonite plugs. The tube was supported by the ebonite rod *Q* and by the stiff brass wires *Y* and *Y'* which passed through ebonite plugs in the outer cylinder, and served to connect *B'* with the earth, and *B* with one pair of quadrants of the electrometer. The electrometer was a very sensitive one, giving a deflection of 500 scale divisions for a potential difference of one volt. The narrow vertical beam of rays was adjusted and kept definite by the slits in the lead plates *S*, *HH'* and *LL'*. A constant and measurable supply of gas was sent through the tube by a gasometer. Experiments were made with gases carefully dried and with gases saturated with water vapour. Two series of experiments were made, one with an inner tube 1 cm. in diameter, the other with an inner tube 2.8 cm. in diameter; the results obtained in the one series agreed very well with those obtained in the other.

The values of the ionic velocities obtained by this method are given in the following table; they have been reduced to the uniform pressure of 760 mm. of mercury on the assumption (see p. 64) that the ionic velocity under a given potential gradient is inversely proportional to the pressure.

IONIC VELOCITIES.

Gas	Velocities in cm. per sec. under a potential gradient of one volt per cm.		Ratio of velocities of negative and positive ions	Tempera- ture degrees centigrade
	Positive ions	Negative ions		
Air dry	1·36	1·87	1·375	13·5
Air moist	1·37	1·51	1·10	14
Oxygen dry	1·36	1·80	1·32	17
Oxygen moist	1·29	1·52	1·18	16
Carbonic acid dry...	·76	·81	1·07	17·5
Carbonic acid moist	·82	·75	·915	17
Hydrogen dry	6·70	7·95	1·19	20
Hydrogen moist ...	5·30	5·60	1·05	20

The intensity of ionisation was altered by causing the Röntgen rays to pass through aluminium plates of different thicknesses, the ionic velocities were found to be independent of the intensity of the rays.

The results obtained by Zeleny agree well with those obtained for the sum of the velocities by Rutherford (see page 45) for air, oxygen, and hydrogen, allowing for the uncertainty as to the amount of moisture in the gases used by Rutherford; for carbonic acid however there is considerable discrepancy, as 2·15 cm./sec., the value of the sum of the velocities obtained by Rutherford, is nearly 40 per cent. greater than the value 1·57 obtained by Zeleny, and as Zeleny found that this sum was the same whether the gases were dry or moist the discrepancy cannot be explained as due to the excess or defect of moisture in Rutherford's gases.

Method of determining the velocity by measuring the number of ions sent by a radial electric field to the sides of a tube of given length when traversed by a current of gas.

32. The principle of this method, which has been used by Rutherford* to measure the velocities of the ions produced by uranium radiation, is as follows. Suppose that ionised air is blown through a tube along the axis of which there is a wire charged positively,

* Rutherford, *Phil. Mag.* v. 47, p. 109, 1899.

the electric field around the wire will drag the negative ions into the wire and thus rob the gas of a certain proportion of these ions; the number of these ions thus abstracted from the gas will depend upon the relation between the velocity of an ion in the electric field and the velocity of the air blast; if the ionic velocity were infinitely greater than the velocity of the blast, all the ions would be abstracted, while if the velocity of the blast were infinitely greater than the ionic velocity, they would all escape.

We see from equation (2), page 54, that t , the time taken by an ion to reach the wire, is given by the expression

$$t = \frac{r^2 - a^2}{2Au_2} \log_{\epsilon} \frac{b}{a} \dots\dots\dots(1),$$

where r is the distance from the axis of the tube of the point from which the ion starts, b the internal radius of the tube, a the external radius of the wire, A the difference of potential between the wire and the tube (the wire being at the higher potential), and u_2 the velocity of the negative ion under unit electric force. If in equation (1) we put t equal to the time taken by the air blast to pass from one end of the tube to the other, we see that all the ions whose distance from the axis of the tube is less than the value of r given by equation (1) will be dragged into the wire; hence if ρ is the ratio of the number of ions dragged from the gas to the whole number of ions, we have, assuming that the ions are uniformly distributed over the cross-section of the tube,

$$\rho = \frac{r^2 - a^2}{b^2 - a^2} = \frac{2Au_2t}{(b^2 - a^2) \log_{\epsilon}(b/a)},$$

or
$$u_2 = \frac{\rho(b^2 - a^2) \log_{\epsilon}(b/a)}{2At} \dots\dots\dots(2).$$

The arrangement used by Rutherford is represented in Fig. 16.

A paper tube coated with uranium oxide was fitted into a metal tube T 4 cm. in diameter. A blast of air from a gasometer, after passing through a plug of cotton-wool C to remove the dust, passed through a long metal tube AB connected with the earth; into this tube cylindrical electrodes A and B were fastened by insulating supports so as to be coaxial with the tube. The electrode A was charged up by a battery, and the electrode B was connected with one pair of quadrants of an electrometer. If B

were charged initially to a potential of the same sign as A (suppose positive) large enough to saturate the gas, then the rate

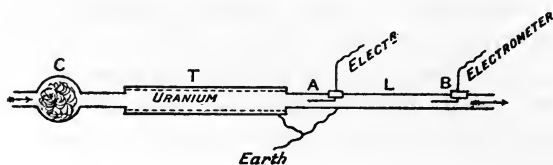

Fig. 16.

of leak of the electrometer when the air blast was passing would measure the number of negative ions which escaped being dragged into the electrode A ; by comparing the rate of leak when the electrode A is not charged, with the rate when it is charged to a known potential, we can determine the value of ρ in equation (2). Rutherford did not use this arrangement to measure directly the velocity of the ions produced by the uranium radiation, but proved by means of it that the velocities of these ions were the same as those of the ions produced by Röntgen rays. For this purpose, after measurements of ρ had been made with the uranium cylinder in place, this cylinder was removed and replaced by an aluminium one exposed to Röntgen rays, the strength of these rays being adjusted so that the amounts of ionisation in the two cases were approximately equal; measurements of ρ were then made with the Röntgen rays on and were found to be identical with those obtained when the ionisation was produced by uranium radiation, thus proving that the ionic velocities are the same in the two cases.

33. A method which is the same in principle as this was first used by McClelland to measure the velocities of the ions produced by flames*, and by arcs and incandescent wires†: the results of these experiments showed that the velocity of the ions diminishes very greatly when they get into the cooler parts of the flame, suggesting that there is a rapid condensation round the ions of some of the products of combustion in the flame. The

* McClelland, *Phil. Mag.* v. 46, p. 29, 1898.

† McClelland, *Proc. Camb. Phil. Soc.* x. p. 241, 1899.

diminution of velocity is clearly shown in the following table given by M^cClelland.

Distance of point where velocity was measured from the flame	Temperature at this point	Velocity of ion under a force of one volt per centimetre
5.5 cm.	230° C.	.23 cm./sec.
10 cm.	160° C.	.21 cm./sec.
14.5 cm.	105° C.	.04 cm./sec.

These velocities are all of them small compared with the velocities of the ions produced by Röntgen rays or by radio-active substances. In the case of the ions from flames as in other cases the negative ions move faster than the positive. M^cClelland applied the same method to the determination of the velocities of the ions produced by arcs or incandescent wires; he found in these cases the same variability in the velocity as he had previously observed in the ions from flames; in the case of the arcs and wires, however, he found that the hotter the flame or wire the smaller the velocity of the ion. We shall return to the consideration of these phenomena when we discuss the electrical properties of flames and arcs.

Determination of the ionic velocities by means of an alternating electric field.

34. This method, which however can only be applied when the ionisation is confined to a thin layer of gas, and when moreover all the ions are of one sign, is a very convenient and accurate one. It was used by Rutherford* to determine the velocity of the negative ions which are produced close to a metallic plate when that plate is illuminated by ultra-violet light. The principle of the method is as follows. *AB* (Fig. 17) is a horizontal plate made of well-polished zinc, which can be moved vertically up and down by means of a screw; it is carefully insulated, and is connected with one pair of quadrants of an electrometer, the other pair are connected with the earth. *CD* is a base plate with a hole *EF* cut in it; this hole is covered in with fine wire-

* Rutherford, *Proc. Camb. Phil. Soc.* ix. p. 401, 1898.

gauze, ultra-violet light from the source S passes through the quartz plates Q_1, Q_2 , and this gauze, and falls on the plate AB . CD

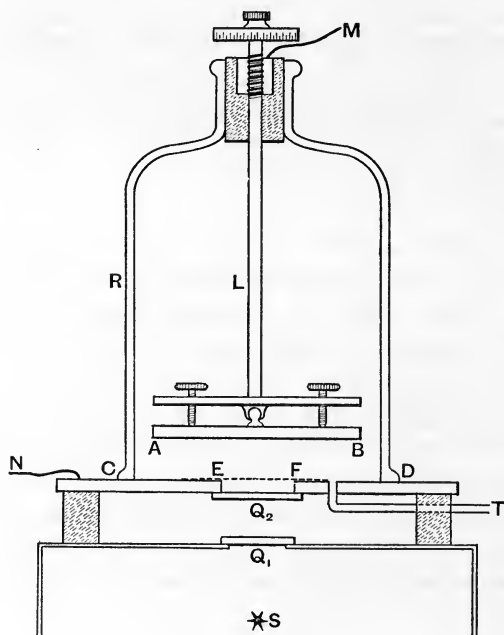

Fig. 17.

is connected with an alternating current dynamo or any other means of producing an alternating difference of potential proportional to a simple harmonic function of the time; the other pole of this instrument is put to earth. Suppose now that at any instant the potential of CD is higher than that of AB ; the negative ions at AB will be attracted towards CD , and will continue to move towards it as long as the potential of CD is higher than that of AB . If however the potential difference between CD and AB changes sign before the negative ions reach CD these ions will be driven back to AB , and this plate will not lose any negative charge. AB will thus not begin to lose negative electricity until the distance between the plates AB and CD is less than the distance passed over by the negative ion during the time the potential of CD is greater than that of AB . The distance between the plates is altered until AB just begins to lose a negative charge, then if we know this distance and the frequency

and maximum value of the potential difference we can deduce the ionic velocity of the negative ion. For let the potential difference between CD and AB at the time t be equal to $a \sin pt$, then if d is equal to the distance between these plates, the electric force is equal to $(a/d) \sin pt$, and if u is the velocity of the ion under unit electric force, the velocity of the negative ion in this field will be

$$u (a/d) \sin pt;$$

hence if x is the distance of the ion from the plate AB at the time t we have

$$\frac{dx}{dt} = \frac{ua}{d} \sin pt,$$

or

$$x = \frac{ua}{dp} (1 - \cos pt),$$

if $x=0$ when $t=0$.

Thus the greatest distance the ion can get from the plate AB is equal to $2ua/pd$. If the distance between the plates is gradually reduced, the plate AB will begin to lose a negative charge when

$$d = \frac{2ua}{pd}, \text{ or } u = \frac{pd^2}{2a}.$$

Hence if we measure p , a and d we can determine u .

In this way Rutherford found the following values for the velocities, under a potential gradient of 1 volt per cm. of the negative ions produced by the incidence of ultra-violet light on a zinc plate, in dry gases at atmospheric pressure.

Gas	Ionic velocity
Air	1.4 cm./sec.
Hydrogen	3.9 cm./sec.
Carbonic acid...	.78 cm./sec.

These values differ but little from those obtained when the ionisation was produced by Röntgen rays.

Rutherford found that the velocity of the ions was independent of the metal of which the plate AB was made; and he proved by this method that the velocities of the ions under a constant

potential gradient vary inversely as the pressure, at any rate down to pressures of 34 mm. of mercury which was the lowest pressure at which he worked.

Langevin's method of measuring the velocities of the ions.

35. Langevin* has devised a method of measuring the velocities of the ions which has the advantage of not requiring the use of a uniform source of Röntgen rays. The theory of the method is as follows. Suppose that we ionise, say by Röntgen rays, the gas between two parallel plates *A* and *B*, then stop the rays and apply a uniform electric field to the region between the plates. If the force on the positive ion is from *A* to *B* the plate *B* will receive a charge of positive electricity. After the field has been on in one direction for a time *T*, reverse it, *B* will now begin to receive negative electricity, and if the force is not reversed again will continue to do so until the ions are exhausted. If *n* is the number of ions of one sign per unit volume between the plates when the rays are cut off, *X* the electric force, *k*₁, *k*₂ the velocities of the positive and negative ions respectively under unit electric force, then during the time *T* the plate *B* will receive per unit area *nk*₁*XT* positive ions, supposing the field to be so strong that the loss of ions by recombination may be neglected, and also that *k*₁*XT* is less than *l*, the distance between the plates. The number of negative ions which in this time have gone to *A* is *nk*₂*XT* provided *k*₂*XT* is less than *l*, so that the number of negative ions left between the plates is *n(l - k*₂*XT)* and these when the field is reversed are driven to *B*. Thus if *Q* is the positive charge received by each unit area of the plate *B*,

$$Q = nk_1XT - n(l - k_2XT) = n(k_1 + k_2)XT - nl,$$

provided both *k*₁*XT* and *k*₂*XT* are less than *l*.

This will hold until *T* is equal to the smaller of the two quantities $\frac{l}{k_1X}$, $\frac{l}{k_2X}$; if *k*₂ is greater than *k*₁ the second limit will be reached first; when this limit is passed there are no negative ions left to be driven against *B* when the field is reversed; thus

$$Q = nk_1XT,$$

* Langevin, *Ann. de Chimie et de Physique*, t. xxviii. p. 289, 1903.

this will hold until $T = l/k_1 X$, for this and greater values of T ,

$$Q = nl.$$

Thus when $k_2 > k_1$

$$Q = e \{n(k_1 + k_2) XT - nl\}; \quad T < l/k_2 X;$$

$$Q = enk_1 XT; \quad T > l/k_2 X, < l/k_1 X;$$

$$Q = enl; \quad T > l/k_2 X, > l/k_1 X;$$

while if $k_1 > k_2$ we see that

$$Q = e \{n(k_1 + k_2) XT - nl\}; \quad T < l/k_1 X;$$

$$Q = e \{nl - n(l - k_2 XT)\} = ek_2 XT; \quad T > l/k_1 X, < l/k_2 X;$$

$$Q = enl, \quad T > l/k_2 X.$$

Thus if we represent the relation between Q and T graphically, the curves will be portions of straight lines as in fig. (18) intersecting at the point corresponding to $T = l/k_1 X$, $T = l/k_2 X$; if we find these points of intersection we can deduce the values of k_1 , k_2 .

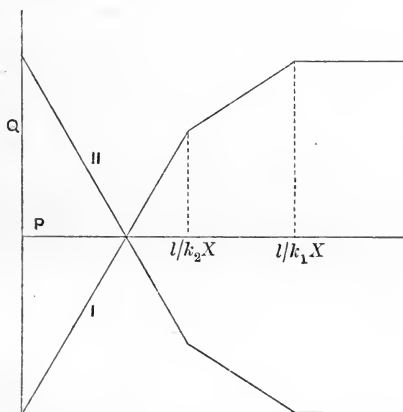

Fig. 18. In curve I the electric force is initially from A to B , in curve II from B to A .

In consequence of inequalities in the ionisation between the plates, and from the recombination of the ions, the curve obtained in practice does not consist of three straight lines, but of three curves which intersect at well defined nicks; an example of such a curve is shown in Fig. 19, which is taken from Langevin's paper. If $k_1 = k_2$ two of the nicks coincide. If we had a mixture of different gases with several kinds of ions there would be a nick

corresponding to each positive ion and also one corresponding to each negative ion.

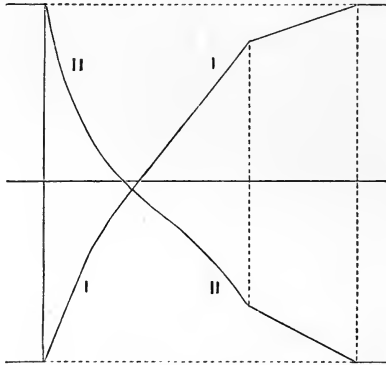

Fig. 19.

By means of this method Langevin has investigated the variation of the velocity of the ion with the pressure of the gas. The results of his experiments are shown in the following table, where p represents the pressure measured in centimetres of mercury, k_1 and k_2 the velocities of the positive and negative ions in air under unit electrostatic force, *i.e.* 300 volts per centimetre.

Negative ions			Positive ions		
p	k_2	$pk_2/76$	p	k_1	$pk_1/76$
7.5	6560	647	7.5	4430	437
20.0	2204	580	20.0	1634	430
41.5	994	530	41.5	782	427
76.0	510	510	76.0	480	420
142.0	270	505	142.0	225	425

If the structure of the ion remained unaltered the velocity under an electric field would be inversely proportional to the pressure, thus pk would be independent of the pressure. The numbers given in the table show that this is approximately true for the positive ions down to a pressure of 7.5 cm.; for the negative ions however there is a very considerable increase in pk when the pressure is reduced below 20 cm., indicating that the structure of the negative ion gets simpler as the pressure is reduced.

Edmunds has made experiments in the Cavendish Laboratory on the variation of the mobility of the ions in helium, using Langevin's method: he finds that for the positive ions pk is constant down to a pressure of 2.2 cm. but that for the negative ions pk increases when the pressure is reduced below 16 cm. and that at 2.2 cm. it is twice as great as at 76 cm.

The following method of measuring the velocities of the ions is now being used at the Cavendish Laboratory. A thin layer BB' of the gas between two parallel metal plates A and B is exposed to the ionising rays. The gas above B' is not ionised. The ionisation in BB' is not continuous, occurring during short periods separated by regular intervals. This is effected by interposing between the vessel AB and the source of the ionising rays a revolving lead disc with a slit in it; the source of the rays whether radium or a Röntgen ray tube is arranged so as to emit a horizontal sheaf of rays. This sheaf is stopped by the lead disc except for the short period in each revolution when the rays pass through the slit and ionise the layer BB' . A commutator is fixed on the axis of the disc and a brush in connection with the plate B presses against it; the commutator is arranged so that immediately after the disc has passed the position in which the rays pass through the slit, B is connected with one terminal of a battery of storage cells, the middle of this battery is put to earth, when the lead disc has made half a revolution, the commutator puts B to the other terminal of the battery and the electric field between A and B is reversed. A is connected with an insulated electroscope which initially was at the potential of the earth. Let $2T$ be the time taken by the lead disc to make one revolution, then if after exposure of the gas to the rays, B is made positive, the positive ions approach A with a velocity k_1V/l , for a time T , where $2V$ is the potential difference between the terminals of the battery and l the distance between the plates. The negative ions are approaching B with the velocity k_2V/l , these start from close to B so that it is easy to arrange matters so that in the time T all the negative ions come against B . In the time T the positive ions move through a distance $k_1 \frac{V}{l} T$ towards the positive plate, if this distance is greater than l all the positive ions will reach A and this plate will receive a charge of positive

electricity. If on the other hand $\frac{k_1 V}{l} T$ is less than l , the positive ions will not have reached A when the field is reversed and they have to retrace their steps, in this case A will not receive any charge. Thus if we measure the charge on A as the distance between the plates A and B is varied, the charge will increase abruptly when $k_1 \frac{V}{l} T = l$, hence if we measure l when the increase takes place we can determine k_1 ; to determine k_2 all we have to do is to arrange the commutator so that B is negatively charged after the exposure of the gas to the rays.

Chattock's method of measuring the velocities of ions produced by the discharge of electricity from a sharp point.

36. The preceding methods would be very inconvenient in the case when the electric field is as strong and the velocities of the ions therefore as great as they are when electricity is discharging from a pointed conductor. For this case, in which the ions at some little distance from the point are all of one sign, Chattock* has devised a very ingenious method by means of which he has been able to measure the velocities of these ions. The principle of the method is as follows. Let P represent a vertical

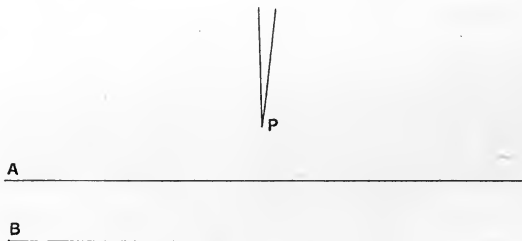

Fig. 20.

needle discharging electricity from its point into the surrounding air; consider the force acting on the ions included between two horizontal planes A and B , Fig. 20. If Z is the vertical component of the electric intensity, ρ the density of the electrification, the

* Chattock, *Phil. Mag.* v. 48, p. 401, 1899; Chattock, Walker and Dixon, *Phil. Mag.* vi. 1, p. 79, 1901.

resultant force F on the ions included between A and B is vertical and equal to

$$\iiint Z\rho dx dy dz.$$

If the velocity of the ion under unit electric force is u , then w the vertical velocity of the ion is equal to uZ . If all the ions are of one sign so that u is the same for all the ions, we have, since $Z = w/u$,

$$F = \frac{1}{u} \iiint w\rho dx dy dz.$$

Since the ions are all of one sign $\iiint \rho w dx dy$ is the quantity of electricity streaming across a horizontal plane in unit time; this is the same for all horizontal planes, and is equal to i where i is the current of electricity flowing from the needle-point, hence we have

$$F = \frac{i}{u} \int dz = \frac{i}{u} (z_B - z_A),$$

where $z_B - z_A$ is the vertical distance between the planes A and B . This force F must be balanced by the difference of the gaseous pressures over A and B , hence if p_B and p_A denote respectively the total pressures over the planes A and B we have

$$F = p_B - p_A,$$

and hence

$$u = \frac{i(z_B - z_A)}{p_B - p_A} \dots\dots\dots(1).$$

Thus, by the measurement of these pressures and of the current flowing from the point (the latter measurement is easily made by inserting a galvanometer in series with the needle-point), we can deduce the value of u .

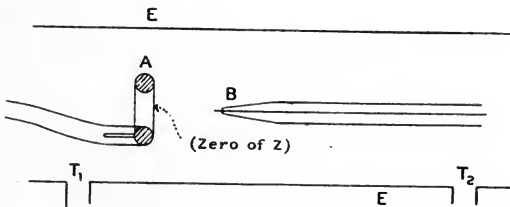

Fig. 21.

The apparatus used by Chattock to carry out this method is represented in Fig. 21. The discharging needle is supported in a narrow sliding glass tube drawn out at the end B ; it discharges to

a ring A made of smooth metal; the needle and ring are enclosed in a wide glass tube E , the ends of which are connected by tubes T_1 and T_2 with the ends of a U-tube pressure gauge containing water; the ring A can be moved along the tube by means of a screw. In this apparatus, since there is no current to the left of the ring or to the right of the point, if we put $z_B - z_A$ equal to z , the distance of the point from the ring, and if ω is the difference of pressure in dynes per sq. cm. measured by the pressure gauge, A the area of cross-section of the tube, then

$$p_B - p_A = \omega A + p',$$

where p' is the part of the pressure which is borne by the ring. We have, by equation (1),

$$\omega = \frac{i}{Au} z - \frac{p'}{A}.$$

It was assumed that when the point was a considerable distance from the ring p' became independent of z ; on this supposition we have, if $\Delta\omega$, Δz are corresponding changes in ω and z ,

$$\frac{\Delta\omega}{\Delta z} = \frac{i}{Au},$$

and it was from this relation that u was calculated. Chattock found for the velocities of the negative and positive ions in air under a potential gradient of a volt per cm. the values 1.8 cm./sec. and 1.38 cm./sec., which agree well with those found for the ions produced by Röntgen rays, and we conclude that the ions in the two cases are the same. In the second paper Chattock extends the method to hydrogen, oxygen, and carbonic acid as well as air, and again finds close agreement between the velocities of the ions produced by the point discharge and those produced by radioactive substances. He points out that while the determinations of the ionic velocities of the positive ions showed in all gases great consistency, considerable variations which could not be attributed to errors of experiment were found in the values of the velocities of the negative ions. This was especially the case in hydrogen, where the values of the ionic velocity of the negative ion varied from 6.8 to 8.5; in the other gases the variation is not so marked. Chattock ascribes this variation to the gases occluded by the discharging point; when this point is negative some of these occluded gases are given off and help to carry the discharge, and as the velocity of the hydrogen ions is very large compared with

that of other ions, it is urged that a small admixture of other and more slowly moving ions might produce a considerable lowering of the average velocity. When the point is positive the occluded gas is supposed either not to be given off, or, if given off, not to take any part in carrying the discharge. This explanation is consistent with other phenomena connected with the discharge of electricity from metals; we shall see that in the electric discharge through gas at low pressures occluded gas is given off from the cathode, and that the amount of gas so given off has very considerable influence upon the phenomena. The values obtained by Chattock for the velocities of the ions produced by the point discharge are given in the following table, in which V_+ denotes the velocity of the positive ion, V_- that of the negative, and \bar{V} the mean of these velocities. The gases were dry.

Gas	V_+	V_-	\bar{V}	V_-/V_+
Hydrogen	5.4	7.43	6.41	1.38
Carbonic acid ...	0.83	0.925	0.88	1.11
Air	1.32	1.80	1.55	1.36
Oxygen	1.30	1.85	1.57	1.42

Determination of the coefficient of recombination when the velocities of the ions are known.

37. The principle of this method which is due to Langevin* is as follows. Suppose that A and B are two parallel plates immersed in a gas, let a slab of the gas bounded by the parallel planes a, b be ionised by an instantaneous flash of Röntgen rays. Let there be an electric force between the plates, then all the positive ions produced by the rays would be attracted to the negative plate and all the negative ions to the positive plate, and if the field were infinitely strong they would reach these plates before they had time to recombine, so that each plate would receive N_0 ions, if the flash of Röntgen rays produced N_0 positive and N_0 negative ions. With weaker fields the number of ions received by the plates will be less as some of these will recombine before they can reach the plates. To find the number in this case we proceed as follows. In consequence of the movements of the ions under

* Langevin, *Ann. de Chimie et de Physique*, t. xxviii, p. 289, 1903.

the electric field the slab of ionised gas will broaden out and will consist of three portions, one on the side of the negative plate in which there are nothing but positive ions, a middle portion in which there are both positive and negative ions, and a portion on the side of the positive plate in which there are only negative ions. If n is the number of ions per unit volume in the middle layer at the time t ,

$$\frac{dn}{dt} = -\alpha n^2 \quad \text{or} \quad n = \frac{n_0}{1 + \alpha n_0 t},$$

where n_0 is the value of n when $t=0$. No recombination occurs in the outer portions, so that all the ions in these portions will reach the plate to which they are nearest.

In the time dt the breadth of each of the outer layers will increase by $X(k_1 + k_2)dt$, where X is the electric force between the plates and k_1 and k_2 the velocities of the positive and negative ions under unit electric force, the number of negative ions added to the layer next the positive plate and of positive ions to the layer next the negative plate in this time is therefore

$$nX(k_1 + k_2)dt = \frac{n_0 X(k_1 + k_2)dt}{1 + n_0 \alpha t}.$$

The outer layers will continue to receive fresh ions until the middle layer disappears, which it will do after a time $l/X(k_1 + k_2)$, l being the breadth of the slab ab . Hence N the number of negative and also of positive ions which escape recombination and reach their respective plates is equal to

$$\int_0^{l/X(k_1+k_2)} \frac{n_0 X(k_1 + k_2)}{1 + n_0 \alpha t} dt = \frac{X(k_1 + k_2)}{\alpha} \log \left(1 + \frac{n_0 \alpha l}{X(k_1 + k_2)} \right).$$

Let $\alpha/4\pi e(k_1 + k_2) = \epsilon$, and $n_0 l e = Q_0$, Q_0 is the charge on the whole of the positive or negative ions produced by the rays, e being the charge on an ion, then if Q is the charge received by one of the plates we have

$$Q = Ne = \frac{X}{4\pi\epsilon} \log \left(1 + \frac{Q_0\epsilon}{4\pi X} \right) \dots\dots\dots(1).$$

If Q_1 is the charge received by either plate when the electric force is X_1

$$Q_1 = \frac{X_1}{4\pi\epsilon} \log \left(1 + \frac{Q_0\epsilon}{4\pi X_1} \right) \dots\dots\dots(2).$$

From equations (1) and (2) we can eliminate Q_0 and determine ϵ .

By this method Langevin got the following values of ϵ for air and carbonic acid at different pressures.

Air		CO ₂	
Pressure in mm.	ϵ	Pressure in mm.	ϵ
152	0.01	135	0.01
375	0.06	352	0.13
760	0.27	550	0.27
1550	0.62	758	0.51
2320	0.80	1560	0.95
5 atm.	0.90	2380	0.97

We have supposed the ionisation in the slab ab to be uniform. Langevin has shown that equations (1) and (2) hold whatever may be the distribution of the initial ionisation.

Langevin has assigned a physical meaning to the quantity denoted by ϵ , according to his theory it is the ratio of the number of collisions between oppositely charged ions which result in recombination, to the whole number of collisions. In attempting to interpret this result the question arises what is a 'collision.' We can detect recombination, but a collision which does not result in recombination does not produce any effect which can be measured. It is evident then that the value of the ratio of the number of recombinations to the number of collisions must be to a large extent a matter of definition and depend upon the view we take of the nature of the ions and of the character of the forces between them; for this reason I have adopted in § 18 a different method of calculating the value of α .

*Evidence as to the nature of the ions afforded by
their velocity under an electric field.*

38. We can obtain some information about the constitution of the ions from the rates of diffusion and their velocity under given electric forces. The question we shall consider is whether the ions are very much more complex in their structure than the molecules of the gas in which they are produced. From the tables of the rates of diffusion of ions and gases given on pp. 39, 40 we see that

the rate of diffusion of hydrogen ions through hydrogen is comparable with the rate of diffusion of the molecules of isobutylic amide (molecular weight 73) through hydrogen: are we to conclude from this that the hydrogen ion is a complex of some 36 molecules of hydrogen? Again, the proportion between the rates of diffusion of ions through hydrogen, air and carbonic acid is not very different from the proportion between the rates of diffusion of the molecules of isobutylic amide or ether vapour through these gases: are we to conclude from this that the ions in hydrogen, air and carbonic acid are identical? A closer investigation shows that in all probability neither of these conclusions is valid. To see this let us find an expression for the velocity of an ion through a gas: if e is the charge on the ion, m its mass, t the average time between two collisions, X the electric force acting on the ion, the velocity of the ion parallel to X will be $\frac{1}{2} X \frac{e}{m} t$. If the ion were a *molecule* of hydrogen and the gas surrounding it hydrogen, then if the mean free path of a charged hydrogen molecule is the same as that of an uncharged one, $t = (1/9480 \times 10^6)$ sec. (Lothar Meyer, *Theorie der Gase*), and $e/m = \frac{1}{2} 10^4$, hence if U is the velocity under a force of a volt per centimetre, *i.e.* $X = 10^9$, $U = 26$ cm./sec., while u the velocity of the positive ion in dry hydrogen is 6.7 cm./sec. For a charged oxygen molecule moving through oxygen,

$$e/m = \frac{1}{2} 10^4 \times 1/16, \quad t = 1/4065 \times 10^6,$$

thus $U = 3.8$ cm./sec. while u the velocity of the positive ion is 1.36.

$$\text{For CO}_2, \quad e/m = \frac{1}{2} 1/22 \times 10^4, \quad t = 1/5510 \times 10^6,$$

hence $U = 2.06$ cm./sec. while $u = .78$ cm./sec.

$$\text{For Cl}_2, \quad e/m = \frac{1}{2} 1/35.5 \times 10^4, \quad t = 1/6240 \times 10^6,$$

$$U = 1.1 \text{ cm./sec. while } u = 1.$$

$$\text{For SO}_2, \quad e/m = \frac{1}{2} 1/32 \times 10^4, \quad t = 1/6000 \times 10^6,$$

$$U = 1.1 \text{ cm./sec. while } u = .5.$$

$$\text{For Helium, } e/m = \frac{1}{4} 10^4, \quad t = 1/2630 \times 10^6,$$

$$U = 47.32, \quad u = 1.4.$$

Tabulating these results we get

Gas	U	u	U/u
Helium.....	47.3	1.4	34
H ₂	26	6.7	3.8
O ₂	3.8	1.36	2.7
CO ₂	2.06	.78	2.7
SO ₂	1.25	.5	2.5
Cl ₂	1.1	.1	1.1

Thus except in the case of helium the velocity of the ion is more than one quarter the velocity of a single molecule. Let us consider what would be the velocity of a group of n molecules carrying the charge e . In the expression $\frac{1}{2} X \frac{e}{m} t$, m for the group would have n times its value for a single molecule; $t = \lambda/v$, where λ is the mean free path and v the relative velocity of the ion and the molecules of the gas; if λ_0 is the value of the free path for the molecule, λ its value for the group of n molecules $\frac{1}{\lambda} = \frac{1}{\lambda_0} \frac{(n+1)}{2}$ while v the relative velocity for the group is equal to $\frac{1}{2} v_0 \left(1 + \frac{1}{\sqrt{n}}\right)$, where v_0 is the relative velocity for the single molecule: making these substitutions we find that the velocity of the group would be

$$\frac{4 \text{ (velocity of the molecule)}}{n(n+1) \left(\frac{1}{\sqrt{n}} + 1\right)},$$

thus if $n=3$ the velocity of the group would be $1/4.7$ of the velocity of the molecule, *i.e.* less than the velocity of the ions for any of the gases except helium, thus a very slight aggregation would be sufficient to account for the want of mobility of the ions.

In calculating the mean free path we have left out of consideration the effect of the charge on the ion; in consequence of this charge the forces between an ion and a molecule will not be the same as those between two molecules, and the additional force due to the charge on the ion might reasonably be expected to affect the mean free path. There is some evidence however that this effect is not considerable, for according to Morreau (*Ann. de Chimie et de Physique* (7) 30, p. 5, 1903) the velocity of the

positive ion in a flame containing potassium salts is 80 cm./sec. under an electric force of a volt per centimetre, the temperature of the flame being between 1600° C. and 1700° C. Now from the formula $u = \frac{1}{2} X \frac{e t}{m v}$, assuming that the potassium atom carries the unit positive charge so that $e/m = 10^4/39$, we find, putting $X = 10^8$, $u = 80$, that $t = 6.24 \times 10^{-9}$; if this were the value of the time between two collisions at a temperature 1638° C. = $6 \times 273^\circ$ C. the corresponding time at 0° C. would be $\frac{1}{\sqrt{6}} 6.24 \times 10^{-9} = 2.6 \times 10^{-9}$. This value is greater than we should expect even if the potassium ion were uncharged; this result then, as far as it goes, is against the view that the charge on the ion materially increases the number of collisions between it and the surrounding molecules.

Charges on the ions.

39. We saw on page 43 that the coefficient of diffusion, D , of an ion through a gas was connected with the velocity under unit electric force, u , of the same ion through the same gas by the equation

$$\frac{u}{D} = \frac{Ne}{\Pi},$$

where N is the number of molecules in a c.c. of gas at a pressure of Π dynes per square cm. It is to be remembered that this relation is obtained on the supposition that a number of ions in a given volume produce the same pressure as the same number of molecules of a perfect gas at the same temperature; in other words, that the ions behave like a perfect gas with respect to pressure. As we have seen that the ions in a gas at atmospheric pressure are probably aggregations more complex than the molecules of a perfect gas, we must regard this assumption as only an approximation to the truth, even for the simpler ions, and one which may be far from accurate when the ions are as large as those which occur in the colder parts of flames or near an incandescent wire.

Taking the values of D given by Townsend and (1) the values of u given by Rutherford, (2) those given by Zeleny, we get the following values for $Ne \times 10^{-10}$, e being expressed in electrostatic units.

From Rutherford's experiments on the mean velocities of the ions in gases and the mean of the coefficients of diffusion given by Townsend we get

I.

Gas	$Ne \times 10^{-10}$
Air	1.35
Oxygen	1.25
Carbonic acid...	1.30
Hydrogen	1.00

From Zeleny's values for the velocities of the ions and Townsend's for the coefficients of diffusion we get for $Ne \times 10^{-10}$

II.

Gas	Moist Gas		Dry Gas	
	Positive ions	Negative ions	Positive ions	Negative ions
Air	1.28	1.29	1.46	1.31
Oxygen	1.34	1.27	1.63	1.36
Carbonic acid...	1.01	.87	.99	.93
Hydrogen	1.24	1.18	1.63	1.25

Since one electromagnetic unit or 3×10^{10} electrostatic units of electricity when passing through acidulated water liberates 1.23 c.c. of hydrogen at the temperature of 15° C. and pressure of 760 mm. of mercury, and since in 1.23 c.c. of gas there are $2.46N$ atoms of hydrogen, we have, if E is the charge in electrostatic units on the atom of hydrogen in the electrolysis of solutions,

$$2.46NE = 3 \times 10^{10},$$

or

$$NE = 1.22 \times 10^{10}.$$

The mean of all the values of Ne in Tables I. and II. is 1.24×10^{10} .

We conclude then (1) that the charges carried by the gaseous ions are the same whether the ions are produced in air, oxygen, hydrogen or carbonic acid, (2) that this charge is equal to the charge carried by the hydrogen atom in the electrolysis of solutions.

The proof of the equality of the charges on the ions in different gases was first obtained by the author by direct measurements of the charges carried by the gaseous ions. Though the variations in the value of Ne given in Tables I. and II. are greater than we should have expected from the accuracy with which the experiments were made, they are not sufficiently regular to enable us to draw any conclusions; thus for example in Table I. Ne for carbonic acid is considerably greater than for hydrogen, while in Table II. it is very much less. We must remember too that these results have been obtained on the supposition that the complex ions behave like a perfect gas; if they behaved like complex vapours the values for Ne obtained on this supposition would be somewhat too large.

Currents in the gas caused by the motion of ions through it.

40. Since the charged ions when in an electric field settle down to a state of steady motion in which they have no acceleration the force exerted by the field on the ions is transferred to the gas. Thus when in any region there is an excess of the ions with charges of one sign over those having the opposite sign there will be a resultant force acting on the gas in this region which may start currents in the gas. In the case of a current passing through ionised gas between parallel metal plates, there is, as we shall see in the next paragraph, an excess of positive ions in the layer of gas near the negative plate and of negative ions in the layer next the positive plate; these layers will be acted on by forces tending to make them move towards their respective plates. If these plates were infinite these forces would be balanced by an excess of pressure next the plate, but if the plates are finite this excess of pressure will relieve itself by the gas moving round to the back of the plate and a system of air currents will be set up.

These currents have been observed by Zeleny* by means of the apparatus represented in Fig. 22. A and B are the two parallel metal plates, connected to the opposite poles of a battery of storage cells. The plates are enclosed in a box of which the sides P and P' are made of blocks of paraffin, while the other two sides are glass to enable the observer to see what is going on inside. The bottom of the box is made of wood, Röntgen rays

* Zeleny, *Proc. Camb. Phil. Soc.* x. p. 14, 1898.

pass through this and ionise the gas between the plates. The vessel *R* contains liquid ammonia, from which ammonia gas passes

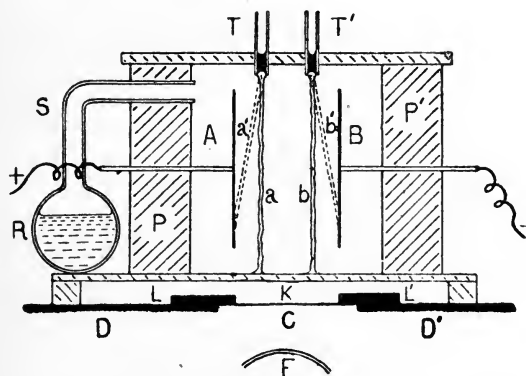

Fig. 22.

through the tube *S* into the box. The tubes *T* and *T'* contain drops of hydrochloric acid. The particles of ammonium chloride formed at the lower ends of the tube, where the acid is in contact with the ammonia, fall slowly, producing well-defined vertical whitish streams *a* and *b* near the plates *A* and *B*. These streams are vertical so long as the Röntgen rays and the electric field are not on together. If, however, when the electric field is on, the gas is exposed to the rays, the streams are deflected towards the plates as indicated by the dotted lines in the figure. In order to show that this was not due to any charge on the solid particles of ammonium chloride the experiment was repeated with streams of carbonic acid gas, the difference of refractive index between this gas and air being sufficient to render the streams visible; it was found that these streams, like those of the ammonium chloride, were deflected towards the plate.

41. For convenience of reference we give a table containing the results of the measurements of the ionic velocities. The velocities are expressed in cms. per second and are for a potential gradient of 1 volt per cm. V_+ , V_- denote respectively the velocities of the positive and of the negative ions, V the mean of these velocities.

VELOCITIES OF IONS.

Ions from Röntgen Rays.

Gas	V_+	V_-	V	Observer
{ Air	1·6	Rutherford
{ Air dry	1·36	1·87	1·61	Zeleny
{ Air moist	1·37	1·51	1·44	Zeleny
{ Oxygen	1·4	Rutherford
{ Oxygen dry	1·36	1·80	1·58	Zeleny
{ Oxygen moist	1·29	1·52	1·405	Zeleny
{ Carbonic acid	1·07	Rutherford
{ Carbonic acid dry	·76	·81	·78	Zeleny
{ Carbonic acid moist.....	·82	·75	·78	Zeleny
{ Hydrogen	5	Rutherford
{ Hydrogen dry	6·70	7·95	7·2	Zeleny
{ Hydrogen moist	5·30	5·60	5·45	Zeleny
{ Nitrogen	1·6	Rutherford
{ Sulphur dioxide	·5	Rutherford
{ Hydrochloric acid	1·27	Rutherford
{ Chlorine	1·0	Rutherford
{ Helium dry	1·42	2·03	1·72	Edmunds

Ions from Ultra-Violet Light.

Air.....	...	1·4	...	Rutherford
Hydrogen	3·9	...	Rutherford
Carbonic acid	·78	...	Rutherford

Ions from Flames.

Velocities varying from ·04 to ·23..... McClelland

Ions liberated by Chemical Action.

Velocities of the order 0·0005 Bloch

Ions from point discharge.

Hydrogen	5·4	7·43	6·41	Chattock
Carbonic acid	0·83	0·925	0·88	Chattock
Air.....	1·32	1·80	1·55	Chattock
Oxygen	1·30	1·85	1·57	Chattock

Potential gradient between two parallel plates immersed in an ionised gas and maintained at different potentials.

42. It was shown first by Zeleny*, and then independently by Child†, that when electricity is passing between two plates immersed in ionised gas, the potential gradient between the plates is not uniform, but is greatest in the neighbourhood of the electrodes. The difference of potential between one of the plates and any point in the gas may be measured by having a water or mercury dropper at the point; the most convenient way, however, is to place at the point a fine wire, which will ultimately assume the potential of the point. When the wire is used it is necessary however to take several precautions: in the first place, if the number of ions in the gas is small, the wire will only take up the potential very slowly, and it is important that the instrument used for measuring the potential of the wire should have very small capacity. This consideration often makes it desirable to use a small gold-leaf electroscope to measure the potential of the wire instead of a quadrant electrometer, which though more sensitive to differences of potential has yet a very much greater capacity. Another point to be remembered is that if a wire is placed in a region where the ions are all of one sign, its potential can only change one way. Thus if it is a region where there are only positive ions, its potential can increase but cannot decrease, and thus if the potential of the wire gets by some accident too high, it cannot sink to its true value.

A characteristic curve for the distribution of potential between the plates, due to Zeleny, is given in Fig. 23. It will be seen that the gradient near the centre of the field is uniform, but that near the plates the gradients get much steeper and that they are steeper at the negative than at the positive plate.

From the equation $\frac{d^2 V}{dx^2} = -4\pi\rho$, where V is the potential at a distance x from the plate and ρ the density of the electrification, we can, if we know the distribution of potential, calculate the density of the electrification at any point between the plates.

* Zeleny, *Phil. Mag.* v. 46, p. 120, 1898.

† Child, *Wied. Ann.* lxxv. p. 152, 1898.

The density corresponding to the potential curve in Fig. 23 is shown in Fig. 24.

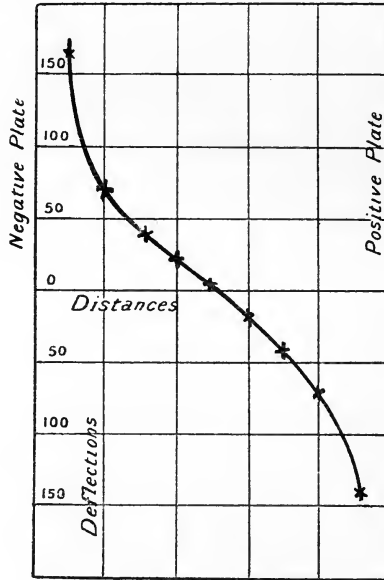

Fig. 23.

We see that near the positive plate there is an excess of negative electricity while near the negative plate the positive

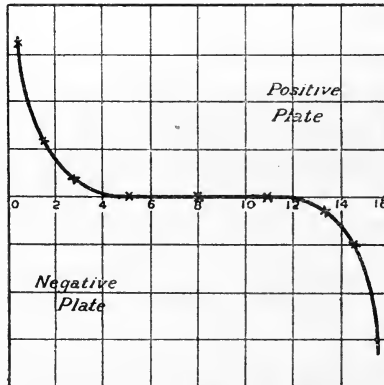

Fig. 24.

electricity is in excess. With the small potential differences used in this experiment the regions where there is an excess of one

kind of electricity over the other are in the immediate neighbourhood of the plates, the density of the free electricity being exceeding small in the central portion of the field. If a larger potential difference had been applied to the plates, the regions with free electricity would have expanded, and with very large potential differences these regions would fill the whole of the space between the plates. In the example given, the greatest density of the electrification is about 2×10^{-4} electrostatic units; as the charge on an ion is about 3.5×10^{-10} such units, the number of positive ions in a cubic centimetre would exceed that of negative by about 6×10^5 . Taking the number of molecules in a cubic centimetre of the gas as 3.5×10^{19} , the ratio of the excess of ions of one sign to the number of molecules is only 1.6×10^{-14} . As most of the negative ions would be driven away from the neighbourhood of the negative plate, this will approximately represent the ratio of the number of free ions to the number of molecules. This example is an illustration of the very small amount of ionisation which is sufficient to account for many of the phenomena of the conduction of electricity through gases.

CHAPTER III.

MATHEMATICAL THEORY OF THE CONDUCTION OF ELECTRICITY THROUGH A GAS CONTAINING IONS.

43. WE shall now proceed to develop the theory of electric conduction through an ionised gas on the basis that the velocities of the ions are proportional to the electric force acting upon them. We shall take the case of two infinite parallel metal plates maintained at different potentials and immersed in an ionised gas; the lines of electric force are everywhere at right angles to the plates; they are thus always parallel to a line which we shall take as the axis of x .

Let n_1, n_2 be respectively the number of positive and negative ions per unit volume at a place fixed by the coordinate x , let q be the number of positive or negative ions produced in unit time per unit volume at this point by the ionising agent; let X be the electric intensity at this point, k_1, k_2 the velocities of the positive and negative ions under unit electric intensity, so that the velocities of these ions at this point are respectively k_1X, k_2X ; let e be the charge on an ion. The volume density of the electrification, supposed due entirely to the presence of the ions, is $(n_1 - n_2)e$; hence we have

$$\frac{dX}{dx} = 4\pi (n_1 - n_2) e \dots\dots\dots(1).$$

If i is the current through unit area of the gas, and if we neglect any motion of the ions except that caused by the electric field, we have

$$n_1 e k_1 X + n_2 e k_2 X = i \dots\dots\dots(2).$$

From equations (1) and (2) we get

$$n_1 e = \frac{1}{k_1 + k_2} \left\{ \frac{i}{X} + \frac{k_2}{4\pi} \frac{dX}{dx} \right\} \dots\dots\dots(3),$$

$$n_2 e = \frac{1}{k_1 + k_2} \left\{ \frac{i}{X} - \frac{k_1}{4\pi} \frac{dX}{dx} \right\} \dots\dots\dots(4).$$

If we measure the distribution of electric force between the plates, we can from these equations, if we know k_1 and k_2 , determine n_1 and n_2 , or if in addition to the distribution of electric force, we measure, by the methods previously given, n_1, n_2 at various points in the field, we can use these equations to determine k_1 and k_2 , the velocities of the ions.

When the gas is in a steady state, the number of negative and of positive ions in each unit of volume must remain constant with respect to the time, thus the losses of these ions must be balanced by the gains. Now ions are lost in consequence of the recombination of the positive and negative ions: these ions will come into collision with each other, and in a certain fraction of the whole number of collisions the positive and negative ions will combine to form a single system which is electrically neutral and which no longer acts as an ion; the number of collisions in unit volume in unit time is proportional to $n_1 n_2$. We shall suppose that the number of positive or negative ions which recombine in unit volume in unit time is $\alpha n_1 n_2$: this is the rate at which unit volume is losing positive and negative ions in consequence of recombination; in consequence of ionisation it is gaining them at the rate q , and in consequence of the motion of the ions under the electric force it is losing positive ions at the rate $\frac{d}{dx}(n_1 k_1 X)$ and negative ones at the rate $-\frac{d}{dx}(n_2 k_2 X)$. The diffusion of the ions causes unit volume to lose positive and negative ions at the rates

$$-D_1 \frac{d^2 n_1}{dx^2}, \quad -D_2 \frac{d^2 n_2}{dx^2},$$

where D_1 and D_2 are the coefficients of diffusion of the positive and negative ions. Unless the electric field is very weak the motion of the ions by diffusion is, except in quite exceptional cases, insignificant in comparison with that under the electric field. We

shall therefore for the present leave diffusion out of account. Hence when the gas is in a steady state we have

$$\frac{d}{dx}(n_1 k_1 X) = q - \alpha n_1 n_2 \dots\dots\dots(5),$$

$$-\frac{d}{dx}(n_2 k_2 X) = q - \alpha n_1 n_2 \dots\dots\dots(6).$$

If k_1 and k_2 are constant at all parts of the field, we have from (1), (5) and (6)

$$\frac{d^2 X^2}{dx^2} = 8\pi e (q - \alpha n_1 n_2) \left(\frac{1}{k_1} + \frac{1}{k_2} \right) \dots\dots\dots(7).$$

From this equation, if we know the distribution of X^2 between the plates, we can determine whether ionisation or recombination is in excess at any point, for from (7) $q - \alpha n_1 n_2$ and $d^2 X^2/dx^2$ have the same sign, hence when ionisation is in excess of recombination, *i.e.* when $q - \alpha n_1 n_2$ is positive, $d^2 X^2/dx^2$ is positive and the curve whose ordinate is X^2 is convex to the axis of x ; when recombination is in excess of ionisation the curve for X^2 is concave to the axis of x .

Substituting in equation (7) the values of n_1, n_2 given by equations (3) and (4) we get

$$\begin{aligned} \frac{d^2 X^2}{dx^2} = 8\pi e \left(\frac{1}{k_1} + \frac{1}{k_2} \right) \left\{ q - \frac{\alpha}{e^2 X^2 (k_1 + k_2)^2} \right. \\ \left. \times \left(i + \frac{k_2}{8\pi} \frac{dX^2}{dx} \right) \left(i - \frac{k_1}{8\pi} \frac{dX^2}{dx} \right) \right\} \dots\dots\dots(8). \end{aligned}$$

I have not been able to get a general solution of this differential equation except when q is constant and $k_1 = k_2$; in that case putting

$X^2 = y$ and $\frac{dy}{dx} = p$ we get, writing k for either k_1 or k_2 ,

$$p \frac{dp}{dy} = \frac{16\pi e}{k} \left\{ q - \frac{\alpha}{4e^2 k^2 y} \left(i^2 - \frac{k^2 p^2}{64\pi^2} \right) \right\} \dots\dots\dots(9).$$

Integrating this we get

$$\frac{k^2 p^2}{64\pi^2} - i^2 = \frac{qek}{2\pi \left(1 - \frac{\alpha}{8\pi ek} \right)} y + Cy^{\frac{\alpha}{8\pi ek}} \dots\dots\dots(10),$$

where C is a constant of integration. From this equation we can find the ratio of X_0 , the electric intensity midway between the

plates, to X_1 , the electric intensity close to a plate. For when $k_1 = k_2$ the distribution of electric force is symmetrical and midway between the plates dX/dx and $p = 0$; let us further assume that we are dealing with a case like that in Fig. 24, where there is no free electricity for some distance from the plane midway between the plates, so that here d^2X/dx^2 also vanishes; hence from (9) and (10) we have

$$X_0^2 = \frac{\alpha i^2}{4e^2 k^2 q},$$

$$\frac{-X_0^2 \frac{4k^2 e^2 q}{\alpha}}{1 - \frac{\alpha}{8\pi e k}} = C X_0^{\frac{\alpha}{4\pi e k}} \dots\dots\dots(11).$$

Now at the positive plate $n_1 = 0$ and at the negative plate $n_2 = 0$; hence at either plate $n_1 n_2 = 0$, but

$$n_1 n_2 = \frac{1}{4k^2 e^2 X^2} \left(i^2 - \frac{k^2 p^2}{64\pi^2} \right);$$

hence if X_1 is the value of X at either plate, we have

$$\frac{-X_1^2 \frac{qek}{2\pi}}{1 - \frac{\alpha}{8\pi e k}} = C X_1^{\frac{\alpha}{4\pi e k}} \dots\dots\dots(12).$$

Hence by (11) and (12)

$$\frac{8\pi k e}{\alpha} = \left(\frac{X_0}{X_1} \right)^{\frac{\alpha}{4\pi e k} - 2},$$

or writing β for $8\pi k e / \alpha$ we get

$$\frac{X_0^2}{X_1^2} = \beta^{\frac{\beta}{1-\beta}}.$$

We see from this equation that X_0/X_1 is never greater than unity, for $\beta^{\frac{\beta}{1-\beta}}$ diminishes from unity to zero as β increases from $\beta = 0$ to $\beta = \text{infinity}$. Since β does not involve either q or i , the ratio of the electric intensities does not depend upon either the intensity of the ionisation or of the current between the plates. For air at atmospheric pressure $k = 480$ (since unit electrostatic force is 300 volts per centimetre), α is about 1.2×10^{-6} , and $e = 3.5 \times 10^{-10}$; substituting these values we find $\beta = 3.9$ for air

at atmospheric pressure. Since k is inversely proportional to the pressure, β is inversely proportional to the pressure, and thus is very large at the pressure of a few millimetres of mercury. Putting $\beta = 4$ we find

$$\frac{X_1}{X_0} = 4^{\frac{1}{2}} = 2.51 \text{ approximately.}$$

At low pressures β is large, in this case $X_1/X_0 = \beta^{\frac{1}{2}}$ approximately, and thus the ratio of X_1 to X_0 varies inversely as the square root of the pressure.

The experiments we have described on the distribution of electric force between the plates show that when the current is small, the regions where X differs appreciably from X_0 are confined to two layers near the plates, the distribution of X between the plates being represented by a curve like that shown in Fig. 25. We can very easily find an inferior limit to λ , the thickness of one of these layers. For let P be a point on the boundary of the

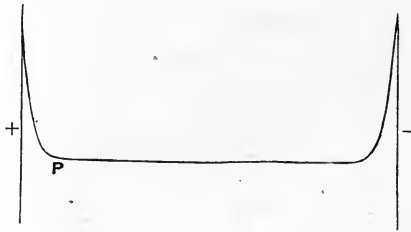

Fig. 25.

layer next the electrode, then since X becomes constant at P , there are at this point as many positive as negative ions per unit volume, and if the velocities of the ions are the same, half the current must be carried by the positive and half by the negative ions. Thus if i is the current through unit area, and e the charge on an ion, $i/2e$ positive ions must cross unit area of a plane through P in unit time; and all these positive ions must be produced in the region between P and the positive plate. But if λ is the thickness of the layer, the number of positive ions produced in unit time corresponding to each unit area of the plate is $q\lambda$, the number that cross unit area at P cannot therefore be greater than $q\lambda$, and can only be as great when there is no recombination of the ions between P and the positive plate, hence

$$q\lambda > \frac{i}{2e},$$

or $\lambda > i/2eq$; thus $i/2eq$ is an inferior limit to λ . If I is the maximum current, l the distance between the plates, $I = qle$; hence $i/2I$ is an inferior limit to λ/l .

44. Though we cannot find a general solution of the equations (1), (2), (5), (6) when k_1 is not equal to k_2 we see at once that a particular solution of these equations is given by the relations

$$\begin{aligned} n_1 &= n_2 = (q/\alpha)^{\frac{1}{2}}, \\ k_1 n_1 X e &= \frac{k_1}{k_1 + k_2} i, \\ k_2 n_2 X e &= \frac{k_2}{k_1 + k_2} i, \\ X &= \left(\frac{\alpha}{q}\right)^{\frac{1}{2}} \frac{i}{e(k_1 + k_2)}. \end{aligned}$$

This solution corresponds to a constant value of the electric force between the plates, and indicates that the proportion of the current carried by the positive and negative ions respectively is the same as the ratio of the velocities of these ions. This solution, though it may apply to the central portion of the field, cannot however hold right up to the plates. For suppose P is a point between the plates at which this solution applies. Then across unit area at P , $ik_1/(k_1 + k_2)e$ positive ions pass in unit time, and these must come from the region between P and the positive plate; if the distance of P from this plate is λ this region cannot furnish more than $q\lambda$ positive ions in unit time, and can only do this when there is no recombination; hence the preceding solution cannot hold at a distance from the positive plate less than

$$\frac{k_1}{k_1 + k_2} \frac{i}{qe}.$$

Similarly it cannot hold at a distance from the negative plate less than

$$\frac{k_2}{k_1 + k_2} \frac{i}{qe}.$$

We shall assume that the preceding solution does hold at distances from the plates greater than the preceding values: and further that in the layers in which the solution does not hold there is no recombination of the ions.

Let us consider the state of things at the positive plate between $x = 0$ and $x = \lambda_1$, where

$$\lambda_1 = \frac{k_1}{k_1 + k_2} \frac{i}{qe}.$$

Then, since in this region there is no recombination, equations (1), (5), (6) become

$$\frac{dX}{dx} = 4\pi(n_1 - n_2),$$

$$\frac{d}{dx}(k_1 n_1 X) = q,$$

$$\frac{d}{dx}(k_2 n_2 X) = -q.$$

If q is constant we have

$$k_1 n_1 X = qx,$$

$$k_2 n_2 X = \frac{i}{e} - qx,$$

where the constant of integration has been chosen so as to make $n_1 = 0$ when $x = 0$: substituting these values for n_1, n_2 in the equation giving dX/dx we get

$$X \frac{dX}{dx} = 4\pi e \left\{ qx \left(\frac{1}{k_1} + \frac{1}{k_2} \right) - \frac{i}{ek_2} \right\},$$

or
$$X^2 = 8\pi e \left\{ \frac{1}{2} qx^2 \left(\frac{1}{k_1} + \frac{1}{k_2} \right) - \frac{ix}{ek_2} \right\} + C \quad \dots\dots(13),$$

where C is a constant which may be determined from the condition that when $x = \lambda_1$

$$X^2 = \frac{\alpha}{q e^2 (k_1 + k_2)^2};$$

from this we find

$$C = \frac{\alpha}{q e^2 (k_1 + k_2)^2} \left\{ 1 + \frac{4\pi e k_1}{\alpha k_2} (k_1 + k_2) \right\}.$$

C is the value of X^2 when $x = 0$, *i.e.* at the positive plate; if we call this value X_1 , and if X_0 is the constant value of X between the layers, we have

$$X_1 = X_0 \left\{ 1 + \frac{4\pi e k_1}{\alpha k_2} (k_1 + k_2) \right\}^{\frac{1}{2}};$$

thus X_1 is always greater than X_0 and the ratio X_1/X_0 does not depend upon the amount of ionisation or the strength of the current between the plates.

If X_2 is the value of X at the negative plate, we can prove in a similar way that

$$X_2 = X_0 \left\{ 1 + \frac{4\pi e k_2}{\alpha k_1} (k_1 + k_2) \right\}^{\frac{1}{2}}.$$

Thus if k_2 , the velocity of the negative ion, is very large compared with k_1 , the velocity of the positive ion, the value of X at the negative plate is large compared with its value at the positive, and the thickness of the layer in which X is variable, is greater at the negative than it is at the positive plate. A curve representing the distribution of electric intensity between the plates in this case is represented in Fig. 26.

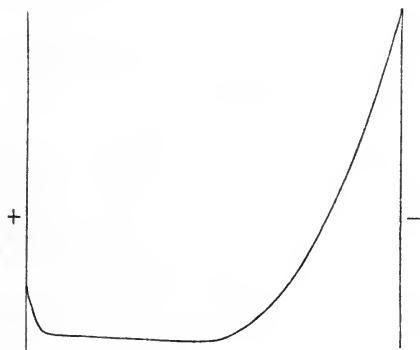

Fig. 26.

If we put

$$\beta_1 = \frac{4\pi e k_1}{\alpha k_2} (k_1 + k_2) : \beta_2 = \frac{4\pi e k_2}{\alpha k_1} (k_1 + k_2),$$

we have

$$X_1 = X_0 (1 + \beta_1)^{\frac{1}{2}} : X_2 = X_0 (1 + \beta_2)^{\frac{1}{2}};$$

when β_1 and β_2 are large we have approximately

$$X_1 = X_0 \beta_1^{\frac{1}{2}} : X_2 = X_0 \beta_2^{\frac{1}{2}}.$$

In the special case when the velocities of the positive and negative ions are equal $\beta_1 = \beta_2$ and $X_1/X_0 = (8\pi e k_1/\alpha)^{\frac{1}{2}}$, this agrees when β is large with the result found by the independent investigation of this case given on p. 87.

The fall of potential V_1 across the layer next the positive plate whose thickness is λ_1 is equal to

$$\int_0^{\lambda_1} X dx;$$

substituting the value of X given by equation (13) and integrating we find

$$\begin{aligned} V_1 &= \frac{1}{2} X_1 \lambda_1 + \frac{1}{2} \frac{X_0 \lambda_1}{\sqrt{\beta_1}} \log(\sqrt{\beta_1} + \sqrt{1 + \beta_1}) \\ &= \frac{1}{2} X_0 \lambda_1 \left\{ (1 + \beta_1)^{\frac{1}{2}} + \frac{1}{\sqrt{\beta_1}} \log(\sqrt{\beta_1} + \sqrt{1 + \beta_1}) \right\}. \end{aligned}$$

$$\text{Since } X_0 = \left\{ \frac{\alpha}{q} \right\}^{\frac{1}{2}} \frac{i}{e(k_1 + k_2)}, \text{ and } \lambda_1 = \frac{k_1}{k_1 + k_2} \frac{i}{qe},$$

$$V_1 = \frac{1}{2} \frac{\alpha^{\frac{1}{2}} i^2 k_1}{q^{\frac{3}{2}} e^2 (k_1 + k_2)^2} \left\{ (1 + \beta_1)^{\frac{1}{2}} + \frac{1}{\sqrt{\beta_1}} \log(\sqrt{\beta_1} + \sqrt{1 + \beta_1}) \right\} \dots (14).$$

Thus the fall of potential across this layer is proportional to the square of the current.

If V_2 is the change in potential in crossing the layer next the negative electrode we find similarly

$$V_2 = \frac{1}{2} \frac{\alpha^{\frac{1}{2}} i^2 k_2}{q^{\frac{3}{2}} e^2 (k_1 + k_2)^2} \left\{ (1 + \beta_2)^{\frac{1}{2}} + \frac{1}{\sqrt{\beta_2}} \log(\sqrt{\beta_2} + \sqrt{1 + \beta_2}) \right\}.$$

If β_1 and β_2 are very large we have approximately

$$V_1 = \frac{1}{2} \frac{\alpha^{\frac{1}{2}} i^2}{q^{\frac{3}{2}} e^2} \frac{k_1}{(k_1 + k_2)^2} \beta_1^{\frac{1}{2}},$$

$$V_2 = \frac{1}{2} \frac{\alpha^{\frac{1}{2}} i^2}{q^{\frac{3}{2}} e^2} \frac{k_2}{(k_1 + k_2)^2} \beta_2^{\frac{1}{2}}.$$

Substituting the values of β_1, β_2 we find

$$\frac{V_1}{V_2} = \frac{k_1^2}{k_2^2},$$

or the falls of potential at the positive and negative plates are proportional to the squares of the velocities of the positive and negative ions.

Let us consider how the fall of potential varies with the pressure of the gas: if p is the pressure, k_1 and k_2 are inversely proportional to p , and q is directly proportional to p , hence we see that for a given current V_1 and V_2 vary inversely as p .

The relation between the potential difference between the plates and the current.

45. The fall of potential between the plates is made up of the fall of potential at the layers which we have already calculated and the fall of potential in the space between the layers where the

electric intensity is uniform and equal to X_0 ; the breadth of this space is $l - (\lambda_1 + \lambda_2)$, where l is the distance between the plates, and since $\lambda_1 + \lambda_2$ is equal to i/qe , the fall of potential in this space is equal to

$$X_0 \left(l - \frac{i}{qe} \right),$$

or to

$$\left(\frac{\alpha}{q} \right)^{\frac{1}{2}} \frac{i}{e(k_1 + k_2)} \left(l - \frac{i}{qe} \right);$$

adding to this the values for the fall of potentials across the layers we get, if V is the potential difference between the plates,

$$V = \frac{1}{2} \frac{\alpha^{\frac{1}{2}} i^2}{q^{\frac{3}{2}} e^2 (k_1 + k_2)^2} \left\{ k_1 (1 + \beta_1)^{\frac{1}{2}} + \frac{k_1}{\sqrt{\beta_1}} \log (\sqrt{\beta_1} + \sqrt{1 + \beta_1}) \right. \\ \left. + k_2 (1 + \beta_2)^{\frac{1}{2}} + \frac{k_2}{\sqrt{\beta_2}} \log (\sqrt{\beta_2} + \sqrt{1 + \beta_2}) \right\} \\ + \frac{\alpha^{\frac{1}{2}} i}{q^{\frac{1}{2}} e (k_1 + k_2)} \left(l - \frac{i}{qe} \right) \dots\dots\dots(15).$$

This equation is of the form

$$V = Ai^2 + Bi,$$

thus the curve whose ordinate is i and abscissa V is a parabola. This equation ceases to be an approximation to the truth when the two layers touch, *i.e.* when $\lambda_1 + \lambda_2 = l$ or $i = qel$; in this case the current is the greatest that can be carried by the ionised gas. The minimum value of the potential difference required to produce this current is got by putting $i = qel$ in equation (15); we see that the potential difference required to produce saturation is proportional to the square of the distance between the plates and to the square root of the intensity of ionisation.

46. The study of the distribution of electric intensity between the plates when the maximum current is passing leads to an easy way of finding the ratio of the velocities of the positive and negative ions, for as in this case there is no recombination, equations (5) and (6), p. 86, give

$$k_1 n_1 X = qx \dots\dots\dots(16),$$

$$k_2 n_2 X = q(l - x) \dots\dots\dots(17),$$

where x is measured from the positive plate. At the point between the plates where the force is a minimum

$$\frac{dX}{dx} = 0 = 4\pi (n_1 - n_2) e,$$

hence at this point $n_1 = n_2$, so that if x is the distance of the point P where X is a minimum from the positive plate we have by equations (16) and (17)

$$\frac{k_1}{k_2} = \frac{x}{l-x};$$

thus the ratio of the velocities of the positive and negative ions is equal to the ratio of the distances of P from the positive and negative plates, so that if we have determined P by measuring the distribution of potential between the plates we can at once deduce the ratio of the velocities.

47. Mie* has by successive approximations obtained solutions of equation 8, p. 86, (1) when the current is only a small fraction

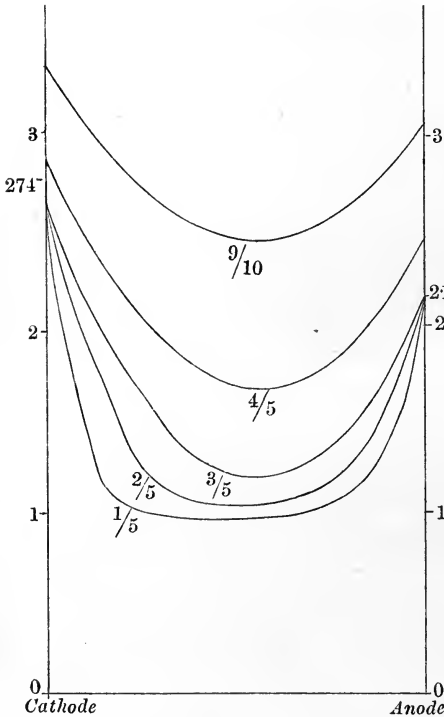

Fig. 27.

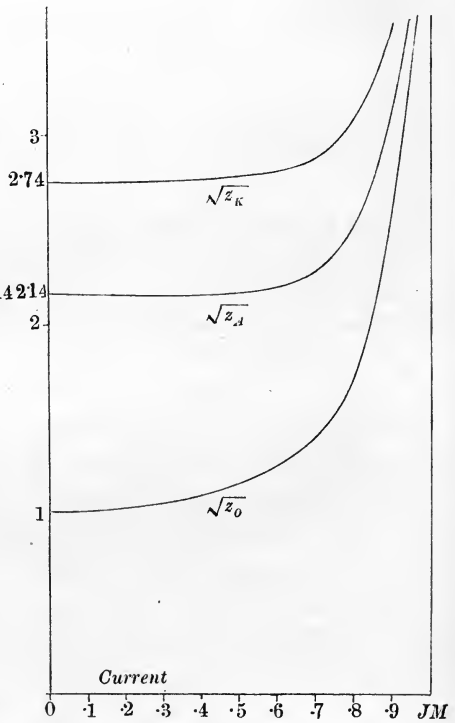

Fig. 28.

of the saturation current, (2) when the current is nearly saturated. The results of his investigation are shown in Figs. 27, 28.

* Mie, *Ann. der Physik* 13, p. 857, 1904.

Fig. 27 represents the distribution of the electric force along the current for various values of the current expressed as fractions of the saturation current. It will be seen that until the current amounts to about 1/5 of the maximum current the type of solution is that indicated on page 88, *i.e.* the electric force is constant except in the neighbourhood of the electrodes where it increases rapidly. In Fig. 28 the quantities denoted by $\sqrt{z_0}$, $\sqrt{z_A}$, $\sqrt{z_K}$ are proportional respectively to the ratios of the minimum electric force, the force at the anode, and the force at the cathode to the current. The result indicated by the solution on page 87 that the ratios of the forces close to the electrodes to the minimum electric force is independent of the current is seen to hold for a wide range of currents.

Solutions of equation 7, p. 86, at pressures chosen so as to make $\alpha/4\pi ek$ have special values, have been given by G. W. Walker (*Phil. Mag.*, Nov. 1904) and Robb (*Phil. Mag.*, Aug. and Dec. 1905).

Case when the velocity of one ion is very large compared with that of the other.

48. The case when the velocity of the negative ion is very large compared with that of the positive is of great importance, and admits of complete solution. We may deduce the equation for X , the electric force, by putting $k_1/k_2 = 0$ in equation (8), p. 86, or proceed independently as follows.

Using the notation of Art. 43 we have

$$i = n_1 k_1 X e + n_2 k_2 X e \dots\dots\dots(1),$$

$$\frac{d}{dx} (n_2 k_2 X e) = q - \alpha n_1 n_2 \dots\dots\dots(2),$$

$$\frac{dX}{dx} = 4\pi e (n_1 - n_2) \dots\dots\dots(3).$$

In this case the current is practically carried by the negative ions so that $i = n_2 k_2 X e$ and therefore $q = \alpha n_1 n_2$.

Thus
$$n_2 = \frac{i}{k_2 X e} \text{ and } n_1 = \frac{q k_2 X e}{\alpha i},$$

substituting these values of n_1 and n_2 in (3) we get

$$\frac{dX}{dx} = \frac{4\pi e^2 k_2 q X}{\alpha i} - \frac{4\pi i}{k_2 X},$$

or
$$\frac{dX^2}{dx} - \frac{8\pi e^2 k_2 q X^2}{\alpha i} = -\frac{8\pi i}{k_2}.$$

The solution of this equation is

$$X^2 = \frac{\alpha}{q} \frac{i^2}{k_2^2 e^2} + C\epsilon \frac{8\pi e^2 k_2 q}{\alpha i} x \dots\dots\dots(4);$$

in this case x is measured from the positive electrode, it is more convenient to measure it from the negative; if x be the distance from the negative electrode, equation (4) becomes

$$X^2 = \frac{\alpha i^2}{q k_2^2 e^2} + C'\epsilon \frac{8\pi e^2 k_2 q}{\alpha i} x \dots\dots\dots(5).$$

To find the value of the constant of integration C' , we have by equation (7), p. 86,

$$\left[\frac{dX^2}{dx} \frac{k_1 k_2}{(k_1 + k_2) 8\pi e} \right]_{x_1} = \int_0^{x_1} (q - \alpha n_1 n_2) dx \dots\dots\dots(6).$$

The right-hand side of the equation is the excess of ionisation over recombination in the region extending from the cathode to $x = x_1$, it must therefore be equal to the excess of the number of negative ions leaving the column at x over those entering the column at the cathode, *i.e.* it is equal to $(i - i_0)/e$, where i_0 is the amount of negative electricity emitted by the cathode in unit time.

When x_1 is large $\frac{dX^2}{dx} = 0$, hence equation (6) becomes

$$C' \frac{8\pi e^2 k_2 q}{\alpha i} \frac{k_1 k_2}{(k_1 + k_2) 8\pi e} = \frac{i - i_0}{e};$$

thus

$$C' = \frac{\alpha i (i - i_0)}{q k_1 k_2 e^2} \frac{k_1 + k_2}{k_2},$$

and therefore, since k_1 is small compared with k_2 ,

$$X^2 = \frac{\alpha i^2}{q k_2^2 e^2} \left(1 + \frac{k_2}{k_1} \frac{i - i_0}{i} \epsilon^{-\frac{8\pi e^2 k_2 q}{\alpha i} x} \right) \dots\dots\dots(7).$$

From the values which have been found for k_2 and α , we infer that the second term inside the bracket will be very small when eqx is large compared with i , thus the second term will be very small outside a layer of gas next the cathode of such thickness that the number of ions produced inside it would be sufficient to carry the current supposing they were all utilised for this purpose: in the case of flames and hot gases this layer is very thin unless the current is exceedingly large, so that in these cases it will only be close to the cathode that the second term inside the bracket is appreciable. Thus from equation (7) we learn that the electric

force will be constant except in the immediate neighbourhood of the cathode, where it increases to a very large value; the force at the cathode itself bears to the force in the uniform part of the field the ratio of $(k_1 + k_2)^{\frac{1}{2}}$ to $k_1^{\frac{1}{2}}$. This uniformity of field throughout the greater part of the circuit combined with the rapid increase close to the cathode is, as we shall see, a very characteristic feature of the passage of electricity through flames and hot gases.

If V is the difference of potential between the electrodes $V = \int X dx$; there is no difficulty in integrating the value of X given by equation (7), an approximate solution will however bring out the essential points more clearly. Except quite close to the cathode the electric force is equal to $\frac{i}{ek_2} \left(\frac{\alpha}{q}\right)^{\frac{1}{2}}$, hence the fall of potential in the uniform part of the field is very approximately equal to $\frac{i}{ek_2} \left(\frac{\alpha}{q}\right)^{\frac{1}{2}} l$, where l is the distance between the electrodes.

Close to the cathode the electric force X when i_0 is small compared with i is approximately given by the equation

$$X = \frac{i}{e(k_1 k_2)^{\frac{1}{2}}} \left(\frac{\alpha}{q}\right)^{\frac{1}{2}} e^{-\frac{4\pi e^2 k_2 q}{ai} x},$$

the fall of potential at the cathode is approximately $\int_0^{\infty} X dx$ or

$$\frac{i}{e(k_1 k_2)^{\frac{1}{2}}} \left(\frac{\alpha}{q}\right)^{\frac{1}{2}} \frac{ai}{4\pi e^2 k_2 q}.$$

Hence V the potential difference between the plates is given by the equation

$$V = \left(\frac{\alpha}{q}\right)^{\frac{1}{2}} \frac{1}{ek_2} \left(li + \frac{ai^2}{4\pi e^2 q} \frac{1}{\sqrt{k_1 k_2}} \right).$$

The fall of potential near the cathode is proportional to the square of the current, while the fall in the rest of the circuit is directly proportional to the current. In the case of conduction through hot gases and flames containing salt vapours we shall see that the fall of potential close to the cathode very much exceeds that in the rest of the circuit, for this to be the case the velocity of the negative ion must be a very large multiple of that of the positive.

49. When a current of electricity is passing through a flame very interesting results are produced by putting a bead of salt in the

flame, the salt vaporises and the ionisation in the salt vapour is much more intense than in the other parts of the flame. Hittorf found, however, that unless the bead of salt is introduced near the cathode it produces but little effect upon the current, when however the region containing the salt vapour reaches the cathode the salt enormously increases the current. The relation between the current and potential difference in this case is easily obtained by the aid of the preceding equations. Let A be the positive, B the negative electrode, and let us take, as representing the part of the flame containing the salt vapour, a slab ab in which the ionisation and velocity of the negative ion are not the same as in the adjacent layers. Then if X is the electric force, we have, in the region Bb ,

$$X^2 = \frac{\alpha i^2}{qk_2^2 e^2} \left(1 + \frac{k_2}{k_1} \epsilon^{-\frac{8\pi e^2 R_2 q}{\alpha i} x} \right) \dots\dots\dots(1),$$

where x is the distance of the point where the force is X from B ; in the region ba at a distance x_1 from b

$$X^2 = \frac{\alpha' i^2}{QK_2^2 e^2} + C\epsilon^{-\frac{8\pi e^2 k_2 Q}{\alpha' i} x_1} \dots\dots\dots(2),$$

where α' , Q , K_2 are the values of α , q and k_2 in this region and C is a constant to be determined.

In the region aA at a distance x_2 from a , we have

$$X^2 = \frac{\alpha i^2}{qk_2^2 e^2} + C'\epsilon^{-\frac{8\pi e^2 k_2 q}{\alpha i} x_2} \dots\dots\dots(3),$$

the exponential terms will diminish rapidly as we recede from B , b , a respectively, we shall assume that the three regions are broad enough for the exponential term in (1) to be negligible at b , and that in (2) at a , in this case since X^2 is continuous we have

$$\frac{\alpha i^2}{qk_2^2 e^2} = \frac{\alpha' i^2}{QK_2^2 e^2} + C,$$

or

$$C = \frac{i^2}{e^2} \left(\frac{\alpha}{qk_2^2} - \frac{\alpha'}{QK_2^2} \right);$$

again

$$\frac{\alpha i^2}{qk_2^2 e^2} + C' = \frac{\alpha' i^2}{QK_2^2 e^2},$$

so that

$$C' = -C.$$

Neither C nor C' contains the large factor $1/k$, and we find by integration that the drop of potential at the surfaces a , b is very small in comparison with the whole potential difference

between a and b , the diminution in potential difference between the electrodes A and B produced by the introduction of the salt vapour in ab is less than the difference of potential between ab previous to the introduction of the salt, as this is a very small fraction of the difference of potential between A and B the introduction of the salt produces little effect on the potential difference required to maintain a given current.

The case is however quite different when the slab ab extends up to the electrode B . In this case X the electric force in the region aB is given by the equation

$$X^2 = \frac{\alpha' i^2}{Q K_2^2 e^2} \left(1 + \frac{K_2}{K_1} \epsilon^{\frac{8\pi e^2 K_2 Q x}{\alpha' i}} \right).$$

Thus the fall of potential at the cathode is now

$$\frac{i}{e (K_1 K_2)^{\frac{1}{2}}} \left(\frac{\alpha'}{Q} \right)^{\frac{1}{2}} \frac{\alpha' i}{4\pi e^2 K_2 Q},$$

whereas before the introduction of the salt it was

$$\frac{i}{e (k_1 k_2)^{\frac{1}{2}}} \left(\frac{\alpha'}{q} \right)^{\frac{1}{2}} \frac{\alpha' i}{4\pi e^2 k_2 q}.$$

Thus if Q , the rate of ionisation in the salt vapour, is large, compared with q , the ionisation in the flame in the absence of the salt, the fall of potential at the cathode will, for the same current, be very much smaller in the salted than in the pure flame; and as the cathode fall of potential is by far the greater part of the potential difference between the electrodes, it will require far less potential difference to produce a given current in a salted than in pure flame, or with the same potential difference the current will be greatly increased by the salt.

If the ionisation in the layer next the electrode were smaller than in the other parts of the discharge, *i.e.* if Q were less than q , the layer would greatly increase the potential fall at the cathode, and with a constant difference of potential between the terminals would greatly diminish the current.

Case when the ionisation is confined to a thin layer.

50. In the preceding investigation we have supposed that the ionisation is uniformly distributed between the plates, there are however many very important cases when ionisation only takes place in a thin layer of the gas, the rest of the space between the plates being free from the action of the ionising agent. We proceed now to the consideration of this case, beginning with the

one where the ionised layer is close to one of the plates *A*. Let us suppose that *A* is the positive plate, then all the ions in the space between the plates must have been dragged by the action of the electric field from the layer, hence these ions must be all positive, so that the current is carried entirely by positive ions. Let there be n_1 of these ions per cubic centimetre and let *X* be the electric force, *i* the current, then using the same notation as before our equations are now

$$\frac{dX}{dx} = 4\pi n_1 e,$$

$$k_1 n_1 X e = i;$$

from these equations we get

$$\frac{XdX}{dx} = \frac{4\pi i}{k_1},$$

or

$$X^2 = \frac{8\pi i x}{k_1} + C \dots \dots \dots (18),$$

where *C* is the constant of integration; it is evidently the value of X^2 close to the positive plate.

If *V* is the potential difference between the plates, and *l* their distance apart, we have

$$V = \int_0^l X dx = \frac{k_1}{12\pi i} \left[\left(\frac{8\pi i l}{k_1} + C \right)^{\frac{3}{2}} - C^{\frac{3}{2}} \right] \dots \dots \dots (19).$$

To find an expression for *C* we must turn our attention to the layer of ionised gas; let us suppose that the current is small compared with that required to saturate this layer, then the number of free positive or negative ions in unit volume of the layer = $(q/\alpha)^{\frac{1}{2}}$, if *q* as before measures the intensity of ionisation; if there is no great change in the electric force as we pass from the gas into the layer the sum of the velocities of the positive and negative ions will be of the order $(k_1 + k_2) C^{\frac{1}{2}}$, and as *i* the current equals the number of ions multiplied by the sum of the velocities of the ions, $e(k_1 + k_2) C^{\frac{1}{2}} (q/\alpha)^{\frac{1}{2}}$ will be of the same order as *i*; hence *C* is comparable with

$$\frac{i^2 \alpha}{q e^2 (k_1 + k_2)^2}.$$

Hence *C* will be small compared with $8\pi i l / k_1$ if

$$\frac{i \alpha k_1}{8\pi q e^2 (k_1 + k_2)^2 l}$$

is a small quantity.

If δ is the thickness of the ionised layer, I the saturation current,

$$I = qe\delta;$$

thus the preceding quantity will be small if

$$\frac{1}{2} \frac{i \delta}{l} \frac{k_2}{(k_1 + k_2)} \frac{1}{\beta_2} \text{ is small,}$$

where

$$\beta_2 = \frac{4\pi e k_2}{\alpha k_1} (k_1 + k_2).$$

If δ/l , i/I are small, then since β_2 is greater and $k_2/(k_1 + k_2)$ less than unity, we see that the quantity under consideration will be small. When this is the case we can, in equation (19), neglect C in comparison with $\frac{8\pi il}{k_1}$, and the equation becomes

$$V^2 = \frac{32\pi}{9k_1} i l^2 \dots\dots\dots(20).$$

We see that the current is proportional to V^2 , and thus increases more rapidly with increasing potential difference than if the conduction followed Ohm's law. We shall see examples of this when we consider the passage of electricity from hot metals immersed in gases. In this case by far the greater part of the ionisation occurs in the layer next the metal and, as Pringsheim* has shown, the current increases more rapidly than the potential difference. The current is proportional to k_1 , the velocity of the ion which carries it; thus since the velocity of the negative ion is greater than that of the positive, the current for the same difference of potential between the plates is greater when the ionisation takes place next the negative plate than when next the positive, in other words the current is greater in one direction than in the opposite; this unipolar conductivity as it is called is very marked indeed in conduction through hot gases and flames containing salts. Rutherford† has observed it when the ionisation was due to Röntgen or radium radiation. We see from (20) that for a given potential difference the current is independent of q , the intensity of ionisation; the maximum current between the plates will of course depend upon the intensity of the ionisation, but as long as the currents are only a small fraction of the maximum corresponding to the ionisation, they will be independent of the amount of ionisation next the

* Pringsheim, *Wied. Ann.* 55, p. 507, 1895.

† Rutherford, *Phil. Mag.* vi. 2, p. 210, 1901.

plate; we see too that the current does not depend on the charge carried by the ion.

The current for a given difference of potential varies inversely as the cube of the distance between the plates; as the current varies as the square of the potential difference, if the average electric intensity between the plates remains constant as the distance diminishes, the current will vary inversely as the distance between the plates.

When the ionisation is confined to a layer next the plate *A*, we can stop the flow of ions and therefore of electricity to the plate *B* by interposing between *A* and *B* a third plate, and the passage of electricity will be stopped just as well by a plate of metal as by a non-conductor; thus we get the somewhat paradoxical effect of completely stopping a current between two plates by interposing between them an excellent conductor of electricity. An example of this effect will be considered when we discuss the passage of electricity through very hot gases.

If the layer of ionised gas is situated between the plates at a distance l_1 from the positive and l_2 from the negative plate, then if V is the potential difference between the plates, we can easily prove by the preceding method that

$$V = \frac{2}{3} \sqrt{8\pi i} \left\{ \frac{l_1^{\frac{3}{2}}}{k_2^{\frac{1}{2}}} + \frac{l_2^{\frac{3}{2}}}{k_1^{\frac{1}{2}}} \right\},$$

where k_1 and k_2 are respectively the velocities of the positive and negative ions. We see that if k_1 is not equal to k_2 the current for the same potential difference will not, unless $l_1 = l_2$, be the same in one direction as in the opposite. If the velocity of the negative ion is greater than that of the positive, the current will be greatest when its direction is such that the negative plate is nearer to the ionised layer than the positive. From this we conclude that want of symmetry in the distribution of ionisation will give rise to unipolar conductivity. The distribution of electric intensity when the ionised layer is between the plates is represented in Fig. 25.

The preceding results are only true when the electric intensity close to the ionised layer is small compared with its value some distance away. We shall now consider from another point of view the condition for this to be the case. If the saturation current, I , passed between the plates the maximum electric force would be

greater than $\sqrt{8\pi Il/k_1}$, and the potential difference greater than $l^{\frac{3}{2}}\sqrt{32\pi I/9k_1}$: unless then the potential difference exceeds this value we cannot have saturation and therefore the force near the

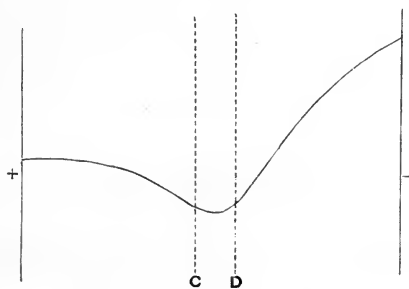

Fig. 25.

plate cannot be great enough to drag all the ions produced near the plate away into the field. In order to get these ions away we have not only to contend against the recombination of the ions, but also against the tendency of the ions to diffuse back into the plate; indeed in many important cases when only ions of one sign come into the gas, as for example when a metal plate emits negative ions by exposure to ultra-violet light, or when a red-hot plate emits positive or negative ions, diffusion is the only thing the field has to overcome in order to saturate the current. In such cases the ions unless removed by the field accumulate round the plate, until the number striking against the plate in unit time is equal to the number emitted by the plate in that time. These ions, like the molecules of any gas, have an average velocity of translation U proportional to their absolute temperature, and the electric field will not be strong enough to remove these ions from the plate unless it is able to impart a velocity U_0 to them. If the field required to do this is small compared with $\sqrt{8\pi Il/k_1}$ then we are justified in putting C in equation 18, page 100, equal to zero. If however the force required to produce the velocity is comparable with $\sqrt{8\pi Il/k_1}$ we cannot assume that C is zero and the force near the plate, as is generally the case when the currents are produced by ultra-violet light, may be comparable with that in other parts of the field. The greater the value of I the more likely are the conditions justifying the zero value of C to be satisfied.

CHAPTER IV.

EFFECT PRODUCED BY A MAGNETIC FIELD ON THE MOTION OF THE IONS.

51. WHEN a charged ion is moving in a magnetic field it experiences a mechanical force whose direction is at right angles to the direction of motion of the ion, at right angles also to the magnetic force and equal in magnitude to $HeV \sin \theta$, where H is the magnetic force, V the velocity of the ion, e its charge, and θ the angle between H and V ; H and e are to be expressed in the electromagnetic system of units. The relation between the direction of this force F , V and H , for a positively charged ion, is shown in Fig. 26.

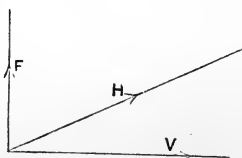

Fig. 26.

Now suppose that we have an ion moving through a gas, the viscosity of the gas causing the velocity of the ion to be proportional to the force acting upon it. Then if X, Y, Z are the components of the electric intensity, α, β, γ those of the magnetic force, u, v, w those of the velocity, the mechanical force exerted on the ion by the magnetic field has for components

$$e(\beta w - \gamma v), \quad e(\gamma u - \alpha w), \quad e(\alpha v - \beta u),$$

while the components of the mechanical force due to the electric

field are Xe, Ye, Ze . Thus as the velocity of the ion is proportional to the mechanical force acting upon it we have

$$\left. \begin{aligned} u &= R(X + \beta w - \gamma v) \\ v &= R(Y + \gamma u - \alpha w) \\ w &= R(Z + \alpha v - \beta u) \end{aligned} \right\} \dots\dots\dots(1),$$

R is evidently the velocity of the ion under unit electric intensity when there is no magnetic field. Solving equations (1) we find

$$\left. \begin{aligned} u &= \frac{RX + R^2(\beta Z - \gamma Y) + R^3\alpha(\alpha X + \beta Y + \gamma Z)}{1 + R^2(\alpha^2 + \beta^2 + \gamma^2)} \\ v &= \frac{RY + R^2(\gamma X - \alpha Z) + R^3\beta(\alpha X + \beta Y + \gamma Z)}{1 + R^2(\alpha^2 + \beta^2 + \gamma^2)} \\ w &= \frac{RZ + R^2(\alpha Y - \beta X) + R^3\gamma(\alpha X + \beta Y + \gamma Z)}{1 + R^2(\alpha^2 + \beta^2 + \gamma^2)} \end{aligned} \right\} \dots (2).$$

The first term in the numerator of these expressions represents a velocity parallel and proportional to the electric force; the second term a velocity at right angles both to the electric and magnetic forces and proportional to $R^2HF \sin \phi$; where H, F , and ϕ represent respectively the magnetic and electric forces and the angle between them; the third term represents a velocity parallel to the magnetic force and proportional to $R^3H^2F \cos \phi$. The relative importance of these terms depends upon the value of RH , if this quantity is small the first term is the most important and the ion moves parallel to the electric force, if on the other hand RH is large the last term is the most important and the ion moves parallel to the magnetic force. Since R is the velocity of the ion under unit electric force, and the unit force on the electro-magnetic system is 10^{-8} of a volt per cm., the value of R for an ion moving through air at atmospheric pressure would be 1.5×10^{-8} , since the velocity of the ion under a volt per cm. is about 1.5 cm./sec. Thus at atmospheric pressure it would not be feasible to get a magnetic field strong enough to make RH large. As R varies inversely as the pressure of a gas through a considerable range of pressures it might at very low pressures be possible to make RH large and thus make the ions travel along the lines of magnetic force.

Let us take the case of an ion placed in a field in which both the electric and magnetic forces are uniform; let the electric force

be parallel to the axis of x and let the magnetic force be in the plane of xz , then $Y = 0$, $Z = 0$, $\beta = 0$, and equations (2) become

$$u = \frac{RX(1 + R^2\alpha^2)}{1 + R^2(\alpha^2 + \gamma^2)} = RX \text{ approximately, if } R^2(\alpha^2 + \gamma^2) \text{ is small,}$$

$$v = \frac{R^2\gamma X}{1 + R^2(\alpha^2 + \gamma^2)} = R^2\gamma X,$$

$$w = \frac{R^2\alpha\gamma X}{1 + R^2(\alpha^2 + \gamma^2)} = R^2\alpha\gamma X.$$

Thus the effect of the magnetic force is to give the ion a velocity $R\gamma u$ at right angles to both the electric and magnetic forces and a velocity $R^2\gamma(\alpha^2 + \gamma^2)^{\frac{1}{2}}u$ in the plane of xz at right angles to the magnetic force.

If both positive and negative ions are present and if R_1 is the value of R for the positive and R_2 that for the negative ion, and if $u_1, v_1, w_1; u_2, v_2, w_2$ are respectively the velocities of the positive and negative ions, then if there are n positive and negative ions per unit volume the current parallel to y will be equal to $ne(v_1 - v_2)$ or, substituting the values of v_1 and v_2 , to

$$ne(R_1^2 - R_2^2)\gamma X = (R_1 - R_2)\gamma I,$$

if I is the main current parallel to x ; thus if the velocities of the positive and negative currents are unequal the magnetic field will give rise to a side current proportional to the main one and the direction of the current will be deflected through an angle whose tangent is $(R_1 - R_2)\gamma$. If we retain terms proportional to $(RH)^2$, where H is the magnetic force, we see that there will be an additional current proportional to $(R_1^2 + R_2^2 - R_1R_2)\gamma(\alpha^2 + \gamma^2)^{\frac{1}{2}}I$ in the plane of xz at right angles to the magnetic force.

When the electric field is not uniform but, like that due to a charged particle, radiates from a point, we can prove without difficulty that an ion in a uniform magnetic field will describe a spiral traced on a cone of revolution, the axis of the cone being parallel to the magnetic force.

Motion of a free ion in a magnetic field.

52. If the ion instead of having to move through the molecules of a gas is moving in a vacuum, the path it describes in a uniform magnetic field is readily found. We shall first of all take the case when no electric forces act upon the ion, then, since the only force

acting on the ion is that due to the magnetic field and this force is always at right angles to the path of the ion, the velocity of the ion will be constant; again, since the force is at right angles to the magnetic force, there will be no acceleration parallel to this force, thus when the magnetic field is uniform the component of the velocity parallel to the magnetic force is constant. As the resultant velocity is constant this implies that the direction of motion of the ion makes a constant angle with the magnetic force. If ρ is the radius of curvature of the path of the ion, m its mass, v its velocity, the force along the normal is equal to $\frac{mv^2}{\rho}$, but this force is equal to $Hev \sin \theta$, where H is the magnetic force and θ the angle between v and H , e the charge on the ion, thus

$$\frac{mv^2}{\rho} = Hev \sin \theta,$$

or

$$\rho = \frac{mv}{eH \sin \theta}.$$

Thus as v and θ are constant the radius of curvature of the path is constant, the path of the particle is therefore a helix wound on a circular cylinder whose axis is parallel to the lines of magnetic force, the radius of the cylinder is $\rho \sin^2 \theta$ or $mv \sin \theta / eH^*$. If the particle is projected at right angles to the lines of magnetic force, the helix shrinks into a circle whose radius is mv/eH : as the path in this case is a closed one the ion never travels more than a finite distance from its point of projection. If the velocity of the ion has a component parallel to the magnetic force, this component remains constant and the ion goes on describing equal spaces parallel to the magnetic force in equal times, while in a direction at right angles to the magnetic force the velocity of the ion is sometimes in one direction and sometimes in the opposite, so that the ion, however long it moves, never travels more than a finite distance from the line of force. We may thus express the general features of the effect by saying that in the magnetic field the ions tend to follow the lines of magnetic force.

53. The preceding investigation relates to the case when the magnetic field is constant and the lines of magnetic force do not change their direction; it is of interest to see whether the ions will

* G. G. Stokes, *Proc. Roy. Soc.* Mar. 30, 1876; *Phil. Mag.* v. 2, p. 359, 1876.

continue to follow the lines of magnetic force when these change their direction from point to point. We shall take the special case when the lines of magnetic force are circles round the axis of z , the field being that due to a current i flowing along this axis; in this case if α, β, γ are the components of magnetic force at a point whose coordinates are x, y, z ,

$$\alpha = \frac{2iy}{x^2 + y^2}, \quad \beta = -\frac{2ix}{x^2 + y^2}, \quad \gamma = 0,$$

and if m is the mass of the ion, e its electric charge, we have

$$\begin{aligned} m \frac{d^2x}{dt^2} &= -e \frac{2ix}{x^2 + y^2} \frac{dz}{dt}, \\ m \frac{d^2y}{dt^2} &= -e \frac{2iy}{x^2 + y^2} \frac{dz}{dt}, \\ m \frac{d^2z}{dt^2} &= \frac{2ei}{x^2 + y^2} \left(x \frac{dx}{dt} + y \frac{dy}{dt} \right) = ei \frac{d}{dt} \log(x^2 + y^2). \end{aligned}$$

From these equations we have

$$\left(\frac{dx}{dt} \right)^2 + \left(\frac{dy}{dt} \right)^2 + \left(\frac{dz}{dt} \right)^2 = \text{a constant} = V^2,$$

where V is the velocity of projection of the ion;

$$y \frac{d^2x}{dt^2} - x \frac{d^2y}{dt^2} = 0.$$

Thus if ρ and θ are the polar coordinates of the ion in the plane xy ,

$$\rho^2 \frac{d\theta}{dt} = h,$$

where h is a constant;

$$\frac{dz}{dt} = \frac{2ei}{m} \log \rho + C,$$

where C is a constant: thus the orbit of the ion in the plane of xy is that of a particle of mass m acted on by a central attractive force equal to $\left(\frac{4e^2i^2}{m} \log \rho + 2eiC \right) / \rho$.

Since

$$\left(\frac{d\rho}{dt} \right)^2 + \rho^2 \left(\frac{d\theta}{dt} \right)^2 + \left(\frac{dz}{dt} \right)^2 = V^2,$$

we have

$$\left(\frac{d\rho}{dt} \right)^2 = V^2 - \frac{h^2}{\rho^2} - \left(\frac{2ei}{m} \log \rho + C \right)^2.$$

Since $\left(\frac{d\rho}{dt}\right)^2$ is essentially positive, ρ will always lie between the greatest and least roots of the equation

$$\frac{2ei}{m} \log R = \left\{ V^2 - \frac{h^2}{R^2} \right\}^{\frac{1}{2}} - C,$$

so that the ion will always remain at a finite distance from the axis of z .

54. Let us consider some special cases. Let the ion be projected from the point $\rho = a$ parallel to the lines of magnetic force: then since $dz/dt = 0$ when $\rho = a$, we have

$$\frac{dz}{dt} = \frac{2ei}{m} \log \frac{\rho}{a},$$

and

$$h = Va,$$

hence

$$\left(\frac{d\rho}{dt}\right)^2 = V^2 \left(1 - \frac{a^2}{\rho^2}\right) - \left(\frac{2ei}{m} \log \frac{\rho}{a}\right)^2;$$

from this equation we see that ρ can never be less than a , and thus the velocity parallel to the axis of z never changes sign: again ρ never exceeds the value R , given by the equation

$$\frac{2ei}{m} \log \frac{R}{a} = V \left(1 - \frac{a^2}{R^2}\right)^{\frac{1}{2}} \dots\dots\dots(1).$$

$R = a$ satisfies this equation, but there is another root greater than a ; it is this root which is the maximum value of ρ .

Thus in the plane at right angles to the axis of z the ion circulates in an orbit included between the circles $\rho = a$ and $\rho = R$; and thus again the ion moves in the general direction of the lines of magnetic force, although in this case there is a drift of the ions parallel to the axis of symmetry of the magnetic field. If V is small compared with $2ei/m$, the solution of the equation (1) is

$$R = a (1 + \xi),$$

where

$$\xi = \frac{V^2}{2e^2i^2/m^2}.$$

In this case the maximum velocity parallel to z is $V.(V/eim)$ and is thus small compared with V . Thus the smaller the velocity of projection and the stronger the field the more nearly does the path of the ion coincide with a line of magnetic force.

In the next case the ion is projected from $\rho = a$ in a direction parallel to z , in this case $h = 0$ and the path of the ion is in the plane through the axis of z and the point of projection; if V is the velocity of projection, then

$$\frac{dz}{dt} = \frac{2ei}{m} \log \frac{\rho}{a} + V;$$

now dz/dt can never be greater numerically than V , hence if V and $2ei/m$ are of the same sign ρ can never be greater than a .

The values between which ρ oscillates are a and $a\epsilon^{-\frac{V}{ei/m}}$; the orbit is a closed one and its dimensions are very small if V is small compared with ei/m . If V and ei/m are of opposite signs then we can show that ρ is never less than a and varies between a and $a\epsilon^{\frac{V}{ei/m}}$.

A third case we shall consider is when the particle is projected with velocity V parallel to ρ from $\rho = a$, in this case again $h = 0$, but

$$\frac{dz}{dt} = \frac{2ei}{m} \log \frac{\rho}{a}.$$

Since dz/dt can never be greater numerically than V , we see that ρ must lie between the limits $\rho = a\epsilon^{\frac{mV}{2ei}}$ and $\rho = a\epsilon^{-\frac{mV}{2ei}}$; the orbit is in the plane through the axis of z and the point of projection. If the magnetic field is very strong and therefore $mV/2ei$ small, ρ is always very nearly equal to a ; let it equal $a(1 + \xi)$, our equations are then approximately

$$\frac{d^2\xi}{dt^2} = -\left(\frac{2ei}{m}\right)^2 \frac{\xi}{a^2},$$

$$\frac{dz}{dt} = \frac{2ei}{m} \xi;$$

the solution of these is

$$\xi = A \sin\left(\frac{2i}{a} \frac{e}{m} t\right),$$

$$z = -aA \cos \frac{2i}{a} \frac{e}{m} t.$$

Since $V = a \frac{d\xi}{dt}$ when $t = 0$, $aA = V \frac{m}{e} \frac{a}{2i} = \frac{Vm}{He}$, where H is the magnetic force at the point of projection. Thus, as we might

have expected, the path in this case is a circle whose radius aA is equal to $(V/H)(m/e)$.

We see from the consideration of the variable field as well as from that of the constant one that the ion will tend to follow the lines of magnetic force, except in the very special case when the circumstances of projection are such that the ion during its motion always cuts the lines of magnetic force at right angles.

Motion of an ion under the joint action of electric and magnetic forces.

55. We shall now investigate the motion of an ion when it is acted on simultaneously by both electric and magnetic forces; we shall take the case when both these forces are constant. Let the axis of z be parallel to the direction of the magnetic force, and the plane of xz parallel to the direction of the electric force. Let H be the magnetic force, $X, 0, Z$ the components of the electric force, then if m is the mass of an ion, e its charge, and x, y, z its coordinates the equations of motion are

$$m \frac{d^2x}{dt^2} = Xe - He \frac{dy}{dt} \dots\dots\dots(1),$$

$$m \frac{d^2y}{dt^2} = He \frac{dx}{dt} \dots\dots\dots(2),$$

$$m \frac{d^2z}{dt^2} = Ze \dots\dots\dots(3).$$

From equation (3) we have

$$z = \frac{1}{2} \frac{Ze}{m} t^2 + w_0 t \dots\dots\dots(4),$$

where w_0 is the velocity of projection parallel to z , the origin of coordinates being supposed to be taken at the point of projection.

From equations (1) and (2) we have

$$y = c + \frac{X}{H} t + A \cos \omega t + B \sin \omega t \dots\dots\dots(5),$$

$$x = a - A \sin \omega t + B \cos \omega t \dots\dots\dots(6),$$

where a, c, A and B are arbitrary constants and $\omega = He/m$.

Writing equations (5) and (6) in the form

$$y - c = \frac{X}{\omega H} \omega t + A' \cos (\omega t - \alpha),$$

$$x - a = - A' \sin (\omega t - \alpha) ;$$

we see that the projection of the path of the ion on the plane of xy is a trochoid, generated by a circle whose radius is $X/\omega H$ rolling on a line perpendicular to the electric force, the distance of the tracing point from the centre of the rolling circle being A' . Since the average value of the periodic terms tends to vanish when the time over which the average extends is large compared with $1/\omega$, we see, from equations (5) and (6), that the equations

$$y = c + \frac{X}{H} t,$$

$$x = a,$$

give the average positions of the ion, and that the average velocity parallel to y is X/H while that parallel to x vanishes.

As the velocity parallel to z at the time t is $\frac{Ze}{m} t + w_0$ we see that if Z is finite the velocity parallel to z will ultimately become infinite compared with the components parallel to the other axes, thus in this case the ions will ultimately move along the lines of magnetic force; we must remember however that this reasoning only applies when the electric field has a finite component in this direction.

If we determine the constants in (5) and (6) in terms of v_0, u_0 , the initial values of the components of the velocity of projection of the ion parallel to the axes of y and x respectively, we have, the origin being taken at the point of projection,

$$y = \frac{u_0}{\omega} (1 - \cos \omega t) + \frac{X}{H} t + \left(v_0 - \frac{X}{H} \right) \frac{1}{\omega} \sin \omega t \quad \dots\dots(7),$$

$$x = \left(\frac{X}{H} - v_0 \right) \frac{1}{\omega} (1 - \cos \omega t) + \frac{u_0}{\omega} \sin \omega t \quad \dots\dots\dots(8).$$

If $X = 0$, *i.e.* if the directions of the electric and magnetic forces coincide, we have

$$\left(x + \frac{v_0}{\omega} \right)^2 + \left(y - \frac{u_0}{\omega} \right)^2 = \frac{v_0^2 + u_0^2}{\omega^2},$$

thus the projection of the path of the ion on the plane of xy is a circle and the path of the ion is a helix of gradually increasing pitch with its axis parallel to the lines of magnetic force.

If $Z=0$, *i.e.* if the electric force is at right angles to the magnetic, and if in addition u_0, v_0, w_0 all vanish, we have

$$y = \frac{X}{\omega H}(\omega t - \sin \omega t),$$

$$x = \frac{X}{\omega H}(1 - \cos \omega t).$$

This is the equation to a cycloid, the radius of the generating circle being $X/\omega H$ or Xm/eH^2 , the line on which it rolls is perpendicular to the electric force. The greatest distance measured in the direction of the electric force which the particle can get from its point of projection is $2Xm/eH^2$; the average velocity in this direction is zero while the average velocity parallel to y , *i.e.* in the direction at right angles both to the electric and magnetic forces, is finite and equal to X/H . If the ion were projected with the velocity w parallel to the axis of z it would retain this velocity unaltered and the average direction of motion of the ion would be at right angles to the electric force and along a line making an angle $\tan^{-1} X/wH$ with the direction of the magnetic force.

56. If $u_0 = 0$ and $v_0 = X/H$ we have by equations (7) and (8)

$$y = v_0 t,$$

$$x = 0.$$

Thus in this case the path of the ion in the plane of xy is the same as if there were neither electric nor magnetic forces acting upon it: the force Xe acting on the particle due to the electric field is in this case just balanced by the force Hev_0 due to the magnetic field.

57. Returning to the general case represented by equations (7) and (8) we easily deduce that the maximum velocity V parallel to the plane of xy attained by the ion is given by the equation

$$V = \frac{X}{H} + \left\{ u_0^2 + \left(\frac{X}{H} - v_0 \right)^2 \right\}^{\frac{1}{2}},$$

thus until u_0 and v_0 are comparable with X/H , the maximum velocity attained is very approximately $2X/H$ and is independent of the velocity of projection, and the charge and the mass of the ion.

The maximum displacement ξ measured parallel to the direction of the electric force is given by the equation

$$\xi = \left\{ \frac{X}{H} - v_0 \right\} \frac{1}{\omega} + \frac{1}{\omega} \left\{ u_0^2 + \left(\frac{X}{H} - v_0 \right)^2 \right\}^{\frac{1}{2}},$$

and thus until u_0 and v_0 become comparable with X/H , the distance travelled by the ion parallel to the lines of electric force will be very approximately independent of the velocity of projection of the ion.

If ξ , ξ_1 , ξ_2 are the maximum displacements corresponding to the electric forces X , X_1 , X_2 , the magnetic force being the same throughout, we find from the preceding equation that

$$\begin{aligned} \omega &= \frac{2}{H(\xi - \xi_1)(\xi_1 - \xi_2)(\xi_2 - \xi)} (X\xi(\xi_2 - \xi_1) \\ &\quad + X_1\xi_1(\xi - \xi_2) + X_2\xi_2(\xi_1 - \xi)), \\ u_0^2 &= \frac{-2\omega}{H(\xi - \xi_1)(\xi_1 - \xi_2)(\xi_2 - \xi)} (X(\xi_2 - \xi_1) + X_1(\xi - \xi_2) + X_2(\xi_1 - \xi)), \\ v_0 &= \frac{1}{H(\xi - \xi_1)(\xi_1 - \xi_2)(\xi_2 - \xi)} (X\xi(\xi_2^2 - \xi_1^2) \\ &\quad + X_1\xi_1(\xi^2 - \xi_2^2) + X_2\xi_2(\xi_1^2 - \xi^2)). \end{aligned}$$

These equations supply a method for finding e/m and the velocity of projection of the ion.

If the charged particles are projected from the plane $x = 0$ in all directions with a constant velocity v the distances they will travel from this plane will vary between

$$\frac{2}{\omega} \left(\frac{X}{H} - v \right) \quad \text{and} \quad \frac{2}{\omega} \left(\frac{X}{H} + v \right).$$

The smaller value is the distance reached by those particles which are projected parallel to the plane in the direction for which the force on the moving particle due to the magnetic field tends towards the plane, the larger value is the distance travelled by particles projected parallel to the plane in the opposite direction.

If there is a second plane at a distance d from the plane of projection, then with a constant magnetic field all the particles will reach the second plane when the electric force X_1 is equal to or greater than the value given by the equation

$$d = \frac{2}{\omega} \left(\frac{X_1}{H} - v \right),$$

while none of them will reach the plane if the electric force X_2 is equal to or less than the value given by the equation

$$d = \frac{2}{\omega} \left(\frac{X_2}{H} + v \right);$$

from these equations we get

$$v = \frac{1}{2} \frac{(X_1 - X_2)}{H}, \quad \frac{e}{m} = \frac{(X_1 + X_2)}{H^2 d}.$$

With a constant electric force, all the particles will be prevented reaching the second plane if the magnetic force H_1 is equal to or greater than the value given by the equation

$$d = \frac{2m}{eH_1} \left(\frac{X}{H_1} + v \right),$$

while none of them will be stopped by a magnetic force H_2 equal to or less than the value given by the equation

$$d = \frac{2m}{eH_2} \left(\frac{X}{H_2} - v \right);$$

from these equations we get

$$v = \frac{X(H_1 - H_2)}{H_1 H_2}; \quad \frac{e}{m} = \frac{2X}{H_1 H_2 d}.$$

These results may be applied to find v and e/m .

58. The case when the electric and magnetic forces are at right angles to each other is a very important one as it includes the fields produced by electric waves. In these waves the electric and magnetic forces are not constant but in the case of a simple harmonic wave may be taken as proportional to $\cos pt$. When the waves are all divergent the electric force is equal to V times the magnetic force, where V is the velocity with which the electric waves travel through the medium. Thus if the direction of propagation of the wave is parallel to the axis of y and if the magnetic force is parallel to the axis of z and equal to $H_0 \cos \theta$, the electric force will be parallel to the axis of x and equal to $VH_0 \cos \theta$ where $\theta = p \left(t - \frac{y}{V} \right)$. The equations of motion of a charged particle acted on by this electric wave are

$$m \frac{d^2 x}{dt^2} = e \left(V - \frac{dy}{dt} \right) H_0 \cos \theta,$$

$$m \frac{d^2 y}{dt^2} = e \frac{dx}{dt} H_0 \cos \theta.$$

From these equations we have, if dx/dt and θ vanish simultaneously,

$$\frac{dx}{dt} = \frac{e}{m} \frac{V}{p} H_0 \sin \theta,$$

$$\frac{d^2 2\theta}{dt^2} + \frac{H_0^2 e^2}{m^2} \sin 2\theta = 0.$$

From the analogy of the second of these equations with that representing the motion of a simple pendulum we see that the character of the motion of the ions will depend upon the value of $H_0 e/pm$; if this quantity is large the average velocity of the ions parallel to x will vanish while that parallel to y will be equal to V : thus the wave will in this case carry the charged particles along with it. When however $H_0 e/pm$ is a small quantity the effect of the wave will be to superpose on the undisturbed motion a small vibratory motion parallel to the electric force in the wave and thus at right angles to its direction of propagation.

CHAPTER V.

DETERMINATION OF THE RATIO OF THE CHARGE TO THE MASS OF AN ION.

59. THE value of e/m —the charge on an ion divided by its mass—has been determined by the application of some of the results discussed in the preceding chapter. The first case we shall consider is that of the ion in cathode rays.

Cathode rays are the streams which start from the cathode in a highly exhausted tube through which an electric discharge is passing; they produce a vivid phosphorescence when they strike against the glass of the tube. In the chapter on cathode rays we shall give the evidence which leads us to the conclusion that they consist of negatively electrified particles starting from the neighbourhood of the cathode and moving with a very high velocity along straight lines. Assuming that this is the nature of the cathode rays we shall show here how to determine the velocity of the particles and the value of e/m . Suppose that we have a highly exhausted tube of the pattern shown in Fig. 27.

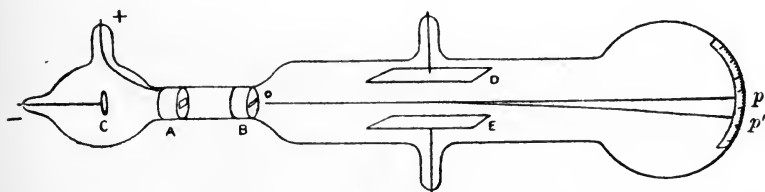

Fig. 27.

In this tube C is the cathode, A the anode, B is a thick metal disc connected with the earth, slits a millimetre or so in diameter are bored through the middle of the disc and through the anode; some of the cathode rays starting from the neighbourhood of the

cathode pass through these holes, thus in the part of the tube to the right of the disc we have a pencil of negatively electrified particles travelling along straight lines parallel to the line joining the holes in the discs, the place where these particles strike the glass is marked by a patch of bright phosphorescence p . Suppose now that the tube is placed in a uniform magnetic field, the lines of force being at right angles to the path of the ions, the paths of the ions will now be circles, the radii of the circles being (see p. 108) mv/eH , where m is the mass of the ion, e its charge, v its velocity, and H the strength of the magnetic field. The place at which these particles strike the tube will no longer be at p but at some other point p' , the direction of pp' being at right angles to the magnetic force. Since op' is an arc of a circle of which op is a tangent, we have

$$pp'(2R + pp') = op^2,$$

where R is the radius of the circle; hence

$$2R = \frac{op^2}{pp'} - pp',$$

or, since $R = mv/eH$, we have

$$2 \frac{mv}{eH} = \frac{op^2}{pp'} - pp'.$$

If the magnetic field is not uniform we may proceed as follows. Since ρ the radius of curvature at any point of the path of the ion is given by the equation

$$\frac{1}{\rho} = \frac{He}{vm},$$

and since, when the path of the ion is fairly flat, $1/\rho$ is very approximately equal to d^2y/dx^2 , where y and x are the coordinates of the ion, x being measured along the undisturbed path, and y at right angles to it, we have

$$\frac{d^2y}{dx^2} = \frac{He}{vm},$$

so that

$$pp' = \frac{e}{vm} \int_0^{op} [\int_0^x H dx] dx \dots\dots\dots(1).$$

Hence if we measure pp' and know the distribution of the magnetic force H along the tube we can from this equation

determine the value of e/vm . This gives us a relation between v and m/e . We can determine v in the following way: two parallel metal plates D and E are placed in the tube, the plates being parallel to the lines of magnetic force and parallel also to the undisturbed path of the rays; these plates are maintained at a known difference of potential by connecting them to the terminals of a battery. Thus we have an electric field between the plates the lines of force of which are at right angles to the lines of magnetic force and to the direction of motion of the ions; this electrostatic force Y tends to deflect the ions, the force acting on an ion being Ye ; the force due to the magnetic field acts in the same straight line and is equal to Hev . Adjust the sign of the difference of potential so that the electric and magnetic forces tend to oppose each other, then keeping one of the forces fixed, say the electric force, alter the value of the other until the two forces just balance, this stage can be ascertained by observing when the phosphorescent patch p' is restored to its undisturbed position. When this stage is reached we have

$$Ye = Hev,$$

or

$$v = \frac{Y}{H} \dots\dots\dots(2).$$

Thus by measuring Y/H we can determine the velocity of the ions composing the cathode rays. As we know e/vm from the experiments on the magnetic deflection we can deduce the values of both e/m and v . Equation (2) depends upon the assumption that both the magnetic and electric fields are uniform, if this condition is not fulfilled we must proceed as follows. Suppose that p'' is the displaced position of p when the electric field alone is acting on the rays, then we can prove without difficulty that

$$pp'' = \frac{e}{v^2m} \int_0^{op} [\int_0^x Y dx] dx \dots\dots\dots(3),$$

hence if we know the distribution of the electric field and the value of pp'' we can by equation (3) find the value of e/v^2m , and since by equation (2) we can determine e/vm we have the data for determining both v and e/m .

In order to apply this method it is necessary that the pressure of gas in the discharge tube in which the rays are produced should be very low; the passage of cathode rays through a gas

makes it a conductor and thus as the rays are shielded from the electrostatic field by the gas through which they move the electrostatic repulsion is hardly appreciable; if, however, the pressure of the gas is very low the conductivity of the gas is so small that there is hardly any appreciable shielding effect and the deflection produced by the electric field is easily observed.

If the pressure of the gas through which the charged particles pass is not exceedingly low the velocity of the particles will be reduced by collision with the molecules of the gas; to investigate this effect let us suppose that the velocity of the particle after traversing a distance x is equal to $v_0 e^{-kx}$. The equation giving y , the magnetic deflection of the particle, will be

$$\frac{d^2y}{dx^2} = \frac{He}{mv_0} \epsilon^{kx}.$$

If the magnetic field is uniform we have

$$\frac{dy}{dx} = \frac{He}{mv_0 k} (\epsilon^{kx} - 1)$$

and

$$y = \frac{He}{mv_0 k} \left(\frac{\epsilon^{kx} - 1}{k} - x \right).$$

If the particle travels through the uniform field for a distance l and then through a distance d under no magnetic force, before reaching the screen, the deflection at the screen will be

$$y_{(x=l)} + d \left(\frac{dy}{dx} \right)_{x=l} \\ = \frac{He}{mv_0 k} \left(\frac{\epsilon^{kl} - 1}{k} - l \right) + \frac{dHe}{mv_0 k} (\epsilon^{kl} - 1),$$

or if kl be small

$$= \frac{He}{mv_0} l \left\{ \frac{l}{2} \left(1 + \frac{kl}{3} \right) + d \left(1 + \frac{kl}{2} \right) \right\}.$$

If z be the deflection due to the electrostatic force X we have

$$\frac{d^2z}{dt^2} = \frac{Xe}{m};$$

thus

$$\frac{dz}{dt} = \frac{Xe}{m} t; \quad z = \frac{1}{2} \frac{Xe}{m} t^2.$$

Again, $\frac{dx}{dt} = v_0 \epsilon^{-kx}$, so that $t = \frac{1}{kv_0} (\epsilon^{kx} - 1)$.

Hence if as before the particle travels through a distance l under a constant electric force X and then for a distance d under no force, z , the deflection on reaching the screen, will be given by the equation

$$z = \frac{Xe}{mv_0^2} \frac{l^2}{2} (1 + kl) + \frac{Xe}{mv_0^2} dl \left(1 + \frac{3kl}{2}\right),$$

hence we have

$$\frac{y^2}{z} = \frac{H^2e}{mX} l \left(\frac{l}{2} + d\right) \left(1 - kl \frac{\left(\frac{l}{2} + d\right)}{\frac{l}{2} + d}\right).$$

Thus the effect of the retardation of the rays by the gas will be to make the value of e/m given by the uncorrected expression

$$\frac{y^2}{z} = \frac{H^2e}{Xm} l \left(\frac{l}{2} + d\right)$$

too small. In a fairly good vacuum the correction is small; thus if the gas in the tube is air at the pressure $\cdot 01$ mm., k for particles moving with a velocity of 3×10^9 cm./sec. is about $\cdot 0085$. On the other hand, the residual gas will tend to make the electrical force in the part of the space between the plates traversed by the rays less than V/D , where V is the potential difference and D the distance between the plates; thus if we put $X = V/D$ in the above equation the value of e/m would, if any residual gas were present, tend to be too large.

Using this method the author in 1897* obtained the values for v and e/m given in the following table: the first column contains the name of the gas filling the tube: the different numbers given under one gas relate to experiments made at different pressures.

Gas	v	m/e	Gas	v	m/e
Air	2.8×10^9	1.3×10^{-7}	Air*	2.8×10^9	1.1×10^{-7}
Air	2.8×10^9	1.1×10^{-7}	Hydrogen	2.5×10^9	1.5×10^{-7}
Air	2.3×10^9	1.2×10^{-7}	Carbonic	2.2×10^9	1.5×10^{-7}
Air*	3.6×10^9	1.3×10^{-7}	acid... }		

The mean of the values of m/e is 1.3×10^{-7} or $e/m = 7.7 \times 10^6$. We see too that within the limits of the errors of the experiments the value of e/m is the same whether the tube be filled with air, hydrogen or carbonic acid, so that it does not depend upon the

* J. J. Thomson, *Phil. Mag.* v. 44, p. 293, 1897.

nature of the gas. This result was first obtained by the writer* by another method; the pressure in the discharge tube was adjusted so that the potential difference between the electrodes in the discharge tube was the same for all the gases tried; photographs were taken of the rays when deflected by a constant magnetic field and from these it was found that the deflected rays occupied the same position whether the gas in the tube was hydrogen, air, carbonic acid or methyl iodide; these gases give a wide range of densities as the density of methyl iodide is about 70 times that of hydrogen. The constancy of the value of e/m for the ions which constitute the cathode rays is in striking contrast with the variability of the corresponding quantity in the ions which carry the current through liquid electrolytes. Experiments were made on the effect of altering the metal of which the cathode was made; the experiments marked with an asterisk in the preceding table were made with platinum electrodes, all the others were made with aluminium electrodes; it will be seen that the values of e/m are the same in the two cases. A further series of experiments on this point has been made by H. A. Wilson†, who used cathodes made of aluminium, copper, iron, lead, platinum, silver, tin and zinc, and found the same value for e/m in all cases.

If we compare the value of e/m , viz. 7.7×10^6 for the ions in the cathode rays, with the value of the corresponding quantity for the ions which carry the current through liquid electrolytes we are led to some very interesting conclusions; the greatest value of e/m in the case of liquid electrolysis is when the ion is the hydrogen ion, in this case e/m is about 10^4 . When we discuss the electric charge carried by the ion in the cathode rays we shall find that it is equal in magnitude to the charge carried by the hydrogen ion, in liquid electrolysis; it follows then that the mass of the hydrogen ion must be 770 times that of the ion in the cathode rays; hence the carrier of the negative electricity in these rays must be very small compared with the mass of the hydrogen atom. We shall return to this point when we have studied other phenomena involving gaseous ions.

60. Kaufmann‡ has introduced a method by which the deflections due to the electric and magnetic force take place

* J. J. Thomson, *Proc. Camb. Phil. Soc.* ix. p. 243, 1897.

† H. A. Wilson, *Proc. Camb. Phil. Soc.* xi. p. 179, 1901.

‡ Kaufmann, *Göttingen Nach.* Nov. 8, 1901.

simultaneously and can be measured with great accuracy. A photographic plate is placed at right angles to the path of the undeflected rays and the electric and magnetic fields are arranged so as to produce deflections in directions at right angles to each other. Suppose the magnetic field produces a vertical, the electric a horizontal deflection. Let O be the point where the undeflected rays strike the plate, then if all the rays have the same velocity the deflected rays will strike the plates at a point O' , the vertical distance between O, O' will be

$$\frac{1}{2} \frac{He}{mv} l \left(\frac{l}{2} + d \right),$$

and the horizontal distance

$$\frac{1}{2} \frac{Xe}{mv^2} l \left(\frac{l}{2} + d \right),$$

hence if we measure these distances on the plates we have the means of determining v and e/m . If the particles have different velocities, then when the rays are deflected we shall have instead of one point O' , a number of points O_1, O_2, O_3 ; by measuring the displacements of these points we can determine the various velocities of the particles and the values of e/m . We shall consider later how Kaufmann applied this method to find the effect of the velocity on the value of e/m for particles whose velocity is comparable with that of light.

Ions in Lenard rays.

61. Lenard* has determined by the method described in Art. 59 the velocity and the value of e/m for the Lenard rays; these rays are cathode rays which have escaped from the discharge tube through a window of very thin aluminium foil. In his experiments the rays after escaping from the discharge tube entered a highly exhausted vessel where they were deflected by electric and magnetic forces in the way described in the preceding article; the results of these experiments are given in the following table.

v cm./sec.	e/m
6.7×10^9	6.49×10^6
7×10^9	6.32×10^6
8.1×10^9	6.36×10^6

* Lenard, *Wied. Ann.* xliv, p. 279, 1898.

The mean of the values of e/m is 6.39×10^6 , which agrees well with the value 7.7×10^6 found above. It will be noticed that the velocities of the ions in this case are much greater than in the preceding, taking the two sets together we have velocities of the ions ranging from 2.2×10^9 to 8.1×10^9 cm./sec. without any indication of a change in the value of e/m .

Lenard* has also made some very interesting experiments on the effect of an external electric field in accelerating or retarding the motion of the ions. The apparatus used for this purpose is shown in Fig. 28.

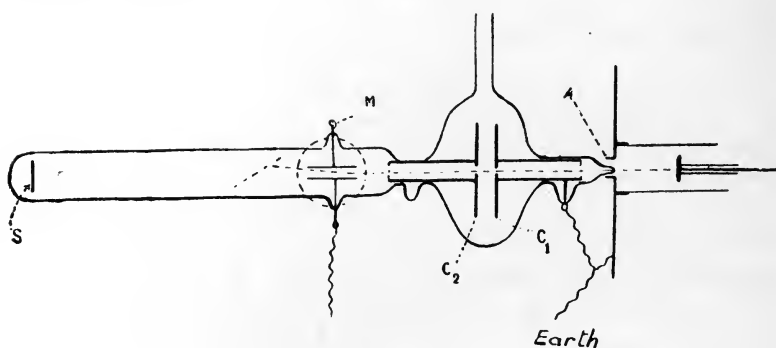

Fig. 28.

The rays after coming through the window A pass through small holes in two parallel circular metallic plates C_1 and C_2 ; of these C_1 is always kept connected with the earth, while C_2 is charged positively or negatively by means of an electrical machine; after leaving this condenser the rays pass between two plates M , used for producing the electrostatic deflection, on to a screen S ; the dotted circle round M represents the coil used for producing the magnetic deflection. The velocities of the ions were measured (1) when the plates of the condenser C_1C_2 were at the same potential, (2) when they were maintained at different potentials; it was found that when the plate C_2 was negatively electrified the velocity in case (2) was less than that in (1), while when the plate C_2 was positively electrified it was greater; if v_1 is the velocity of the ions in case (1), v_2 that in case (2), then assuming that the

* Lenard, *Wied. Ann.* xlv. p. 504, 1898. *

whole change in the energy is due to the action of the electric field we have

$$\frac{1}{2}m(v_2^2 - v_1^2) = eV \dots \dots \dots (1),$$

where V is the potential difference between the plates, V being taken positive when C_2 is at a higher potential than C_1 . The results of Lenard's experiments are given in the following table, the fourth column contains the value e/m calculated by equation (1).

v_1 (cm./sec.)	v_2 (cm./sec.)	V (electromagnetic units)	e/m
$\cdot 7 \times 10^{10}$	$\cdot 35 \times 10^{10}$	$- 291 \times 10^{10}$	$6\cdot 2 \times 10^6$
$\cdot 68 \times 10^{10}$	$\cdot 34 \times 10^{10}$	$- 210 \times 10^{10}$	$8\cdot 1 \times 10^6$
$\cdot 62 \times 10^{10}$	$\cdot 89 \times 10^{10}$	$+ 291 \times 10^{10}$	$6\cdot 9 \times 10^6$
$\cdot 77 \times 10^{10}$	$\cdot 47 \times 10^{10}$	$- 291 \times 10^{10}$	$6\cdot 4 \times 10^6$
$\cdot 79 \times 10^{10}$	$1\cdot 0 \times 10^{10}$	$+ 291 \times 10^{10}$	$6\cdot 6 \times 10^6$
$\cdot 88 \times 10^{10}$	$1\cdot 07 \times 10^{10}$	$+ 291 \times 10^{10}$	$6\cdot 5 \times 10^6$

The constancy of the value of e/m is a strong confirmation of the truth of the theory that the rays are charged particles in rapid motion.

Method of determining the value of e/m and v by measuring the energy carried by the cathode rays.

62. Many other methods have been employed to measure e/m . One, used by the writer*, was to measure the energy carried by the rays. To do this a narrow pencil of rays passed through a small hole in a metal cylinder and fell upon a thermo-couple, the couple was heated by the impact of the rays, and by measuring by means of a galvanometer the rate at which the temperature of the junction increased, the amount of heat communicated to the junction in unit time was determined, let us call this amount Q ; then if we assume that all the energy possessed by the cathode rays is converted into heat we have

$$\frac{1}{2} Nmv^2 = Q,$$

where N is the number of particles which enter the cylinder through the hole in unit time, m is the mass and v the velocity of a particle.

* J. J. Thomson, *Phil. Mag.* v. 44, p. 293, 1897.

If e is the charge of the ion, then in each unit of time Ne units of negative electricity will enter the cylinder; the rate at which the negative charge increases can easily be measured if the cylinder is insulated and connected with an electrometer; let E be the rate of increase of the negative electricity inside the cylinder, then we have

$$Ne = E.$$

Eliminating N from these equations we get

$$\frac{1}{2} \frac{m}{e} v^2 = \frac{Q}{E}.$$

If we observe the magnetic deflection produced by a known magnetic field we determine mv/e , hence since we have just seen how to determine mv^2/e we can deduce the values of v and m/e .

The results of experiments made in this way are shown below.

Gas	v	e/m
Air	2.4×10^9	1.1×10^7
Air	3.2×10^9	1.4×10^7
Hydrogen	2.5×10^9	1.0×10^7

The mean of the values for e/m is 1.17×10^7 : this value is considerably greater than the one previously found, the method however is not so reliable as the preceding one, as three measurements have to be made, the magnetic deflection, the heating effect, and the rate of increase of the charge in the cylinder, instead of two, the magnetic and the electric deflection; and it is not merely that the measurements are more numerous, they are also more difficult, as the measurement of the heating effect and the rate of increase of the charge are much more complicated than that of the electrostatic deflection. The conductivity given to the gas by the passage through it of the cathode rays allows some of the charge in the cylinder to leak away and thus tends to make the observed value of E smaller than the true one; if E were underestimated the values of e/m obtained by this method would be too large. In the experiments described above efforts were made to diminish this effect as much as possible by connecting the cylinder to a condenser of large capacity so that the negative charge on the

rays should only produce a small change in the potential of the cylinder. We may remark in passing that the charges of negative electricity carried by the rays are very large, thus with quite a small hole (about 1 mm. in radius) in the cylinder the potential of the cylinder would change sometimes as much as 5 volts per second when exposed to the rays, even though it was connected with a condenser having a capacity about .15 microfarad.

Methods of determining v and e/m from the magnetic deflection and potential difference between the electrodes of the discharge tube.

63. These methods, which were first used by Schuster* in 1890, are based on the following principles. If V is the potential difference between the terminals of the tube, then the work done on an ion in passing from one end of the tube to the other is Ve , hence the kinetic energy acquired by the ion can not be greater than Ve , so that

$$\frac{1}{2}mv^2 \nless Ve.$$

From the observation of the effect of the magnet on the discharge (Schuster measured the radii of the circles which are the path of the ions in a strong magnetic field) we know the value of mv/e , let us call this quantity q , then from the preceding equation we have

$$e/m \nless \frac{2V}{q^2}.$$

To find an inferior limit for e/m , Schuster took v equal to the velocity of mean square of the atoms of the gas in the tube; calling this velocity U we have

$$e/m \nless \frac{U}{q}.$$

Schuster found for air by this method

$$e/m \nless 11 \times 10^9,$$

$$e/m \nless 10^9.$$

If we assume that the charge on the nitrogen atom is three times that on the atom of hydrogen in the electrolysis of liquids

* Schuster, *Proc. Roy. Soc.* xvii. p. 526.

and if m is the mass of the nitrogen atom, then e/m is equal to 2×10^8 ; as this is within the limits for e/m previously found, Schuster concluded that the negatively electrified particles in the cathode rays in a tube filled with nitrogen are atoms of nitrogen. We have seen that more recent investigations have led to quite a different conclusion.

64. Several determinations of the values of e/m and v have been made on the assumption that the kinetic energy possessed by the ion is equal to the energy that would be acquired by the ion in falling through the potential difference V between the anode and the cathode; on this assumption we have

$$\frac{1}{2}mv^2 = Ve \dots\dots\dots(1),$$

and if q or nv/e is determined by the magnetic deflection we have

$$\frac{e}{m} = \frac{2V}{q^2}.$$

Determinations of e/m on this principle have been made by Kaufmann* and subsequently by Simon†. Kaufmann found by this method that

$$\frac{e}{m} = 1.86 \times 10^7.$$

And Simon, who made a very large number of experiments in which the potential difference between the cathode and anode ranged from 4860 to 11840 volts, found that

$$\frac{e}{m} = 1.865 \times 10^7.$$

The value of e/m was found to be independent of the potential difference. A Wimshurst machine was used to produce the discharge as this maintains a very much more uniform potential difference than an induction coil.

The values found for e/m by this method are larger than those found by the methods previously described; the method is however open to objection, for it assumes that the kinetic energy of the ion is equal to the work done on an ion starting in the cathode itself and thus experiencing the maximum fall of

* Kaufmann, *Wied. Ann.* v. 61, p. 544; 62, p. 596, 1897; 65, p. 431, 1898.

† Simon, *Wied. Ann.* v. 69, p. 589, 1899.

potential possible in the tube, and also that all the work done by the electric field is spent in increasing the kinetic energy of the ion while none of this energy is lost by the collisions of the ion with the molecules of the gas through which it passes. Now we have no right to assume without proof that the ion starts from the cathode itself; we shall see that, at any rate when the pressure is not very low, large numbers of ions are produced at some little distance away from the cathode, and as the change of potential in the neighbourhood of the cathode is very rapid such ions would experience a notably smaller potential fall than those starting from the cathode itself. Nor is the fact that the values of e/m found by this method are independent of the potential difference a conclusive proof that the ions under observation started from the cathode. For suppose that the distance from the cathode of the place from which the greater part of the ions start is d , and that $V\beta$ is the potential gradient, then the fall of potential experienced by these ions is $V(1-\beta d)$; now β diminishes as the pressure of the gases diminishes while d increases, so that it is quite possible that βd is independent of the pressure of the gas (it would be so if for example β were directly and d inversely proportional to the pressure); in this case the fall of potential experienced by the ions would always be a constant fraction of the total fall of potential in the tube, so that the value of e/m determined by equation (1) would always bear a constant ratio to the true value. As the maximum potential difference used by Simon was only about 1100 volts the pressure could not have been very low in his experiments. When the pressure of the gas is exceedingly small the number of collisions with the molecules of a gas made by an ion in its journey down the tube may be so greatly reduced that but few fresh ions are produced by the collisions, and in this case the greater number of the ions may come from the electrode itself, but even in this case the use of equation (1) is not legitimate, as part of the work may be spent in tearing the ions out of the metal and only the remainder is available for increasing the kinetic energy.

These considerations show that the use of equation (1) leads to an over-estimate of the kinetic energy of the ion and therefore, since $e/m = mv^2/eq^2$, the value of e/m calculated by this method will tend to be too large.

Recent experiments made by Seitz* show that, however, when the pressure of the gas is very low the kinetic energy acquired by the corpuscles is equal to \sqrt{Ve} . The deflection of the corpuscles by an electric field, the heat produced by them, and, on the preceding assumption, the fall of potential at the cathode all involve the same quantity, the kinetic energy of the corpuscle. Seitz determined the kinetic energy by each of these methods and found that they gave the same value.

The method used by Lenard, and described on page 124, though it depends upon the same equations is not open to these objections, as in this method the potential difference which enters into the equations is applied to the ions after they have been produced and started on their path, and in this case the increase in the kinetic energy must equal the work done if we can neglect the loss of kinetic energy of the ions produced by collisions with the molecules of the gas; this effect can be eliminated by working at very low pressures and varying the length of path traversed by the ion under the electric field.

Becker† has quite recently determined e/m for cathode rays by this method, he finds $e/m = 1.8 \times 10^7$ the velocity of the rays was about 10^{10} cm/sec.

65. In January, 1897, Wiechert‡ published a determination of the values between which e/m must lie. The principles on which this determination is based are as follows: by measuring the magnetic deflection in a field of known strength we can determine $\frac{m}{e}v$; to get a second relation between m/e and v , Wiechert put

$$\frac{1}{2} \frac{m}{e} v^2 = kV \dots \dots \dots (1),$$

where V is the difference of potential between the electrodes in the discharge tube and k an unknown quantity which cannot be greater than unity. To get the maximum value of v , and therefore the maximum of e/m , k in equation (1) was put equal to unity. To get minimum values for v and e/m Wiechert assumed that the kinetic energy of the ions in the cathode rays was greater than that due to a fall through a potential difference equal to

* Seitz, *Ann. der Phys.* viii. p. 233, 1902.

† Becker, *Ann. der Phys.* xvii. p. 381, 1905.

‡ Wiechert, *Sitzungsber. d. Physikal.-ökonom. Gesellsch. zu Königsberg*, i. Pr. 38, p. 1, 1897.

the 'cathode fall of potential.' The cathode fall of potential is the difference between the potential of the cathode and that of a point on the outer boundary of that dark space in the discharge which adjoins the cathode. Warburg has shown that this cathode fall of potential is independent of the magnitude of the current through the gas, of the pressure of the gas and, within certain limitations, of the nature of the electrodes. As its value in air is about 270 volts, Wiechert assumed that a minimum value for kV was 200 volts. The grounds for this assumption do not seem obvious; *a priori* it would seem more probable that the minimum value to take for kV should have been the potential difference, not between the cathode and the outer boundary of this dark space, but between this boundary and the place where the magnetic deflection of the rays was determined, for we know that the rays are fully developed at this boundary, and it is by no means so certain that at moderate pressures they all exist close to the cathode. Using these assumptions, however, Wiechert found for the maximum value of e/m the value 4×10^7 and for the minimum value 4×10^6 .

66. Wiechert* has also determined by direct measurement the velocity of the ions in the cathode rays, using a method first applied by Des Coudres† for this purpose. The principle of the method is as follows: suppose that $ABCD$, $A'B'C'D'$ are two circuits traversed by very rapidly alternating currents, such as those produced by the discharge of a Leyden jar, let us suppose that the currents in the two circuits are in the same phase, and that these circuits are placed close to a tube along which cathode rays are passing. The currents in the circuits will give rise to electric and magnetic forces which will deflect the rays as they pass by the circuits. If the velocity of the rays were infinite, then the deflections produced by the two circuits on the rays would be equal and in the same direction; if however the rays take a finite time to travel from one circuit to the other, and if the distance between the circuits is adjusted so that this time is equal to half the period of vibration of the current, then the deflection produced by the first circuit will be equal and opposite to that produced by the second; or if the distance between the circuits

* Wiechert, *Wied. Ann.* lxxix. p. 739, 1899.

† Des Coudres, *Verhandl. d. physikal. Gesellsch. zu Berlin*, xiv. p. 86, 1895.

is such that the time taken by the rays to pass from one circuit to the other is equal to one quarter of the period of the currents, then when the effect produced by the circuit $ABCD$ is a maximum that produced by $A'B'C'D'$ will be zero.

The arrangement used to apply these principles to determine the velocity of the cathode rays is represented in Fig. 29; $ABCD$, $A'B'C'D'$ are the circuits carrying the currents produced by the discharge of the jars, C is a concave cathode, B_1 , B_2 metal diaphragms perforated at the centre, G a screen covered with some material which becomes phosphorescent when bombarded by the cathode rays. M is a horse-shoe magnet which deflects the rays from the hole in the diaphragm B_1 , so that when no currents are

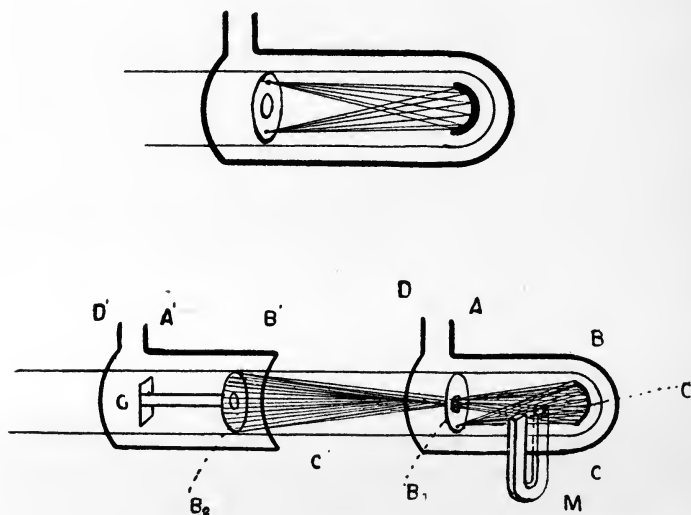

Fig. 29.

passing through $ABCD$, $A'B'C'D'$ the cathode rays are stopped by the diaphragm and the phosphorescent screen remains dark. When a current passes through $ABCD$ the pencil of cathode rays is deflected and swings backwards and forwards like a pendulum; if during the swing the pencil strikes the hole in B_1 some of the rays will get through B_1 and B_2 , and the screen G will be illuminated. The brightness of the illumination will be greatest when the hole in B_1 is just at the extremity of the swing caused by the current in $ABCD$, for in this case the pencil is momentarily at

rest, and the time the pencil remains on the opening is therefore a maximum. If there is no current in $A'B'C'D'$ the position of the phosphorescent spot on the screen will be on the line joining the holes in the two diaphragms; if a current in the same phase as that through $ABCD$ is passing through $A'B'C'D'$, then since the cathode rays that reach the diaphragm are displaced upwards by the current in $ABCD$, they will be similarly displaced by that in $A'B'C'D'$, and the phosphorescent patch will be above the line joining the holes in the diaphragm, while if the current in $A'B'C'D'$ is in the opposite phase the patch will be displaced downwards, the direction of the displacement of the patch will be reversed by reversing the poles of the magnet. If however the phases of the currents in $ABCD$, $A'B'C'D'$ differ by a quarter of a period, then when the vertical displacement due to $ABCD$ is a maximum that due to $A'B'C'D'$ will be zero, and the vertical distribution of the light on the screen G will not be affected by reversing the magnet M . We can ensure that the rays which get through the opening in B_1 are those which are passing when the vertical displacement due to the current in $ABCD$ is greatest, by gradually increasing the deflection of the rays by moving the magnet M ; when we have got M into such a position that any further increase in the deflection prevents any rays from reaching the screen, we know that only those which suffer the maximum deflection come under the action of $A'B'C'D'$; if then we move $A'B'C'D'$ into such a position that the vertical distribution of phosphorescence on the screen is not affected by reversing M , we know that when the rays are passing $A'B'C'D'$ the current in this circuit differs in phase by a quarter period from the phase of the current in $ABCD$ when the rays were passing that circuit. If the circuits $ABCD$, $A'B'C'D'$ are arranged so that the currents in them are simultaneously in the same phase, we know that the rays must have taken a time equal to one quarter of a period of the currents to pass from $ABCD$ to $A'B'C'D'$. The period of the currents can be determined by Lecher's method*, hence knowing the distance between the circuits we can determine the velocity of the rays.

The arrangement used to carry out this method is represented in Fig. 30. CC are two pairs of parallel plates, the upper pair of plates are connected with the spark gap F , which is also connected with the terminals of an induction coil, the lower pair of

* Lecher, *Wied. Ann.* xci. p. 850, 1890.

plates are connected symmetrically with the circuits $ABCD$, $A'B'C'D'$. The cathode rays are produced by a system in electrical connection with that producing the alternating currents. L and L are two Leyden jars whose outer coatings are connected with the extremities of the spark gap F , the inner coatings of the jars are connected with the primary coil of a high tension transformer, the secondary coil of which is connected with the anode and cathode of the discharge tube. In order to prevent the rays being scattered to the walls of the tube during their passage from one circuit to another a magnetising spiral was wound round the tube producing a magnetic force parallel to the length

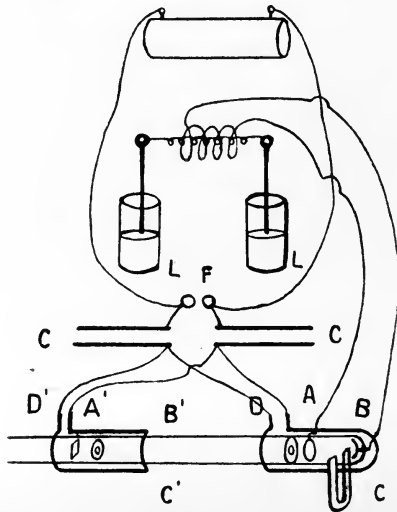

Fig. 30.

of the tube; this concentrated the rays along the axis of the tube and made the observations easier. With this contrivance it was found possible not merely to find a position of $A'B'C'D'$, when the currents differed by a quarter of a period, when the rays passed through them, but to find the second position when they differed by three-quarters of a period.

If λ is the distance between the circuits when they differ by a quarter period, L the wave-length of the electrical waves passing through these circuits, v the velocity of the rays, and V the velocity of light, then

$$\frac{v}{V} = \frac{\lambda}{L/4}.$$

Thus, in one experiment, $L = 940$ cm., $\lambda = 39$, hence v is about 5×10^9 . The pressure was between $\frac{1}{2}$ and $\frac{1}{4}$ of a millimetre. v being determined, we get e/m from the value of mv/e , which is got by measuring the magnetic deflection of the rays. The determination of v by this method is difficult and we cannot expect a high degree of accuracy. As the result of his experiments, Wiechert came to the conclusion that the value of e/m is between 1.55×10^7 and 1.01×10^7 . The most probable value he gives as 1.26×10^7 .

Determination of e/m for the negative ions produced when ultra-violet light falls on a metal plate, the gas through which the ions pass being at a very low pressure.

67. The writer* determined the values of e/m for the negative ions produced by the incidence of ultra-violet light on a metal plate by the following method. It is proved on page 114 that when an ion starts from rest from the plane $x=0$, at the time $t=0$, and is acted on by a uniform electric field of strength X , parallel to the axis of x , and by a uniform magnetic force H , parallel to z , the position of the particle at the time t is given by the equations

$$x = \frac{mX}{eH^2} \left\{ 1 - \cos \left(\frac{e}{m} Ht \right) \right\},$$

$$y = \frac{mX}{eH^2} \left\{ \frac{e}{m} Ht - \sin \left(\frac{e}{m} Ht \right) \right\},$$

where x and y are the coordinates of the ion. The path of the ion is thus a cycloid and the greatest distance the ion can get from the plane $x=0$ is equal to $2mX/eH^2$.

Suppose now that we have a number of ions starting from the plane $x=0$, and moving towards the parallel plane $x=a$, supposed to be unlimited in extent; if a is less than $2mX/eH^2$ all the ions which start from $x=0$ will reach the plane $x=a$, while if a is greater than $2mX/eH^2$ none of the ions will reach this plane. If $x=0$ is a zinc plate illuminated by ultra-violet light, and thus the seat of a supply of negative ions, and $x=a$ a metal plate connected with an electrometer, then when a definite electric intensity is established between the plates, so that the number of ions which leave the plate in unit time is

* J. J. Thomson, *Phil. Mag.* v. 48, p. 547, 1899

fixed, and if a is less than $2Xm/eH^2$, all the ions which start from $x=0$ will reach the plane $x=a$. Thus the rate at which the plate connected with the electrometer receives a negative charge will be the same when there is a magnetic force acting across the plate as when there is no such force. If however a is greater than $2Xm/eH^2$, then no ion which starts from $x=0$ will reach the plane $x=a$, and this plate will not receive any negative charge: so that in this case the magnetic field entirely stops the supply of negative electricity to the plate connected with the electrometer. Thus, on this theory, if the distance between the plates is less than a certain value, the magnetic force produces no effect on the rate at which the plate connected with the electrometer receives a negative charge, while when the distance is greater than this value the magnetic force entirely stops the supply of negative electricity to the plate. The actual phenomena are not so abrupt as this theory indicates. We find in practice that when the plates are near together the magnetic force produces only an exceedingly small effect, and this an increase in the rate of charging of the plate. On increasing the distance between the plates, we come to a stage where the magnetic force produces a very great diminution in the rate of charging; it does not, however, stop it abruptly, as there is a considerable range in which the magnetic field diminishes but does not entirely stop the supply of negative electricity to the plate. At still greater distances the current to the plate under the magnetic force is quite insignificant compared with the current when there is no magnetic field. We should get this gradual instead of abrupt decay of the current if the ions were projected with finite velocity, or if, instead of all starting from the plane $x=0$, they started from a layer of finite thickness t ; in this case the first ions which failed to reach the plate would be those which started from $x=0$, this would occur when $a=2mX/eH^2$, some ions would however continue to reach the plate until $a=t+2mX/eH^2$. Thus if we measure the distance between the plates when the magnetic force first begins to retard the current, we can, if we know the values of X and H , determine the value of e/m . The finite thickness of the layer from which the ions start may be explained by the use of a principle which we shall find of great importance in many other phenomena connected with the discharge of electricity through gases: it is

that when ions move through a gas with a velocity exceeding a certain limit, the ions by their collisions with the molecules of the gas through which they move produce fresh ions. Thus when the negative ions which start from the metal surface acquire under the electric field a certain velocity they will produce new ions, and thus the ionisation will not be confined to the metal plate but will extend through a layer of finite thickness.

In using this method of determining e/m it is necessary to have the gas between the plates at a very low pressure, so low that the mean free path of the ion is at least comparable with the distance between the plates; if this is not the case the resistance offered to the motions of the ions by the viscosity of the gas prevents the preceding investigation from being applicable.

The mean value of e/m found in these experiments was 7.3×10^6 . It thus agrees very well with the value 7.6×10^6 found for the same quantity for the carriers of the negative electricity in the cathode rays: and proves that the carriers of electricity in the two cases are the same, or, as we may express it, that a metal plate emits cathode rays when illuminated by ultra-violet light.

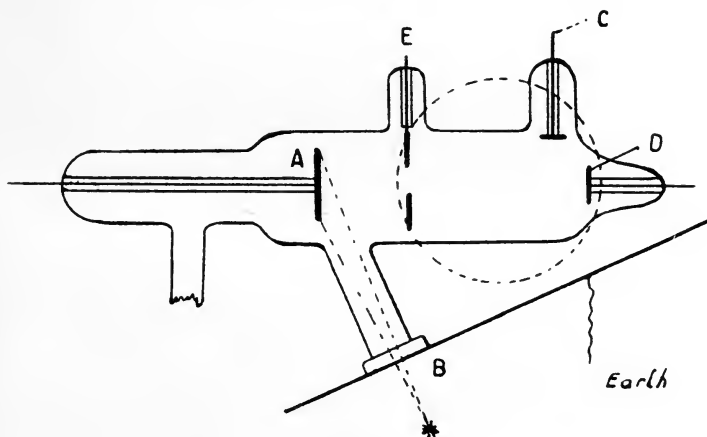

Fig. 31.

68. Lenard* in 1900 also measured the value of e/m in the case of the discharge of negative electricity through gas at a very low pressure from a cathode illuminated by ultra-violet light. The arrangement he used is represented in Fig. 31. A is

* Lenard, *Ann. d. Phys.* ii. p. 359, 1900.

an aluminium plate on which the ultra-violet light shines: this light comes from a spark between zinc electrodes and enters the tube through the quartz window *B*. *E* is another metal electrode perforated in the middle and connected with the earth, it shields the right-hand part of the apparatus from the electrostatic action of the charged electrode *A*. *D* and *C* are electrodes which can be connected with an electrometer. When *A* is charged up a stream of negative electricity goes through the opening in *E*, and striking against the plate *D*, charges up the electrometer with negative electricity. If the electrometer be connected with *C* instead of with *D*, it will not receive any charge. We can however give *C* a charge by deflecting the stream of negative ions by a magnet until they strike against *C*. As we still further increase the magnetic field the ions will be deflected by the field past *C*, and the charge communicated to *C* will fall off rapidly. The amount of negative electricity received by the electrodes *D* and *C* respectively, as the magnetic force is increased, was in Lenard's experiments represented by the curves in Fig. 32. The ordinates are the charges received by the electrodes and the abscissæ the values of the magnetic force. The curve to the left is for the

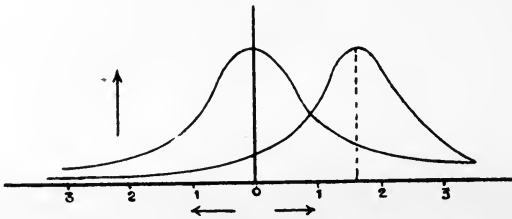

Fig. 32.

electrode *D*, that to the right for *C*. Since the negative ions are not exposed to any electric field in the part of the tube to the right of *E* their paths in this region under a constant magnetic field will be circles whose radii are equal to mv/eH . Now *C* will receive the maximum charge when the circle with this radius passing through the middle of the hole in *E*, and having its tangent at this point horizontal, passes also through the middle of the electrode *C*. The radius *R* of this circle is fixed by the relative positions of *E* and *C*. Hence, if we measure *H* when *C* receives its maximum charge, we have

$$R = \frac{mv}{eH} \dots \dots \dots (1).$$

The velocity is determined by the assumption that the work done by the electric field, when the ion passes from A to E , is spent in increasing the kinetic energy of the ion (we have already considered on page 128 the objections which may be raised against this assumption): this leads to the equation

$$\frac{1}{2}mv^2 = Ve \dots\dots\dots(2),$$

where V is the potential difference between A and E . From equations (1) and (2) the values of e/m and v can be determined. In this way Lenard found that e/m for the negative ions produced by the action of ultra-violet light in a gas at a very low pressure is equal to 1.15×10^7 .

Reiger* found for the negative ions emitted by glass when exposed to ultra-violet light values of e/m ranging from 9.6×10 to 1.2×10^7 .

Value of e/m for the negative ions produced by an incandescent wire.

69. A metal wire when raised to a white heat in a gas at a very low pressure gives out negative ions; the writer† has determined the value of e/m for the negative ions given out by an incandescent carbon filament in hydrogen at a very low pressure. The method used was the same as that used by him to determine the value of e/m for the ions produced by the action of ultra-violet light, and which has already been described on page 135. The value of e/m found in this way was 8.7×10^6 , which agrees within the errors of experiment with the values found for e/m for the ions in the cathode rays, and for those produced by the action of ultra-violet light.

For the particles emitted by a glowing Nernst filament Owen‡ found $e/m = 5.65 \times 10^6$, and for those emitted by glowing lime Wehnelt§ found $e/m = 1.4 \times 10^7$.

Value of e/m for the negative ions emitted by radio-active substances.

70. It has been shown by M. and Madame Curie|| that the

* Reiger, *Ann. d. Phys.* xvii. p. 947, 1905.

† J. J. Thomson, *Phil. Mag.* v. 48, p. 547, 1899.

‡ Owen, *Phil. Mag.* vi. 8, p. 230, 1904.

§ Wehnelt, *Ann. d. Phys.* xiv. p. 425, 1904.

|| M. et Mme. Curie, *Comptes Rendus*, t. 130, p. 647.

radioactive substance radium emits negative ions. The velocity of these ions and the value of e/m have been determined by Becquerel*. The method he employed was to measure the deflections of the rays produced by an electrostatic and also by a magnetic field. The experiments were made at atmospheric pressure, and the resistance offered to the motion of the ions by the gas through which they pass was neglected: this would not be justifiable in the case of the ions we have hitherto been considering, but as the ions emitted by radium are very much more penetrating than those we have hitherto considered, and are able to travel as far through a gas at atmospheric pressure as other kinds of ion travel through a gas at a very low pressure, we shall probably get approximately the right values for e/m and v for the radium ions even if we neglect the resistance of the gas. The radium was placed below two parallel vertical metal plates, about 3.5 cm. wide and 1 cm. apart; above these metal plates was a horizontal photographic plate protected by a covering of black paper from the action of light; a thin slip of mica, symmetrically situated with respect to the metal plates, was placed over the radium, this cast a shadow on the photographic plate which when the metal plates were at the same potential was at the middle of the field; when a great difference of potential, 10,200 volts, was maintained between the plates the position of this shadow was displaced towards the positive plate. Consider an ion passing between the plates, then if l is the length of its path between the plates, F the electric force acting upon it, the displacement of the ion parallel to the lines of electric force when it leaves the region between the plates is $\frac{1}{2} \frac{Fe l^2}{m v^2}$, and its direction of motion is displaced through an angle $\tan^{-1} \frac{Fe l}{m v^2}$, hence if h is the vertical distance of the photographic plate above the upper edge of the parallel metal plate, the point where the ion strikes the plate will be deflected through a space δ parallel to the line of electric force, where δ is given by the equation

$$\begin{aligned} \delta &= \frac{1}{2} \frac{Fe l^2}{m v^2} + h \frac{Fe l}{m v^2} \\ &= \frac{Fe l}{m v^2} \left\{ \frac{l}{2} + h \right\}. \end{aligned}$$

* Becquerel, *Rapports présentés au Congrès International de Physique à Paris*, t. iii. p. 47, 1900.

The magnetic deflection was found in the following way: a small quantity of radium was placed in a little lead saucer on a photographic plate; as none of the rays from the radium reach the plate the latter is not affected; if however a strong magnetic field, with the lines of force parallel to the plate, acts on the negative ions coming from the radium, these will be bent round and will strike the plate, producing a photograph.

To find the boundary of this photograph, let us take the plane of the photographic plate as the plane of xy , the magnetic force H being parallel to x ; the equations of motion of an ion are

$$m \frac{d^2x}{dt^2} = 0, \quad m \frac{d^2y}{dt^2} = He \frac{dz}{dt}, \quad m \frac{d^2z}{dt^2} = -He \frac{dy}{dt};$$

the solutions of these equations are, if $\omega = He/m$, and u, A, B are constants,

$$\begin{aligned} x &= ut, \\ y &= A(1 - \cos \omega t) + B \sin \omega t, \\ z &= A \sin \omega t + B(\cos \omega t - 1). \end{aligned}$$

If v and w are the values of $dy/dt, dz/dt$ when $t=0$, we have

$$\begin{aligned} y &= \frac{w}{\omega}(1 - \cos \omega t) + \frac{v}{\omega} \sin \omega t, \\ z &= \frac{w}{\omega} \sin \omega t + \frac{v}{\omega}(\cos \omega t - 1); \end{aligned}$$

when the ion strikes the plane we have $z=0$, hence

$$\tan \frac{1}{2} \omega t = \frac{w}{v}.$$

Now if the ion is projected so as to make an angle θ with the direction of the magnetic force, and if the plane through the direction of projection and the axis of x makes an angle ϕ with the plane of xz , we have, if V is the velocity of projection,

$$u = V \cos \theta, \quad v = V \sin \theta \sin \phi, \quad w = V \sin \theta \cos \phi,$$

hence

$$\begin{aligned} \tan \frac{1}{2} \omega t &= \cot \phi \\ &= \tan \left(\frac{\pi}{2} - \phi \right), \end{aligned}$$

thus

$$\omega t = \pi - 2\phi.$$

Substituting this value for t , we find, if ξ and η are the coordinates of the point where the ion strikes the photographic plate,

$$\xi = \frac{V \cos \theta}{\omega} (\pi - 2\phi),$$

$$\eta = \frac{2V \sin \theta \cos \phi}{\omega}.$$

Thus, for the particles projected in a plane through the axis of x , the locus of the points where they strike the plate will be an ellipse whose semi-axes are $\frac{2V \cos \phi}{\omega}$ and $\frac{V(\pi - 2\phi)}{\omega}$. For the particle projected in the plane of xz , the semi-axes of the ellipse are $2V/\omega$ and $\pi V/\omega$. An example of such an ellipse is shown in Fig. 33, which is copied from a photograph by Becquerel.

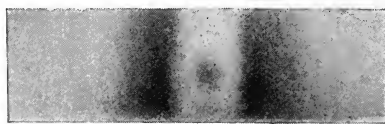

Fig. 33.

By the measurement of the axes of the ellipse we can determine V/ω , *i.e.* Vm/eH . As the radium emits ions having velocities extending over a considerable range, the impression on the plate is not the arc of a single ellipse, but a band bounded by the ellipses corresponding to the smallest and greatest velocities of the ions. Becquerel took photographs when the ions from the radium went (1) through the air at atmospheric pressure, and (2) through air at very low pressure; the photographs were found to be identical, in fact one-half of the photograph represented in Fig. 33 is produced by ions going through air at atmospheric pressure, and the other half by ions going through air at a very low pressure. The identity of the results in the two cases justifies us in our neglect of the resistance of the air.

A simpler method than the electrostatic one used by Becquerel to get a second relation between v and e/m , would be to place the radium on a photographic plate in a little tube so that all the ions start at right angles to the plate. A uniform magnetic

field acts parallel to the plate, and that above the photographic plate and parallel to it is a metal plate which is connected with an electric machine; when this plate is charged with electricity there will be a strong electric field acting on the ion parallel to its direction of projection and at right angles to the magnetic force. If photographs are taken (1) with the plate uncharged, (2) with the plate charged, the two photographs will give us a simple method of finding v and e/m . For let us suppose that all the ions have the same velocity V , the distance $2R$ of the image in the first photograph from the radium is given by the equation

$$R = \frac{m}{e} \frac{V}{H}.$$

To find the distance of the image in the second photograph, let us take the same axes as before, and let Z be the electric force at right angles to the plate, then the equations of motion of an ion are

$$m \frac{d^2 z}{dt^2} = Ze - He \frac{dy}{dt},$$

$$m \frac{d^2 y}{dt^2} = He \frac{dz}{dt}.$$

The solution of these equations, when $z, y, dy/dt$ vanish when $t=0$, is

$$y = \frac{Z}{H} \left(t - \frac{\sin \omega t}{\omega} \right) + \frac{V}{\omega} (1 - \cos \omega t),$$

$$z = \frac{Z}{H\omega} (1 - \cos \omega t) + \frac{V}{\omega} \sin \omega t,$$

where V is the velocity of projection of the ion.

When the ion strikes the photographic plate $z=0$, hence

$$\tan \frac{1}{2} \omega t = - \frac{V}{Z/H}.$$

Substituting this value of t in the expression for y we find, if R_1 is the distance from the radium of the point at which the ion strikes the plate,

$$R_1 = \frac{Z}{H} t + \frac{2V}{\omega};$$

but $2V/\omega = R$, where R is the distance from the radium of the

point of return of the ion when the upper metal plate is not charged, hence we have

$$R_1 - R = \frac{Z}{H} t,$$

or

$$\frac{1}{2} \omega t = \frac{R_1 - R}{R} \frac{V}{Z/H};$$

hence since

$$\tan \frac{1}{2} \omega t = -\frac{V}{Z/H}$$

we have

$$\tan \frac{R_1 - R}{R} \frac{V}{Z/H} = -\frac{V}{Z/H} \dots\dots\dots(1),$$

an equation by which we can determine the value of $V/(Z/H)$. When V is known, e/m can be determined from the value of R .

When Z/H is small compared with V an approximate solution of equation (1) is

$$V = (Z/H) \frac{\pi}{2} \frac{R}{R_1 - R}.$$

Becquerel did not use this method of determining V , but the electrostatic method previously described; the latter method is not however in many respects so convenient as the one just given.

As the result of his experiments Becquerel found for one set of rays given out by the radium

$$v = 1.6 \times 10^{10}, \quad e/m = 10^7,$$

thus the value of e/m is the same for these negatively charged ions from radium as for the ions in the cathode and Lenard rays, as well as for those produced by ultra-violet light or by incandescent metals. The velocity of the ions is much greater than any we have met with in the case of ions arising in other ways, amounting as it does to more than half the velocity of light; the ions chosen by Becquerel for this experiment were by no means the fastest given out by the radium. Becquerel detected the existence of others whose velocity was at least half as much again as the velocity of those he measured.

It may be convenient to summarise in a table the results of the measurements of e/m made by different observers, and with ions produced in different ways.

TABLE OF VALUES OF e/m .

Source of Ions	Observer	Date	Method of Determination	Value of e/m	$v \times 10^{-9}$
Cathode rays	J. J. Thomson	1897	Magnetic and electrostatic deflection	7.7×10^6	2.2—3.6
„	J. J. Thomson	1897	Magnetic deflection and heating effect	1.17×10^7	2.4—3.2
„	Kaufmann	1897—8	Magnetic deflection and potential difference	1.86×10^7	
„	Simon	1899	Magnetic deflection and potential difference	1.865×10^7	
„	Wiechert	1899	Magnetic deflection and velocity of ions	1.01×10^7 — 1.55×10^7	
„	Seitz	1901	Magnetic and electrostatic deflection	6.45×10^6	7.03
„	Seitz	1902	Magnetic and electrostatic deflection, heating effect and potential difference	1.87×10^7	5.7—7.5
„	Starke	1903	Magnetic and electrostatic deflection	1.84×10^7	3.8—12
„	Reiger	1905	Magnetic deflection and potential difference	1.32×10^7	
„	Becker	1905	Magnetic deflection and retardation in electric field	1.8×10^7	10
Lenard rays	Lenard	1898	Magnetic and electrostatic deflection	6.39×10^6	
„	Lenard	1898	Magnetic deflection and retardation in electric field	6.8×10^6	3.4—10
Ultra-violet light	J. J. Thomson	1899	Retardation of discharge by magnetic field	7.6×10^6	
„	Lenard	1900	Magnetic deflection and potential difference	1.15×10^7	
„	Reiger	1905	Magnetic deflection and potential difference	9.6×10^6 — 1.2×10^7	
Incandescent metals	J. J. Thomson	1899	Retardation of discharge by magnetic field	8.7×10^6	
Incandescent oxides	Owen	1904	Retardation of discharge by magnetic field	5.6×10^6	
„	Wehnelt	1904	Magnetic deflection and potential difference	1.4×11^7	
Radium	Becquerel	1900	Magnetic and electrostatic deflection	10^7 approximately	2×10^{10}
„	Kaufmann	1901—2	Magnetic and electrostatic deflection	1.77×10^7 for small velocities	
Polonium (slow rays)	Ewers	1906	Magnetic and electrostatic deflection	1.7×10^7	

It is to be noted that these large values of e/m for gases only occur when the pressure of the gas is very low, when in fact there is very little gas for the ion to get entangled with; when the pressure of the gas is high, the ion seems to act as a nucleus round which the molecules of the gas collect; the ion thus gets loaded up, and the ratio of e/m is very small compared with its value at lower pressures.

Value of e/m for the positive ions.

71. The number of determinations of the value of e/m for the ions which carry the positive charge is small compared with those made for the corresponding quantity for the negative ions. The first determination of the value of e/m for the positive ions was made by W. Wien*. The positive ions he used were those which occur in what are known as 'canal-strahlen.' If an electric discharge passes between an anode and a cathode perforated with a number of holes, then behind the cathode, *i.e.* on the side of the cathode opposite to the anode, pencils of light are seen to

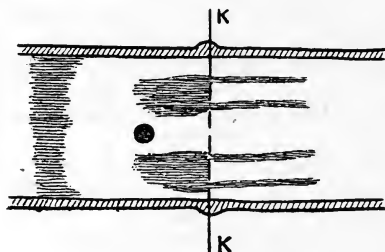

Fig. 34.

penetrate through the holes as in Fig. 34†, producing phosphorescence when they strike the glass. These rays—the canal-strahlen—have been shown by Wien to consist of positively charged ions. He exposed a long pencil of these rays coming through a perforated iron cathode to both an electrostatic and a magnetic field, and measured the corresponding deflections; from these he deduced by the method described in § 59, the values of e/m and v , and found

$$v = 3.6 \times 10^7 \text{ cm./sec.}, \text{ while } e/m = 300.$$

The 'canal-strahlen' or positive rays are only deflected with great difficulty, and it is necessary to use very strong fields; this increases the difficulty of the investigation; in Wien's experiments

* W. Wien, *Wied. Ann.* lxx. p. 440, 1898.

† Wehnelt, *Wied. Ann.* lxxvii. p. 421, 1899.

the strength of the magnetic field was 3250. It will be seen that the velocity of the positive ions is very much smaller than that of any of the cathode rays hitherto measured, while the value of e/m is of an entirely different order, being only about $1/30000$ of the value for the negative ion; moreover the value of e/m for the positive ions in the gas is *of the same order of magnitude* as the value of e/m in the ordinary electrolysis of solutions. Thus if m were the mass of the atom of iron, e the charge carried by an atom of hydrogen, e/m is about 200, or since iron is divalent the value of e/m for the ion in the electrolysis of solutions is about 400. We have not however sufficient data to enable us to determine whether the carriers of the positive electricity in the 'canal-strahlen' are the atoms or molecules of the metal of the cathode or of the gas in the tube.

In some later experiments Wien* has measured the value of e/m for the 'canal-strahlen' in tubes filled with different gases, he found that the most deflectible rays gave values for e/m of the order 10^4 , *i.e.* the value for the hydrogen atom, not only when the tube was filled with hydrogen but also when it was filled with other gases very carefully prepared: the phosphorescence due to the most deflectible rays was however much greater in hydrogen than in air or oxygen. We shall see that a metallic cathode emits hydrogen with great persistency, so that it is practically impossible to prepare a tube which does not contain hydrogen near the cathode. Along with these deflectible rays Wien found in a tube filled with hydrogen, rays for which e/m was less than $1/650$ of the greatest value, 10^4 . This would imply if we suppose the particles to retain their charge during the whole of their course that the mass of these particles is more than 650 times that of the hydrogen atom: this is enormously greater than the mass of the hydrogen *ion* in a weak electric field, while in the strong fields acting on the 'canal-strahlen' we should expect the mass of the ion to be less than in weak fields. These heavy particles may be pieces of metal torn off the cathode. I observed some time ago similar differences in the masses of the positive ions emitted by incandescent metals (see Art. 62).

The energy in the particles forming the positive rays or 'canal-strahlen' is that which they would acquire by a fall through a potential difference of about 16000 volts. As we know the charge and the mass of the particles forming the positive rays, we can

* Wien, *Ann. der Phys.* viii. p. 241. 1902.

compare the energy in the particles due to this difference of potential with the mean energy possessed at any temperature by the molecules of a gas, the mass of the molecules being the same as that of the particles in the positive rays; doing so we find that even at the highest attainable temperature the energy of a molecule in the gas would be quite insignificant in comparison with that of a particle in the positive rays.

72. The writer has determined the value of e/m for the positive ions by the method described on page 135 for the determination of the value of e/m for the negative ions produced by the action of ultra-violet light. The positive ions were produced by raising, by means of an electric current, an iron wire to a red heat in an atmosphere of oxygen, the pressure being very low. The wire was parallel to a metal plate connected with an electrometer, the distance of the wire from the plate was 4 mm. If the wire was charged positively the plate and the electrometer received a positive charge, the current passing between the plate and the hot wire being easily measured by the electrometer; if now the space between the hot wire and the plate was placed in a very powerful magnetic field, the lines of force being parallel to the plate, the rate of leak from the wire to the plate was found to diminish if the potential difference between the wire and the plate did not exceed a certain value—just as in the corresponding case of the negative ions produced by ultra-violet light—but while in the latter case a comparatively feeble magnetic force is sufficient to diminish the current, it requires a very powerful magnetic force to produce the effect with the hot wire; thus for example in my experiments on the positive ions I used a magnetic field of strength 12400 c.g.s. units, while in the experiments on the negative ones a field of 100 was amply sufficient to produce very appreciable effects. In the case of the hot wire I found that using a magnetic field of strength 12400 the rate of leak was less when the magnetic field was on than when it was off, when the potential difference between the plates was less than 50 volts; when it exceeded this value the rate of leak was the same whether the magnet was on or off. Thus when $H = 12400$ and $X = 50 \times 10^8 / 4$ the critical distance is .4 cm. Hence by the results given we have

$$.4 = \frac{2 \times 50 \times 10^8 m}{.4 \times (12400)^2 e},$$

or
$$\frac{e}{m} = 400.$$

This is about the value for e/m for the ion of iron in electrolysis: it does not however prove that the carriers of the positive electricity are the atoms of iron, for if m were the mass of a molecule of oxygen and e the charge on a hydrogen ion in the electrolysis of solutions e/m would be about 310, and the difficulties of the experiment are so great that we cannot say that this result differs from that actually found by more than the possible errors of the experiment.

We see however that for the positive ions e/m is of the same order as in ordinary electrolysis of solutions, and is variable, while for negative ions it is of an entirely different order, and is constant.

The effect of the strongest magnetic fields I have been able to use on the current when this is carried by positive ions is very much less marked than the effect of comparatively weak fields on the current when it is carried by negative ions. In the case of the positive ions the magnetic force, even in the most favourable circumstances, only diminishes the current, it does not entirely stop it: this points to the conclusion that the carriers of the positive charge are not all of one kind, but that some are much heavier than others; thus in the case of the leak of positive electricity from a hot platinum wire the study of the effect of the magnetic field on the current leads to the conclusion that a part of the current is carried by molecules of oxygen and the rest by molecules of platinum, or perhaps by aggregates of several molecules. The proportion between the numbers of the different kinds of carriers seems to vary very largely with the temperature and state of the surface of the platinum.

Rutherford* has shown that radium emits positively charged particles moving with enormous velocities, for these particles he finds $e/m = 6 \times 10^3$, $v = 2.5 \times 10^9$; these values are confirmed by the experiments of Des Coudres, who found

$$e/m = 6.4 \times 10^3, v = 1.65 \times 10^9.$$

Recent determinations by Mackenzie† on these particles make $e/m = 5 \times 10^3$.

* Rutherford, *Phil. Mag.* 6, v, p. 177, 1903. Des Coudres, *Phys. Zeit.* iv. p. 483, 1903.

† Mackenzie, *Phil. Mag.* [6], 10, p. 538, 1907.

CHAPTER VI.

DETERMINATION OF THE CHARGE CARRIED BY THE NEGATIVE ION.

73. WE have seen that the value of e/m for the negative ions in gases at a low pressure is more than a thousand times the greatest value of the ratio of the same quantities for ordinary electrolytes. The question at once arises, is this due to a difference in the masses of the ions, or to a difference in their electrical charges, or to both these causes? to decide these points we must determine the value of m or e . The writer made in 1898* and 1899† determinations of the value of e for the ions produced in one case by Röntgen rays and in the other by ultra-violet light. The method was based on the discovery made by C. T. R. Wilson‡ (see Chap. VII.) that gaseous ions, whether positive or negative, act as nuclei for the condensation of clouds even in the absence of dust; and that if we have a mass of dust-free gas containing ions in a closed vessel, and cool the gas by a sudden expansion, then a cloud will be produced if the ratio of the volume of the gas after expansion to the volume before is greater than 1.25. An expansion of this amount is quite incapable of producing more than very slight condensation in the gas if it does not contain ions. The water condenses round the ions, and if these are not too numerous each ion becomes the nucleus of a drop of water. Thus by producing a sudden expansion in a gas containing ions we can get a little drop of water round each ion; these drops are visible, and we can measure the rate at which they fall. Sir George Stokes has shown that if v is the velocity with which a drop of water falls through a gas, a the radius of the

* J. J. Thomson, *Phil. Mag.* v. 46, p. 528, 1898.

† J. J. Thomson, *Phil. Mag.* v. 48, p. 547, 1899.

‡ C. T. R. Wilson, *Phil. Trans. A*, p. 265, 1897.

drop, μ the coefficient of viscosity of the gas, and g the acceleration due to gravity, then

$$v = \frac{2}{9} \frac{ga^2}{\mu};$$

thus if we measure v we can determine a , and hence the volume of each drop. If q is the volume of water deposited from each cubic centimetre of the gas, n the number of the drops, we have

$$q = n \frac{4}{3} \pi a^3.$$

To find q we may proceed as follows: the gas after being cooled by the very rapid expansion is supersaturated and moisture is deposited on the ions; during the condensation of the water heat is given out which warms the gas, so that the temperature of the gas rises above the lowest temperature reached during the expansion before condensation has taken place. Let t_2 be the lowest temperature reached during the expansion, t the temperature when the drops are fully formed, then if L is the latent heat of evaporation of water, C the specific heat of the gas at constant volume, M the mass of unit volume of the gas after expansion, we have

$$Lq = CM(t - t_2) \dots \dots \dots (1);$$

we neglect the heat required to raise the temperature of the water in the gas in comparison with that required to raise the temperature of the gas itself. We have further

$$q = \rho_1 - \rho,$$

where ρ_1 is the density of the water vapour before condensation begins, and ρ the density at the temperature t . Substituting this value for q in equation (1), we get

$$\rho = \rho_1 - \frac{CM}{L}(t - t_2) \dots \dots \dots (2).$$

Since ρ is a known function of t this equation enables us to find t when t_2 is known.

If x is the ratio of the final to the initial volume of the gas and T the temperature in degrees centigrade of the gas before expansion, then since the mass of 1 cubic centimetre of air at the temperature 0° C. and under a pressure of 760 millimetres of mercury is .00129 grm., we have

$$M = \frac{\cdot 00129}{x} \times \frac{273}{273 + T} \frac{P}{760},$$

where P is the initial pressure of the gas expressed in millimetres of mercury.

Again,
$$\rho_1 = \frac{\rho'}{x},$$

where ρ' is the density of water vapour at the temperature T before expansion; as the air was saturated with water vapour at this temperature ρ' can be obtained directly from the Tables of the vapour pressure of water vapour.

The cooling caused by the adiabatic expansion is determined by the equation

$$\log \frac{273 + T}{273 + t_2} = \cdot 41 \log x \dots\dots\dots(3).$$

For in such an expansion $p v^\gamma$ is constant, where p is the pressure and v the volume and γ the ratio of the specific heat at constant pressure to that at constant volume: but $p v = R\theta$, where θ is the absolute temperature and R a constant, hence we have during an adiabatic expansion

$$v^{\gamma-1} \theta = \text{a constant};$$

hence if $v_1\theta_1, v_2\theta_2$ are the initial and final values of v and θ , we have

$$v_1^{\gamma-1}\theta_1 = v_2^{\gamma-1}\theta_2,$$

or
$$\log \frac{\theta_1}{\theta_2} = (\gamma - 1) \log \frac{v_2}{v_1}.$$

Since $\gamma = 1\cdot41$ this is equivalent to equation (3). From (3) we determine t_2 , and then since

$$C = \cdot 167, \quad L = 606,$$

equation (2) becomes

$$\rho = \frac{\rho'}{x} - \frac{\cdot 167}{606} \times \frac{\cdot 00129}{x} \frac{273}{273 + T} \frac{P}{760} (t - t_2) \dots\dots\dots(4).$$

As an example of how this equation is applied let us take a case which occurred in one of the experiments. Here

$$T = 16^\circ, \quad P = 760, \quad x = 1\cdot36.$$

To get t_2 we have

$$\log \frac{273 + 16}{273 + t_2} = \cdot 41 \log 1\cdot36 = \log 1\cdot134,$$

hence
$$273 + t_2 = 254\cdot8, \quad \text{or } t_2 = -18^\circ\cdot 2.$$

We find from the Tables that at 16°

$$\rho' = \cdot 0000135,$$

hence equation (4) becomes

$$\rho = 99\cdot 3 \times 10^{-7} - 2\cdot 48 \times 10^{-7} (t + 18\cdot 2) \dots \dots \dots (5).$$

To solve this equation we keep substituting various values for t until we find one for which the corresponding value of ρ given by (5) is the same as the value of the vapour pressure of water at the temperature t . We find by this process of trial and error that the solution of equation (5) is $t = 1\cdot 2$, and the corresponding value of ρ is $51\cdot 5 \times 10^{-7}$. Substituting this value for ρ we find $q = 47\cdot 7 \times 10^{-7}$ grms.

When we know q and a , n the number of drops is at once determined by the equation

$$n = q / \frac{4}{3} \pi a^3.$$

In this way we can determine the number of ions per cubic centimetre of gas. When we know the number of ions and also the velocity of the ions under unit electric force, we can very easily deduce the charge carried by an ion by measuring the current carried by these ions across each unit of area under an electric force E . For if n is the whole number of ions of one sign per c.c., U the mean of the velocities of the positive and negative ions under unit electric force, the current through unit area is equal to

$$neEU,$$

where e is the charge on the ion; the electric force E ought to be so small that the current is proportional to the electric force. When this is not the case the number of ions is diminished by the action of the electric field, and depends upon the magnitude of the electric force.

We can easily measure the current through the ionised gas and thus determine $neEU$, and as n , E , U are known we can deduce the value of e .

74. This method was first applied by the author to determine the charge on the ions produced by Röntgen rays. The method used for making the cloud and measuring the expansions is the same as that used by C. T. R. Wilson*: the apparatus for this and the

* C. T. R. Wilson, *Proc. Camb. Phil. Soc.* ix. p. 333, 1897.

electrical part of the experiment is represented in Fig. 35. The gas which is exposed to the rays is contained in the vessel *A* ;

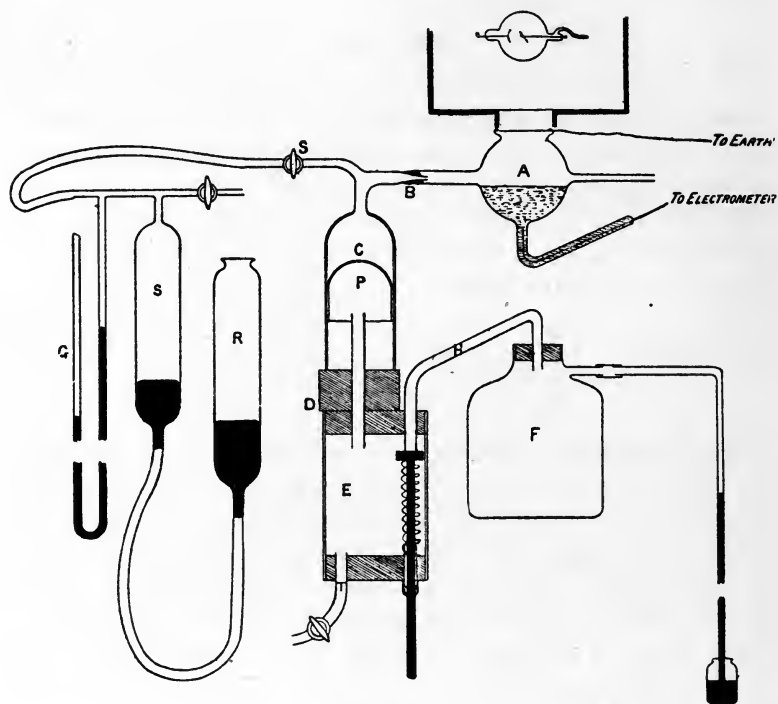

Fig. 35.

this vessel is connected by the tube *B* with the vertical tube *C*, the lower end of this tube is carefully ground so as to be in a plane perpendicular to the axis of the tube, it is fastened down to the india-rubber stopper *D*. Inside this tube there is an inverted thin-walled test tube *P* with the lip removed and the open end ground so as to be in a plane perpendicular to the axis of the tube. The test tube slides freely up and down the larger tube and acts as a piston. Its lower end is always below the surface of the water which fills the lower part of the outer tube ; a tube passing through the india-rubber stopper puts the inside of the test tube in communication with the space *E*. This space is in connection by the tube *H* with a large vessel *F* in which the pressure is kept low by a water-pump. The end of the tube *H* is ground flat and is closed by an india-rubber stopper which presses

against it, the stopper is fixed to a rod, and by pulling this rod down smartly the pressure inside the test tube is lowered and the test tube falls rapidly until it strikes against the india-rubber stopper. The tube T , which can be closed by a stop-cock, admits air into E and allows us to force the test tube back into its place for another expansion. The tubes R and S are for the purposes of regulating the amount of expansion. To do this the mercury vessel R is raised or lowered when the test tube is in its lowest position until the gauge G indicates that the pressure in A is the desired amount below the atmospheric pressure. The stop-cock S is then closed and air is admitted into the interior of the piston by opening the stop-cock T . The piston then rises until the pressure in A differs from atmospheric pressure only by the amount required to support the weight of the piston; this pressure is only that due to a fraction of a millimetre of mercury.

If Π is the barometric pressure, then P_1 , the pressure of the air before expansion, is given by the equation

$$P_1 = \Pi - \pi,$$

where π is the maximum vapour pressure of water at the temperature of the experiment. The pressure of the air P_2 after the expansion is given by

$$P_2 = P_1 - p,$$

where p is the pressure due to the difference of level of the mercury in the two arms of the gauge G .

Thus if v_2 is the final and v_1 the initial volume of the gas

$$\frac{v_2}{v_1} = \frac{P_1}{P_2} = \frac{\Pi - \pi}{\Pi - \pi - p}.$$

The vessel in which the rate of fall of the fog and the conductivity of the gas are tested is at A . It is a glass tube 36 millimetres in diameter covered with an aluminium plate; to avoid the abnormal ionisation which occurs when Röntgen rays strike against a metal surface, the lower part of the aluminium plate is coated with wet blotting-paper, and the electric current passes from the blotting-paper to the horizontal surface of the water beneath. The induction coil and the focus bulb for the production of the Röntgen rays are placed in a large iron tank, in the bottom of which a hole is cut and closed by an aluminium

window. The vessel A is placed underneath this window and the bulb giving out the rays some distance above it so that the beam of rays escaping from the tank is not very divergent. The intensity of the rays can be reduced to any required degree by inserting leaves of tinfoil or sheets of aluminium between the bulb and the vessel.

In these experiments it is necessary to work with very weak rays, so that the number of ions is comparatively small; when the number of ions is large some of them seem to escape from being caught by the cloud produced by the expansion, and when this is the case the number of ions deduced from the time of fall of the cloud will be too small; it is therefore advisable to work with such weak ionisation of the gas that the first cloud clears away all the ions.

To find the current passing through the gas, the tank and the aluminium plate on the top of the vessel A are connected with one pair of quadrants of the electrometer, the other pair of quadrants is connected with the water surface in the vessel A ; this surface is charged up to a known potential by connecting it with one of the terminals of a battery, the other terminal of which is connected with the earth. After the surface has been charged it is disconnected from the battery and the insulation of the system tested by observing whether there is any leak when the Röntgen rays are shut off; the insulation having been found satisfactory, the rays are turned on and the charge begins to leak from the electrometer; by measuring the rate of leak the quantity of electricity which in one second passes through the gas exposed to the rays can be determined. For suppose that in a second the electrometer reading is altered by p scale divisions, and that one scale division of the electrometer corresponds to a potential difference V between the quadrants, and that C is the capacity of the system consisting of the electrometer, the water surface and the connecting wires, then the quantity of electricity which passes in one second through the gas exposed to the rays is pVC . If n is the total number of ions positive as well as negative per cubic centimetre of the gas, u_0 the mean of the velocities of the positive and negative ions under a potential gradient of a volt per centimetre, E the potential gradient in volts per centimetre acting on the ionised gas, A the area of the

water surface, the current through the gas is equal to $Aneu_0E$; but as this current is equal to pVC , we have

$$pVC = Aneu_0E,$$

an equation by means of which we can determine ne , and as from the experiments on clouds we know the value of n we can at once deduce the value of e . Proceeding in this way the author found in 1898 that for the ions produced by Röntgen rays passing through air, using electrostatic units,

$$e = 6.5 \times 10^{-10} \text{ gr.}^{\frac{1}{2}} (\text{cm.})^{\frac{3}{2}} (\text{sec.})^{-1}.$$

A similar series of experiments on the ions produced by Röntgen rays passing through hydrogen gave for e the charge on the hydrogen ion the value

$$6.7 \times 10^{-10} (\text{gr.})^{\frac{1}{2}} (\text{cm.})^{\frac{3}{2}} (\text{sec.})^{-1}.$$

The difference between this and the value of the charge on the ion in air is much less than the error of experiment, so that the charges on the ions are the same in these gases. This was shortly afterwards confirmed by the experiments made by Townsend on the rates of diffusion of the ions; an account of these experiments has already been given in Chapter II.

75. The author in 1901-2 repeated these experiments on the charges carried by the ions, making some modifications in the method. In the first place, the ionisation was produced by the radiation from radium instead of by the Röntgen rays; this was done to get a more uniform rate of ionisation than is possible with Röntgen tubes, the irregularity of which gave a great deal of trouble in the earlier investigation. Secondly, the electrometer used in the new experiments was much more sensitive than the old one, the new electrometer was of the Dolezalek type and gave a deflection of 20,000 scale divisions for a potential difference of one volt.

The measurements made by C. T. R. Wilson* (see Chap. VII.) show that with expansions between 1.25 and 1.3 negative, and only negative, ions act as nuclei for cloudy condensation, while with expansions greater than 1.3 both negative and positive ions are brought down by the cloud. It was feared that when the expansions were sufficiently large to bring both sets of ions into play the more active negative ions might have a tendency to monopolise

* C. T. R. Wilson, *Phil. Trans.* cxciii. p. 289.

the aqueous vapour, and that therefore the whole of the positive ions might not be brought down with the cloud. This fear was found to be justified, for with the expansion apparatus used in the earlier experiments it was found that with expansions greater than 1.3 the number of particles in the cloud formed in the ionised gas was not, as it should have been if all the ions had been caught by the cloud, twice as great as when the expansion was less than this value. The apparatus was modified so as to make the rate of expansion very much more rapid than in the earlier experiments; with the new apparatus the number of particles in the cloud when the expansion was greater than 1.3 was twice as great as when the expansion was less than this value; this confirms the view that with this apparatus all the ions are caught by the cloud. The result of a number of determinations of e with the new apparatus, using different samples of radium and different intensities of radiation, was that

$$e = 3.4 \times 10^{-10} (\text{gr.})^{\frac{1}{3}} (\text{cm.})^{\frac{2}{3}} (\text{sec.})^{-1}.$$

76. Another method of finding e has been used by H. A. Wilson*. C. T. R. Wilson found that clouds could be deposited round negative ions by an expansion which was insufficient to produce condensation on positive ions. It is thus possible to adjust the expansion so as to get a cloud in which all the drops are negatively charged. H. A. Wilson arranged his experiment so that such a cloud was formed between two horizontal plates; these plates could be maintained at different electrical potentials so that a uniform field acted between the plates, this field acting on the charged drops produced a vertical force in addition to that due to the weight of the drop and so affected the rate of fall.

Let X be the vertical force, e the charge on the drop, v_1 the rate of fall of the drop under this force, and v the rate of fall when there is no electric field; then since the rate of fall is proportional to the force on the drop, if a is the radius of the drop, ρ its density

$$\frac{Xe + \frac{4}{3}\pi\rho ga^3}{\frac{4}{3}\pi\rho ga^3} = \frac{v_1}{v},$$

or
$$Xe = \frac{4}{3}\pi\rho ga^3 \frac{(v_1 - v)}{v}.$$

* *Phil. Mag.* vi. 5, p. 429, 1903.

But
$$v = \frac{2}{9} \frac{g\alpha^2\rho}{\mu},$$

so that
$$Xe = \sqrt{2} \cdot 9\pi \sqrt{\frac{\mu^3}{g\rho}} \frac{v^{\frac{3}{2}}(v_1 - v)}{v}.$$

Thus if X , v , and v_1 are known e can be determined.

By this method Wilson found $e = 3.1 \times 10^{-10}$ electrostatic units.

Wilson found that some of the drops in the cloud carried a charge $2e$ and others a charge $3e$.

Having found the value of e , let us compare it with E the charge carried by the hydrogen ion in the electrolysis of solutions. If N is the number of molecules in a cubic centimetre of a gas at a pressure of 760 mm. of mercury and at 0° C. then we know as the result of experiments on the liberation of hydrogen in electrolysis (see p. 77) that

$$NE = 1.22 \times 10^{10}.$$

In treatises on the Kinetic Theory of Gases (for example, O. E. Meyer, *Die kinetische Theorie der Gase*) it is shown how by the aid of certain assumptions as to the nature and shape of the molecules it is possible to find N . The values got in this way vary considerably, the best determinations of N lying between 2.1×10^{19} and 10^{20} ; this would make E lie between 6.1×10^{-10} and 1.29×10^{-10} ; the value of e is well between these limits. Hence we conclude that the charge carried by any gaseous ion is equal to the charge carried by the hydrogen ion in the electrolysis of solutions.

This conclusion is also confirmed by the experiments of Townsend already referred to. In these experiments the charges on the ions in air, hydrogen and carbonic acid gas were directly compared with E , and proved to be equal to it (see p. 77). Starting with this result we can by direct experiment on gases determine the value of E , and then by the aid of the equation

$$NE = 1.22 \times 10^{10},$$

the number of molecules in a cubic centimetre of the gas, and hence the mass of a molecule of the gas; proceeding in this way we avoid all those assumptions as to the shape and size of the

molecules of the gas, and the nature of the action which occurs when two molecules come into collision, which have to be made when the same quantities are determined by means of the Kinetic Theory of Gases. The value we have found for E makes

$$N = 3.9 \times 10^{19}.$$

77. The determinations of e described above have been made on ions produced by Röntgen or radium rays. The properties of the ions in gases are the same, however, whether the ions are produced by Röntgen, radium, Lenard, or cathode rays, or by the agency of ultra-violet light. Evidence in support of this is afforded by the fact that, as we have seen, the velocity of the ions in the electric field is the same in whichever of the above-mentioned ways they are produced. We shall see too (Chap. VII.) that they behave in exactly the same way with respect to their power of producing condensation of clouds. We have thus strong reasons for thinking that the charge on the ion does not depend upon the kind of radiation used to liberate the ion. I have made some direct experiments on this point, and have made measurements of the charge on the negative ions produced by the incidence of ultra-violet light on metals; the method used was the same as in the case of the ions produced by Röntgen rays, and the result was that within the limits of experimental error the charge on the negative ion produced by the action of ultra-violet light was the same as that on the ion produced by Röntgen rays*.

The case of the ions produced by ultra-violet light is interesting, as it is the one in which both the values of e and of e/m (when the pressure is low) have been measured when the ions are the same in the two experiments.

78. As e is the same as E the charge on the hydrogen ion, while e/m is about one thousand seven hundred times E/M , where M is the mass of the atom of hydrogen, it follows that m is only about 1/1700 of M , so that the mass of the carrier of the negative charge is only 1/1700 of that of the atom of hydrogen.

79. Let us now sum up the results of the determinations of e and of e/m which have been made for the ions produced in gases by radiations of different kinds. We have seen that in all the cases

* J. J. Thomson, *Phil. Mag.* v. 48, p. 547, 1899.

in which e has been determined it has been found equal to E , the charge on a hydrogen ion in liquid electrolysis. The charge on the gaseous ion does not, like that on the ions in liquids, depend on the substance from which the ions are produced; thus in the case of the ions produced by Röntgen or analogous radiation, the charge on an ion produced from oxygen is the same as that on one produced from hydrogen, though in liquids the charge on an oxygen ion is twice that on a hydrogen one.

Again, at very low pressures, when the negative ion can escape getting entangled with the molecules of the gas by which it is surrounded, the *mass* as well as the charge of the negative ion is invariable and much smaller than the mass of the smallest portion of ordinary matter, *i.e.* that of an atom of hydrogen, recognised in the Kinetic Theory of Gases. We shall call each of these small negative ions a *corpuscle*, thus negative electrification when the pressure of the gas is low so that there is only a very small quantity of ordinary matter present, consists of an assemblage of corpuscles.

On the other hand the positive ions are, as far as we know, always associated with masses which are comparable with the masses of the ordinary atoms of the gas in which they occur.

We are at once led by this result to a view of the nature of electricity which in many respects closely resembles that of the old 'One Fluid Theory of Electricity.' The 'electric fluid' corresponds to an assemblage of corpuscles, negative electrification consisting of a collection of these corpuscles: the transference of electrification from place to place being a movement of corpuscles from the place where there is a gain of positive electrification to the place where there is a gain of negative. Thus a positively electrified body is one which has been deprived of some corpuscles. These corpuscles may either remain free or get attached to molecules of matter with which they come in contact; thus positive electrification is always associated with ordinary matter, while negative electrification may or may not be, according as the corpuscles are or are not attached to molecules of ordinary matter. Thus in gas at very low pressures the corpuscles are free, but in gases at higher pressures they get attached to the molecules of the gas so that there is not much difference between

the effective masses of the positive and negative ions; that this is the case is indicated by the results of the experiments we have described on the velocities of the positive and negative ions in the electric field, for though the negative ion moves faster than the positive, the difference is not great. We shall return to the development of this corpuscular theory of electricity in a later chapter.

CHAPTER VII.

ON SOME PHYSICAL PROPERTIES OF GASEOUS IONS.

80. ONE of the most striking effects produced by ions is the influence they exert on the condensation of clouds. One instance of this is the discovery by R. von Helmholtz* of the effect of an electric discharge on a high pressure steam jet. When steam rushes out from a jet placed near a pointed electrode connected with an electric machine or an induction coil, a remarkable change in the appearance of the jet takes place when electricity is escaping from the electrode. This can conveniently be shown by throwing the shadow of the jet on a screen; when there is no escape of electricity the jet is nearly transparent and the shadow is very slight; as soon however as electricity begins to escape, the opacity of the jet increases to a remarkable extent, the shadow becomes quite dark and distinct, and colours arising from the diffraction of the light by the small drops of water make their appearance, the jet sometimes presenting a very beautiful appearance. For an account of the ways of arranging the experiments so as to observe these colours to the best advantage and of a method by which the size of the drops of water can be deduced from the colour phenomena, we must refer to a paper by Barus†. This effect evidently shows that the electrification makes the steam condense into water drops.

In a later paper by R. von Helmholtz and Richarz‡, published after the death of the former, the authors show that a steam jet is affected by making or breaking the current through the primary

* R. v. Helmholtz, *Wied. Ann.* xxxii. p. 1, 1887; see also Bidwell, *Phil. Mag.* v. 29, p. 158, 1890.

† Barus, *American Journal of Meteorology*, ix. p. 488, 1893.

‡ R. v. Helmholtz and Richarz, *Wied. Ann.* xl. p. 161, 1890.

of an induction coil, even when the terminals of the secondary placed in the neighbourhood of the jet are separated by much more than the sparking distance, and that the effects persist even when the terminals are wrapped in moist filter-paper so as to catch any metallic particles that might be given off from them.

R. von Helmholtz and Richarz (*loc. cit.*) showed that the steam jet was affected by gases from the neighbourhood of flames whether these were luminous or not; the very cool flames of burning ether and alcohol are exceptions to this statement.

A platinum wire raised to a dull red heat affected the jet when electrified, and if raised to a bright yellow heat affected the jet even when unelectrified, except when the wire was surrounded by hydrogen, in which case the unelectrified wire had no effect. Coal gas passed through platinum gauze raised to a dull red heat also influenced the jet.

The jet is also affected by the presence in its neighbourhood of certain substances such as sulphuric acid, also by gases which are dissociating or undergoing chemical changes in the air such as N_2O_4 or NO_2 , it is not affected by ozone or hydrogen peroxide. If however ozone is destroyed by bubbling through such substances as solutions of potassium iodide or potassium permanganate, the gas which emerges has the power of affecting the jet; this gas has also the power of forming clouds when it comes into contact with moist air, as was first shown by Meissner*; experiments on this point have also been made by R. von Helmholtz and Richarz and by J. S. Townsend†. The action in this case and in other cases of the effect of chemicals is, as we shall see, probably due to the formation of some substance which dissolves in the drops of water and lowers their vapour pressure; thus the drops in this case are not formed of pure water, but of more or less dilute solutions.

Moist air drawn over phosphorus, sodium or potassium also affects the jet.

Lenard and Wolff‡ also showed that the incidence of ultra-

* Meissner, *Jahresber. f. Chemie*, 1863, p. 126.

† J. S. Townsend, *Proc. Camb. Phil. Soc.* x. p. 52, 1898.

‡ Lenard and Wolff, *Wied. Ann.* xxxvii. p. 443, 1899.

violet light on a zinc plate or on some fluorescent solutions in the neighbourhood of a steam jet produced condensation in the jet; a similar effect was produced by ultra-violet light passing through quartz. Richarz* showed that the incidence of Röntgen rays produced condensation in the jet. There was for some time considerable difference of opinion as to the cause of this behaviour of the steam jet; the earliest researches on this subject came at a time when the experiments of Aitken†, of Coulier‡ and of Kiessling§ had drawn attention to the great effect produced by dust on cloudy condensation. These physicists had shown that the clouds produced by the lowering of temperature resulting from a small adiabatic expansion of the damp dusty air of an ordinary room entirely disappeared if the dust were filtered out of the air: the drops in the cloud were shown to collect round the particles of dust, the water drops were thus able to start with a finite radius—that of the dust particle—and so had not to pass through the stage when their radius was of molecular dimensions, when, as Lord Kelvin has shown, the effect of surface tension would lead to such intense evaporation as soon to cause the disappearance of the drops.

The discovery of the effect of dust on the condensation of water vapour produced a tendency to ascribe the formation of clouds in all cases to dust and to dust alone; in fact, to use the indication of the steam jet as a measure of the dustiness of the air; thus, for example, Lenard and Wolff ascribed the effect which they found was produced by the incidence of ultra-violet light on metals to metallic dust given off by the metal under the influence of the light. On the other hand, R. von Helmholtz, and later Richarz, strongly maintained the view that many of the effects they observed were not due to dust, but to ions, and they gave strong arguments and made some striking experiments in support of this view: as however this evidence is somewhat indirect, and as the truth of their view has been indisputably proved by the direct experiments recently made by

* Richarz, *Wied. Ann.* lix. p. 592, 1896.

† Aitken, *Nature*, xxiii. pp. 195, 384, 1880. *Trans. Roy. Soc. Edin.* xxxiii. p. 337, 1881.

‡ Coulier, *Journal de Pharm. et de Chimie*, xxii. p. 165, 1875.

§ Kiessling, *Naturw. Verein Hamburg-Altona*, viii. 1, 1884.

C. T. R. Wilson*, we shall proceed at once to a description of his researches.

81. The method used by Wilson was to suddenly cool the moist gas by an adiabatic expansion, so that the gas which was saturated with water vapour before cooling became supersaturated afterwards. One of the arrangements used by Wilson to produce

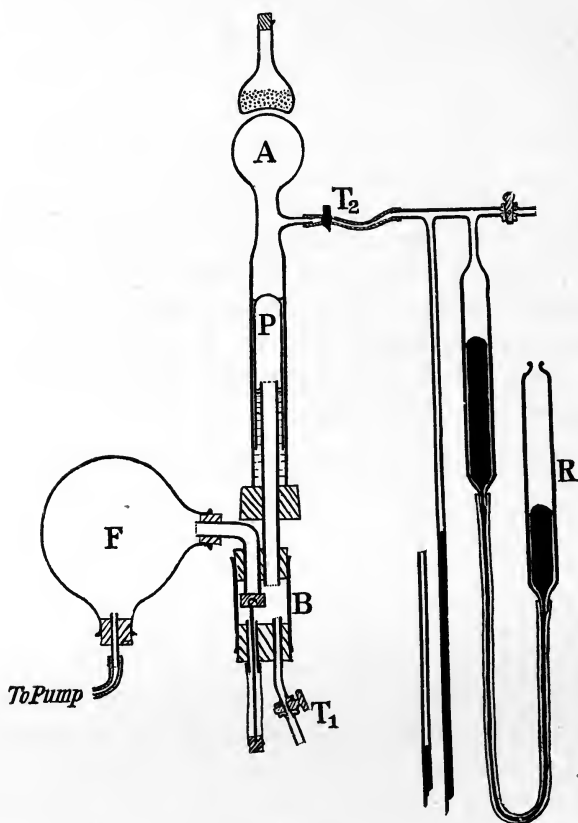

Fig. 36.

the expansion is shown in Fig. 36: the way in which the apparatus works has already been explained (see p. 154). It is very important in these experiments that the expansions which produce the cloud should be as rapid as possible, for with slow expansions

* C. T. R. Wilson, *Phil. Trans.* 189, p. 265, 1897.

as soon as the supersaturation is sufficient for the first drops to be formed, if these have time to grow before the expansion is completed, they will rob the air of its moisture, and the supersaturation will not rise much above the value required for the formation of the first drops. To ensure this rapid expansion, the piston *P*, Fig. 36, should be light and able to move freely up and down, and the arrangement by which the difference of pressure between the inside and outside of the cylinder is produced should work very rapidly.

82. Using an arrangement of this nature, Wilson found that when dusty air filled the expansion chamber a very slight expansion was sufficient to produce a dense fog; if this was allowed to settle and the process repeated, the air by degrees got deprived of the dust which was carried down by the fog; when the air became dust-free no fogs were produced by small expansions. If we take as the measure of the expansion the ratio of the final to the initial volume of the gas, no cloud was produced in the dust-free air until the expansion was equal to 1.25. When the expansion was between 1.25 and 1.38, a few drops made their appearance; these drops were very much fewer in hydrogen than in air. On increasing the expansion beyond 1.38 a much denser cloud was produced in the dust-free gas, and the density of the cloud now increased very rapidly with the expansion. Thus we see that even when there is no dust, cloudy condensation can be produced by sudden expansions if these exceed a certain limit. This limit appears to be independent of the nature of the gas, as is shown by the following table, which gives the ratio of the

Gas	Rain-like condensation		Cloud-like condensation	
	Final/initial volume	Super-saturation	Final/initial volume	Super-saturation
Air	1.252	4.2	1.375	7.9
Oxygen	1.257	4.3	1.375	7.9
Nitrogen	1.262	4.4	1.375	7.9
Hydrogen ...	—	—	1.375	7.9
Carbonic acid	1.365	4.2	1.53	7.3
Chlorine	1.30	3.4	1.44	5.9

volumes required to produce the first or rain-like stage of condensation and the supersaturation, *i.e.* the ratio of the pressure

of the aqueous vapour actually present when the condensation begins to the saturation vapour pressure at that temperature: the third and fourth columns give the corresponding quantities for the second stage of the condensation, *i.e.* when the expansion produces a dense cloud.

The rain-like condensation is absent in hydrogen.

83. The description given above relates to the behaviour of gas in the normal state; on exposing the gas to Röntgen rays, Wilson found that, as in the normal gas, there were no drops until the expansion was equal to 1.25; on passing this limit however the density of the cloud was very greatly increased by the rays, and if these were strong the few drops which were all that were formed when the rays were absent were replaced by a dense and almost opaque cloud. The strength of the rays does not affect the expansion required to produce the cloud; no matter how strong the rays may be there is no cloud produced unless the expansion exceeds 1.25: the strength of the rays increases the number of drops in the cloud, but does not affect the stage at which the cloud begins. The effect of the rays in producing a cloud lasts some few seconds after the rays have been cut off. Wilson* has shown that the radiation from uranium and other radio-active substances produces the same effect as Röntgen rays, as does also ultra-violet light when incident upon such a metal as zinc: the effects produced by ultra-violet light are however somewhat complicated and we shall have to return to them again.

84. That the effect produced by Röntgen and uranium rays is due to the production of charged ions produced in the gas can be shown directly by the following experiment. If the ions produced by the Röntgen rays act as nuclei for the water drops, then since these ions can be withdrawn from the gas by applying to it a strong electric field, it follows that a cloud ought not to be formed by the rays when the air which is expanded is exposed to a strong electric field while the rays are passing through it. This was found to be the case, and the experiment is a very striking one. Two parallel plates were placed in the vessel containing the dust-free air; these plates were about 5 cm. apart, and were large enough to include the greater part of the air between them†. The

* C. T. R. Wilson, *Phil. Trans.* 192, p. 403, 1899.

† J. J. Thomson, *Phil. Mag.* v. 46, p. 528, 1898.

plates could be connected with the terminals of a battery of small storage cells giving a potential difference of about 400 volts. Röntgen rays passed through the gas between the plates; the gas had previously been freed from dust. When the plates were disconnected from the battery a suitable expansion produced a dense cloud; when however the plates were connected with the battery only a very light cloud was produced by the expansion, and this cloud was almost as dense when the Röntgen rays did not pass through the air as when they did.

85. When a dense cloud has been produced by Röntgen rays by an expansion between 1.25 and 1.38, or by an expansion without Röntgen rays greater than 1.38, then for some little time after drops can be produced by expansions less than 1.25, and these are not eliminated by the action of an electric field. A dense fog apparently leaves behind it little drops of water, which, though too minute to be visible, act in the same way as particles of dust, producing cloudy condensation with very slight expansions. Wilson* has also shown that when electricity is discharged from a pointed electrode in the expansion chamber, cloudy condensation is, as in the case of exposure to Röntgen rays, much increased for expansions between 1.25 and 1.38. When the discharge was stopped before the expansion took place, it was found that fogs could be produced for 1 or 2 minutes after the cessation of the discharge; the expansion required to produce the fog diminished as the interval after the cessation of the discharge increased, showing that some of the nuclei produced had grown during this interval. This effect is probably due to the formation of some chemical compound during the discharge, perhaps nitric acid, which by dissolving in the drops lowers their vapour pressure.

86. Wilson (*loc. cit.*) showed that the passage of ultra-violet light through a gas (as distinct from the effects produced when it is incident on a metallic surface) produces very interesting effects on the condensation of clouds. If the intensity of the light is small, then no clouds are produced unless the expansion equals that (1.25) required to produce clouds in gases exposed to Röntgen rays. If however the ultra-violet light is very intense, clouds are produced in air or in pure oxygen, but not in hydrogen, by very

* C. T. R. Wilson, *Phil. Trans.* 192, p. 403, 1899.

much smaller expansions, and the expansion required decreases as the time of exposure to the light increases; thus the nuclei producing the clouds grow under the influence of the light. If the light is exceedingly strong, clouds are produced in air or oxygen without any expansion at all; these clouds are exceedingly fine and may last for hours after the light is cut off. Wilson was even able to produce these clouds in air standing over a 17% solution of caustic potash, and which therefore was not saturated with water vapour; in this case the drops lasted for three hours after the light was cut off, so that there could be very little evaporation from the drops; this, as Wilson points out, shows that the drops cannot be pure water. These clouds are probably analogous to those observed many years ago by Tyndall*, when ultra-violet light passes through air containing the vapours of certain substances of which amyl-nitrite was the one which gave the most striking effects. The effects can be explained by the formation under the influence of the ultra-violet light of some substance—Wilson suggests that in his experiments it was H_2O_2 —which by dissolving in the drops as they form lowers the equilibrium vapour pressure, and thus enables the drops to grow under circumstances which would make drops of pure water evaporate. This explanation is supported by the fact that ultra-violet light does not produce these clouds in water vapour by itself or in hydrogen: and also by the fact that, unlike the clouds due to Röntgen rays, these clouds formed by ultra-violet light do not diminish in density when a strong electric field is applied to the gas, showing that the nuclei are either not charged or that if they are charged they are so loaded with foreign molecules that they do not move perceptibly in the electric field. Vincent† has observed movements of these drops in a strong electric field; he found that some drops moved in one, others in the opposite direction, while there were some which did not move at all. Thus some drops are uncharged, others positively or negatively charged. It would thus seem that the charges have nothing to do with the formation of these drops, the drops merely forming a home for the ions produced by the ultra-violet light.

87. Buisson‡, who examined this question with great care, could

* J. Tyndall, *Phil. Trans.* 106, p. 333, 1870.

† Vincent, *Proc. Camb. Phil. Soc.* xii. p. 305, 1904.

‡ Buisson quoted by Perrin, *Thèses présentées à la Faculté des Sciences de Paris*, p. 31, 1897.

not detect any conductivity in the air through which the ultra-violet light passed. Lenard* has however shown recently that a certain kind of ultra-violet light which is absorbed so quickly by the air as to be extinguished, when the air is at atmospheric pressure, within a space of a few centimetres, does produce electrical conductivity in the gas through which it passes, and that a charged conductor placed in the neighbourhood of air traversed by these rays loses its charge, and does so much more rapidly when the charge is positive than when it is negative. Lenard determined the velocity of the negative ions by a method analogous to that described on page 49 and found this velocity through air at atmospheric pressure to be 3.13 cm./sec. under a potential gradient of a volt per cm.: this is about twice the velocity of the ions produced by Röntgen rays; on the other hand the velocity of the positive ions under the same potential gradient was not more than .0015 cm./sec., which is only about one thousandth part of the velocity of the positive ion produced by Röntgen rays. The greater mobility of the negative ions explains why the leak from a positively charged body in the neighbourhood of the ionised gas is so much more rapid than that from a negatively charged one. We shall return to this point in the chapter on the effect of ultra-violet light on gases.

88. The results obtained by Wilson and Lenard seem to point to the conclusion that when gas is exposed to the action of ordinary ultra-violet light, we have some chemical action taking place, resulting in the formation of a product which by dissolving in water lowers the vapour pressure over the drops and thus facilitates their formation. When these drops are exposed to the influence of ultra-violet light of the kind investigated by Lenard, they lose, as so many other bodies do when illuminated by light of this kind, negative electricity, and it is the negative ions liberated in this way which produce the electrical conductivity investigated by Lenard. The difference between the action of ultra-violet light and Röntgen rays is that the former when very intense can produce clouds with little or no expansion, while the latter cannot; this on the theory given above is due to ultra-violet light being more efficient than Röntgen rays in promoting chemical action; there are many examples of this, *e.g.* the combination of hydrogen and chlorine.

* Lenard, *Ann. der Phys.* i. p. 486; iii. p. 298, 1900.

The influence of minute traces of soluble substances in promoting the formation of clouds has been shown in a very straightforward way in some experiments made by H. A. Wilson*. The writer† has shown how drops, even if their existence is very transient, would facilitate the progress of chemical combination between the gases surrounding them, and how this action would afford an explanation of the remarkable fact investigated by Baker‡ and Pringsheim§, that the occurrence of some of the best known cases of chemical combination between gases depends upon the presence of moisture and does not take place in gases dried with extreme care.

89. *Nuclei from metals.* C. T. R. Wilson|| has shown that certain metals produce nuclei which cause cloudy condensation when the expansion exceeds 1·25, although the effects are much more marked when the expansion is increased to 1·30. The amount of this effect depends greatly upon the kind of metal used: amalgamated zinc gives comparatively dense clouds, polished zinc and lead also show the effect well; on the other hand polished copper and tin produce no appreciable effect. The order of the metals in respect to their power of producing nuclei for cloudy condensation is the same as their order in respect to their power of affecting a photographic plate placed at a small distance from their surface, a subject which has been studied by Russell¶ and Colson**. The effect produced by the presence of a metal on clouds in hydrogen is very slight.

Although the expansion required to produce cloudy condensation when metals are present is the same as when charged ions are produced by Röntgen rays, the metal effect differs from the Röntgen ray effect inasmuch as it is not diminished by the application of an intense electric field. It is possible however that in still air the ionised gas is confined to a layer close to the surface of the metal, and that the rush of gas caused by the sudden expansion detaches the layer and scatters the ions throughout the

* H. A. Wilson, *Phil. Mag.* v. 45, p. 454, 1898.

† J. J. Thomson, *Phil. Mag.* v. 36, p. 313, 1893; *B. A. Report*, 1894.

‡ Baker, *Phil. Trans.* 179, p. 571, 1888.

§ Pringsheim, *Wied. Ann.* xxxii. p. 384, 1887.

|| C. T. R. Wilson, *Phil. Trans.* 192, p. 403, 1899.

¶ Russell, *Proc. Roy. Soc.* lxi. p. 424, 1897; lxiii. p. 102, 1898.

** Colson, *Comptes Rendus*, 123, p. 49, 1896.

volume of the gas. If this be the case, then, since the ions are only free during the short time the expansion is taking place, they will not be appreciably affected by the electric field, which cannot in the short time at its disposal sweep the ions from the gas. The existence of such a layer of ionised gas next the metal is rendered very probable by the effects which are known to accompany the splashing of drops of water, mercury and many other liquids. Thus Lenard* showed that when drops of water splashed against a metal plate, the drops of water became positively electrified while there was negative electrification in the surrounding air. Air shaken up in a bottle containing mercury becomes negatively electrified. Lord Kelvin† has shown that when air is bubbled through water it comes off charged with negative electricity. I have recently found that if the air is made to bubble with great vigour through water then when it leaves the water it contains positive as well as negative ions, though the latter are the more numerous; air treated in this way was found to discharge a body with a negative charge, though not so rapidly as one with a positive one. As another illustration of electrification produced by an agitation at the surface of water we may mention that Holmgren‡ has shown that when two wet cloths are brought together and then pulled suddenly apart electrification is produced, the positive electrification being on the cloth, the negative in the air. He also found that when the area of a water surface was changing rapidly, as for example when ripples were travelling over the surface, electrification was produced, the positive electricity being on the water and the negative in the air. The writer found§ that when the liquids were surrounded by pure hydrogen instead of air, the electrification produced by splashing was exceedingly small: Wilson, as has already been stated, found that the effect produced by metals on cloudy condensation was exceedingly small in hydrogen. These facts are sufficient to show that the exposure of a fresh surface of many substances is accompanied by the spread of ions through the adjoining gas. This would naturally result in the formation of a double layer of electrification at the

* Lenard, *Wied. Ann.* xvi. p. 584, 1892.

† Lord Kelvin, *Proc. Roy. Soc.* lvii. p. 335, 1894.

‡ Holmgren, *Sur le Développement de l'Électricité au contact de l'air et de l'eau. Société physiographique de Lond.* 1894.

§ J. J. Thomson, *Phil. Mag.* v. 37, p. 341, 1894.

surface, and it is possible that one of the coatings of this layer might be removed by the rush of air when the expansion takes place.

We know too that metals emit radiation which can ionise a gas, and that part of this radiation is rapidly absorbed by the gas, so that the ionised layer produced by it would be very thin. It is important to notice that if this layer of ionised gas were very close to the surface of the metal, the ions in it would not be dispersed into the surrounding gas even though the metal were charged up so as to produce an electric field of very considerable strength. For suppose we have a charge e at a point P at a distance r from a plane conducting surface, then there will, in consequence of the electricity of opposite sign induced on the plane, be a pull on the charge at P towards the plane equal to $e^2/4r^2$; if there is an external field of strength F tending to make the charged body move away from the plane, this will not be able to overcome the attraction towards the plane unless $F e$ is greater than $e^2/4r^2$, or F greater than $e/4r^2$. Let us suppose e is equal to the charge on an ion, 3.4×10^{-10} in electrostatic units, and that the strength of the electric field is 100 volts per centimetre, which on the electrostatic system is equal to $\frac{1}{3}$, then we see that the force on the ion in this strong field will be towards the plate, *i.e.* the ion will not be driven into the surrounding gas if r is less than 1.6×10^{-5} ; we see from this example that it must be exceedingly difficult to detach very thin layers of ionised gases by electrical means.

90. The few nuclei that produce rain-like condensation with expansions between 1.25 and 1.38 in gases not exposed to any external ionising agent arise from the ionisation which as we have seen is present in all gases shut up in closed vessels. In his earlier experiments Wilson was not able to detect any diminution in the number of drops when the expansion took place in a strong electric field. In some later experiments (*Phil. Mag.* June, 1904) in which he used very much larger vessels he was able to show that an electric field produced a great diminution in the number of nuclei. The absence of this diminution in the small vessels is due to the great diminution in the number of free ions produced by their diffusion to the walls of the vessel, the diffusion producing much greater effect in small than in large vessels. This reduction in the number of the ions not only makes variation in their number

more difficult to detect on account of the rapidity with which the big drops formed round them fall, but it also enables very weak electric fields to remove them from the vessel, so that in small vessels small accidental differences of potential might have produced saturation before the external field was applied.

Comparative efficiency of positive and negative ions in producing condensation of clouds.

91. The writer* in 1893 made an experiment with a steam jet which showed that negative electrification had a decidedly greater effect in promoting condensation than positive. The following arrangement was used. A vertical glass tube dipped into the steam chamber, and to the top of this tube was fused a horizontal cross-piece, the steam issued from nozzles at the ends of the cross-piece; into these nozzles pointed platinum wires were fused, and these wires were connected with the terminals of a small induction coil. When the coil was in action there was great condensation in the two jets, but the jet at the nozzle connected with the negative terminal of the coil was always denser than that connected with the positive; this was not due to any want of symmetry in the tubes or differences in the nozzles, for on reversing the coil the denser cloud passed from one nozzle to the other. No sparks passed between the platinum electrodes, the strength of the coil being only sufficient to give a non-luminous discharge from their points.

Later in 1898† I observed indications of a similar effect when clouds were produced by expansion, but the subject was first systematically investigated by C. T. R. Wilson‡ in 1899. Wilson investigated the amount of expansion required to make positive and negative ions act as nuclei for the condensation of water drops; he used several methods, the arrangement of the apparatus in one of these is shown in Fig. 37. The vessel in which the clouds were observed was nearly spherical and about 5·8 cm. in diameter. It was divided into two equal chambers by a brass partition (about 1 mm. thick) in the equatorial plane; the vessel was cut in two and the edges of the two halves ground smooth, to

* J. J. Thomson, *Phil. Mag.* v. 36, p. 313, 1893.

† J. J. Thomson, *Phil. Mag.* v. 46, p. 528, 1898.

‡ C. T. R. Wilson, *Phil. Trans.* 193, p. 289, 1899.

allow them to be easily cemented against the face of the partition. The latter was circular and had a narrow strip of brass soldered to each face extending all round the circumference except for a gap at the top. When the halves of the glass vessel were cemented against these strips, a slit was left at the gap about 4.5 cm. long

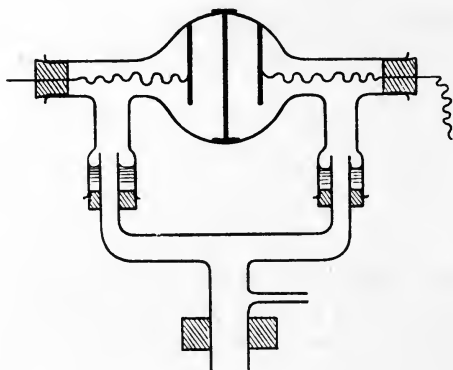

Fig. 37.

and 2.5 mm. wide on each side of the partition. This slit was covered with a thin piece of aluminium cemented to the outer surface of the glass and to the edge of the brass partition. A thin layer of air in contact with each surface of the partition could thus be exposed to Röntgen rays from a source vertically over the dividing plate. Each half of the apparatus contained a second brass plate parallel to the central plate and 1.8 cm. from it. There was room between the sides of these plates and the walls of the vessel for the air to escape when the expansion was made. To keep the beam of Röntgen rays parallel to the surface of the partition a lead screen with a slit 4 mm. wide was placed about 2 cm. above the aluminium window of the glass vessel: this screen was moved until when both plates were kept at the same potential exactly equal fogs were obtained on the two sides. The metal plates were covered with wet filter-paper to get rid of any ions due to the metal. Suppose now that the middle plate is earthed while the left-hand plate is at a lower and the right-hand plate at a higher potential. Then it is evident since the ionisation is confined to a layer close to the middle plate that under these circumstances the left half of the vessel will contain positive ions and the right half negative ones. Wilson

found that with an expansion of 1·28 there was a dense fog in the half containing the negative ions, and only a few drops in the half containing the positive ones, and that this excess of condensation in the negative half continued until the expansion was equal to 1·31, when little or no difference was to be seen in the clouds in the two halves. Care was taken that the potential of the positive plate should exceed that of the middle one by the same amount as this exceeded the potential of the negative plate.

The difference between the effects produced by positive and negative ions is shown in the following table, where the time of fall of the drops is used to measure the number of nuclei which

Expansion	Left side	Right side	Ratio of times negative/positive
1·28	positive 5 negative 15	negative 16 positive 3	$\left. \begin{matrix} 3\cdot2 \\ 5\cdot0 \end{matrix} \right\} 4\cdot1$
1·30	negative 15 positive 5 negative 10 positive 2	positive 2 negative 15 positive 2 negative 10	$\left. \begin{matrix} 7\cdot5 \\ 3\cdot0 \\ 5\cdot0 \\ 5\cdot0 \end{matrix} \right\} 5\cdot1$
1·31	positive 7 negative 14	negative 12 positive 7	$\left. \begin{matrix} 1\cdot7 \\ 2\cdot0 \end{matrix} \right\} 1\cdot8$
1·32	negative 8 positive 8 negative 14 positive 12	positive 5 negative 10 positive 8 negative 17	$\left. \begin{matrix} 1\cdot6 \\ 1\cdot2 \\ 1\cdot7 \\ 1\cdot4 \end{matrix} \right\} 1\cdot5$
1·33	negative 12 positive 12	positive 10 negative 13	$\left. \begin{matrix} 1\cdot2 \\ 1\cdot1 \end{matrix} \right\} 1\cdot15$
1·35	negative 10 positive 10	positive 10 negative 10	$\left. \begin{matrix} 1\cdot0 \\ 1\cdot0 \end{matrix} \right\} 1\cdot0$

produce condensation; if this number is small, then the water drops formed round them will be large and will therefore fall rapidly, while if the number of nuclei be large, since there is only the same quantity of water to be distributed among them, the drops will be small and will fall slowly. In the experiments referred to in the table there was a potential difference equal to that due to two Leclanché cells between the middle plate and either of the outer ones. The words positive and negative

in the table indicate that the positive or negative ions respectively were in excess in the region referred to.

The difference in the rates of fall of the drops with the same expansions is due to irregularities in the action of the bulb used to produce the Röntgen rays. The negative ions begin to act as nuclei for foggy condensation when the expansion is about 1.25, corresponding to about a fourfold supersaturation, while we see from the table that the positive ions do not begin to act as nuclei until the expansion is equal to 1.31, corresponding to about a sixfold supersaturation. Wilson has shown that all the negative ions are caught when the expansion is equal to 1.28, but that it is not until the expansion reaches 1.35 that all the positive ions are caught. This is not due to the negative ions having a larger electrical charge than the positive; to show this take an expansion vessel such as that shown in Fig. 36 and ionise the gas in it by Röntgen rays; first produce a fog with an expansion of 1.28 (which only brings down the negative ions), and determine the number of ions from the time of fall in the way already explained; then with the same intensity of radiation produce a cloud by an expansion of 1.35, which brings down both the positive and negative ions, and again calculate the number of ions; we shall find it twice as great as in the first case, thus showing that the numbers of positive and negative ions are equal. As the gas as a whole has no charge, the total charge on the positive ions must be equal to that on the negative, hence as there are as many positive ions as negative, the charge on a positive ion must be the same as that on a negative one. We shall return to the origin of the greater efficiency of the negative than of the positive ions when we discuss the theory of the action of ions in promoting condensation. In the meantime we may point out that this difference between the ions may have very important bearings on the question of atmospheric electricity, for if the ions were to differ in their power of condensing water around them, then we might get a cloud formed round one set of ions and not round the other. The ions in the cloud would fall under gravity, and thus we might have separation of the positive and the negative ions and the production of an electric field, the work required for the production of the field being done by gravity*.

* J. J. Thomson, *Phil. Mag.* v. 46, p. 528, 1898.

An action of this kind would tend to make the charge in the air positive, as more negative ions than positive would be carried down by water drops: for a further consideration of this effect we may refer the reader to the papers by Elster and Geitel* on the ionic theory of atmospheric electricity.

Theory of the effect of ions on Condensation.

92. The effect of electrification on the evaporation of drops of water was investigated by the writer in *Applications of Dynamics to Physics and Chemistry*, p. 165. The general tendency of this effect can easily be seen from elementary principles: for if we have a drop of water of radius a , carrying a charge e of electricity, its potential energy is equal to $\frac{1}{2}e^2/Ka$, where K is the specific inductive capacity of the dielectric surrounding the drop. Now as the drop evaporates the electricity remains behind, so that e does not change while a diminishes, hence the potential energy due to the electrification of the drop increases as the drop evaporates; thus to make the charged drop evaporate more work has to be available than when it is uncharged, so that electrification will diminish the tendency of the drop to evaporate, and the drop will be in equilibrium when the vapour pressure of the water vapour around it would not be sufficient to prevent the evaporation of an uncharged drop. The surface tension of the water will, as was shown by Lord Kelvin, produce the opposite effect; for the potential energy due to the surface tension is equal to $4\pi a^2 T$, where T is the surface tension; thus as the drop evaporates the energy due to surface tension diminishes, so that the work required to vaporise a given quantity of water in a spherical drop is less than if surface tension were absent or inoperative, as it would be if the surface were flat. Thus a curved drop will evaporate when a flat one would be in equilibrium.

It is shown in *Applications of Dynamics to Physics and Chemistry*, p. 165, that when δp , the change in the vapour pressure due to the electrification and surface tension, is only a small fraction of the original vapour pressure p ,

$$\frac{\delta p}{p} = \frac{1}{R\theta} \frac{1}{4\pi a^2} \frac{d}{da} \left(4\pi T a^2 + \frac{e^2}{2Ka} \right) \frac{1}{\sigma - \rho} \dots\dots\dots(1);$$

* Elster and Geitel, *Physikalische Zeitschrift*, i. p. 245, 1900.

or when T does not vary with a

$$\frac{\delta p}{p} = \frac{1}{R\theta} \left\{ \frac{2T}{a} - \frac{e^2}{8\pi K a^4} \right\} \frac{1}{\sigma - \rho};$$

σ is the density of water, ρ that of the vapour, θ the absolute temperature, R the constant which occurs in the equation for a 'perfect' gas, $p = R\theta\rho$; in the investigation this equation is assumed to hold for the water vapour. When the change in the pressure is not a small fraction of the equilibrium vapour pressure for an infinitely large drop, then the investigation already alluded to shows that the preceding equation has to be replaced by

$$R\theta \log_e \frac{p}{P} + \frac{R\theta(\rho' - \rho)}{\sigma} = \left(\frac{2T}{a} - \frac{e^2}{8\pi K a^4} \right) \frac{1}{\sigma},$$

where p and ρ are the equilibrium vapour pressure and density for a drop of radius a , P and ρ' the corresponding quantities for a drop of infinite radius. Since $\rho' - \rho$ is exceedingly small compared with σ , this equation becomes approximately

$$R\theta \log_e \frac{p}{P} = \left(\frac{2T}{a} - \frac{e^2}{8\pi K a^4} \right) \frac{1}{\sigma} \dots\dots\dots(2).$$

We see from this equation that if e is zero the equilibrium vapour pressure p for a drop of finite size is always greater than P , so that such a drop would evaporate unless the vapour around it were supersaturated; when however the drop is electrified this is no longer the case, for we see from equation (1) that in this case if the vapour is saturated, *i.e.* if the vapour pressure is P , the drop will grow until its radius a is given by the equation

$$\frac{2T}{a} - \frac{e^2}{8\pi K a^4} = 0.$$

Thus if the drop were charged with the quantity of electricity carried by a gaseous ion, *i.e.* 3.4×10^{-10} electrostatic units, and if the surface tension of the small drop was equal to 76, which is the value for thick water films, then a would be equal to $1/3.2 \times 10^7$, and thus each gaseous ion would be surrounded by a drop of water of this radius; if we call this radius c , then equation (2) may be written

$$R\theta c \log_e \frac{p}{P} = 2Tx(1 - x^2) \dots\dots\dots(3),$$

where $x = c/a$. This equation enables us to find the size of a drop corresponding to any vapour pressure.

For water vapour at 10°C ., $R\theta$ is equal to 1.3×10^9 . Putting for c the value previously found and $T = 76$, equation (3) becomes approximately

$$.27 \log_e \frac{p}{P} = x(1 - x^2) \dots \dots \dots (4).$$

From this equation we see that even in a space far from saturated with water vapour, *i.e.* when p is only a fraction of P , drops will be formed, and that the size of these drops diminishes only very slowly as the quantity of water vapour in the surrounding air diminishes; thus if we diminish the quantity of water vapour in the air to $1/e$, *i.e.* $1/2.7$ of that required to saturate it, we see from equation (3) that the radius of the drops formed round the ions would only be a little less than $10/11$ of the radius of the drop formed in saturated air: and that to reduce the drop to half the radius corresponding to saturation, we should have to dry the air so completely that p/P was only about $1/3 \times 10^{16}$. We have seen that there are always some ions in the air, hence if there is any water vapour in the air some of it will be condensed into fine drops. It has been suggested that these drops play a part in certain cases of chemical combination, the preceding numerical example will show the difficulty of getting the gas dry enough to produce a substantial reduction in the volume of these charged drops.

Supersaturation required to make one of the charged drops grow to a large size.

93. As the radius of the drop increases from c to an infinite size, x diminishes from unity to zero. Now the right-hand side of equation (4) vanishes at each of these limits, but between them it reaches a maximum value which occurs when $4x^3 = 1$ or $x = \frac{1}{1.58}$, when $x(1 - x^2)$ reaches the value .471; hence we see from equation (3) that for the drops to increase to a large size $\log_e p/P$ must reach the value 1.7 approximately. Hence for the drops to grow p/P must be about 5.3: this, on the theory we have given, is the amount of supersaturation required to make large drops grow round the ions. We have seen from Wilson's experiment that it actually requires a four-fold supersaturation, but as in the theory the saturated water vapour was assumed to obey Boyle's law, and the surface tension was assumed to have the value it has for thick films, neither of which assumptions

is likely to be true, the agreement between the theory and the experiments is as close as could be expected.

94. Wilson showed that even when there is no external ionisation, a dense cloud the nuclei of which are not charged is produced by an eight-fold supersaturation: we can by the aid of equation (2) determine the radii of these nuclei, supposed spherical; putting in that equation $e = 0$, $T = 76$, $R\theta = 1.3 \times 10^9$, and $p/P = 8$, we find that a , the radius of the nucleus which produces this kind of condensation, is equal to $1/1.9 \times 10^7$. This nucleus is thus slightly *larger* than the drop which collects round an ion, as we found that the radius of this drop is $1/3.1 \times 10^7$. With regard to the nature of the nuclei which produce the cloud corresponding to the eight-fold supersaturation, Wilson has proved that the amount of supersaturation required to produce the cloud is the same in air, oxygen, hydrogen, and carbonic acid; the size of the nuclei is therefore the same in all these gases; it is thus very improbable that they consist of aggregations of the molecules of the gas; it would seem most likely that they are minute drops of water which are continually being formed from the saturated vapour and then evaporating, but lasting sufficiently long to enable them to be caught during the sudden expansion, and to act as the nuclei round which the drops in the cloud condense. These minute drops of water are not however all of the same size, for after passing the expansion 1.38 the density of the cloud increases very rapidly as the expansion increases, showing that many more nuclei become efficient when the expansion increases. This behaviour of the cloud indicates that there are little drops of water of different sizes, the small ones being more numerous than the larger ones, and that there is a fairly definite limit to the size of the drop, the number of drops whose size exceeds this limit being too small to produce an appreciable cloud. This collection of drops of different sizes is what we might expect if we regard the little drops as arising from coalescence of molecules of water vapour, and the larger drops from the coalescence of the smaller ones.

95. The fact that the drops are of different sizes indicates that they are not in a state of equilibrium with regard to evaporation and condensation, and the drops have probably a very ephemeral existence. The following considerations show that on the view of

the relation between surface tension and the thickness of water films, to which Reinold and Rucker were led by their experiments on very thin films, drops of pure water of a definite radius might be in equilibrium with saturated water vapour even if they were not charged.

Effect on the condensation of variation of Surface Tension with the radius of the drop.

96. When a liquid film gets very thin its surface tension no longer remains constant but depends upon its thickness. For very thin films theory indicates (see Lord Rayleigh, *Phil. Mag.* v. 33) that the surface tension would be proportional to the square of the thickness, while the experiments of Reinold and Rucker show that the surface tension has a maximum value for a thickness comparable with that of the dark spot in soap films; more recent experiments by Johannot have made it probable that, considering the surface tension as a function of the thickness there is more than one maximum. Taking for simplicity the case when there is only one maximum the relation between the surface tension and the thickness is represented by a curve of the character of Fig. 38, the ordinates representing the surface tension, and the abscissa the thickness.

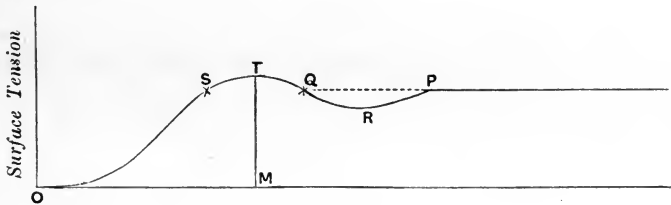

Fig. 38.

When the surface tension varies with the radius of the drop equation (1) becomes

$$\sigma R \theta \log_e \frac{P}{p} = \frac{2T}{r} + \frac{dT}{dr} - \frac{e^2}{8\pi K r^4} \dots \dots \dots (5).$$

From Fig. 39, taking r to represent the thickness of the film, we see that when $r = 0$, $\frac{2T}{r} + \frac{dT}{dr}$ vanishes, and that this quantity will attain a maximum and then diminish as r increases; we shall take the case when it goes on diminishing until it vanishes and changes sign. Then $\frac{2T}{r} + \frac{dT}{dr}$ will be represented by a curve of the type of Fig. 39.

Let us first take the case when the drop is unelectrified. Equation (5) shows that the radius of a drop when the vapour

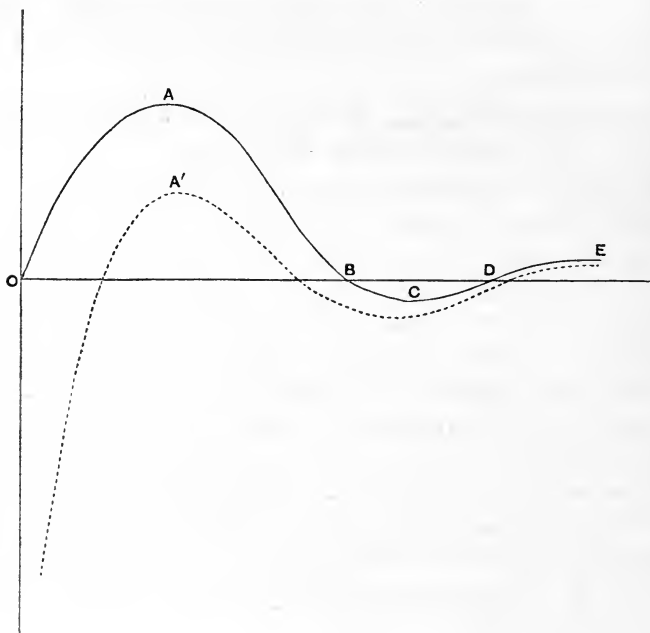

Fig. 39.

pressure is p can be got by drawing a horizontal line at a distance $\sigma R \theta \log_e \frac{p}{P}$ above the horizontal axis of coordinates and finding where it cuts the curve.

We see now when we take the variation of surface tension into account that even the slightest supersaturation will produce some condensation, but that these drops will be exceedingly small*, and will evaporate as soon as the supersaturation ceases. Let us suppose however that we produce enough supersaturation to carry the drop represented by the point A on Fig. 39. When once the drop has got past this point the equilibrium vapour pressure gets smaller as the drop gets bigger, so that water will condense on the drop and the drop will increase in size, but the bigger it gets the smaller the equilibrium vapour pressure and the faster it grows, in fact the region between A and D is unstable, and when once

* Of course drops would not be formed if the radius indicated by theory were smaller than the radius of a water molecule.

the drop has got past *A* it will become large enough to be visible. This I think is the explanation of the dense cloud which C. T. R. Wilson found is produced even in the absence of ions by an eight-fold supersaturation—this supersaturation is required to carry the drop past *A*.

Let us now consider the reverse process, the evaporation of a drop already formed. To fix our ideas let us suppose that the drop is originally in an atmosphere saturated with water vapour and that the temperature is gradually raised so that the surrounding atmosphere is no longer saturated. The drop will evaporate until it gets to the state represented by the point *E*; now evaporation becomes more difficult because as the drop gets smaller the equilibrium vapour pressure gets smaller and to get the drop past the state represented by the point *C* will require a finite rise in temperature (*i.e.* will require the temperature to be raised until the amount of water vapour in the air is only a definite fraction of the saturation amount at that temperature), just as in the reverse process it required the temperature to be lowered a finite amount to carry the drop past *A*. If the rise in temperature is not sufficient to carry the drop past *C* the drop will not wholly evaporate, but will be in equilibrium when its radius is between *OD* and *OC*, thus all these residual drops will be within comparatively narrow limits of size; when the temperature of the drop is the same as that of the air all these drops will have a radius *OD*. These small and invisible drops of water will greatly facilitate the formation of a cloud when next supersaturation takes place, since these drops to grow to visibility will only require the supersaturation corresponding to *E*, while if they were not present to begin with, the supersaturation required to produce a cloud would be that corresponding to *A*. This explains the well-known fact that when once a cloud has been formed, it only requires very slight supersaturation to produce another after a short interval.

So far we have only been dealing with uncharged drops, when the drops are charged we must use

$$\frac{2T}{r} + \frac{dT}{dr} - \frac{e^2}{8\pi Kr^2}$$

instead of

$$\frac{2T}{r} + \frac{dT}{dr};$$

the dotted curve represents the graph of this quantity, the supersaturation required to produce visibility corresponds to A' and is less than that for an uncharged drop.

The principles of the preceding theory ought to apply to the phenomena attending the supersaturation of salt solutions; we see that only a finite and definite amount of supersaturation could occur without deposition of salts, and that amount would be diminished by the presence of ions.

Difference between the action of positive and negative ions in producing condensation.

97. The production of electrification by the splashing of drops and bubbling through water suggests that at the surface of a drop of water there is a double layer of electrification, *i.e.* a layer of one sign at the surface of the drop and a layer of the opposite sign in the gas, the distance between the two layers being very small. If a layer of this kind existed it would produce a difference between the condensing powers of positive and negative ions. Perhaps the easiest way to see this is to notice that by equation (2) $\sigma R\theta \log \frac{P}{p}$ is equal to the excess of pressure at the surface of the water over the atmospheric pressure; for $\frac{2T}{r}$ is the pressure due to the surface tension, while $\frac{KR^2}{8\pi}$ or $\frac{e^2}{8\pi Kr^4}$ is the *tension* due to the electric field. If there is a double layer at the surface of the drop the expression for the tension must be modified; if V is the difference of potential between these layers due to their charges, and d the distance between the layers, then even when the drop is electrically neutral there is a tension equal to

$$\frac{K}{8\pi} \frac{V^2}{d^2}$$

on the surface of the water, so that

$$\sigma R\theta \log \frac{P}{p} = \frac{2T}{r} - \frac{1}{8\pi} \frac{KV^2}{d^2} \dots\dots\dots(6).$$

Now suppose the drop of water has a charge e , the electric force at the surface of the water will be

$$\frac{V}{d} + \frac{e}{Kr^2},$$

and the tension on the surface will be

$$\frac{K}{8\pi} \left\{ \frac{V}{d} + \frac{e}{Kr^2} \right\}^2.$$

$$\begin{aligned} \text{Thus } \sigma R\theta \log \frac{P}{p} &= \frac{2T}{r} - \frac{K}{8\pi} \left(\frac{V}{d} + \frac{e}{Kr^2} \right)^2 \\ &= \frac{2T}{r} - \frac{1}{8\pi} \frac{e^2}{Kr^4} - \frac{V}{4\pi d} \frac{e}{r^2} - \frac{K}{8\pi} \frac{V^2}{d^2}. \end{aligned}$$

Comparing this expression with (6) we see that the effect of the charge is to diminish the right-hand side by

$$\frac{1}{8\pi} \frac{e^2}{Kr^4} + \frac{Ve}{4\pi dr^2};$$

now if $\frac{Ve}{4\pi dr^2}$ is positive the effect of the double layer will be to promote condensation, while if this term is negative the layer will retard condensation. Thus the layer will make an ion of the sign which produces at the surface of the drop an electric field in the same direction as that due to the double layer more effective as a condenser than an ion of the opposite sign. Thus if the double layer in the case of water had the negative coating inside, a negative ion would be more efficient in producing condensation than a positive one. When a fresh surface of water is exposed to air we have seen that the air gets negatively electrified; we may regard this as indicating that an equal quantity of positive goes to the water surface to form the outer coating of the double layer, so that this double layer has the negative side next the water, the positive side next the air.

We know that in some liquids the electrification produced by bubbling air through them is positive instead of negative, in such liquids the outer coating of the double layer should be negative, and for these the positive ion should be a better condenser than the negative. Prziham (*Wien. Bericht.* Feb. 1906) has recently shown that clouds formed in alcohol vapour condense more easily on positive ions than on negative.

CHAPTER VIII.

IONISATION BY INCANDESCENT SOLIDS.

98. WE shall now proceed to the study of some special cases of ionisation, beginning with that due to incandescent metals. That the air in the neighbourhood of red-hot metals is a conductor of electricity has been known for nearly two centuries; the earliest observations seem to have been made by Du Fay* in 1725, by Du Tour† in 1745, by Watson‡ in 1746, by Priestley§ in 1767, and by Cavallo|| in 1785. Becquerel¶ in 1853 showed that air at a white heat would allow electricity to pass through it even when the potential difference was only a few volts. Blondlot** confirmed and extended this result, and proved that air at a bright red heat was unable to insulate under a difference of potential as low as 1/1000 of a volt; he showed, too, that the conduction through the hot gas was not in accordance with Ohm's law. Recent researches have thrown so much light on the causes at work in the ionisation of gases in contact with glowing solids, that it is unnecessary to enter into these earlier investigations in greater detail. Guthrie†† seems to have been the first to call attention to one very characteristic feature of ionisation by incandescent metals, *i.e.* the want of symmetry between the effects of positive and negative electrification. He showed that a red-hot iron ball in air could retain a charge of negative but not of positive electrification, while a white-hot ball could not retain a charge of either positive or negative electrification.

* Du Fay, *Mém. de l'Acad.* 1733.

† Du Tour, *Mém. de Mathématique et de Physique*, xi. p. 246, 1755.

‡ Watson, *Phil. Trans.* abridged, vol. x. p. 296.

§ Priestley, *History of Electricity*, p. 579.

|| Cavallo, *Treatise on Electricity*, vol. i. p. 324.

¶ Becquerel, *Annales de Chimie et de Physique*, iii. 39, p. 355, 1853.

** Blondlot, *Comptes Rendus*, xcii. p. 870, 1881; civ. p. 283, 1887.

†† Guthrie, *Phil. Mag.* iv. 46, p. 257, 1873.

99. The ionisation produced by incandescent metals was investigated systematically in great detail by Elster and Geitel*, who used for this purpose the apparatus represented in Fig. 40.

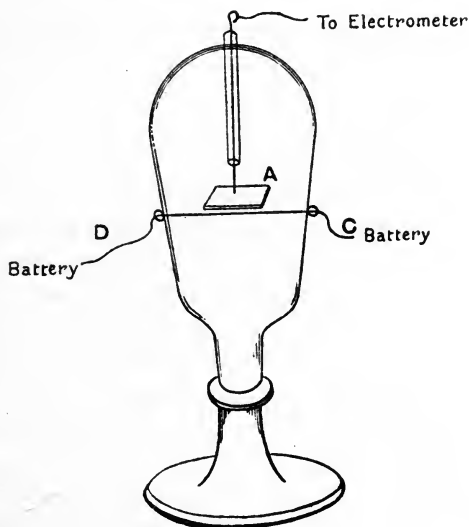

Fig. 40.

This is a glass vessel containing an insulated metal plate *A*, which is connected with one pair of quadrants of an electrometer. Underneath this plate there is a fine metallic wire, which can be raised to incandescence by an electric current passing through the leads *C*, *D*; to prevent any disturbing effects arising from the change produced by the current in the electric potential of the wire, the middle point of the wire was connected with the earth. Let us first take the case when the gas in the vessel is air or oxygen at atmospheric pressure, then, as soon as the glow of the hot wire begins to be visible, the metal plate receives a *positive* charge; this charge increases until the potential of the plate reaches a value which varies very much with the dimensions of the apparatus used: in Elster and Geitel's experiments it was of the order of a few volts. This potential increases as the temperature of the wire increases, until the wire is at a yellow heat; at

* Elster and Geitel, *Wied. Ann.* xvi. p. 193, 1882; xix. p. 588, 1883; xxii. p. 123, 1884; xxvi. p. 1, 1885; xxxi. p. 109, 1887; xxxvii. p. 315, 1889. *Wien. Bericht.* xcvii. p. 1175, 1889.

this stage the potential of the plate is a maximum. After passing this stage the potential diminishes as the wire gets hotter and hotter, until at a bright white heat the charge received by the plate is very small.

The electrification on the plate is very much influenced by the pressure of the gas. Starting at atmospheric pressure and gradually exhausting the vessel, we find that at first the change of pressure does not produce any great effect upon the potential of the plate *A*, but when we approach very high exhaustion, such as those in Crookes' tubes, the potential of the plate begins to diminish, until at very low pressures it changes sign and may as the exhaustion proceeds reach a very large negative value. The pressure at which the change in sign of the electrification of the plate takes place depends upon the temperature of the wire, the higher the temperature the higher the pressure at which the reversal of the electrification occurs. Again, long-continued incandescence of the wire favours the negative electrification of the plate; the physical condition of the platinum wire is changed by long-continued heating, and the wire becomes brittle. The following experiment, due to Elster and Geitel*, seems to indicate that the gases absorbed in the platinum wire and which are gradually, but only very gradually, expelled by long-continued heating, play a considerable part in the electrical phenomena connected with the incandescence of metals. They found that if the platinum wire was kept glowing in a fairly good vacuum long enough for the metal plate to receive a negative charge, the introduction of a very small quantity of fresh gas reversed the sign of electrification on the metal plate, and the pressure had to be reduced far below the original value for the negative electrification to be recovered.

100. The effects are also complicated by the dust and vapour given off by the glowing platinum, and which form a deposit on the walls of the vessel. The production of this dust can very easily be shown by the study of clouds formed by the method described in Chapter VII. If a fine platinum wire is fused into the expansion apparatus, and the air rendered dust-free in the usual way, so that no clouds are produced by an expansion less than 1.25, dense clouds will be formed by comparatively small expansions after a current has been sent through the wire strong enough to raise it

* Elster and Geitel, *Wien. Bericht.* xvii. p. 1175, 1889.

to incandescence* ; indeed it is not necessary to make the wire so hot as to be luminous, an increase in the temperature of the wire to 200 or 300° C. is sufficient to produce the cloud.

The sign of the electrification produced by glowing substances is influenced by the nature of the substances and of the gas surrounding them ; thus in hydrogen Elster and Geitel† showed that the plate above the incandescent wire became negatively electrified even when the hydrogen was at atmospheric pressure. This electrification continually increased with the temperature. To get the negative electrification, however, the wire must be at least at a bright yellow heat ; at lower temperatures the electrification is positive ; a clean copper wire, on the other hand, gives a positive electrification in hydrogen, unless the pressure is very low.

Elster and Geitel showed that the sign of the electrification in water vapour and the vapours of sulphur and phosphorus was the same as in air ; they could detect no electrification in mercury vapour.

101. The influence of the nature of the incandescent substance is shown by the fact that with incandescent carbon filaments the electrification on the metal plate is always negative. It is also shown clearly by some experiments made by Branly‡. Branly's method was as follows : he hung up a charged insulated conductor in the neighbourhood of the incandescent body ; he found that when the latter was a piece of platinum at a dull red heat the insulated conductor lost a negative but not a positive charge ; when the platinum was white hot the conductor was discharged whether electrified positively or negatively. If the incandescent body was an oxide and not a pure metal, at any rate if it was an oxide of one of the metals tried by Branly, viz. lead, aluminium or bismuth, then it would discharge a positively electrified body but not a negatively electrified one, which is exactly opposite to the effect produced by a pure metal at a dull red heat.

102. McClelland§ sucked the gases from the neighbourhood of the incandescent wire and then investigated their properties. He

* R. v. Helmholtz, *Wied. Ann.* xxxii. p. 1, 1887. Lodge, *Nature*, xxxi. p. 267, 1884.

† Elster and Geitel, *Wied. Ann.* xxxi. p. 109, 1887.

‡ Branly, *Comptes Rendus*, cxiv. p. 1531, 1892.

§ McClelland, *Proc. Camb. Phil. Soc.* x. p. 241, 1900.

found that as soon as the wire began to glow the gas would discharge a negatively but not a positively electrified body; when the temperature of the electrified body was increased by about 400° C. the gas began to discharge a positively electrified body, though not so freely as it did a negatively electrified one; when the wire got to a bright yellow heat the gas discharged both positive and negative electricity with equal facility. McClelland investigated the laws of conduction of electricity through the gas which had been in contact with the glowing wire; he found that it showed all the characteristics of conduction through a gas containing ions; thus the relation between the current and the electromotive force is represented by a curve like Fig. 5, the current soon reaching saturation. McClelland also determined the velocity in an electric field of the ions, produced by the incandescent metal. He found that their velocity was small compared with that of the ions produced by Röntgen rays, and that the hotter the wire the *smaller* was the velocity of the ions.

103. The account we have already given of the effects observed in the neighbourhood of an incandescent wire shows that the electrification produced in this way is a very complicated phenomenon, and depends:

- (1) On the temperature of the wire.
- (2) On the pressure of the gas around the wire.
- (3) On the nature of the gas.
- (4) On the nature of the incandescent wire.

We shall simplify the investigation of the cause of this electrification if we study a case in which as many as possible of these effects are eliminated. Now (2) and (3) are eliminated if we work with the highest attainable vacuum; in this case the phenomena are greatly simplified and exhibit points of remarkable interest. To investigate them we may use a piece of apparatus like that shown in Fig. 41. It consists of a straight piece of fine wire AB , which can be heated to any desired temperature by an electric current led in through the leads CA , DB . Around this wire and insulated from it is a metallic cylinder, shown in section in EF and GH ; this cylinder should be longer than, and coaxial with, the wire. This system is sealed into a glass vessel connected with an air-pump and the pressure reduced as low as possible, say to

·001 mm. of mercury. It is desirable to keep the wire red hot for a very considerable time (I have found a week not too long), in

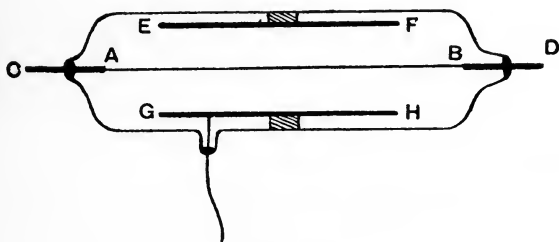

Fig. 41.

order to expel gases absorbed in the wire; until these are got rid of the behaviour of the wire is very irregular. The vessel should be pumped from time to time while the wire is hot, to get rid of the gases coming out of the wire; it will be necessary to exhaust the vessel from time to time, even after these have been expelled, as the heat coming from the wire seems to liberate gas from the walls of the glass vessel and the metal cylinder. Connect the hot wire to one terminal of a battery and the cylinder to the other, and place in the circuit a sensitive galvanometer. If now the wire be made red hot and connected with the negative pole of the battery, an appreciable current will go through the galvanometer; if, however, the terminals are reversed so that the hot wire is connected with the positive pole of the battery, the current which passes is too small to be detected by the galvanometer; thus there can be a current through the exhausted vessel when the negative electricity goes from the hot wire to the cold cylinder, but not an appreciable one when the positive electricity would have to go from the wire to the cylinder; the system can thus transmit a current in only one direction. The current does not obey Ohm's law: at first it increases with the electromotive force, but it soon reaches a saturation value beyond which it does not increase, even though the electromotive force is increased, provided the increase in the electromotive force is not sufficient to enable the electric field itself to ionise the gas.

104. The saturation current increases very rapidly with the temperature. This is well shown by the curve in Fig. 42, which

represents the results of the experiments made by O. W. Richardson*, in the Cavendish Laboratory, on the saturation current between a hot platinum wire and a metal cylinder surrounding it

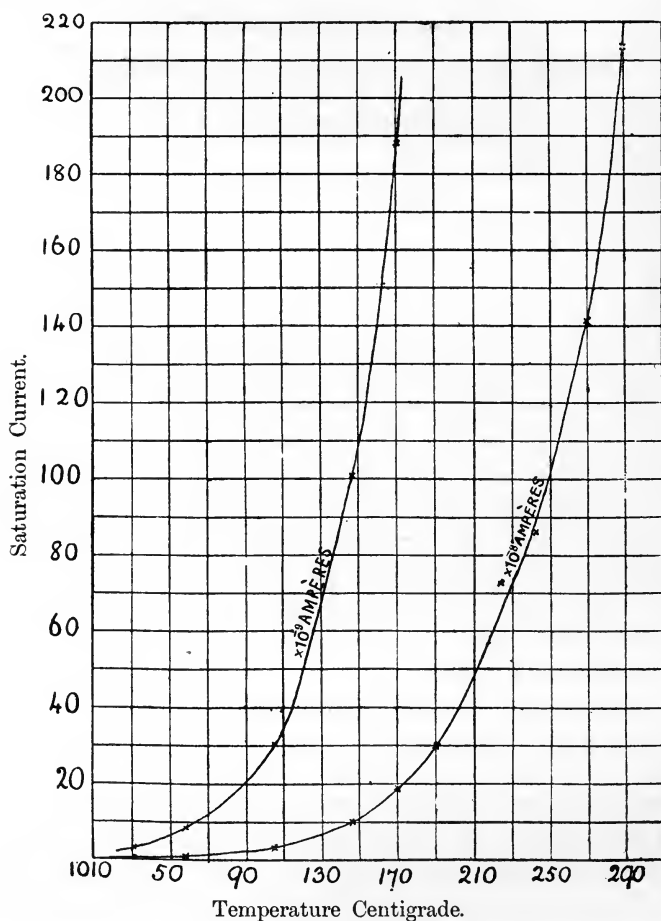

Fig. 42.

in a high vacuum. The temperatures were obtained by measuring the resistance of the wire. Richardson found that the relation between the saturation current I and the absolute temperature θ could be expressed by an equation of the form

$$I = a\theta^{\frac{1}{2}} \epsilon^{-\frac{b}{\theta}},$$

* O. W. Richardson, *Proc. Cam. Phil. Soc.* xi. p. 286, 1902; *Phil. Trans.* 201, p. 516, 1903.

for the curve in Fig. 42,

$$a = 1.51 \times 10^{26}, \quad b = 4.93 \times 10^4.$$

In the case of this wire the current amounted to about 4×10^{-4} ampères at the temperature 1500°C ., which represents a rate of emission of negative electricity from the hot wire of above one milliampère per square centimetre of surface. If the same formula held up to the melting point of platinum, which we shall take to be 2000°C ., the rate of emission of negative electricity from the glowing wire would be about 1/10 of an ampère per square centimetre.

The rate of escape of negative electricity from glowing carbon in some cases greatly exceeds that from glowing platinum. This is no doubt chiefly owing to the fact that the carbon can be raised to a much higher temperature than the platinum. Richardson has obtained from carbon filaments in a good vacuum currents of the order of an ampère per square centimetre of surface.

105. This escape of negative electricity from glowing carbon in high vacua is the cause of an effect observed in incandescent electric lamps, known as the Edison effect, and which has been studied by Preece* and in great detail by Fleming†. The 'Edison effect'

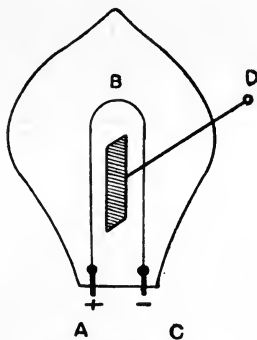

Fig. 43.

is as follows: Suppose that *ABC* represents the carbon filament of an incandescent lamp, and that an insulated metal plate is

* Preece, *Proc. Roy. Soc.* xxxviii. p. 219, 1885.

† Fleming, *Proc. Roy. Soc.* xlvii. p. 118, 1890; *Phil. Mag.* xlii. p. 52, 1896.

inserted between the filaments; then if the positive end *A* of the filament is connected with a wire *D* leading from the metallic plate and a galvanometer inserted between *A* and *D*, a considerable current, amounting in some of Fleming's experiments to three or four milliampères, passes through the galvanometer, the direction of the current being from *A* to *D* through the galvanometer. If, however, the metal plate is connected with the negative electrode of the lamp and a galvanometer inserted in this circuit, the current through the galvanometer is exceedingly small compared with that observed in the preceding case. We see that this is what would occur if there was a vigorous discharge of negative electricity from the negative leg of the carbon filament, and no discharge or a much smaller one from the positive leg; this would tend to make the potential of the metal plate differ but little from that of the negative leg of the carbon loop, while the difference of potential between the positive leg and the plate would be nearly that between the electrodes of the lamp, and consequently the current through a circuit connecting the positive electrode to the metallic plate would be much greater than through one connecting the negative electrode to the plate.

Fleming showed that when the negative leg of the carbon loop was surrounded by a cylinder made either of metal or of an insulating substance, the Edison effect disappeared almost entirely. Fleming too found, as Elster and Geitel had previously shown by a somewhat different method, that a current of electricity could pass between an incandescent carbon filament and a cold electrode, if the direction of the current was such as to cause the negative electricity to pass from the hot filament to the cold plate, and that a current would not pass in the opposite direction. Elster and Geitel showed, too, that a plate placed near an incandescent filament received even in very high vacua a charge of negative electricity. The behaviour of the hot filament shows that it, like the incandescent platinum wire, emits negative electrification. That the emission from the carbon filament is much greater than that from the platinum wire—great as we have seen the latter to be—is shown by the fact that although, as Fleming (*loc. cit.*) has shown, the 'Edison effect' can be observed with an incandescent platinum wire in place of the carbon filament, the effect with platinum is exceedingly small compared with that with carbon, and

is only appreciable when the platinum is so hot that it is on the point of melting.

106. There can thus be no doubt that from incandescent metals and carbon there is a very rapid escape of negative electricity. The question arises, What are the carriers of this electrification? The answer to this question seems at first sight obvious, for both the carbon filament and the platinum wire volatilise, or at any rate give off dust if not vapour at high temperatures. This is shown by the familiar deposit of carbon on the glass of incandescent lamps, and of platinum or platinum oxide on the walls of an exhausted vessel in which a platinum wire has been glowing for a long period. It seems natural, therefore, to regard the carriers of the negative electricity as the molecules or atoms of carbon or platinum vapour. We might, however, be led to suspect the accuracy of this view when we observe the enormous quantities of negative electricity which can be discharged by a small piece of very thin wire; quantities which are inconsistent with that law of electrolysis which states that to carry a quantity of electricity E we require a mass of a substance $E\epsilon$, where ϵ is the electrochemical equivalent of the substance.

We can, however, determine by the method of Art. 59 the ratio of the charge e to the mass m of the carriers of the negative electricity from an incandescent wire. The results of this determination, which are given in Art. 59, are conclusive, for they show that the value of e/m for these carriers is the same as its value for the carriers of the negative electricity in the cathode rays, and in the discharge of negative electricity from metals placed in a good vacuum and illuminated by ultra-violet light. Thus the negative electricity from the hot wire is carried by the same carriers as the cathode rays, *i.e.* by 'corpuscles,' those small negatively electrified bodies of constant mass which in all the cases yet investigated act as the carriers of negative electricity in high vacua.

We thus are led to the conclusion that from an incandescent metal or glowing piece of carbon 'corpuscles' are projected, and though we have as yet no exact measurements for carbon, the rate of emission must, by comparison with the known much smaller rate for platinum, amount in the case of a carbon filament at its

highest point of incandescence to a current equal to several amperes per square centimetre of surface. This fact may have an important application to some cosmical phenomena, since, according to the generally received opinion, the photosphere of the sun contains large quantities of glowing carbon; this carbon will emit corpuscles unless the sun by the loss of its corpuscles at an earlier stage has acquired such a large charge of positive electricity that the attraction of this is sufficient to prevent the negatively electrified particles from getting right away from the sun; yet even in this case, if the temperature were from any cause to rise above its average value, corpuscles would stream away from the sun into the surrounding space. We may thus regard the sun, and probably any luminous star, as a source of negatively electrified particles which stream through the solar and stellar systems. Now when corpuscles moving at a high speed pass through a gas they make it luminous; thus when the corpuscles from the sun meet the upper regions of the earth's atmosphere they will produce luminous effects. Arrhenius* has shown that we can explain in a satisfactory manner many of the periodic variations in the Aurora Borealis if we assume that it is caused by corpuscles from the sun passing through the upper regions of the earth's atmosphere.

The emission of corpuscles from incandescent metals and carbon is readily explained by the view—for which we find confirmation in many other phenomena—that corpuscles are disseminated through metals and carbon, not merely when these are incandescent, but at all temperatures; the corpuscles being so small are able to move freely through the metal, and they may thus be supposed to behave like a perfect gas contained in a volume equal to that of the metal. The corpuscles are attracted by the metal, so that to enable them to escape into the space surrounding it they must have sufficient kinetic energy to carry them through the layer at its surface, where its attraction of the corpuscles is appreciable. If the average kinetic energy of a corpuscle like that of the molecule of a gas is proportional to the absolute temperature, then as the temperature increases, more and more of the corpuscles will be able to escape from the metal into the air outside.

* Arrhenius, *Physikalische Zeitschrift*, ii. pp. 81, 97, 1901.

Rate at which the corpuscles escape from the metal.

107. We can without much difficulty find an expression for this quantity if we assume that the corpuscles in the metal behave like a perfect gas. Let AB , CD represent two planes parallel to the surface of the metal including between them the region in which the metal exerts an appreciable force upon the corpuscle. Let us take the axis of x at right angles to these planes, the positive direction of x being from the air to the metal; then if p is the pressure due to the corpuscles, n the number of corpuscles in unit volume, X the force acting on a corpuscle, we have when there is equilibrium

$$\frac{dp}{dx} = Xn \dots \dots \dots (1);$$

but if the corpuscles behave like a perfect gas $p = \beta\theta n$, where θ is the absolute temperature and β a constant which is the same for all gases; substituting this value for p in equation (1), we get

$$\beta\theta \frac{dn}{dx} = Xn \dots \dots \dots (2);$$

integrating this equation from CD to AB , we get

$$\log \frac{n'}{N} = - \frac{w}{\beta\theta},$$

or
$$n' = N\epsilon^{-\frac{w}{\beta\theta}} \dots \dots \dots (3),$$

where n' and N are respectively the numbers of corpuscles in unit volume of the air and metal, and

$$w = \int Xdx;$$

thus w is the work required to drag a corpuscle out of the metal.

Equation (3) gives the number of corpuscles in the air when things have attained a steady state. To find the number of corpuscles coming from the metal in unit time let us proceed as follows: regard the steady state as the result of a dynamical equilibrium between the corpuscles going from the metal to the air and those going from the air to the metal. If n' is the number of corpuscles in unit volume of the air, the number which

in one second strike against unit area of the metal is by the Kinetic Theory of Gases equal to

$$\sum_0^{\infty} u dn,$$

dn being the number of corpuscles which have velocities between u and $u + du$, and the summation is to be taken for all positive values of u . Now if n' is the total number of corpuscles in unit volume

$$dn = n' \sqrt{\frac{hm}{\pi}} \epsilon^{-hmu^2} du,$$

where m is the mass of a corpuscle: hence

$$\begin{aligned} \sum_0^{\infty} u dn &= n' \sqrt{\frac{hm}{\pi}} \int_0^{\infty} \epsilon^{-hmu^2} u du \\ &= \frac{1}{2} \frac{n'}{\sqrt{\pi hm}} \\ &= \frac{n'c}{\sqrt{6\pi}}, \end{aligned}$$

where c is the velocity of mean square and is equal to $\alpha(\theta/m)^{\frac{1}{2}}$, α being a constant which is the same for all gases: substituting the value of n' from equation (3) we find that the number of corpuscles coming from the air and striking against unit area of the metal in unit time is equal to

$$\frac{\alpha}{\sqrt{6\pi}} \left(\frac{\theta}{m}\right)^{\frac{1}{2}} N \epsilon^{-\frac{w}{\beta\theta}};$$

if we suppose that all the corpuscles which strike against the metal enter it, this will be the number of corpuscles entering the metal, and therefore in the steady state the number leaving it; the number may be written in the form

$$a\theta^{\frac{1}{2}} \epsilon^{-\frac{b}{\theta}};$$

this number multiplied by e will be the quantity of negative electricity leaving unit area of the metal in unit time, and therefore will be the saturation current from a hot wire at the temperature θ . Richardson's measurements of the saturation current at different temperatures agree well, as we have seen, with a formula of this form. From the values of a and b determined by experiments on the escape of electricity from a hot wire

we can deduce the values of N and w . Richardson found that for platinum

$$a = 1.5 \times 10^{26} \text{ and } b = 4.93 \times 10^4;$$

this gives $N = 1.3 \times 10^{21}$ and $w = 8 \times 10^{-12}$ ergs.

The pressure due to the corpuscles in the metal would at atmospheric temperature be between 30 and 40 atmospheres.

Richardson* has investigated the leak from hot sodium and found that it is very much greater than that from platinum at the same temperature, and could be detected at temperatures as low as 200°—300° C. Wehnelt† discovered that the leak from oxides of the electropositive metals, calcium and barium, is also very much greater than from platinum at the same temperature, a spot of lime on an incandescent piece of platinum furnishing a very convenient source of an abundant supply of negative corpuscles. Wehnelt proved that the variation with temperature of the leak from these incandescent oxides was also expressive by an equation of the type of that on p. 194; Owen‡ has shown that this expression holds for the leak from an incandescent Nernst filament.

Richardson§ gives the following values for b deduced from his own observations and from those of H. A. Wilson, Wehnelt, and Owen.

Substance	b	a	Observer
Carbon	9.8×10^4	10^{34}	Richardson
Platinum treated for 24 hours with nitric acid	7.75×10^4	6×10^{25}	H. A. Wilson
Platinum treated for 1 hour with nitric acid	6.55×10^4	6.9×10^{26}	H. A. Wilson
Platinum in hydrogen at 0.0013 mm.	6×10^4	10^{26}	H. A. Wilson
Platinum in hydrogen at 0.112 mm.	4.3×10^4	5.3×10^{23}	H. A. Wilson
Platinum in hydrogen at 133 mm....	1.8×10^4	10^{18}	H. A. Wilson
Platinum not specially treated	4.93×10^4	7.5×10^{25}	Richardson
Nernst filament.....	4.41 4.82×10^4	3.5×10^{24} 1.15×10^{23}	Owen
Barium oxide on platinum	4.49×10^4	7.2×10^{26}	Wehnelt
Calcium oxide on platinum.....	4.28×10^4	4.5×10^{26}	Wehnelt
Sodium	3.16×10^4	10^{31}	Richardson

* Richardson, *Phil. Trans.* 201, p. 516, 1903.

† Wehnelt, *Ann. de Phys.* 14, p. 425, 1904.

‡ Owen, *Phil. Mag.* [6] 8, p. 230, 1904.

§ Richardson, *Jahrbuch für Radioaktivität* 1, p. 308, 1904.

The accuracy with which the formula

$$a\theta^{\frac{1}{2}}\epsilon^{-\frac{b}{\theta}}$$

represents the leak may be estimated by the following table, which gives the leak observed by H. A. Wilson from a platinum wire treated with nitric acid and those calculated from the expression $6.9 \times 10^7 \times \theta^{\frac{1}{2}}\epsilon^{-6.55 \times 10^4/\theta}$.

Temperature in degrees Centigrade	Leak per sq. cm. observed	Leak calculated
1375	1.57×10	1.49×10
1408.5	3.43×10	3.33×10
1442	7.46×10	7.18×10
1476	15.2×10	15.3×10
1510.5	32.3×10	31.8×10
1545	63.8×10	64.5×10
1580	128×10	128.5×10

The factor $\epsilon^{-6.55 \times 10^4/\theta}$ in this expression represents the term $\epsilon^{-\frac{w}{\beta\theta}}$, hence we find that w , the work required to detach a corpuscle from the platinum, is that required to drag its charge through a potential difference of about 5.6 volts. A small change in the amount of this work such as would be produced by a double layer of electricity at the surface of the wire would produce enormous changes in the amount of negative electricity coming from the wire. Thus taking the case given above, we see that at a temperature of 1000° absolute the exponential term is ϵ^{-65} . Suppose now that a double layer of electricity were set up at the surface of such a sign as to help the corpuscles to escape from the metal, and suppose that the potential difference between the coatings of the double layer were 1 volt. The extra work required to detach a corpuscle would be that corresponding to 4.6 instead of 5.6 volts; this would make the exponential factor $\epsilon^{-65 \times \frac{4.6}{5.6}}$ or ϵ^{-53} instead of ϵ^{-65} , thus the effect of the surface layer would be to increase the current ϵ^{12} or more than 150,000 times.

H. A. Wilson* has shown that the negative leak from a hot platinum wire is enormously increased by the presence of small quantities of hydrogen, since platinum absorbs hydrogen the wire

* H. A. Wilson, *Phil. Trans.* 202, p. 243, 1903.

itself is a source of this gas; by boiling the wire in nitric acid so as to eliminate the hydrogen from it he was able to reduce the leak to $1/250,000$ of its value from a wire not so treated. He found too that the leak from a hot wire in hydrogen at low pressures was proportional to the pressure, whereas in air and water vapour the leak at low pressures is independent of the pressure provided the electric field is not intense enough to produce ionisation by collision. He also found that when the pressure of the ion was altered time was required for the wire to give the leak appropriate to the new pressure, indicating that the leak depends more upon the hydrogen absorbed by the platinum than on that outside the wire. He concludes from his experiments that the negative leak from hot wires depends almost entirely upon the presence of traces of hydrogen and if these were removed the leak would, if it did not vanish altogether, be very greatly reduced. On one occasion when a little phosphorus accidentally got on the wire the leak was enormously increased. In all cases however he found that the variation of the leak with the temperature was expressed by a relation of the form given on p. 194.

The enormous effects produced by hydrogen on the rate of leak may be due, at any rate in part, to the production at the surface of the platinum of double layers of electrification helping the corpuscles to escape from the metal. We shall find when we consider in Chapter X, Photo-electric effects, that the presence of hydrogen facilitates the escape of the corpuscles when the platinum is exposed to ultra-violet light, and that this can also be explained by the formation of a double layer of electricity at the surface of the metal.

I recently observed another instance of the effect of hydrogen on the escape of corpuscles from sodium. A bright surface of sodium was produced in a highly exhausted vessel which contained a well insulated electroscope, this vessel was placed in a chamber from which all light was carefully excluded and which was so dark that a sensitive photographic plate was not fogged after an exposure of 48 hours, under such circumstances the electroscope very slowly lost a positive charge but retained a negative one; when however a trace of hydrogen was sent into the vessel in the dark chamber, the electroscope began to lose its positive charge much more rapidly, there was no leak if the

electroscope was negatively charged; the increased leak from the positively charged electroscope lasted for a few minutes and then disappeared, it could however be renewed by letting in fresh hydrogen and this process could be repeated time after time. This leak was stopped when the electroscope was placed in a magnetic field, showing that it was due to negative corpuscles coming from the sodium while the metal was absorbing hydrogen. No leak of the electroscope occurred if oxygen or carbonic acid gas was admitted into the vessel instead of hydrogen.

108. The double layer at the surface of the metal might in part be due to the same causes as those which produce the contact potential difference between two electrolytes of different concentrations. If two electrolytes are in contact and in one of them there is strong ionisation and in the other weak, there is a difference of potential between them proportional to $R\theta \log \frac{p_1}{p_2}$, where R is the gas constant, θ the absolute temperature and p_1 and p_2 the pressure of the ions in the two solutions. Now some metals, platinum and sodium for example, absorb hydrogen and this is ionised in the metal, thus the metal and the surrounding space are analogous to two electrolytes in contact in one of which there is strong ionisation, while there is very little in the other, there will thus be a difference of potential and therefore a double layer of electrification at the surface; in addition to this source of the double layer there may be that which gives rise to the Volta contact difference of potential. The existence of double layers from causes such as these, though not affecting the form of the expression for the leak in terms of the temperature, would affect the physical meaning to be given to the constants, and would for example make it illegitimate to deduce from the value of the constant a in the formula on page 194 the number of free corpuscles in each cubic centimetre of the metal.

109. The emission of the negative corpuscles from heated substances is not, I think, confined to the solid state, but is a property of the atom in whatever state of physical aggregation it may occur, including the gaseous. The emission of the negative corpuscles from the atoms is well shown in the case of sodium vapour; if a little sodium be placed in a tube from which all gas has as far as possible been exhausted there will be in the dark no leak from

a charged conductor sealed in the tube, if however the temperature is raised to about 300°C . in the dark a considerable leakage of electricity from the charged conductor will occur, whether the charge be positive or negative; the leak in the former case is however greater than in the latter. It might be thought that the leak is due to the corpuscles given out by the solid sodium in the tube, these however would be negatively charged and could not discharge a negatively charged conductor; nor is it due to sodium condensed on the charged conductor itself, for there is no leak on cooling down to the temperature of the room and exposing the charged conductor when negatively electrified to light; if sodium had condensed on the charged metal the leak would have been very perceptible.

If the atoms of sodium vapour emit negative corpuscles they will be positively charged and so should be attracted by a negatively electrified body. The following experiment which I have recently tried shows that this is the case. Sodium was heated in a highly exhausted vessel, placed in a dark chamber; two glass tubes *b*, *c* fused in the vessel had electrodes running down them which could be maintained at different potentials by connecting them with the terminals of a battery of storage cells. These tubes were at a slightly lower temperature than the lower part of the vessel so that the sodium vapour condensed in them. If the wires were not charged the deposit of sodium was about equally dense in the two tubes, if however a difference of potential of about 300 volts was maintained between the tubes the deposit of sodium was found to be almost entirely confined to the tube containing the negatively electrified wire; this was not due to any want of symmetry in the tubes, because the deposit could be obtained on either tube by charging its wire negatively.

The emission of the negatively electrified corpuscles from sodium atoms is conspicuous as it occurs at an exceptionally low temperature; that this emission occurs in other cases although at very much higher temperatures is, I think, shown by the conductivity of very hot gases, and especially by the very high velocity possessed by the negative ions in these gases; the emission of negatively electrified corpuscles from atoms at a very high temperature is thus a property of a very large number of elements, possibly of all.

The emission of corpuscles from the atom must play a very important part in the decomposition of the molecules of a compound by heat, if the forces which bind the atoms together in the molecule are mainly electrical in their origin. For imagine a molecule consisting of two atoms, one, *A*, positively, the other, *B*, negatively electrified, and suppose that the temperature is raised until the point is reached when the negatively electrified atom begins to discharge the negatively electrified corpuscles: when this stage is reached *B* loses a corpuscle. Let us suppose that under the electric field this corpuscle finds its way to the positively electrified *A* neutralising its charge, so that momentarily *A* and *B* are without charge, the attraction previously existing between them is annulled and there is no longer anything to prevent their drifting apart. It does not follow however that the molecule is necessarily permanently split up, for *A* has now no positive charge to prevent the negative corpuscles from escaping, and as it is the electropositive element in the compound it would under similar conditions lose corpuscles more readily than *B*; thus *A* will soon regain its positive charge. *B* being without charge cannot discharge negative corpuscles as easily as it did previously when it was negatively electrified, thus some time may elapse before *B* emits a corpuscle, and in the interval it may get struck by a negative corpuscle and thus acquire a negative charge, recombination might then occur between it and the positively charged *A*, this combination being dissolved again by the process we have already sketched. We should thus get to a state in which there is statistical equilibrium, the number of recombinations in unit time being equal to the number of atoms dissociated in that time: the proportion of the free to the combined atoms will depend upon the properties of each of the atoms; the more easily *A* loses its corpuscles by heating and the greater the difficulty of getting the corpuscles out of *B*, the smaller will be the proportion of free atoms. These considerations show that heat may produce dissociation in other ways than the more commonly recognised one of increasing the kinetic energy until the centrifugal force is great enough to overpower the attraction.

110. The emission of corpuscles by hot bodies will make all such bodies conductors of electricity, and the conductivity will increase very rapidly with the temperature. If we take for example a piece

of lime which as Wehnelt has shown gives off large quantities of corpuscles at high temperatures, then when the lime is hot it will contain a large supply of free corpuscles which will move under an electric field and make the lime a conductor. Experiments are being made at the Cavendish Laboratory by Dr Horton to see whether the conductivity which bodies, such as glass, acquire at high temperatures is not due to the emission of corpuscles from the molecules of the hot substance.

111. We thus see that from an incandescent wire corpuscles are projected at a rate sufficient to produce a very large rate of leak when the pressure of the gas surrounding the wire is very low; at such pressures there is very little gas to hamper the motion of the corpuscles, which consequently can move with very high velocities; as soon as a corpuscle emerges from the incandescent surface it travels away from it towards the cylinder surrounding the wire, and when the current between the wire and the cylinder is saturated none of the corpuscles diffuse back again into the wire.

When however the pressure of the gas surrounding the wire is considerable the corpuscles cannot travel so freely, they tend to accumulate in the neighbourhood of the wire and some of them diffuse back into it again. The density of the corpuscles in the neighbourhood of the wire cannot exceed a definite value, given by equation (3), p. 199: just as in the case of the evaporation of a liquid, the pressure of vapour in contact with the liquid cannot exceed a definite value depending upon the temperature.

Relation between the current and the potential difference.

112. Let us consider the case of two parallel plates at right angles to the axis of x , then if only one of the plates is incandescent, or if both are incandescent but the temperature is so low that only positive ions are produced at the surface of the plates, then the ions carrying the current between the plates will be all of one sign and we may apply the results of Art. 50. Hence if X is the electric force, k the velocity of the ion under unit electric force, we have, if i is the current,

$$X \frac{dX}{dx} = \frac{4\pi i}{k};$$

hence if k is independent of x we have

$$X^2 = \frac{8\pi i}{k} x + C.$$

If n is the number of ions per cubic centimeter

$$\frac{dX}{dx} = 4\pi ne,$$

thus

$$n = \frac{i}{ek} \frac{1}{\sqrt{\frac{8\pi i}{k} x + C}}.$$

Thus the density of the ions at the hot plate when $x = 0$ is equal to

$$\frac{i}{ek\sqrt{C}}.$$

Now suppose that the quantity of electricity emitted by the hot plate per second is I , the quantity of electricity passing through unit area of the gas between the plate is i : the difference $I - i$ must equal the charge carried back to the plate by the corpuscles striking against it. We showed on page 200 that if n is the number of corpuscles per unit volume in the gas near the plate, the number striking unit area of the plate per second is

$$\frac{nc}{\sqrt{6\pi}},$$

where c is the velocity of mean square of the corpuscles. Since

$$n = i/ekC^{\frac{1}{2}},$$

the charge given to the plate by the corpuscles which strike against it is

$$\frac{ic}{\sqrt{6\pi k} C^{\frac{1}{2}}},$$

as this is equal to $I - i$ we have

$$I - i = \frac{ic}{\sqrt{6\pi k} \sqrt{C}},$$

or

$$C = \frac{c^2}{6\pi k^2} \frac{i^2}{(I - i)^2}.$$

If V is the difference of potential and l is the distance between the plates, $V = \int_0^l X dx$, and since

$$X = \left\{ \frac{8\pi i}{k} x + C \right\}^{\frac{1}{2}},$$

$$V = \frac{k}{12\pi i} \left[\left(\frac{8\pi i l}{k} + C \right)^{\frac{3}{2}} - C^{\frac{3}{2}} \right],$$

or substituting the value previously found for C

$$V = \frac{k}{12\pi i} \left[\left(\frac{8\pi i l}{k} + \frac{c^2}{6\pi k^2} \frac{i^2}{(I-i)^2} \right)^{\frac{3}{2}} - \frac{c^3 i^3}{(6\pi)^{\frac{3}{2}} k^3 (I-i)^3} \right] \dots (1).$$

This gives the relation between the current and the potential difference. I is the saturation current.

The quantities are supposed to be measured in electrostatic units.

We shall consider two particular cases of this equation; the first is when i is so small compared with I that

$$\frac{c^2}{6\pi k^2} \frac{i^2}{(I-i)^2}$$

is small compared with $\frac{8\pi i l}{k}$.

Then equation (1) becomes

$$V = \left(\frac{8\pi i}{k} \right)^{\frac{1}{2}} \frac{2}{3} l^{\frac{3}{2}},$$

or

$$i = \frac{9kV^2}{32\pi l^3} \dots \dots \dots (2).$$

Thus the current increases more rapidly than the potential difference, and diminishes rapidly as the distance between the plates is increased.

This equation has been tested by Rutherford*; we cannot however expect the theory to be in very close agreement with the facts, for in deducing equation (1) we have made several assumptions which are not satisfied in practice; in the first place we have assumed that k is independent of x , this will only be true when the temperature is uniform between the plates, it will not be true when one plate is hot and the other cold, for the velocity of the ion depends upon the temperature. Thus H. A. Wilson† has shown that in a flame at a temperature of about 2000° C. the velocity of the negative ion under a potential gradient of 1 volt per cm. is about 1000 cm./sec., that of the positive ion under the same gradient 62 cm./sec.; in hot air at a temperature of about 1000° C. the velocity of the negative ion is only about 26 cm./sec.,

* Rutherford, *Physical Review*, xiii. p. 321, 1901.

† H. A. Wilson, *Phil. Trans. A*, 192, p. 499, 1899.

that of the positive about 7·2 cm./sec. McClelland* found that the ions from an incandescent wire when they got into the cold air at some distance from the wire travelled with velocities as small as ·04 cm./sc., and that the velocity diminished as the ions got further from the wire and could be increased again by warming the ions; thus k varies rapidly with the temperature and therefore with x .

The increase of k with the temperature makes the current increase rapidly with the temperature of the hot plate. We see from equation (1) that the current for a constant small difference of potential does not depend upon the amount of ionisation near the plate†, so that the increase of ionisation at the higher temperature would not explain the increase of current when the wire gets hotter; a satisfactory explanation of this increase is however afforded by the increase of k with the temperature.

When the temperature of the hot plate is high enough for negative as well as positive ions to exist near the plate, the leak between the hot plate and a cold one will be greater when the hot plate is the negative electrode than when it is the positive: for in the former case the current is carried by negative ions, in the latter by positive, and equation (1) shows that with the same potential difference the current is proportional to the velocity of the ion by which it is carried. Now the velocity of the negative ion is always greater than that of the positive, and the ratio of the velocity of the negative to that of the positive increases rapidly with the temperature; thus the experiments of H. A. Wilson on the leak through gases mixed with the vapours of salt (*l. c.*) show that this ratio at 2000° C. is about 17 while at 1000° C. it is only about 3·5. At ordinary temperatures for the case of ions drawn from the neighbourhood of the hot wire, McClelland's experiments show that this ratio is only about 1·25. The great increase of current produced by changing the sign of a very hot electrode from + to - is a very well-marked phenomenon; one striking example of it is furnished by an old experiment of Hittorf's‡. In this experiment a bead of salt was placed in a flame between glowing electrodes: the increase in the current was much

* McClelland, *Phil. Mag.* v. 46, p. 29, 1899.

† It must be remembered that equation (1) only applies when the current is small, so that $X=0$ when $x=0$; when the current approaches saturation it increases rapidly with the amount of ionisation at the plate.

‡ Hittorf, *Pogg. Ann. Jubelband*, p. 430, 1874.

greater when the bead was placed close to the negative electrode than when it was placed near to the positive. These results, it must be remembered, are only true when the currents are very small compared with their saturation values; the saturation values do not depend upon the velocities of the ions but only upon the number of ions produced in unit time at the surface of the hot metal.

The velocity of an ion under a constant electric force increases as the pressure of the gas diminishes, hence we see from equation (1) that the current when small will increase when the pressure diminishes.

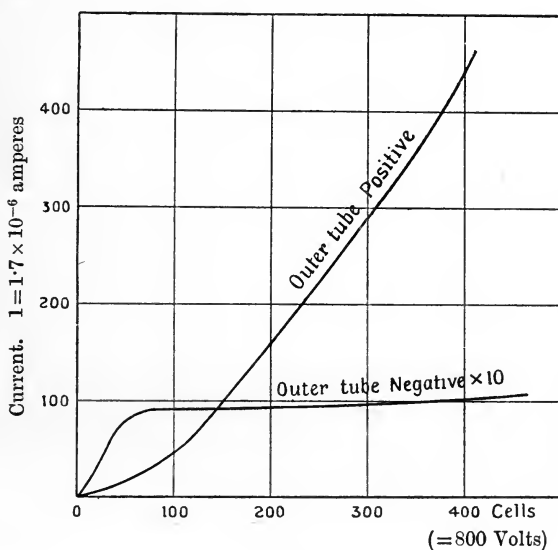

Fig. 44.

113. A well-marked feature of the discharge from incandescent metals is the very rapid increase of the current, when this is small, with the electromotive force, an increase much more rapid than that given by Ohm's law. This has frequently been observed; thus, for example, Pringsheim* gives as an empirical formula for the current i in terms of the potential difference V for the discharge between two pointed electrodes in a hot gas

$$i = \frac{V + aV^2}{w},$$

where a and w are constants. The rapid increase in the current is

* Pringsheim, *Wied. Ann.* lv. p. 507, 1895.

well illustrated by the curve in Fig. 44 given by H. A. Wilson* for the case of the current between a hot platinum wire and a hot platinum tube outside it; in this curve the ordinates represent the current and the abscissæ the potential differences, the curve for the case when the tube is negative illustrates too the 'saturation' of the current under high electromotive forces. This rapid increase of the current is accounted for by equation (1), which shows that the current is proportional to the square of the potential difference.

The equation (1) will however, except at very low pressures, only hold when the current is an exceedingly small fraction of the saturation current, for in deducing it we have assumed that

$$\frac{c^2}{6\pi k^2} \frac{i^2}{(I-i)^2}$$

is small compared with $\frac{8\pi il}{k}$.

Now c is the velocity of mean square of the corpuscles so that if the temperature of the hot plate is 1000°C . c^2 will be of the order 9×10^{12} , k is the velocity of the ion through the gas under unit electrostatic force, *i.e.* 300 volts per centimetre; thus if the air is cold and at atmospheric pressure k will be about 4.5×10^2 and k^2 about 2×10^5 ; thus c^2/k^2 will be exceedingly large, and it is only when i is very small compared with I that the above condition is fulfilled.

The other case we shall consider is when

$$\frac{c^2}{6\pi k^2} \frac{i^2}{(I-i)^2}$$

is large compared with $\frac{8\pi il}{k}$.

In this case $V = \frac{c}{\sqrt{6\pi}} \frac{i}{k(I-i)} l$,

$$i = \frac{VI}{V + \frac{c}{\sqrt{6\pi}} \frac{l}{k}}.$$

This equation shows that i now increases less rapidly than the potential difference, it approaches saturation when $\frac{V}{l} k$ is large compared with $c/\sqrt{6\pi}$, *i.e.* when the electric field is so strong that

* H. A. Wilson, *Phil. Trans. A*, 197, p. 415, 1901.

the velocity given to an ion by the field is large compared with the velocity of mean square of a corpuscle at the temperature of the hot plate; we see from the numbers given above that it would require a prodigious field to saturate the current from a hot wire through a gas at atmospheric pressure, in fact it would be impossible to saturate the current at all, for the field required to do so is greater than that required to spark through the gas.

Emission of Positive Electricity by Hot Metals.

114. Hot metals emit positive as well as negative electricity, indeed in many cases until the temperature gets very high the metal emits more positive than negative electricity. The emission of positive electricity can be detected at much lower temperatures than that of negative. Strutt* has detected the emission of positive electricity from copper and silver wires at a temperature less than 200° C.

The rate of emission of positive ions from a hot wire depends to a very large extent on the previous history of the wire. On first heating a wire it emits a large quantity of positive electricity, if the wire is kept hot the rate of emission rapidly decays until it falls to a small fraction of its original value. This large initial leak cannot be due to dirt on the surface of the wire for it occurs with platinum wires which have been boiled in nitric acid. It is not confined to metals, for Owen† has shown that it is well marked in a Nernst filament; he found that the filament after heating did not recover its power of giving a large initial leak after exposure to air at atmospheric pressure for several days. The evidence as to the recovery of such a leak in platinum wires after exposure to air is somewhat conflicting, as H. A. Wilson and Richardson, who have each made important investigations on the leak from hot wires, have arrived at opposite conclusions. Wilson thinking that a short exposure to air is sufficient to restore the original leak, while Richardson attributed the increase which he obtained not to the air but to the accidental presence of a complex vapour, probably that of phosphorus, as he has found‡ that the exposure of a platinum wire to a small quantity of phosphorus will for a time produce an enormous increase in the positive leak from the wire.

* Strutt, *Phil. Mag.* 6. 4, p. 98, 1902.

† Owen, *Phil. Mag.* 6. 8, p. 230, 1904.

‡ Richardson, *Phil. Mag.* 6. 9, p. 407, 1905.

Richardson found that a wire which had been strongly heated could be kept in a vacuum for more than three weeks without any recovery of its power to give a large positive leak. It would be of great interest to see if any recovery took place after a rest in a vacuum of much longer duration, and so determine whether the large initial leak is due to some foreign matter absorbed by the wire or whether, like the emanation from a radio-active substance, it arises from something produced by the metal itself which gradually accumulates in the wire.

Richardson has made the very interesting discovery* that when a wire has by heating lost its power of giving a large positive leak, it can regain the power by being made the cathode for the electric discharge through a gas at low pressure, or even by being placed near such a cathode; in the latter case the recovery of this power does not take place if an obstacle is placed between the cathode and the wire. We cannot tell without further experiments whether this recovery is due to the bombardment of the wire by corpuscles or positive ions, or to some matter deposited on the wire by the discharge; this point could be tested by placing the wire in a stream of cathode rays in a highly exhausted tube, arranged so that none of the metal torn off from the cathode can reach the wire.

It is important to settle this point because some substances after exposure to cathode rays show what is known as thermo-luminescence, which is in some respects analogous to the behaviour of the wire. The substances showing thermo-luminescence when heated after exposure to cathode rays become luminous, as the heating continues the luminosity gradually fades away and finally disappears, and does not recur until the substance has been again exposed to cathode rays. The luminosity of these substances thus shows analogies with the leak of positive electricity from hot wire.

The small permanent leak which remains after the temporary one has been eliminated by preliminary heating increases rapidly with the temperature, and can like the negative leak be represented by an expression of the type $\theta^{\frac{1}{2}} \epsilon^{-\frac{\lambda}{\theta}}$. It does not however increase so rapidly with the temperature as the negative leak, so that at high temperatures the latter is much the more prominent.

* Richardson, *Phil. Mag.* 6. 8, p. 400, 1904.

The facts just mentioned suggest that the gas absorbed by the platinum and slowly given off when heated plays an important part in the carriage of the electricity from the wire, and we can easily understand how this gas, coming straight from the midst of a good conductor, would be ionised and able to carry the current. The emission of absorbed gas from the platinum is however, according to Berliner*, closely connected with the disintegration of the platinum wire which takes place when the wire is kept glowing and which is made evident by a deposit of platinum or platinum oxide on the walls of the tube and a diminution in the weight of the hot wire: the carriers of the electricity might thus be the dust or vapour of platinum escaping from the wire. This disintegration of the platinum has been studied by Berliner*, Elster and Geitel†, Nahrwold‡, and Stewart§: who have shown

(1) That the amount of disintegration produced in a given time by the incandescence of a platinum wire diminishes after prolonged heating.

(2) That the amount of this disintegration is very much increased by the presence of oxygen. It is exceedingly small in nitrogen and hydrogen; indeed, some of the experiments suggest that there would be no disintegration of a glowing platinum wire in these gases if every trace of oxygen could be removed from them. We may suppose that where oxygen is present slight oxidation takes place, producing a weathering of the surface which facilitates the disintegration of the metal.

The disintegration of the platinum can be easily shown by the effect of the incandescence of the wire on the condensation of clouds in the air in its neighbourhood. We owe this method to Aitken||. One simple way of showing this effect is to have a fine platinum wire fused in the expansion chamber in the cloud apparatus (Fig. 36). If the air be made dust-free when the wire is cold, then on sending a current through the wire so as to raise it to a red heat and then letting it cool, a dense cloud is produced by a very small expansion; as this expansion is much smaller than that required to produce a cloud on ions, there must be particles

* Berliner, *Wied. Ann.* xxxiii. p. 289, 1888; xxxv. p. 791, 1888.

† Elster and Geitel, *Wied. Ann.* xxxi. p. 109, 1887.

‡ Nahrwold, *Wied. Ann.* xxxi. p. 448, 1887; xxxv. p. 107, 1888.

§ Stewart, *Phil. Mag.* xlviii. p. 481, 1889.

|| Aitken, *Trans. Roy. Soc. Edin.* xxx. p. 337.

much larger than molecules in the neighbourhood of the wire. Unless the wire is very carefully cleaned an increase of temperature much less than that required to produce luminosity is sufficient to produce a cloud. This depends apparently upon dirt or moisture deposited on the wire, and Aitken's experiments show that this effect disappears when the wire has been cleaned by long-continued incandescence; no amount of incandescence seems however to destroy the cloud when the temperature of the platinum wire is raised to that corresponding to a red heat. Mr Owen*, who has recently made experiments in the Cavendish Laboratory on this point, finds that when the platinum wire is in air or oxygen there is, even after long-continued incandescence of the wire, always a cloud when the temperature of the wire is raised to about 300°C . In pure hydrogen however the wire has to be raised nearly to a red heat before this cloud is formed.

115. There is a close similarity between the laws of disintegration of the wire and those of the leak of positive electricity from it. We have already alluded to the effect of long-continued heating on the leak; the presence of oxygen has also a very marked effect. This can be shown in a striking way by observing the pressure at which a plate in the neighbourhood of the hot wire begins to acquire a negative instead of a positive charge. If the wire be not too hot, then at high pressures the plate will be charged positively; on exhausting the vessel a point will be reached where the positive charge begins to decrease, then it vanishes and finally is replaced by a negative charge. This change in the sign of the charge on the plate occurs at much higher pressures in hydrogen and nitrogen than in oxygen, where this reversal is difficult to obtain unless the wire be very hot. When the reversal of sign has been obtained in hydrogen or nitrogen the addition of a surprisingly small quantity of oxygen is sufficient to make the charge on the plate positive again. It is possible that part of the diminution in the positive leak produced by long-continued heating at low pressures may be due to the burning up of the oxygen, or when there is any grease present to the replacement of oxygen by the vapours of hydrocarbons liberated by the continuous heating. The increase in the positive electrification produced by oxygen is easily explained if there is any oxidation of the metal at a red heat; for in the oxide thus formed the

* Owen, *Phil. Mag.* [6], 6, p. 306, 1903.

oxygen carries the negative, the metal the positive charge; thus if the oxygen in the neighbourhood of the platinum wire got ionised by the heat, the platinum by combining with the negative but not with the positive oxygen ions would leave an excess of positive ions in the neighbourhood. That chemical action has a considerable effect on the electrification is confirmed by the observation of Branly that the oxides of metals give off at a dull red heat negative electricity, whereas metals give off positive; in the case of the oxides the chemical action which takes place is the dissociation of the oxide into the metal and oxygen, the oxygen ions carrying the negative charge and thus producing negative electrification round the wire. A similar explanation applies to the following result which I observed with the arc discharge: when the arc passed between terminals of bright copper there was an excess of positive electricity in the gas round the terminals; if however the terminals were thickly coated with oxide and placed in hydrogen the electrification in the gas was negative until the oxide was reduced; when this had been accomplished the electrification became positive.

116. A very small amount of chemical action is sufficient to produce very intense electrification, so that it might be urged that even in the best attainable vacuum there is sufficient gas to produce the electrification; that this positive electrification occurs in very good vacua is certain; in a vacuum so good that it was hardly possible to get any discharge through it with an induction coil giving an 8-inch spark, I have got the positive electrification from a red-hot platinum wire which had been kept glowing at a much higher temperature 8 hours a day for a week. Stronger evidence that the positive electrification is not due entirely to chemical action on the wire is afforded by a determination of the nature of the carriers of this charge; if the charge arose from chemical action we should expect the carriers to be the atoms or molecules of the gas. The following experiments show that although there are a few carriers of this character the majority of them are much larger and are probably molecules, or even larger masses of platinum. The method used to determine the mass of the carriers was the same as that used (see p. 135) to determine the mass of the negative carriers at high temperatures, inasmuch however as the mass of the positive carriers turns out

to be enormously greater than that of the negative ones, it is necessary in dealing with the positive leak to employ very much greater magnetic forces than those used in the previous experiments, and this involves some modifications in the conditions of the experiment. The arrangement used is shown in Fig. 45.

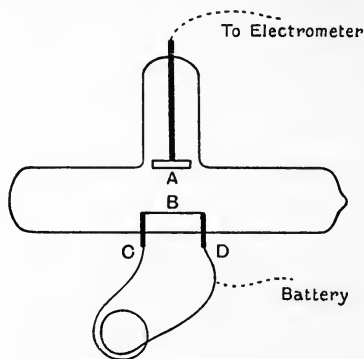

Fig. 45.

A is an insulated metal plate placed in the middle of a brass tube about 5 mm. in diameter; this plate is connected with a quadrant electrometer. *B* is a piece of platinum foil parallel to the plate and about 3 mm. from it; this foil can be raised to incandescence by an alternating electric current passing through the leads *C*, *D*. The current was produced by making the circuit connecting these leads loop round a transformer. By this method the hot wire and its leads could be easily insulated; the hot wire and the brass tube were connected with one terminal of a battery of small storage cells, the other terminal of which was connected with the earth. The current to the plate *A* from the hot wire was measured by the deflection produced in the electrometer in a given time; this deflection was measured for various potentials of the hot wire, with the magnetic field both on and off; the highest potential at which a given magnetic field produces an appreciable diminution gives, as is explained in Art. 67, the means of determining m/e —the ratio of the mass of the carrier to its charge. In the investigation of Art. 55 it was assumed that the electric force was uniform in the region in which the ions were moving; in the case of the hot wire there are so many ions all of one sign carrying the current that they disturb the potential gradient and make the force vary from point to point. We can easily

prove however that this inequality in the electric field will not impair the validity of the method. If the field is not uniform the paths of the ions will not be cycloids; the ions however, whether the field is uniform or not, after receding a certain distance d from their source, will be turned round by the magnetic force and begin to move back, thus they will never get further than d away from the source. Now if the plate on which the ions are received is at a distance greater than d from the hot metal which is the source of the ions, the magnetic field will produce a diminution in the current flowing into the plate, while if the distance is less than d , the magnetic field will produce no diminution in the leak. This critical distance d can be determined by comparing the currents with the magnetic field on and off: it is evidently the distance from the source at which the velocity of the ion parallel to the electric force vanishes. If x is the distance of an ion from the hot plate, X the electric force acting on the ion, H the magnetic force supposed to be uniform and parallel to the axis of z , then we have

$$m \frac{d^2x}{dt^2} = Xe + He \frac{dy}{dt} \dots\dots\dots(1),$$

$$m \frac{d^2y}{dt^2} = - He \frac{dx}{dt} \dots\dots\dots(2)$$

or
$$m \frac{dy}{dt} = - H e x,$$

since $\frac{dy}{dt} = 0$, when $x = 0$; substituting this value for $\frac{dy}{dt}$ in equation (1) we get

$$m \frac{d^2x}{dt^2} + \frac{H^2 e^2}{m} x = Xe.$$

Integrating with respect to x from $x = 0$ to $x = d$, we have, since dx/dt vanishes both when $x = 0$ and when $x = d$,

$$\frac{1}{2} \frac{H^2 e^2 d^2}{m} = e \int_0^d X dx;$$

if V is the difference of potential between the plates $V = \int_0^d X dx$;

hence
$$\frac{1}{2} \frac{H^2 e}{m} d^2 = V$$

or
$$\frac{e}{m} = \frac{2V}{H^2 d^2} \dots\dots\dots(3),$$

and thus even when the field is not uniform e/m is given by the same equation as in Art. 67.

In applying this method to the case of the leaking of positive electricity from a hot wire we find that enormously greater magnetic forces are necessary to produce any diminution upon the leak than were required to produce the same effect on the leak of negative electricity from a hot wire: and even with the greatest magnetic forces obtainable the effects of the magnetic field upon the rate of leak are sometimes scarcely appreciable. The effect of a magnetic field upon the positive leak, like the positive leak itself, is irregular, even when the temperature of the wire and the pressure of the gas are kept as constant as possible, small changes in conditions which it is very difficult to control or even to specify, producing great changes in the leak and in the effect of the magnetic field upon it. It is probable that these changes correspond to a change in the nature of the carriers of the electricity. In some cases the leak is not affected by the magnetic field even of 19000 units. When, however, the discharge is sensitive to the magnetic field the general nature of the effects observed with the apparatus already described and with a field of 19000 units is as follows, the pressure of the gas (air) being about $\cdot 007$ m.; the numbers given are only approximate as the irregular variations in the leak are so large as to make accurate measurement impossible. When the potential difference between the hot metal and the plate connected with the electrometer was small, say 3 or 4 volts, the leak was very nearly stopped by the magnetic field; with a potential difference of 10 volts the leak was reduced by the magnetic field to about one-quarter of its original value, the effect of the magnetic force upon the leak diminished as the potential difference increased but was appreciable until this reached about 120 volts. Thus in this case we see that while some of the carriers can reach the plate under a difference of potential of 10 volts, there are others which require a potential difference of 120 volts to do so. If e_1/m_1 be the ratio of the charge to the mass of the first carrier, e_2/m_2 that of the second, then putting in equation (3)

$H = 19000$, $d = \cdot 3$ and $V = 10 \times 10^8$ and 120×10^8 , we get

$$\frac{e_1}{m_1} = 60,$$

$$\frac{e_2}{m_2} = 720;$$

if e_1, e_2 were the same as the charge on a hydrogen ion, then m_1 and m_2 would be respectively about 170 and 14 times the mass of the hydrogen atom; these are limiting values of e/m , there are also intermediate values. These results indicate that the electricity is carried both by atoms of the metal (in this case platinum) and of the gas, the former predominating. The fact that in certain cases the rate of leak is not affected by the magnetic force even when the potential difference is reduced to one volt or less shows that in these cases the carriers have much larger mass than the molecule of platinum, they are probably platinum dust.

Rutherford* from experiments on the velocity of the ions through air at atmospheric pressure also came to the conclusion that carriers of very different kinds were at work in carrying the positive electricity from a hot metal.

Though the effect of the magnetic field on the rate of leak diminishes when the potential difference is increased and at one stage disappears, yet on still further increasing the potential a stage is reached where the magnetic force again produces a very considerable diminution in the rate of leak. This stage is closely connected with the way in which the rate of leak varies with potential difference; if we represent the rate of leak by the ordinates, the potential difference by the abscissæ of a point on a curve, then, as McClelland† has shown, the curve is of the type represented in Fig. 46 showing three well-marked stages: in the first the current increases rapidly with the potential difference, in the second the current is saturated and is independent of the potential

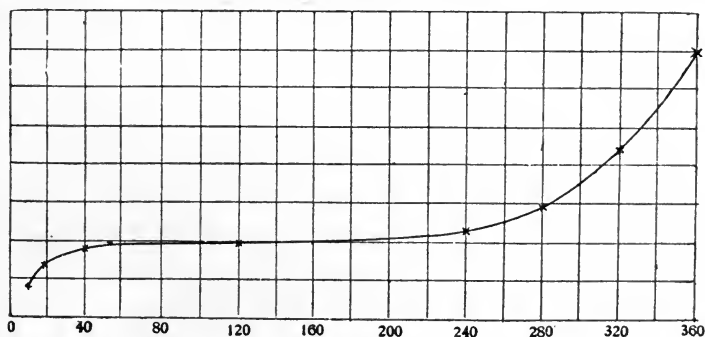

Fig. 46.

* Rutherford, *Physical Review*, xiii. p. 321, 1901.

† McClelland, *Proc. Camb. Phil. Soc.* xi. p. 296, 1902.

difference, in the third stage the current again increases rapidly. This increase is as we shall see due to the formation of fresh ions by the motion through the gas of ions coming from the hot plate; there are in this stage negative as well as positive ions between the electrodes. It is in the third stage that the magnetic field again produces a diminution in the rate of leak, the explanation of this is I think that the magnet stops the motion of the *negative* ions which are now helping to carry the current and which, as we have seen, are very much hampered by a magnetic field.

Elster and Geitel* found that the rate of positive leak was often indeed in their experiments generally increased, not diminished, by the magnetic field; with the apparatus described and arranged as on page 218, I only observed an increase in one case, *i.e.* when the temperature was high and the potential difference small. At a very high temperature negative as well as positive ions are produced at the plate; these negative ions are projected with great velocity, so that even if the plate has a small positive charge the negative ions coming from the plate will exceed the positive ones and a conductor in the neighbourhood will receive a negative charge. If the potential of the plate be raised until this conductor gets a positive charge, then the application of a magnetic field will often considerably increase the positive charge on the conductor; this increase is, however, due to the retardation of the stream of *negative* ions and not to the acceleration of the positive ones. If the metal tube in which the hot plate (Fig. 45) is contained is not connected with the hot plate but with the earth, then a magnetic field will often increase the rate at which the plate acquires a positive charge; this, however, is merely the diversion of positive ions from the tube to the cold plate by the magnetic field.

117. We could determine the value of e/m for the carriers of electricity by the following method, which does not require the application of a magnetic field, and which is applicable when the current is carried by ions of one sign and when the pressure of the gas is so low that we can neglect the resistance of the gas to the motion of the ions. Let us consider the case of a current between two parallel plates, one of which is the hot plate or other source of ions. Take the axis of x at right angles to the plate, let

* Elster and Geitel, *Wied. Ann.* xxxviii. p. 27, 1889.

V be the difference of potential between the hot plate and a point whose coordinate is x , ρ the density of the electricity. Then

$$\frac{d^2V}{dx^2} = -4\pi\rho \dots\dots\dots(1).$$

If v be the velocity of the ion at x , v_0 its velocity when starting from the plate, m its mass and e its charge, then

$$\frac{1}{2}m(v^2 - v_0^2) = Ve \dots\dots\dots(2);$$

but since all the ions are of one sign, i the current through unit area is equal to $v\rho$, hence from (1) and (2)

$$\left(v_0^2 + \frac{2e}{m} V\right) \left(\frac{d^2V}{dx^2}\right)^2 = 16\pi^2 i^2 \dots\dots\dots(3);$$

integrating this equation we have, if we write X for dV/dx ,

$$X^2 = C + \frac{8\pi i \cdot m}{e} \left\{v_0^2 + \frac{2e}{m} V\right\}^{\frac{1}{2}};$$

hence if X is the value at the cold plate, X_0 that at the hot, V the potential difference between the plates, and C the constant of integration,

we have
$$X^2 - X_0^2 = \frac{8\pi i \cdot m}{e} \left[\left\{v_0^2 + \frac{2e}{m} V\right\}^{\frac{1}{2}} - v_0 \right];$$

if X' and X_0' , i' and V' are corresponding values in a second experiment we have

$$X'^2 - X_0'^2 = \frac{8\pi i' \cdot m}{e} \left[\left\{v_0^2 + \frac{2e}{m} V'\right\}^{\frac{1}{2}} - v_0 \right];$$

hence if $(X^2 - X_0^2)/8\pi i = \xi$, $(X'^2 - X_0'^2)/8\pi i' = \xi'$,

we have
$$\frac{e^2}{m^2} \xi^2 + 2v_0 \frac{e}{m} \xi = \frac{2e}{m} V,$$

$$\frac{e^2}{m^2} \xi'^2 + 2v_0 \frac{e}{m} \xi' = \frac{2e}{m} V',$$

$$\frac{e}{m} \xi \xi' (\xi - \xi') = 2(V\xi' - V'\xi) \dots\dots\dots(4),$$

an equation by which we can determine e/m when we know ξ , ξ' , V , and V' . To determine ξ and ξ' we require to know the value of X at the two plates. This can be done as follows: as the pressure is very low we can produce by independent electrodes cathode rays in the vessel in which the leak is taking place; if we arrange these electrodes so as to allow a small pencil of these rays

to pass close to first one plate and then the other and measure the electrostatic deflection of the rays, we can from this deflection deduce the electric force and then by equation (4) the value of e/m .

Effect of the Gas on the rate of leak.

118. We have seen that in the best vacua we can produce, a metal when first it begins to glow gives off positive electricity and then at considerably higher temperatures negative electricity as well, the rate of emission of negative electricity increasing more rapidly with the temperature than that of the positive, so that at very high temperatures the negative is greatly in excess of the positive. Thus to make a metal emit positive electricity we have to communicate a certain amount of energy to its surface, a larger amount being required to make it give out negative electricity. When the incandescent metal is surrounded by gas at an appreciable pressure we find that the nature of the gas has a very distinct effect upon the amount of leak. The author* has shown that gases such as the vapours of iodine and bromine, chlorine, hydriodic acid gas, hydrobromic acid gas, hydrochloric acid gas, the vapours of potassium iodide, sal-ammoniac, sodium chloride, potassium chloride, which are dissociated by heat conduct electricity on quite a different scale from those which like air, hydrogen or nitrogen do not suffer any dissociation; in the latter case the leak is not greater than could be accounted for by the emission of ions from the electrodes, in the former case it is very much greater, showing that the gas itself is ionised.

The vapours of many metals conduct very well; of the metals I tried, sodium, potassium, thallium, cadmium, bismuth, lead, aluminium, magnesium, tin, zinc, silver and mercury; sodium and potassium had the highest conductivity; while the conductivity of the vapours of mercury, tin, thallium, did not seem any greater than that of air; so that the small conductivity actually observed might have been due to the presence of air and not to the vapour of the metal.

* J. J. Thomson, *Phil. Mag.* v. 29, pp. 358, 441, 1890.

The distribution of potential near Glowing Electrodes.

119. We shall confine ourselves to the case when the current passes between two parallel plane electrodes. If one of these be hot and the other cold—too cold to emit either positive or negative ions—the current will be carried entirely by ions of one sign, the electric force will therefore increase continuously from the hot plate to the cold one, and (see p. 207) the distribution of potential will be represented by a curve similar to that in Fig. 47, the lower electrode being the hotter of the two.

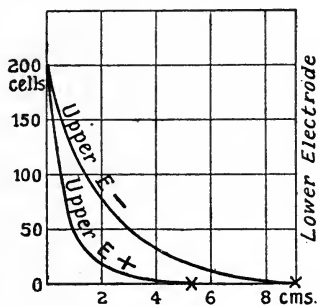

Fig. 47.

Similar curves will represent the distribution of potential when both plates are hot provided the temperature of the negative plate is not high enough for negative as well as positive ions to be emitted by the plate, for it is evident that in this case the current has to be carried entirely by positive ions. The shape of the

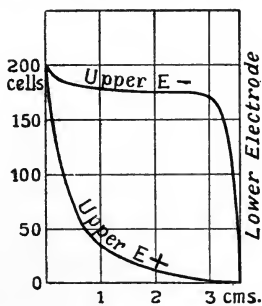

Fig. 48.

curve will change when both plates are hot enough to emit ions and the negative so hot that negative as well as positive ions are

emitted. For, when the field is strong most of the positive ions will be driven from the positive plate and the negative ions from the negative plate; there will be an excess of positive ions at the negative plate, so that in its neighbourhood the potential curve will be concave, and an excess of negative ions at the positive, which will make the potential curve convex. The potential curve will be like the higher curve in Fig. 48, the straight part in the middle showing that except close to the plates there are approximately equal numbers of positive and negative ions present. Curves similar to this have been obtained by H. A. Wilson* and Marx†.

When the hot plates are made of different materials, Pettinelli and Marolli‡ have shown that the magnitude of the current depends upon which metal is used as the cathode, thus with electrodes of carbon and iron the current when the carbon was cathode was three or four times the current when the iron was cathode; they state that the current is greatest when the more porous substance is used as the cathode. These effects are much more marked at high than at low temperatures; it is probable that they do not commence until the temperature is high enough to produce negative ions.

120. The difference in the velocities of the ions produces very marked unipolar effects in the current, *i.e.* the current with the same electromotive force is very much greater in one direction than the opposite; we can very easily see the reason for this, for take the case where only one electrode is hot enough to emit ions, then we see from equation (2), p. 209, that the current is proportional to the velocity under unit force of the ion carrying the current. As the velocity of the negative ion is greater than that of the positive, the current will be greater when it is carried by the negative ions than when it is carried by the positive. It must be remembered that the ratio of the velocities of the ions produced by an incandescent metal depends very largely upon the temperature. Thus McClelland§, who measured the ratio in air at the ordinary temperature (the ions having been blown from the

* H. A. Wilson, *Phil. Trans. A*, 192, p. 499, 1899.

† Marx, *Ann. der Phys.* ii. p. 768, 1900.

‡ Pettinelli and Marolli, *Atti della Accad. dei Lincei*, v. p. 136, 1896.

§ McClelland, *Proc. Camb. Phil. Soc.* x. p. 241, 1899.

incandescent wire to the place of observation), found that the velocity of the negative ions was only about 25 per cent. greater than that of the positive; while H. A. Wilson*, who measured this ratio for the ions produced when salts were volatilised in flames at high temperatures or in hot air, found that at 1000° C. the velocity of the negative ion was for the salts of the alkali metals 3·6 and for those of the alkali earths seven times that of the positive. At 2000° C. the velocity of the negative ions for the alkali metals was seventeen times that of the positive. The absolute values were still more different; thus McClelland found for the velocity under a potential gradient of a volt per cm. values ranging from ·006 cm./sec. to ·03 cm./sec., while Wilson at 1000° C. found 26 cm./sec. for the negative, and 7·2 cm./sec. for the positive; at 2000° C. the values were respectively 1030 cm./sec. and 62 cm./sec.

* H. A. Wilson, *Phil. Trans. A*, 192, p. 499, 1899.

CHAPTER IX.

IONISATION IN GASES FROM FLAMES.

121. It has been known for more than a century that gases from flames are conductors of electricity: a well-known application of this fact—the discharge of electricity from the surface of a non-conductor by passing a flame over it—was used by Volta in his experiments on Contact Electricity. We shall not attempt to give any historical account of the earlier experiments on this subject, because the conditions in these experiments were generally such that the interpretation of the results obtained is always exceedingly difficult and often ambiguous: the reason of this is very obvious—to investigate the electrical conditions of the flame wires are generally introduced, these become incandescent and so at once add to the electrical phenomena in the flame the very complicated effects we have been discussing in the last chapter.

The gases which come from the flame, even when they have got some distance away from it and have been cooled by the surrounding air, possess for some time considerable conductivity, and will discharge an insulated conductor placed within their reach. The conductivity can be entirely taken out of the gas by making it pass through a strong electric field, this field abstracts the ions from the gas, driving them against the electrodes so that when the gas emerges from the field, although its chemical composition is unaltered, its conducting power is gone. This result shows too that no uncharged radio-active substances, such as emanate from thorium and some other substances, are produced in the flame; these would not be taken out by the field, so that if they existed the conductivity of the gas would not be destroyed by the field. If not driven out of the gas by an electric field the ions are fairly long lived. Thus in some experiments Giese

noticed that the gas retained appreciable conductivity 6 or 7 minutes after it had left the flame. The ions stick to any dust there may be in the air and then move very slowly so that their rate of recombination becomes exceedingly slow. McClelland* has shown that the velocity of the ions under a given electric force decreases very much as they recede from the flame; thus close to the flame the velocity under the force of a volt per centimetre was $\cdot 23$ cm./sec., while some distance away from it the velocity was only $\cdot 04$ cm./sec.

In order that a conductor should be discharged by a flame it is not necessary that it should be placed where the gases from the flame would naturally strike it—thus for example it will be discharged if placed underneath a Bunsen flame. The explanation of this is that the electric field due to the charged conductor drags out of the flame and up to the conductor ions of opposite sign to the charge.

This ionised gas is produced by flames of coal gas whether luminous or not, by the oxy-hydrogen flame, by the alcohol flame of a spirit lamp, by a flame of carbonic oxide; it is not however produced in very low temperature flames such as the pale lambent flame of ether. Thus to produce the ionised gas high temperature as well as chemical combination is required. That chemical combination alone is insufficient to produce ionisation is shown by the case of hydrogen and chlorine which do not conduct even when combining under ultra-violet light†. Braun‡ has shown that in the explosive wave produced in the combination of certain gases there is ionisation, but in this case there is also very high temperature.

In the coal-gas flame the part where the gas comes in contact with the air and where there is most combustion is positively electrified, while the interior of the flame is negatively electrified; this accounts for the effect produced by holding a negatively electrified body near the flame, the luminous part turns to the negative body, and if this is near, stretches out until it comes into contact with it; if the flame be placed between two

* McClelland, *Phil. Mag.* v. 46, p. 29, 1898.

† J. J. Thomson, *Proc. Camb. Phil. Soc.* xi. p. 90, 1901.

‡ Braun, *Zeitschrift für Physikalische Chemie*, xiii. p. 155, 1894.

oppositely charged plates the bright outer portion of the flame is attracted towards the negative plate while the inner portion moves, but less markedly, towards the positive plate. This effect is illustrated by Fig. 49 taken from a paper by Neureneuf*. In

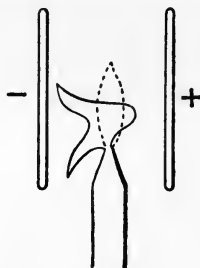

Fig. 49.

some experiments made by Holtz†, one of which is figured in Fig. 50, the flame was divided by the electric field between the

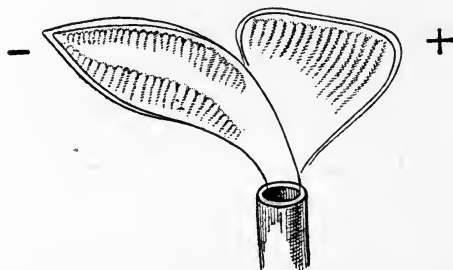

Fig 50.

plates into two sheets; the reader will find many other interesting experiments on the effect of an electric field on the shape of flames in the papers by Neureneuf and Holtz. It appears from these results that in the bright portion of the flame where combustion is taking place there is an excess of positive electricity, while in the unburnt coal gas there is an excess of negative, a fact discovered a long time ago by Pouillet‡. If the hydrogen and oxygen were ionised by the heat, then since negative ions of oxygen combine with positive ions of hydrogen to form water, the

* Neureneuf, *Annales de Chim. et de Phys.* v. 2, p. 473, 1874.

† Holtz, *Carl Répert.* xvii. p. 269, 1881.

‡ Pouillet, *Ann. de Chim. et de Phys.* xxxv. p. 410, 1827.

negative oxygen ions and the positive hydrogen ones would get used up, and there would be an excess of positive electricity in the oxygen and of negative in the hydrogen. It is possible too that at a temperature corresponding to that of vivid incandescence in a solid the molecules of a gas may like those of a solid give out the negative corpuscles, on this account there would be a tendency for the hotter parts of the flame to be positively, the colder negatively, electrified. When as in luminous flames we have small particles of solid carbon raised to the temperature of vivid incandescence the electrical effects are complicated by those due to incandescent solids which as we have seen in the last chapter are very considerable.

When two wires connected together through a sensitive galvanometer are placed in different parts of the flame currents flow through the galvanometer; suppose one of the wires is placed in the cool inner portion of the flame where there is an excess of negative electricity, while the other wire is placed at the outside of the flame where there is an excess of positive electricity, there will, neglecting any ionisation due to the wire, be a current from the hot outer portion of the flame to the cool inner portion through the galvanometer: the wire in the outer portion will however certainly be raised to incandescence, if its temperature keeps so low that only positive ions are produced at its surface, then there will on this account be a current of electricity from the hot to the cool part of the flame through the flame and thus in the opposite direction to the previous current. If however the wire got so hot that it emitted more negative than positive ions the effect of the incandescence of the wires would be to increase instead of diminishing the current due to the flame itself. Thus we see that these currents will vary in a complex way with the temperature. For an account of the currents which can thus be tapped from a flame and for other electrical properties of flames we must refer the reader to the papers of Erman*, Hankel†, Hittorf‡, Braun§, Herwig||, and

* Erman, *Gilbert. Ann.* xi. p. 150, 1802; xxii. p. 14, 1806.

† Hankel, *Pogg. Ann.* lxxxi. p. 213, 1850; cviii. p. 146, 1859.

‡ Hittorf, *Pogg. Ann.* cxxxvi. p. 197, 1869; Jubelbd. p. 430, 1874.

§ Braun, *Pogg. Ann.* cliv. p. 481, 1875.

|| Herwig, *Wied. Ann.* i. p. 516, 1877.

especially of Giese*, who was the first to suggest that the conduction of electricity through flames and hot gases was due to the motion of charged ions distributed through the gases: there is a very complete account of these researches in Wiedemann's *Elektricität*, Bd. iv. B, chap. 4.

Conduction of electricity through flames.

122. The passage of electricity through flames has been investigated by Arrhenius†, H. A. Wilson‡, Marx§, Starke||, Moreau¶, Stark**, Tufts††, and Tufts and Stark‡‡. The most important phenomena of flame conduction are as follows.

Distribution of electric intensity between the electrodes.

There is a very intense electric field close to the negative electrode and a weak uniform field between the electrodes, the field

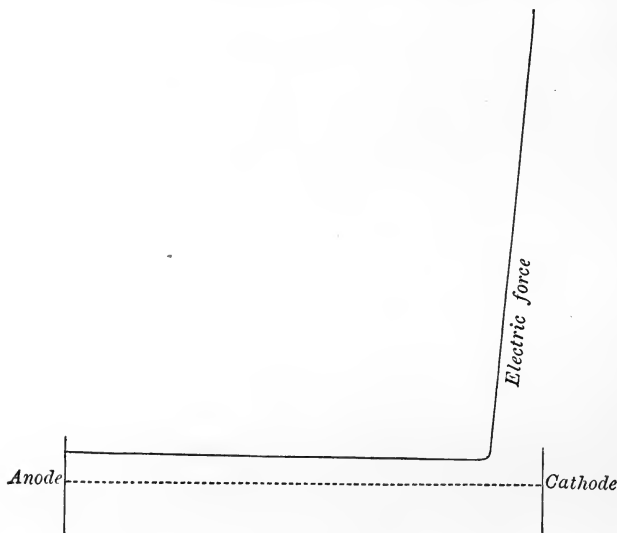

Fig. 51.

* Giese, *Wied. Ann.* xvii. pp. 1, 236, 519, 1882; xxxviii. p. 403, 1889.

† Arrhenius, *Wied. Ann.* xliiii. 18, 1891.

‡ H. A. Wilson, *Phil. Trans.* A, 192, 499, 1899; *Proceedings Physical Society.*

§ Marx, *Ann. d. Phys.* ii. 768, 798, 1900; *Verh. d. D. Phys. Ges.* v. 441, 1903.

|| Starke, *Verh. d. D. Phys. Ges.* v. 364, 1903; vi. 33, 1904.

¶ Moreau, *Ann. de Chimie et de Physique*, vii. 30, p. 1, 1903.

** Stark, *Physik. Zeitschr.* v. 83, 1904.

†† Tufts, *Physik. Zeitschr.* v. 76, 1904.

‡‡ Tufts and Stark, *Physik. Zeitschr.* v. 248, 1904.

near the positive electrode although not nearly so intense as that close to the negative is stronger than that at some distance from either electrode. The distribution of electric intensity is of the type shown in Fig. 51.

Fig. 52 represents the distribution of electric potential measured by H. A. Wilson between electrodes 18 cm. apart in a long flame from a quartz tube burner. The difference of potential between the electrodes was 550 volts and it will be noticed that a drop of 450 volts occurs quite close to the cathode.

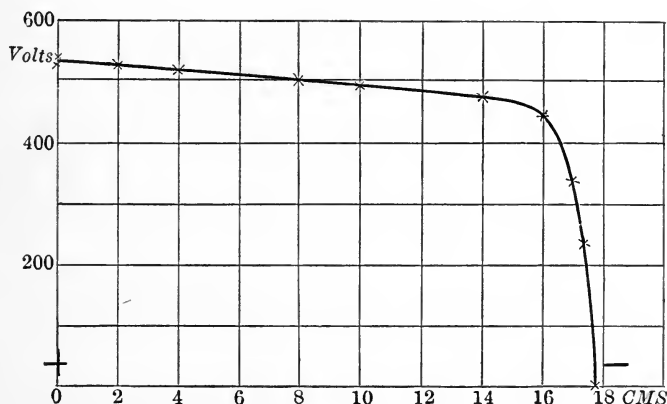

Fig. 52.

If X is the electric intensity at a point x , q the amount of ionisation per unit volume, k_1 , k_2 the velocities of the positive and negative ions under unit force, m , n the number of positive and negative ions per unit volume, we have by equation (7), p. 86,

$$\frac{d^2X^2}{dx^2} = 8\pi e(q - \alpha nm) \left(\frac{1}{k_1} + \frac{1}{k_2} \right).$$

Since X is constant along the flame $\frac{d^2X^2}{dx^2}$ vanishes, hence

$$q = \alpha nm.$$

Thus the ionisation balances the recombination; as recombination of the ions is certainly taking place in the flame it follows that there must be ionisation throughout the flame. In the first edition of this book the view was taken that by far the greater part of the ionisation took place in the immediate neighbourhood of the

glowing electrodes. Some of the results obtained by H. A. Wilson, especially the fact that even with large potential differences the current was almost independent of the distance between the electrodes, were readily explained on this view; while assuming that the large potential difference was able to saturate the current they were inconsistent with the existence of uniform ionisation throughout the flame, with such ionisation the saturation current would be proportional to the distance between the electrodes. It appears however from the preceding results that even when the potential difference is large the electric field is weak except close to the cathode, so that there is no approach to saturation throughout the flame. We investigated in Art. 48 the relation between the current and the potential difference when the velocity of the negative ion is very much greater than that of the positive; as this is the case in flames, we have by equation (7) of Art. 48

$$X^2 = \frac{\alpha i^2}{q e^2 k_2^2} + \frac{\alpha i (i - i_0)}{q e^2 k_1 k_2} \epsilon^{-\frac{8\pi e^2 q k_2}{i a} x} \dots\dots\dots(1),$$

where i_0 is the number of corpuscles coming from unit area of the incandescent cathode per second, x is the distance from the cathode of the place where the electric intensity is X .

This equation represents a distribution of the electric intensity of the same kind as that found in flames, the first term on the right-hand side of the equation represents the uniform field, the second term the variable part near the cathode; since k_1 , the velocity of the positive ion under unit force, is very small compared with k_2 , the velocity of the negative ion, we see that unless i_0 is nearly equal to i the electric force at the cathode when $x = 0$ will be large compared with that in the uniform part of the field.

If we compare this formula with the results of H. A. Wilson's* experiments we are led to the conclusion that so far from there being an excess of ionisation close to the cathode the ionisation is less there than in the body of the flame. Let us take as an example the case represented by the curve in Fig. 52. Here the electric force in the uniform part of the field was about 8 volts per cm., or, as the quantities in equation (1) are supposed to be expressed in electrostatic units, 8/300. The current between the

* H. A. Wilson, *Phil. Mag.* [6], 10, p. 476, 1905.

electrodes, which were discs 1 cm. in diameter, was $270 \times 8.8 \times 10^{-9}$ amperes, so that the current per unit area in electrostatic units was $\frac{4}{\pi} \times 270 \times 8.8 \times 3$. Thus we have

$$\frac{8}{300} = \left\{ \frac{\alpha}{qe^2} \right\}^{\frac{1}{2}} \frac{1}{k_2} \frac{4}{\pi} 270 \times 8.8 \times 3,$$

so that

$$\left(\frac{\alpha}{qe^2} \right)^{\frac{1}{2}} \frac{1}{k_2} = \frac{\pi}{4 \times 27 \times 10^4}$$

approximately.

The index of the exponential term is $\frac{8\pi e^2 q k_2}{i\alpha} x$; substituting the values of i and α/qe^2 , we find that this is equal to $\frac{324 \times 10^6}{k_2} x$.

Now Wilson has shown that the velocity of the negative ion under a force of a volt per centimetre is about 1000 cm./sec.; k_2 is the velocity under unit electrostatic force, *i.e.* 300 volts per centimetre, *i.e.* k_2 is about 3×10^5 . Substituting this value for k_2 we find that the exponential term is ϵ^{-1080x} , with this value of the exponential term the field would become practically uniform at a distance not exceeding a very small fraction of a millimetre from the cathode. An inspection of Fig. 52 shows that the variable part of the field extends to quite 1 cm. from the cathode, a result quite inconsistent with its representation by the term ϵ^{-1080x} . We have assumed that the q occurring in the exponential term is equal to that in the constant term, if however the ionisation is variable from point to point this will not be the case, the q occurring in the exponential term refers to the ionisation near the cathode, if this is less than the q in the body of the flame the index of the exponential term will be less than the value we have calculated. Now the electrode will conduct heat from the flame and will therefore cool it. The process of ionisation is however analogous to the dissociation of a diatomic gas into atoms, and the expression for the amount of this dissociation

contains a factor $e^{-\frac{\alpha}{\theta}}$ where θ is the absolute temperature, so that this factor varies very rapidly with the temperature. Thus a comparatively slight cooling of the gas near the cathode would produce a great diminution in q , this diminution in q would

diminish the index in the exponential term in equation (1) and thus increase the thickness of the variable part of the electric field.

We have seen on page 97 that equation (1) leads to the following relation between V the potential difference between the plates, i the current through unit area and l the distance between the electrodes :

$$V = \frac{il}{k_2} \left\{ \frac{\alpha}{qe^2} \right\}^{\frac{1}{2}} + \frac{i \sqrt{i(i-i_0)}}{k_1^{\frac{1}{2}} k_2^{\frac{3}{2}}} \frac{1}{8\pi} \left(\frac{\alpha}{qe^2} \right)^{\frac{3}{2}} \dots\dots\dots(2).$$

When i_0 is small compared with i , this equation becomes

$$V = \frac{il}{k_2} \left(\frac{\alpha}{qe^2} \right)^{\frac{1}{2}} + \frac{i^2}{8\pi k_1^{\frac{1}{2}} k_2^{\frac{3}{2}}} \left(\frac{\alpha}{qe^2} \right)^{\frac{3}{2}} \dots\dots\dots(3).$$

The first term represents the fall of potential in the body of the flame, this is proportional to the current; the second term represents the drop of potential at the cathode, this is proportional to the square of the current. H. A. Wilson has shown that the relation between the potential difference and the current can be expressed with great accuracy by an equation of the type

$$V = Ai + Bi^2.$$

Conductivity of Gases containing Salt Vapours.

123. When the vapours of salts are introduced into a flame the conductivity between metallic terminals is very greatly increased, and the electrical properties are simpler and more regular than in pure flames; the laws of the flow of electricity through these salt-laden flames have been investigated by Arrhenius* and H. A. Wilson†. The method—devised by Arrhenius and adopted by Wilson—of introducing the salt into the flame was as follows: a dilute solution of the salt was sprayed into exceedingly fine drops by a Gouy sprayer, the spray got well mixed with the coal gas on its way to the burner, and in the flame the water evaporated and the salt vaporised. The amount of salt supplied to the flame in unit time was estimated by determining

* Arrhenius, *Wied. Ann.* xlii. p. 18, 1891.

† H. A. Wilson, *Phil. Trans. A*, 192, p. 499, 1899.

the rate at which a bead of salt introduced into an equal and similar flame so as to produce the same coloration as that produced by the spray in the original flame burnt away. The salts used were chiefly the haloid and oxy-salts of the alkali metals and earths. The conductivity due to the salt was determined by subtracting from the current observed when the salt was in the flame the current with the same electromotive force in the pure flame. It was found that when the concentration of the solutions is small, equivalent solutions* of all salts of the same metal impart the same conductivity to the flame. With large concentration this is no longer the case, the oxy-salts giving greater conductivity than the haloid salts. According to Arrhenius all the salts in the flame are converted into hydroxides, so that whatever salts are used, the metal in the flame always occurs in the same salts. The relation between the current and the electromotive force is represented by Fig. 53 taken from Wilson's paper. In a later paper Wilson has shown that these curves are parabolas.

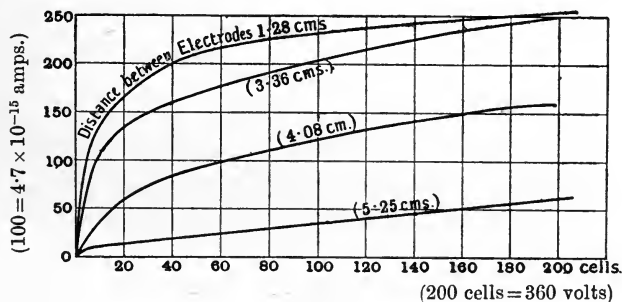

Fig. 53.

When the salt vapour is put into the flame by means of a bead of salt on a platinum wire, very little effect on the current is produced when the bead is inserted in the body of the flame, whereas a very large increase in the current occurs when the bead is put close to the cathode. This does not however necessarily mean that the salt vapour is not ionised except close to the cathode, for we have seen on page 99 that this would occur if the ionisation were the same at all parts of the flame provided, as is the case in

* Equivalent solutions are those in which the weight of salt per litre is proportional to the molecular weight of the salt.

flames, the velocity of the negative ion is very much greater than that of the positive. When this is the case the distribution of the electric force is such that increased ionisation produces little effect except close to the cathode. That there is increased ionisation when the salt is placed in the body of the flame is shown very clearly by an experiment made by H. A. Wilson; he measured the potential difference between two neighbouring points a and b in a pure flame and found that the electric force was about 1.6 volts per cm., he then introduced between a and b a bead of salt and found that though the current was not appreciably altered the electric force between a and b had fallen to a very small fraction of a volt per cm.; since the electric force is equal to

$$\frac{i}{k_2} \sqrt{\frac{\alpha}{qe^2}},$$

this result would indicate that the value of q in the salted flame must be some hundreds of times its value in the unsalted.

If we write equation (3) in the form

$$V = \frac{il}{q^{\frac{1}{2}}} \left(\frac{\alpha}{k_2^2 e^2} \right)^{\frac{1}{2}} + \left(\frac{i}{q^{\frac{1}{2}}} \right)^2 \frac{1}{q^{\frac{1}{2}}} \left(\frac{\alpha}{k_2 e^2} \right)^{\frac{3}{2}} \frac{1}{8\pi k_1^{\frac{1}{2}}},$$

we see that when V is constant $i/q^{\frac{1}{2}}$ must increase as q increases, and that for large values of i , i will vary approximately as $q^{\frac{3}{2}}$. Since $i/q^{\frac{1}{2}}$ increases with q we see that for a constant difference of potential the electric force in the body of the flame will increase with q while the fall of potential at the cathode will diminish. Thus the potential gradient in the uniform part of the flame will be steeper in a salted flame than in a pure one, while the cathode fall will be less; we see too that the thickness of the layer near the cathode where the electric force is variable is thinner in a salted than in a pure flame, so that the uniform part of the field comes closer to the cathode.

Tufts* has shown that if the cathode is covered with lime the fall of potential is very much reduced; this is doubtless owing to the fact that incandescent lime, as Wehnelt has shown, gives out

* Tufts, *Physik. Zeitschr.* v. 76, 1904.

a copious supply of corpuscles, so that i_0 in equation (2), p. 236, may be comparable with i , and therefore the potential fall at the cathode small compared with the fall when $i_0 = 0$.

The conductivity given to the flame by the salts of the different alkali metals under the same condition as to temperature, potential difference and concentration.

124. The Cæsium salts conduct the best, and then follow in order the salts of Rubidium, Potassium, Sodium, Lithium, and Hydrogen. The order of the conductivities is thus the same as that of the atomic weights of the metals; the difference between the metals is very large, as is shown by the following table given by H. A. Wilson:

Potential Difference	Chlorides			Nitrates		
	5·60	·795	·237	5·60	·795	·237
	Current			Current		
Cæsium	123	60·5	22·2	303	115	36·6
Rubidium	41·4	26·4	11·3	213	82·4	25·9
Potassium	21·0	13·4	5·75	68·4	29·3	9·35
Sodium	3·49	2·45	1·15	3·88	2·67	1·32
Lithium	1·29	·87	·41	1·47	·99	·53
Hydrogen	·75	...	·27			

On the Variation of Conductivity with the strength of the Solution.

125. Arrhenius came to the conclusion that, using the same salt, the conductivity was proportional to the square root of the concentration, while H. A. Wilson considered that the application of this simple law was restricted in the case of the oxy-salts to extremely dilute solutions, and that although the range of its application was more extended in the case of the haloid salts, the agreement was only approximate. If we refer to the theory of the conduction just given we find that the conductivity when the current is far from saturation is proportional to $q^{\frac{1}{2}}$, while for large currents it is proportional to $q^{\frac{2}{3}}$, where q is the number of ions produced per second in a cubic centimetre of the gas. In the case of the salt vapour q will be proportional to the number of molecules of salt in a cubic centimetre of the gas, and will thus be

proportional to the strength of the solution. Curves given in Fig. 54 taken from a paper by Smithells, Dawson and Wilson* show the variations of the current with the strength of the solution for a series of salts.

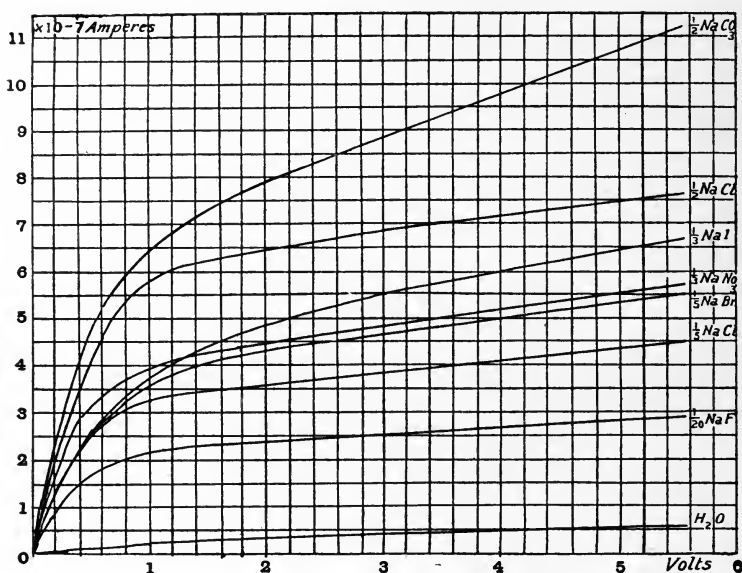

Fig. 54.

Velocity of the Ions.

126. The velocity of the ions in flames containing salt vapours has been determined by H. A. Wilson†, who used a method of which the principle is as follows. Suppose that in a flame we have two electrodes one vertically over the other, and that we introduce a bead of salt just underneath the upper electrode, the vapour from this bead will be carried along by the upward rush of gases in the flame, and unless the ions in the salt vapour are driven downwards by the electric field between the electrodes, none of them will reach the lower electrode. If however the ions from the salt do not reach the electrode the current between the electrodes will be unaffected by the presence of the salt. Thus

* Smithells, Dawson and Wilson, *Phil. Trans. A*, 193, p. 89, 1900.

† H. A. Wilson, *Phil. Trans. A*, 192, p. 499, 1899.

when the potential difference between the electrodes is small the current will not be increased by the introduction of the salt, but as soon as the electric force between the electrodes is sufficient to drive one of the ions against the blast in the flame, the current will be increased by the bead of salt. This is illustrated by the curve in Fig. 55 taken from Wilson's paper; we see that when

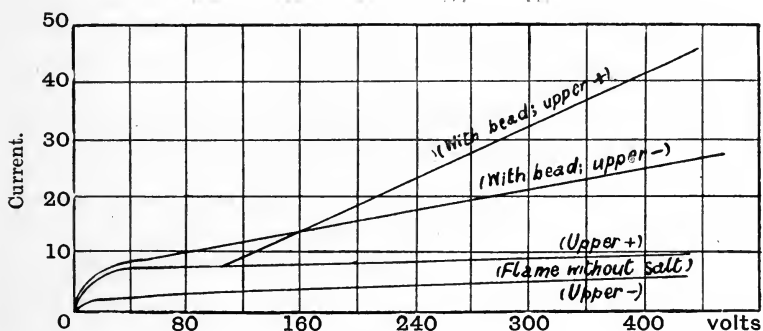

Fig. 55.

the upper electrode was positive the current was not increased by the bead until the potential difference between the electrodes was about 100 volts, while for greater differences of potential the bead produced a substantial increase in the current. Thus when there was a difference of 100 volts between the electrodes, the smallest electric force in the space traversed by the ion must be just sufficient to give to the positive ion a downward velocity equal to the upward velocity of the gas in the flame. Since the electric field is not uniform between the electrodes (see p. 225), it is necessary to measure the distribution of potential between the electrodes in order to determine the minimum electric force; when this and the upward velocity of the gas in the flame are known we can determine the velocity of the ions in a flame under a given electric force. By this and similar methods Wilson deduced the following values for the velocities of the ions under an electric force of a volt per centimetre.

In a flame whose temperature was estimated to be about 2000°C ., the velocity of the negative ion, whatever salts were put in the flame, was about 1000 em./sec.

The velocities of the positive ions of salts of Cæsium, Rubidium,

Potassium, Sodium, and Lithium were all equal, and were about 62 cm./sec.

In a stream of hot air whose temperature was estimated at 1000° C. the following results were obtained for the velocities under a potential gradient of 1 volt per cm.

Negative ions	26 cm./sec.
Positive ions of salts of Li, Na, K, Rb, and Cs	7·2 cm./sec.
Positive ions of salts of Ba, Sr, and Ca ...	3·8 cm./sec.

The absolute numbers must be regarded as only approximately true, the relative values are probably much more accurate.

The velocities are very much less at 1000° C. than they are at 2000° C., but we notice that while the negative ion at the lower temperature moves at only 1/40 of its pace at the higher, the velocity of the positive ion is by the same fall in temperature only reduced to about 1/8·5 of its value.

These determinations of the velocity throw some light on the character of the ions; for suppose e is the charge of electricity on the ion, X the electric force acting upon it, the mechanical force acting on the ion is equal to Xe ; if λ is the mean free path of the ion, v its velocity of translation, then the time between two collisions is λ/v , and in this time the force acting upon it will give it a velocity in the direction of the force equal to $Xe\lambda/vm$, where m is the mass of the ion; the average velocity parallel to X due to the electric force will therefore be $Xe\lambda/2vm$: and this will be the velocity with which the ion will, under the electric force, move through the gas. The equal velocity of all negative ions from whatever source they may be derived might at first sight seem to indicate that, as Arrhenius supposed, all the salts were converted to hydroxides in the flame, and that the negative ion was in every case the radicle OH: let us calculate what on this supposition would be the velocity of the negative ion at a temperature of 2000° C. We do not know the free path of OH through a mixture of coal gas and air, but as the free path of the molecule H_2 through hydrogen at 0° C. and at atmospheric pressure is $1\cdot8 \times 10^{-5}$ cm., and the free path of O_2 through oxygen under the same circumstances is $1\cdot06 \times 10^{-5}$ cm., we may as a rough approximation take for the mean free path of OH through

the mixture the value 1.4×10^{-5} cm. at 0°C. ; at 2000°C. λ the mean free path would be this value multiplied by $2273/273$, *i.e.*, 1.2×10^{-4} . To get the value of v we remember that mv^2 is the same for all gases at the same temperature, while at different temperatures it is proportional to the absolute temperature. For O_2 at 0°C. $v = 4.25 \times 10^4$ cm./sec., hence for OH at 0°C. $v = 5.6 \times 10^4$ cm./sec., and for OH at 2000°C. $v = 1.6 \times 10^5$: e/m for OH is equal to 1.1×10^3 , hence substituting these values in the expression $Xe\lambda/2vm$ and putting $X = 10^8$ we find for the velocity under the potential gradient of one volt per cm. 37 cm./sec.: the actual velocity is as we have seen 1000 cm./sec.: hence we conclude that the radicle OH cannot be the carrier of the negative charges. The great velocity of the negative ions at these high temperatures points to the conclusion that the negative ions start as corpuscles and gradually get loaded by molecules condensing round them; at temperatures as high as 2000° the time they exist as free corpuscles is an appreciable fraction of their life; while they are free corpuscles they have an exceedingly large velocity, so that though this is enormously reduced when they become the nucleus of a cluster, their average velocity is very considerable. At low temperatures condensation takes place much sooner, so that the average velocity is lower.

The fact that under an electric field the velocities of the positive ions of all the salts of the univalent metals are the same, shows that these too become the nucleus of a group whose size only depends upon the charge on the positive ion; since the velocities of the positive ions for the divalent metals while equal among themselves are less than those of the monovalent metals, we conclude that these divalent ions become the centres of clusters more complex than those which collect round the monovalent ions.

Determinations of the velocities of the ions in flames have also been made by Marx*, he finds for the velocity of the negative ion the same value as Wilson, *i.e.* 1000 cm./sec. under a potential gradient of a volt per centimetre; he gets however for the positive ions under the same gradient considerably larger values than Wilson, *i.e.* 200 cm./sec. instead of 62 cm./sec. A calculation similar to that just given for the velocity of the radicle OH

* Marx, *Ann. der Phys.* ii. p. 768, 1900.

shows that a velocity of 200 cm./sec. is of the same order as the velocity at 2000° C. of an atom of hydrogen in an electric field.

Moreau* has also determined the velocities of the ions in flames at temperatures from 1600 to 1700 C., he finds the velocity of the positive ion 80 cm./sec. under a force of one volt per cm. The velocity of the negative ion he finds to be greater the lower the atomic weight of the salt in the metal, unless the quantity of salt in the flame is very small.

Transverse Electromotive Force produced by a magnetic field acting on a flame carrying a current.

127. If an electric current is flowing through a flame parallel to the direction x , and a magnetic force at right angles to this direction, say parallel to the direction y , is applied to the flame a transverse electromotive force is produced which is at right angles to both x and y . This electromotive force has been detected and measured by Marx†. The general explanation of this effect, which is analogous to the 'Hall' effect in metals, is easy; the calculation of its magnitude except in a few special cases is however beset by difficulties.

As there is a current parallel to x flowing through the flame, the average direction of the positive ions will be along, say, the positive direction of x , that of the negative ions in the opposite direction. Let V be the average velocity of the positive ions, V' that of the negative, if these are moving in a magnetic field where the magnetic force H is parallel to y , they will be subject to mechanical forces tending to move them in the same direction, this direction being parallel to z , at right angles to both x and y . The magnitudes of the mechanical forces acting on the positive and negative ions are respectively HeV and HeV' , where e is the charge on an ion. The displacement of the ions under these forces will (if V is not equal to V') produce a current of electricity through the flame parallel to z ; if however the ions cannot escape in this direction the current will soon stop, as the accumulation of ions will produce a back pressure and an electrostatic

* Moreau, *Journal de Physique* [4], ii. p. 558; *Ann. de Chimie et de Phys.* [7], xxx. p. 5.

† Marx, *Ann. der Phys.* ii. p. 798, 1900.

field which will balance the effect of the mechanical forces arising from the magnetic field.

We shall now proceed to deduce the equations which give the disturbance produced by the magnetic field; these equations are not limited to the case of flames, but apply to all cases of the conduction of electricity through a gas containing ions.

Let the direction of the primary current, *i.e.* the current before the magnetic field is applied, be taken as the axis of x , let the magnetic force act downwards at right angles to the plane of the paper: then the force on the ions will be in the plane of the paper and at right angles to the axis of x ; we shall take the axis of z in this direction.

Let H be the intensity of the magnetic force,

X, Z the components of the electric force parallel to the axes of x and z respectively,

u, v the velocities of the positive and negative ions under unit electric force,

p_1, p_2 the pressures at any point due to the positive and negative ions respectively,

m, n the number of positive and negative ions per cubic centimetre at any point.

We shall assume that these ions behave like a perfect gas, so that $p_1 = Rm, p_2 = Rn$, where R is a constant proportional to the absolute temperature.

Let us consider first the positive ions, their velocity parallel to the axis of x is Xu , hence the mechanical force on an ion parallel to z due to the magnetic field is $euXH$, the force on the ion due to the electric field is Ze , and the force on the ions in unit volume due to the variation in the pressure at different points in the field is $-dp_1/dz$, hence the total force parallel to z on the positive ions in unit volume is equal to

$$-\frac{dp_1}{dz} + me(uXH + Z),$$

and the number crossing in unit time one square centimetre of surface at right angles to z is equal to

$$\frac{u}{e} \left\{ -\frac{dp_1}{dz} + me(uXH + Z) \right\};$$

similarly the flux parallel to x is equal to

$$\frac{u}{e} \left\{ -\frac{dp_1}{dx} + me(-uZH + X) \right\};$$

if we neglect terms depending upon H^2 the term uZH may be omitted, and the flux parallel to x is then

$$\frac{u}{e} \left\{ -\frac{dp_1}{dx} + meX \right\}.$$

Similarly the flux of the negative ions parallel to z is equal to

$$\frac{v}{e} \left\{ -\frac{dp_2}{dz} + ne(vXH - Z) \right\},$$

and the flux parallel to x to

$$\frac{v}{e} \left(-\frac{dp_2}{dx} - neX \right).$$

Let q be the number of ions produced in one cubic centimetre of the gas in one second, αnm the number of ions which recombine in one second in unit volume; then by the equation of continuity we have, when things are in a steady state,

$$\frac{u}{e} \frac{d}{dz} \left\{ -\frac{dp_1}{dz} + me(uXH + Z) \right\} + \frac{u}{e} \frac{d}{dx} \left(-\frac{dp_1}{dx} + meX \right) = q - \alpha mn,$$

$$\frac{v}{e} \frac{d}{dz} \left\{ -\frac{dp_2}{dz} + ne(vXH - Z) \right\} + \frac{v}{e} \frac{d}{dx} \left(-\frac{dp_2}{dx} - neX \right) = q - \alpha mn;$$

we have also, using electrostatic units,

$$\frac{dX}{dx} + \frac{dZ}{dz} = 4\pi e(m - n),$$

and

$$\frac{dX}{dz} - \frac{dZ}{dx} = 0.$$

Since $p_1 = Rm$, $p_2 = Rn$, we have as many equations as there are variables, p_1 , p_2 , m , n , X , Z . The solution will however depend very greatly upon the boundary conditions; thus one solution is $Z = 0$, p_1 and p_2 constant, and X independent of z and the same as when the magnetic force is zero: this, however, involves a transverse flux of positive ions equal to mu^2XH and of negative ions equal to nv^2XH , and is not consistent with a steady state unless there is some means for this transverse stream to escape. If there is no way of escape for the transverse streams of ions

the flux of the ions parallel to z must vanish at the boundaries of the gas. Let us suppose that it vanishes throughout the gas, then we have

$$-\frac{dp_1}{dz} + me(uXH + Z) = 0 \dots\dots\dots(1),$$

$$-\frac{dp_2}{dz} + ne(vXH - Z) = 0 \dots\dots\dots(2).$$

Putting $p_1 = Rm$, $p_2 = Rn$ and $(m - n)e = \rho$ we get from (1) and (2)

$$\frac{R}{e} \frac{d\rho}{dz} = eXH(mu - nv) + Ze(m + n) \dots\dots\dots(3);$$

and since, changing to electromagnetic units,

$$4\pi \frac{d\rho}{dz} = \frac{1}{V^2} \left(\frac{d^2Z}{dx^2} + \frac{d^2Z}{dz^2} \right),$$

where V is the velocity of light, (3) becomes

$$\frac{R}{4\pi e V^2} \left(\frac{d^2Z}{dx^2} + \frac{d^2Z}{dz^2} \right) = eXH(mu - nv) + Ze(m + n) \dots\dots(4),$$

an equation to find Z . In the terms on the right-hand side, we may put for X , m , n the values when $H = 0$, if we are content to neglect terms in H^2 .

Since $V^2 = 9 \times 10^{20}$, $e = 1.1 \times 10^{-20}$ (in electromagnetic units), $R = 5 \times 10^{-14}$, for a gas at 0°C ., we see that (4) may be written

$$4 \times 10^{-16} \left(\frac{d^2Z}{dx^2} + \frac{d^2Z}{dz^2} \right) = eXH(mu - nv) + Ze(m + n).$$

If the sum of the partial pressures due to the positive and negative ions were 1 atmosphere $e(m + n)$ would be about $\cdot 5$, hence we see that if the pressure of the ions is large compared with 10^{-15} atmospheres and if Z does not vary exceedingly rapidly with x , a very approximate solution of (4) will be

$$Z = \frac{XH(nv - mu)}{m + n} \dots\dots\dots(5).$$

This may be written

$$Z = \frac{H(i_n - i_p)}{e(m + n)},$$

where i_n and i_p are respectively the currents carried by the negative and positive ions.

At a place where there is no free electricity $m = n$; in this case (5) becomes

$$Z = \frac{1}{2}XH(v - u).$$

This is the formula usually employed, but we see from the preceding work it is only applicable in a very special case.

When solutions of KCl of various strengths were sprayed into a flame Marx* found values of Z/XH varying from 10.18×10^{-6} for the pure flame to 3.7×10^{-6} when a saturated solution of KCl was sprayed into it, the sign of the result showing that the velocity of the negative ion is greater than that of the positive. If we apply the preceding formula we find, on the supposition that the measurements were made in a part of the flame where there was no free electricity, that the difference between the velocities of the negative and positive ions under an electric force of one volt per centimetre, *i.e.* 10^8 units, would vary from 2036 cm./sec. for the pure flame to 740 cm./sec. for the flame containing the concentrated solution; the value 940 found by H. A. Wilson by direct experiment is between these limits.

If the electric and magnetic forces are considerable there will, when there is no escape for the transverse flow of ions, be very considerable variations in the number of ions in the gas; for putting $p_1 = Rm$, $p_2 = Rn$, we get from equations (1) and (2),

$$R \frac{d}{dz} \log mn = eXH(u + v),$$

or

$$mn = Ce^{eX(u+v)z/R},$$

where C is a constant. To see what variation this implies let us take the case of air ionised by Röntgen rays, the pressure being 1/1000 of an atmosphere, then since $u + v$ at atmospheric pressure is 3×10^{-8} cm./sec., at the assumed pressure it will be 3×10^{-5} , and if X is 10 volts a centimetre, *i.e.* 10^9 , and $H = 10^2$, then since $e/R = 4 \times 10^{-7}$, we see that

$$mn = Ce^{1.2z};$$

thus in the space of a centimetre parallel to z , mn will about triple in value: this variation in the number of ions will affect the distribution of the current parallel to x , the current will be greatest where there are most ions and will therefore no longer

* Marx, *Ann. der Phys.* ii. p. 798, 1900.

be independent of z : this variation in the current may affect the distribution of potential between the electrodes and thus introduce fresh sources of disturbance into the problem.

In the case when there are only ions of one sign present, say the negative, there is a very simple solution of the preceding equations, for we see that $Z = eHXv$, p_2 constant and X the same as when there is no magnetic force, satisfies these equations.

Maximum current that can be carried by the vapour of a Salt.

128. H. A. Wilson* has made an exceedingly important set of experiments on the maximum current that can be carried by a given amount of salt vapour; in these experiments the solution containing the salt vapour was not sprayed into a flame, but into air heated by passing through a long platinum tube raised to bright yellow heat by a furnace; a smaller central tube was placed along the axis of the outer tube and the current between the inner and outer tubes measured. When solutions of the strength 1/10th normal were sprayed and the temperature of the tubes raised and the potential difference increased, a stage was reached when neither an increase in the temperature nor in the potential difference produced any increase in the current. Wilson measured this limiting current and found that it was equal to the current which when passing through an aqueous solution of the salt would electrolyse in one second the same quantity of salt as was sprayed in that time into the hot air; thus if the salt had been supplied to water at the same rate as it was supplied to the hot air the maximum current that could be sent through the aqueous solution would be the same as that which could be sent through the air; this was proved for the following salts of the alkali metals: CsCl, CsCO₃, RbI, RbCl, Rb₂CO₃, KI, KBr, KF, K₂CO₃, NaI, NaBr, NaCl, Na₂CO₃, LiI, LiBr, LiCl, Li₂CO₃.

* H. A. Wilson, *Phil. Mag.* vi. 4, p. 207, 1902.

CHAPTER X.

IONISATION BY LIGHT. PHOTO-ELECTRIC EFFECTS.

129. THE discovery by Hertz* in 1887 that the incidence of ultra-violet light on a spark gap facilitated the passage of the spark, led immediately to a series of investigations by Hallwachs†, Hoor‡, Righi§ and Stoletow|| on the effect of light, and especially of ultra-violet light, on charged bodies. It was proved by these investigations that a newly cleaned surface of zinc, if charged with negative electricity, rapidly loses this charge however small it may be when ultra-violet light falls upon the surface; while if the surface is uncharged to begin with, it acquires a positive charge when exposed to the light, the negative electrification going out into the gas by which the metal is surrounded; this positive electrification can be much increased by directing a strong air-blast against the surface. If however the zinc surface is positively electrified it suffers no loss of charge when exposed to the light: this result has been questioned, but a very careful examination of the phenomenon by Elster and Geitel¶ has shown that the loss observed under certain circumstances is due to the discharge by the light reflected from the zinc surface of negative electrification on neighbouring conductors induced by the positive charge, the negative electricity under the influence of the electric field moving up to the positively electrified surface.

* Hertz, *Wied. Ann.* xxxi. p. 983, 1887.

† Hallwachs, *Wied. Ann.* xxxiii. p. 301, 1888.

‡ Hoor, *Repertorium des Physik*, xxv. p. 91, 1889.

§ Righi, *C. R.* cvi. p. 1349; cvii. p. 559, 1888.

|| Stoletow, *C. R.* cvi. pp. 1149, 1593; cvii. p. 91; cviii. p. 1241; *Physikalische Revue*, Bd. i., 1892.

¶ Elster and Geitel, *Wied. Ann.* xxxviii. pp. 40, 497, 1889; xli. p. 161, 1890; xlii. p. 564, 1891; xliii. p. 225, 1892; lii. p. 433, 1894; lv. p. 684, 1895.

The ultra-violet light to produce these effects may be obtained from an arc lamp, or by burning magnesium, or by sparking with an induction coil between zinc or cadmium terminals, the light from which is very rich in ultra-violet rays. Sunlight is not rich in ultra-violet rays, as these have been absorbed by the atmosphere, and it does not produce nearly so large an effect as the arc-light. Elster and Geitel, who have investigated with great success the effects produced by light on electrified bodies, have shown that the more electropositive metals lose negative charges even when exposed to ordinary daylight. They found that amalgams of sodium or potassium enclosed in a glass vessel lose a negative charge in the daylight, though the glass would stop any small quantity of ultra-violet light that might be left in the light after its passage through the atmosphere. When sodium or potassium by themselves instead of their amalgams were used, or, what is more convenient for many purposes, the liquid alloy formed by mixing these metals in the proportion of their combining weights, they found that the negative electricity was discharged by the light from a petroleum lamp; while with the still more electropositive metal rubidium the negative electricity could be discharged by the light from a glass rod just heated to redness. They found, however, that the eye was more sensitive to the radiation than the rubidium, for no discharge could be detected until after the radiation from the glass rod was visible. I have lately found however that electropositive metals like rubidium give off negative electricity in the dark, especially if a trace of hydrogen is present.

Elster and Geitel arrange the metals in the following order with respect to their power of discharging negative electricity :

Rubidium.
 Potassium.
 Alloy of Potassium and Sodium.
 Sodium.
 Lithium.
 Magnesium.
 Thallium.
 Zinc.

For copper, platinum, lead, iron, cadmium, carbon, and mercury the effects with ordinary light are too small to be measurable.

The order of the metals for this effect is the same as in Volta's series for contact-electricity, the most electropositive metals giving the largest photo-electric effect. Many substances besides metals discharge negative electricity under the action of ultra-violet light: lists of these substances will be found in papers by G. C. Schmidt* and O. Knoblauch†. Among the more active photo-electric solids are, fluor-spar, the various coloured varieties of which vary greatly in the degree to which they possess this property; the sulphides of antimony, lead, arsenic, manganese, silver, and tin (the sulphates do not possess this property); hydroxide of tin, iodide of lead, many aniline dyes in the solid state.

Pure water is not photo-electric, and a thin film of water over the surface of a metal destroys the effect due to the metal. The solutions of many substances are however very photo-electric, especially solutions of fluorescent substances such as eosine, fuchsine, cyanine, hydrochinone, congo-red; potassium nitrate and formic acid also show this effect. Among well-known substances which do *not* show this effect we may mention solutions of sulphate of quinine, potassium permanganate and phenol.

Photo-electric properties of Gases.

130. With gases the action of light may be expected to manifest itself in a different way from that occurring in the case of solids and liquids; we cannot expect to get a separation of electricity of such a kind that one region of the gas becomes positively, another negatively, electrified. If a molecule of a gas loses, like a piece of metal, negative electricity when exposed to ultra-violet light, then this molecule will behave like a positive ion, and the negative corpuscle it has lost will attach itself to some other molecule of the gas which will act like the negative ion; thus if ultra-violet light produced on the molecules and atoms of a gas the same effect as it does on a mass of metal we should expect this effect to show itself as ionisation of the gas. In the case of sodium vapour, light produces a decided increase in the conductivity; it is not necessary that the light should be ultra-violet, the

* G. C. Schmidt, *Wied. Ann.* lxiv. p. 708, 1898.

† O. Knoblauch, *Zeit. f. Physikalische Chemie*, xxix. p. 527, 1899.

light from a petroleum lamp is sufficient to produce well-marked effects; we have seen that sodium when in the solid state is peculiarly sensitive to the action of light. Experiments have been made on other gases; thus Henry* who tried the effect of ultra-violet light on iodine vapour, which absorbs a good deal of light, could not detect any increase in conductivity when the gas was illuminated: Buisson† was unable to detect any conductivity in air through which ultra-violet light was passing: recently, however, Lenard‡ has described an effect due to a very easily absorbed kind of ultra-violet light produced when sparks from an induction coil pass between aluminium terminals; this light is so easily absorbed by air that its effect becomes inappreciable after it has passed through a few centimetres of air at atmospheric pressure. Quartz is more transparent than air to this light; coal-gas is very much less transparent than air, while hydrogen is more so. If the aluminium terminals were placed behind a quartz window in a metal plate, then a charged conductor placed on the far side of the plate near to the gas illuminated by these rays was found to lose its charge rapidly if positively electrified, very much more slowly if negatively electrified. In order to avoid spurious effects due to the light falling on metal surfaces in the neighbourhood Lenard covered these with soap and water, which he found prevented any discharge of electricity due to light falling on a metal plate. The much greater loss experienced by the plate when the charge was positive than when it was negative indicates that the velocity of the negative ions is much greater than that of the positive. Lenard measured, by a method used by Zeleny and described on p. 49, the velocities of the ions; he found that under a potential gradient of a volt per centimetre the velocity of the negative ions through air at atmospheric pressure is 3·13 cm./sec.: this is considerably greater than (almost double) the velocity found by Rutherford for the negative ions produced by ordinary ultra-violet light incident on a metal plate: the velocity of the positive ions was found by Lenard for a gradient of a volt. per centimetre to be only 0·0015 cm./sec., that is only about 1/2000 of the velocity of the negative ions. The exceedingly small velocity

* Henry, *Proc. Camb. Phil. Soc.* ix. p. 319, 1897.

† Buisson, quoted by Perrin, *Ann. de Chimie et de Physique*, vii. 11, p. 526, 1897.

‡ Lenard, *Drude's Ann.* i. p. 486; iii. p. 298, 1900.

of these positive ions raises the question as to whether they are not particles of dust or minute drops of impure water, rather than gaseous ions. It is essential to show that they are not of this nature if these experiments are to demonstrate the ionisation of the air by the ultra-violet light, for the enormous discrepancy between the velocities of the positive and negative ions is exactly what we should expect if dust possessing photo-electric properties were exposed to the influence of ultra-violet light; such particles would emit negative electricity, while the positive electricity would remain behind on the dust; the comparatively large dust particles would move very slowly in an electric field, while the negative ions being free from dust might be expected to move with much greater velocity. Lenard discusses this interpretation of his results and rejects it for reasons which do not appear to us absolutely convincing. He considers that the negative ions produced by the action of ultra-violet light on air are essentially different from those produced when the light falls on a metal, and that while the latter are able to produce condensation in a steam jet, the former are unable to do so. The evidence for this is as follows: though the gas under direct illumination by the ultra-violet light produces vigorous condensation in a steam jet, yet if the negative ions are pulled out of the illuminated gas by a positively charged plate placed at some distance away no condensation of the jet takes place in the region between the plate and the gas exposed to the light, though the leak of positive electricity from the plate shows that this region is being traversed by negative ions. To make the experiment conclusive, however, we require to know the sensitiveness of the steam jet, *i.e.*, the minimum number of ions per cubic centimetre it is capable of detecting, and also to be sure that the number of negative ions in the neighbourhood of the jet exceeds this minimum: the second point is one that requires very careful attention, for if the electric field in the neighbourhood of the plate is intense the negative ions will be moving at a very high speed and a very small number of ions in each cubic centimetre would be sufficient to produce a very appreciable leak; in fact if this leak is 'saturated' we see that the density of the ions will be inversely proportional to the strength of the field, so that by increasing this strength sufficiently we could certainly stop the condensation of the steam jet. Thus this experiment does not prove that the negative ions are incapable of acting as centres

of condensation: to make the proof valid we should require to know that the number of ions in each unit volume was so large that condensation would take place if these ions had the property of the normal negative ion.

131. C. T. R. Wilson* has studied the action of ultra-violet light on gases from the point of view of the effect produced by the light on the formation of clouds. His results with intense light have already been described in Chapter VII., we shall only consider here the effects he got with very feeble light, as the effects have a direct bearing on the question of the ionisation of air by ultra-violet light, though they do not touch the question as to the effects produced by the extremely absorbable light studied by Lenard. Wilson found that with very feeble ultra-violet light clouds were produced by expansion when this exceeded a definite amount, just as in the case of a gas ionised by Röntgen rays, and that the amount of expansion required was just the same for the ultra-violet light as for these rays: this at first sight looks as if the ultra-violet light ionised the gas. Wilson, however, found that the clouds produced by ultra-violet light differed from those produced by Röntgen rays, inasmuch as the former were not affected by strong electric fields, whereas the formation of the latter was almost entirely prevented by such fields. If the clouds due to ultra-violet light had been due to the ionisation of the gas the ions would have been removed by the field and the clouds stopped. At the same time the coincidence between the expansions required for the formation of clouds under ultra-violet light and when ions are present is so remarkable that it makes us very reluctant to believe that the nuclei are different in the two cases; it seems to me that an explanation which is in harmony with the facts is that charged ions do form the nuclei of the drops formed by weak ultra-violet light, but that these ions are produced during the expansion of the gas and are not present when the gas is at rest; these ions might arise in the following way: we have seen in Chapter VII. that under the action of strong ultra-violet light visible clouds are formed without expansion, these clouds being probably due to the formation of hydrogen peroxide, which mixing with the water lowers the vapour pressure; now when the light is very feeble it seems probable that there may still be a formation of

* C. T. R. Wilson, *Phil. Trans.* 192 A, p. 403, 1899.

drops of water which, however, in consequence of the very small amount of hydrogen peroxide produced by the feeble light, never grow large enough to be visible. Thus we may regard the air exposed to the ultra-violet light as full of exceedingly minute drops of water; when the expansions take place the air will rush violently past the drops and we get a state of things which in many respects is analogous to the bubbling of gas through water; when, however, air bubbles through water there is, as Lord Kelvin* has shown, negative electricity in the air and positive in the water; thus when the air rushes past the water drops we should expect the air to contain negative ions, the positive ions being on the drops; the ions once formed would act as nuclei for clouds if the expansion exceeded the value 1.25. If this view is correct, then we should expect the number of ions produced by an expansion greater than 1.25 to increase with the expansion, for in this case the expansion has to produce the nuclei as well as deposit the clouds, and the more vigorous the expansion the greater would be the number of nuclei produced.

There are some other considerations which may have a bearing on this question; we have seen (p. 187) that the formation of a fresh water surface is accompanied by the liberation of ions; when the cloud of small drops is formed by the weak ultra-violet light there is a creation of new surfaces of water and the probability of the liberation of ions, the positive ions being carried by small water drops would only move very slowly under an electric field and so might not be cleared out by any field it is practicable to apply.

Vincent† has made experiments on the clouds formed without expansion by ultra-violet light, he finds that some drops are charged positively, others negatively, while others were without charge. He was not able to detect the presence of hydrogen peroxide.

It is an important meteorological question whether direct sunlight can produce a cloud in the atmosphere without expansion. Wilson was not able to get a cloud in a closed vessel in sunlight with less than the normal expansion 1.25. He points

* Lord Kelvin, *Proc. Roy. Soc.* lvii. p. 335, 1894.

† Vincent, *Proc. Camb. Phil. Soc.* xii. p. 305, 1904.

out, however, that the conditions in the open air are more favourable to the production of clouds than those in a closed vessel, for in a closed vessel the drops might diffuse to the sides before they had time to grow to a visible size, while in the atmosphere this way of escape would not be open to them.

Photo-electric effects involve an absorption of Light.

132. Stoletow* at an early stage in the history of this subject called attention to the connection between the photo-electric effects and the absorption of the ultra-violet light; he pointed out that water which does not give photo-electric effects does not absorb many of the visible or ultra-violet rays, while solutions such as those of methyl-green or violet, which are photo-electric, show strong absorption. Hallwachs†, who investigated the subject in greater detail, found in all the photo-electric liquids which he tried strong absorption for the ultra-violet light, but that strong absorption was not always accompanied by photo-electric effects; thus for example the aqueous solution of fuchsine is photo-electric, while the alcoholic solution is not, and yet the alcoholic solution absorbs more ultra-violet light than the aqueous one.

The effects of increased absorption are shown in a very beautiful way by the experiments of Elster and Geitel‡ on the leak of negative electricity from surfaces of sodium, potassium, and rubidium under different coloured lights. The experiments, the results of which are shown in the following table, were made as follows: the rate of escape from the three metals when exposed to the white light from a petroleum lamp was measured; these measurements are given in the table under the heading 'white light.' The light from this lamp was then sent through an ammoniacal solution of copper oxide and the metals exposed to the blue light thus obtained; this solution was replaced by one of potassium chromate to get yellow light, by one of potassium bichromate to get orange light, and by a plate of deep red glass to get the red light.

Thus we see from this table that though for white and blue

* Stoletow, *Physikalische Revue*, Bd. i. 1892.

† Hallwachs, *Wied. Ann.* xxxvii. p. 666, 1889.

‡ Elster and Geitel, *Wied. Ann.* lii. p. 433, 1894.

lights potassium is much more photo-electric than sodium, it is much less so for yellow and orange light, owing to the strong absorption of these rays by the sodium. The very great sensitiveness

Colour of Light	Rate of leak of negative electricity		
	Na	K	Rb
White	21·0	53·1	537·0
Blue.....	7·8	30·3	86·8
White	22·6	52·9	527·7
Yellow.....	8·2	3·5	339·7
White	21·9	53·9	552·3
Orange.....	3·1	2·2	182·0
White	21·9	52·9	527·7
Red	·2	0·1	21·0

of rubidium to light of long wave-length is another instance. Thus while the ratios of the leaks for rubidium and potassium under blue light were only 3 to 1, the ratio for yellow light was about 100 to 1.

Connection between the rate of leak and strength of Electric Field.

133. The first measurements on this subject were made by Stoletow*, who used the following arrangement: the light from an arc lamp passed through a hole in a metal screen, and after passing through a perforated plate *C* fell upon a parallel metal plate *D*; these plates were connected together through a battery, the negative pole of the battery being connected with *D*, the plate illuminated by the light. The current passing between the plates was measured by a very sensitive galvanometer. By means of this arrangement Stoletow measured the relation between the current and the potential difference between the plates, making experiments with the plates at distances apart varying from about 2·5 millimetres to 100 millimetres; the results of these experiments, in which the gas between the plates was air at atmospheric pressure, are represented by the curves of Fig. 56; the abscissæ represent the potential differences between the plates, the unit being 1·43 volts (the electromotive force of a Clark's cell); the ordinates represent the current passing between the plates, the unit being

* Stoletow, *Journal de Physique*, ii. 9, p. 468, 1890.

8.6×10^{-11} ampères; the symbol on the curve, for example $x + 25$, indicates that the distance between the plates was $x + 25$ millimetres, where x is a small distance, about 1.5 mm., that was not

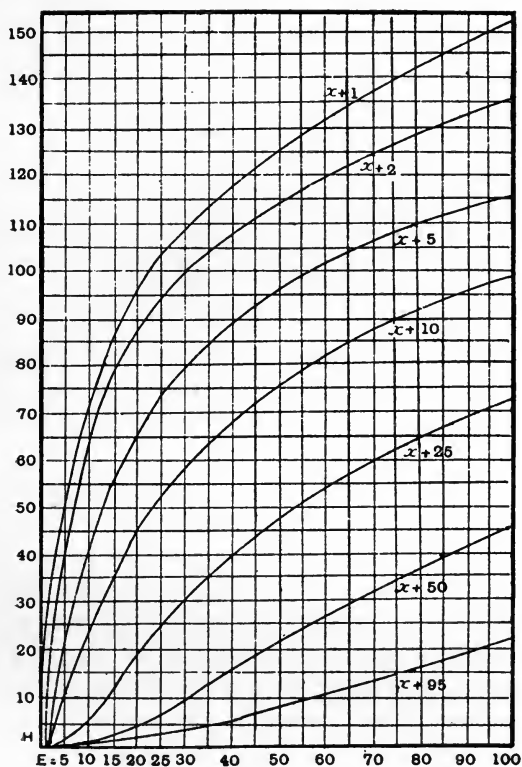

Fig. 56.

very accurately determined; the diameter of the plates was 22 mm. An inspection of the curves shows that when the distance between the plates is small and the electromotive force large the current increases much more slowly than the electromotive force; it is, however, evidently far from saturation; while when the plates are separated by distances greater than 25 mm. there is no approach to saturation. The curves corresponding to the greater distances between the plates show that under small electromotive forces the current increases more rapidly than the potential difference. As far as the measurements represented in the figure go i is approximately the same at all distances d , provided V is pro-

portional to d , V being the potential difference, *i.e.*, i is a function of the mean value of the electric force between the plates; this law, as Stoletow showed in a later paper*, does not apply for any great range of potential differences, at lower pressures especially, the departures from it are soon very apparent.

Since in this case the ions are all of one kind we may (see p. 207) apply the equation,

$$X^2 = X_0^2 + \frac{8\pi i x}{k},$$

where k is the velocity of the ion under unit electric force, i the intensity of the current, X_0 and X the values of the electric force at the plate and at a point distant x from it.

To form an estimate of the variation in the electric field which is produced by the presence of the negative ions between the plates, let us take one of Stoletow's experiments in which under an electric field of 150 volts per cm. the current was 3.3×10^{-11} ampères. The velocity of the negative ions produced by a field of 1 volt per centimetre has been shown by Rutherford to be about 1.5 cm./sec. Hence using electrostatic units, X and X_0 being the values of X at places a centimetre apart, we get, putting $i = 10^{-1}$, $R = 4.5 \times 10^2$, $X + X_0 = 1$, in the preceding equation, $X - X_0 = 1/180$ or a little less than 2 volts per cm., thus the variation in the strength of the field is comparatively small. Stoletow, who determined the intensity of the field between two parallel plates one of which was illuminated by ultra-violet light, was not able to detect any variation in the intensity. Schweidler†, who investigated this point at a later period, found that the distribution of potential between the plates when the ultra-violet light was in action, was not quite uniform; his results are shown in Fig. 57, where the curved line represents the distribution of potential when the light was shining, the straight one when it was not. The curvature of the potential curve in the light is all in one direction, indicating the presence of an excess of negative ions in every part of the region between the plates. The variation in the intensity of the field between the plates has also been observed and measured by Buisson‡ and used by him to determine

* Stoletow, *Journal de Physique*, ii, 9, p. 469, 1890.

† Schweidler, *Wien. Ber.* cvii. p. 881, 1898.

‡ Buisson, *Comptes Rendus*, cxxvii. p. 224, 1898.

the velocity of the negative ions; he finds that under a potential gradient of a volt per cm. this velocity is about 2.2 cm./sec.

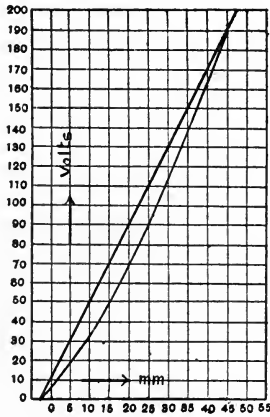

Fig. 57.

Schweidler* has also made experiments on the relation between the current and the strength of the electric field over a wider

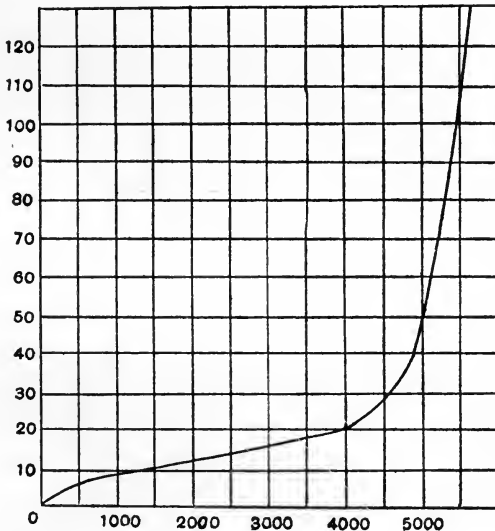

Fig. 58.

* Schweidler, *Wien. Ber.* cviii. p. 273, 1899.

range than in Stoletow's experiments: his results for air at atmospheric pressure are shown by the curve (Fig. 58). It will be noticed that when the strength of the field approaches the value 5730 volts, which is the strength required to produce a spark in the dark across the plates which were 3 mm. apart, there is a very great increase in the current.

This rapid increase of the photo-electric effect in the neighbourhood of the sparking potential was first observed by Kreuzler*. The relation between the leak from plates of iron, aluminium, copper, zinc, silver and amalgamated copper, and the strength of field are represented in the curves given in Fig. 59: the abscissæ

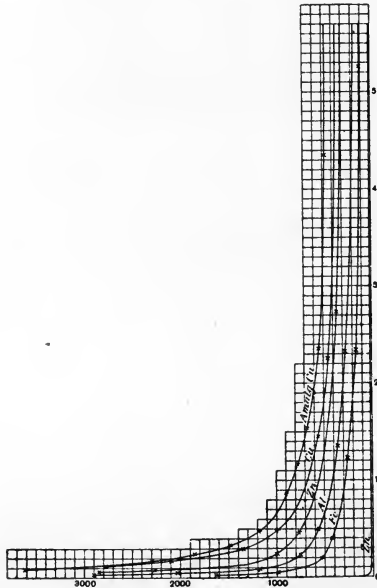

Fig. 59.

measured from 0 represent the difference between the electromotive force applied and that required to produce discharge in the dark. The increase in the leak is so great that it cannot be adequately represented in a moderately sized figure, a better idea in the case of the zinc plate can be derived from the following table given by Kreuzler. V is the potential difference and i the current, the potential required to produce a spark was 4060.

* Kreuzler, *Ann. der Phys.* vi. p. 398, 1901.

These figures also show evidence of an effect often observed when using ultra-violet light—the decrease of sensibility with the time; thus of the two readings taken with the greatest potential difference the later one was very appreciably less than the earlier

V	i ($1=10^{-10}$ Amp.)	V	i ($1=10^{-10}$ Amp.)	V	i ($1=10^{-10}$ Amp.)
4040	136.39	3050	0.19	3300	0.36
3970	25.67	2540	0.09	3440	0.58
3780	5.88	1760	0.06	3640	1.36
3700	2.40	1170	0.05	3710	1.98
3590	1.39	1760	0.06	3760	3.88
3440	0.70	2530	0.08	3970	21.09
3300	0.40	3060	0.17	4040	80.51

one. This 'fatigue' of the plates is probably due to oxidation, it does not take place in hydrogen nor at very low pressures, nor when platinum is used instead of zinc.

The increase in the rate of leak when the electric field approaches a certain strength is also very evident when the gas is at lower pressures. The effect of altering the pressure of the gas was first investigated by Stoletow*, and subsequently by Schweidler† and Lenard‡. Stoletow showed that as the pressure was dimi-

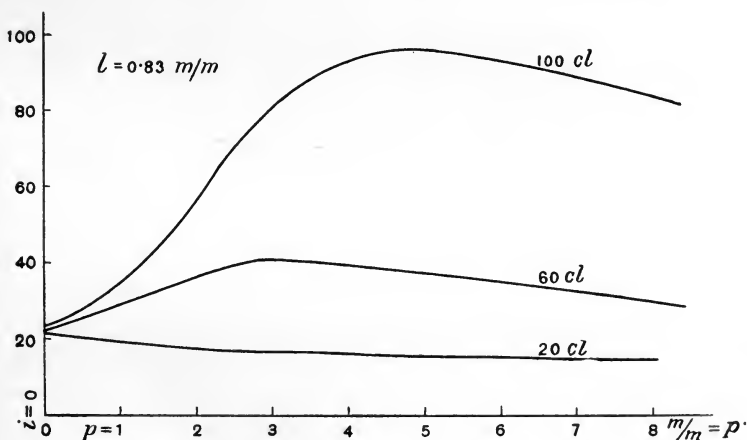

Fig. 60.

* Stoletow, *Journal de Physique*, ii. 9, p. 468, 1890.† v. Schweidler, *Wien. Ber.* cviii. p. 273, 1899.‡ Lenard, *Ann. der Phys.* ii. p. 359, 1900.

nished, starting from atmospheric pressure, the current slightly increased, the change in the current being small compared with that in the pressure; on carrying the reduction of pressure still further, a stage was reached (if the strength of the field was not too small) when the current increased rapidly as the pressure diminished; this went on until the current reached a maximum value, after which it began to decline, but at the lowest obtainable pressures it had a finite value which was independent of the strength of the electric field.

The variation of the current with the pressure when the potential difference remains constant is exhibited in the curves (copied from Stoletow's paper) shown in Fig. 60; the distance between the plates was .83 millimetre and the figures on the curves indicate the potential difference expressed in terms of Clark's cells (1 Clark's cell = 1.4 volts).

The values of the current at a series of pressures when the distance between the plates was 3.71 mm. and the potential difference about 90 volts are shown in the following table:

Pressure in millimetres	Current	Pressure in millimetres	Current	Pressure in millimetres	Current
754	8.46	2.48	74.7	0.105	65.8
152	13.6	1.01	105.8	0.0147	53.8
21	26.4	0.64	108.2	0.0047	50.7
8.8	32.2	0.52	102.4	0.0031	49.5
3.3	48.9	0.275	82.6		

We see by an inspection of the curves in Fig. 60 that the pressure at which the current is a maximum increases with the electric force between the plates: Stoletow has shown that p_m , the pressure at which the current is a maximum, is proportional to E/d , where d is the distance and E the potential difference between the plates; this law may also be expressed by saying that if λ is the mean free path of a molecule at the pressure for maximum current, when the electric force is X , then $X\lambda$ is constant. The curves in Fig. 60 show that at very low pressures the current is independent of the strength of the electric field, *i.e.* is saturated. This is also well shown by the following numbers taken

from Lenard's paper. V is the potential difference in volts and i the current, the vacuum was the best obtainable, the pressure being less than $\cdot 002$ mm. of mercury.

V	i	V	i
45000	24.5×10^{-10} Coulomb/sec.	500	23.4×10^{-10} Coulomb/sec.
25000	26.6 " "	120	21.9 " "
8900	22.5 " "	14	19.9 " "
4100	24.8 " "	9	15.9 " "
3110	24.5 " "	1	7 " "
1300	24.5 " "	0	4 " "

The critical pressure is of the same order of magnitude as the pressure at which the electric field would be able to produce a discharge in the dark; in this region of pressure Stoletow has

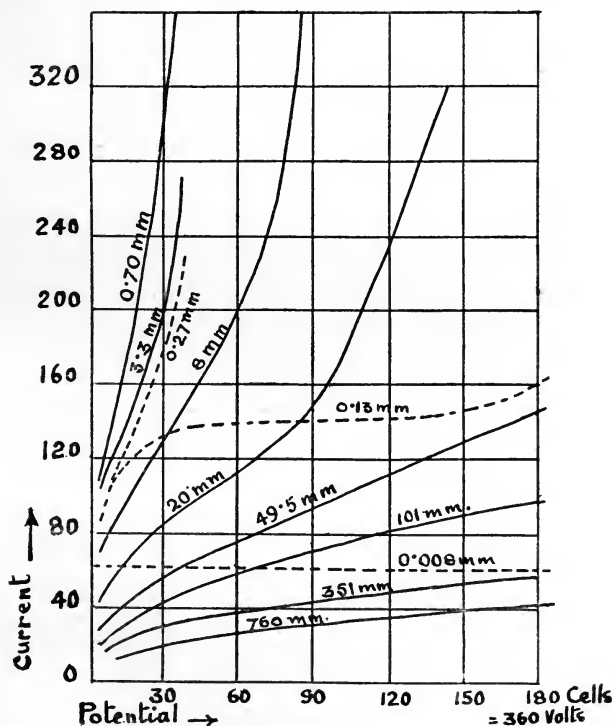

Fig. 61. Distance between electrodes 3.5 mm. Gas hydrogen.

shown that the current does not depend merely upon the value of E/d , where E is the potential difference and d the distance between

the plates, for with a constant value of E/d the current at these pressures increases rapidly with the distance between the plates.

V. Schweidler* has given curves representing the relation between the current and the potential difference at several pressures. Similar curves have lately been obtained by Varley† at the Cavendish Laboratory, some of these are reproduced in Figs. 61 and 62. The curves show three distinct stages; the first when

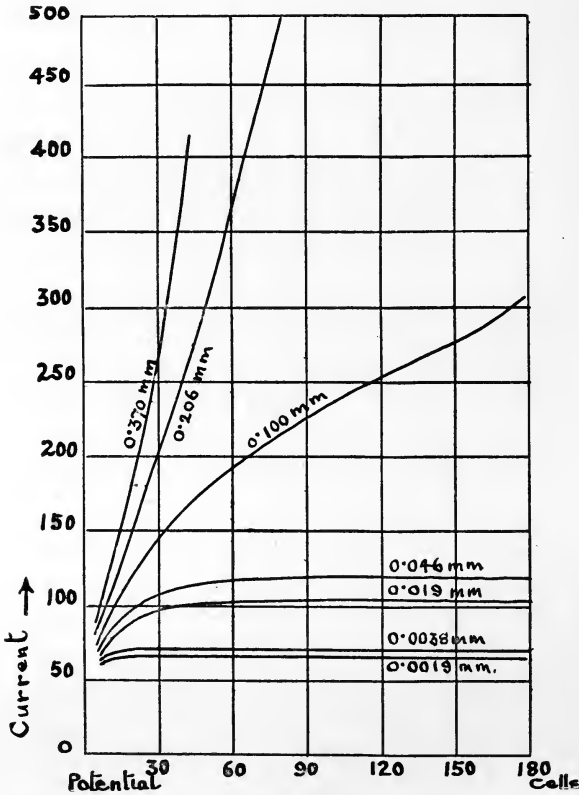

Fig. 62. Distance between the electrodes 3.5 mm. Gas air.

the electric force is weak, then the current increases rapidly with the electric force, the rate of increase gradually dies away as the electric force increases, and the second stage is reached when the current only varies slowly, at some pressures hardly at all, with

* v. Schweidler, *Wien. Ber.* cviii. p. 273, 1899.

† Varley, *Phil. Trans. A*, 202, p. 439, 1904.

the electric field; with still larger electric forces a third stage is reached when the current increases rapidly with the electric force and also with the distance between the electrodes.

Theoretical considerations relating to the connection between the current and the strength of the electric field.

134. It will be convenient to confine our attention in the first place to electric fields which are weak compared with those required to produce discharge in the dark. The view we take of the action of the ultra-violet light is that under the action of this light the metal emits from each unit area in unit time a certain number of corpuscles; that these corpuscles soon, when gas surrounds the metal, get attached to one or more molecules of the gas and form negative ions.

The negative ions accumulate in the space between the plates and since like the molecules of a gas they are moving about in all directions some of them will strike against the negative plate and give up their negative charges to it: the steady state will be reached when the negative electricity given out by the plate struck by the ultra-violet light, minus the quantity of electricity given up to the plate by the ions striking against it, is equal to the current through the gas.

To express this condition mathematically let us take the case of two parallel plates one of which is illuminated by ultra-violet light; let X be the electric intensity at right angles to the plates, the illuminated plate being at the lower potential, n the density of the negative ions between the plates*, k the velocity of the negative ion under unit electric force, e the charge on an ion, i the current through unit area, then

$$i = nekX.$$

The number of negative ions which in unit time strike against unit area of the plate is, see p. 200, equal to $\frac{cn}{\sqrt{6\pi}}$, where c is the average velocity of translation of the negative ions. If I is the

* These ions start as corpuscles but soon cling to molecules of the gas and become ions.

number of corpuscles emitted by unit area of the plate in unit time, then .

$$Ie = \frac{cne}{\sqrt{6\pi}} + i,$$

or since

$$i = nekX,$$

$$Ie = \frac{ci}{\sqrt{6\pi}kX} + i,$$

or

$$i = \frac{Ie\sqrt{6\pi}kX}{c + \sqrt{6\pi}kX}.$$

When X is so small that kX is small compared with c , *i.e.* when the velocity of the ion due to the electric field is small compared with the mean velocity of translation of the ion,

$$i = Ie\sqrt{6\pi}kX\frac{1}{c}.$$

Thus when the electric force is small the current obeys Ohm's law. For larger values of the electric force the rate of increase of the current with the electric force diminishes and the current approaches the saturation value Ie .

Since $k = \frac{1}{2} \frac{e \lambda}{m c},$

m being the mass of the ion and λ its mean free path, we have

$$i = \frac{IeX}{X + \frac{2mc^2}{\lambda e \sqrt{6\pi}}},$$

and when X is small

$$i = \frac{IeX\sqrt{6\pi}\lambda}{2mc^2}.$$

Since mc^2 only depends upon the temperature, the rate of increase of the current with the electric force will be proportional to the mean free path of the ion and so will be greater at low pressures than at high ones. If the pressure of the gas remains constant while the temperature varies, since both λ and mc^2 are proportional to the absolute temperature the ratio of the two will be independent of the temperature, and the variation of i with the temperature will depend solely upon the variations of I .

135. Even when there is no external electric field the diffusion of the ions will produce a small current due to the drift of the negative ions from the illuminated electrode. If n is the density of the negative ions at the illuminated electrode, n' that at the other electrode, the gradient of density is $\frac{n-n'}{l}$ when l is the distance between the electrodes; hence if D is the coefficient of diffusion of the negative ions, i the current through unit area,

$$D \frac{(n-n')e}{l} = i.$$

We have also

$$Ie - \frac{cne}{\sqrt{6\pi}} = i,$$

and

$$\frac{cn'e}{\sqrt{6\pi}} = i.$$

Hence

$$Ie - \frac{c}{\sqrt{6\pi}} \frac{li}{D} = 2i,$$

or

$$i = \frac{Ie}{2 + \frac{c}{\sqrt{6\pi}} \frac{l}{D}}.$$

136. Elster and Geitel* and Stoletow† found that, with the strength of electric field used by them, the rate of escape of electricity through carbonic acid gas was much greater than that through air or oxygen. Breisig‡ on the contrary found that the rate was less through CO₂ than through air: and that it was exceptionally large through the vapours of ether and alcohol. The rate of leak varies so much with the potential difference that a comparison of the rates of leak for the different gases with only one value for the potential difference is not satisfactory and gives little information. What is really wanted is a comparison for the different gases of the curves representing the relation between the current and the potential difference. This has been done by Varley§, one of whose curves is given in Fig. 63. It will be seen that the current due to the photo-electric effect is with

* Elster and Geitel, *Wied. Ann.* xli. p. 161, 1890.

† Stoletow, *C. R.* cvii. p. 91, 1888.

‡ Breisig, *Bonn. Diss.* 1891; *Wied. Beiblätter*, xvii. p. 60.

§ Varley, *Phil. Trans.* 302, p. 439, 1904.

weak electric fields greater in air than in hydrogen, with strong fields it is greater in hydrogen than in air. It would also be desirable to have these curves drawn for ultra-violet light of different wave-lengths. The different gases might also cause the currents to differ by altering the surface of the metal either by combining with it or by condensing on its surface.

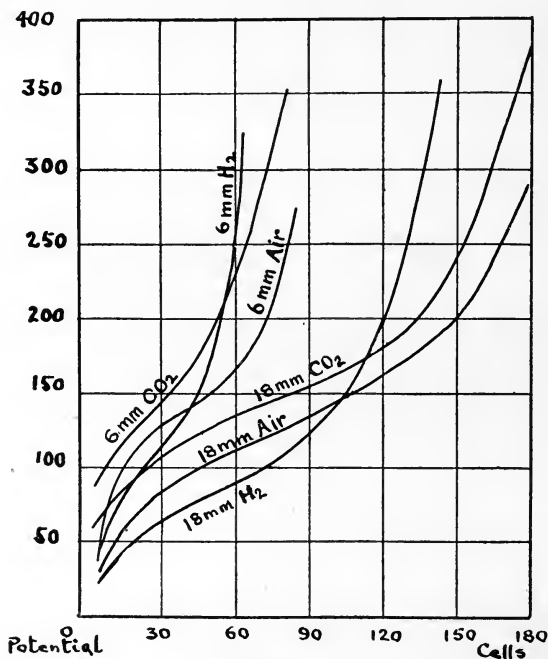

Fig. 63.

137. We shall now go on to consider the sudden increase in the current which occurs when the electric field approaches the intensity required to produce a discharge in the dark. We can, I think, explain this by means of some considerations first advanced by the author* to explain the ionisation produced when a strong electric field causes a discharge to pass through a gas. When cathode or Lenard rays pass through a gas, the gas becomes a conductor, *i.e.* it is ionised; hence we see that when very rapidly moving ions pass through a gas and come into collision with its molecules the gas is ionised, the energy required for the ionisation

* J. J. Thomson, *Proc. Camb. Phil. Soc.* Feb. 5, 1900; *Phil. Mag.* v. 50, p. 278, 1900.

coming from the kinetic energy of the rapidly moving ions. Inasmuch as the ionisation of a molecule of a gas requires the expenditure of a finite amount of work, a moving ion cannot ionise a molecule against which it strikes unless its kinetic energy exceeds a certain critical value, but when its energy does exceed this value then a certain fraction of the number of collisions between the ions and the molecule will result in ionisation. Now when the ions are moving in an electric field, the kinetic energy acquired by the ions will increase as the strength of the field increases, and when the field is strong enough to make the kinetic energy of the ions exceed the critical value, the ions by their collisions will give rise to new ions, and thus there will be an increase both in the number of ions and the current through the gas: it is this increase which is so marked a feature of the currents produced by ultra-violet light when the electric field is strong.

If l is the mean free path of an ion, X the electric force, e the charge on the ion, then the mean kinetic energy given to the ion by the electric field is Xel ; when therefore Xel exceeds a certain critical value, ionisation will take place in a certain fraction of the collisions; let us denote this fraction by $f(Xel)$, $f(x)$ being a function of x which vanishes when x is less than a certain value. If there are n ions per cubic centimetre, then the number of collisions in unit time is equal to nv/l , where v is the average velocity of translation; hence the number of ions produced in unit time per unit volume is $\frac{nv}{l}f(Xel)$. A certain number of collisions may result either in the recombination of the ion, or the attachment of the ion to the system against which it collides, so that the ion ceases to be available for carrying the current; let a fraction β of the collisions result in the destruction of the ion as an ionising agent, then the number of these ions which disappear from a cubic centimetre of the gas in unit time is $\beta \frac{nv}{l}$ *, hence the excess of the ions produced over those which disappear is equal to

$$\frac{nv}{l} \{f(Xel) - \beta\} \dots\dots\dots(1).$$

* We have here neglected the loss of ions due to the recombination of positive and negative ions in comparison with that due to the collision of the ions with the molecules.

We have by the equation of continuity, if u is the average velocity of translation parallel to the axis of x ,

$$\frac{dn}{dt} + \frac{d}{dx}(nu) = \frac{nv}{l} \{f(Xel) - \beta\} \dots\dots\dots(2).$$

Now when the ions are moving so rapidly that they have sufficient kinetic energy to act as ionising agents, their velocity must be mainly due to the electric field, since when this field is absent no ionisation is produced. Hence we have approximately

$$v = u.$$

When things are in a steady state we have by (2)

$$\frac{d}{dx}(nu) = \frac{nu}{l} \{f(Xel) - \beta\};$$

integrating we get

$$nu = C\epsilon^{\frac{1}{l} \int_0^x (f(Xel) - \beta) dx},$$

or if as a first approximation we regard X as constant we have

$$nu = C\epsilon^{\frac{x}{l}(f(Xel) - \beta)}.$$

If the current has reached the saturation stage before ionisation begins, then $nu = \dot{I}$ when $x = 0$, x being measured from the illuminated plate, hence

$$nu = I\epsilon^{\frac{x}{l}(f(Xel) - \beta)};$$

if d is the distance between the plates, then i the current is the value of nue when $x = d$, thus

$$i = eI\epsilon^{\frac{d}{l}(f(Xel) - \beta)} \dots\dots\dots(3).$$

When this additional ionisation sets in, the current with a constant value of X increases with the distance between the plates; this effect has been observed by Stoletow*. As long as the ionisation is confined to that produced at the metal plate by the ultra-violet light, the current is determined by the electric force, i.e. i is a function of X and not of d ; when however the secondary ionisation occurs i is a function of both X and d .

* Stoletow, *Journal de Physique* [2], ix. p. 468, 1890.

The point at which the secondary ionisation begins is when Xel has a certain definite value; as l the mean free path of an ion is inversely proportional to the pressure, the value of X required to start the secondary ionisation will be directly proportional to the pressure; the curves given by v. Schweidler* for the relation between the current and electromotive force at different pressures show that his experiments are in fair agreement with this result, he only gives approximate values for the pressures, and there are hardly sufficient points determined on the curve to enable us to fix with accuracy the points at which the secondary ionisation commences; but from an inspection of his curves I should say that at a pressure of 750 mm. secondary ionisation began when the difference of potential between his plates, whose distance apart is given as between 3—5 mm., was equal to 4700 volts; at 130 mm. to 1150 volts, and at 17 mm. to about 140 volts.

It is evident that the current cannot go on continually increasing as the pressure diminishes, for, when the free path gets comparable with the distance between the plates, there will be very few collisions, and therefore little if any secondary ionisation; in the limit when the pressure is indefinitely reduced, the number of ions reaching the plate not exposed to the light must equal the number leaving the illuminated plate, hence with our previous notation the limiting current will be equal to I_e .

The value of the free path at the pressure when the current is a maximum is by equation (3) determined by finding the value of l which makes $\{f(Xel) - \beta\}/l$ a maximum, this condition gives $f'(Xel)Xel = f(Xel) - \beta$, an equation to determine Xel ; thus when the current is a maximum Xl has a constant value, this coincides with Stoletow's result that if p_m is the pressure at which the current is a maximum X/p_m is constant.

138. We shall see later on that the positive ions can act as ionisers when their kinetic energy exceeds a certain value which is much greater than that required to give this property to the negative corpuscles. To calculate the effect of the ionisation produced by the positive ions we may proceed as follows, let m be

* v. Schweidler, *Wien. Ber.* cvii. p. 273, 1899.

the number of positive ions per cubic centimetre, w the velocity of the positive ion, l' the mean free path of this ion, $F(Xel')$ the fraction of the collisions which result in ionisation, then neglecting the recombination of the ions which in the intense fields we are considering will be small, we have, from the equations of continuity,

$$\frac{dn}{dt} + \frac{d}{dx}(nu) = \frac{nu}{l}f(Xel) + \frac{mw}{l'}F(Xel'),$$

$$\frac{dm}{dt} - \frac{d}{dx}(mw) = \frac{nu}{l}f(Xel) + \frac{mw}{l'}F(Xel'),$$

x is measured in the direction of motion of the positive ions, the rest of the notation is the same as before.

When things are in a steady state $\frac{dn}{dt}$ and $\frac{dm}{dt}$ vanish and since $e(nu + mw) = i$, we have

$$\frac{d}{dx}(enu) = \frac{enu}{l}f(Xel) + \frac{i - enu}{l'}F(Xel');$$

the solution of this equation when X can be regarded as constant is

$$enu = -\frac{i\gamma}{\alpha - \gamma} + C\epsilon^{(\alpha - \gamma)x},$$

where α and γ are written for $f(Xel)/l$ and $F(Xel')/l'$ respectively, and C is the constant of integration. To determine C we have $enu = I$ when $x = 0$, hence

$$enu = I\epsilon^{(\alpha - \gamma)x} + \frac{i\gamma}{\alpha - \gamma}(\epsilon^{(\alpha - \gamma)x} - 1),$$

if d is the distance between the plates then when $x = d$, $enu = i$, or

$$i = \frac{I\epsilon^{(\alpha - \gamma)d}(\alpha - \gamma)}{\alpha - \gamma\epsilon^{(\alpha - \gamma)d}}.$$

If the distance between the plates is a large multiple of the free path of a corpuscle, then with these intense fields $\epsilon^{(\alpha - \gamma)d}$ is very large, thus it would only require a very small value of γ to make $\gamma\epsilon^{(\alpha - \gamma)d}$ equal to α , in this case i would become infinite and a spark would pass, thus when once the stage is reached when ionisation by the positive ions begins a very small increase in the field will produce an enormous increase in the current culminating in the passage of a spark.

139. The velocity with which the corpuscles are projected from the illuminated metal is a matter of great importance, for if

this velocity exceeded a certain value the corpuscles would, near the surface of the plate, ionise the gas even though the electric field were so weak that the kinetic energy given by it to the corpuscles was too small to make the corpuscles act as ionisers. The velocity at emission of the corpuscles has been measured by Lenard*, he found that in the very high vacua the illuminated surface continued to give off negative corpuscles even when there was a small charge of positive electricity on the illuminated plate, showing that the corpuscles were projected with sufficient energy to make their way against a small retarding force; by measuring the differences in the number of corpuscles projected as the positive charge on the illuminated plate was increased, he was able to calculate the number of corpuscles which at projection possessed any assigned velocities. He found that the corpuscles were not all emitted with the same velocities. The distribution in the velocities of the particles emitted by platinum, aluminium and carbon is given in the following table, the velocities are those at right angles to the surface of the metal.

	Carbon	Platinum	Aluminium
Corpuscles emitted with velocities between 12 and 8×10^7 cm./sec. ...	0·000	0·000	0·004
Corpuscles emitted with velocities between 8 and 4×10^7 cm./sec. ...	0·049	0·155	0·151
Corpuscles emitted with velocities between 4 and 0×10^7 cm./sec. ...	0·67	0·65	0·49
Corpuscles only emitted with the help of an external electric field	0·28	0·21	0·35
	1·00	1·00	1·00

Part, at any rate, of the difference in the velocities of the corpuscles may be due to the fact that, as Ladenburg† has shown, the corpuscles come from a layer of finite thickness, thus those which come from the deeper parts of the layer will, when they emerge, have made more collisions with the molecules of the metal than those which come from the shallower parts, and so will have had their velocities more reduced before they emerge from the metal.

* Lenard, *Ann. der Phys.* viii. p. 149, 1902.

† Ladenburg, *Ann. der Phys.* xii. p. 558. 1903.

140. To get clear of a conducting surface the corpuscles must start with very considerable velocities. For the negatively charged corpuscle when near the surface will in consequence of electrostatic induction be attracted towards the surface, and will be dragged back into the surface unless its velocity of projection exceeds a certain value. If r is the distance of the corpuscle from the metal surface when it starts, then $\frac{1}{2}mv^2$ the initial kinetic energy must be greater than $e^2/4r$ in order that the corpuscle should escape from the surface, here e is the charge and m the mass of the corpuscle. If $r = 10^{-8}$ cm., then since $e/m = 5.1 \times 10^{17}$ (in electrostatic units), $e = 3.4 \times 10^{-10}$, v must be greater than 9×10^7 cm./sec. The velocities measured by Lenard were those possessed by the corpuscle after it had escaped from the electrostatic attraction of the metal surface.

This dragging back of the corpuscles by electrostatic induction will be diminished if at the surface of the metal there is a double layer of electrification, such as might arise from a film of condensed gas, with the positive coating outside and the negative one next the metal; in this case the electric field between the coatings will help to pull the corpuscle away from the metal. We have very considerable evidence in favour of the existence of such layers, and the fact observed by Wulf* that the photo-electric stream from platinum could be increased almost tenfold by charging its surface electrolytically with hydrogen, suggests that these layers may produce exceedingly large effects.

This is what we should expect from the values of the velocities of projection obtained by Lenard; an inspection of the table shows that in the case of carbon 95 per cent. of the corpuscles are projected with velocities less than 4×10^7 cm./sec., this velocity is that acquired by the fall of the corpuscle through a potential difference of .5 volt. Thus a gas film at the surface of the carbon with a potential difference of .5 volt (the negative coating being outside) would practically entirely stop the emission of corpuscles from the illuminated carbon.

141. The greatest velocity of projection found by Lenard was that corresponding to the fall of the electric charge on the corpuscles through a potential difference of about 5 volts, from his experiments he came to the conclusion that a corpuscle did not

* Wulf, *Ann. der Phys.* ix. p. 946, 1902.

produce ions by collision with molecules unless its velocity were at least that due to the fall of its charge through a potential difference of 11 volts. It is evident however that these rapidly moving corpuscles, just expelled from the metal, will require less energy to bring their velocities up to ionising point, than those corpuscles in the body of the gas which have had their velocities reduced by repeated collisions with the molecules of the gas, so that a comparatively weak electric force close to the plate will cause ionisation to take place in that region. The ionisation by collision in a case like this differs from that previously investigated, inasmuch as it is confined to the region close to the illuminated surface, and does not take place in the rest of the field. The effect of this increased ionisation close to the surface in the current is much the same as if the number of corpuscles emitted by the surface were increased. An inspection of the curves given by Varley, Figs. 61 and 62, suggests that something of this kind must take place; we see from these that when the pressure is low, but not too low, say about 1 mm., the current under an electric field too small to give a corpuscle starting from rest enough energy to make it act as an ioniser is greater than the saturation current in the highest vacuum, the latter, if no surface films are removed by the reduction of pressure, is the measure of the number of corpuscles given out by the illuminated surface. Since in the gas at 1 mm. the current is greater than this saturation current, even when the electric field is comparatively weak, there must be more ions than are given out by the metal plate, these on this view are produced by collisions close to the electrified plate.

It is interesting to notice how small the amount of energy carried away by the stream of corpuscles ejected by the ultra-violet light is in comparison with that emitted by ordinary thermal radiation. In Lenard's experiments quoted on page 263 the saturation current was about 25×10^{-10} coulombs/sec. If the corpuscles were all ejected with the velocity due to a fall of their charge through 5 volts (this is considerably above the average) the number of ergs emitted per second would be $5 \times 10^8 \times 25 \times 10^{-10}$ or 1.25. The illuminated surface had an area of about 7 sq. cm., so that the number of ergs emitted from 1 sq. cm. per second was only .18. The number of ergs radiated per sq. cm. per second from a black body at 0° C. is about 25,000.

142. Lenard* has made the very important discovery that the velocity of projection of the corpuscles projected through the agency of ultra-violet light is independent of the intensity of the light. The *number* of corpuscles emitted is proportional to this intensity but the velocity of each corpuscle depends only upon the nature of the illuminated surface. A little consideration shows that this result has very important consequences. It proves that the velocity of the corpuscles is not due to the direct action upon the corpuscle of the electric force, which according to the Electromagnetic Theory of Light occurs in the incident beam of light. It suggests that the action of the incident light is to make some system, whether an atom, a molecule or a group of molecules, in the illuminated system unstable, and that the systems rearrange themselves in configurations in which they have a much smaller amount of potential energy, the diminution in the potential energy will be accompanied by a corresponding increase in the kinetic, and in consequence of the increased kinetic energy corpuscles may be projected from the atoms in the illuminated substance. It may be pointed out in illustration of the effect of the light in changing the systems in the substance on which it shines that there are many cases of the production by light of isomers of organic compounds accompanied by the evolution of heat. Thus on this view the expulsion of the corpuscle from the substance is due to a kind of explosion; in the case of an elementary substance this explosion may be an explosion of the atom, such as might be produced by a rearrangement of some of the corpuscles of which it may be supposed to be constructed, and the energy with which the corpuscles are projected may be derived from the internal energy of the atom. On this view the substance is to some extent altered by the incidence of the ultra-violet light, and if the substance is an element we may suppose that some of its atoms have been changed. We have as yet no direct evidence of such a change, unless part of the phenomena of "fatigue" (see p. 287) are due to it. A simple calculation will show that the amount of matter changed by the emission of corpuscles under ultra-violet light would in the course of any feasible experiment be exceedingly small. A photo-electric stream of 10^{-10} coulombs per second per square centimetre is one of more than average

* Lenard, *Ann. der Phys.* viii. p. 149, 1902.

intensity, yet it would require such a stream to flow uninterruptedly for 300 years before all the atoms in a surface layer of the substance had changed their character. We arrive at this number in the following way. The corpuscles, as Ladenburg* has shown, have their source in a layer of finite thickness. He found on coating a glass plate with layers of nickel of different thicknesses that the photo-electric effect increased with the thickness of the nickel as long as the thickness was less than 10^{-4} cm., when this thickness was reached the photo-electric effect became normal and independent of the thickness. Hence we may suppose that the supply of corpuscles is drawn from a layer 10^{-4} centimetres thick, the number of molecules in the portion of this layer having a surface of 1 square centimetre is of the order 10^{20} . If each of these molecules supplied only one corpuscle, the amount of electricity on the corpuscles would be about 1 coulomb, hence since in 1 second only 10^{-10} coulombs are set free, it would take 10^{10} seconds or more than 300 years before all the molecules in the layer had exploded; while if the energy of the explosion were sufficient to liberate more than one corpuscle this period would have to be greatly extended. It would be interesting to see if the properties of a thin film of an intensely photo-electric substance like rubidium suffered any change after prolonged exposure to light.

The Photo-electric Effect depends upon the orientation of the plane of polarisation of the Light.

143. Elster and Geitel† made the very interesting discovery that when the incident light is plane polarised, the photo-electric effect, the intensity and angle of incidence being the same, is greater when the light is polarised at right angles to the plane of incidence than when it is polarised in that plane. On the Electromagnetic Theory of Light there is in light polarised at right angles to the plane of incidence an electric force with a component normal to the reflecting surface, when the light is polarised in the plane of incidence the electric force is parallel to this surface. The most convenient way of investigating the effect of polarisation is to

* Ladenburg, *Ann. der Phys.* xii. p. 558, 1903.

† Elster and Geitel, *Wied. Ann.* lii. p. 433, 1894; lv. p. 684, 1895; lxi. p. 445, 1897.

use a liquid surface, as it is important that the reflecting surface should be smooth, and to choose a liquid which is sensitive to ordinary light, as it is then possible to use a Nicols prism to polarise the light: the liquids used by Elster and Geitel were the liquid alloy of sodium and potassium, and amalgams of rubidium and caesium; these were placed in vessels from which the air was exhausted and the rate of escape of negative electricity observed with light incident on the surfaces at different angles. Some of the results obtained in this way are given below, data were not given to enable us to say to which stage of the curve connecting the rate of escape of negative electricity with the electromotive force the observations refer.

Rate of escape (i) of electricity from sodium potassium amalgam exposed to white light polarised at right angles to the plane of incidence.

Angle of incidence	<i>i</i>	Angle of incidence	<i>i</i>	Angle of incidence	<i>i</i>
0°	2.8	30°	17.4	60°	28.7
10	5.2	40	23.4	70	23.8
20	11.2	50	27.0	80	11.0

Rate of escape (i) of electricity from the same cell exposed to white light polarised in the plane of incidence.

Angle of incidence	<i>i</i>	Angle of incidence	<i>i</i>	Angle of incidence	<i>i</i>
3°	2.8	30°	2.65	60°	1.51
10	2.78	40	2.24	70	1.01
20	2.87	50	1.80	80	.33

Thus, except at perpendicular incidence when the two are necessarily equal, the leak caused by the light polarised in the plane of incidence is very much smaller than that caused by light polarised at right angles to this plane, and we see too that whereas in the former case the current continually diminishes as the angle of incidence increases, in the latter it increases with the angle of incidence until the latter is about 60°, after this the current decreases.

Elster and Geitel have determined how the amount of light absorbed by the metal varies with the angle of incidence for light polarised in and at right angles to the plane of incidence. The absorptions and the corresponding photo-electric currents are shown in Fig. 64. Curves (1) and (2) represent the photo-electric currents due to light polarised at right angles and in the plane of incidence respectively, curves (3) and (4) the absorptions of the light in these cases. It will be seen that in each case the current and absorption increase and decrease together, but that a given amount of absorbed light is very much more efficacious in producing discharge when its plane of polarisation is at right angles to, than when it is in, the plane of incidence. The connection between the absorption and current is made clearer by the following considerations given by Elster and Geitel. Suppose the intensity of the incident light polarised at right angles to the plane of incidence is unity, let the amount of light absorbed when the angle of incidence is ϕ be a_ϕ , and a_0 when $\phi = 0$, then when the angle of incidence is ϕ , the component of the electric force parallel to the

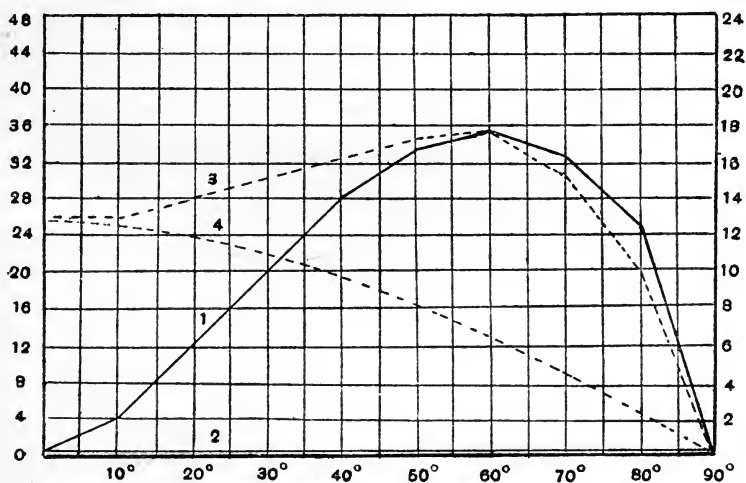

Fig. 64.

surface is proportional to $\cos \phi$, and the energy corresponding to this component to $\cos^2 \phi$; the amount of this energy absorbed will be $a_0 \cos^2 \phi$, hence $a_\phi - a_0 \cos^2 \phi$ will be the energy due to the electric force at right angles to the surface absorbed by the metal. Suppose I_ϕ is the current when the angle of incidence is ϕ , I_0 the

current when the angle of incidence is zero for unit intensity of light, the intensity due to the electric force parallel to the surface is $\cos^2 \phi$, the current due to this is $I_0 \cos^2 \phi$, hence the current arising from the component of the electric force perpendicular to the surface may be taken to be $I_\phi - I_0 \cos^2 \phi$. Now Elster and Geitel have shown that $a_\phi - a_0 \cos^2 \phi$ and $I_\phi - I_0 \cos^2 \phi$ are approximately proportional to each other; this is shown by the two curves in Fig. 65, which represent the variation of the two quantities with the angle of incidence. The continuous line represents the variation of the current, the dotted line that of the absorption.

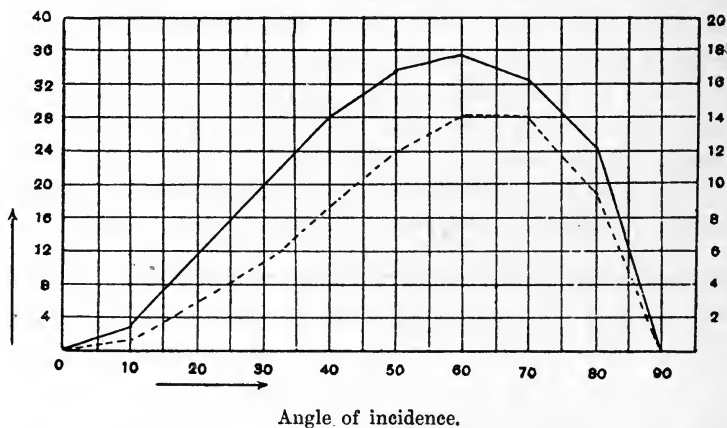

Fig. 65.

If we take the view that the photo-electric effect is due to the emission of negatively electrified corpuscles from the metal, we can explain the influence of the orientation of the planes of polarisation as follows. We may suppose that the energy from the light absorbed by the metal goes into some of the corpuscles, giving them sufficient kinetic energy to escape from the metal, just as they are able to do at a very high temperature. These corpuscles have acquired from the ultra-violet light very much more kinetic energy than is possessed by a molecule of a gas at the temperature of the metal; thus every collision a corpuscle makes with the molecules of the metal will result in a loss of kinetic energy, so that if it is to escape from the metal it is important that it should make as few collisions as possible before reaching the surface, *i.e.* that it should move approximately at right angles to

the surface. When the light is polarised at right angles to the plane of incidence there is a component of the electric force at right angles to the surface which will direct some of the corpuscles in this direction, when however the light is polarised in the plane of incidence the electric force is parallel to the surface and tends to make the corpuscles move parallel to the surface instead of towards it; thus the corpuscles have in order to escape to make more collisions in this case than the former, and so are less likely to reach the surface with sufficient energy to escape from it.

The experiments of Elster and Geitel were made with light in the visible spectrum as the substances they used, sodium and potassium alloy and rubidium, gave large photo-electric effects with light with long wave length; the effect does not seem appreciable when ultra-violet light is used, for both Lenard* and Ladenburg† have found that with this light the photo-electric effect depends solely upon the intensity of the light and is independent of the plane of polarisation or the angle of incidence; this is in agreement with Ladenburg's result that the source of the photo-electric effect is a layer of finite thickness, as the light after entering the metal would rapidly lose the peculiarities of polarisation of the incident light.

Influence of Temperature on the Photo-electric Effect.

144. The influence of the temperature of the metal on the photo-electric effect has been investigated by Hoor‡, Stoletow§, Elster and Geitel||, Righi¶, and Zeleny**. Hoor found that the sensitiveness of a zinc plate to light diminished when the temperature was raised from 18° to 55°. Stoletow found on the other hand that raising the temperature to 200° C. increased the sensitiveness, Elster and Geitel that an alteration of temperature had no effect on zinc. Righi found that the positive charge given by light to a previously uncharged plate was greater when the plate

* Lenard, *Ann. der Phys.*

† Ladenburg, *Ann. der Phys.* xii. p. 558, 1903.

‡ Hoor, *Wien. Berichte*, xxvii. p. 719, 1888. *Exner's Rep.* xxv. p. 91, 1889.

§ Stoletow, *Comptes Rendus*, cviii. p. 1241, 1889.

|| Elster and Geitel, *Wied. Ann.* xlvi. p. 625, 1893.

¶ Righi, *Atti Ist. Ven.* vii. Mem. 11.

** Zeleny, *Physical Review*, xii. p. 321, 1901.

was hot than when it was cold: we must remember that a blast of air blowing across the plate increases the positive charge so that part of the effect observed by Righi may have been due to air currents set up by the hot plate. In considering the interpretation of these seemingly discrepant results we must remember that the circumstances which affect the sensitiveness of the metal to the light will depend very much upon the strength of the field. Thus supposing we are dealing with a strong field and the gas surrounding the metal is at an exceedingly low pressure, the photo-electric current is saturated and measures the number of corpuscles given off from the metal in unit time; measurements of the effect of temperature in this case would admit of a perfectly definite interpretation, but when the gas is at a high pressure and the strength of the field is weak, *i.e.* when we are working on the earlier part of the curve connecting the current and the electro-motive force, then the interpretation of the effect of temperature

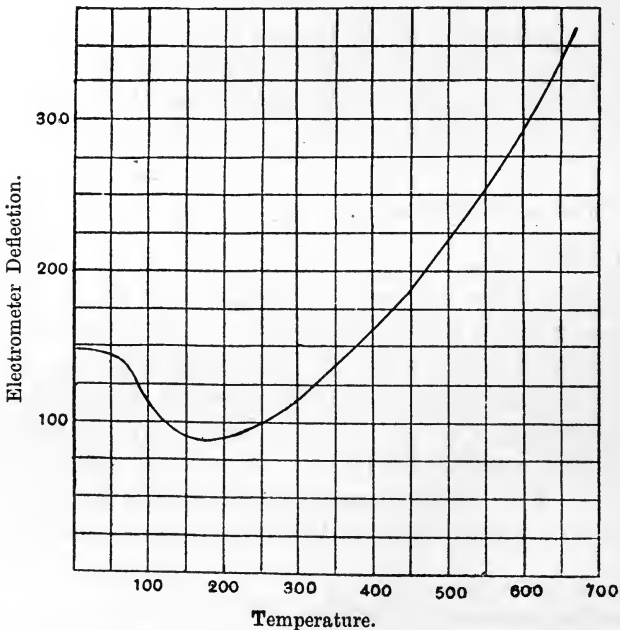

Fig. 66.

is ambiguous, for the current at this stage depends not only upon the rate of emission of the corpuscles, but also upon the velocity of

the ions through the gas. Now the increase in temperature may alter the pressure of the gas, and hence the velocity of the ions through it, and it would require further experiments to disentangle this effect of the velocity of the ions from the effect on the rate of emission of the corpuscles from the plate. The experiments of Elster and Geitel on the effect of temperature on the current from a potassium surface in a good vacuum are not open to this objection, as the effect of the gas is eliminated, and in this case they found an increase in the current of about 50 per cent. when the temperature was increased from 20° to 50° ; from some experiments made by the writer it appears that when the temperature is raised considerably higher, say to 200° , there is a very great increase in the current from the alkali metals, and that these are very much more sensitive to light at high temperatures than they are at low.

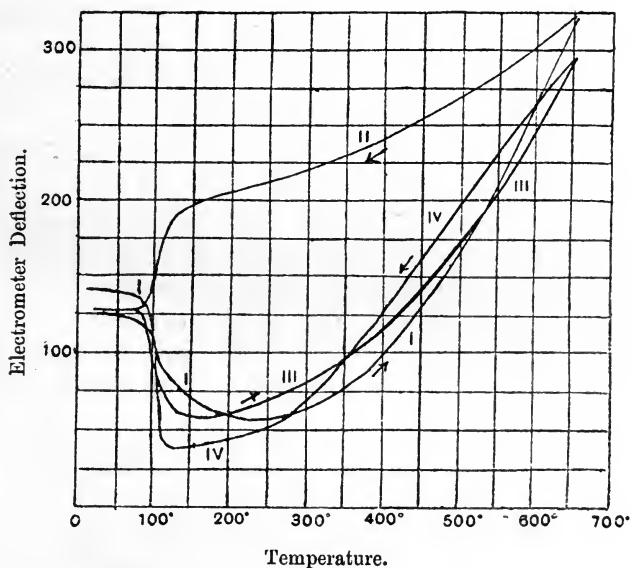

Fig. 67.

Zeleny, who measured the current from platinum and iron exposed to ultra-violet light and surrounded by air at atmospheric pressure, found that from platinum the current first decreased as the temperature increased, reached a minimum, and then

increased with the temperature as far as the highest temperature used. The results showed a curious hysteresis effect in the currents obtained, when the metal was cooling they were greater than those at the same temperature when the wire was getting hotter. These results are indicated in the curves shown in Fig. 67, where (i) represents the currents corresponding to continuously increasing temperatures, (ii) those for continuously decreasing temperatures, (iii) those for increasing temperatures, and (iv) for decreasing temperatures when the wire was cooled to the temperature of the room between each observation. These observations show that heating the wire produces some change in the surface, possibly in the amount of gas condensed upon it or absorbed by the metal, from which it only slowly recovers. With iron the minimum current is not nearly so clearly marked as with platinum, nor is there so great a difference between the curves for increasing as those for decreasing temperature; on the other hand the photo-electric current increases more rapidly with the temperature for iron than for platinum, the current at 700°C . being for iron about 40 times the current at 15°C ., while for platinum the current at 700°C . was only about 2.5 times that at 15°C .

Zeleny also investigated whether, if the metal were raised to a temperature just below that at which it would begin to give off positive ions in the dark, it could be made to give off positive ions by the incidence upon it of ultra-violet light; the positive ions were however not produced at a lower temperature in the light than in the dark. Nor when the metal was raised to the temperature at which the positive ions were produced was the rate of production increased by the incidence of ultra-violet light.

At high temperatures the streams of electricity from incandescent metals are so large in comparison with those due to photo-electric effects that variations due to the latter can only be detected with great difficulty. The photo-electric variation with temperature might more conveniently be studied by cooling the metal to very low temperatures such as those of liquid air or hydrogen, this does not however appear to have been done. It would also be interesting to see if the effects due to temperature are connected with changes in the amount of gas absorbed by the metal.

Nature of the ions produced by the action of ultra-violet light on metals.

145. The experiments made by the author and Lenard (see p. 135) show that in high vacua metals when illuminated with ultra-violet light give out corpuscles, *i.e.* bodies whose mass is only about $\frac{1}{1000}$ of that of the hydrogen atom; when however the metal is surrounded by gas the corpuscles soon strike against the molecules, get attached to them and have to drag them along with them as they move under the action of the electric field. The velocity of the negative ions through different gases has been measured by Rutherford (see p. 61), who showed that the velocity of the ion did not depend upon the nature of the metal on which the light fell, but that it did depend on the nature of the gas through which the ion had to travel, and that the velocity through any gas of the negative ion produced by ultra-violet light was very approximately the same as that of the ion produced by Röntgen rays through the same gas.

The diminution of the photo-electric effect produced by a transverse magnetic field when the pressure of the gas is low, which was discovered by Elster and Geitel*, has already been discussed on page 136.

The photo-electric effect seems to disappear immediately the light is cut off. Stoletow†, who made a series of experiments on this point, could not obtain any evidence that there was any finite interval between the incidence of the light and the attainment of the full photo-electric effect, or between the eclipse of the light and the total cessation of the effect, and he showed that the interval must at any rate be less than $\frac{1}{1000}$ of a second.

Photo-electric Fatigue.

146. The rate of emission of negative corpuscles from some metals is much greater when a clean surface is first exposed to ultra-violet light than it is after the exposure has lasted for some time. The cause of this effect, which is known as 'photo-electric fatigue,' has not yet been fully made out, and there are some discrepancies in the results of the experiments which have been made upon it. There seems no doubt that it varies

* Elster and Geitel, *Wied. Ann.* xli. p. 166, 1890.

† Stoletow, *Aktinoelektrische Untersuchungen*, *Physikalisch. Revue*, i. p. 725, 1892.

greatly (1) for different metals, (2) with the gas in which the metal is placed, and (3) with the quality of the ultra-violet light. Thus Ladenburg* found that aluminium in a high vacuum showed no fatigue, whereas the fatigue for silver was very well marked; the surface of the silver was roughened by the ultra-violet light, suggesting that particles of silver had been torn from the surface, while the aluminium surface was not affected. Ladenburg showed that the state of polish of the surface had great influence on the photo-electric effect. Varley found that while zinc became rapidly fatigued in air it did not do so in hydrogen, in this case the fatigue might be ascribed to oxidation of the surface. Fatigue however is by no means always due to oxidation, for Lenard† has observed it in the best vacuum he could obtain. v. Schweidler‡ found that fatigue did not depend upon the electrification of the surface, and that it took place just as rapidly when the surface was positively electrified, when no electricity was escaping from the plate, as when the plate was negatively charged and electricity was streaming out of the plate. Kreuzler§ and Buisson|| found that fatigue did not take place in the dark and thus was due to the action of light. Hallwachs¶, who worked with surfaces of Cu, CuO, and Cu₂O, on the other hand came to the conclusion that fatigue took place just as rapidly in the dark as in the light; he found that it was very much less in small vessels than in large ones or in the open air and he attributed it to the effect of ozone. The occurrence of fatigue in high vacua shows that this cannot be the only cause of the phenomenon. A great many of the effects can be explained by the formation or destruction of films of gas on the surface of the metal, producing double layers and helping or retarding the escape of corpuscles from the metal. These, as the calculation given on p. 276 shows, might produce enormous changes in the photo-electric effects. Buisson has shown that the potential difference in a solution between a plate and a standard metal is altered if the plate is taken out of the solution and exposed to ultra-violet light and then replaced, this is in favour of the view that the ultra-violet light affects films of gas on the metal.

* Ladenburg, *Ann. der Phys.* xii. p. 558, 1903.

† Lenard, *Ann. der Phys.* xii. p. 449, 1903.

‡ v. Schweidler, *Wien. Ber.* 112, 11a, p. 974, 1903.

§ Kreuzler, *Ann. der Phys.* vi. p. 398, 1901.

|| Buisson, *Journ. de Phys.* [3], x. p. 597, 1901.

¶ Hallwachs, *Physik. Zeitschr.* v. p. 239, 1904.

The subject of photo-electric fatigue is one of great interest, especially in connection with the view that the incidence of the ultra-violet light might produce slow changes in some of the atoms of the substance illuminated by it, such a change might produce an effect on the photo-electric power of the substance even in the highest vacua.

Connection between photo-electric effects and the fluorescence and ionisation of solutions.

147. G. C. Schmidt* made a series of experiments on this subject, with the result that there was no clear evidence of any intimate relation between photo-electric effects, ionisation and fluorescence: for while in fuchsine there seemed to be clear indications of a connection between ionisation and photo-electric effects—since aqueous solutions of fuchsine are photo-electric, while solutions in alcohol and acetone are not, and fuchsine is ionised in water and not in the other solvents—the results with eosine seemed decisive against this connection, as the addition of neutral salts, such as potassium iodide or sodium chloride, destroys the ionisation, while in aqueous solutions it has no influence upon the photo-electric effects. Again, magdala red fluoresces in alcohol, amyl-alcohol and acetone, the first two solutions are photo-electric, the last is not. Salts which undergo decomposition in the light such as the haloid salts of silver are strongly photo-electric.

In the case of water a change in the physical state seems to be accompanied by a change in the photo-electric properties, as dry ice was found by Brillouin† to be photo-electric, while water in the liquid state is not.

The opinion has been advanced by Cantor‡ and Knoblauch§ that the photo-electric effect depends upon oxidation, on the ground that the substances, elementary and compound, which exhibit this effect are those which combine with oxygen; it is however, I think, necessary to distinguish between the *power* of combining with oxygen and the *act* of combination. We should

* G. C. Schmidt, *Wied. Ann.* lxiv. p. 708, 1898.

† Brillouin, *Écl. Électr.* xiii. p. 577, 1897.

‡ Cantor, *Wien. Sitzungsber.* 102, p. 1188, 1893.

§ Knoblauch, *Zeit. f. Physikalische Chemie*, xxix. p. 527, 1899.

expect the photo-electric substances to be oxidisable, as they readily lose negative corpuscles, and thus get positively charged and in a fit state to combine with an electro-negative substance like oxygen; there is no evidence however that the presence of oxygen is necessary for the photo-electric effect, in fact the evidence the other way seems quite conclusive, for substances like rubidium and potassium enclosed in highly exhausted vessels seem to retain their photo-electric power indefinitely, and any trace of oxygen originally present would soon be absorbed by the metals.

The phenomena of photo-electric effects seem to me strongly in favour of the view that the chemical effects produced by light are due to the emission of corpuscles from some of the atoms of the illuminated compound rather than that the emission of the corpuscles is the secondary effect and chemical combination the primary. As an instance of how light might bring about a change in the chemical properties we may take the question of valency, or the electric charge carried by the atom in a compound, this depends upon the relative ability of the atoms in the compound to eject or attract corpuscles. The phenomena of photo-electricity shows that this power is strongly affected by light, hence we should expect that exposure to light might affect the valencies of the atoms, and as a matter of experience we find that many of the chemical changes produced by light are accompanied by a change of valency.

If the atom of the metal has a charge of positive electricity it will require a higher initial velocity to expel a corpuscle from the atom than if the atom were originally without charge; this may be the reason why a compound, such as NaCl, containing an atom of a very photo-electric element should have very little photo-electric power; the positive charge on the sodium atom in the compound may prevent the escape of corpuscles which would be able to emerge from a neutral atom of the metal. If the charge on an atom may have more than one value, as in the case when the element has a variable valency, the compound in which the metal has the highest valency and therefore the greatest positive charge would have a tendency to have the least photo-electric power.

CHAPTER XI.

IONISATION BY RÖNTGEN RAYS.

148. WE shall in this chapter mainly confine our attention to the ionising properties of the rays, leaving for future consideration the manner of their production and a discussion of their nature; it will however be convenient to enumerate some of their most important properties. Röntgen* found in 1895 that very remarkable effects occurred in the neighbourhood of a highly exhausted tube through which an electric discharge was passing; the exhaustion of the tube being so great that a vivid green phosphorescence appeared on the glass. He found that a plate covered with a phosphorescent substance such as potassium-platino-cyanide became luminous when placed near the tube, and that a thick plate of metal cast a sharp shadow when placed between the tube and the plate; while light substances, such as thin aluminium, cardboard, wood, cast but slight shadows, showing that the agent which produced the phosphorescence on the plate could traverse with considerable freedom bodies which are opaque to ordinary light. As a general rule the greater the density of a substance the more opaque it is to this agent; thus the bones are much more opaque to this effect than the flesh, so that if the hand is placed between the discharge tube and the plate the outlines of the bones are distinctly visible in the shadow cast on the screen, or if a purse containing coins is placed between the tube and the plate the purse itself casts but little shadow, while the coins cast a very dense one. Röntgen showed that the agent, now called Röntgen rays, producing the phosphorescence on the plate is propagated in straight lines, and is not bent in passing from one medium to another; there is thus no refraction of the rays. The rays affect a

* Röntgen, *Wied. Ann.* lxiv. p. 1, 1898 (reprinted from the original paper in the *Sitzungsberichte der Würzburger Physik. Med. Gesellsch.* 1895).

photographic plate as well as a phosphorescent screen and shadow photographs can readily be taken: the time of exposure depends on the intensity of the rays, and this depends on the discharge through the tube and on the substances traversed by the rays in their passage to the plate; the time of exposure required to produce a photograph may vary from a few seconds to several hours. The power of the rays to penetrate obstacles in their path varies very much with the condition of the discharge tube from which they originate; when the pressure in this tube is not very low, and the potential difference between its electrodes consequently comparatively small, the rays have but little penetrating power and are readily absorbed; such rays are called 'soft rays.' If the exhaustion of the tube is carried much further, so that the potential difference between the electrodes is greatly increased, the Röntgen rays have much greater penetrating power and are called 'hard rays.' With a very highly exhausted bulb and a large induction coil it is possible to get rays which will produce appreciable effects after passing through sheets of brass or iron several millimetres thick. The difference in penetrating power is well shown by observing the changes which take place in the shadow of a hand on a phosphorescent screen, as the pressure of the gas in the discharge tube is gradually reduced. When first the rays appear they are so 'soft' that they are stopped by the flesh as well as the bones, so that the bones are very indistinctly seen; when the exhaustion proceeds further the rays get harder, and are able to penetrate the flesh but not the bones. At this stage the difference between the shadow of the flesh and the bones is most distinct; when the exhaustion proceeds further the rays get so hard that they are able to penetrate the bones as well as the flesh and the shadow again becomes indistinct. Not only may the rays from different discharge tubes be different, but even the same bulb may emit at the same time rays of different degrees of hardness. The property by which it is most convenient to identify a ray is its hardness, and this is conveniently measured by the amount of absorption when it passes through a layer of aluminium or tinfoil of given thickness. Now in some experiments made by the writer and McClelland* on the absorption produced when the rays passed through one layer of tinfoil after

* J. J. Thomson and McClelland, *Proc. Camb. Phil. Soc.* ix. p. 126, 1899.

another, it was found that the absorption produced by the first few sheets of tinfoil traversed by the rays was much greater than that due to the same number of sheets after the rays had already travelled through several sheets of tinfoil. This shows that some of the rays are readily absorbed by the tinfoil while others pass through with much greater facility; thus the first few layers of tinfoil would stop the first kind of rays, while the remainder pass through with comparatively little absorption. McClelland showed that if he took plates of different metals, the thickness of the plates being chosen so that they gave the same absorption for the rays from one tube, they would not necessarily give the same absorption for the rays from another.

The Röntgen rays when they pass through a gas make it a conductor of electricity, they ionise the gas*: the number of ions produced in one second in one cubic centimetre of the gas by rays of given intensity depends upon the nature of the gas, and upon its pressure.

Effect of Pressure.

149. Perrin† has shown that the rate of production of ions per cubic centimetre by rays of given intensity is proportional to the pressure of the gas. He proved this by showing that the saturation current through a given volume of gas was proportional to the pressure. In his experiments the current passed between two large plates of metal, care being taken that the rays did not fall upon the plates; this precaution is necessary, because, as we shall see, when the Röntgen rays fall upon metal secondary rays are produced which ionise the gas, and complicate the effects. It is also necessary to arrange the electric field so that all the gas exposed to the rays—or at least every part of it from which the ions can move to the electrodes—is under the influence of an electric field strong enough to produce saturation, for unless saturation is reached throughout the whole of the gas, the current will depend upon the velocity of the ions under the electric field as well as upon the number of ions produced; as the velocity of the ions increases as the pressure diminishes the unsaturated current will diminish less rapidly with the density

* J. J. Thomson, *Camb. Univ. Reporter*, Feb. 4, 1896. Benoist and Harnozescu, *C. R.* cxii. p. 235, 1896. Righi, *Acc. dei Lincei* (5), v. p. 143, 1896.

† Perrin, *Annales de Chimie et de Physique* [7], xi. p. 496, 1897.

than the saturated one. In fact when the electric field is feeble the current will increase as the pressure diminishes, for if n is the number of positive or negative ions per cubic centimetre, q the number of ions produced in one second in a cubic centimetre, then (see p. 15) $n = (q/\alpha)^{\frac{1}{2}}$; the current under a small electric force X is equal to $neX(u+v)$, where e is the charge on an ion, u and v the velocities of the positive and negative ions under unit electric field. Now n is proportional to \sqrt{q} , and therefore to \sqrt{p} , p being the pressure of the gas, since (see p. 19) α is independent of p , while u and v are proportional to $1/p$; the current under small electric forces will vary as $1/\sqrt{p}$.

Effect of the Temperature of a Gas on the Ionisation.

150. This was first investigated by Perrin*, who, using air, came to the conclusion that if the pressure of the air was kept constant, the total ionisation was between temperatures of -12°C . and $+135^{\circ}\text{C}$. independent of the temperature, as the density of the air when the pressure is kept constant varies inversely as the absolute temperature, and as the ionisation when the temperature is constant is directly proportional to the temperature, Perrin's result would imply that the ionisation of air when the density is constant must be directly proportional to the absolute temperature. The more recent experiments of M^cClung† have shown however that for air, carbonic acid and hydrogen the ionisation when the density is constant is independent of the temperature. M^cClung made two series of experiments in one series, the pressure as in Perrin's experiments was kept constant, here the ionisation was found to be inversely proportional to the absolute temperature; in the other series the density was kept constant, when the ionisation was found to be independent of the temperature. The range of temperatures was from 15°C . to 272°C .

The variation of ionisation with temperature has a very direct bearing on the question as to what is the condition of the molecules which are ionised by the Röntgen rays. We must remember that it is only an exceedingly small fraction of the molecules which are ionised by the rays; even when the ionisation is exceptionally large the proportion of the number of free ions to

* Perrin, *Annales de Chimie et de Physique* [7], xi. p. 496, 1897.

† M^cClung, *Phil. Mag.* [6], vii. p. 81, 1904.

the number of molecules of the gas is less than 1 to 10^{12} . Thus if all the molecules of the gas are equally exposed to the rays, since the ionisation is confined to an exceedingly small fraction of the number of molecules the molecules which are ionised must be in some state very far removed from the average condition of the molecules. One supposition which naturally suggests itself is that it is only those molecules which possess an amount of kinetic energy exceeding a certain value which get ionised by the rays: the following investigation however shows that in this case the ionisation ought to vary much more rapidly with the temperature than is consistent with the results of either M^cClung's or Perrin's experiments.

For according to the Kinetic Theory of Gases the number of molecules in a cubic centimetre which have velocities between c and $c+dc$ is equal to

$$\frac{4}{\sqrt{\pi}} Nm^{\frac{3}{2}} \theta^{-\frac{3}{2}} \epsilon^{-\frac{mc^2}{\theta}} c^2 dc,$$

where N is the whole number of molecules per unit volume, θ the absolute temperature and m the mass of a molecule of the gas; hence if n is the number of molecules which have velocities greater than c ,

$$n = \frac{4}{\sqrt{\pi}} Nm^{\frac{3}{2}} \theta^{-\frac{3}{2}} \int_{c_1}^{\infty} \epsilon^{-\frac{mc^2}{\theta}} c^2 dc,$$

or putting $c^2 = \theta \omega^2$,

$$n = \frac{4}{\sqrt{\pi}} Nm^{\frac{3}{2}} \int_{\frac{c_1}{\sqrt{\theta}}}^{\infty} \epsilon^{-m\omega^2} \omega^2 d\omega;$$

hence we have

$$\frac{dn}{d\theta} = \frac{2}{\sqrt{\pi}} Nm^{\frac{3}{2}} \epsilon^{-\frac{mc_1^2}{\theta}} \frac{c_1^3}{\theta^{\frac{3}{2}}}.$$

Now since the number of molecules ionised is an exceedingly small fraction of n , if these are the molecules having a velocity greater than c_1 , then $\epsilon^{-\frac{mc_1^2}{\theta}}$ must be very small, but when this is the case n will increase very rapidly with θ ; thus suppose for a moment that $\epsilon^{-\frac{mc_1^2}{\theta}}$ is equal to 10^{-12} , then if we double θ the value of every term in the integral in the expression for n would be increased more than a million times, a result quite inconsistent with the fact that n is independent of the temperature: hence we

conclude that the few molecules that are ionised cannot owe their ionisation to the possession of an abnormal amount of kinetic energy; a similar objection would apply to the ionisation being due to any property of the molecule whose frequency was given by the Maxwell-Boltzmann Law of Distribution.

Another view that at first sight appears as if it might explain the small amount of ionisation is that this is not due to the direct action of the Röntgen rays on the molecules, but that these rays act on the free ions, which, as the phenomenon of spontaneous ionisation shows, are always present in small numbers, even when the gas is in its normal state, the rays giving to these ions sufficient kinetic energy to enable them to ionise the molecules of the gas against which they strike. To express the results of this hypothesis in an analytical form, let us suppose that the number of free positive or negative ions per cubic centimetre is n , and that in consequence of the kinetic energy given by the rays to an ion, each ion produces ω other ions per second; let the number of ions which recombine in one second be αn^2 , and let β be the number of ions produced per second from the spontaneous ionisation of the gas, then when things are in a steady state we have

$$\omega n + \beta - \alpha n^2 = 0,$$

or
$$n = \frac{\omega}{2\alpha} + \sqrt{\frac{\beta}{\alpha} + \frac{\omega^2}{4\alpha^2}}.$$

Since the number of ions produced by the rays is large compared with that $-\sqrt{\beta/\alpha}$ —due to the spontaneous ionisation β/α must be small compared with $\omega^2/4\alpha^2$, and we have approximately $n = \omega/\alpha$, thus we should have a definite value for the number of ions in a cubic centimetre of the gas. This view however leads to a result which is not in accordance with the results of observation, for the saturation current for a cubic centimetre of the gas is proportional to the number of ions produced in one second in a cubic centimetre of the gas, *i.e.* ωn . Now this number being proportional to n , the number of free ions, should be less in a strong electric field than in a weak one, for in a strong field the life of the ion is shorter than it is in a weak one, as it is rapidly driven out of the gas against the electrodes; hence if the view we are discussing were the true one, the current through a gas when the electric field is strong ought to diminish as the strength of the field

increases; as this is not the case we conclude that the ionisation cannot be produced in the way we have been considering.

Other possible explanations of the small number of molecules dissociated by the rays are (1) that the rays are of such a kind that only a small fraction of the molecules are exposed to the full force of their influence: that if, for example, we consider a plane at right angles to the direction of propagation of the rays the energy is not distributed uniformly over this plane, but that the distribution of energy has as it were a structure, although an exceedingly fine one, places where the energy is large alternating with places where it is small, like the mortar and bricks in a wall; thus if the places where the energy is intense enough to produce ionisation of a molecule occupied but a small fraction of the area of the plane at right angles to the rays, the rays would be able to pass through a gas and yet only a small fraction of the molecules would be exposed to their maximum influence, just as is the case when a beam of cathode rays passes through the gas; we shall return to this point when we consider the nature of the Röntgen rays. Another view which might be taken is that all the molecules of a gas, even though this gas may be like hydrogen an element, are not of the same kind, and that mixed with the ordinary molecules we have a few which are of such a kind as to be very easily ionised, and that the number of molecules of this kind, which are practically molecules of a different gas, is not given by Maxwell's law of distribution. The idea that even a gas is not uniform in composition, but contains, as it were mixed with it, small quantities of other gases—not necessarily as impurities due to its method of preparation but as an essential constituent of it—may appear at first stating so opposed to the ordinary facts of chemistry as not to be worthy of discussion. We may however point out that the quantities of such gases, if we may take the ionisation as their measure, are so small as to be utterly beyond the power of chemical analysis to detect, so that it cannot be by chemical considerations that the truth or falsehood of this hypothesis can be decided.

Another explanation of the smallness of the number of molecules ionised is that the ionisation of an atom is determined by its internal condition; we have reason to believe that the atoms of the elements possess large stores of internal energy and that the

amount of this energy does not vary appreciably with the temperature. We may reasonably expect considerable variation in the energy stored in individual atoms, a small number possessing amounts of energy differing considerably from the average amount possessed by the other atoms, if the atoms with the abnormal amount of internal energy were much more nearly unstable than the normal atom, then it might easily happen that only the abnormal atoms would be ionised, and as these are only a very small fraction of the whole number of atoms it follows that the number of ions will only be a very small fraction of the number of atoms.

Ionisation of Different Gases.

151. When Röntgen rays of the same intensity pass through different gases at the same pressure, the amount of ionisation depends greatly upon the nature of the gas; the number of ions produced, measured by the saturation current, is least in hydrogen, and, for the gases hitherto tried, greatest in the vapour of methyl iodide: it is also exceedingly large for mercury vapour: the relative values of q —the number of ions produced in one second in a cubic centimetre of the gas at atmospheric pressure and temperature—are given in the following table. The number for air is taken as unity.

Gas	q			Gas	q		
	Perrin *	Rutherford †	Thomson ‡		Perrin	Rutherford	Thomson
H ₂	·026	·5	·33	C ₂ N ₂	1·05
N ₂	...	·9	·89	C ₂ H ₂	1
O ₂	...	1·2	1·1	H ₂ S	...	6	6
CO ₂	1·34	1·2	1·4	SO ₂	6	4	6·4
CO	·86	HCl	8	11	8·9
NO	1·08	Cl ₂	...	18	17·4
N ₂ O	1·3	...	1·47	NH ₃	·1 ?	...	1 ?

We see that though the results of different observers are in fair agreement for most gases, for hydrogen they are very discordant. We must remember that different observers used rays

* Perrin, *Annales de Physique et de Chimie* [7], xi. p. 496, 1897.

† Rutherford, *Phil. Mag.* v. 43, p. 241, 1897.

‡ J. J. Thomson, *Proc. Camb. Phil. Soc.* x. p. 10, 1900.

of different degrees of hardness, and that it is probable that the relative ionisation in two gases depends upon the kind of rays used to ionise them. Recent experiments made by M^cClung* and by Eve† have shown that the relative amount of ionisation in different gases does depend to a very large extent upon the quality of the rays by which the ionisation is produced. Thus M^cClung obtained the following results.

Name of gas	Relative ionisation		Density of gas
	Soft rays	Hard rays	
Air	1	1	1
Hydrogen	·105	·177	·0693
Oxygen	1·3	1·17	1·11
Carbonic acid	1·46	1·33	1·53
Sulphur dioxide	11·05	4·79	2·19

In the following table the relative ionisation for soft rays as determined by Strutt‡ are compared with those for very hard rays as determined by Eve.

Gas	Relative ionisation		Density
	Soft rays (Strutt)	Hard rays (Eve)	
Hydrogen	·114	·42	·0693
Air	1·00	1·0	1·00
Oxygen	1·39	...	1·11
Carbon dioxide	1·60	...	1·53
Cyanogen	1·05	...	1·86
Sulphur dioxide	7·97	2·3	2·19
Chloroform	31·9	4·6	4·32
Methyl iodide	72·0	13·5	5·05
Carbon tetrachloride ...	45·3	4·9	5·31
Sulphuretted hydrogen	...	·9	1·18

Thus with the hard rays the ionisation is in many cases very much more nearly proportional to the density than with soft rays, hydrogen is however a notable exception to this law as it departs

* M^cClung, *Phil. Mag.* [6], viii. p. 357, 1904.

† Eve, *Phil. Mag.* [6], viii. p. 610, 1904.

‡ Strutt, *Proc. Roy. Soc.* 72, p. 209, 1903.

much more from the density law with hard rays than with soft. With the γ radiation from radium, which is much more penetrating than any radiation we can obtain by electrical discharges and which we have reason to believe is of the nature of Röntgen radiation, the ionisation in different gases is with the exception of hydrogen very approximately proportional to the density of the gas. The anomalous behaviour of hydrogen with regard to Röntgen rays is one that might well repay further investigation; it is also to be noticed that the refractive index for hydrogen is abnormally large for a gas with so small a density.

152. The gases in which the ionisation is large have also large refractive indices, it does not however seem that a large refractive index necessarily implies large ionisation; for example, the refractive index of acetylene C_2H_2 as determined by Mascart is very nearly the same as that of sulphuretted hydrogen H_2S , yet the ionisation in the H_2S is about six times that in C_2H_2 . The ionisation by soft Röntgen rays does not seem to be closely connected with the density of the gas; thus the density of H_2S is a little greater than that of O_2 and considerably less than that of CO_2 , yet the ionisation in either of these gases is small compared with that in H_2S . In other cases of ionisation such as that due to radiation from some radio-active substances, or to the passage of cathode rays through a gas, we shall see that the ionisation is much more closely connected with the density of the gas, being (except in the case of hydrogen) directly proportional to the density.

153. The writer* pointed out that the measurements given in the table on page 298 indicate that the ionisation of a gas is approximately an additive property, *i.e.* if $2[A]$ is the value of q for a gas A_2 , $2[B]$ the value for a gas B_2 and so on, then the value of q for a gas $A_lB_mC_n$ will be $l[A] + m[B] + n[C]$. Thus if we use the numbers given in the third column of the preceding table for H_2 , N_2 , O_2 , CO_2 , SO_2 , and Cl_2 to determine the values of $2[H]$, $2[N]$, etc., we find

$$\begin{array}{ll} [H] = \cdot 165, & [C] = \cdot 3, \\ [N] = \cdot 445, & [S] = 5\cdot 3, \\ [O] = \cdot 55, & [Cl] = 8\cdot 7. \end{array}$$

The amounts of ionisation for these elements are in the same order as their atomic weights. If we use these numbers to

* *Loc. cit.*

calculate the ionisation in the other gases in the table using the additive rule we get the following results.

Gas	Ionisation observed	Ionisation calculated	Gas	Ionisation observed	Ionisation calculated
CO	·86	·85	C_2H_2	1	·93
NO	1·08	·995	H_2S	6	5·63
N_2O	1·47	1·44	HCl	8·9	8·86
C_2N_2	1·05	1·49	NH_3	1	·94

Thus except in the case of C_2N_2 the agreement is within the limits of the errors of experiment.

Connection between the absorption of the rays by a gas and the ionisation produced in a gas by the rays.

154. The rays are absorbed by gases through which they pass, the amount of this absorption has been measured by Rutherford*, who used for this purpose the apparatus represented in Fig. 68.

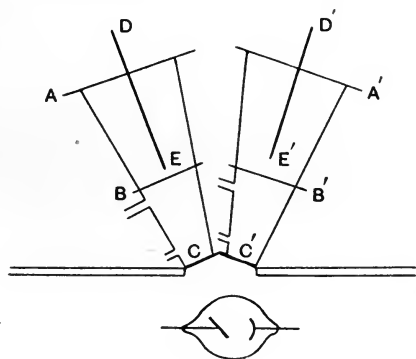

Fig. 68.

Two large similar conical vessels ABC , $A'B'C'$, much larger at the top than at the bottom, were placed in such positions that the axis of each cone passed as nearly as possible through the anode of the tube producing the Röntgen rays. The upper parts of the vessels AB , $A'B'$ were made of lead, and were separated from the lower portions, which were made of glass, by thin plates of ebonite, similar plates covered the ends of the glass cylinders at C and C' , so that the vessels BC , $B'C'$

* Rutherford, *Phil. Mag.* v. 43, p. 241, 1897.

were air-tight and could be exhausted when required. The intensities of the rays after they had passed through the glass cylinders were measured by determining the saturation currents through the lead cylinders $AB, A'B'$. Insulated wires $DE, D'E'$ were used as the electrodes, these were connected with opposite pairs of quadrants of an electrometer, both initially charged to the same potential. The outsides of the vessels $AB, A'B'$ were connected with the earth. The position of the bulb giving the rays was adjusted so that when the glass vessels $BC, B'C'$ were filled with air at the same pressure the needle of the electrometer remained at rest when the rays were passing through the vessel; this showed that the potentials of each pair of quadrants were falling at the same rate, and therefore that the currents through the vessels $AB, A'B'$ were equal. If the gas were removed from one of the vessels $BC, B'C'$ or another gas introduced, the balance was disturbed, thus showing the absorption of the rays by the gas in the vessel. If we assume that the energy absorbed when the rays pass through unit length of the gas is equal to λI , I being the energy in the rays, then the change δI in the intensity when the rays traverse a distance δx is given by the equation

$$\delta I = -\lambda I \delta x,$$

or

$$I = I_0 \epsilon^{-\lambda x},$$

where I_0 is the intensity of the rays when $x=0$. Thus if l is the length of path of the rays through the vessel BC , the ratio of the intensity of the radiation in AB when BC is full of a gas whose coefficient of absorption is λ , to the intensity when BC is exhausted, is equal to $\epsilon^{-\lambda l}$, in this way λ can be determined. Rutherford found

Gas	λ	q	Gas	λ	q
Hydrogen.....	small	·5	Sulphur dioxide	·0025	4
Air	·001	1	Sulphuretted hydrogen	·0037	6
Oxygen	about	1·2	Hydrochloric acid	·0065	11
Nitrogen		·9	Chlorine	·0095	18
Coal gas		·001	·8	Mercury vapour	·1
Carbon dioxide)		1·2	Methyl iodide	·07	...

that for air λ is about 10^{-3} , so that the rays lose about 1 per cent. of their energy in passing through 10 cm. of air at atmospheric pressure; about 7 cm. of mercury vapour at atmospheric pressure and at the temperature of boiling mercury reduced the intensity

of the rays to about $\frac{1}{2}$. The values of λ for different gases are given in the table. The third column of this table contains the relative values of q —the number of ions produced in each volume in unit time by rays of equal intensity.

These numbers show that good conductors under the rays are good absorbers of the radiation: if the conductivity were proportional to the radiation, *i.e.* if q/λ were constant, then if the whole of the radiation were absorbed by a gas the number of ions produced would be independent of the nature of the gas. For if I_0 is the initial intensity of the rays the intensity after they have passed through a distance x of the gas is $I_0\epsilon^{-\lambda x}$, hence the number of ions produced in unit time in the space dx is proportional to $qI_0\epsilon^{-\lambda x}$, thus the total number of ions produced in the gas in unit time is proportional to

$$\int_0^{\infty} qI_0\epsilon^{-\lambda x},$$

and this is equal to qI_0/λ : if q/λ is the same for all gases the total number of ions produced by rays of given intensity will be the same. The numbers given above for q/λ show considerable variations in the different gases: the discrepancies however chiefly occur in the gases for which λ is very small, and in which the errors of experiment are necessarily large.

Rutherford and M^cClung* have recently made very careful comparisons of the values of λ for carbonic acid and air; they found the ratio for the two gases was 1.59, for the ratio of the currents they found 1.43, but they consider the current through the carbonic acid was not quite saturated. I found the ratio of the currents through the two gases to be 1.53, which is very nearly the ratio of the absorptions. The value of λ depends upon the character of the rays, for hard rays it is very much smaller than for soft ones, thus the value of λ for air in Rutherford and M^cClung's experiments was only about one-quarter of the value in Rutherford's earlier experiments in which softer rays were used. In the case of the radiation from uranium—which is much more easily absorbed than Röntgen rays—Rutherford† has shown that when all the radiation is absorbed by a gas, the total amount of ionisation is approximately the same in air, hydrogen, oxygen,

* Rutherford and M^cClung, *Phil. Trans. A*, cxcvi. p. 25, 1901.

† Rutherford, *Phil. Mag.* v. 47, p. 109, 1899.

carbonic acid gas, and coal gas. Laby has recently investigated the total amount of ionisation produced by these rays in a large number of gases and found considerable variations in the amount produced in different gases, thus in SO_2 it was $\cdot 57$ and C_5H_{12} $1\cdot 34$ times that in air.

Langevin* found that when the 'soft' Secondary Röntgen Radiation (see p. 312) was entirely absorbed by air, hydrogen, coal gas, carbonic acid gas, and sulphuretted hydrogen the relative numbers of ions produced was as follows:

Gas	Total ionisation
H_2	19
Air	21·6
Coal gas	23
CO_2	23·2
H_2S	30

The difference in these numbers seems greater than can be accounted for by errors of experiment.

The absorption depends upon the pressure of the gas: using the vapour of methyl-iodide, Rutherford has shown that down to a pressure of a quarter of an atmosphere the absorption is proportional to the pressure.

155. Benoist† concludes from experiments on the vapours of bromine and iodine, of ethyl-bromide and methyl-iodide, that the absorption produced by a given mass of a substance is independent of its physical state; that, for example, the vapour of a volatile liquid or solid absorbs the same amount of radiation when in the gaseous state as when condensed into a solid or liquid.

Benoist introduces a quantity which he calls the coefficient of transparency of the substance; it is the weight in milligrammes of a prism of the substance on a base one square centimetre in area, which produces the same absorption as a standard prism of paraffin-wax 75 mm. long, when the rays travel along the axes of the prisms. He has proved the very important law, that if we have a mass M of a substance whose transparency is E made up of masses M_1, M_2, M_3, \dots , of substances whose coefficients of

* Langevin, *Annales de Chimie et de Physique* [7], 28, p. 289, 1903.

† Benoist, *Journal de Physique* [3], x. p. 653, 1901.

transparency are $E_1, E_2, E_3 \dots$, then, whether the substances are mechanically mixed or in a state of chemical combination,

$$\frac{M}{E} = \frac{M_1}{E_1} + \frac{M_2}{E_2} + \frac{M_3}{E_3} + \dots \dots \dots (1).$$

I think the meaning of this law is made clearer by the introduction of a quantity which we may call the molecular absorption of the substance, *i.e.* the absorption produced by one molecule of the substance, and which is connected with the Benoist coefficient as follows: suppose that the mass of a molecule is m , and that in Benoist's prisms there are N molecules, then $Nm = c \cdot E$, where c is a constant; by the definition of E these N molecules produce a given amount of absorption; hence if a is the absorption due to one molecule $Na = C$, where C is a constant; hence we see that

$$\frac{m}{E} = \lambda a,$$

where λ does not depend on the nature of the substance. Let us now express Benoist's law in terms of the absorption a . If there are N_1 molecules of the first substance, N_2 of the second, and so on,

$$M_1 = N_1 m_1, \quad M_2 = N_2 m_2, \quad M = Nm,$$

and

$$\frac{M}{E} = N\lambda a;$$

thus equation (1) becomes

$$Na = N_1 a_1 + N_2 a_2 + N_3 a_3 + \dots$$

This is equivalent to the statement that the absorption of any substance is equal to the sum of the absorptions of the individual molecules in that substance, the absorption due to any molecule being independent of the nature of the chemical compound of which it forms a part or its physical state. Benoist states that the absorption does not depend upon the temperature. The absorption of a body for the Röntgen rays is thus an additive property.

There is a very close connection between the absorption of an element and its molecular weight; this is shown by the curve in Fig. 69 (taken from Benoist's paper) in which the ordinates represent the equivalents of transparency of the elements, the abscissæ the molecular weight; it will be seen that the curve is quite a smooth one, in every case the transparency diminishes

as the molecular weight increases. From this it follows that the molecular absorption increases more rapidly than the molecular weight. Having got the curve connecting the transparency with

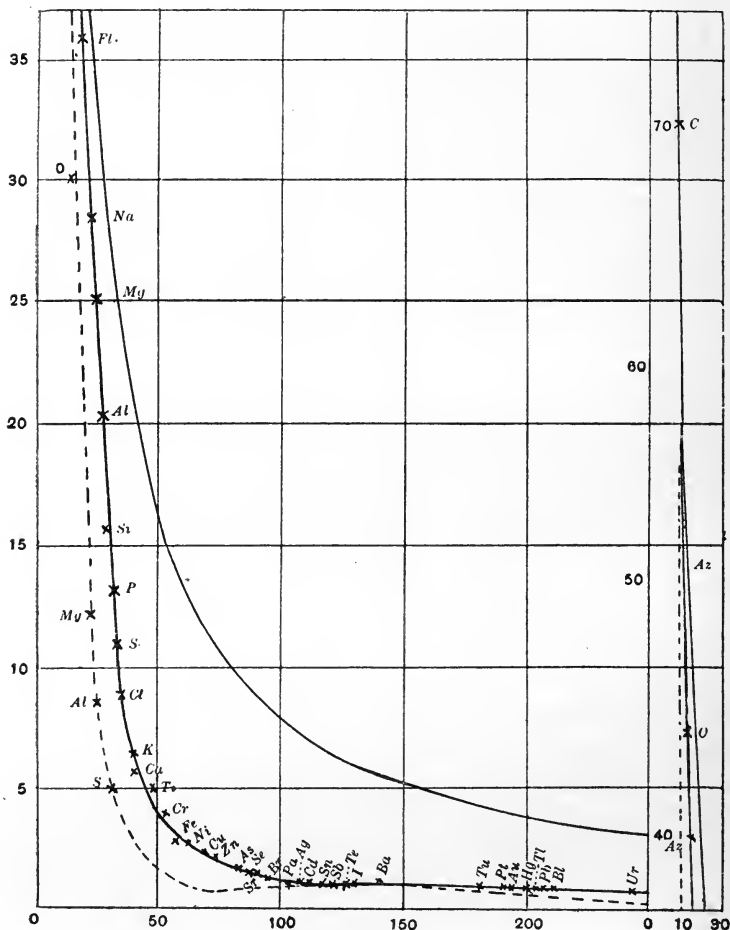

Fig. 69.

the molecular weight, it is evident that we have the means of determining the molecular weight of a substance by measuring its transparency to Röntgen rays when in a pure state or when combined with elements whose transparency is known. Benoist has applied this method to determine the molecular weight of indium.

From Benoist's results I have calculated the following relative values of a for some of the elements which often occur in gaseous compounds.

Substance	a	Substance	a
O ₂	·36	S ₂	2·8
N ₂	·27	Cl ₂	4
C ₂	·17	Br ₂	47

Knowing a for these gases we can calculate the absorptions of the gases measured by Rutherford (see page 306), the results are given in the following table :

Gas	a (Benoist)	λ (Rutherford)	a/λ
O ₂	·36	·001	360
CO ₂	·45	·001	450
SO ₂	1·76	·0025	700
H ₂ S	1·4	·0037	378
HCl	2	·0065	301
Cl ₂	4	·0095	420

In calculating the numbers in the second column I have neglected the absorption due to the hydrogen in the compound, as this is too small to be accurately determined. Benoist showed that the relative values of a depended upon the nature of the rays; indeed with the very penetrating γ rays from radium, E is a constant and a directly proportional to the atomic weight; taking this into account Rutherford's results are in fair accordance with Benoist's law except in the case of SO₂.

The question arises whether the energy absorbed by the gas is wholly accounted for by the work spent in ionising the gas or whether part of the energy of the rays is directly transformed into heat and energy in the gas without the intervention of ionisation: if the ions are allowed to recombine, the work spent in ionisation will ultimately appear as heat energy in the gas; this would however not necessarily be the case if the ions were driven out of the gas by a strong electric field. The evidence is, I think, in favour of the view that the ionisation of the gas is only accountable

for a small part of the loss of energy. Rutherford and M^cClung* have calculated the work necessary to ionise a molecule of the gas on the assumption that all the loss of energy in the rays was due to the ionisation of the gas; on this hypothesis they found the work necessary to ionise a molecule of air was equal to the work done on the ionic charge when it fell through a potential difference of about 175 volts, this is very much larger than the value of the same quantity, about two volts, obtained by H. A. Wilson and Townsend by different considerations. Combining these results we conclude that only about 1/80 of the energy of the rays is expended in the ionisation of the gas, the rest being converted into heat. Barkla (see p. 326) has shown that the loss of energy when the rays go through a gas is due much more to the scattering of the rays than to work spent in ionisation.

Secondary Röntgen radiation.

156. When the Röntgen rays pass through a substance they cause it to emit Röntgen rays—called secondary rays—which in many cases are different in character from the rays—primary rays—which produced them. These secondary rays are produced by solids, liquids and gases. Perrin† observed that when the rays struck a metal plate, more ionisation was produced than if rays of the same intensity passed through the air without coming into contact with the plate. He arranged two pairs of parallel plates so that the same volume of gas was exposed to rays of the same intensity between each pair of plates, in the one pair however the rays passed between the plates without touching the metal, while in the second pair the rays were incident normally on one of the plates; he found that the saturation current was always greater for the second pair of plates than for the first, the excess depending on the metal struck by the rays. If this plate were made of gold, zinc, lead or tin, the difference was considerable, if it were made of aluminium it was only small, while it was quite inappreciable if the plate were wet with water, alcohol or petroleum.

Sagnac‡ has made some experiments which show very clearly the existence of these secondary rays; the method he used is

* Rutherford and M^cClung, *Phil. Trans.* cxcvi. p. 25, 1901.

† Perrin, *Annales de Chimie et de Physique* [7], xi. p. 496, 1897.

‡ Sagnac, *ibid.* [7], xxii. p. 493, 1901.

shown in Fig. 70 α and β ; in the experiment represented in Fig. 70 α the secondary rays were detected by their action on a photographic plate, in that represented in Fig. 70 β by their action in discharging a gold-leaf electroscope. L is the bulb producing

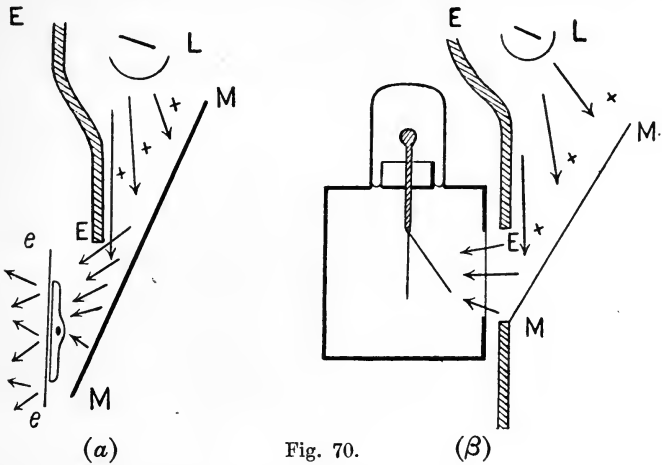

Fig. 70.

the primary rays, EE a thick lead plate to screen off these rays from the photographic plate or the electroscope, MM the plate struck by the primary rays and emitting the secondary ones, ee in Fig. 70 α the photographic plate; the electroscope is covered with a metal case connected with earth to screen off from the gas exposed to the primary rays the electric field due to the charged gold-leaves, the secondary rays entered this case through a thin aluminium window. The electroscope was discharged and the plate affected even when MM was made of comparatively light and transparent substances, such as paraffin, ebonite, sulphur, or aluminium, while a greater effect was produced by heavy substances. A small effect is produced even when the plate MM is absent, this is due to the secondary rays emitted by the air; the secondary rays emitted by air were first observed by Röntgen*, who detected them by the luminosity they produced in a phosphorescent screen.

157. Sagnac (*loc. cit.*) showed that the secondary rays were not diffusely reflected primary rays†; he did this by proving that the

* Röntgen, *Wied. Ann.* lxiv. p. 18, 1898.

† Barkla has shown that this is only true when the substance giving rise to the secondary rays is one of considerable atomic weight.

secondary rays were much more easily absorbed than the primary ones. The method he used for this purpose is shown in Fig. 71. The primary rays from the bulb l passed through two openings ab , cd in the lead plates E_1E_1 , E_2E_2 ; the secondary rays from the plate LL passed through a hole in a lead plate E_1E_1' , then through a thin aluminium window into the electroscope C . A plate of aluminium AA is placed, first in the path of the primary rays and

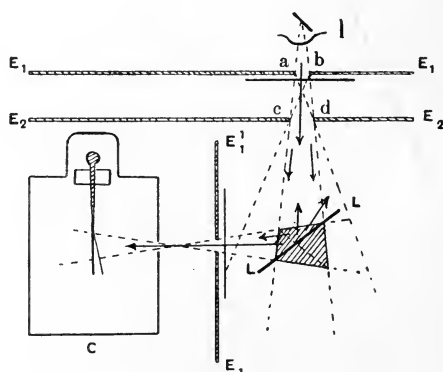

Fig. 71.

the rate of leak observed, it is then removed from the path of the primary rays and placed at $A'A'$ in the path of the secondary rays, and the rate of leak again observed; the rate of leak in the latter case is always less than that in the former, showing that the secondary rays are more absorbed by the plate than the primary ones. If t is the time taken by the gold-leaves to fall through a certain angle when the plate is at AA , t' the time when the plate is at $A'A'$, then if $c = (t' - t)/t$, c is called by Sagnac the coefficient of transformation of the rays. This coefficient depends upon the nature of the plate LL ; it is much smaller when the plate is made of light substances such as aluminium or paraffin than when it is made of heavy ones such as gold or lead: this shows that the secondary rays emitted by light substances, although not so numerous, are more penetrating than those emitted by heavy ones. Sagnac also showed that when the distance of the electroscope from the plate LL was increased, a much greater diminution was produced in the rate of leak when the plate LL was made of lead

than when it was made of zinc or copper, showing that a considerable proportion of the secondary rays from lead were absorbed by a few centimetres of air.

158. Some very interesting experiments on the secondary rays were made by Townsend*, who used the method represented in Fig. 72. The bulb producing the rays and the induction coil

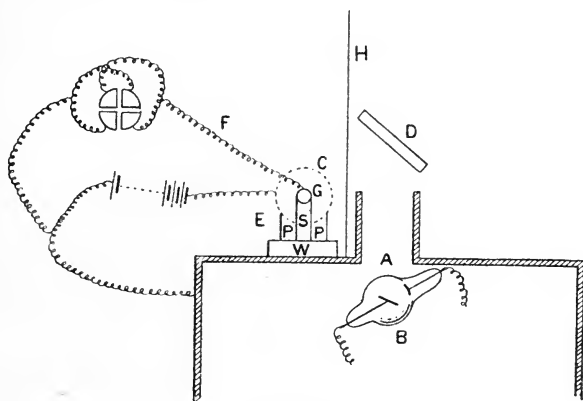

Fig. 72.

by which it was worked were placed inside a box covered with lead, having one aperture at *A* through which the rays passed up through a lead tube to prevent them from spreading out laterally. *C* is a cylinder of wire-gauze containing an axial electrode *G*. The gauze was connected with one terminal of a battery of small storage cells, the other terminal of which was put to earth, the electrode *G* was connected with an insulated pair of quadrants of an electrometer. The potential difference between the gauze and the electrode *G*, 85 volts, was sufficient to produce the saturation current. The substance emitting the secondary radiation was placed at *D* and measurements were made (1) when the secondary radiation passed through nothing but air, (2) when it passed through a plate of aluminium .25 m. thick. The results are contained in the following table; the numbers being the deflection of the electrometer in 10 seconds.

This table shows very clearly the different kinds of radiation given out by different substances; thus the radiation from brass,

* J. S. Townsend, *Proc. Camb. Phil. Soc.* x. p. 217, 1899.

zinc, and copper is almost completely stopped by the aluminium, while the radiation from other substances passes through it comparatively easily. The secondary radiation was found not to be

Radiator (substance placed at <i>D</i>)	Rays passing through Air	Rays passing through Al	Radiator (substance placed at <i>D</i>)	Rays passing through Air	Rays passing through Al
Air	2	1	Solid Paraffin	30	15.5
Aluminium ..	6	3.5	Brass	66	2.5
Glass	7.5	3	Zinc	68	3
Lead	24	6	Copper	70	2.5

much affected by the state of the surface of the body, thus the radiation from polished brass was only 2 or 3 per cent. greater than from brass coated with oxide: if the brass was covered with wet filter-paper the deflection of the electrometer was reduced from 66 to 46. The secondary radiation is not merely a surface effect, the radiation comes from a layer of the substance of appreciable thickness. This was proved by covering a plate of aluminium with a thin layer of paraffin; the radiation was reduced to about one-sixth of the amount from a solid block of paraffin. With denser substances such as lead the layer from which the secondary radiation comes will be much thinner than for a light substance like paraffin. In the first place the primary rays can only penetrate to a very small depth below the surface, and in the second place the secondary rays being so much more easily absorbed will only be able to pass through a small fraction of the thickness penetrated by the primary rays. Thus the thickness of the layer from which the radiation comes will always be much less than the thickness which can be penetrated by the primary rays. The arrangements in the preceding experiments were such that the only radiation which would affect the electrometer was that which had passed through several centimetres of air. Townsend showed that in addition to this there was also secondary radiation which was absorbed by a layer of air a few millimetres thick.

The arrangement used for this purpose is shown in Fig. 73. It was arranged to find the saturation-current between two circular plates *A* and *B*, 4.8 cm. radius, for different distances between the plates; if there were no secondary radiation this current would be proportional to these distances.

The primary rays passed through a hole M in a lead plate and then through a hole N in another lead plate on which the lower plate BB , which was made of aluminium, rested. After passing through N the primary rays passed through the air and fell on

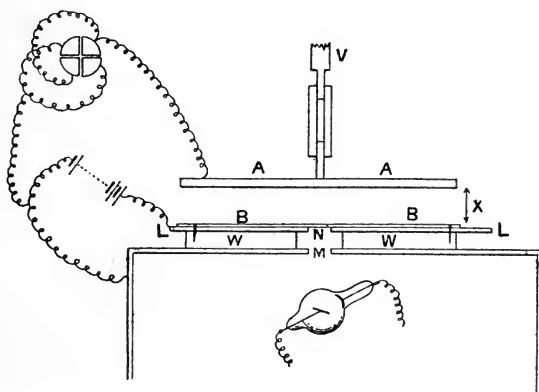

Fig. 73.

the plate AA , whose distance from B could be adjusted by means of a screw. A series of experiments were made with plates of different materials at A , the plate B was an aluminium one throughout the experiments; the results of the experiments are given in the following table: t is the distance between the plates in millimetres, and the numbers in the other columns are proportional to the saturation-currents in the various cases. The composition of the upper plate is given in the first row in the table.

t	Brass	Cu	Zn	Al
1	55	54.4	49	15
2	81	84	66	23.7
5	109.5	107.5	87	40.8
10	126	128	103	57
15	142	144	119	73

If there were no secondary radiation the 2, 3, 4 and 5 columns should be identical, and the numbers proportional to the distance between the plates. Let us take the case of brass, then when the distance between the plates is 15 mm., the number of ions pro-

duced is proportional to 142; when the distance between the plates is reduced to one millimetre, the number of ions is not reduced to $1/15$ but to $1/2.6$ only, showing that there are relatively a great many more ions in the millimetre of air next the brass plate than there are in the layers of air at a considerable distance away from it. We see from the table that the ionisation in the millimetre of air nearest the metal is proportional to 55, in the next millimetre it is 26, the average in the next three millimetres is 9.5, in the next five 3.5, and in the last five 3.2: thus by far the greater part of the secondary radiation is absorbed by a layer of air 2 millimetres thick, this part of the radiation would be all absorbed by the air between the plate and the cylinder in the experiment shown in Fig. 72, so that the numbers obtained by the use of this instrument relate to a different class of rays from those detected by the parallel plates. The curves in Fig. 74, taken from Townsend's paper, give a good idea of the rapidity with

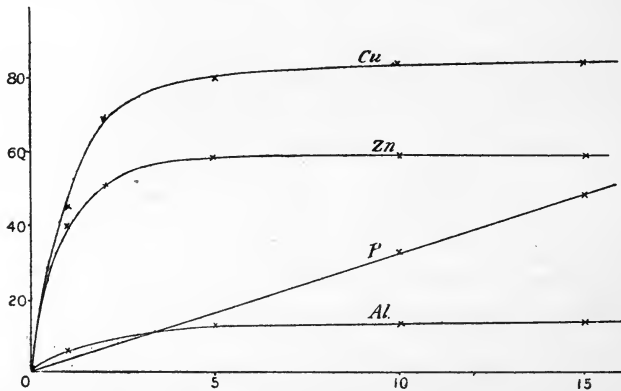

Fig. 74.

which the ionisation diminishes as the distance from the metal surface increases; the ordinates in the curves are proportional to the total amount of ionisation up to a distance from the plate represented by the abscissæ. If S is the ratio of the number of ions produced by the easily absorbable secondary rays in the air to the number of ions produced by the primary rays when they traverse a layer of air 1 cm. thick, then Townsend found that for copper $S = 2.5$, for zinc $S = 1.84$, for aluminium $S = .4$: these numbers are considerably larger than those previously obtained by Perrin, and this and the difference between these results

and those obtained by Sagnac indicate that the character of the secondary radiation depends very largely upon that of the primary. This has been shown directly by Langevin, who found that with primary rays of varying penetration he got values of S ranging from 4.4 to 1.67, the larger values corresponding to the more penetrating primary rays. H. S. Allen* has compared the number of ions produced by the secondary ionisation with those which would be produced if the primary rays were entirely absorbed by the gas; using brass as the metal and sulphuretted hydrogen as the gas, he found that the number of ions produced by the secondary radiation coming out of the brass was about $1/2000$ of the number which would have been produced if the primary rays had been absorbed by the sulphuretted hydrogen. We must remember that most of the secondary radiation is absorbed in the brass and does not emerge.

159. The effect of the secondary ionisation has to be taken into account in all investigations on the relation between the ionisation and the pressure. Thus suppose we were investigating the relation between the saturation-current and the pressure, the current passing between two parallel plates, one of these being exposed to the primary rays and giving out secondary radiation. The secondary radiation is absorbed within a short distance from the plate, and though when we diminish the pressure we increase this distance the total amount of ionisation will not be affected until the pressure gets so low that the secondary rays can travel from one plate to the other. Thus if S is the secondary and P the primary ionisation, the latter is proportional to the pressure p , equal say to ap , then, until the pressure gets so low that the secondary radiation extends from one plate to the other, the saturation-current will be proportional to $S + ap$; thus if the secondary ionisation is large compared with the primary, there will be at first very little change in the saturation-current due to a change in pressure; when the pressure gets so low that the secondary radiation is not nearly absorbed between the plates, then both secondary ionisation and primary ionisation, and therefore the saturation-current, will be proportional to the pressures.

160. The easily absorbed radiation given out by a metal plate when struck by Röntgen rays consists partly at any rate of

* H. S. Allen, *Phil. Mag.* vi. 3, p. 126, 1902.

negatively electrified particles, *i.e.* cathode rays. The cathode rays can be distinguished by being deflected by a magnetic field, and by carrying with them a charge of negative electricity so that the metal plate from which they start would, if insulated, acquire a charge of positive electricity. Dorn* has shown that rays which can be deflected by a magnet are emitted by plates of lead and platinum, and to a smaller extent by plates of copper and zinc when exposed to Röntgen rays. The direction of the deflection is the same as that of cathode rays coming from the metal. Curie and Sagnac† have shown that the metal plate emits negative electricity and acquires a positive charge; in order to demonstrate this effect it is necessary to work in a good vacuum, as if the plate is surrounded by air at an appreciable pressure, the conductivity of the air due to the primary and secondary radiations is so great that any charge on the plate leaks away before it can be observed. One of the methods used by Curie and Sagnac to demonstrate the charge on the plate is shown in Fig. 75.

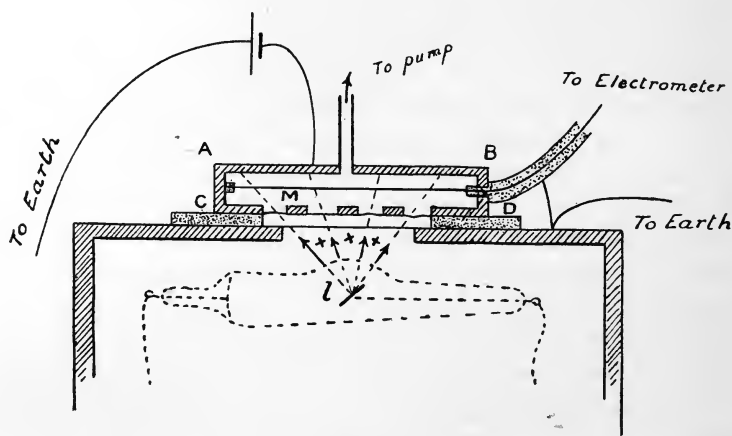

Fig. 75.

A thin piece of metal *M* is insulated and connected with one pair of quadrants of an electrometer; *M* is enclosed in a metal box *ABCD* which is connected with the earth, the lower face of the box is pierced with windows closed with thin foil of the same material as the box; the bulb *l* which produces the rays is

* Dorn, *Abhand. d. naturf. Ges. zu Halle*, xxii. p. 39, 1900, Beiblätter, 24, p. 572.

† Curie and Sagnac, *Journal de Physique* [4], i. p. 13, 1902.

enclosed in a box covered with lead. When the plate M and the box $ABCD$ are made of different metals, then at atmospheric pressure the conductivity of the air is considerable, and the arrangement acts like a galvanic battery, a potential difference equal to the contact difference of potential being established between M and the box; as we exhaust the air from the box this difference remains at first unaltered, but when a very good vacuum is obtained the potential difference is greatly increased; thus when the plate M is made of platinum and the box of aluminium, Curie and Sagnac found that at atmospheric pressure M was positive to the box by less than 1 volt, but at a high vacuum the potential of M was greater than that of the box by about 30 volts. This shows that the platinum emits more negative electricity than it receives from the aluminium. If the plate M is aluminium, and the box platinum, the plate acquired a negative charge. Curie and Sagnac showed that the penetrating power of these negatively charged rays was of the same order as that of the Lenard rays, a piece of aluminium foil about 46×10^{-4} cm. thick reducing the stream of negative electricity by about 40 per cent.: from this we may conclude that the velocity of the secondary rays is of the same order as that of cathode rays in a highly exhausted tube, say between 10^9 and 10^{10} cm./sec. Dorn* has measured the magnetic deflection of these rays and finds velocities varying from 1.8×10^9 to 8.5×10^9 cm./sec., the values depending upon that assumed for e/m .

We may compare the effects produced when Röntgen rays fall on a metal plate with those produced by the incidence of ultra-violet light; in both cases cathode rays are emitted by the metal. The secondary Röntgen rays may be compared with the reflected light or perhaps with greater accuracy with the phosphorescent light given out by certain substances under the influence of ultra-violet light; for while the reflected light is of the same quality as the incident light, the secondary Röntgen rays are not of the same nature as the primary rays, part at least of the secondary rays being much more easily absorbed than the primary ones.

On account of the great absorption of the secondary and cathode rays, the layer from which they come must be very

* Dorn, *Lorentz Jubilee Volume*, p. 595, 1900.

close to the surface: thus suppose AB is the face of a metal plate on which Röntgen rays are incident, let the primary rays penetrate to CD , then all the metal between AB and CD will be emitting secondary and cathode rays, but it is only the secondary rays which come from a thin layer $ABEF$ which escape extinction before reaching the surface, and as the cathode rays are still more easily absorbed it is only those from a still thinner layer $ABE'F'$ which emerge into the air.

The amount of secondary radiation which emerges from the metal is but a small fraction of that developed by the primary radiation, the greater part of the secondary radiation produced in the metal is absorbed before it emerges from the surface. To calculate the proportion between the amount of energy which emerges and the whole amount produced we may proceed as follows. Let γ be the coefficient of absorption in the metal of the primary rays, then if I_0 is the intensity of these at the surface, their intensity at a depth x will be equal to $I_0\epsilon^{-\gamma x}$; let the energy of the secondary radiation emitted by a stratum of metal between x and $x + dx$ be $pI_0\epsilon^{-\gamma x}dx$, if β is the coefficient of absorption of the secondary rays, the energy of this radiation when it emerges from the metal will be

$$\frac{1}{2} pI_0\epsilon^{-\gamma x}\epsilon^{-\beta x}dx,$$

thus the total energy in the emergent rays is

$$\frac{1}{2} pI_0 \int_0^{\infty} \epsilon^{-(\gamma+\beta)x} dx = \frac{1}{2} \frac{pI_0}{\gamma + \beta}.$$

The total amount of energy in the secondary ionisation is

$$pI_0 \int_0^{\infty} \epsilon^{-\gamma x} dx = \frac{pI_0}{\gamma}.$$

Thus the energy in the rays which emerge bears to the whole energy the ratio of γ to $2(\gamma + \beta)$. The ionisation due to the whole of the secondary rays would therefore be $2(\gamma + \beta)/\gamma$ times the ionisation observed in the experiments described in Art. 158. Let us compare this with the total amount of ionisation which would be produced if the primary radiation were entirely absorbed in the gas. If I is the ionisation produced per cm. of path by the primary radiation the total amount of ionisation which would be produced if all the primary radiation were absorbed is I/γ' , γ' being the coefficient of absorption of the primary rays in air.

Thus if N_0 and N are respectively the number of ions produced by the absorption of all the secondary rays and primary rays, I' the number of ions produced by the secondary rays which emerge from the plate,

$$\frac{N_0}{N} = \frac{\frac{2(\beta + \gamma) I'}{\gamma}}{\frac{I}{\gamma'}}$$

As the secondary rays are much more easily absorbed than the primary, β is large compared with γ , so that approximately

$$\frac{N_0}{N} = \frac{2\beta I'}{\gamma \frac{I}{\gamma'}}$$

Now when the density of the absorbing medium is increased the absorption of the soft rays is in general increased in a greater proportion than that of the hard, hence if β' is the absorption coefficient of the secondary rays in air,

$$\frac{\beta}{\gamma} > \frac{\beta'}{\gamma'}$$

thus

$$\begin{aligned} \frac{N_0}{N} &> \frac{2\beta' I'}{\gamma' \frac{I}{\gamma'}} \\ &> 2\beta' \frac{I'}{I}. \end{aligned}$$

From the results quoted on page 318 we see that for copper $I'/I = 2.54$, while since the secondary rays are nearly absorbed by a layer of air 2 mm. thick β' will be greater than 5. Thus

$$\frac{N_0}{N} > 25.4,$$

so that the secondary rays are capable of producing many more ions than the primary. Hence either the primary rays when they pass through heavy metals give rise to a liberation of energy, as is done for example by light waves when they pass through a mixture of hydrogen and chlorine, or else the proportion of the energy of the secondary radiation spent in ionisation is much larger than that for the primary rays. There are some grounds for believing that both these effects occur. We know that only a small fraction

of the energy of the primary rays is used up in ionisation and that this fraction diminishes as the hardness of the rays increases, while part at least of the secondary radiation consists of cathode rays, and we should expect that a larger proportion of the energy of cathode rays than that of Röntgen rays would be used up in ionisation. There is, however, evidence in favour of the view that in some cases there is a liberation of energy when Röntgen rays pass through matter. Bumstead has measured the amount of heat developed in lead and zinc when they absorb equal amounts of energy from Röntgen rays, and he finds that the heat developed in the lead is about twice that in the zinc. In his experiments the surfaces of the lead and zinc were covered with aluminium foil so that losses of energy due to heat radiation, and secondary Röntgen radiation, might be the same in the two cases. Thus if there was no liberation of energy the heating effect should be the same in the two cases. The very marked difference points to a liberation of energy at any rate in the case of the lead. This is a most interesting and important result, as it suggests that Röntgen rays may furnish a means of tapping the stores of inter-atomic energy. The phenomena of radio-activity lead us to the conclusion that the amounts of energy stored in the atoms of the elements is enormously greater than that liberated when these atoms take part in any known chemical reactions.

The incidence of Röntgen rays on elements having large atomic weights gives rise to the emission of negative corpuscles moving, as Dorn has shown, at the rate of 10^9 cm./sec. The largeness of this velocity indicates that these corpuscles do not acquire their energy directly from the incident rays, and suggests that they are projected from the atom by an explosion, due to some instability in the atom brought about by the incidence of the rays, the energy of the corpuscle being derived from the internal energy of the atom rather than from the energy in the incident rays. For if this velocity arose from the direct action of the electric force X in the incident rays, then if t is the time the pulse takes to travel over the corpuscle

$$10^9 = X \frac{e}{m} t,$$

or $Xt = 60$ since $e/m = 1.7 \times 10^7$.

The energy per unit area of the incident pulse is equal to

$$\frac{1}{4\pi} \frac{X^2\delta}{V^2},$$

where $\delta = Vt$ is the thickness of the pulse, and V the velocity of light; putting $Xt = 60$ we see that this energy is equal to $3.6 \times 10^3 / 4\pi\delta$, or taking $\delta = 10^{-5}$ as a superior limit, this energy would be nearly one calorie, an altogether inadmissible amount.

The experiments by Bumstead suggest that the incidence of the rays liberate energy from the atom, and Barkla has recently shown that the penetrating power of the soft secondary radiation, and therefore presumably the velocity of the corpuscles, is independent of the intensity of the incident rays, *i.e.* does not depend upon X ; this again, as in the corresponding case with ultra-violet light, is in favour of the view that the secondary rays are projected by an explosion of the atom under the influence of the rays and not by the direct action of the electric field in the rays on the corpuscles.

Theory of the Secondary Radiation.

161. The secondary radiation is readily explained if we adopt the theory of the Röntgen rays given in a subsequent chapter. On this theory the rays are regarded as the pulses of intense electric and magnetic force which must, by the laws of Electrodynamics, be produced when rapidly moving electrified particles, such as cathode rays, are suddenly stopped. It is shown that on the stoppage of the particle a spherical pulse of intense electric and magnetic force travels outwards with the velocity of light.

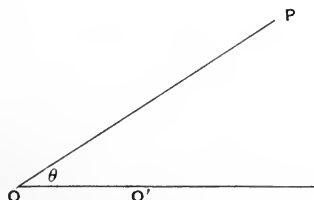

Fig. 76.

When the velocity of the particle is small compared with that of light, the distribution of the electric and magnetic forces in the pulse is as follows. If O , Fig. 76, is the position of the electrified particle after it is stopped, $O'O$ the direction along which it was

moving, e its charge, v its velocity, and V the velocity of light; then when the pulse reaches a point P , the electric force at P is at right angles to OP and in the plane of the paper and equal to

$$V \frac{ev \sin \theta}{\delta \cdot OP},$$

where δ is the thickness of the pulse and θ the angle POQ' . The magnetic force at P is at right angles to the plane of the paper and equal to

$$\frac{ev \sin \theta}{\delta \cdot OP}.$$

Thus both the electric and magnetic forces vanish along the line of motion of the electrified particle, and the electric force at P is in the plane through P and the line along which the particle is moving.

This view of the origin of the Röntgen rays is strongly supported by some very interesting experiments recently made by Barkla*. The principle of these experiments is as follows. Let IO , Fig. 77, be a stream of cathode particles striking a solid target

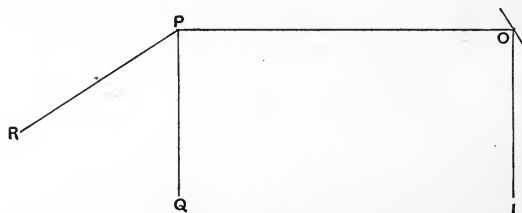

Fig. 77.

at O and OP a bundle of Röntgen rays coming out at right angles to IO , the incident cathode rays. If all the cathode particles were stopped at their first encounter with the target, the electric forces in the pulses at P would all be in the plane of the paper and at right angles to OP . If, as is actually the case, the cathode rays collide with several particles before they are stopped, the electric forces in some of the pulses will not be in the plane of the paper; there will however be a preponderance of forces in this plane, and there will be an effect of the same quality though not of the same intensity as if the forces were entirely in this plane. Assuming this to be the case let us see what will happen if the rays fall on a gas

* Barkla, *Phil. Trans. A*, 204, p. 467.

at P . The electric force in the rays will suddenly start into rapid motion the corpuscles in the gas, the direction of their motion being at right angles to OP . Pulses are produced when an electrified body is suddenly started of the same character as those generated when the body is suddenly stopped; these pulses constitute the secondary radiation given out by the gas. Let us compare the intensity of secondary radiation at two points Q and R equidistant from P and such that PQ is in the plane of the paper and parallel to IO , while PR is at right angles to this plane. Since PQ is on the line along which the corpuscles are started the intensity of the secondary radiation will be a minimum at Q , while it will be a maximum at R since PR is at right angles to the velocity of the corpuscles. If now the bulb is rotated, keeping O fixed until the stream of cathode particles is at right angles to the plane of the paper, the intensity of the secondary radiation will be a minimum at R and a maximum at P . Barkla found a well-marked effect of this character; when the stream of cathode particles was in the plane of the paper the secondary radiation was greater at R than at Q , while when the cathode rays were at right angles to the paper the secondary radiation was greater at Q than at R .

Let us suppose that such a pulse is travelling through a medium containing corpuscles—it is not necessary that the corpuscles should be free: when the pulse reaches a charged corpuscle the corpuscle will be acted on by a very intense force and its motion accelerated. Now when the velocity of a charged body is changing pulses of electric and magnetic force proceed from the body, the magnitude of these forces being proportional to the acceleration of the body: thus while the primary Röntgen pulse is passing over the corpuscle and accelerating its motion, the corpuscle gives out a pulse of electric and magnetic force—the secondary Röntgen pulse—the secondary pulse ceasing as soon as the acceleration of the corpuscle vanishes, *i.e.* as soon as the primary pulse has passed over. It is easy to compare the energy in the secondary pulse with that in the primary. For suppose the corpuscle O is moving parallel to the axis of x , let f be its acceleration, then it emits a pulse of magnetic force such that when the pulse reaches the point P , the magnitude of the force is equal to $fe \sin \theta / V \cdot OP$, V being the velocity of light, θ the angle between OP and the axis of x , and

e the charge on the corpuscle in electromagnetic units; the direction of the force is at right angles to OP and the axis of x ; this magnetic force is accompanied by an electric force at right angles to OP in the plane containing OP and the axis of x , and equal in magnitude to $fe \sin \theta / OP$: hence by Poynting's theorem the flow of energy is along OP , and since the quantity of energy flowing across unit area in unit time is, when as in this case the electric and magnetic forces are at right angles to each other, equal to the product of the electric and magnetic forces divided by 4π , the rate at which energy flows across unit surface is equal to

$$\frac{1}{4\pi} \frac{e^2 f^2 \sin^2 \theta}{V \cdot OP^2};$$

integrating this expression over the surface of a sphere with the ion as centre, we see that the rate at which energy is leaving the corpuscle is equal to

$$\frac{2}{3} \frac{e^2 f^2}{V},$$

and the total amount of energy emitted by the corpuscle is equal to

$$\frac{2}{3} \frac{e^2}{V} \int f^2 dt.$$

Now suppose that the electric force in the primary Röntgen pulse is parallel to x and equal to X , then if m is the mass of the corpuscle $f = \frac{Xe}{m}$; substituting this expression for f we find that the energy emitted by the corpuscle is equal to

$$\frac{2}{3} \frac{e^4}{m^2 V} \int X^2 dt,$$

the integration extending over the time taken by the pulse to pass over the corpuscle; if d is the thickness of the pulse and if X is constant from the front to the back of it, then

$$\int X^2 dt = \frac{X^2 d}{V},$$

and thus the total energy in the secondary radiation emitted by the corpuscle is equal to

$$\frac{2}{3} \frac{e^4}{m^2} \frac{X^2 d}{V^2}.$$

If E is the energy per unit area of the pulse, then

$$E = \frac{1}{4\pi} \frac{X^2 d}{V^2};$$

thus the energy emitted by the corpuscle is equal to

$$\frac{8\pi}{3} \frac{e^4}{m^2} E,$$

and if there are N corpuscles per unit volume the energy of the secondary radiation per unit volume is

$$\frac{8\pi}{3} \frac{Ne^4}{m^2} E.$$

Though each pulse of secondary radiation given out by a corpuscle is of the same thickness as the primary pulse, yet the properties of the secondary radiation may be very different from those of the primary, for each pulse of primary radiation causes each corpuscle to emit a pulse of secondary radiation, so that the single primary pulse produces a great number of secondary pulses following each other at intervals which depend upon the proximity of the corpuscles in the medium traversed by the primary waves; the properties of this train of pulses would depend upon λ , the average distance between the corpuscles: they would approximate to those of light of wave-length λ and might thus differ materially from those of the primary rays. In fact on this point of view there is much the same difference between the primary and secondary rays as there is between the sharp crack of lightning and the prolonged roll of thunder.

We see from the preceding equations that in passing over a distance dx , the primary pulse causes the corpuscles to emit secondary radiation whose energy is

$$\frac{8\pi}{3} \frac{Ne^4}{m^2} E dx;$$

if this were the only loss of energy experienced by the primary rays, we should have

$$dE = -\frac{8\pi}{3} \frac{Ne^4}{m^2} E dx,$$

or

$$E = C\epsilon^{-\frac{8\pi}{3} \frac{Ne^4}{m^2} x},$$

so that the opacity of the substance to the primary rays would be measured by

$$\frac{8\pi}{3} \frac{Ne^4}{m^2};$$

this is independent of d , the thickness of the pulse, and depends merely upon the medium and not upon the kind of rays passing through it: the very great difference between the penetrating power of hard and soft rays shows that the energy spent in the secondary radiation cannot be the only cause of the absorption of the primary rays.

Barkla*, who has made very valuable investigations on the Secondary Radiation produced by Röntgen rays, finds that for elements of small atomic weight the coefficient of absorption for the secondary radiation is the same as that for the primary; thus primary and secondary radiations are of the same type, so that the secondary may be regarded as scattered primary radiation. He finds that the behaviour of the secondary radiation is in accordance with the theory just given, for he shows that the proportion between the energy scattered by a cubic centimetre of a light substance and the energy of the primary radiation which has passed through the cubic centimetre is independent of the nature of the primary radiation, it is the same whether this be hard or soft: for different substances this ratio is directly proportional to the density of the substance so that equal masses scatter equal amounts of energy. The preceding investigation shows that the energy of the secondary radiation is $\frac{8\pi}{3} \frac{Ne^4}{m^2}$ that of the primary; thus the first law follows at once, and the second also follows if we suppose that the mass of a substance is proportional to the number of corpuscles it contains.

Barkla finds that the energy of the scattered radiation from one cubic centimetre of air is about $\cdot 0002$ that of the primary radiation passing through it, thus

$$\frac{8\pi}{3} \frac{Ne^4}{m^2} = \cdot 00025;$$

putting $e = 1\cdot 2 \times 10^{-20}$, $e/m = 1\cdot 7 \times 10^7$,

we find $Ne = 10$.

* Barkla, *Phil. Mag.* [6], 7, p. 543, 1904.

If n is the number of molecules of air in a cubic centimetre

$$ne = \cdot 4,$$

thus each molecule of air contains about 25 corpuscles, or the number of corpuscles in each atom would be approximately equal to its atomic weight. Since the energy scattered is proportional to the density of the gas, this result if true for one element would be true for all.

162. When the primary rays pass through substances of high atomic weight the secondary rays are no longer all of the same type as the primary, a portion of them are very much more easily absorbed than the primary ones.

When a corpuscle, after displacement by the primary rays, is acted on by very intense forces arising from the proximity of other corpuscles, it is evident that the character of the secondary pulse will not be the same as when these forces are small, for in the latter case the acceleration of the particle will sink to a very small value as soon as the primary pulse has passed over it, so that the thickness of the secondary pulse will be approximately the same as that of the primary; in the former case the acceleration of the corpuscle will be large long after the primary pulse has passed away, thus the breadth of the pulse will be much increased and the radiation will be of a different character from that of the primary.

The change in the character of the radiation seems to occur almost abruptly at a particular atomic weight, thus Barkla found considerable quantities of the easily absorbed radiation from calcium and elements of greater atomic weight, while he could not detect it at all from any substance with an atomic weight less than that of calcium.

The corpuscles will not only scatter and radiate some of the energy of the primary rays, they may themselves absorb and retain a considerable amount of energy, so that part of the energy of the primary radiation may appear as kinetic energy of the corpuscles inside the atom. The amount of energy absorbed in this way will depend upon the distribution of the electric force in the primary pulse; thus, for example, we might have a pulse in which the electric force was the same from back to front, or we might have a pulse with the same total amount of energy but with a much more complicated distribution of electric force; this

force might be in one direction in the front of the pulse and in the opposite direction in its rear. The energy scattered by the corpuscles would be the same in the two cases, but the energy absorbed by them would be very different. We shall calculate the energy absorbed (1) on the assumption that the electric force is constant throughout the pulse, and (2) on the assumption that the force is equal to X through one half of the pulse and to $-X$ through the other half. In the first case, m being the mass of a corpuscle, e its charge, $\frac{dx}{dt}$ the velocity of the corpuscle after the pulse has passed over it,

$$\text{then} \quad m \frac{dx}{dt} = \int X e dt = \frac{X \delta e}{V},$$

δ being the thickness of the pulse and V the velocity of light. The kinetic energy acquired by the corpuscle is

$$\frac{1}{2} m \left(\frac{dx}{dt} \right)^2 = \frac{1}{2} \frac{X^2 \delta^2 e^2}{m V^2}.$$

The energy E per unit area of the pulse is

$$\frac{1}{4\pi} \frac{X^2 \delta}{V^2},$$

so that the energy acquired by a corpuscle is

$$\frac{1}{2\pi} \frac{e^2}{m} \delta E,$$

and if there are N corpuscles per unit volume, the energy given to the corpuscles when the pulse travels over a distance dx is

$$\frac{1}{2\pi} \frac{e^2}{m} \delta N E dx.$$

Let us now consider the effect produced on a corpuscle when a pulse, one half of which is positive and the other negative, passes over it. Let X , $-X$ be respectively the electric forces in the positive and negative halves of the pulse, d the thickness of either pulse; then the positive pulse gives to the corpuscle a velocity Xed/Vm , and the corpuscle on the arrival of the second pulse will have moved through a distance $\frac{1}{2}(Xed/Vm)(d/V)$. The second half of the pulse gives to the corpuscle a momentum equal and opposite to that given to it by the first pulse and thus reduces it

to rest: the joint action of the pulse on the corpuscle is to leave the velocity unaltered, and to displace it through a distance ξ given by the equation

$$\xi = \frac{Xe}{m} \frac{d}{V} \frac{d}{V}.$$

If we suppose that the ion was in equilibrium in the position $\xi = 0$, and that when displaced from this position the force tending to bring it back is $\mu\xi$, the work done in displacing the corpuscle through the distance ξ is $\frac{1}{2}\mu\xi^2$, thus the energy communicated to the corpuscle is

$$\frac{1}{2}\mu \frac{X^2e^2}{m^2} \frac{d^4}{V^4}.$$

If E is the energy in the pulse per unit area, we have

$$E = \frac{1}{2\pi} \frac{X^2d}{V^2};$$

hence the work done on the corpuscle is equal to

$$\pi\mu \frac{e^2}{m^2} \frac{d^3}{V^2} E.$$

If n is the frequency of the free vibration of the corpuscle, $n^2 = \mu/m$, so that the work done on the corpuscle is

$$\begin{aligned} & \pi n^2 \frac{e^2}{m} \frac{d^3}{V^2} E \\ &= 4\pi^3 \frac{e^2}{m} \frac{d^3}{\lambda^2} E, \end{aligned}$$

where λ is the wave-length of the free vibration of the corpuscle. Thus the work done on the corpuscles when the two pulses travel over a distance δx is equal to

$$4\pi^3 \frac{e^2}{m} d^3 \Sigma \frac{N}{\lambda^2} E \delta x = hE\delta x, \text{ say,}$$

where N is the number of corpuscles giving out light of the wave-length λ in unit volume; hence we have

$$\frac{dE}{dx} = -hE,$$

or

$$E = E_0 e^{-hx};$$

h is the coefficient of absorption of the medium for the Röntgen rays when we take into account the energy absorbed by the

ions and neglect that radiated by them; we see that for a pulse in which the electric force is uniform the energy absorbed by the corpuscles is proportional to the thickness of the pulse, while when the distribution of force in the pulse consists of a force in one direction in one half of the pulse and an equal force in the opposite direction in the other half the energy absorbed by the corpuscles is proportional to the cube of the thickness of the pulse. For any pulse which can be made up by superposition of these distributions the energy absorbed will be proportional to

$$A\delta + B\delta^3,$$

where δ is the thickness of the pulse. For very thin pulses the first term will be the more important, and then, as a reference to p. 328 will show, the energy absorbed by the particles depends only upon the mass of the absorbing medium and not upon its chemical composition.

Sagnac, by allowing secondary rays to fall on metal, has obtained tertiary rays, which are even more easily absorbed than the secondary; he suggests that by a repetition of this process we might ultimately get rays having the properties of ordinary light. As yet, however, no Röntgen rays have been obtained which show any trace of refraction when passing from one medium to another.

163. The heating effects produced when Röntgen rays are absorbed by metals was first measured by Dorn*; Rutherford and M^cClung† made this effect the subject of an extensive series of measurements, using a bolometer to determine the increase in temperature produced by the rays. Their measurements were made with the object of finding the energy in the rays and it was assumed that this was equal to the mechanical equivalent of the heat produced when the rays are totally absorbed by the metal. Recent experiments made by Professor Bumstead‡ at the Cavendish Laboratory make the legitimacy of this assumption very doubtful. Bumstead found that with equal absorption of the rays the heat developed when the rays were absorbed by lead was nearly twice as great as when they were absorbed by zinc; the heat developed

* Dorn, *Wied. Ann.* lxiii. p. 160, 1897.

† Rutherford and M^cClung, *Phil. Trans.* A, cxevi. p. 25, 1902.

‡ Bumstead, *Phil. Mag.* [6], xi. p. 292, 1906.

was measured with a radiometer. This result suggests that the rays produce some change in the atoms of the substance through which they pass and that part of the heating effect is due to energy liberated by this change. The question raised by this investigation is of the greatest importance, as if a change in the atom occurs under the influence of Röntgen rays a way is opened up of tapping the stores of energy which we have reason to believe are contained in the atoms of the various elements. In this connection it would be interesting to try whether the heat developed by radium in a given time depended on the medium used to absorb its radiation, and also whether if radium were kept for a long time in contact, say, with lead, other elements would gradually be produced. The ores in which radio-active substances are found are remarkable for the number of elements they contain, may it not be possible that this may be partly due to transmutation of the elements under the action of the radiation from these substances?

I have tried a large number of experiments to see if the incidence of the Röntgen rays on metals gives rise to any products which are radio-active after the rays have ceased to fall upon the metal. The secondary radiation excited by Röntgen rays with its combination of very easily absorbable and more penetrating radiation is remarkably analogous to the radiation emitted by radio-active substances (see Chap. XII), and this suggests that the metal is radio-active while the rays are incident upon it. I was, however, unable to detect any residual radio-activity in the metal after an exposure of several hours to strong Röntgen rays. Similar experiments in which the radiation from radium was used instead of Röntgen radiation have been made by Professor Bumstead* and myself†, but with negative results.

The passage of Röntgen radiation through insulating solids and liquids increases their conductivity‡, and in some cases this increase takes some time to die away after the passage of the rays has ceased.

* Bumstead, *Proc. Cam. Phil. Soc.* xiii. p. 125, 1905.

† J. J. Thomson, *Proc. Cam. Phil. Soc.* xiii. p. 124, 1905.

‡ J. J. Thomson, *Nature*, 55, p. 606, 1897. P. Curie, *Comptes Rendus*, 134, p. 420, 1902. Becker, *Ann. der Phys.* xii. p. 124, 1903.

CHAPTER XII.

RAY'S FROM RADIO-ACTIVE SUBSTANCES.

164. SHORTLY after the discovery of the Röntgen rays Becquerel found that uranium and its compounds emitted a radiation which, like Röntgen rays, affected a photographic plate and ionised a gas through which it passed. Subsequent investigations led to the discovery of other bodies possessing similar properties. The study of these bodies has resulted in the creation of a new science of the greatest interest and importance—the Science of Radio-activity. This is discussed at length by Rutherford in his treatise on Radio-activity. The subject is so intimately connected both with the theory of the discharge of electricity through gases and with the methods employed in the study of this subject that it is desirable to study, as we shall attempt to do in this chapter, the subject of Radio-activity in especial relation to the theory of Electrical Discharge.

165. The very marked phosphorescence produced in certain substances by Röntgen rays led to a series of investigations whose object was to see whether phosphorescence was accompanied by the emission of Röntgen rays: since Röntgen rays produced phosphorescence the question naturally suggested itself, may not phosphorescence be accompanied by Röntgen rays? Early in 1896 Henry* showed that the phosphorescent substance sulphide of zinc, after exposure to sunlight or magnesium light, acted photographically on a plate protected by black paper or by thin aluminium foil. A little later Becquerel† found that if the double sulphate of uranium and potassium was placed on a photographic plate protected by light-proof paper and the system exposed to the

* Henry, *Comptes Rendus*, cxxii. p. 312, 1896.

† Becquerel, *Comptes Rendus*, cxxii. p. 420, 1896.

sun the plate was affected: he thought at first that this was due to the phosphorescence emitted by the uranium while in the light, he soon found however that exposure to the sunlight was not necessary*, and that the plate was equally affected in the dark. To test whether this effect was due to a phosphorescence which had persisted from some previous exposure of the uranium salt to light, he took a crystal of uranium nitrate and dissolved it in water in the dark; he then, keeping it still in the dark, allowed it to recrystallise, and tested its action on the photographic plate without ever exposing the crystal to light; he found that it acted strongly on the plate; he found also that the solution of uranium nitrate which is not phosphorescent is active†. On these grounds Becquerel came to the conclusion that the effect is not due to phosphorescence but is a property of the metal itself. He found too that the salts of uranium as well as the metal itself retained this radio-active property without sensible diminution after being kept in the dark, some of them in lead boxes, for more than a year. In addition to affecting a photographic plate protected by a covering opaque to ordinary light, the radiation from uranium, like the Röntgen rays, makes the gas through which it passes a conductor; thus a charged electroscope with a piece of uranium placed on the disc slowly loses its charge, whether this be positive or negative. Becquerel at first thought that the rays from uranium differed from the Röntgen rays in being capable of refraction and polarisation; subsequent investigations made by himself and others have shown however that this is not the case. Niepce de St Victor many years ago found that paper saturated with a solution of uranium nitrate affected a photographic plate.

166. Rutherford‡ made a very extensive series of experiments on the radiation from uranium and its compounds, using the electrical method of investigation, *i.e.* measuring the intensity of the radiation by the ionisation produced by the rays. He made the very interesting discovery that the radiation from uranium, like the secondary Röntgen radiation, is a mixture of two types of radiation, one type α being absorbed by a few millimetres of air

* Becquerel, *Comptes Rendus*, cxvii. p. 501, 1896.

† *Ibid.* pp. 691, 765.

‡ Rutherford, *Phil. Mag.* v. 47, p. 109, 1899.

at atmospheric pressure, the other type β having a penetrating power comparable with the rays from a Röntgen tube of moderate exhaustion. Rutherford found that the absorption by the different gases of the α type of radiation emitted by uranium or any of its compounds was such that the intensity of the radiation was reduced to one-half its value after passing through

3 mm. of carbonic acid gas,
4.3 mm. of air,
7.5 mm. of coal gas,
16.3 mm. of hydrogen.

The pressure in all cases was that due to 760 mm. of mercury. The penetrating power of the α radiation is thus intermediate between that of ordinary primary and secondary Röntgen rays.

The absorption of the α rays was shown by Rutherford to be proportional to the density of the gas.

Near a layer of uranium we have thus a region of very intense ionisation extending over the few millimetres necessary to absorb all the α rays, beyond this only the β rays penetrate, and as these have only small ionising power compared with the α rays there is in this region very much less ionisation than in the layers close to the uranium. Thus if we have two parallel metal plates over one of which a layer of uranium is spread, then if the distance between the plates is greater than that required to absorb the α radiation, the total amount of ionisation between the plates and therefore the value of the saturation current which can pass from one plate to the other will not increase much as the distance between the plates is increased, while as long as the distance between the plates is less than that required to absorb the α radiation the saturation current will be approximately proportional to the distance between the plates; this illustration will suffice to show that the phenomena of electric conduction under uranium radiation are somewhat intricate, they can however be readily explained by the existence of the two types of radiation, one very easily absorbed, the other much more penetrating.

Since the intensity of the ionisation is much greater close to the plate covered with uranium than at some distance away, the electric force near to the uranium will be less than the average

value between the plates; this fall in the electric force at the place where there is most ionisation makes it more difficult to produce a saturation current than it would be if the ionisation were uniform between the plates; this may account for the fact discovered by Rutherford (*l. c.*) that even with large potential differences between the plates the current shows an increase, though only a small one, when the potential difference is increased. This is illustrated in the curves in Fig. 78, which represent the relation between the potential difference and the current under uranium radiation. A similar effect seems to occur in all cases of ionisation by α rays.

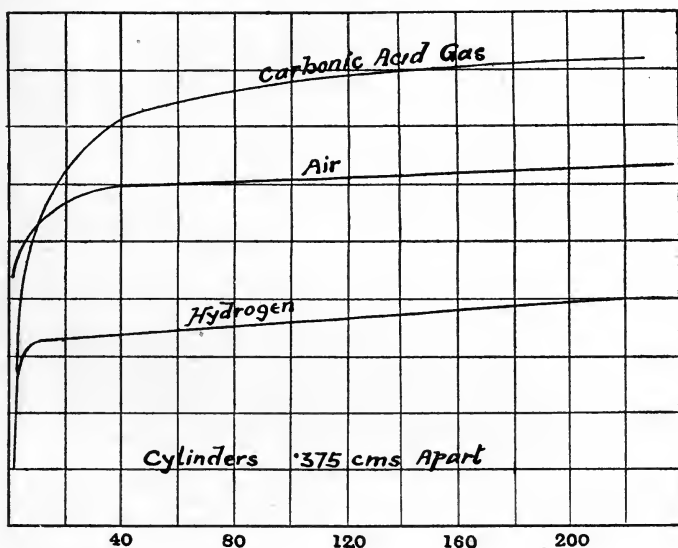

Fig. 78.

The proportion between the amounts of the β and α radiations emitted by a layer of a salt of uranium was found by Rutherford (*l. c.*) to depend upon the thickness of the layer, the thicker the layer the larger the ratio of the β to the α radiation, for very thin layers the radiation is almost wholly of the α type. This is what we should expect if we regard the α and β radiations as independent of each other: for if the α radiation is stopped by a thickness t_1 of the salt, while the β radiation is not stopped until the thickness is t_2 , the α radiation will not increase with the thickness of the layer when this is greater than t_1 , while the β

radiation will go on increasing until the thickness is equal to t_2 . If one of the radiations was produced by the other, if for example the β radiation corresponded to primary Röntgen rays, the α to the more absorbable secondary rays produced by the impact of the primary ones with the uranium close to the surface, then we should expect the proportion between the radiations to be independent of the thickness of the layer.

167. The total amount of ionisation produced when the α rays of uranium and its salts are completely absorbed has been determined by Monsieur and Madame Curie* and by Rutherford and M^cClung†, it increases somewhat with the thickness of the layer, as the following table given by the latter observers shows. The amount of ionisation is expressed in terms of the saturation current which is given in ampères per square centimetre of surface.

Surface of Uranium Oxide = 38 sq. cms.

Weight of Uranium Oxide spread over this surface in grammes	Current in Ampères per sq. cm. of surface
·138	1.7×10^{-13}
·365	3.2×10^{-13}
·718	4×10^{-13}
1.33	4.4×10^{-13}
3.63	4.7×10^{-13}

Taking the value given by Rutherford and M^cClung for the energy absorbed when each ion is produced, we find that when the saturation current is 4.7×10^{-13} ampères per square centimetre the energy emitted from a square centimetre is about 10^{-11} calories per second, or at the rate of 1 calorie in about 3000 years. If we take the radiation corresponding to the thinnest layer we find that for each gramme in the layer it is about 1 calorie in 30 years.

Radiation from Thorium.

168. Soon after the discovery of the rays from uranium, Schmidt‡ discovered that thorium gave out rays having very

* Curie, *Rapports présentés au Congrès de Physique à Paris*, t. iii. p. 79, 1900.

† Rutherford and M^cClung, *Phil. Trans. A*, cxevi. p. 25.

‡ Schmidt, *Wied. Ann.* lxx. p. 141, 1898.

similar properties. This radiation was subsequently studied by Rutherford* and by Owens†, and was found to present many features of great interest. Like the radiation from uranium it consists of two types, one easily absorbed the other more penetrating.

Discovery of Thorium Emanation.

169. The radiation from thick layers of thorium oxide when first measured by Rutherford seemed to be extremely capricious; thus, for example, when its intensity was measured by the conductivity it communicated to a gas, the slightest draught in the vessel through which the current of electricity passed was sufficient to produce a very sensible diminution in the current; indeed so sensitive was the current to external disturbances, that it was found exceedingly difficult to get consistent results. Rutherford showed that these irregularities had a most interesting cause, as he was able to trace them to an 'emanation' given off by the thorium. He found that the thorium gave off something which was wafted about by currents of air like a vapour; in order to avoid prejudging the question as to the physical state in which the substance given off by the thorium existed, Rutherford called it an emanation. This, emanation is radio-active, *i.e.* it gives off rays that can penetrate a photographic plate or ionise a gas; it can penetrate, apparently by diffusion, thin pieces of paper; it cannot, however, get through glass or mica, even when they are in very thin films: in fact, its power of getting through substances seems much more selective than the corresponding power possessed by either Röntgen, Becquerel, or cathode rays; in this respect it resembles the effect coming from certain metals and resinous substances studied by Russell. That the passage of the emanation through solids is analogous to the slow diffusion of gas through metal, as, for example, hydrogen through red-hot platinum, is suggested by the fact that if the thorium oxide is covered up with paper it takes a considerable time for the emanation to get through.

The following experiment is one by which Rutherford demonstrated the existence of the 'emanation,' and studied many of its properties.

* Rutherford, *Phil. Mag.* v. 49, pp. 1, 161, 1900.

† Owens, *Phil. Mag.* v. 48, p. 360, 1899.

A thick layer of thorium oxide was enclosed in a narrow rectangular vessel *A*, made up of two thicknesses of foolscap paper. This paper was sufficiently thick to stop all the radiation from a thin layer of thorium. The vessel containing the thorium

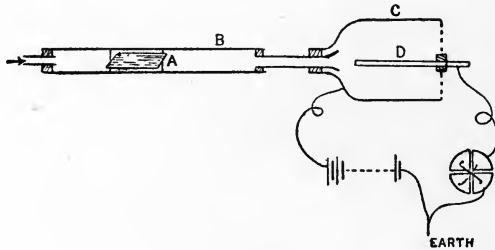

Fig. 79.

was placed inside a long metal tube *B*. One end of this tube was connected with a large insulated vessel *C*, the end of this vessel was perforated to allow air to pass through. An insulated electrode *D* was inserted in *C*, and connected with one pair of quadrants of an electrometer. *C* was connected with one terminal of a battery giving an electromotive force of 100 volts, the other terminal of this battery was put to earth.

A slow current of dust-free air was passed through the apparatus. After a short time a current began to pass between *C* and *D*, and gradually increased until it reached a certain value, when it became steady. The flow of air was then stopped, and it was found that the current between *C* and *D* persisted for about 10 minutes. As long as the current of air was passing through the apparatus there would have been a current of electricity between *C* and *D*, if ordinary radiation and no emanation had been coming from the thorium, for the radiation would have produced ionised gas in the neighbourhood of *A*, and this would have been carried by the current into *C*: but in this case the current of electricity would have stopped within a fraction of a second after the stoppage of the current of air, whereas, as we have seen, the effect persisted for 10 minutes. This shows that fresh ions must be continually produced in *C*, in other words, the substance carried over from *A* must be radio-active, and though its radio-activity diminishes with time there is enough left to be appreciable after an interval of 10 minutes.

Rutherford measured the leak between *C* and *D* at regular intervals after the stoppage of the current of air, and so was able to measure the rate at which the intensity of the radiation from the emanation died away: the intensity diminishes in geometrical progression with the time, and is thus proportional to $e^{-\lambda t}$, where t is the time and λ a constant; the intensity is reduced to about one-half its value in one minute, so that λ is about 1/86. The rate at which the radiation falls off is not affected by exposing the emanation to a strong electric field, nor could any motion of the emanation as a whole be detected in such a field: Rutherford showed that the average velocity of the particles of the emanation, under an electric field of one volt per centimetre, must be less than 10^{-5} cm./sec.

In consequence of the diffusion of the emanation from the thorium the radiation from thick layers of this substance does not cast shadows, the emanation getting by diffusion round the opaque body and obliterating the shadow.

The emanation can pass through plugs of porous substances, can bubble through water or the strongest acids, and can be raised to temperatures far above a red-heat without losing its radio-activity*; in fact, when once the 'emanation' has been produced no physical or chemical process which has yet been tried has any effect upon its radio-activity: in this inertness it resembles the gases argon and helium, the latter of which occurs along with thorium in many minerals.

Since the emanation can penetrate several millimetres of a thorium compound, the radiation from a layer of such a compound will increase with the thickness of the layer when this is less than a few millimetres; above a certain thickness the radiation becomes practically constant.

The fact that the 'emanation' can pass through porous plugs and water traps, and can withstand temperatures which alter the properties of thorium, is strong evidence that the emanation is not thorium dust, *i.e.* not small particles of thorium in the solid state; this conclusion is strengthened by the fact that the emanation does not give rise to a cloud when the air through which it is diffused suffers an expansion sufficient to produce a fog in dusty air.

* Rutherford and Soddy, *Journal of Chemical Society*, lxxxi. p. 321, 1902.

No alteration has been detected in the pressure of an exhausted bulb when the emanation is allowed to diffuse into it, nor does this intrusion of the emanation produce apparently any change in the spectrum given out by the bulb.

Induced Radio-activity produced by Thorium Emanation.

170. Rutherford* discovered that the emanation from thorium makes any substance with which it comes in contact radio-active. This can be shown by the following experiment (Fig. 80).

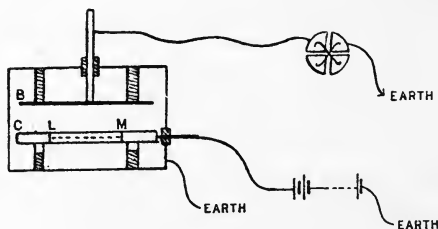

Fig. 80.

Two isolated plates *B* and *C* are placed parallel to one another in a closed metallic vessel connected with the earth. In a shallow depression, *LM*, in the plate *C*, a layer of thorium oxide is placed and covered with several layers of foolscap paper. The plate *C* is connected to the positive pole of a battery, giving a potential difference of at least 50 volts, and the other pole of this battery is connected with the earth. The plate *B* is connected with an electrometer. If this is left for several hours, and then the plate *C* with the thorium removed, and replaced by a clean metallic plate, it will be found that the gas between the plates now possesses considerable conductivity; this will gradually diminish with lapse of time and after a few days become inappreciable. If, instead of leaving *B* in the vessel when *C* is removed, both *B* and *C* are replaced by fresh plates, there will be no conductivity; the ionisation is thus due to some change produced in the plate *B* by the action of the thorium. The plate *B* has been made radio-active. That this effect is due to the action of the emanation and not of the straight line radiation may be proved in several ways. In the first place, the effect is absent if we use

* Rutherford, *Phil. Mag.* v. 49, p. 161, 1900.

a thin layer of thorium oxide, which emits plenty of straight line radiation but very little emanation. Again, when we de-emanate thorium oxide by intense heating we destroy its power of producing induced radio-activity, although we do not affect its power of emitting straight line radiation.

The close connection between the emanation and the induced radio-activity is shown by the following experiment made by Rutherford.

A slow current of air from a gas-bag passed down a rectangular wooden pipe, 60 cm. long; the air passed through sulphuric acid to dry it, and through a plug of cotton-wool in the pipe, this plug removed spray and equalised the flow of air over the cross section of the tube. A metal plate charged with positive electricity covered the bottom of the tube; four insulated metal plates *A, B, C, D*, placed at equal intervals, had a negative charge induced on them by being connected with the earth. When the current of air passed through the vessel with the velocity .2 cm./sec. for 7 hours, the potential difference between the lower and upper plates being 300 volts, the following results were obtained:

	Relative current due to emanation	Relative excited radio-activity
Plate <i>A</i> ...	1	1
„ <i>B</i>55	.43
„ <i>C</i>18	.16
„ <i>D</i>072	.061

Thus the induced radio-activity is approximately proportional to the intensity of the radiation given out by the emanation.

The experiment shows that the emanation is in some way the cause of the induced radio-activity; it does not enable us to decide whether the radio-activity is due to a deposit of the substance of the emanation on the plate, or whether it is due to a change in the surface layers of the plate produced by the *radiation* coming from the emanation. We shall return to this point when we have discussed more fully the properties of the induced radio-activity.

If in the inclosure containing the thorium and the emanation there is a conductor strongly charged with negative electricity, the induced radio-activity will be concentrated on this conductor and there will be less on the walls of the inclosure than there would be if the conductor were uncharged; thus the excess of radio-activity on the wire is obtained at the expense of that on the surrounding objects.

The amount and quality of the induced radio-activity seem to be independent of the material of which the walls of the inclosure are made; the substitution of paper or cardboard for metal makes no appreciable difference in the result. The radio-activity does not depend upon the nature of the gas in the inclosure, nor upon the pressure of the gas, although the concentration of the induced radio-activity on negatively electrified surfaces is less complete at low pressures than it is at high. Thus, for example, in an experiment made by Rutherford the induced radio-activity on a negatively electrified wire was practically unchanged when the pressure was reduced from 760 mm. to 16 mm.; at a pressure of 5 mm., however, it was about $1/20$ of its value at the higher pressure; this diminution in the radio-activity of the wire is accompanied by an increase in that of the walls of the inclosure.

Duration of the induced Radio-activity.

171. This induced radio-activity dies away gradually with the time; the rate of decrease is, however, very slow, as Rutherford's measurements show that it takes about 11 hours for the intensity of the radiation to fall to one-half its original value. The rate at which the radiation dies away does not depend upon the nature of the material which is made radio-active. The duration of the induced radio-activity is thus very much greater than that of the emanation which produced it, as we have seen that this fades away to one-half its original value in one minute. We must remember, however, that this relates to the emanation when it has escaped from solids and is in a form analogous to that of a free gas; we do not know whether the rate of decay is as great as this when the emanation is diffusing through a solid: the results of experiments seem rather to indicate that it is not, for the emanation is still active after passing through a great many sheets of paper; if its rate of decay when in the paper is as rapid as it is when in the air it must be able to diffuse through these in a very few minutes.

A surface once made radio-active can be exposed to very rough usage without losing this property; thus Rutherford raised a piece of radio-active platinum to a white heat and found after cooling that it had lost little if any of its activity. Washing the surface with hot or cold water, caustic soda, or nitric acid has no effect upon the activity; if, however, the wire is dipped in sulphuric or hydrochloric acid the radio-activity is removed in a few minutes: the radio-activity is however only removed from the metal to the acid, for on evaporating down to dryness the residue left was found to be strongly radio-active. It would thus appear that the radio-active substance is dissolved in the acid and retains its radio-activity.

No change in weight due to the induced radio-activity can be detected, nor does microscopic examination of the metal reveal the presence of any dust or any change in the surface. The radio-activity can be removed by long scouring with sand or emery paper; the pieces removed are radio-active.

Time taken to produce the Radio-activity.

172. The radio-activity takes considerable time to produce. On first exposure to the emanation it increases nearly proportionally with the time, afterwards the rate of increase falls off, and it ultimately attains a constant value. The following diagram (from Rutherford's paper), Fig. 81, shows how the intensity of the induced radiation increases with the time of exposure to the thorium.

The time taken to attain a steady state is fixed by the rate at which the induced radiation fades away. For let I be the intensity of the induced radio-activity at any time t , q the rate at which this is increasing in consequence of the presence of the thorium, I/T the rate at which it would decay if no thorium were present, then we have

$$\frac{dI}{dt} = q - \frac{I}{T},$$

or

$$I = qT \left(1 - e^{-\frac{t}{T}} \right) \dots\dots\dots(1),$$

thus the radio-activity will not reach a steady state until t is considerably greater than T . Now T has been determined by Rutherford by measuring the rate at which the activity of the

surface disappears when it is not exposed to the action of thorium; putting $q = 0$ we get

$$I = I_0 e^{-\frac{t}{T}},$$

where I_0 is the value of I when $t = 0$; Rutherford found that I fell to $\frac{1}{2}I_0$ in about 11 hours, so that $T = 16$ hours; thus it will take a time greater than 11 hours but comparable with it for the induced

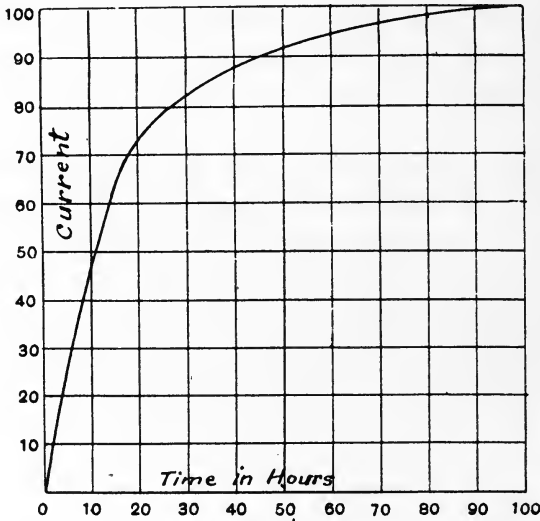

Fig. 81.

radio-activity to reach a steady state. We see from equation (1) that the induced radio-activity should reach half its final value in about 11 hours; an inspection of Fig. 81 will show that this is the case.

Penetrating power of the induced Radio-activity.

173. Rutherford measured the penetrating power of the induced radiation and found that it was considerably greater than that from thin layers of the thorium itself. Thus the latter is reduced to half its intensity after passing through about 1 cm. of air at atmospheric pressure, while the induced radio-activity can pass through 1.65 cm. before its intensity is reduced by the same amount. The penetrating power of the induced radio-activity is

independent of the nature of the substance made radio-active; this is a strong indication that the induced radio-activity is due to a deposit of the emanation and not to an alteration of the surface of the substance by radiation from the emanation.

The effect produced by negative electrification in increasing the induced radio-activity on a surface thus electrified is, I think, probably connected with the property possessed by several radio-active substances, for example uranium and radium (see p. 373), of emitting negatively electrified corpuscles. Miss Slater* has recently shown that the radio-active emanations from thorium and radium possess this property. The particles which emit a corpuscle and which thereby acquire a charge of positive electricity will be attracted by the negatively electrified surface and will move rapidly up to it. The velocity with which the particle moves in the electric field is very great compared with the velocity with which it would have moved towards the surface if only diffusion had come into play. Thus the emanation will in consequence of the charge on the surface arrive at the surface very much sooner than it would have done if there had been no charge; it thus arrives very much fresher and is much more efficient as a producer of induced radio-activity.

174. The velocity acquired by the positively charged particles of the emanation when in the electric field has been measured by Rutherford†, using the following method, which is based on the assumption—justified by the extent to which the induced radio-activity can be concentrated on a negatively electrified surface—that the radio-activity of the surface is almost wholly due to the number of positively electrified particles which reach it.

The emanation spreads between two parallel plates *A* and *B*, Fig. 82; an electric field is produced between the plates; this field consists of two parts, (1) a constant potential difference equal to E_0 , making the top plate +, the lower plate -, (2) a field in which the direction of the force is reversed at equal intervals of time T ; thus it is equal to E_1 for a time T , then changes to $-E_1$ which lasts

* Miss Slater, *Phil. Mag.* [6], 10, p. 460, 1905.

† Rutherford, *Physikalische Zeitschrift*, iii. p. 210, 1902; *Phil. Mag.* vi. 5, p. 95, 1903.

for a time T , when it changes again to $+E_1$, and so on. This variable potential difference is placed in series with the constant potential difference, so that in the first half of the alternation the electric force acting downwards is $(E_0 + E_1)/d$, where d is the distance between the plates, while in the second half of the alternation it is equal to $(E_1 - E_0)/d$ and acts upwards: E_1 is supposed

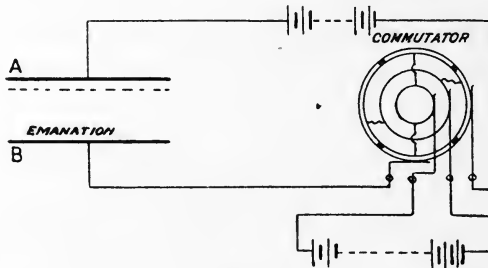

Fig. 82.

to be greater than E_0 . There is thus on the average a tendency to make the positive ions go to the lower plate, but during the second half of the alternation some of the particles will be attracted to the upper plate and will make it radio-active: the number of such particles will depend upon the velocity of the particles and may be calculated as follows.

Let K be the velocity of the particles under unit electric force and let us suppose that the positive particles are being produced uniformly between the plates, the number produced in one second in a layer of unit thickness between the plates being q . The particles which reach the upper plate when negatively electrified will be of two classes: (1) those produced whilst the plate is negatively electrified, and (2) those which were present between the plates at the beginning of the alternation. Let us take first the number in the first class; consider the number sent to the top plate by a layer of thickness dx at a distance x away from it; any particle from this layer, since it moves with the velocity KX_1 , will take the time x/KX_1 to reach the plate. X_1 is the electric force between the plates and is equal to $(E_1 - E_0)/d$. Since the particle must reach the plate before the end of the alternation the latest time it can start is x/KX_1 before the end, and thus the particles reaching the layer are only formed for a time $T - x/KX_1$; the

number of particles reaching the plate from this layer is $q(T - x/KX_1) dx$ and the total number of particles in class (1) is equal to

$$\int_0^{KX_1T} q(T - x/KX_1) dx = \frac{1}{2}qKX_1T^2.$$

The number in class (2) will be the number of positive particles at the beginning of the alternation in a layer next the upper plate whose thickness is KX_1T . The force in the preceding alternation tending to drive the particles from the upper plate is X_2 , where $X_2 = (E_0 + E_1)/d$; hence the velocity of the particles is KX_2 : the number of particles produced in a layer of thickness dx , at a distance x from the upper plate, which have not moved by the end of the alternation to a distance from the upper plate greater than KX_1T is $q \frac{(KX_1T - x)}{KX_2} dx$; hence the number of particles in the second class is equal to

$$\int_0^{KX_1T} q \frac{(KX_1T - x)}{KX_2} dx = \frac{1}{2}q \frac{K \cdot X_1^2 T^2}{X_2}.$$

Thus the total number of positive particles reaching the upper plate in the time of a double alternation of length $2T$

$$= \frac{1}{2}qKX_1T^2 \left(1 + \frac{X_1}{X_2}\right).$$

In this time the total number of positive particles produced is $2qdT$, and if care is taken to make the electric field sufficiently strong all these particles will reach one or other of the plates. Hence ρ , the ratio of the number of particles reaching the upper plate to the sum of the numbers reaching the upper and lower plates, is given by the equation

$$\rho = \frac{1}{4} \frac{KX_1T^2}{d} \left(1 + \frac{X_1}{X_2}\right),$$

or substituting for X_1 and X_2 their values we get

$$\rho = \frac{1}{2}KT^2 \frac{(E_1 - E_0)}{d^2} \frac{E_1}{E_1 + E_0} \dots\dots\dots(1)$$

On the hypothesis already mentioned, that the induced radio-activity is almost entirely caused by the positively charged particles which come up to the plate, ρ is the ratio of the radio-activity of the upper plate to the sum of the activities of the upper and lower plates, and by measuring these activities ρ can be determined; when ρ is known equation (1) gives us the means of determining K and hence the velocity of the positively charged particles in an electric field. By this method Rutherford got the following results.

Plates 1.3 cm. apart.

$E_1 + E$ volts	$E_1 - E$ volts	Alternations per sec.	ρ	Velocity for one volt per cm.
152	101	57	.27	1.25
225	150	57	.38	1.17
Plates 2 cm. apart.				
272	207	44	.37	1.47
300	200	53	.286	1.45

These results relate to air at atmospheric pressure. Zeleny (p. 47) found that the velocity of the positive ions produced by Röntgen rays in air at this pressure was 1.36 cm./sec. for the potential gradient of a volt per cm.: the velocity of the positive particles in the thorium emanation is thus within the limits of experimental error equal to the velocity of the ordinary positive ions.

Rutherford has shown that at low pressures, say less than 1 mm., of mercury there is less tendency for the radio-activity to be concentrated on the negative electrode than there is when the pressure is higher. Makower* has shown that this is also the case with the radio-activity produced by the emanation from radium and that the effects of pressure are more marked in small vessels than in large ones. This is what we should expect, for the expulsion of the corpuscles and α particles from the emanation would set the residue of the molecule in rapid motion. If the pressure in the vessel were high this velocity would soon be destroyed by collisions,

* Makower, *Phil. Mag.* [6], 10, p. 526, 1905.

and the particles would then be attracted to the cathode. If however the pressure were low their initial velocity might carry them both sides of the vessel against the attraction due to the electric field.

Radio-activity of Radium, Polonium, Actinium.

The Becquerel rays have led to the discovery of some new substances possessing the power of radio-activity to a far greater extent than uranium—the original source of these rays. After Becquerel's discovery Monsieur and Madame Curie* made a very systematic and extensive examination of a great number of chemical elements and compounds, and also of minerals, to see if other elements possessed powers similar to uranium; the examination of the elements and compounds (which included the rare elements, gallium, germanium, neodymium, praseodymium, mobium, scandium, gadolinium, erbium, samarium, rubidium, yttrium, ytterbium, holmium) did not lead to the discovery of any substances other than uranium possessing this property. The investigation of the minerals was more fruitful, for they found that several minerals containing uranium were more active than the same bulk of uranium. This is shown by the following table in which ι is the saturation current in ampères between two circular plates 8 cm. in diameter and 3 cm. apart when one of the plates is covered with the substance under consideration :

	$\iota \times 10^{11}$ ampères		$\iota \times 10^{11}$ ampères
Metallic Uranium.....	2.3	Thorite.....	1.4
Pitch-blende from		Orangeite.....	2.0
Johanngeorgenstadt	8.3	Monazite.....	0.5
Joachimstal.....	7.0	Xenotime.....	0.03
Pribran.....	6.5	Æschynite.....	0.7
Cornwall.....	1.6	Fergusonite.....	0.4
Cleocite.....	1.4	Samarskite.....	1.1
Chalcolite.....	5.2	Niobite.....	0.3
Autunite.....	2.7	Carnotite.....	6.2

All these minerals contain uranium and thorium, but it will be seen that several of them are more radio-active than the pure metals: this suggests that they may contain some exceedingly

* Curie, *Rapports, Congrès International de Physique*, t. iii. p. 79, Paris, 1900.

active substances other than uranium; this supposition was strengthened when Monsieur and Madame Curie prepared Chalcocite artificially from pure substances and found that it was only about one-fifth as radio-active as the natural mineral. They then set to work to search pitch-blende systematically; they tested the radio-activity of a certain piece, then separated this chemically and tested that of the constituents, and thus gradually separated the active from the inert parts of the pitch-blende. This treatment has led to the discovery of three different strongly radio-active constituents of pitch-blende: radium discovered by Monsieur and Madame Curie and Monsieur Bemont*, polonium discovered by Monsieur and Madame Curie†, and actinium by Monsieur Debierne‡. Radium accompanies the barium prepared from pitch-blende, and in its chemical actions is similar to that metal; it can, however, be separated from barium by fractionation, as its chloride is less soluble in water, in alcohol and in hydrochloric acid. The amount of radium in pitch-blende is exceedingly small, many thousand kilograms of this mineral only yielding a few decigrams of a radio-active substance, of which only a small fraction is radium. The spectrum of radium was examined by Demarçay§; the following are the principal lines between wave-lengths 5000 and 3500.

Wave-length	Intensity	Wave-length	Intensity
4826·3	10	4600·3 ?	3
4726·9	5	4533·5	9
4699·8	3	4436·1	8
4692·1	7	4340·6	12
4683·0	14	3814·7	16
4641·9	4	3649·6	12

There are also two nebulous bands in the spectrum, one extending from 4631·0 to 4621·9 with the maximum at 4627·5; the second begins suddenly at 4463·7, has a maximum from 4455·2 to 4453·4, fading away at 4390. The appearance of the spectrum is shown in Fig. 83.

* Curie and Bemont, *Comptes Rendus*, cxxvii. p. 1515, 1898.

† Curie, *op. cit.* p. 175.

‡ Debierne, *Comptes Rendus*, cxxix. p. 593, 1899; cxxx. p. 906, 1900.

§ Demarçay, *ib.* cxxvii. p. 1218, 1898; cxxix. p. 116, 1899; cxxxi. p. 258, 1900.

The sensitiveness of the test by radio-activity is shown by the fact that it required several thousand times more radium to give an appreciable spectrum than to give an amount of radio-activity quite appreciable by electrical methods.

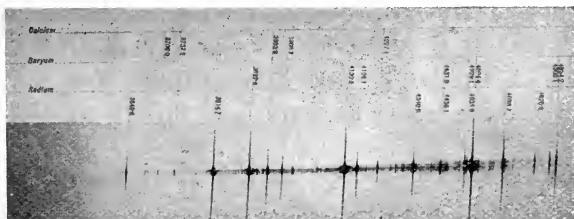

Fig. 83.

The atomic weight of radium has been determined by Monsieur and Madame Curie* to be 225. Runge and Precht† from considerations based on its spectrum estimate the atomic weight as 257·8, their method is however very indirect and there seems little doubt that the smaller value is the more accurate.

The radiation from radium is extraordinarily intense. Monsieur and Madame Curie have prepared specimens of radium which when enclosed in a lead tube 5 cm. thick will discharge an electroscope more readily than uranium, even although the latter is brought without any covering close up to the electroscope.

The radiation comprises rays of four classes: (1) α rays, these are easily absorbed rays carrying a charge of positive electricity slightly deflected by electric or magnetic fields; (2) β rays, these are much more penetrating rays which are deflected by magnetic or electric fields and which carry a charge of negative electricity; (3) γ rays, rays still more penetrating which are not deflected; (4) slowly moving corpuscles.

*Emanation from Radium and induced Radio-activity
produced by it.*

175. M. and Mme Curie‡ have shown that the walls of a vessel containing radium become radio-active. Radium, like

* Curie, *Comptes Rendus*, July 21, 1902.

† Runge and Precht, *Physik. Zeit.* iv. p. 285, 1903.

‡ Curie, *Rapports présentés au Congrès International de Physique*, iii. p. 108, 1900.

thorium, gives out an emanation which is also radio-active. The persistence of the radio-activity of the radium emanation is however very much greater than that from thorium; the latter, as we have seen, falls to half its value in about one minute, the corresponding time for the radium emanation is about four days. The radium emanation, like that of thorium, makes the walls of a vessel in which it is contained radio-active; the induced radio-activity due to radium dies away more rapidly than that due to thorium, it also is concentrated on negatively electrified bodies.

Molecular Weight of the Radium Emanation.

The molecular weight of radium emanation has been estimated by Rutherford and Miss Brooks* from determinations of its rate of diffusion through air as between 40 and 100; by measuring its rate of diffusion through a porous pot, Makower† found values ranging from 86 to 99, while Bumstead and Wheeler‡ give 180 as the result of their comparison of the rates of escape of the emanation and CO₂ from a porous vessel. These results indicate that the emanation is a heavy gas having a molecular weight much smaller than that of radium itself. Makower has shown that the emanation of thorium has about the same molecular weight as that of radium.

Polonium.

176. Polonium, discovered by M. and Mme Curie§, is found in company with the bismuth extracted from pitch-blende: they obtained bismuth richer and richer in polonium by the following methods of fractionation:

1. Sublimation of the sulphide *in vacuo*. The sulphide of polonium is much more volatile than that of bismuth.

2. Precipitation of solutions in nitric acid by water. The precipitated nitrate is much more active than that remaining behind in the solution.

3. Precipitation by hydrogen sulphide from a solution in hydrochloric acid. The precipitated sulphide is much more active than the salt which remains behind.

* Rutherford and Miss Brooks, *Trans. Roy. Soc. Canada*, vii. p. 21, 1901.

† Makower, *Phil. Mag.* [6], 9, p. 56, 1905.

‡ Bumstead and Wheeler, *Amer. Jour. Soc.*, Feb. 1904.

§ Curie, *Comptes Rendus*, cxxvii. p. 175, 1898.

Polonium has not been obtained in a pure enough state to give a spectrum. As far as is known the radiation from it is entirely of the easily absorbed types (1) and (4). The radiating power of polonium is not permanent, it continually gets weaker and weaker. It is probably one of the products of the disintegration of radium.

Actinium and Emanium.

Actinium, which was discovered by Debierne*, is a very radio-active substance which accompanies the thorium extracted from pitch-blende. It exhibits the same radio-active properties as emanium, a radio-active substance accompanying the cerium earths in pitch-blende discovered by Giesel†. They both produce an emanation which decays in a few seconds.

Atomic Disintegration.

177. The phenomena of radio-activity are coordinated in a very striking way by the hypothesis of atomic disintegration which we owe to Rutherford and Soddy. We shall only give a brief account of this theory as it is discussed at length by Rutherford in his treatise on radio-activity. According to this theory the atoms of the radio-active elements disintegrate from time to time forming atoms of other elements, and it is during the disintegration of the atom that the rays characteristic of these radio-active substances are emitted. Thus the radio-active substance is not permanent, it is continually passing into another state, and it does this at rates which vary greatly from one substance to another. In some cases, as in that of thorium emanation, the rate of decay is so rapid that the substance practically disappears in a few minutes; in others, as in thorium itself, the rate of decay is so slow that no appreciable diminution in the amount of the substance occurs in a thousand years. Thus to take the case of thorium, some of the atoms of thorium are supposed to disintegrate into α particles and an atom of a new substance, thorium X ; if N is the number of thorium atoms present at the time t , the number which disintegrate in unit time will be λN where λ is a constant, and we have

$$\frac{dN}{dt} = -\lambda N,$$

$$N = N_0 e^{-\lambda t},$$

* Debierne, *Comptes Rendus*, cxxix. p. 593, 1899; cxxx. p. 906, 1900.

† Giesel, *Ber. d. D. Chem. Ges.* p. 3608, 1902; p. 342, 1903.

where N_0 is the number of thorium atoms when $t = 0$: we see from this that the number of thorium atoms will be reduced to one-half in a time $\frac{\log 2}{\lambda}$. Rutherford estimates this time at 2.4×10^9 years.

The atoms of thorium X disintegrate into α particles and atoms of the thorium emanation; the rate of transformation is much more rapid than for thorium itself, being at a rate that would reduce the number of thorium X atoms to one-half in 4 days. The atoms of the thorium emanation disintegrate into α particles and atoms of the substance which produces the deposited radio-activity caused by the thorium emanation; the rate of transformation being so rapid in this case that the number of atoms of the thorium emanation would be reduced to one-half in about 1 minute. The following table, taken from Rutherford's *Radio-activity*, shows the various transformations which the radio-active elements are supposed to undergo. The arrows in the diagram indicate the stages at which the various rays are emitted.

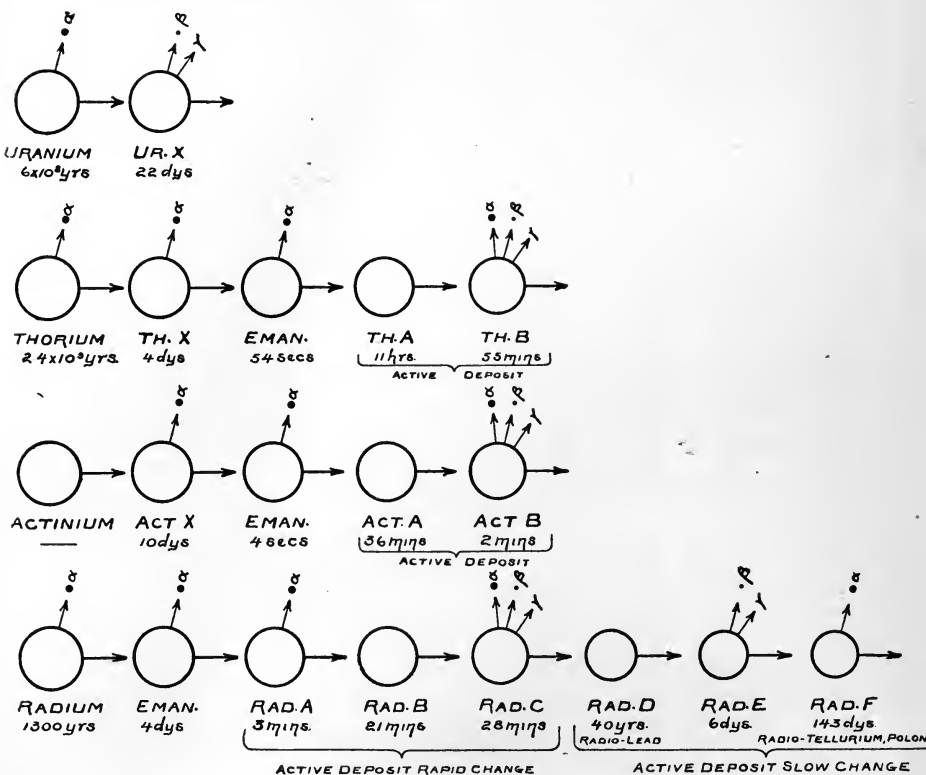

Fig. 84.

Properties of the Rays.

178. We shall now consider in detail the effects produced by the various types of rays emitted by the radio-active substances. So far four types have been discovered, the α , β , γ rays and a fourth type consisting of very slowly moving corpuscles; these only differ from the β rays in the speed at which they are moving.

The α rays.

These are easily absorbed rays emitted by most radio-active substances and which are absorbed by a few centimetres of air. At first it was supposed that these rays did not carry a charge of electricity as their deflection in a magnetic field is so small that for some time it escaped detection. Rutherford* however showed in 1903 that they were positively charged particles. Strutt† had previously suggested that they were positively charged particles whose mass was very much larger than that of a corpuscle. The method by which Rutherford showed that these rays are deflected by magnetic and electric forces was as follows. A thin layer of radium bromide was placed at the bottom of the vessel *G* (Fig. 85),

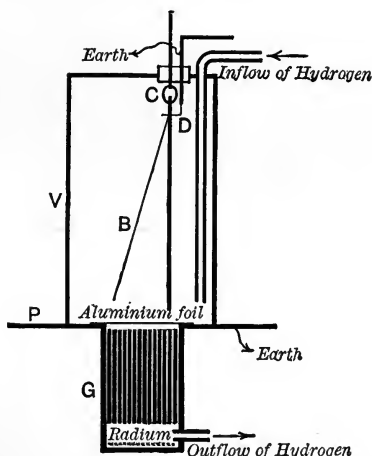

Fig. 85.

a series of vertical plates very close together were placed over this layer and the radiation had to pass between these plates on its way to the ionisation chamber *V*. A very slight deflection of the

* Rutherford, *Phil. Mag.* [6] 5, p. 177, 1903.

† Strutt, *Phil. Trans.* A, 1901, vol. cxevi. p. 525.

rays was sufficient to make them strike against the sides of the plates and prevent them from reaching V . Rutherford found that a strong magnetic field where the lines of force were horizontal and parallel to the vertical plates diminished the amount of ionisation in V , and from the amount of this diminution the deflection of the rays could be calculated. From the magnetic deflection the value of mv/e could be calculated by the method of § 59, m , v , e representing respectively the mass, velocity, and charge on the particle. In this way Rutherford found

$$\frac{mv}{e} = 4.1 \times 10^5 \dots\dots\dots(1).$$

The direction of the deflection showed that the particle carried a positive charge.

To get the deflection due to an electric field the plates were insulated and alternate ones connected together so as to form two sets of plates insulated from each other, one set was connected with one terminal of a Wimshurst machine, the other set with the other terminal, and thus a strong transverse electric force acted on the α particles as they passed up between the plates; this diminished the ionisation in V , and from this diminution the deflection by the electric field can be determined; from this the value of mv^2/e can be deduced by the method of § 59. In this way Rutherford found

$$\frac{mv^2}{e} = 1.025 \times 10^{15} \dots\dots\dots(2).$$

From (1) and (2) we get

$$\frac{e}{m} = 6 \times 10^3,$$

$$v = 2.5 \times 10^9 \text{ cm./sec.}$$

We see from this that the value of e/m for these rays is of the same order as 10^4 , the value of e/m for the hydrogen ion in the electrolysis of solutions. Thus the mass of an α particle is some thousands of times greater than that of a corpuscle; in consequence of this great mass, the energy possessed by an α particle, although its velocity is less than that of some of the more rapidly moving corpuscles, is much greater than the energy of these corpuscles. In fact most of the energy of the radiation emitted from radio-active substances is in the α rays. The α rays affect a

photographic plate, and Becquerel* obtained a photograph of the path of the rays from radium bromide in a magnetic field; he found that the direction of the deflection showed that the charge of electricity on the rays was positive; also that the curvature of the path near the radium bromide was greater than that far away. The values he obtained for mv/e ranged from 2.9×10^5 to 3.41×10^5 , agreeing well with Rutherford's result.

Descoudres† using the photographic method measured the deflections of the α particle in both electric and magnetic fields; in this way he found

$$\frac{mv}{e} = 2.5 \times 10^5, \quad \frac{mv^2}{e} = 4.1 \times 10^{14},$$

giving
$$\frac{e}{m} = 6.4 \times 10^3 \quad \text{and} \quad v = 1.65 \times 10^9.$$

Mackenzie‡ made at the Cavendish Laboratory numerous measurements of the deflections of the α rays under magnetic and electric forces. He used a modification of the photographic method, placing in front of the plate a screen of zinc sulphide; this phosphoresced when it was struck by the rays and the phosphorescence affected the plate. The source of the α rays was radium bromide; his photographs showed that the α radiation was not all of the same kind, for under the magnetic field the image of the slit through which the rays passed was considerably broadened, showing that the rays had not all experienced the same deflection. The broadening under the electric force was not so marked as that under the magnetic. This is probably due to the exposure not being so prolonged in the electric as in the magnetic field, for if we assume that e/m is the same for all the particles and that the rays differ only in their velocity, the dispersion should be greater in the electric than in the magnetic field as the deviation under electric forces varies as the square, while that under magnetic force only as the first power, of the velocity. If, however, there are comparatively few rays with velocities greatly different from the mean, it will require a very long exposure to get a picture of the edges of the beam of α rays.

Mackenzie made experiments in which the length of path

* Becquerel, *C. R.* 136, p. 1517, 1903.

† Descoudres, *Phys. Zeit.* 4, p. 483, 1903.

‡ Mackenzie, *Phil. Mag.* [6] 10, p. 538, 1905.

traversed by the rays in the magnetic field was varied. From these he showed that an α particle retained its charge during the whole of its course from the radium bromide to the photographic plate.

Mackenzie found as the results of the experiments in the magnetic field, values of $\frac{mv}{e}$ ranging from 2.65×10^5 to 3.92×10^5 .

The experiments in the electric field gave 4.11×10^{14} as the value of mv^2/e , these results give values of v ranging from 1.11×10^9 to 1.64×10^9 ; these are the velocities with which the α particles emerge from a thin layer of mica covering the radium bromide. Mackenzie calculated that the velocities of the particles were reduced by about 6 per cent. in passing through the mica, so that the velocities on leaving the radium would be from 1.18×10^9 to 1.74×10^9 . The values of e/m range from 3×10^3 to 6.05×10^3 , the mean being about 5×10^3 . If the α particle carried the same charge as a corpuscle, the value of e/m would, if it were a hydrogen atom, be 10^4 , if it were an atom of helium it would be 2.5×10^3 , if it were a molecule of hydrogen 5×10^3 . It is probable, from other considerations, that some if not all of the α particles will be atoms of helium, for a considerable number of α particles are emitted by radio-active substances and therefore we should expect to find along with these substances the element of which the α particles are atoms; we do find the element helium present along with radio-active substances and this is strong *prima facie* evidence that some of these particles are helium. The determinations of e/m are not in accordance with this view, if we assume that the charge on the atom is the same as that on a corpuscle; we know nothing however about the magnitude of this charge and if the charge on the α particle were twice that on a corpuscle, the values of e/m for these particles would be in good accordance with those for a helium atom. As to the question whether or not all the α particles are helium, we must remember that it is easier to establish a definite relation between the rate of production of the gas and the amount of radio-activity for a gas like helium which does not enter into any chemical combination and which only occurs sparingly, than for a gas like hydrogen, of common occurrence and of which, even if it were produced by radio-active substances, the amount arising in this way would be small compared with the total amount present.

179. When a thick layer of radium is used the α rays which emerge have come from different depths below the surface and so must emerge with different velocities, having travelled different distances in the retarding medium. Bragg and Kleeman however by their researches on the absorption of the α rays (see § 182) have shown that there is a more fundamental reason than this for the variation in velocity, and that the different disintegration products of radium emit α rays of different qualities.

There is good reason for supposing that polonium is one of the disintegration products of radium. Mackenzie found for the α rays from a specimen of radio-active tellurium (polonium) obtained from Sthamer the value 3.3×10^8 for mv/e , which is intermediate between the greatest and least values he found for the rays from radium bromide. Hough has recently determined at the Cavendish Laboratory the value of e/m for the α rays from this substance: he finds that it is equal to 4.8×10^8 , and is thus approximately the same as for the α particles from radium bromide.

180. The α rays lose their power of affecting a photographic plate suddenly after passing through a certain thickness of air or a smaller thickness of a denser substance. Rutherford* measured the value of mv/e for the α rays given out by a thin layer of radium *C* after the rays had traversed successive layers of aluminium, he increased the number of layers until the rays ceased to affect a photographic plate; the results are given in the following table, the thickness of each layer of aluminium foil was .00031 cm.

Number of layers	Value of mv/e
0	1
5	.85
8	.76
10	.73
12	.64
13	no photographic effect

From these results we see that just before the rays lost their power of affecting a photographic plate they still possessed about 40 per cent. of the very large amount of energy they had when they emerged from the radio-active substance. The loss of

* Rutherford, *Phil. Mag.* [6] 10, p. 163, 1905.

velocity in passing through the different layers is very nearly proportional to the number of layers passed through; the experiments however are hardly decisive between this supposition and the alternative one that the loss of energy is proportional to the number of layers passed through.

The most probable reason for the loss of photographic power (and this loss is accompanied by the loss of ionising power) seems to me to be that when the energy of the α particle falls below a certain value, a negatively electrified corpuscle gets attached to the particle so that its positive charge is neutralised and it becomes an uncharged atom with quite different properties from the original α particle. In order that an α particle should separate from a corpuscle after colliding with it, it is necessary that the relative velocity of the particle and the corpuscle before impact must exceed a definite value; for let v be the relative velocity of a corpuscle and particle, when they are separated by a distance a , M the mass of the particle, m that of a corpuscle, E and e the charges on the particle and corpuscle in electrostatic measure, then we can easily show by the theory of Central Forces that if M is large compared with m the condition that the particle should get away from the corpuscle is that $\frac{1}{2}mv^2$ should be greater than Ee/a ; if this condition is not fulfilled the corpuscle will become a satellite of the particle and make it electrically neutral. If we put a equal to the radius of the particle then, as long as $\frac{1}{2}mv^2$ is $> Ee/a$, the particle can not be neutralised, for it will be able to escape from the corpuscle after any collision; if we put

$$e/m = 5.1 \times 10^{17}, \quad E = e = 3.5 \times 10^{-10}, \quad a = 10^{-8},$$

the limiting value of $v = 1.9 \times 10^8$; if the velocity fell below this value then it is possible that a collision might, if the bodies came close together, result in the α particle having its charge neutralised. The value found by Rutherford for the velocity of the α particle when it ceases to ionise is considerably greater than the limiting value just found, we need not attach much importance to this as the value of a we used was the conventional one 10^{-8} cm. and not one deduced from any property of the α particle. If the particle had a greater charge than the corpuscle, say twice the charge, the limiting velocity would be higher, but in this case we should expect the loss of ionising power to occur by two steps, one when the positive charge was diminished to one-half when it took up the first corpuscle and the other when the charge was finally neutralised by a second.

181. *Absorption of the α rays.* Some early experiments made by Mme Curie* on the α rays from polonium showed that the absorption of these rays presents some very interesting features.

The arrangement used to show this is represented in Fig. 86: PP , $P'P'$ are two metallic plates between which the current produced by a considerable potential difference is measured in the usual way: the polonium is placed at A and the rays from it go through wire-gauze at T . When the distance AT exceeded

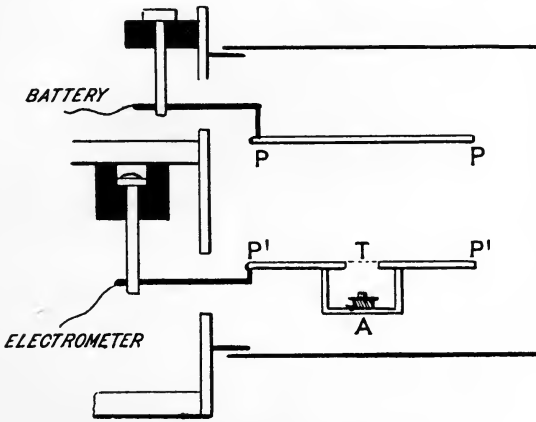

Fig. 86.

4 cm. no current could be detected between the plates, as this distance diminished the appearance of a current was very abrupt, a small diminution in this distance making the current increase from an exceedingly small value to an appreciable fraction of its value when the polonium was quite close to T . When the polonium is covered with a thin sheet of aluminium foil the absorption produced by the foil is much greater when the distance AT is considerable than when it is small. The effects observed with polonium (and they also occur as Mme Curie has shown with the α rays of radium) are those which would be produced if the polonium rays were homogeneous but became less penetrating after passing through an absorbing medium.

182. Recent experiments made by Bragg and Kleeman† have thrown a great deal of light on the laws of absorption of these rays.

* Curie, *Comptes Rendus*, cxxvii. p. 175, 1898.

† Bragg and Kleeman, *Phil. Mag.* [6] 10, p. 318, 1905.

The method they used was to measure the ionisation produced in a thin chamber AB by a narrow pencil of α rays coming from a small quantity of radium R and to find how it varied as the distance between the radium and AB was gradually increased. Since the

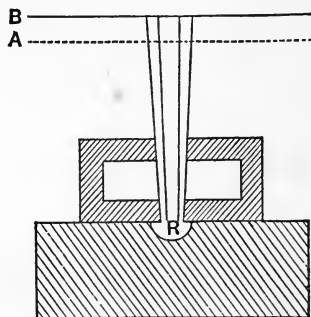

Fig. 87.

chamber was large enough always to catch the whole pencil of rays no correction is needed for the spreading out of the rays as their distance from the radium increases. To get the results in the simplest form it is desirable to have only one radio-active substance present. Radium bromide ordinarily contains not merely radium, but also its disintegration products; it can however be temporarily freed from these by prolonged heating. In this case the curve representing the relation between the amount of ionisation in the chamber and the distance from the radium is of the kind represented by (I) in Fig. 88, the ordinates representing the distance from the radium and the abscissæ the amount of ionisation. We see that at first the ionisation actually increases as the distance increases, when however a certain distance from the radium is reached the ionisation very rapidly falls off to a small fraction of its former value. Thus we may regard the α rays as being able to penetrate a certain distance in air without loss of ionising power, while after passing this distance they suddenly lose this power almost entirely; they lose at the same time their power of producing phosphorescence and of affecting a photographic plate; this, as I have already stated, is in my opinion due to the α particle losing its charge from its inability to keep away from negative corpuscles with which it collides.

Though the ionising power of the rays does not at first diminish with increase of distance travelled by the rays, their velocity as Rutherford's experiments show steadily diminishes and the

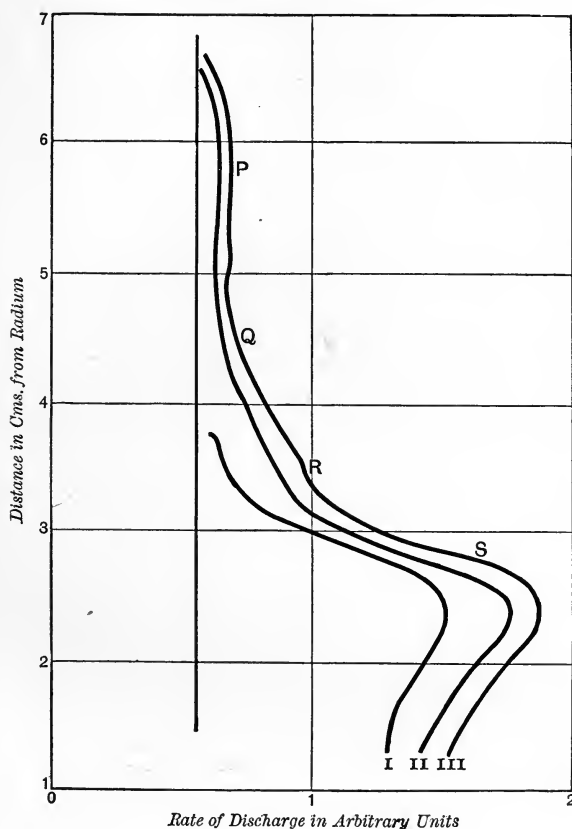

Fig. 88.

increase of ionisation with the distance is probably an illustration of the principle of which we shall find many examples that the ionising power of rapidly moving charged particles increases as the velocity of the particles diminishes. In interpreting these results however we must not forget that secondary radiation is produced by the impact of the rays with the matter through which they pass. The effect of the secondary rays due to the passage through the gas will increase with the distance while that due to the impact against the further plate in the ionising chamber will diminish.

When instead of using a single radio-active substance we use radium bromide in radio-active equilibrium which contains a mixture of these substances the curves are more complex. Fig. 89 taken from a paper by Bragg and Kleeman* shows some specimens

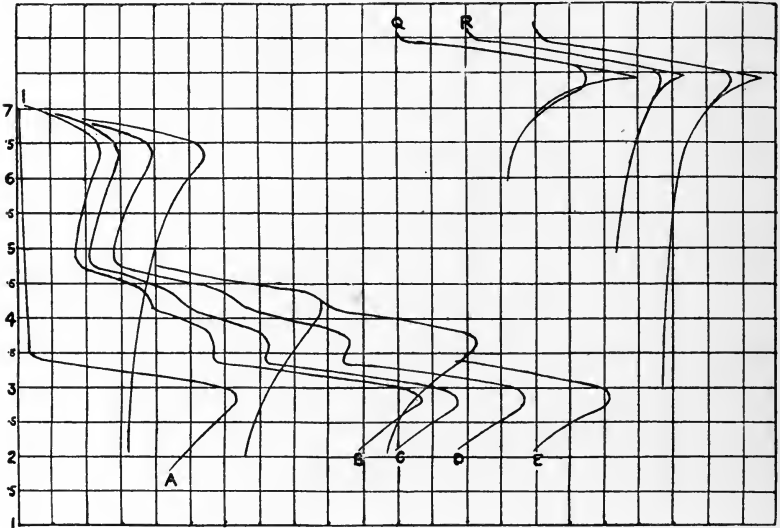

Fig. 89.

of these curves. It will be seen that they contain several points at which the ionisation suffers an abrupt diminution, indicating that the α rays from the different radio-active substances have different penetrating power. From these curves Bragg and Kleeman (*loc. cit.*) have calculated that the α rays emitted by radium and some of its disintegration products can penetrate the following distances in air at atmospheric pressure before losing their ionising power.

Radium	3.50 cm.
Emanation or Radium A	4.23 "
Radium A or Emanation	4.83 "
Radium C	7.06 "

One set of α particles have a range of 4.23 cm., another a range of 4.83; one of these comes from the emanation the other from

* Bragg and Kleeman, *Phil. Mag.* [6] 10, p. 318, 1905.

radium *A*; it has not however yet been settled, whether the α particles from radium *A* are those with the longer or shorter range.

If a thin piece of metal is placed over the radium the ranges of all the α particles are diminished by the same amount. This is shown by the curves obtained by Bragg and Kleeman which are represented in Fig. 90.

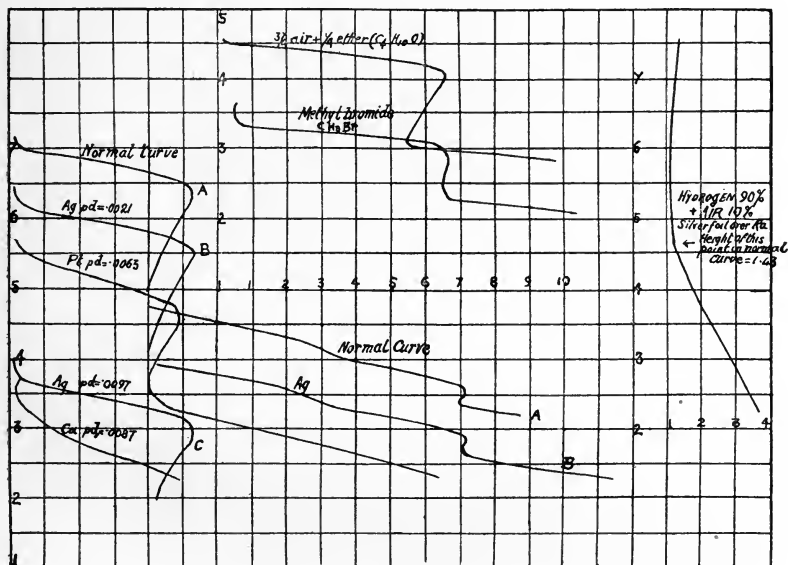

Fig. 90.

Absorption of α rays by different substances.

183. By comparing the drop in the range in air produced by films of different materials we can compare the absorption of the α rays produced by these materials. Thus we see from the figure that a film of silver for which the product of the density and thickness is $\cdot 00967$ diminishes the range of the α particles in air by $3\cdot 35$ cm., i.e. a silver stratum for which $\rho d = \cdot 00967$ produces the same absorption as an air stratum for which $\rho d = 3\cdot 35 \times \cdot 0012 = \cdot 00402$. In this way Bragg and Kleeman found the very interesting result that the masses of unit area of strata of equal absorption are proportional to the square root of the atomic weights of the absorbing substances. Thus for example the masses of layers of

oxygen and hydrogen producing equal amounts of absorption are as 4 to 1, or if the pressures are the same the thickness of the hydrogen stratum is four times that of the oxygen one, in other words the ranges of the α particles in hydrogen and in oxygen are in the proportion of 4 to 1.

If m is the mass of the atom, N the number of atoms in the volume of the stratum cut off by a cylinder whose cross section is of unit area, then the mass per unit area of the stratum is Nm and for equal absorptions we must have $\frac{Nm}{\sqrt{m}}$ constant, *i.e.* $N\sqrt{m}$ must be constant, or the absorption by equal numbers of atoms must be proportional to the square root of the atomic weight.

This law of absorption is quite different from that of rapidly moving negative corpuscles, in the latter case equal absorptions are approximately produced by equal masses; thus a stratum of hydrogen to produce the same absorption of the negative corpuscles as a stratum of oxygen would have to be sixteen times thicker, while to produce equal absorption of the α rays only four times the thickness would be required. Thus increase in the atomic weight does not produce the same increase in absorption for the α rays as it does for fast cathode rays, while in the case of soft Röntgen rays increase in atomic weight produces even greater increase in absorption than it does for cathode rays.

The α rays emitted by different substances have different ranges, the order in increasing range is

Thorium	}	excited radiation
Radium		
Thorium		
Radium		
Polonium		
Uranium.		

184. If instead of using a narrow cone of rays from a speck of radio-active substance we use all the rays given out by such a substance spread over a considerable area, we shall find that the ionisation at different distances from the radio-active substance continually diminishes as the distance increases, and does not (like that due to a thin pencil of rays) remain independent of the distance when this is small. An inspection of Fig. 91 will show

at once why this is the case, the α rays are emitted in all directions and an oblique ray like PQ may have to travel more than the

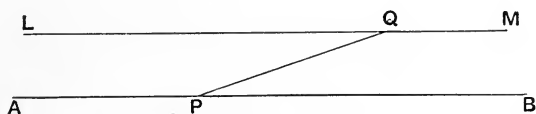

Fig. 91.

critical distance before it crosses the plane LM even though the distance of this plane from the radio-active substance is much less than the critical distance; the proportion of oblique rays which fail to reach the upper plane increases with the distance of this plane from the substance, and thus the ionisation will diminish as this distance increases, however small the distance may be.

The earlier experiments on the absorption of the α rays were made with such a disposition of the radio-active substance and the diminution in the ionisation as the distance increased led to the belief that the intensity of the α rays at a distance d from their source was proportional to $\epsilon^{-\lambda d}$; the experiments of Bragg and Kleeman have shown that this is not the case.

185. *Ionisation produced by α rays when they pass through different gases.* Strutt* has made a very extensive series of experiments on the ionisation produced by α rays when they pass through different gases, the pressure of the gas in the ionisation vessel being so low that the α rays passed through the vessel without losing their power of ionisation; this was tested by measuring the ionisation at different pressures and reducing the pressure until the ionisation was exactly proportional to the pressure. The results are given in the following table and it will be seen that they suggest that except for hydrogen and methyl iodide the ionisation is proportional to the density of the gas. Other considerations show however that this cannot be the law connecting the ionisation with the molecular weight of the gas. For by this law the amount of ionisation produced by an α ray per unit length of its path through a gas would be proportional to the density of the gas. Bragg and Kleeman have shown however that in a gas at constant pressure the length of path during which the α particle

* Hon. R. J. Strutt, *Phil. Trans. A.* 196, p. 507, 1901.

acts as an ioniser is approximately inversely proportional to the sum of the square roots of the atomic weights of the atoms in a

TABLE I.

Gas	Relative density	Relative ionisation	Ionisation calculated on square root law
Hydrogen	0·0693	0·226	0·26
Air	1·00	1·00	1·00
Oxygen	1·11	1·16	1·08
Carbon dioxide	1·53	1·54	1·59
Cyanogen	1·86	1·94	1·88
Sulphur dioxide.....	2·19	2·04	1·80
Chloroform.....	4·32	4·44	3·15
Methyl iodide.....	5·05	3·51	2·40
Carbon tetrachloride...	5·31	5·34	3·6

molecule of the gas, or in the case of an elementary gas to the square root of its density at a constant pressure. Combining this with Strutt's result that the ionisation per unit length of path is proportional to the density we see that the total number of ions produced by the α particle would be proportional to the square root of the atomic weight of an elementary gas. Thus if both these laws were true the α particles ought to produce more ions in gases of large atomic weight than in those of low provided the particles are entirely absorbed by the gas. The variation in the number of ions would be large, thus in marsh gas CH_4 the number would only be about half that in hydrogen while in iodine vapour the number would be eleven times that in hydrogen.

Rutherford gives the following results for the relative numbers of ions produced when the α rays from uranium are entirely absorbed by different gases.

Gas	Number of ions	
Air	100	100
Hydrogen	95	90
Oxygen	106	108
Carbon dioxide	96	101
Hydrochloric acid	102	130
Ammonia	101	70

These results suggest that the number of ions produced when the α rays are absorbed is much the same in all gases. Laby has recently made experiments at the Cavendish Laboratory on this point and has found that though there are unmistakable differences in the number of ions produced in different gases, the range of these differences is very much smaller than they would be if the ionisation were proportional to the density and that in general the differences are small. Laby's results are given in the following table.

TABLE II.

Gas	Density ρ	Formula	Stopping power given by Bragg and Kleeman		Total ionisation	
			Experi- ment	Calcul. by $\sqrt{\text{law}}$	Found I	Calculated on the assump- tion that I is proportional to ρ
Air (standard)...	1.00	...	1.00	1.00	1.00	1.00
Nitrous oxide ...	1.52	N ₂ O	1.46	1.52	.97	1.04
Carbon dioxide	1.53	CO ₂	1.47	1.51	1.03	1.05
Acetylene97	C ₂ H ₂	1.11	1.17	1.27	.87
Pentane	2.50	C ₅ H ₁₂	3.59	3.86	1.34	.71
Ethyl chloride...	2.22	C ₂ H ₅ . Cl	2.36	2.31	1.18	.94
Methyl bromide	3.31cal.	CH ₃ . Br	2.09	2.03	1.02	1.58
Ethyl ether.....	2.67	(C ₂ H ₅) ₂ O	3.40	3.67	1.29	.78
Ammonia59	NH ₃89	.90	.66
Aldehyde.....	1.53cal.	CH ₃ . CHO	1.88	1.96	1.05	.82

If the variations in the total number of ions produced are small, the amount of ionisation per unit length of path must be inversely proportional to the length of the path, *i.e.* the amount of ionisation per unit length of path must be proportional to the sum of the square roots of the atomic weights of the atoms in the molecule. The ionisation according to this law is given in the third column of Table I, p. 368. If we compare the results given by this law, which we shall call the square root law, with those given by the law that the ionisation per unit length of path is proportional to the density of the gas, we see that the square root law has the advantage of bringing hydrogen into line with the other gases; on the density law the behaviour of hydrogen is quite exceptional. Laby's results show that the density law is untenable, and that for a considerable number of gases the square root law is true. The square root law will not hold for those gases in which the

total ionisation differs appreciably from that in hydrogen; if the total ionisation is in excess the ionisation per unit length in the gas will exceed that given by the square root law, while if the total ionisation is less than that in hydrogen, the square root law will give too high a value for the ionisation per unit length.

The ionisation produced by an α particle seems to depend upon its charge, for these particles, as Rutherford has shown, cease to ionise at a stage when they possess far greater kinetic energy than is necessary to make an ordinary gaseous positive ion produce ionisation by collision: the most natural explanation of this seems to be that the cessation of ionisation by the α particle is due to its charge having been neutralised by a corpuscle so that the system no longer produces an external electric field. If the ionisation is due to the electric field we may suppose that when an atom comes so near to the α particle that the force at the atom due to the particle exceeds a certain value F , a corpuscle is dragged from the atom and the gas is ionised. The force due to the α particle at a distance r is equal to e/r^2 , hence every atom will be ionised which comes within a distance d of the particle, if $\frac{e}{d^2} = F$. If N is the number of atoms per unit volume the number of atoms ionised by a particle per unit length of path will be $N\pi d^2$ or $\pi Ne/F$. If the square root law of ionisation is true it follows that the electric force required to pull a corpuscle from an atom is inversely proportional to the square root of the atomic weight.

186. We shall now proceed to enquire under what conditions an α particle, which is probably an atom of helium, could travel through 7 cm. of air at atmospheric pressure and have its velocity reduced from 2.6×10^9 to 2×10^9 cm./sec. We shall use the methods developed by Maxwell in his paper on "The Dynamical Theory of Gases," *Collected Papers*, vol. II. p. 36, supposing that the α particles and the atoms of the gas through which they are passing exert forces on each other depending on the distance between them.

187. The α particles are moving so rapidly that the other particles may be regarded as at rest; let us suppose that the force between an α particle and a particle of matter is, when they are at a distance r apart, $\frac{K}{r^n}$, then if V is the velocity of the α particle, M_1 , M_2 the masses of the α particle and a particle of

matter respectively, we have, if δV is the increase in V produced by a collision between an α particle and a particle of matter, and 2θ the angle through which the direction of the relative velocity of the α particle and the molecule against which it collides is deflected,

$$\delta V = -\frac{2M_2}{M_1 + M_2} V \sin^2 \theta$$

(see Maxwell, "The Dynamical Theory of Gases," *Collected Papers*, vol. II. page 36): θ is given by the equation

$$\frac{\pi}{2} - \theta = \int_0^x \frac{dx}{\left\{1 - x^2 - \frac{2}{n-1} \left(\frac{x}{\alpha}\right)^{n-1}\right\}^{\frac{1}{2}}},$$

where $\alpha = b \left\{ \frac{V^2 M_1 M_2}{K (M_1 + M_2)} \right\}^{\frac{1}{n-1}}$,

and x' is the root of the equation

$$1 - x^2 - \frac{2}{n-1} \left(\frac{x}{\alpha}\right)^{n-1} = 0;$$

b being the perpendicular distance from the molecule on the direction of motion of the particle before collision: θ is thus a function of α and n . If the α particle moves through a distance Δx , then in traversing this distance the number of molecules with which it collides having values of b between b and $b + \delta b$ is $2\pi b \delta b N \Delta x$ where N is the number of molecules per unit volume. If the effects of these collisions are additive, as they will be to a first approximation if the value of δV for each collision is small, ΔV the increase in V when the α particle moves through a distance Δx is given by the equation

$$\begin{aligned} \Delta V &= -\frac{4\pi M_2}{M_1 + M_2} V N \Delta x \int_0^\infty \sin^2 \theta \cdot b db \\ &= -\frac{4\pi M_2}{M_1 + M_2} \left\{ \frac{K (M_1 + M_2)}{(V^2 M_1 M_2)} \right\}^{\frac{2}{n-1}} N V \Delta x \int_0^\infty \sin^2 \theta \cdot \alpha d\alpha. \end{aligned}$$

Now θ is a function of n and α only. Hence $\int_0^\infty 4\pi \sin^2 \theta \alpha d\alpha$ will be a function of n alone and will not involve V , M_1 , or M_2 : let us call it A_1 , then

$$\frac{dV}{dx} = -\frac{M_2}{M_1 + M_2} \left(\frac{K (M_1 + M_2)}{M_1 M_2} \right)^{\frac{2}{n-1}} N A_1 V^{\frac{n-5}{n-1}}.$$

If the law of force is that considered by Maxwell, *i.e.* the inverse fifth power of the distance, $n = 5$ and thus $\frac{dV}{dx}$ is independent of the velocity.

If however the law were the inverse fifth power, the penetration of the α particles would, unless their constitution differs very much from that of an ordinary atom, be very much less than is actually the case. We can calculate the penetrating power of helium moving through air as follows. If D is the coefficient of diffusion of helium through air, then (see Maxwell, *Dynamical Theory of Gases*)

$$D = \frac{p_1}{\rho_1} \frac{p_2}{\rho_2 A_1 \left\{ \frac{K}{M_1 M_2 (M_1 + M_2)} \right\}^{\frac{1}{2}} p},$$

where p_1 , ρ_1 , p_2 , ρ_2 are the partial pressures and densities of the helium and air respectively and $p = p_1 + p_2$; in our case when the number of α particles is small compared with the number of molecules $p = p_2$.

Comparing this with the expression for $\frac{dV}{dx}$ we see that

$$\frac{dV}{dx} = -\frac{1}{D} \frac{p_1}{\rho_1} = -\frac{10^{10}}{2D} \text{ approximately,}$$

when D is the value at 0°C . In the absence of any direct determination of D we shall assume that it is about the same as hydrogen through air, *i.e.* about '6, hence $\frac{dV}{dx}$ would be about 10^{10} .

Rutherford's experiments show that the velocity of an α particle falls from 2.6×10^9 to 2×10^9 cm./sec. in 7 cm., hence for the α particles $\frac{dV}{dx}$ is of the order 10^8 , or only about one hundredth part of the calculated value; thus if the law of force were the inverse fifth power of the distance, the penetrating power of the α particles could not exceed one hundredth part of their actual value. If n is less than five the penetrating power will increase rapidly with the velocity and a value of n between 3 and 4 would give sufficient penetrating power to be in accordance with the observations. The variation of viscosity with temperature shows that between molecules of the same kind n must be greater than 5, but the case of the α particles differs materially from that contemplated in

the Kinetic Theory inasmuch as these particles are charged with electricity which will affect the forces between them and the molecules of the gas through which they pass. It may be noticed that $1/D$, which is proportional to $\frac{dV}{dx}$, is for many pairs of gases approximately proportional to the product of the square roots of the atomic weights, a result analogous to Bragg and Kleeman's square root law.

On the detection of the positive electrification on the α rays, and the emission of slowly moving negatively electrified particles by radio-active substances.

188. The detection and measurement of the positive charge carried by the α rays is somewhat difficult owing to radio-active substances emitting large quantities of slowly moving negatively

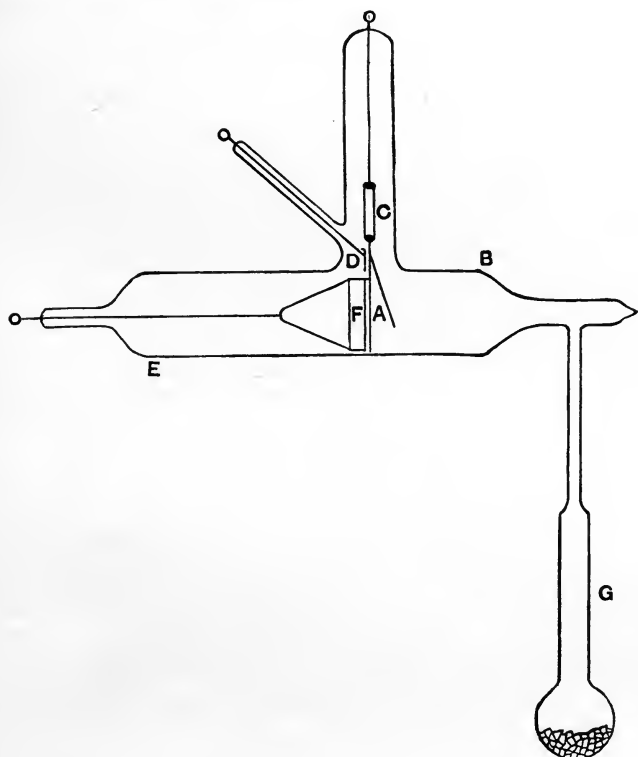

Fig. 92.

electrified particles: the method by which I detected these particles and the charge on the α particles is as follows*.

A gold-leaf electroscope *A* (Fig. 92) was placed in a large glass vessel coated with tin-foil connected with the earth, the leaves of the electroscope were supported by a rod of fused quartz and were charged by the wire *D*, a polonium disc (obtained from Sthamer) was placed in the side tube *D* at a distance of about 1 millimetre from the electroscope, and the tube was exhausted to a very low vacuum by Dewar's method of cooling charcoal with liquid air. The vessel was placed between the poles of a powerful electro-magnet which when excited gave a field of about 12,000 units between the polonium disc and the electroscope. When there was no magnetic field the leak when the electroscope was charged positively was large, much larger than when it was charged negatively, whereas if there had been nothing but α rays given off from the polonium the leak would have been greater when the electroscope was charged negatively. The large positive leak is due to slowly moving corpuscles given off by the polonium; these are moving very slowly, their velocity corresponding to a fall through a potential difference of the order of 2 or 3 volts, whereas the ordinary β particles have velocities corresponding to a fall through many thousand volts. In consequence of their low velocities these corpuscles are stopped by a thin layer of air, so that in order to detect them it is necessary to have a very good vacuum. I have found that they are given off by radium and uranium as well as polonium, and Miss Slater has shown that they are also emitted by thorium and by the radium emanation. The emission of these corpuscles will leave the particles of the emanation with a positive charge and will thus explain the tendency of the emanation to condense on negatively electrified bodies.

Thus slowly moving corpuscles can be stopped by a strong magnetic field and when this is done we can detect the positive charge on the α particles, for in the presence of a strong field it is found that the leak of the electroscope shown in Fig. 92 is zero when it is charged positively and quite appreciable when it is charged negatively, showing that the α particles from the polonium carry a positive charge. Rutherford† has also by a similar method detected the positive charge on the α particles.

* J. J. Thomson, *Proc. Camb. Phil. Soc.* xiii. p. 49, 1904.

† Rutherford, *Phil. Mag.* [6] x. p. 193, 1905.

189. *Absorption of cathode rays.* If a layer of matter is placed in front of a stream of corpuscles, the stream after passing through the plate differs in two respects from the incident stream; in the first place the number of corpuscles in the former stream is less than that in the latter, and secondly the energy of the individual particles in the stream is diminished by the passage through the layer; the emergent stream is also more diffuse than the incident one. It is necessary to distinguish these effects because in some experiments it is merely the diminution in the number that is measured, in others it is the diminution in energy, while in others the effects observed depend upon both the diminution in the number and the diminution of the energy. An example of the first kind is Seitz's experiment in which the quantity measured is the charge carried by the rays which get through the plate; this depends only on the number of corpuscles; an example of the second kind is Leithauser's experiment where the magnetic deflection of the ray was measured after passing through the plate; and examples of the third kind are experiments such as those of Lenard and Rutherford in which the effect produced by the interposition of the layer on the phosphorescence or ionisation produced by the rays is measured. The diminution in the number of corpuscles is due to the deflection of the corpuscles under the forces exerted upon them by the atoms through which they pass; if a corpuscle passes very close indeed to one of the corpuscles inside an atom the path of the corpuscle will be deflected—if it is deflected through more than a right angle, the corpuscle will turn back and will not emerge from the plate; instead of being deflected all at once by one collision, the reversal may be produced by the accumulation of the effects of several collisions.

Calculation of the coefficient of absorption of cathode particles. If we suppose that an atom consists of a number of corpuscles distributed through positive electrification we can find an expression for the absorption experienced by corpuscles when they pass through a layer containing a large number of such atoms. The rapidly moving corpuscle will penetrate the atom and will be deflected when it comes near an inter-atomic corpuscle by repulsion between the corpuscles, this deflection will produce an absorption of the cathode particles. If the corpuscle in the atom is held fixed by the forces acting upon it, the colliding corpuscle

will, after the collision, have the same velocity as before, though the direction of its motion will be deflected; if the atomic corpuscle A is not fixed the colliding corpuscle B will communicate some energy to it and will itself go off after the collision with diminished energy. Without solving the very complicated problem which presents itself when we take into account the forces exerted by the other corpuscles, we can form some idea of the effects produced by such constraint by following the effects produced by increasing the mass of A . The general effect of great constraint would be represented by supposing the mass of A to be very large, while absence of constraint would be represented by supposing the mass of A to be equal to that of B .

Let M_1, M_2 be the masses of the corpuscles A and B respectively; we shall suppose the velocities of the colliding corpuscles so great that in comparison the corpuscles in the atom may be regarded as at rest. Let V be the velocity of B before the collision, b the perpendicular let fall from A on V . Then if 2θ be the angle through which the direction of relative motion is deflected by the collision, we can easily show that, taking the force between the corpuscles to be e^2/r^2 ,

$$\sin^2 \theta = \frac{1}{1 + \frac{b^2 V^4}{e^4} \left(\frac{M_1 M_2}{M_1 + M_2} \right)^2}.$$

If u, u' are the velocities of B parallel to x before and after collision,

$$u' - u = - \frac{M_1 u}{M_1 + M_2} 2 \sin^2 \theta + \frac{M_1}{M_1 + M_2} \sin 2\theta \cos \phi \sqrt{V^2 - u^2}$$

(see Maxwell, *Dynamical Theory of Gases*, page 36), where ϕ is the angle between the plane containing b and V and that containing V and x : averaging, the term containing $\cos \phi$ will disappear and we have

$$u' - u = - 2 \frac{M_1 u}{M_1 + M_2} \frac{1}{1 + \frac{b^2 V^4}{e^4} \left(\frac{M_1 M_2}{M_1 + M_2} \right)^2}.$$

If there are N of the inter-atomic corpuscles per unit volume, the number of collisions in which b is between b and $b + db$ made

by a corpuscle B when it travels over a distance Δx is $N\Delta x 2\pi b db$. Hence if Δu is the change in the velocity of the B corpuscle in Δx ,

$$\Delta(u) = -2uN\Delta x \cdot \frac{M_1}{M_1 + M_2} \int_0^{b_1} \frac{2\pi b db}{1 + \frac{b^2 V^4}{e^4} \left(\frac{M_1 M_2}{M_1 + M_2}\right)^2} \dots (1),$$

where b_1 is determined by the condition that our expressions only apply when the corpuscle B comes into collision with the A corpuscles one at a time, so that the shortest distance between A and B must be considerably less than a , the distance between two corpuscles in the atom.

If r is the least distance between the fixed and moving corpuscles, we can easily show that

$$1 - \frac{b^2}{r^2} = \frac{2e^2}{V^2 r} \frac{M_1 + M_2}{M_1 M_2}.$$

Thus putting $r = a$, we see that b_1 is of the order

$$a \left\{ 1 - \frac{2e^2 M_1 + M_2}{V^2 a M_1 M_2} \right\}^{\frac{1}{2}}.$$

Integrating equation (1) we get

$$\frac{d}{dx}(u) = -u \cdot 2\pi N \cdot \frac{M_1}{M_1 + M_2} \frac{e^4 (M_1 + M_2)^2}{V^4 (M_1 M_2)^2} \log \left\{ 1 + \frac{b_1^2 V^4}{e^4} \left(\frac{M_1 M_2}{M_1 + M_2}\right)^2 \right\}.$$

Since the logarithmic term only varies slowly we may put for b_1 any quantity of the same order without greatly affecting the result; putting

$$b_1 = a \left(1 - \frac{2e^2}{V^2 a} \frac{M_1 + M_2}{M_1 M_2} \right)^{\frac{1}{2}},$$

we get

$$\frac{d}{dx}(u) = -u \cdot \frac{4\pi N e^4 \cdot (M_1 + M_2)}{V^4 \cdot M_1 M_2^2} \log \left(\frac{a V^2}{e^2} \frac{M_1 M_2}{M_1 + M_2} - 1 \right).$$

Thus, neglecting the loss of kinetic energy of the corpuscles, the number of corpuscles crossing unit area in unit time varies as $\epsilon^{-\lambda x}$ where

$$\lambda = \frac{4\pi N \cdot e^4 (M_1 + M_2)}{V^4 \cdot M_1 M_2^2} \log \left(\frac{a V^2}{e^2} \frac{M_1 M_2}{M_1 + M_2} - 1 \right) \dots (2).$$

λ is the coefficient of absorption measured in experiments like

those of Seitz and Becker when the charge carried by corpuscles coming through layers of different thicknesses of various metals is measured. This expression only applies when the velocity of the corpuscle is so great that the corpuscle is able to penetrate the atom and come into the neighbourhood of the corpuscles inside the atom; if the velocity of the corpuscle is small it will be turned back almost as soon as it enters the atom, in this case the collisions are between corpuscles and atoms and not between the moving corpuscle and the individual corpuscles in the atom; the value of λ should be now equal to $2/3l$ where l is the mean free path of a very small body moving through the atoms of the absorbing substance; if the latter is a gas, and l_1 the mean free path of its molecules, $l = 4\sqrt{2}l_1$.

190. Let us now consider the effect produced on the energy of the corpuscles by their collisions. Using the notation of the last paragraph we can easily show that if T is the kinetic energy of a corpuscle before the collision, δT the increase in T produced by the collision, then on the average

$$\delta T = - \frac{4M_1M_2T}{(M_1 + M_2)^2} \sin^2 \theta,$$

and hence if ΔT is the average change in T when the corpuscle moves through a distance Δx ,

$$\begin{aligned} \Delta T &= - \frac{4M_1M_2T}{(M_1 + M_2)^2} \frac{\pi N \cdot e^4 (M_1 + M_2)^2}{V^4 M_1^2 M_2^2} \\ &\quad \log \left\{ 1 + \frac{b_1^2 V^4}{e^4} \left(\frac{M_1 M_2}{M_1 + M_2} \right)^2 \right\} \Delta x \\ &= - \frac{2\pi \cdot N e^4 M_2}{M_1 T} \log \left(\frac{a V^2}{e^2} \frac{M_1 M_2}{M_1 + M_2} - 1 \right) \Delta x \end{aligned}$$

or
$$\frac{dT}{dx} = - 2\pi \frac{N e^4 M_2}{M_1 T} \log \left(\frac{2aT}{e^2} \frac{M_1}{M_1 + M_2} - 1 \right) \dots\dots\dots(3)$$

$$= - \frac{\beta}{T} \text{ say.}$$

Thus T instead of diminishing according to the exponential law will be given by an equation of the form

$$T_x^2 = T_0^2 - 2\beta x,$$

if we neglect the variations in the logarithmic term which occurs in β . This relation is obtained on the supposition that the

velocities of the corpuscles are sufficiently great to carry them into the interior of the atom; for small velocities we can easily show that

$$\frac{dT}{dx} = - \frac{4\bar{M}_1 M_2}{(\bar{M}_1 + M_2)^2} T \frac{2}{3l},$$

where l is the quantity defined on page 378 and \bar{M}_1 is the mass of a molecule of the gas: as M_2 is small compared with \bar{M}_1 we may write this equation in the form

$$\frac{dT}{dx} = - \frac{8}{3} \frac{M_2}{\bar{M}_1} \frac{T}{l},$$

so that T will vary as $e^{-\mu x}$ where $\mu = \frac{8}{3} \frac{M_2}{\bar{M}_1 l}$.

191. There are thus very marked differences between the effects of the absorbing medium on the 'absorption' due to diffusion and on the absorption of the energy. The former follows the exponential law, the latter does not. Again the coefficient λ which measures the diffusive absorption does not vary nearly so rapidly with M_1 , the effective mass of the corpuscle with which the cathode ray comes into collision, as does β the quantity measuring the absorption of the kinetic energy of the rays; the latter is inversely proportional to M_1 while the former is only diminished by one-half when M_1 increases from M_2 to infinity. We should expect from this that the absorption of the kinetic energy should depend much more on the structure of the atom of the absorbing medium than the absorption due to diffusion.

192. We can express the value of λ in terms of P , the number of corpuscles in an atom of the absorbing substance, for if δ is the density of the substance, m the mass of an atom, $P\delta = Nm$ and equation (2) becomes

$$\lambda = \frac{4\pi\delta P}{mV^4} \frac{e^4}{M_2^2} \cdot \frac{M_1 + M_2}{M_1} \log \left(\frac{\alpha V^2}{e^2} \frac{M_1 M_2}{M_1 + M_2} - 1 \right):$$

putting $e/M_2 = 1.7 \times 10^7 \cdot V_0$, $e = 3.5 \times 10^{10}$, and $e/m = 10^4 V_0/w$, where V_0 is the velocity of light and w the atomic weight of the absorbing substance, we get

$$\frac{\lambda}{\delta} = \frac{4\pi P}{w} \frac{V_0^3}{V^4} 10.5 \times 10^8 \frac{M_1 + M_2}{M_1} \log \left(\frac{\alpha V^2}{e^2} \frac{M_1 M_2}{M_1 + M_2} - 1 \right).$$

We have data by which we can determine λ/d , for Rutherford has determined the diminution in the ionisation produced by the β rays from uranium, which are much more nearly uniform in velocity than those from radium, when they pass through various substances, and assuming that it falls off according to the exponential law $e^{-\lambda'x}$, he finds the following values for λ'/δ .

Substance	λ'	δ	λ'/δ
Glass	14	2.45	5.7
Mica.....	14.2	2.78	5.1
Ebonite	6.5	1.14	5.7
Wood	2.16	.40	5.4
Cardboard	3.7	.70	5.3
Iron	44	7.8	5.6
Aluminium.....	14	2.6	5.4
Copper.....	60	8.6	7.0
Silver	75	10.5	7.1
Lead.....	122	11.5	10.8
Tin	96	7.3	13.2

The value of λ_1 is not necessarily the same as that of λ , as the ionisation in the vessel is influenced by the diminution in their kinetic energy as well as by the diminution in their number. The diminution in the kinetic energy if not accompanied by a diminution in their number would produce an increase in the ionisation, as we see from equation (3) that the energy communicated by the cathode rays to the atoms through which they pass increases as the energy of these rays diminishes, so that λ_1 is less than λ , though probably of the same order of magnitude. Becquerel found that the velocity of the β rays from uranium was

$$1.6 \times 10^{10} \text{ cm./sec.}$$

Substituting this value of V in equation (2) we find, if M_1 is large compared with M_2 ,

$$\frac{\lambda}{\delta} = \frac{7P}{w} \log \left(\frac{aV^2}{e^2} \frac{M_1 M_2}{M_1 + M_2} - 1 \right).$$

Comparing this with the value given above for the uranium rays and remembering that the logarithmic term is not very large we see that P will not be greatly different from w , a result we arrived at from different considerations on p. 327, *i.e.* that the

number of corpuscles in an atom is a quantity of the same order as the atomic weight.

193. The expression for λ is inversely proportional to the fourth power of the velocity and thus diminishes very rapidly as the velocity increases—the penetration of the rays increases with great rapidity with the velocity. This result is amply confirmed by experiment, as the following results given by Lenard* show.

Velocity of corpuscles expressed as due to a potential fall in volts	Velocity of corpuscles expressed as a fraction of the velocity of light	λ for the following gases at a pressure of 1 mm. of mercury			
		Hydrogen	Air	Argon	Carbonic acid
6	1/270	44	30	28	34
30	1/120	14.6	27	26	32
100	1/70	6.01	21	20	28
1000	1/20	1.2	3.9	4.2	7
40000	1/10	0.19	0.85	1.3	2
30000 ?	1/3 ?	0.00062	0.005	—	0.0067
	1	0.000006	0.000009	0.00001	0.00001

It will be seen that for the more rapidly moving corpuscles the absorption diminishes very rapidly as the velocity increases, while for the slower corpuscles it varies but slowly with the velocity; this is in accordance with the considerations given above, and arises from the slower corpuscles not being able to penetrate into the atom. It is remarkable that hydrogen, which absorbs the quicker rays less than any of the other gases, has the greatest absorption for the slowest rays. The absorption of hydrogen for the slowest rays is greater than we should have anticipated, for the mean free path of a hydrogen molecule moving through hydrogen at the pressure of 1 mm. of mercury is

$$760 \times 2 \times 10^{-5} \text{ cm. :}$$

hence l the mean free path of a corpuscle moving, as do the slowest of those given in the table, with a velocity large compared with the mean velocity of a hydrogen molecule, is

$$4\sqrt{2} \times 760 \times 10^{-5} \text{ cm. or } 4.2 \times 10^{-2}.$$

We have seen that the value of λ for the slow corpuscles is $2/3l$,

* Lenard, *Annalen der Physik*, xii. p. 732, 1903.

i.e. about 16, the value given by Lenard is 44. The values of $2/3l$ for air, argon, and CO_2 are respectively 32, 31, 46.

The absorption of the rays by air, argon, and carbonic acid is about what we should expect if we suppose that the charge on the corpuscle does not influence its free path; the absorption by hydrogen is however considerably greater than the value got on this supposition, suggesting that the force between the hydrogen molecule and the charge on the corpuscle is sufficient to make the free path of the charged corpuscle considerably smaller than that of an uncharged body of the same size: we shall see that the absorption of hydrogen is anomalous with rapidly moving corpuscles as well as with slow ones.

Seitz* has made a series of determinations of the number of corpuscles passing through thin layers of metal, for corpuscles moving with different velocities; his results, which do not seem to have been corrected for the reflection of corpuscles at the surface of the layers, indicate a coefficient of absorption varying inversely as $aV^6 - bV^4$ where V is the initial velocity of the corpuscle and a and b are constants.

*Connection between the coefficient of absorption and the density
of the absorbing substance.*

194. For rapidly moving corpuscles the coefficient of absorption is roughly proportional to the density. This was first shown by Lenard† for rapidly moving cathode rays, emerging from the discharge tube through a thin aluminium window—the rays had a velocity corresponding to that given to the charge on a corpuscle through a fall of potential of about 30,000 volts. Lenard estimated the intensity of the rays by the luminosity they produced on a phosphorescent screen, so that the coefficient of absorption he measured was that corresponding to the change in the energy carried by the rays through unit area in unit time, and not merely the change in the number of corpuscles passing through this area.

Lenard's results are given in the following table, where λ is the coefficient of absorption and d the density of the absorbing substance.

* Seitz, *Ann. der Phys.* xii. p. 860, 1903.

† Lenard, *Wied. Ann.* lvi. p. 255, 1895.

Substance	λ cm. ⁻¹	d gr./cm. ³	λ/d
Hydrogen at 3 mm. pressure	·00149	3.6×10^{-7}	4040
Air at 78 mm. pressure	·00416	1.2×10^{-6}	3330
Hydrogen at 760 mm. pressure ...	·476	8.5×10^{-5}	5610
Air " " "	3·42	1.2×10^{-3}	2780
SO ₂ " " "	8·51	2.7×10^{-3}	3110
Collodium	3310	1·1	3010
Paper	2690	1·30	2070
Glass	7810	2·47	3160
Aluminium	7150	2·70	2650
Mica	7250	2·80	2590
Dutch metal	23800	8·90	2670
Silver	32200	10·5	3070
Gold	55600	19·3	2880

Thus though the density of the lightest substance is but one fifty-millionth of that of the heaviest, the values of λ/d only range from 2070 to 5610. Hydrogen shows an abnormally high absorption; if we leave out this gas the range in λ/d is only from 2070 to 3330. Thus λ/d varies very little; the differences in the values of this quantity for different substances seem however to be real and would repay further investigation from the light they might be expected to throw on the structure of the atom.

Substance	λ cm. ⁻¹	d	λ/d
Platinum.....	157·6	21·5	7·34
Lead	62·5	11·4	5·48
Silver	65·7	10·6	6·20
Copper.....	49·2	8·95	5·50
Iron	52·2	7·76	6·74
Tin	51·2	7·3	7·01
Zinc	40·3	7·2	5·58
Mica.....	10·8	2·74	3·94
Glass	12·5	2·73	4·58
Aluminium.....	11·6	2·7	4·30
Celluloid	5·45	1·36	4·01
Ebonite	4·77	1·14	4·18
Card	3·84	1·0	3·84
Sulphur-dioxide...	·0413	·0078	5·45

Strutt* has measured the coefficient of absorption of the much more rapidly moving corpuscles given out by radium, measuring the intensity of the stream of corpuscles by the ionisation they

* Hon. R. J. Strutt, *Nature*, lxi. p. 539, 1900.

produced; his coefficient like that of Lenard measures the rate of diminution of the energy carried by the corpuscles. The corpuscles coming from radium are projected with different velocities, so that the intensity cannot be represented by one exponential term, and the values obtained for the coefficient of absorption will depend somewhat on the thickness of the absorbing layer. Strutt's results are given in the preceding table.

The values of λ/d for platinum, tin, iron, are abnormally high; this is confirmed by the results given on p. 380 for the corpuscles emitted by uranium, and also by some recently obtained by Godlewski* for those given out by actinium. The intensity of the rays was measured by the ionisation they produced so that the coefficient of absorption was of the same kind as that obtained by Lenard and Strutt.

The following table contains Godlewski's results for the rays for actinium for a few metals along with those obtained by Rutherford for the uranium rays and by Strutt for the radium rays.

Substance	Actinium		Uranium		Radium	
	λ	λ/d	λ	λ/d	λ	λ/d
Aluminium	32.7	12.9	14.0	5.4	11.6	4.30
Mica	33.0	12.0	17.2	5.1	10.8	3.90
Brass.....	108	13.1
Copper	139	15.9	60	7.0	49.2	5.50
Tin-foil.....	154	15.7	51.2	7.01
Lead	163	14.1	122	10.8	62.5	5.48

The variations in λ/d are smaller for the rays from actinium than for those from uranium or radium, and indicate that the proportion between the absorption of different substances depends upon the velocity of the rays.

Crowther has recently measured at the Cavendish Laboratory the values of λ/D for a considerable number of elementary substances using the β rays given out by uranium. The results are shown in Fig. 93, the elements being arranged in the groups indicated by the periodic law. It will be noticed that the values of λ/D of the elements in the different groups show similar variations with increase of atomic weight. The elements at the

* Godlewski, *Phil. Mag.* [6] x. p. 375, 1905.

beginning of a group have smaller values of λ/D than the elements at the end of the preceding group, the values in the group increase with the atomic weight and do so with exceptional rapidity at the end of the group.

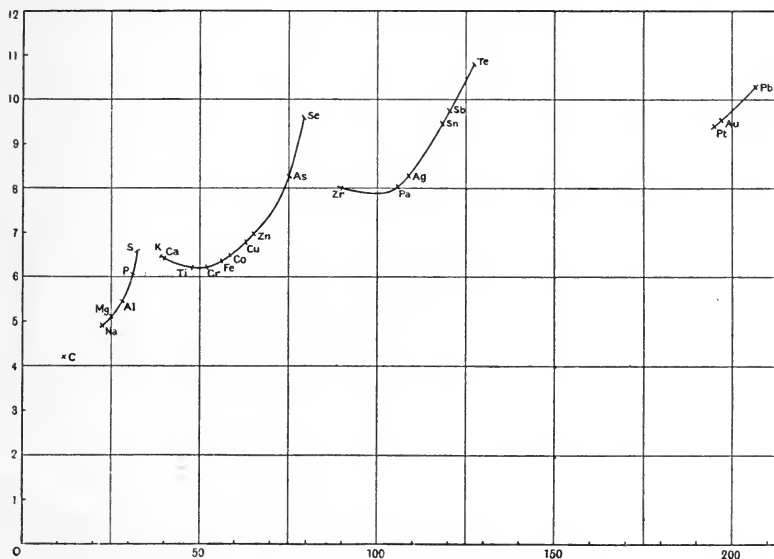

Fig. 93.

If we suppose the absorption produced by each atom to be unaffected by the presence of neighbouring atoms, then we can show that λ/D is equal to λ'/m_1 where λ' is the absorption due to one atom and m_1 the mass of the atom. For if N is the number of atoms in a plate of unit area and unit thickness

$$\lambda = N\lambda', \text{ and } D = Nm_1,$$

hence

$$\frac{\lambda}{D} = \frac{\lambda'}{m_1}.$$

If we have a mixture or chemical compound of two elements A and B , and if λ_{AB} is the value of λ for the mixture, $(\lambda/D)_A$, $(\lambda/D)_B$ the values of λ/D for A and B when separated, λ'_A , λ'_B the absorptions due to an atom of A and B respectively, N_1 , N_2 the numbers of atoms of A and B in a plate of unit area and unit thickness: then

$$\lambda_{AB} = N_1\lambda'_A + N_2\lambda'_B = N_1m_1(\lambda/D)_A + N_2m_2(\lambda/D)_B,$$

where m_1 and m_2 are the masses of the atoms of A and B ; if D is the density of the mixture,

$$D = N_1 m_1 + N_2 m_2,$$

hence

$$\left(\frac{\lambda}{D}\right)_{AB} = \frac{N_1 m_1 (\lambda/D)_A + N_2 m_2 (\lambda/D)_B}{N_1 m_1 + N_2 m_2} = \frac{M_1 (\lambda/D)_A + M_2 (\lambda/D)_B}{M_1 + M_2},$$

where M_1, M_2 are the masses of A and B respectively in unit volume, thus (λ/D) is an additive property; this result has been verified by Crowther, it enables us to find the value of (λ/D) for substances which can not be obtained in the free state.

Seitz* has measured the mass per unit area of plates of different substances which diminish the charge carried by the β rays from radium bromide passing through them to the same extent. The charge was received on a metal plate connected with an electrometer, the results are not free from ambiguity as the charge received by this plate would be influenced by reflection from the plate, the reflected rays not giving up their charges; the amount of reflection would depend upon the velocity of the rays, and since the law of absorption of the velocity of the β particle is not the same as that of the number of the particles, the equality of the charge given to the electrometer would not, unless the effect of reflection were allowed for, necessarily imply that the plate connected with the electrometer was struck by the same number of β particles. Seitz's results are given in the following table.

Substance	Mass of unit area of plate of substance producing same absorption as a tin plate of unit mass	Substance	Mass of unit area of plate of substance producing same absorption as a tin plate of unit mass
Lead	0.745	Aluminium	1.56
Gold	0.83	Gypsum ...	1.57
Platinum.....	0.84	Paper	1.57
Tin	1	Mica	1.57
Silver	1	Water	1.66
Dutch metal	1.227	Paraffin.....	1.69
40% silver nitrate solution.....	1.258	Ebonite.....	1.73
Steel.....	1.29	Carbon (gas-coke).....	1.86
Sulphur	1.34		

* Seitz, *Phys. Zeitsch.* v. p. 395, 1904.

Becker* has recently measured the coefficients of absorption corresponding to the diminution in the number of particles passing through unit area in unit time, for cathode rays produced by an induction coil, and having a velocity corresponding to that of a potential fall of about 35,000 volts. The results for gases are given in the following table, λ is the coefficient of absorption of the gas at a pressure of 1 mm. of Hg, D the density of the gas.

Gas	λ	λ/D
Helium	·000292	1243
Argon	·00314	1412
Oxygen	·00285	1613
Air	·00278	1730
Carbonic acid.....	·00423	1730
Sulphur-dioxide.....	·00662	1747
Nitrogen.....	·00278	1781
Ethylene.....	·00330	2117
Ammonia	·00219	2302
Marsh gas	·00230	2486
Hydrogen	·000337	2990

The values of λ/D for the inert monatomic gases are distinctly less than for the other gases, while for hydrogen and gases containing hydrogen they are decidedly higher. The values of λ make us suspect another anomaly in the behaviour of hydrogen; for since the absorption of the rays is an atomic property the value of λ for a compound should, if no change takes place in the atom when it enters into chemical combination, be calculable from the values of λ for the constituents of the compound; applying this rule we can from the values of λ for nitrogen and ammonia calculate the value of λ for H_2 , we can also calculate this value from the absorptions of CH_4 , C_2H_4 , if we do this we get the following values for λ for hydrogen:

$$\begin{aligned} \text{from } NH_3 \text{ and } N_2 & \quad \lambda = \cdot00053, \\ \text{from } CH_4 \text{ and } C_2H_4 & \quad \lambda = \cdot00065, \\ \text{from } H_2 \text{ itself} & \quad \lambda = \cdot00033. \end{aligned}$$

There are thus considerable discrepancies in the absorption of hydrogen as determined by these different methods, and though we could not expect any very close agreement, since the absorption

* Becker, *Ann. der Phys.* xvii. p. 381, 1905.

due to the hydrogen in the compounds is not large, the discrepancy seems greater than can be explained by errors of experiment, for the differences in the values of λ/D for one gas, determined by experiments made over a considerable range of pressure, were much smaller in Becker's experiments than we should expect if the variations in the value of λ for hydrogen in its different combinations were due to errors in the experiments.

The expression for the diminution in the number of corpuscles crossing unit area in unit time given on page 376 indicates that variations in the value of λ/D with the nature of the atom may arise in two ways, (1) from variations in M_2 the effective mass of a corpuscle inside an atom, (2) from variations in the logarithmic term which involves a the mean distance between the corpuscles in the atom as well as the velocity of the corpuscles. If the variation in λ/D arose entirely from (1) the ratio of the values of λ for different substances should be independent of the velocity of the corpuscles; a reference to the results given on pp. 380, 384 will show that this is not the case, hence we conclude that a considerable portion of the variation of λ must arise from variations in the mean distances between the corpuscles.

195. *Absorption of Kinetic Energy of the Corpuscles.* It is important to separate the diminution in the kinetic energy of the corpuscles from the scattering of the particles due to the deflection of their paths, as the two are not necessarily proportional to each other; indeed we might easily have scattering without any diminution in kinetic energy. The results given on page 378 show that the diminution in the kinetic energy varies much more rapidly with the mass of the particle against which the moving corpuscle collides than does the scattering, hence we should expect that the coefficients which represent the diminution in kinetic energy would depart far more from the density law than do the coefficients which represent the scattering. We have not enough determinations of the absorption coefficients for the kinetic energy to determine whether they obey the density law or not; that there is a diminution in the kinetic energy has been shown by Leithauser* who measured the magnetic deflection of cathode rays before and after their passage through thin aluminium films—these measure-

* Leithauser, *Ann. der Physik*, xv. p. 283, 1904.

ments showed (1) that a pencil of cathode rays which were homogeneous before passage through the film were no longer so when they emerged from it, but consisted of rays possessing velocities over a considerable range, (2) that these velocities were all less than the velocity of the rays before entering the film. This is what we should expect from the theory of collisions; the corpuscles when passing through the film will not all make the same kind or number of collisions, so that when they emerge their velocities will be grouped about a mean, somewhat like the distribution of molecular velocities according to Maxwell's law, there being however none with a velocity greater than the initial velocity of the corpuscle. The distribution of corpuscles about a mean is shown in Figs. 94 *a* and *b* taken from Leithauser's paper; the ordinates represent the number of corpuscles possessing a velocity represented by the abscissae. Figs. 94, *a* and *b*, correspond to the cases when the initial velocities of the corpuscle were respectively 6.4×10^9 cm./sec. and 7.84×10^9 cm./sec. It will be seen that the emergent pencil is much more homogeneous with the quick corpuscles than with the slow ones.

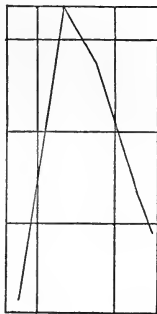
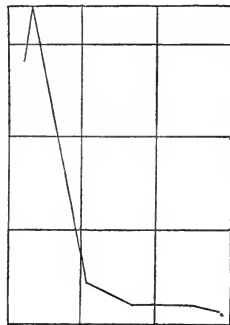
Fig. 94 *a*.Fig. 94 *b*.

The loss of velocity was much less with the quick corpuscles than with the slow ones. When the initial velocity was 7.84×10^9 , the velocity after passing through an aluminium film .00018 cm. thick was 7.73×10^9 ; this makes the coefficient of absorption of the velocity 77; as this is much smaller than the 'scattering coefficient' of aluminium for rays of the same velocity, it indicates that the greater part of the absorption of cathode rays is due to

scattering and not to loss of velocity. Des Coudres* has also measured the diminution in velocity which occurs when rays pass through thin films of metal, he found that the rays which emerged obliquely had smaller velocities than those emerging normally.

Reflection of cathode rays and β particles.

196. When rapidly moving corpuscles strike against the surface of either a conductor or an insulator, streams of corpuscles start from the surface in all directions, these are often spoken of as 'diffusely reflected' rays. We must remember that this diffusely reflected stream may arise in two ways, it may consist in part of corpuscles which were incident upon the surface and which have had their motion reversed by collisions with the molecules of the reflector, another part of it may be due to corpuscles which are emitted by molecules of the reflector under the action of the incident rays; it is better to confine the term reflected rays to the first class, and to call the second class secondary rays. The secondary rays are analogous to those emitted by a metallic surface when exposed to ultra-violet light. To distinguish between reflected and secondary rays it is necessary to take some property such as the velocity of the rays or their penetrating power and see whether the magnitude of this is of the same order in the rays coming from the plate as in those striking against it; if the two are of quite different orders we infer that the rays are secondary.

The diffuse reflection of the β rays emitted by radio-active substances was studied by Becquerel† who used the photographic method; it has also been investigated by Eve‡ and McClelland§, who used the ionisation method. The existence of these diffusely returned rays can be easily demonstrated by an arrangement like that represented in Fig. 95. The radio-active substance is placed at *R* and screened from the electroscope by a thick lead plate, so that when the reflecting plate *M* is removed there is only a slow leak in the electroscope due to the γ rays from the radio-active substances which have passed through the lead screen. When the reflecting surface *M* is placed in the way of the rays from *R* the

* Des Coudres, *Phys. Zeitsch.* iv. p. 140, 1902.

† Becquerel, *C.R.* cxxxii. pp. 371, 374, 1286, 1900.

‡ Eve, *Phil. Mag.* [6], viii. p. 669, 1904.

§ McClelland, *Trans. Royal Dublin Soc.* viii. p. 169, 1905; ix. p. 1, 1905.

rate of leak of the electroscope is greatly increased; that the rays producing this leak are mainly due to the β rays from R and not

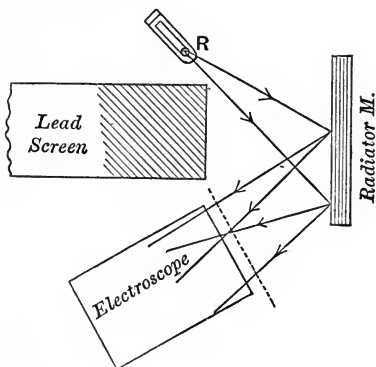

Fig. 95.

to the γ rays can be shown by placing in the path of the incident rays a sheet of lead thick enough to absorb the β rays but not thick enough to absorb an appreciable amount of the more penetrating γ rays; when this is done the rate of leak from the electroscope is reduced by about 80 per cent. The amount of this returned radiation does not vary much with the state of the surface of M ; it is about the same for iron as for iron filings and for ice as for water. As might be expected some of these returned rays start from some little depth below the surface, and their number increases with the thickness of M until this thickness is a few millimetres when the number becomes practically constant.

The relative amounts of these returned rays from various reflectors and the absorption coefficient of these rays when they pass through aluminium are given in the following table (p. 392) taken from Eve's paper.

The primary β rays are not homogeneous, the mean value of λ for aluminium for these rays is about 14, thus with the exception of the rays from granite, brick, and cement the penetrating power of the reflected rays is less than that of the incident ones, though the difference is hardly great enough to warrant us to come to a decision as to whether these rays are reflected or secondary. McClelland found the coefficient of absorption of the reflected rays from lead to be the same as for the primary.

Reflector	Density	Secondary radiation	Sec. rad. Density	λ for aluminium
Mercury	13·6	147	10·8	
Lead	11·4	141	12·4	18·5
Copper.....	8·8	79	9·0	20
Brass	8·4	81	9·6	21
Iron (wrought) ...	7·8	75	9·6	20
Tin	7·4	73	9·9	20·3
Zinc.....	7·0	79	11·3	
Granite	2·7	54	20·0	12·4
Slate	2·6	53	20·4	12·1
Aluminium.....	2·6	42	16·1	24
Glass	2·5	44	17·6	24
Cement	2·4	47	19·6	13·5
Brick	2·2	49	22·3	13·0
Ebonite	1·1	32	29·1	26·0
Water	1·0	24	24·0	21
Ice	·92	26	28·2	
Paraffin, solid.....	·9	17	18·8	21
„ liquid ...	·85	16	18·8	
Mahogany	·56	21·4	38·2	23
Paper	·4 ?	21·0	52	22
Mill-board	·4 ?	19·4	48	20·5
Papier-mâché.....		21·9		
Bass-wood	·36	20·7	57	22
Pine.....	·35	21·8	62	21
X-ray screen		75·2		23·6

A strong reason for believing the rays coming from the reflecting plate to be secondary rather than reflected, is that it would appear from Eve's experiments that the character of the diffusely returned rays produced by the γ rays is much the same as that of the rays produced by the β rays. In the case of the γ rays there can be no question of reflection, for the properties of the incident and returned rays are quite distinct. The incident rays are very penetrating and are not deflected by a magnet, while the returned rays are easily absorbed and easily deflected. If, as seems to be the case, the returned rays produced by the β rays are of the same character as those produced by the γ , the argument for the rays being secondary rather than reflected seems very strong. It is perhaps surprising that if the rays are secondary the quality of the rays emitted by different substances should not differ more widely than Eve's experiments indicate; this however cannot be considered as at all conclusive against the secondary nature of this radiation, as the same uniformity of properties apparently exists when the

γ rays alone are used, and in this case the returned radiation is plainly secondary. The variation, if any, of the quality of the returned radiation with the nature of the source of the incident β radiation is one well worthy of attention, as in all the experiments hitherto made radium bromide in radio-active equilibrium has been used.

McClelland has made an extensive series of observations on the relative amounts of the diffusively returned radiation produced by the combined action of the β and γ rays from radium-bromide on the different chemical elements. His results are given in the following table, the third column gives the relative amounts of secondary radiation produced by an incident beam of constant intensity; p , given in the fourth column, is the ratio of the energy in the secondary radiation to that in the primary*.

I. Substance	II. Atomic weight	III. Secondary radiation	IV. $p \times 1000$
Uranium	239.5	100	50.5
Bismuth	208.5	97	49
Lead	206.9	97	49
Mercury	200.3	96	48.5
Platinum	194.8	93	47
Tungsten	184	88	44
Iodine	127	85.5	43
Antimony	120	85	42.5
Tin	118.5	84	42.5
Cadmium.....	112.4	82	41.5
Silver	107.9	81	41
Molybdenum	96	78	39.5
Selenium	79.1	74	37
Arsenic.....	75	73	36.5
Zinc	65.4	72	36.5
Copper	63.6	71	36
Cobalt	59	67	34
Nickel	58.7	67	34
Iron	55.9	65	33
Chromium	52.1	63	31.5
Calcium	40.1	55	27.5
Potassium	39.1	54	27
Sulphur	32.06	53.5	27
Phosphorus	31	53	26.5
Aluminium	27.1	48	24
Magnesium	24.4	43	21.5
Sodium	23.0	42	21.5
Carbon	12	29	15

* McClelland, *Trans. Roy. Irish Acad.* ix. p. 9, 1906.

It will be seen that the order for the amount of secondary radiation is that of the atomic weights. McClelland has pointed out a peculiarity in the variation of this radiation with the atomic weight; this is most easily understood if we represent graphically the relation between the secondary radiation and the atomic weight. Such a graph is shown in Fig. 96. If we consider the elements in

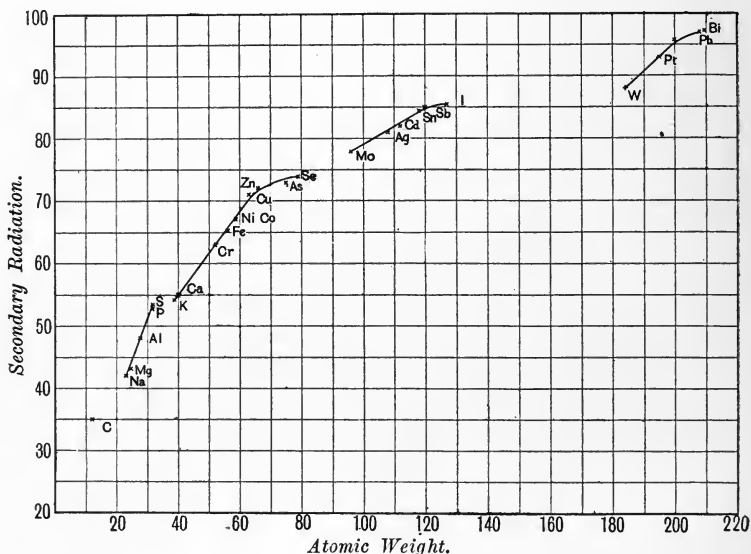

Fig. 96.

one of Mendeléeff's groups, the secondary radiation increases more rapidly with the atomic weight for the elements at the beginning of the group than for those at the end. We have seen (see p. 385) that the values of λ/D increase more rapidly with the atomic weight for the elements at the end of a group than for those at the beginning. This difference in the curves might have been expected as increased absorption will diminish the amount of secondary radiation coming from the plate.

The secondary radiation excited by radium rays is thus closely related to the atomic weight and therefore to the chemical properties of the elements. I have found that this is also true for the secondary radiation excited by Röntgen rays. This is shown in Fig. 97, which represents the results of determinations which I have made with the help of Mr G. W. C. Kaye on the ionisation produced by the secondary rays in the first 15 mm. of air above

the substance emitting the secondary rays; these rays were excited by hard Röntgen rays. It will be noticed that with the exception of the case of nickel, increase of atomic weight is accompanied by increased ionisation. And also that at certain points there is a large change in the ionisation for a small change in the atomic weight; these points occur at the middle of the groups into which the elements are divided by the periodic law.

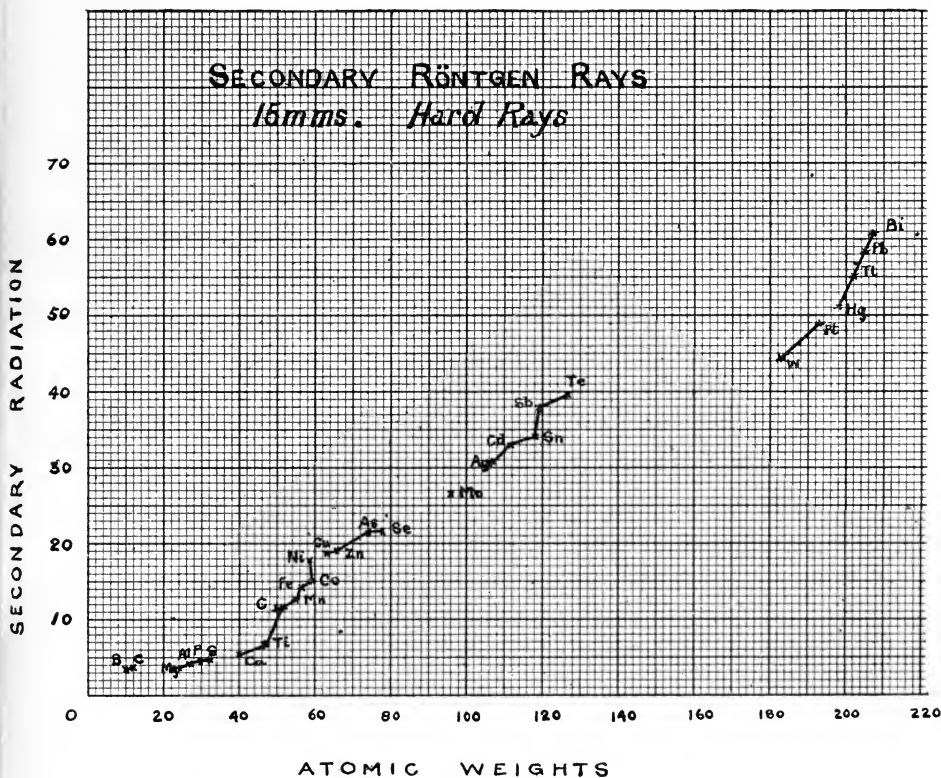

Fig. 97.

197. *Secondary Radiation from Mixtures.* The radiation and the absorption of the radiation is an atomic property; making use of this principle we can find an expression for the secondary radiation from a mixture or chemical compound of two substances, *A* and *B*. Let *m* and *n* be the number of atoms of *A* and *B* per unit volume, *k*₁ and *k*₂ the secondary radiation from an atom of *A* and *B* respectively for the absorption of unit energy of the primary

radiation, a , b , the absorption of atoms of A and B for the primary radiation, a_1 , b_1 that for the secondary radiation from A , a_2 and b_2 that from B .

In the mixture or chemical compound the absorption per unit volume of the primary radiation will be $ma + nb$, so that if I_0 is the intensity of primary radiation travelling parallel to the axis of x and incident on a slab bounded by a plane face perpendicular to the axis of x , the intensity of the primary radiation at a depth x inside the plate will be $I_0 e^{-(ma+nb)x}$. The secondary radiation from the substance A excited by this radiation in a layer of thickness Δx is $k_1 m I_0 e^{-(ma+nb)x} dx$, and when this emerges from the plate the intensity is reduced to

$$k_1 m I_0 e^{-(ma+nb)x} e^{-(ma_1+nb_1)x} dx.$$

If the slab is thick, the total radiation of the A kind emerging from the plate will be obtained by integration with respect to x from zero to infinity, and is therefore equal to

$$\frac{k_1 m I_0}{(ma+nb) + (ma_1+nb_1)} = \frac{k_1 m I_0}{m(a+a_1) + n(b+b_1)}.$$

Let us denote this by R'_A : if R_A is the radiation from a slab made entirely of A ,

$$R_A = \frac{k_1 I_0}{a+a_1},$$

thus

$$R'_A = \frac{m(a+a_1) R_A}{m(a+a_1) + n(b+b_1)}.$$

Similarly if R'_B is the secondary radiation from B coming out of the plate,

$$R'_B = \frac{n(b+b_2) R_B}{m(a+a_2) + n(b+b_2)},$$

where R_B is the secondary radiation from a pure B plate.

These expressions for the secondary radiation take a much simpler form when the absorption of the radiation, primary as well as secondary, follows Lenard's law, *i.e.* is proportional to the density of the substance. The number of atoms in unit volume of an elementary substance is equal to the density divided by the mass of an atom, hence if the absorption of the substance is proportional to the density the absorption per atom must be proportional to the mass of the atom. If M_1 , M_2 are the masses

of the atoms of A and B respectively, then when Lenard's law holds we may put

$$a = \gamma M_1, \quad b = \gamma M_2, \quad a_1 = \gamma_1 M_1, \quad b_1 = \gamma_1 M_2, \quad a_2 = \gamma_2 M_1, \quad b_2 = \gamma_2 M_2.$$

Substituting these values we find

$$R'_A = \frac{m M_1 R_A}{m M_1 + n M_2},$$

$$R'_B = \frac{n M_2 R_B}{m M_1 + n M_2},$$

or if q_1 and q_2 are respectively the masses of A and B per unit volume

$$R'_A = \frac{q_1 R_A}{q_1 + q_2},$$

$$R'_B = \frac{q_2 R_B}{q_1 + q_2}.$$

These results enable us to calculate the secondary radiation from elements which can only be obtained in the combined state.

198. *Reflection of cathode rays produced by an electric discharge.* When these cathode rays, which are very much slower than those produced by radio-active substances, strike the surface of either a conductor or an insulator secondary cathode rays start from the surface in all directions; this phenomenon is generally called the diffuse reflection of the cathode rays: we must be careful however to remember that reflection is used in a different sense from that which is usual in optics, where for example we should not speak of the phosphorescent light given out by such a substance as quinine when struck by ultra-violet.

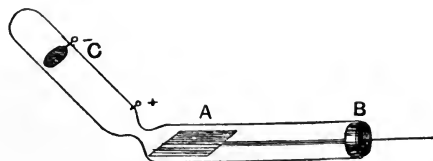

Fig. 98.

light as reflected light; in the case of the cathode rays all the cathode rays proceeding from a surface struck by cathode rays are called reflected rays. The existence of such rays is easily

shown by an experiment due to Goldstein*. The cathode rays from the cathode *C* fall on the plate *A* which can be rotated by a handle passing through a stuffing-box. The half of the tube *AB* on the illuminated side of *A* becomes phosphorescent from the cathode rays diffusely reflected from *A*. The reflection occurs even when the plate does not itself become phosphorescent under cathode rays.

199. Measurements of the amount of 'reflection' experienced by cathode rays when incident upon different substances and at different angles of incidence have been made by Campbell Swinton†, by Starke‡, and by Austin and Starke§. Campbell Swinton's experiments, which had for their object the measurement of the variation of the 'reflected' rays at various angles of

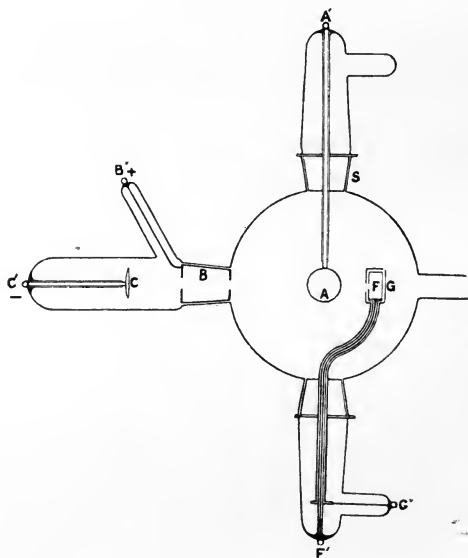

Fig. 99.

incidence and emergence, were arranged as represented in Fig. 99. *C* is the cathode; *A* the reflecting surface, a flat piece of platinum which could be rotated about its axis; *F'* a Faraday cylinder which

* Goldstein, *Wied. Ann.* xv. p. 254, 1882.

† Campbell Swinton, *Proc. Roy. Soc.* lxiv. p. 377, 1899.

‡ Starke, *Wied. Ann.* lxvi. p. 49, 1898; *Ann. der Phys.* iii. p. 75, 1900.

§ Austin and Starke, *Ann. der Phys.* ix. p. 271, 1902.

receives the rays emitted by the surface; this could be set so that the opening made any required angle with the direction of the incident rays; the charge received by this cylinder was taken as the measure of the amount of reflection. Campbell Swinton came to the conclusion that although the 'reflection' was very diffuse there was appreciably more in the direction in which the angle of emergence was equal to the angle of incidence than in any other direction; he found that the total amount of emission was slightly greater at oblique than at normal incidence; he measured also the charge received by the reflector and found that though with normal incidence it received a large negative charge, the charge diminished as the incidence became more oblique, vanished, and finally with very oblique incidence became positive. The positive charge received by the reflector has also been observed by Austin and Starke (*l.c.*).

Starke determined the proportion between the incident and receding rays, or rather the ratio of the negative charge acquired by the reflector to that carried by the receding rays.

The principle of the method used by Starke is as follows. The cathode rays enter through a hole in the cylinder and strike the reflector; the cylinder and reflector are each connected to earth through high-resistance galvanometers; when the rays strike against the reflector currents pass through these galvanometers; let i_1, i_2 be the currents through the galvanometers connected with the reflector and cylinder respectively; let N be the number of corpuscles striking the reflector in unit time, n the number leaving it in the same time, e the charge on a corpuscle; then, if there is no ionisation in the gas of the cylinder, no escape of the receding

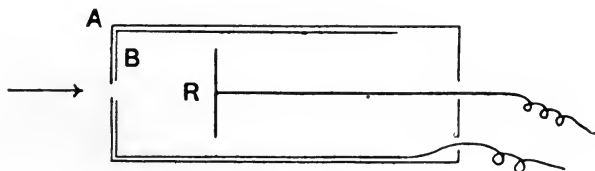

Fig. 100.

rays through the hole, and no diffusion of the incident rays in the cylinder causing some of the incident rays to strike the walls of the cylinder instead of the reflector, and if we neglect the charge carried away from the cylinder by the secondary Röntgen rays

excited by those Röntgen rays proceeding from R , the place of impact of the cathode rays, we have

$$(N - n)e = i_1; \quad ne = i_2;$$

or

$$\frac{n}{N} = \frac{i_2}{i_1 + i_2};$$

hence if we measure i_1 and i_2 we can determine the value of n/N ; in practice some corrections are necessary, for which we must refer to Starke's paper (*l.c.*); the value of n/N depends upon the metal; the following are Starke's values for this quantity:

Metal	Density	n/N	Metal	Density	n/N
Pt	21·5	·72	Brass	8·1	·43
Pb	11·3	·63	Fe	7·7	·40
Ag	10·5	·59	Zn	7·1	·40
Bi	9·9	·58	Al	2·6	·25
Ni	8·9	·48	Mg	1·7	·25
Cu	8·5	·45			

Thus the value of n/N increases with the density of the metal; the numbers given above are roughly proportional to the square root of the density; we see that even for the lightest metals the number of corpuscles receding from the surface is as much as one-quarter of the number of those approaching it. The preceding values of n/N are when the incidence of the cathode rays is normal; in this case Starke found that n/N did not depend upon the velocity of the incident rays. This result can only be approximately true, otherwise the numbers in the preceding table would apply to the β rays which are just rapidly moving cathode rays; the results for the β rays are however quite different. It is noteworthy that the value of n/N in this case seems to be determined by the density and not by the atomic weight of the metal, in the case of the β rays we have seen that the rays coming from the metal are determined by the atomic weight and not by the density.

200. The fact observed by Campbell Swinton (*l.c.*) that when the incidence is very oblique the reflector acquires a positive instead of a negative charge, has been carefully studied by Austin and Starke*, who have measured the charge received by the

* Austin and Starke, *Ann. der Phys.* ix. p. 271, 1902.

reflector for cathode rays incident at various angles; they find that the angle of incidence at which the charge received by the reflector changes from $-$ to $+$ depends on the material of which the reflector is made, the state of its surface and the velocity of the rays. With denser reflectors the change from $-$ to $+$ takes place at a smaller angle of incidence than it does with lighter reflectors; and, again, the smaller the velocity of the rays the smaller the critical angle. The amount of influence exerted by the nature of the metal, and the velocity of the rays, may be illustrated by the following numbers due to Austin and Starke. With a platinum reflector, and with cathode rays produced by a potential difference of 9000 volts, the critical angle of incidence was 60° ; with a copper reflector, and a potential difference of 8700 volts, the critical angle was 80° , and with a potential difference of 5000 volts, 70° . The positive potential to which the reflector is raised never exceeds a few volts.

201. Since, in some cases, the reflector receives a positive charge from the impact of the negatively electrified corpuscles, more corpuscles must leave the surface than arrive at it; it follows that the velocity of the receding corpuscles must, on the average, be less than that of the approaching ones, otherwise the energy emitted by the reflector would be greater than the energy received. Another reason for thinking that the velocity of the secondary rays is much smaller than that of the incident is that a positive potential of a few volts is sufficient to prevent them leaving the surface. Measurements of the velocity of the 'reflected' rays, by means of the deflection they experience in a magnetic field, have been made by Merritt*, Austin and Starke (*l.c.*), and Gehrcke†; both Merritt and Austin and Starke came to the conclusion that the velocity of the reflected rays was much the same as that of the incident; Gehrcke, however, by a very ingenious method showed that among the 'reflected' rays there were a large number whose velocities were considerably less than that of the incident rays. Gehrcke's method is represented in Fig. 101; K_1 and K_2 are two cathodes connected together and with the negative pole of an electrical machine; the rays from K_1 went straight from the cathode on to a fluorescent screen FF' , while those from K_2 fell

* Merritt, *Physical Review*, vii. p. 217, 1898.

† Gehrcke, *Ann. der Phys.* viii. p. 81, 1902.

on a magnesium reflector, the 'reflected' rays from which fell on the same screen. J_1 and J_2 are the coils for producing the magnetic

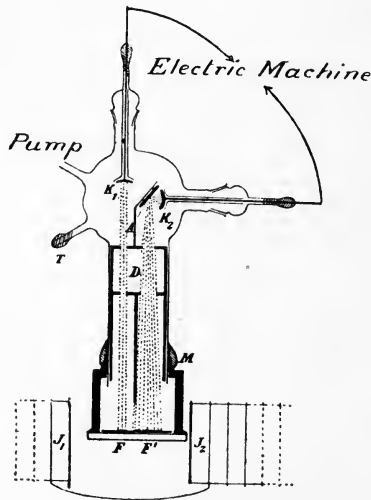

Fig. 101.

field. The appearance of the phosphorescence on the screen before and after the magnetic field was started is shown in Fig. 102.

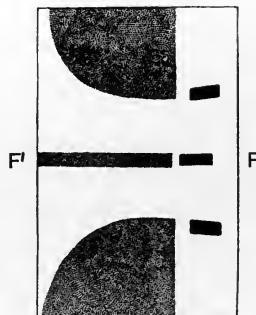

Fig. 102.

The middle patches F , F' represent the phosphorescence without a magnetic field due to the direct and reflected rays respectively; the patches above and below these represent the phosphorescence when the magnetic field was on, the upper and lower patches

corresponding to fields in opposite directions. It will be noticed that while the patch of phosphorescence, due to the direct rays, has not been sensibly broadened by the magnetic field, the narrow patch due to the 'reflected' rays has become a broad band, showing the presence of some rays much more easily deflected, and therefore moving more slowly than the incident rays. Since one of the boundaries of the reflected patch keeps in line with one of the direct patch, there must be some of the reflected rays which move with approximately the same velocity as the incident rays.

We conclude from this experiment that a surface struck by cathode rays emits secondary rays which on the average move more slowly than the primary ones. The ratio of the number of secondary to the number of primary rays is greater at oblique than at normal incidence. The 'reflection' of cathode rays at the surface of a solid seems in many respects analogous to the emission of corpuscles from a body illuminated by ultra-violet light. The corpuscles in the primary rays penetrate some little distance below the surface, ionising the molecules against which they strike; the secondary corpuscles produced in this way, and also some of the primary ones whose motion has been reversed by the collisions they have made with the molecules of the reflector, escape from the reflector and form the reflected cathode rays, which thus consists of particles originating in two distinct ways.

The path of a corpuscle which strikes the reflector obliquely will be nearer the surface than if it strikes the reflector normally, and thus the corpuscles liberated by it will have a shorter distance to travel before reaching the surface of the reflector and emerging from it, we should therefore expect the oblique rays to produce more reflected rays.

Lenard* has also investigated the effects of the incidence of cathode rays on metallic surfaces. The rays he used had velocities corresponding to a potential difference of 4000 volts as the maximum, and his results differ in some respects from those obtained by Austin and Starke who used rather faster rays. Lenard could not detect any rays coming from the surface with velocities comparable with those of the incident rays, but he obtained

* Lenard, *Ann. der Phys.* xv. p. 485, 1904.

a copious supply of very slow secondary rays; the velocity of these rays corresponded to that acquired by a fall through a potential difference of about 10 volts, and this as well as the amount of the secondary radiation was independent of the angle of incidence and of the state of polish of the surface; the amount of secondary radiation varied with the nature of the metal, aluminium giving the largest supply when tested by the brightness of the phosphorescence produced by the rays.

Scattering of Cathode Rays by the gas inside the tube.

202. Measurements of the scattering of cathode rays inside the discharge tube have been made by Kaufmann*, who employed the electrical method. The greatest potential differences employed was only about 7500 volts, so that the velocity of the rays in Kaufmann's experiments was very much less than in those of Lenard on the absorption of these rays (p. 382). The principle of the method used by Kaufmann was as follows. Consider a bundle of rays originally horizontal passing through the gas, then if N_0 is the number of corpuscles crossing a vertical plane AB in unit time, the number crossing a parallel plane CD at a distance x from AB will be $N_0\epsilon^{-bx}$, where b is by definition the coefficient of absorption; if e is the charge carried by a corpuscle the quantity of negative electricity entering the space between AB and CD in unit time is N_0e , the amount leaving it is $N_0e\epsilon^{-bx}$; hence if $ABCD$ is surrounded by a metallic cylinder the quantity of electricity received by the cylinder in unit time is $N_0e(1 - \epsilon^{-bx})$; thus, if we compare the charge received by the cylinder with that which passes through the end CD , we shall find $(1 - \epsilon^{-bx})/\epsilon^{-bx}$, from which we can deduce the value of b . Kaufmann in this way determined b for nitrogen, carbonic oxide, carbonic acid and hydrogen, at pressures ranging from about 1/50 to 1/28 of a millimetre of mercury and with potential differences from about 2500 to 7500 volts; he found that if V is the potential difference in the discharge tube in volts, p the pressure in millimetres of mercury, then for the same gas, within the limits of pressure and potential difference indicated, bV/p was constant; *i.e.* the absorption coefficient is proportional to the pressure and inversely proportional to the kinetic energy of the corpuscle. The values for the different gases are indicated in the following table:

* Kaufmann, *Wied. Ann.* lxi. p. 95, 1899.

Gas	bV/p	Molecular weight
H ₂	730	2
N ₂	5650	28
CO	6380	28
CO ₂	6830	44

The values of b do not follow those of the molecular weight as closely as the values determined by Lenard; one reason for this may be the greater velocities of the rays investigated by Lenard; we have seen (p. 378) that it is only for very rapidly moving cathode rays that we could expect Lenard's law to be strictly true; another reason may be that in the method used by Kaufmann the positive and negative ions produced by the primary rays by collision with the molecules of the gas might diffuse with different velocities to the conductors in the tube, so that part of the current measured in these experiments may be due to secondary ionisation.

The γ Rays.

203. The absence of any magnetic deflection of these rays and of any indication of a charge points to the conclusion that they are of the same character as Röntgen rays and do not consist of rapidly moving negatively charged particles. As these rays are very much more penetrating than ordinary Röntgen rays and as the importance of the 'scattering' compared with the loss of energy due to ionisation of the absorbing substance increases with the hardness of the rays, it is important to investigate the expression for the absorption of rays when scattering is taken into account. Let us consider the case of rays parallel to the axis of x passing through a plate of material bounded by planes at right angles to this axis. As these rays pass through the material they will be scattered, some of the scattered rays going forwards, others backwards; there will thus be two streams of γ rays in the plate, one stream travelling in the direction of the incident rays the other in the opposite direction. Let I be the energy passing at a distance x from the point of the plate through unit area in unit time in the first of these streams, R the corresponding amount for the second stream. If a fraction βdx of the energy of the rays is

absorbed when they travel through a distance dx , and if hdx is the fraction of the energy scattered, then we have

$$\begin{aligned}\delta I &= \frac{1}{2}h(I + R) dx - \beta I dx, \\ -\delta R &= \frac{1}{2}h(I + R) dx - \beta R dx,\end{aligned}$$

or

$$\begin{aligned}\frac{dI}{dx} + \beta I &= \frac{1}{2}h(I + R), \\ -\frac{dR}{dx} + \beta R &= \frac{1}{2}h(I + R).\end{aligned}$$

To solve these equations put $I = A\epsilon^{\lambda x}$, $R = B\epsilon^{\lambda x}$; substituting these values in the preceding equations we get

$$\begin{aligned}(\lambda + \beta - \frac{1}{2}h)A &= \frac{1}{2}hB, \\ (-\lambda + \beta - \frac{1}{2}h)B &= \frac{1}{2}hA,\end{aligned}$$

hence $(\beta - \frac{1}{2}h)^2 - \lambda^2 = \frac{1}{4}h^2$,

hence $\lambda = \pm \sqrt{\beta(\beta - h)}$;

we have if $\lambda = \sqrt{\beta(\beta - h)}$,

$$I = A\epsilon^{\lambda x} + A'\epsilon^{-\lambda x},$$

$$R = \frac{\lambda + \beta - \frac{1}{2}h}{\frac{1}{2}h} A\epsilon^{\lambda x} + \frac{\beta - \lambda - \frac{1}{2}h}{\frac{1}{2}h} A'\epsilon^{-\lambda x}.$$

To determine A and A' we have the conditions that when $x = 0$, $I = I_0$, the intensity of the incident rays, and when $x = d$, d being the thickness of the plate, $R = 0$. Making these substitutions we find

$$\begin{aligned}A &= I_0 \left/ \left(1 - \frac{(\beta - \frac{1}{2}h + \lambda)}{\beta - \frac{1}{2}h - \lambda} \epsilon^{+2\lambda d} \right) \right., \\ A' &= I_0 \left/ \left(1 - \frac{(\beta - \frac{1}{2}h - \lambda)}{\beta - \frac{1}{2}h + \lambda} \epsilon^{-2\lambda d} \right) \right.,\end{aligned}$$

so that I , the intensity of the rays after passing through the plate, is given by the equation

$$I = \frac{2I_0\lambda}{(\beta - \frac{1}{2}h + \lambda)\epsilon^{\lambda d} - (\beta - \frac{1}{2}h - \lambda)\epsilon^{-\lambda d}} \dots\dots\dots(1).$$

The intensity of the 'reflected' rays is got by putting $x = 0$ in the expression for R , doing this we find that the intensity is given by the equation

$$R = \frac{I_0 h (\epsilon^{\lambda d} - \epsilon^{-\lambda d})}{2 \{ (\beta - \frac{1}{2}h + \lambda)\epsilon^{\lambda d} - (\beta - \frac{1}{2}h - \lambda)\epsilon^{-\lambda d} \}} \dots\dots\dots(2).$$

From these expressions we see that the intensity of the rays after passing through the plate is not given by an exponential expression, *i.e.* is not proportional to $\epsilon^{-\mu d}$; if the coefficient of absorption is calculated on the basis of such a law the values of the coefficients obtained will vary with the thickness of the plate, even though the primary radiation is homogeneous. Rutherford showed that the value of the coefficient of absorption varied with the thickness of the layer; this is shown in the following table where column (I) gives the coefficient of absorption calculated on the basis of the exponential law for the first 2.5 mm. of substance traversed, column (II) for the thickness 2.5 to 5 mm., column (III) for 5 to 10 mm. and (IV) from 10 to 15.

Substance	I	II	III	IV
Mercury	·726	·661	·538	·493
Lead	·641	·563	·480	·440
Zinc	·282	·266	·248	·266

The coefficients decrease with the thickness of the substance travelled. This is usually attributed to the primary radiation being heterogeneous, the more absorbable portions being weeded out first; it would however also arise from the erroneous assumption of an exponential law, and although it is probable from other reasons that the γ radiation from radium is heterogeneous, we cannot without further calculation prove this from experiments such as those represented in the table.

An interesting special case of (1) is when there is no absorption of energy but only scattering, in this case $\beta = h$ and $\lambda = 0$, and (1) becomes

$$I = \frac{I_0}{1 + \frac{1}{2}hd}$$

Thus the intensity of the transmitted radiation falls off much less rapidly than if it were expressed by an exponential law.

We see from p. 326 that when the radiation from one corpuscle does not interfere with that from a neighbouring one

$$h = \frac{8\pi}{3} \frac{Ne^4}{m^2}$$

where N is the number of corpuscles in unit volume, e the charge and m the mass of a corpuscle; putting

$$e/m = 1.7 \times 10^7, \quad e = 10^{-20},$$

and assuming that the number of corpuscles in an atom is equal to the atomic weight, we find that, if σ is the density of the substance,

$$h = .25\sigma,$$

so that

$$I = \frac{I_0}{1 + .125\sigma d} \dots\dots\dots (3).$$

Thus if there were no absorption of energy by ionisation, &c. it would take a layer of water 800 cm. thick to reduce the intensity to 1% of its original value. The scattering gives a finite limit to the penetrating power of any radiation analogous to Röntgen rays. The larger the ratio of the energy scattered to the energy spent in ionisation the more will the absorption of the rays depart from the exponential law.

If the electric forces in the pulses constituting the γ rays are not uniform in direction from back to front but are positive in one part of the pulse, negative in another, then if the corpuscles in the atoms over which the pulse is travelling are so closely packed that the pulse may cover two corpuscles A and B simultaneously, A being in the positive, B in the negative part of the pulse, then since the accelerations of A and B are of opposite signs the magnetic force due to their motion will be in opposite directions. Since these electric and magnetic forces due to A and B tend to neutralize each other the energy radiated from the two combined will be less than that from either separately, the energy absorbed, *i.e.* the value of h , will be less than the value just given, and the penetrating power of the radiation greater than indicated by the expression (3).

We shall show later that in consequence of the emission of radiation from a moving charged body, such a body, when acted upon by a force Xe , does not start at once with an acceleration Xe/m , where m is the mass of the body. The acceleration is at first zero and gradually increases until it reaches the limiting value Xe/m ; if this initial stage, whose duration only depends on the charge and mass of the charged body, occupies an appreciable part of the time taken by the Röntgen pulse to pass over the

body, the amount of energy radiated would be considerably less than that given by the investigation in § 161, where the acceleration was assumed to have the maximum value Xe/m during the whole of the time the pulse was passing; thus for very thin pulses the value of h would be considerably less than that given by this investigation, and therefore the absorption of the rays less than that given by the expression (3).

The investigations that have been made of the absorption of the γ rays, show that these pulses are so thin that the time taken by them to pass over a corpuscle, or if the pulses consist of alternations of sheets of positive and negative electric force the time of transit of one of these sheets is comparable with the time taken for the acceleration to reach its maximum value. For equation (3) is equivalent when σd is small to $I = I_0 \epsilon - \cdot 125 \sigma d$; thus the absorption coefficient λ calculated in the usual way would be $\cdot 125 \sigma$, so that $(\lambda/\text{density})$ would be $\cdot 125$. The following table taken from a paper by Wigger (*Jahrbuch des Radioaktivität*, II. p. 391, 1906) shows that for the γ rays from radium the absorption is much less than that given by this result, $\lambda/\text{density}$ being constant and about $\cdot 02$ instead of $\cdot 125$.

Absorption of γ rays from radium bromide.

Observer...	RUTHERFORD. Absorption by thin metal sheets	M ^c CLELLAND. Absorption by plates 1·25 cm. thick, the rays having previously passed through 8 mm. of lead	WIGGER. Absorption after rays have passed through 28 mm. of lead
Material	$(\lambda/\text{density})$	$(\lambda/\text{density})$	$(\lambda/\text{density})$
Mercury...	·068	·036	·0208
Lead	·068	·037	·0213
Tin	·052	—	—
Copper ...	·035	—	·0226
Iron	·039	—	·0211
Zinc	·039	·033	·0201
Aluminium	—	·038	·0208
Sulphur...	—	—	·0202

The thinner the pulse, the smaller should be the value of $(\lambda/\text{density})$.

CHAPTER XIII.

THE POWER OF THE ELEMENTS IN GENERAL TO EMIT IONISING RADIATION.

204. THE radiations discussed in the last chapter were those emitted by a few elements of which two only, uranium and thorium, were known before the discovery of radio-activity, the others, radium, polonium and actinium were brought to light by the study of this property. The question arises, is the property of emitting radiations of this character confined to these elements, or is it possessed, though to a very much smaller extent, by the elements in general? Of late years a considerable amount of attention has been given to this question, resulting in the collection of a large amount of evidence in favour of the view that this property is possessed to some extent by all bodies, although there seems to be a great gap between the amount of radiation emitted by the least active of the recognised radio-active elements and the most active of the others.

All the investigations on the radiation emitted by ordinary matter have been made by the electrical method, by measuring the amount of ionisation in a volume of gas placed in the neighbourhood of the body under investigation. We have seen (p. 6) that gases enclosed in metallic vessels are ionised to a slight extent and that the amount of ionisation is, in small vessels, proportional except in the case of hydrogen to the density of the gas, we have seen too in the last chapter that the ionisation produced by the radiation from radio-active substances follows exactly the same law.

Rutherford and Cooke* and McClennan† have shown that part of the ionisation of the gas inside a closed vessel is due to

* Rutherford and Cooke, *Physical Review*, xvi. p. 183, 1903.

† McClennan, *Physical Review*, xvi. p. 184, 1903.

radiation coming from outside the vessel, for they found that when the closed vessel is surrounded by thick lead screens the ionisation in the gas inside the vessel is very considerably reduced. Cooke* found however that there was a limit to the diminution that could be produced in the ionisation by screening; for however thick the lead screens were made the ionisation inside the vessel never sank to less than about one-third of the amount when the screens were removed. Experiments have been made by Cooke† and also by Wood‡ to find out whether this external radiation which can be screened off enters the vessel from above, below or sideways. Screens were arranged so as to cut off the radiations travelling in these directions separately, but no well marked differences in the amount of radiation travelling in different directions were established, the external radiation seems to be fairly uniformly distributed in all directions.

A further step was made by Strutt§, M^cClennan and Burton|| and Cooke¶, who showed that the amount of ionisation inside a closed vessel varied with the nature of the material of which the vessel was made and this result was subsequently confirmed by Righi**. Speaking generally we may say that, for vessels of the same size and shape, lead vessels give the largest ionisation, tin and iron considerably less, and zinc, aluminium and glass least of all; the relative amounts however depend, as we shall see later, to a considerable extent upon the shape and size of the vessel. This variation in the amount of ionisation with the nature of the walls of the vessel occurs whether or not the external radiation is screened off.

Two ways suggest themselves as to how the influence of the walls of the vessel on the ionisation might arise. In the first place ions might be produced by chemical action between the gas and the metal; we shall see later that chemical action may result in the production of free ions; or again ions might slowly diffuse out from the metal into the gas, such as seems to occur when a

* Cooke, *Phil. Mag.* 6. vi. p. 403, 1903.

† Cooke, *Phil. Mag.* 6. vi. p. 403, 1903.

‡ Wood, *Phil. Mag.* 6. ix. p. 550, 1905.

§ Strutt, *Nature*, Feb. 19, 1903.

|| M^cClennan and Burton, *Nature*, Feb. 26, 1903.

¶ Cooke, *Nature*, April 2, 1903.

** Righi, *Il Nuovo Cimento*, Jan. 1905.

metal is heated to redness when positive ions are given out, originating perhaps from gases absorbed by the metal. This view is however untenable, for Campbell* has shown that the ionising effect of a metal can penetrate thin aluminium foil; it is also rendered extremely improbable by the fact that the ionisation in different gases depends only upon the density of the gas and not upon its chemical properties. The other way of explaining this variation in the ionisation is to regard it as due to radiation coming from the metal itself, and the question then arises whether the radiation comes from the lead or other metal used for the vessel, or whether it is due to a radio-active impurity in the metal. This is a point that requires the most careful attention, for the activity of the radio-active substances, such as radium, so enormously transcends that of the metal, that the presence of an amount of radium so small as to be absolutely beyond detection by any chemical or spectroscopic analysis would produce amounts of ionisation far greater than those actually observed.

Now radium and its emanation are very widely diffused substances, thus for example I observed that air which had bubbled through Cambridge tap-water was highly conducting† and the conductivity was traced to the presence in the water of small quantities of radium emanation. I also found traces of radium in the most diverse substances such as various sands, gravels, clays and even in some specimens of wheaten flour. The amount of radium however in different specimens varied very capriciously. Elster and Geitel‡ have detected the presence of radium in the soil, and Strutt§ has lately made a very exhaustive examination of a large number of rocks in all of which he found appreciable quantities of radium. It is evident therefore that radium in minute quantities is very widely distributed and that it is necessary to eliminate this source of radio-activity before we can establish the radio-activity of ordinary matter. Another source of error, affecting experiments made in laboratories where radium has been used, is that the walls and contents of the building get contaminated with a deposit of one of the transformation products of radium and acquire radio-activity in this way; to

* Campbell, *Phil. Mag.* 6. ix. p. 531, 1905; 6. xi. p. 206, 1906.

† J. J. Thomson, *Phil. Mag.* 6. [4], p. 352, 1902.

‡ Elster and Geitel, *Physik. Zeitschr.* iv. p. 526, 1903.

§ Strutt, *Proc. Roy. Soc.* lxxvii. p. 472, 1906.

guard against this effect it is necessary to scrape the old surface from all vessels used for experiments of the kind we are discussing and to work with virgin surfaces.

The evidence against the ionisation observed in closed vessels arising from radio-active impurities may be summarized as follows.

Different observers using quite different samples of the various metals agree in the order in which they place the various metals with respect to this power of emitting radiation. In comparing the results of experiments of this kind regard must be had to the shape and size of the vessel as well as of the material of which it is composed: the radiation given out by the walls of the vessel is of two kinds, one very penetrating, the other easily absorbed: the ionisation due to the former kind of radiation is proportional to the volume of the vessel, while that due to the absorbable kind is proportional to the area of the surface: thus the ratio of the ionisations in equal vessels made of different materials will depend upon the proportion between the ionisation due to the surface and that due to the volume, and hence upon the shape and size of the vessel.

Experiments have been made by Strutt* and Wood† in which the vessels were of the same size and shape, the results for the relative amounts of ionisation are given in the following table:

Material	Ionisation	
	Strutt	Wood
Lead	4·2	5·2
Tin	4·4 to 6·3	4·7
Aluminium	2·7	2·7
Zinc	2·3	2·3

If radium were present as an impurity we should expect to find large variations in the effects produced by different samples of the same material, of the same order as those we do find in different specimens of water or soil. Again if radium were present in the metals we should expect to find also its emanation. Many

* Strutt, *Phil. Mag.* 6. v. p. 680, 1903.

† Wood, *Phil. Mag.* 6. ix. p. 550, 1905.

attempts have been made to detect this emanation but without success. I have dissolved large quantities of the salts of different metals in distilled water, and left the solutions standing for months so as to give time for any emanation to come out, but on bubbling air through the solution no trace of emanation could be obtained, and attempts to detect it by boiling the water were equally unsuccessful. Campbell* has carried this test still further, he dissolved in nitric acid 1500 grammes of the same lead which he had used for the closed vessel in which the ionisation test was made, but on bubbling air through the solution after it had stood for some time no trace of emanation could be detected.

On the supposition that the ionisation in the lead vessel was due to radium, the amount of radium in the 1500 grammes of lead could be calculated, and hence the amount of emanation it would give off; this calculation showed that this quantity of emanation would have increased the leak in the testing chamber 500-fold; as no measurable increase was produced the experiment seems conclusive against the hypothesis that the ionisation produced by the lead was due to the presence of a small quantity of radium.

Campbell†, by comparing the ionisation produced by the metals with that produced by their salts, has shown that the emission of radiation is an atomic property, he has also shown that samples of the same salt prepared by different methods produce the same effect; this is very strong evidence against their activity being due to an impurity.

205. Another test as to whether or not the activity is due to an impurity is the following: if the effects were due to an impurity, say radium, the *quality* of the radiation given out by all metals would be the same. Campbell‡ has made a very elaborate investigation on this point. The general principle of his method is as follows. Suppose we have a box two sides of which are parallel plates of the substance to be investigated arranged so that the distance between them can be varied continuously, the other side of the box being made of a substance whose radio-activity is small, a series of measurements of the ionisation inside the box are made, starting with the two plates close together and gradually

* Campbell, *Phil. Mag.* 6. xi. p. 206, 1906.

† Campbell, *Proc. Camb. Phil. Soc.* xiii. p. 282, 1906.

‡ Campbell, *Phil. Mag.* 6. xi. p. 206, 1906.

increasing the distance between them. The radiation emitted by the plates is of two kinds, one kind a penetrating radiation which can travel across the greatest distance separating the plates without appreciable absorption, the other kind an easily absorbable radiation which gets stopped after travelling through a few centimetres of air. The ionisation due to the penetrating radiation is proportional to the distance between the plates and will be graphically represented by a straight line passing through the origin. The ionisation due to the second kind of radiation will, when the plates are close together, be proportional to the distance between them, but as the distance between the plates increases the rate at which the ionisation increases with the distance will fall off, and when the distance between the plates is greater than the radiation can penetrate the ionisation will become independent of the distance.

If this radiation has the same properties as the α radiation, *i.e.* if the ionisation due to it is uniform for a distance l and then ceases, we can easily show that the amount of ionisation when the plates are separated by a distance x is equal to

$$\mu N \frac{x}{l} \left(l - \frac{x}{2} \right)$$

when x is less than l , and to $\frac{1}{2}\mu Nl$ when x is greater than l . Here N is the number of rays emitted by the plate, μ the number of ions produced by each ray per unit length of path. The ionisation due to the penetrating radiation may be represented by px .

Hence if y is the ordinate of the curve representing the ionisation when the plates are separated by a distance x , we have

$$y = \mu N \frac{x}{l} \left(l - \frac{x}{2} \right) + px$$

when x is less than l , and

$$y = \frac{1}{2}\mu Nl + px$$

when x is greater than l .

Thus for large values of x the curve (Fig. 103) becomes a straight line. If this line cuts the axis of y in N , ON will represent the total ionisation due to the absorbable rays. If the tangent to the curve at the origin cuts this line in Q then the abscissa of Q is equal to $l/2$ and is therefore a measure of the

penetrating power of the absorbable radiation. In practice corrections have to be applied to these expressions to allow for the

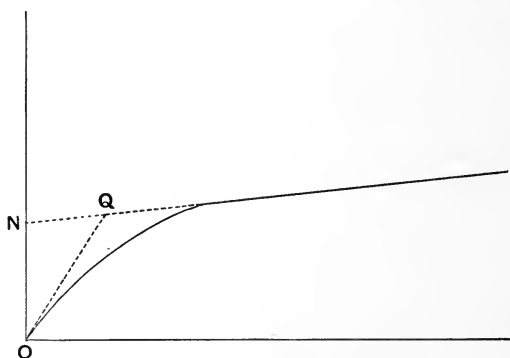

Fig. 103.

influence of the sides and the obliquity of the rays, for these we refer the reader to Campbell's paper.

If experiments of this kind are made (1) with the box shielded from external radiation by thick lead screens, (2) when unshielded, and curves drawn for the two sets of experiments, then a third curve, whose ordinates are the differences of the ordinates of (1) and (2), will represent the effect of the external radiation. If this curve is a straight line the radiation arising from the external radiation is entirely of a penetrating character; this is found to be the case when the box is made of lead or aluminium, for most metals however the curve resembles that given in Fig. 103, showing that the penetrating radiation when passing through the metal sets up by an easily absorbable secondary radiation. The results obtained by Campbell are expressed by the following table.

s is the number of ions produced per second by the intrinsic absorbable radiation from 1 sq. cm. of the surface of the metal, when totally absorbed in air.

s' the number of ions produced per second by the easily absorbable secondary radiation from 1 sq. cm. of the metal under the conditions of the experiment when the radiation is totally absorbed in air.

V the number of ions produced in 1 c.c. per second by the penetrating radiation from the box.

V' the number of ions produced in 1 c.c. per second by the external radiation and the penetrating secondary radiation excited by it.

a the distance the absorbable intrinsic radiation can travel in air without losing its ionising power.

λ the absorption coefficient of the easily absorbable secondary radiation.

Material	s	s'	V	V'	a	λ
Lead 1	270	0	10.2	14.2	12.0}	
					12.5}	
Lead 2	260	0	13.4	26.3	12.5}	
					12.0}	
Copper 1	103	160	2.2	22.0	9	0.6
Copper 2	110	91	8.1	27.4	9	0.5
Aluminium ...	117	0	14.8	17.0	6.0}	
					6.5}	
Tin	144	156	3.1	18.9	9	0.5
Silver	146	146	25.5	17.0	8.5	0.9
Platinum	74	411	17.3	14.1	12.0	0.4
Gold.....	78	169	10.4	16.8	10.0	0.6
Zinc.....	72	51	15.4	16.8	10.0	0.5
Iron.....	119	124	12.3	10.5	13.0	0.5

It will be seen that the quality of the radiation, as determined by the value of a , varies considerably from metal to metal, the value of a found for these metals is in most cases considerably greater than 6.5, the value for the α radiation from radium.

Campbell has been able to detect the ionisation due to the radiation from metals after the radiation has passed through thin aluminium foil, and he has detected in this way the radiation from non-conductors such as sulphur for which the previous method can not be used.

If gases share this property of giving out radiation then the radiation of the gases themselves should produce no inconsiderable effect when the linear dimensions of the vessel are large compared with the quantity a given in the preceding table. For when, as is the case with this intrinsic radiation, the radiation from a cubic centimetre of gas and the absorption of the radiation are both proportional to the number of molecules of the substance per cubic centimetre, it is easy to show that the stream of intrinsic radiation passing through unit area due to a volume of the

substance, is independent of the number of molecules per cubic centimetre, provided the linear dimensions of the substance are large compared with the distance the radiation can travel through it without being absorbed. Hence when the linear dimensions of the vessel are large compared with the value of a for the radiation emitted by the gas, the stream of radiation due to the gas will be comparable with that emitted by a slab of liquified or solidified gas and thus unless the radiation emitted per molecule were much smaller for the gas than for the metal the stream of radiation from the gas would be comparable with that coming from the sides of the vessel. When the volume of the gas is large enough for this to be the case the ionisation due to the gas radiation will be proportional to the volume and so in an investigation like Campbell's would affect the value assigned to the penetrating radiation from the walls of the vessel.

With regard to the nature of the easily absorbed radiation Campbell has shown that it does not consist of negatively charged particles. For if it consisted of such particles we could from its penetrating power deduce the velocity of the particles and hence the potential difference which would be sufficient to stop them if they moved against the electric field. Campbell made the radiation from metals pass through such a field and found that the radiation emerged from the field without any appreciable diminution in intensity.

Variations in the ionisation inside a closed vessel.

206. When air is shut up in a closed vessel the ionisation in the air is subject to curious fluctuations and changes, the origin of which is not yet fully understood. Thus for example Campbell and Wood, working in the Cavendish Laboratory, have shown that in an unshielded vessel the ionisation shows regular diurnal variations, having a maximum in the early morning. The most obvious explanation of this is that there is a similar variation in the amount of radium emanation in the lower regions of the atmosphere. Dike has verified this hypothesis by showing that the induced radio-activity deposited on a negatively electrified surface in the Cavendish Laboratory has well marked diurnal variation, with a pronounced maximum in the early morning. Diurnal variations in the amount of induced radio-activity have also been observed by Simpson* in Lapland. If the emanation

* Simpson, *Phil. Trans.* cvv. p. 61, 1906.

from radium present in the atmosphere diffuses out of the soil, the quantity near the surface would depend greatly upon vertical currents in the atmosphere and we should expect to get the greatest accumulation of emanation near the surface when the upward convection currents have their minimum value. It is remarkable that the gradient of electrical potential in the air gives maxima at the same time. Another very remarkable result is that the ionisation inside a closed vessel goes on increasing for several weeks and often rises to a value two or three times the value obtained when the air was fresh. At first indeed there may be a temporary diminution in the ionisation, as was observed by McClellan and Barton, due probably to the decay of radium emanation present in the air when it was first enclosed, the subsequent increase is more obscure. Elster and Geitel have, as we have seen, observed abnormally strong ionisation in cellars and caves in which the air is stagnant, but as bricks and the walls of the cave contain radium this is what we should expect from the slow diffusion of the radium emanation from the walls into the air. In the case of closed metallic vessels, however, the cause is more obscure as no emanation has been detected from these metals even when the time allowed for any emanation there might be to accumulate is much longer than that necessary to enable the ionisation in a closed vessel of the metal to double or treble in value. When once the ionisation has risen to a high value a large quantity of fresh air has to be sent through the vessel before the ionisation sinks to its normal value, as if the cause of the increase stuck with some persistency to the walls of the vessel. The fact that the saturation current reaches these high values shows that the increase is not due to an accumulation of ions but to an increase in the rate at which they are produced. Is it possible that these additional ions are produced by some chemical action between the gas and the walls of the vessel and that this action has, like some other such actions, *e.g.* the combination of hydrogen and chlorine, a period of so-called induction, *i.e.* that it takes a considerable time before the action goes on at the normal rate?

The subject of this chapter is treated very completely by Campbell in his valuable paper in the *Jahrbuch der Radioaktivität*, Bd. 2, p. 434, 1906.

CHAPTER XIV.

IONISATION DUE TO CHEMICAL ACTION, THE BUBBLING OF AIR THROUGH WATER, AND THE SPLASHING OF DROPS.

Electrification due to Chemical Action.

207. IN many cases of chemical combination in which gases take part we get electrification of the gas; Pouillet* was the first to discover an example of this effect; he found that while a carbon cylinder is burning, the air round the cylinder is positively while the cylinder itself is negatively electrified. Lavoisier and Laplace† showed that the same effect occurs with glowing coal. Pouillet‡ also found that when a jet of hydrogen burns in air, there is positive electrification in the surrounding air, negative electrification in the hydrogen. Lavoisier and Laplace§ found that when hydrogen is rapidly liberated by the action of sulphuric acid on iron there is considerable positive electrification in the gas; in this case the interpretation of the results is made difficult by the electrical effects produced by the bubbling of the gas through the liquid, these we should expect to be very considerable as the gas is liberated in small bubbles, which is the most favourable case for getting a considerable electrification in a given volume of air. This and other cases of electrification by chemical action have been investigated by Enright|| and by Townsend¶; the latter showed that the hydrogen produced by the action of sulphuric acid on iron retained its electrification

* Pouillet, *Pogg. Ann.* ii. p. 422.

† Lavoisier and Laplace, *Phil. Trans.* 1782.

‡ Pouillet, *Pogg. Ann.* ii. p. 426.

§ Lavoisier and Laplace, *Mémoires de l'Académie des Sciences*, 1782.

|| Enright, *Phil. Mag.* v. 29, p. 56, 1890.

¶ Townsend, *Proc. Camb. Phil. Soc.* ix. p. 345, 1898; *Phil. Mag.* v. 45, p. 125, 1898.

after passing through tubes filled with tightly packed glass-wool, thus proving that the electrification could not be carried by the coarse spray produced by the bursting of the bubbles, as this is stopped by the wool. Townsend also showed that when chlorine is liberated by the action of hydrochloric acid on manganese dioxide the chlorine has a strong positive electrification; and that the oxygen produced by heating potassium permanganate carries with it a strong positive charge.

Townsend has shown that gases liberated by electrolysis carry with them considerable charges of electricity. Thus the hydrogen evolved by the electrolysis of sulphuric acid at temperatures as high as 40° or 50°C. has a considerable positive charge; the charge on the oxygen is exceedingly small in comparison, it is also positive. When these gases are liberated by the electrolysis of a solution of caustic potash the electrification on the hydrogen is very small, while the oxygen has a much larger negative charge the amount of which rapidly increases with the temperature; the nature of the electrode too has a considerable influence on the amount of electrification which comes off in the gas. The interpretation of these results, like those of the evolution of gases by the action of acids on metals, is made difficult by the electrical effects produced by the bubbling of the gases through the liquid. Kusters*, who has also investigated this subject, ascribes most of the electrification to the bubbling.

Townsend† found that these electrified gases possess the remarkable property of producing a cloud when they pass into a vessel containing aqueous vapour; this cloud is produced even when the air in the vessel is far from saturated with moisture, and does not require any lowering of temperature such as would be produced by the expansion of the air in the vessel. Townsend found that when the gas liberated by electrolysis was not charged no cloud was produced, and that the weight of cloud produced, other circumstances being the same, was proportional to the charge in the gas. Clouds are produced, however, in some cases in which no charges are perceptible; thus H. A. Wilson‡ has shown that if solutions of salts or acids, or even of sugar or glycerine, are sprayed

* Kusters, *Wied. Ann.* lxi. p. 12, 1899.

† Townsend, *Proc. Camb. Phil. Soc.* ix. p. 345, 1897.

‡ H. A. Wilson, *Phil. Mag.* v. 45, p. 454, 1898.

by a Gouy sprayer into a vessel and the air from this vessel passed through sulphuric acid a cloud is formed when this air emerges into a damp atmosphere. The cause of this seems fairly clear, although the passage through the sulphuric acid may rob the drops of the solution of their water, the acid or salt in the drop is carried along with the air through the sulphuric acid; when this emerges into the moist atmosphere the water condenses round the salt or acid and forms a drop of the solution, thus the drops in the cloud are not pure water, but solutions, and as the vapour pressure for these solutions is smaller than that for pure water the drops do not evaporate, even although the atmosphere is not saturated with moisture. Meissner* has also described clouds not accompanied by electrification which are produced when air containing ozone is passed through a solution of potassium iodide: these can be explained in a similar way by supposing that the ozone acting on the potassium iodide produces some substance which readily dissolves in water when it comes into contact with it. I think that a similar explanation may hold for the clouds produced by the electrified gas, for the carriers of the electricity are evidently complex bodies of very considerable size, since Townsend† found that the velocity of these carriers under a potential gradient of 1 volt per cm. was only about $1/8000$ of the velocity under the same electric field of the ions produced by the action of the Röntgen rays on the gases: if we suppose that these systems can dissolve in water like an acid or salt and lower the vapour pressure, the process by which the cloud is formed would be the same as that in H. A. Wilson's experiment.

Townsend measured the rate of fall, the weight of the cloud, and the amount of electrification carried by it; the first of these measurements gives the size of a drop, the second the number of drops, and the third the charge on a drop; he found, assuming each drop to be charged, that the magnitude of the charge on the carrier of the electricity in electrolytic oxygen was about 5.1×10^{-10} electrostatic units.

Bloch‡ has also measured the velocity in the electric field of the ions produced when hydrogen is evolved by the action of hydro-

* Meissner, *Jahresber. f. Chem.* 1863, p. 126; see also Townsend, *Proc. Camb. Phil. Soc.* x. p. 52, 1899.

† *Ib.* ix. p. 345, 1897.

‡ Bloch, *Ann. de Chimie et de Physique*, [8], iv. p. 25, 1905.

chloric acid on zinc, when CO_2 is prepared from marble and hydrochloric acid, and when oxygen is prepared by heating potassium permanganate, he found that the velocity for a potential gradient of a volt per centimetre was in all cases of the order 1/100 mm. per second. From the equation

$$X = 6\pi\mu aV,$$

where V is the velocity acquired by a sphere of radius a when moving under the action of a force X through a fluid having viscosity μ , we find, putting $V = 10^{-3}$, $\mu = 2 \times 10^{-4}$, $X = 3 \times 10^{-10} \times (1/300)$, that $a = 2.5 \times 10^{-7}$, so that the size of these carriers is much larger than that of a single molecule.

Ionisation produced by the oxidation of phosphorus.

208. The case of ionisation by chemical action which has been most closely studied is that of the oxidation of phosphorus. Air which has passed over phosphorus at not too low a temperature has the power of discharging both positively and negatively electrified bodies. This fact was known to Matteucci*, the phenomenon was also investigated by Naccari†, and Elster and Geitel‡ and was subsequently discovered independently by Shelford Bidwell§; of late years it has been the subject of investigations by Barus||, Schmidt¶, Harms**, and Bloch††. Barus made experiments to see if the ionising properties of the phosphorised air could be exerted through thin films of various materials, the only films through which he could get an appreciable effect were those made of thin tissue paper, and here the effect seemed to make its way through the pores rather than through the material itself, as on oiling the paper to stop up the pores the transmission ceased. Barus found that the air which had passed over phosphorus was very active as a cloud producer. If hydrogen is passed over phosphorus it does not become a conductor of electricity.

* Matteucci, *Encyclopædia Britannica* (1855 edition), viii. p. 622.

† Naccari, *Atti della Scienze de Torino*, xxv. p. 252, 1890.

‡ Elster and Geitel, *Wied. Ann.* xxxix. p. 321, 1890.

§ Shelford Bidwell, *Nature*, xlix. p. 212, 1893.

|| Barus, *Experiments with ionised air*, Washington, 1901.

¶ G. C. Schmidt, *Ann. der Phys.* x. p. 704, 1903.

** Harms, *Phys. Zeitschr.* iv. p. 111, 1902.

†† Bloch, *Ann de Chemie et de Physique*, [8], iv. p. 25, 1905.

Recent experiments made by Harms and Bloch have proved that the conductivity of the air which has passed over phosphorus is due to the presence of ions in the gas. Thus Bloch has shown that the conductivity can be taken out of the phosphorised air by making it pass through a strong electric field, a property characteristic of an ionised gas.

Bloch and Harms have shown that the current through the phosphorised air can be saturated but that in consequence of the inertness of the ions it requires a very intense field to drive all the ions to the electrodes. Bloch determined the velocity of the ions under an electric field and showed that, as in all known cases when the ions are produced by chemical action, the mobility of the ions was very small compared with that of ions produced by Röntgen rays, the velocity of the ions in the phosphorised air being for the same electric field only about 1/1000 of that of ions produced by Röntgen rays; this shows that the ions in the phosphorised air are of very considerable size having radii comparable with 10^{-6} cm. Bloch has also determined the value of α , the coefficient of recombination, for the ions in the phosphorised air and finds that this too is only about one-thousandth part of α for the ions produced by Röntgen rays. All the properties of the phosphorised air indicate that the ions in it are some oxides of phosphorus collected around charged nuclei; the production of a cloud when the air comes into contact with damp air is quite in accordance with this view, as these oxides are soluble in water and would thus lower its vapour pressure and produce condensation.

Ozone is produced when oxygen passes over phosphorus, but Goekel* has shown that the ozone may be absorbed without destroying the conductivity.

Both Harms and Bloch have shown that the number of ions produced when oxygen passes over phosphorus is very small in comparison with the number of oxygen atoms which enter into combination with the phosphorus.

Elster and Geitel † have shown that the conductivity produced by passing air over sulphur even at a high temperature is exceedingly small compared with that produced by phosphorus.

* Goekel, *Phys. Zeitschr.* iv. Aug. 15, 1903.

† Elster and Geitel, *Wied. Ann.* xxxix. p. 321, 1890.

Conductivity produced by Hydration.

209. Le Bon* has shown that the hydration and dehydration of certain salts produce conductivity in the surrounding gas. The most conspicuous case is that of sulphate of quinine, when sulphate of quinine is heated above a certain temperature and then allowed to cool, the quinine phosphoresces and the air over the salt becomes a conductor of electricity. This seems to be a case of ionisation by chemical action and not the emission of ionising radiation from the sulphate, for Miss Gates†, who has made many experiments on this subject, found that the effect on the air disappeared if the sulphate were covered with the thinnest aluminium foil procurable. Miss Gates, and later Kalähne‡, found that the current of electricity from the quinine through the air was greater when the quinine was positively, than when it was negatively charged, and that the difference was greater when the conductivity was due to hydration than when it was due to dehydration. This result indicates an excess of positive ions in the air.

When the water of crystallisation is driven off salts by raising them to a high temperature there is in many cases a production of ions.

Another very interesting case of the production of ions is that discovered by Beattie§ and which has also been investigated by Garrett and Willows||. Beattie found that if a mixture of sodium chloride and iodine is sprinkled over a metal plate and the plate heated to a temperature somewhat over 300° C. large quantities of positive ions and smaller quantities of negative ones are given off by the salt, the number of these ions increases rapidly as the temperature increases. This and similar effects have been investigated by Garrett and Willows; they find that the ionisation observed by Beattie is due to the formation and subsequent dissociation of the iodide of the metal of which the plate is composed. Heating $ZnCl_2$ or ZnI_2 in platinum vessels they find that these salts at temperatures above 350° C. give off large quantities of ions, the rate increasing rapidly

* Le Bon, *Compt. Rend.* cxxx. p. 891, 1900.

† Miss Gates, *Phys. Rev.* xviii. p. 135, 1904.

‡ Kalähne, *Ann. der Phys.* xviii. p. 450, 1905.

§ Beattie, *Phil. Mag.* [5], xlvi. p. 97, 1899; [6] i. p. 422, 1901.

|| Garrett and Willows, *Phil. Mag.* vi. 8, p. 437, 1904.

with the temperature. They found too that if a quantity of ZnI_2 was kept at a constant temperature the rate at which the evolution of ions took place diminished according to an exponential function of the time, *i.e.* could be represented by an expression of the form $e^{-\lambda t}$; at the temperature of 360°C . the rate of production of ions fell to half its original value in about 41 minutes. They also determined the velocity of the ions in an electric field and found that in this, as in the other cases of ionisation by chemical action, the velocity is very small compared with that of ions produced by Röntgen rays. When the temperature of the salt was 360°C . they found for the positive ions coming from ZnCl_2 , ZnBr_2 , or ZnI_2 the velocity of 6×10^{-3} cm./sec. for a potential gradient of one volt per centimetre. The velocity of the negative ion seemed considerably larger but very irregular. An interesting question, the answer to which is still uncertain, is what is the carrier of the positive charge which forms the nucleus of the positive ion when such a salt as ZnI_2 is heated, is it an atom of zinc or one of hydrogen derived from the moisture which such a hygroscopic salt is likely to contain?

Many salts when heated to redness give out much larger quantities of ions than metals at the same temperature. Some salts give out an excess of negative, others of positive ions, all the lower oxides I have tried give an excess of negative, and all the phosphates of positive.

There are many other cases in which it is probable that chemical action is the cause of the emission of corpuscles and thus of electrical separation. We have seen that when metals are stimulated by the action of ultra-violet light, high temperature, Röntgen rays, or the radiation from radio-active substances, the atoms of the metal give out corpuscles. May not the same effect be produced by the stimulus or disturbance given to the atom when it takes part in a chemical reaction? That some such effect is produced seems probable from the behaviour of some oxides when heated, the oxides of calcium and barium give out as Wehnelt has shown large quantities of corpuscles. This does not seem altogether due to the high temperature of the atom of calcium in the compound, for if that were the cause the rate of emission might be expected to be of the same order for different compounds of calcium and also for the metal itself: it is however very much greater for the oxide than for the metal or any other

salt yet investigated, indeed the phosphate gives out at not too high temperatures an excess of positive electricity instead of an excess of corpuscles. These factors suggest that in the case of the oxide there are chemical changes going on in which the calcium atom gets disturbed and emits a copious supply of corpuscles.

In the case of barium oxide which also emits corpuscles when heated it is known that there is a transformation from one oxide to another at high temperatures, in these transformations the atoms of barium might be expected to be disturbed and caused to emit corpuscles.

Electrification produced by the bubbling of air through water, the splashing of drops.

210. Lord Kelvin* showed that air bubbled through water carried with it a negative charge, the amount of this charge depending upon the purity of the water, the addition of salts or acids to the water diminishing the effect, and in some cases reversing the sign of the electrification. The closely connected effect produced by the splashing of drops had previously been investigated by Lenard†, whose attention was called to the question by the well-known fact that there is something exceptional in the phenomena of atmospheric electricity at the foot of a waterfall when the water falls upon the rocks and breaks into spray. Lenard found that when a drop of water splashes against a plate, a positive charge goes to the water, while the surrounding air is negatively electrified. The amount of the electrification is influenced to a remarkable extent by the purity of the water; thus Lenard found that while the effect was very marked with the exceptionally pure water at Heidelberg, it was almost insensible with the less pure water at Bonn. He found too that the splashing of a weak solution of sodium chloride produced positive instead of negative electrification in the air; thus while the splashing of rain electrifies the air negatively, the breaking of waves on the sea-shore will electrify it positively.

In some experiments that I made on the subject‡, I found that the effects produced by exceedingly minute traces of some

* Lord Kelvin, *Proc. Roy. Soc.* lvii. p. 335, 1894.

† Lenard, *Wied. Ann.* xlvi. p. 584, 1892.

‡ J. J. Thomson, *Phil. Mag.* v. 37, p. 341, 1894.

substances were exceedingly large; thus, although rosaniline is a very powerful colouring agent, I found that its presence in water could be detected by the electrical effect before any change in the colour was apparent.

Kosters* found that while air bubbled through pure water was negatively electrified, the addition of .007 per cent. of sulphuric acid to the water made the air coming through electrically neutral, while the addition of more acid caused the air to be positively electrified, although the amount of this was small compared with the negative electrification due to pure water.

The effect produced by the addition of salts and acids to the water on the electrification of air passing through has also been investigated by Lord Kelvin, Maclean, and Galt†.

When air bubbles through water, or when the area of a drop of water is suddenly increased by the splashing of the drop against a plate, a virgin surface of water is exposed to the air; if, as seems to be the case, a double layer of electricity is formed at this surface, and if the ions in the layer next the air come from the air, then there must be left in the air an excess of negative ions if the outer coating is positive, and of positive if the outer coating is negative.

Lenard‡ found that electrification was produced by many liquids besides water and aqueous solutions; thus, mercury produced a very large effect of the same sign as water; if mercury is vigorously shaken up in a bottle, and the air drawn off, it is found to be strongly charged with negative electricity; turpentine, too, gives a large effect of the opposite sign to that of water, the air being positively, the turpentine negatively, electrified. The splashing of carbon bisulphide also gives rise to considerable electrification, the sign of the electrification being the same as for water.

The nature of the gas surrounding the liquid has also a very considerable effect upon the electrification; thus Lenard found that the electrification due to the splashing of water surrounded by hydrogen was much less than when the water was surrounded by air; using very carefully purified hydrogen, I got only a very

* Kosters, *Weid. Ann.* lxi. p. 12, 1899.

† Lord Kelvin, Maclean, and Galt, *Phil. Trans.* A, 1898.

‡ Lenard, *Wied. Ann.* xlvi. p. 584, 1892.

small electrification, and that of the opposite sign to the effect in air.

Recent experiments made by Kähler* have shown that the absence of electrification when air is bubbled through salt solutions is not due to the absence of ions but to the presence of both positive and negative ions in equal numbers, in the case of pure water only negative ions are present. Aselmann† has shown that the ions produced by the splashing of drops are of many different sizes, thus for the velocity, under the potential gradient of a volt per centimetre, of the negative ions produced by the splashing of pure water he found values ranging from 4 cm./sec. to 2.7×10^{-4} cm./sec., the greater number of ions having velocities between 4 and 1.6×10^{-2} cm./sec. For the ions produced by the splashing of a 0.2 per cent. solution of NaCl he found the velocities of the negative ions to range from 4 cm./sec. to 1.9×10^{-3} cm./sec., while the velocities of the positive ions were between 8.8×10^{-2} cm./sec. and 3.4×10^{-4} cm./sec.

* Kähler, *Ann. der Phys.* xii. p. 1119, 1903.

† Aselmann, *Ann. der Phys.* xix. p. 960, 1906.

CHAPTER XV.

SPARK DISCHARGE.

211. WE have hitherto mainly been discussing cases in which the ionisation was produced independently of the electric field acting upon the gas, we shall now proceed to the consideration of cases in which the ionisation is mainly due to the action of the electric field itself, and when the electric field before sending the electric current through the gas has first to make the gas a conductor. Cases when ionisation is produced by an electric field have already been considered on pp. 270 *et seq.*, we shall now consider the most familiar case of this kind—the electric spark. To take as simple a case of this as possible, let us suppose that we have two large metal plates parallel to one another and near together, let the plates be placed in connection with a large battery of cells or some other means of producing a difference of potential between them; then if we start with a very small difference of potential between the plates the only current which will pass from one plate to the other will be the very small one due to the spontaneous ionisation of the gas between the plates; this current is not luminous and is proportional to the distance between the plates, and so by pushing the plates near together may be made as small as we please. On measuring the potential difference, however, a stage is reached when a current accompanied by luminosity passes between the plates, and when this, the sparking stage, is reached the potential differences between the plates remain approximately constant, even when the number of cells in the circuit connecting the two plates is increased. The potential difference between the plates when the spark passes depends upon the distance between the plates, *i.e.* the length of the spark, and on the nature and pressure of the gas in which the plates are immersed; the investigation of the connection between these quantities has occupied the attention

of many observers. Before we consider their results, it will be useful to consider some properties of the spark which have an important effect on the accuracy of such observations.

212. We shall call the greatest potential difference, which can be applied to the electrodes for an indefinitely long time without causing the spark to pass, the spark potential difference. It must not be supposed, however, that whenever a potential difference just greater than this is applied to the plates a spark always passes; it frequently happens that if the potential difference is only applied for a short time the air between the plates can sustain a much greater difference of potential than the spark potential without a spark passing through it. Thus Faraday* long ago observed that it takes a greater potential difference to start the first spark than is required to keep up the sparks when once they have been started, and that the effect of one spark in facilitating the passage of its successors does not die away until the gas has rested for several minutes. I found that if the gas is dried with extreme care it is possible to get it to stand, without a spark passing, a potential difference three or four times as large as that which is sufficient to produce a spark in less perfectly dried gas†. The dry gas seems, however, to be in an unstable state as far as its electrical properties are concerned, for when once a spark has been forced through it the potential difference between the plates falls to the value for a moist gas, and the gas is not again able to stand a greater potential difference until it has rested for several minutes; this result suggests that if we had a perfectly dry gas it might not be possible to start a spark through it. The gas would, however, be in an unstable state, and may be compared to a supersaturated solution into which a foreign body has to be introduced before crystallisation begins, though the process once started continues until the solution ceases to be supersaturated. Another analogy would be a gas supersaturated with aqueous vapour, when for condensation to take place we require the presence of nuclei round which the drops may condense. The tendency of the gas to get into this electrically unstable state is much diminished by the presence of moisture, or of gases from flames, sparks, or arcs, by the illumination of the cathode by ultra-violet light, or

* Faraday, *Experimental Researches*, § 1417.

† J. J. Thomson, *Phil. Mag.* v. 36, p. 313, 1893.

by the exposure of the spark-gap to Röntgen or Becquerel rays, in short by any agent which introduces ions into the field. Warburg* has made very extensive researches on the effect produced by several of these agents on the passage of sparks; the method he used consisted in measuring the interval between the application of a potential difference greater than the spark potential and the passage of the spark; this interval, which may be several minutes when the potential only just exceeds the spark potential, diminishes as the potential difference increases, we shall call it the 'lag' of the spark. The amount of the 'lag' has an important effect on many phenomena connected with sparks; thus for example if it is great and an induction coil or some other machine furnishing a very rapidly changing potential be used to produce the spark, the terminals may support for the short time during which the electric field lasts a potential difference which would produce a spark if the lag were short; in a case like this an agent might make the spark pass by diminishing the time of lag even though it had no effect on the spark potential. A notable instance of this is the effect produced by ultra-violet light on sparks passing between the terminals of an induction coil. Hertz† showed that the exposure of the spark-gap to such light facilitated the passage of the spark; E. Wiedemann and Ebert‡ showed that if the negative electrode is screened off from the light, leaving the spark-gap and positive electrode illuminated, no effect is produced; we have seen (Chapter X.) that the illumination of a negatively electrified body leads to a discharge of negative ions, and that no ions are produced when the body is positively electrified. Swynghedauw§ found that if the positive electrode was large its illumination helped the spark: it is possible that with large electrodes sufficient light may be reflected from the positive to the negative electrode, or to some body in the neighbourhood of the positive electrode which is negatively electrified by induction, to cause the negatively electrified body to emit ions.

Wiedemann and Ebert (*l.c.*) showed that the nature of the gas had considerable influence upon the amount of the effect

* Warburg, *Sitz. Akad. d. Wissensch.*, Berlin, xii. p. 223, 1896; *Wied. Ann.* lix. p. 1, 1896; lxii. p. 385, 1897.

† Hertz, *Wied. Ann.* xxxi. p. 983, 1887.

‡ E. Wiedemann and Ebert, *Wied. Ann.* xxxiii. p. 241, 1888.

§ Swynghedauw, *Rapports présentés au Congrès International de Physique*, Paris, iii. p. 164.

produced by ultra-violet light, the effect being especially large in carbonic acid gas (the currents due to photo-electric effects in this gas are much larger than in air). Warburg* showed that the chief effect of the ultra-violet light was to diminish the 'lag' and that the effect on the spark potential was comparatively small. This is clearly shown by the figures given in the following table, taken from Warburg's paper: the potential difference was produced by a battery of storage cells, and a contact make and break was used, by means of which the potential difference was applied to the air-gap for a short interval, in this case $\cdot 0012$ sec. The fractions in the table have for their numerators the number of times a spark passed when the potential difference was applied for this time, and for their denominators the number of times the potential difference was applied; thus the fraction $\frac{0}{10}$ indicates that the spark never passed, and the fraction $\frac{10}{10}$ that it always did so. The gas used in these experiments was hydrogen at a pressure of 11 mm. of mercury, the spark potential was 960 volts in daylight, 1080 in the direct light from an arc lamp, and 1260 when this light had passed through glass. The electrodes were platinum spheres, 7 mm. in diameter, and the spark length was 4.5 cm.

Potential Difference in volts	960	1440	1500	1920	2040	2940	3000	3960	5040	6000	7020	7920	8940
In the dark							$\frac{0}{10}$	$\frac{1}{10}$	$\frac{1}{10}$	$\frac{2}{10}$	$\frac{4}{10}$	$\frac{7}{10}$	$\frac{8}{10}$
In daylight			$\frac{1}{10}$		$\frac{3}{10}$	$\frac{8}{10}$							
In the arc light through glass	$\frac{10}{10}$			$\frac{10}{10}$									
In the arc light	$\frac{0}{10}$		$\frac{10}{10}$										

It will be seen from this table that while in the dark the spark does not always pass even when the potential difference is 9 times that required to produce a spark when the field is continuous, in the arc light a potential difference only a little greater than the minimum required to produce a spark always produces a spark; the table shows too that daylight produces a very perceptible diminution of the 'lag.'

* Warburg, *Sitz. Akad. der Wissenschaften*, Berlin, xii. p. 223, 1896.

Warburg* showed that the 'lag' in a very dry gas was much longer than in one containing a small quantity of water vapour; the difficulty of starting the electric discharge in very carefully dried gas has already been alluded to.

The importance of the 'lag' in relation to the mechanism of the spark discharge seems first to have been realised by Jaumann†, who pointed out that while it lasted some process must be going on in the gas which converts it from an insulator to a conductor. During this process no light can be detected even in the darkest room, and both Jaumann and Warburg failed to find by direct experiments with electroscopes any indication of a current passing through the gas at this stage. Warburg‡, however, at low pressures observed some effects which seem to indicate that during the lag there is a current passing through the gas although it is too small to be detected by an electroscope or to produce any luminosity. The evidence for this is based on the effect produced by a magnet on the discharge through a gas at low pressure; a discharge is hindered by the action of a transverse magnetic field owing to the deflection of the ions which carry the current; Warburg showed that the magnetic field not only hampered the luminous discharge, it also produced a great increase in the duration of the 'lag'; he concluded from this that during the lag there is a feeble current which is essential for the production of the spark, and that the magnetic field by hampering this current prolongs the time which has to elapse before the spark can pass. Walter§ by taking photographs of sparks on rapidly moving plates has shown that a bright spark is preceded by faintly luminous brush discharges. We shall see when we consider the theory of the spark discharge that the formation of a preliminary current is necessary for the production of the spark unless the potential difference is very great.

Effect of rapid variations in the potential of the terminals on the passage of a spark.

213. Jaumann|| has made some interesting experiments on the effect on the spark length of rapid changes in the electrical

* Warburg, *Wied. Ann.* lxii. p. 385, 1897.

† Jaumann, *ib.* lv. p. 656.

‡ Warburg, *ib.* lxii. p. 385.

§ Walter, *ib.* lxvi. p. 636, lxviii. p. 776.

|| Jaumann, *Wien. Sitz.* xvii. p. 765, 1888.

condition of the electrodes. The experiments are of the following type. The main current from an electrical machine charged the

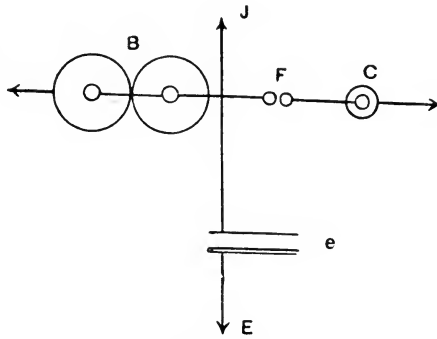

Fig. 104.

condenser *B*, while the condenser *C* could be charged through the air space *F*, *C* being a small condenser whose capacity was only 55 cm., while *B* was a battery of Leyden jars whose capacity was about 1000 times that of *C*; a wire was connected to the inside coating of *B* and terminated about 5 mm. above the plate *E*, which was connected with the earth. A glow discharge passed from the wire to the plate, and the difference of potential between the outside and inside coatings of the jars *B* was constant and equal to about 12 electrostatic units. When the knobs of the air break *F* were suddenly pushed together a spark about 5 mm. in length passed across the air break and in addition a bright spark 5 mm. long jumped across the air space at *e* where there was previously only a glow. The passage of the spark at *F* put the condenser *C* in connection with *B*, and thus produced a rapid variation in the potential of the wire, and the spark at *E* was the result. From experiments of this kind Jaumann came to the conclusion that if *V* is the potential difference between the electrodes the condition for sparking is that $V \frac{dV}{dt}$ and not *V* should have a definite value, so that if we could make the potential difference vary with great rapidity it might produce a spark even though its magnitude were much below the sparking value. I cannot see, however, that the experiments justify this conclusion; it must be remembered that when we add on the small condenser we start electrical vibrations,

and that while these are going on the maximum value of the potential in certain parts may greatly exceed the value when the vibrations have died away. Thus, to take a very simple case, suppose A is a very large Leyden jar, while B is a very small one, originally A is charged, B is not, the outsides of both are connected with the earth; if the insides of A and B are suddenly connected, then though the final potential of B will be smaller than the initial value of the potential of A , yet the maximum value during the oscillations will be nearly twice as large as the initial potential of A , and thus if B were suddenly connected with A a spark might pass across the plates of B although B might stand without sparking a potential difference equal to that originally existing between A : the passage of this spark would, however, be due to the oscillation producing a great increase in the maximum potential difference, and would not necessarily indicate that with a given potential difference the spark would pass more easily if this were changing than if it were steady. This question has been the subject of much controversy, it is often called the question of 'constant spark potential' and has been discussed by Jaumann*, Swyngedauw†, and K. R. Johnson‡.

Variation of the spark potential difference with the spark length and pressure of the gas.

214. The first measurements of the potential difference required to produce a spark through air at atmospheric pressure were made by Lord Kelvin§ in 1860, since then the subject has attracted much attention and important investigations have been made by Baille||, Liebig¶, Paschen**, Peace††, Orgler‡‡, Strutt§§, Bouty|||.

* Jaumann, *Wied. Ann.* lv. p. 656, 1895; *Wien. Sitz.* xvii. p. 765, 1888.

† Swyngedauw, *Thèse: Contribution à l'Étude des Décharges*, 1897.

‡ Johnson, *Drude's Ann.* iii. p. 460, 1900; v. p. 121, 1901.

§ Lord Kelvin, *Collected Papers on Electrostatics and Magnetism*, p. 247.

|| Baille, *Annales de Chimie et de Physique* [5], xxv. p. 486, 1882.

¶ Liebig, *Phil. Mag.* v. 24, p. 106, 1887.]

** Paschen, *Wied. Ann.* xxxvii. p. 79, 1889.

†† Peace, *Proc. Roy. Soc.* lii. p. 99, 1892.

‡‡ Orgler, *Drude's Ann.* i. p. 159, 1900.

§§ Strutt, *Phil. Trans.* 193, p. 377, 1900.

||| Bouty, *Comptes Rendus*, 131, pp. 469, 503, 1900.

Earhart*, Carr† and Russell‡, Hobbs§ and Kinsley||. The values of the spark potential difference given by the earlier experimenters are as a rule somewhat larger than those found under similar circumstances by more recent observers, probably because latterly more attention has been paid to eliminating the effects due to 'lag'; whenever 'lag' is present the potential difference when the spark passes is higher than the minimum required to produce a spark. We shall first give a general account of the laws which have been brought to light by the experiments made on this subject, reserving until the end of the chapter the tables which embody the numerical results obtained by the above-mentioned physicists.

Let us first take the case where the electrodes are so large compared with the distance between them and placed in such a position that the lines of electric force are parallel to each other, this condition would be fulfilled if the electrodes were parallel planes placed at a distance from each other not greater than a small fraction of their diameter; it is approximately fulfilled in the arrangement most frequently used where the electrodes are portions of spheres of large radius placed close together.

In the first place the potential difference required to produce a spark of given length does not depend upon the metal of which the electrodes are made (it is possible that aluminium and magnesium electrodes may be exceptions to this rule). Experiments on this point have been made by Righi¶, Peace, and Carr. Righi tried electrodes of carbon, bismuth, tin, lead, zinc, and copper and got the same potential difference with all these substances. Peace (*l.c.*) who made very careful experiments with electrodes of zinc and brass could not detect the slightest difference in the potential difference required to spark across them. Carr found the spark potential to be the same with electrodes of brass, iron, zinc, and aluminium. On the other hand, De la Rue and Hugo Müller** came to the conclusion that sparks pass more easily

* Earhart, *Phil. Mag.* vi. 1, p. 147, 1901.

† Carr, *Proc. Roy. Soc.* lxxi. p. 374, 1903.

‡ Russell, *Phil. Mag.* [6], xi. p. 237, 1906.

§ Hobbs, *Phil. Mag.* [6], x. p. 617, 1905.

|| Kinsley, *Phil. Mag.* [6], ix. p. 692, 1905.

¶ Righi, *Nuovo Cimento* (2), xvi. p. 97, 1876.

** De la Rue and Müller, *Phil. Trans.* 169, Pt. 1, p. 93, 1898.

between aluminium electrodes than between electrodes of any other metal, but that with this exception the nature of the electrodes has no influence upon the spark length. It is worthy of remark that the cathode fall of potential which is very closely connected with the spark potential does not differ by more than a few volts for electrodes of all the metals used by Righi; for aluminium and magnesium electrodes, however, it is decidedly smaller.

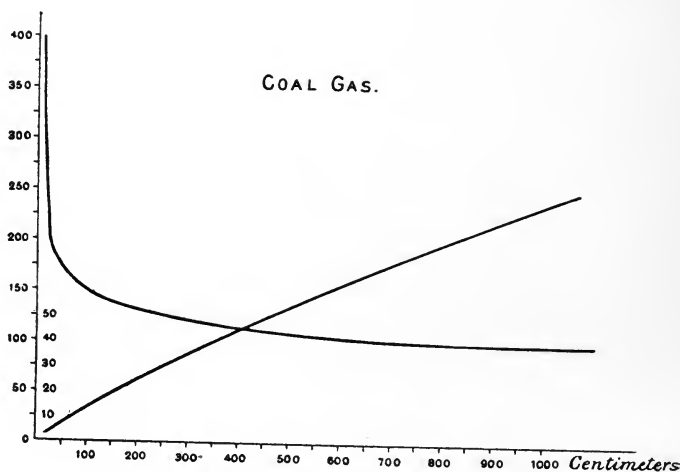

Fig. 105.

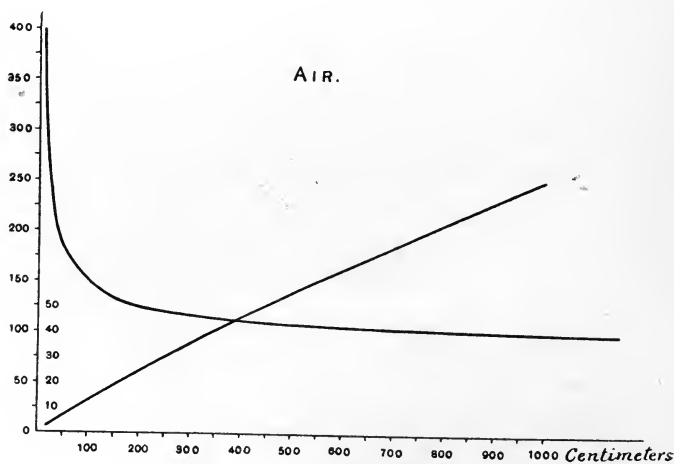

Fig. 106.

The connection between the spark potential and the spark length is represented by the curves given in Figs. 105, 106, 107, and 108 for air, hydrogen, and carbonic acid and coal gas at atmospheric pressure, the ordinates are proportional to the potential difference required to produce a spark of a length represented by the abscissæ.

The curves in Figs. 105—108 are due to Liebig (*l. c.*), who used spherical electrodes 19.5 cm. in diameter. The curves

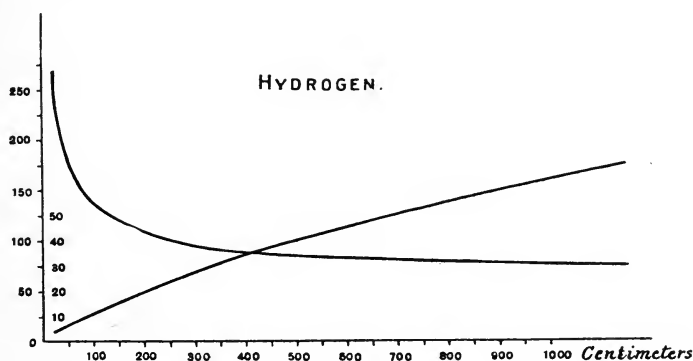

Fig. 107.

running up to the vertical axes represent the connection between the average value of the electric intensity, *i.e.* V/d , where V is the spark potential and d the spark length, and the spark length.

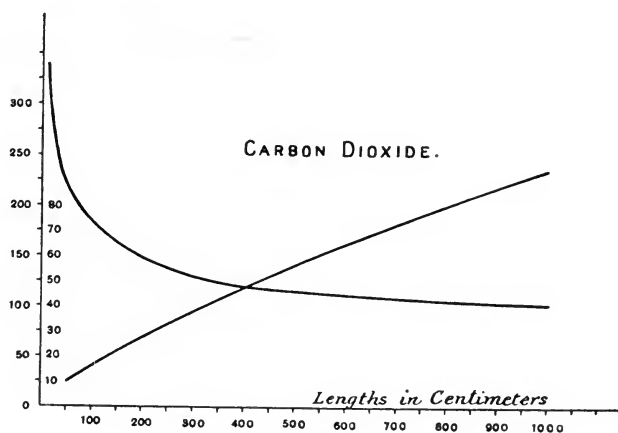

Fig. 108.

It will be seen that except for very short sparks the curves representing the relation between V and d are approximately straight lines, so that for moderately long sparks the relation between V and d would be of the form

$$V = a + bd,$$

where a and b are constants. Chrystal* has shown that the simple relation

$$V = 4.997 + 99.593 d,$$

where V is measured in electrostatic units and d in centimetres, agrees with Baille's very numerous experiments on the spark potential in air at atmospheric pressure quite as well if the spark length exceeds 2 mm. as the more complicated formula

$$V^2 = 10500 (d + 0.08) d$$

proposed by Baille himself. Carey Foster and Pryson† also found that the linear relation $V = a + bd$ was the one which best represented the results of their experiments on the potential difference required to spark through gas at atmospheric pressure.

215. The curves we have given do not however give any indication of the relation between the spark potential and the spark length when the latter is exceedingly small. When the spark length falls below a certain value which is inversely proportional to the pressure, and which we shall call the critical spark length, the potential difference has a minimum value, and if the spark length is still further diminished the spark potential begins to increase and goes on increasing until the spark length gets down to about 10^{-4} cm., when it very rapidly diminishes. The increase of the spark potential due to a diminution in the spark length was first observed by Peace; as the critical spark length at atmospheric pressure is exceedingly small, only about .01 mm., it is difficult to experiment with sparks short enough to show the effect, as however the critical spark length varies inversely as the pressure, we can by diminishing the pressure increase the critical spark length until its observation becomes comparatively easy. Perhaps the simplest way of showing the effect is to use slightly curved electrodes and to observe the position of the spark as these are brought closer

* Chrystal, *Proc. Roy. Soc. Edin.* xi. p. 487, 1882.

† Carey Foster and Pryson, *Chemical News*, xlix. p. 114, 1884.

together. When the electrodes are at some distance apart the spark passes along the shortest line between them; as the electrodes are pushed together it will be found that a stage is reached when the spark no longer passes along the shortest line, but goes to one side, taking a longer path, showing that it is easier to produce a long spark than a short one; with this arrangement the potential difference required to produce the spark does not vary as the electrodes are moved nearer together, it remains constant and equal to the minimum potential difference required to produce a spark; the spark length too is constant and equal to the critical spark length; the position of the spark is determined by the condition that it passes at the place where the distance between the electrodes is equal to the critical spark length. In order to measure the increase of potential difference due to the diminution in spark length it is necessary to use perfectly flat and parallel electrodes, when these are pushed together the length of the spark is necessarily diminished. The electrodes used by Carr (*l. c.*) are represented in Fig. 109; they were plane brass plates embedded in ebonite and separated by ebonite rings of different

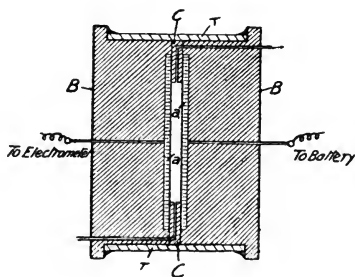

Fig. 109.

thicknesses. With this apparatus Carr obtained the results given in the following tables:

Pressure 2.02 mm.: gas—air.

Spark length	Spark potential in volts
1 mm.	558
2 mm.	371
3 mm.	357
5 mm.	376
10 mm.	472

Pressure 1.05 mm.: gas—air.

Spark length	Spark potential in volts
1 mm.	1826
2 mm.	594
3 mm.	397
5 mm.	355
10 mm.	379

The effect is even more strongly marked in hydrogen, as the following table shows.

Pressure 2.6 mm.: gas—hydrogen.

Spark length	Spark potential in volts
1 mm.	1781
2 mm.	462
3 mm.	398
5 mm.	285
10 mm.	317

In each of these cases the spark potential for the shortest spark is greater than for the longest. When the spark length falls below about 5×10^{-4} cm. the spark potential, as Earhart has shown, falls off rapidly; we shall return to this point later on. The existence of a critical spark length is also proved by the remarkable changes which take place in the appearance of the discharge when the electrodes are brought very near together. Thus in the course of some experiments on the discharge between large parallel plates I observed* that at very low pressures the discharge went from the under side of the lower plate, which was the positive electrode, and round to the top of the upper plate; the space between the plates was quite free from any luminous discharge: showing the discharge went more easily round the longer path than by the much shorter one between the plates. The same thing is shown in Figs. 110 and 111, which are drawings given by Lehmann† of the appearance as seen through a microscope of the discharge between electrodes of different shapes placed very near together.

* J. J. Thomson, *Proc. Camb. Phil. Soc.* v. p. 395, 1886.

† Lehmann, *Moleculare Physik*, ii. p. 295.

A very famous experiment due to Hittorf*, represented in Fig. 112, is another illustration of this. The two electrodes were only 1 mm.

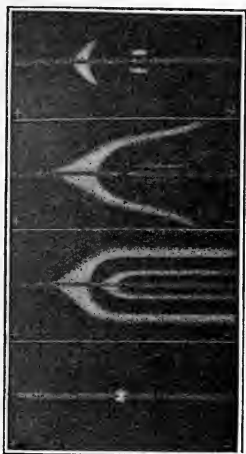

Fig. 110.

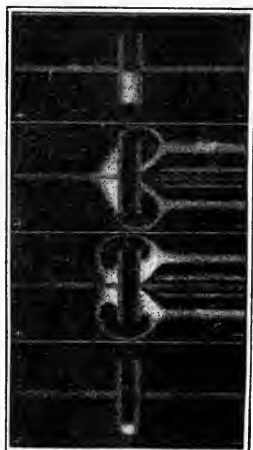

Fig. 111.

apart, the regions around them were connected together by a long spiral tube 375 cm. long; in spite of the enormous difference between the lengths of the paths the discharge, when the pressure

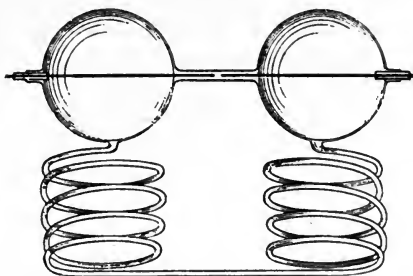

Fig. 112.

was very low, all went round through the spiral, the space between the electrodes remaining quite dark.

216. The curves in Figs. 105—108 show how rapidly the value of V/d (V being the spark potential and d the distance between the plates) increases as d diminishes. This was observed

* Hittorf, *Wied. Ann.* xxi. p. 96, 1884.

by Lord Kelvin in 1860. If the electric field were uniform V/d would be the electric intensity between the plates; in general, however, when a current of electricity passes through a gas the field is not uniform but is greater at one or both of the electrodes than in the rest of the field, we are not justified therefore in assuming that V/d is the maximum electric intensity between the electrodes.

Variation of the spark potential with the pressure.

217. If the spark length is constant and not too small then, starting with air at atmospheric pressure, as the pressure is diminished the spark potential decreases, the relation between the potential and pressure being at first a linear one; on further diminution of the pressure the spark potential reaches a minimum value, after this any further diminution in the pressure is accompanied by an increase in the spark potential. The relation between the spark potential and the pressure is represented by the curve in Fig. 113,

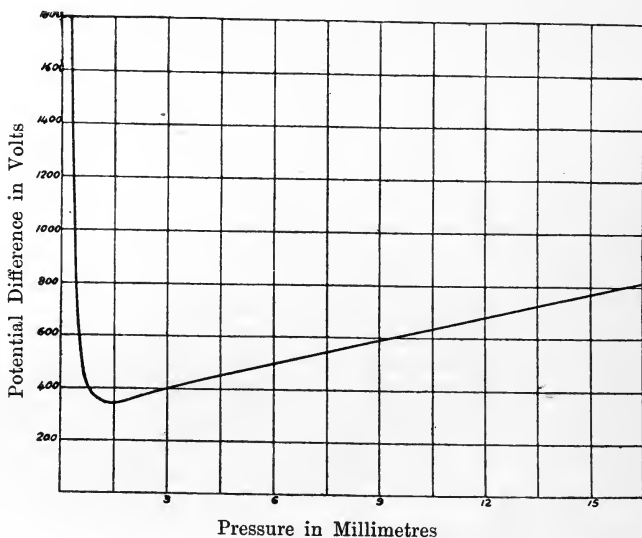

Fig. 113.

taken from a paper by Carr (*l. c.*); in this curve the ordinates represent the spark potential, the abscissæ, the pressure; the electrodes were parallel planes and the spark length 3 mm. The

pressure at which the spark potential is a minimum is called the critical pressure. Peace (*l. c.*) showed that the critical pressure depended upon the spark length, the shorter the spark length the greater the critical pressure. He showed too that the minimum spark potential was constant, being independent of the spark length; in air it was equal to about 351 volts, so that unless the spark length is less than about 5×10^{-4} cm., a potential difference of less than 351 volts cannot produce a spark.

These points are well illustrated by the curves in Fig. 114, taken from Carr's paper; they represent the relation between the pressure and the spark potential, for spark lengths of 1, 2, 3, 5, and 10 mm.

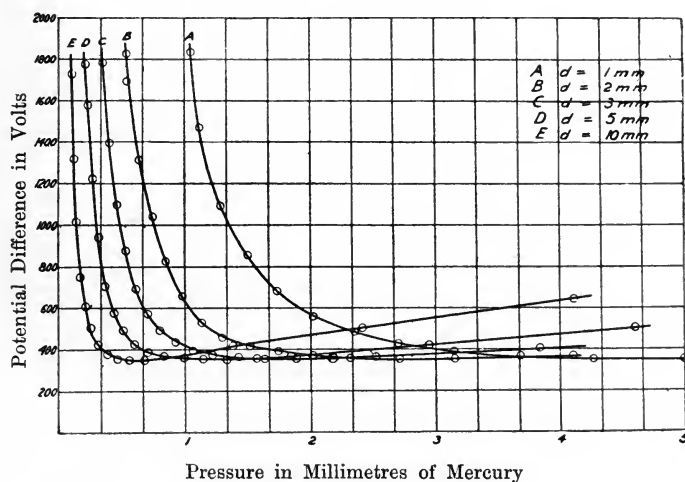

Fig. 114. Air.

10 mm. The critical pressures for these spark lengths as given by Carr are as follows.

Spark length	Critical pressure	Product of spark length and critical pressure
1 mm.	4.98 mm.	4.98
2 mm.	2.71 mm.	5.42
3 mm.	1.89 mm.	5.67
5 mm.	1.34 mm.	6.7
10 mm.	.679 mm.	6.79

It will be seen that the product of the critical pressure and the spark length is approximately constant: we must remember that owing to the flatness of the curves in the neighbourhood of the critical pressure the exact determination of the critical pressure is a matter of some difficulty, especially with the shorter sparks: the differences in the product of the critical pressure and the spark length are not greater than could be accounted for by the errors in the determination of the critical pressure.

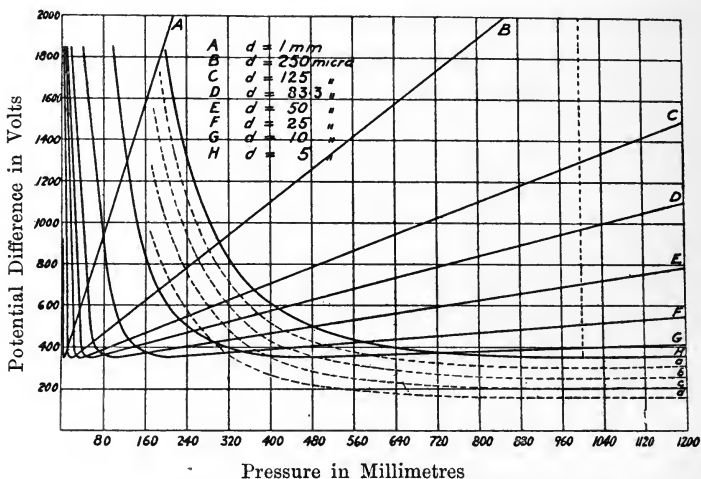

Fig. 115. Air.

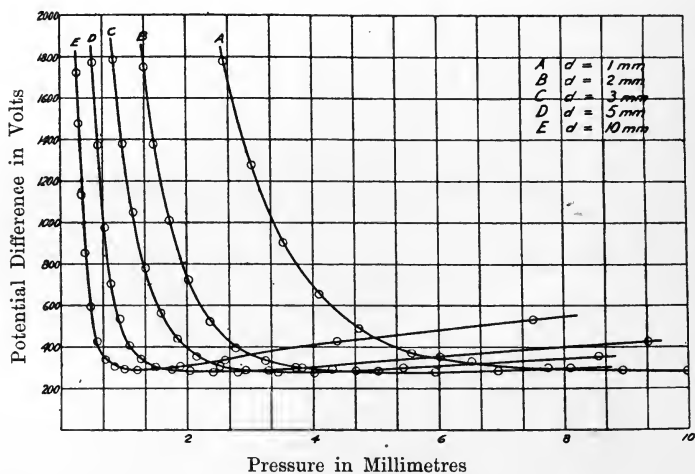

Fig. 116. Hydrogen.

The same features are shown by sparks through hydrogen and carbonic acid; the curves for these as given by Carr are shown in

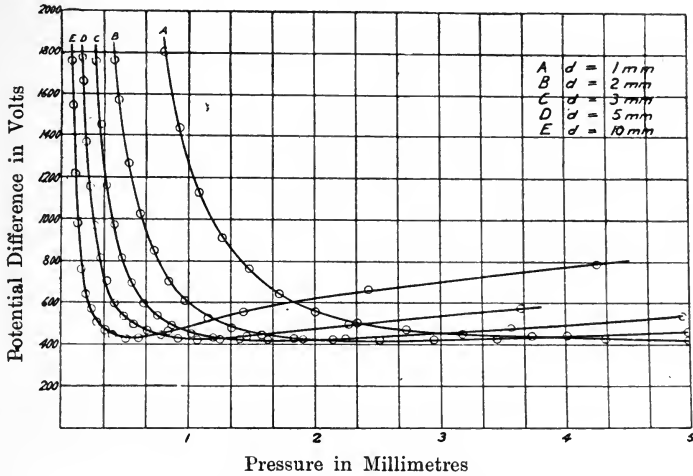

Fig. 117. Carbonic Dioxide.

Figs. 116 and 117, and the connection between the critical pressure and the spark length shown in the following tables:

Hydrogen. Minimum potential 280 volts.

Spark length	Critical pressure	Product of spark length and critical pressure
1 mm.	10.3 mm.	10.3
2 mm.	5.93 mm.	11.8
3 mm.	4.02 mm.	12.06
5 mm.	2.8 mm.	14.0
10 mm.	1.46 mm.	14.6

Carbonic acid. Minimum potential 420 volts.

Spark length	Critical pressure	Product of spark length and critical pressure
1 mm.	5.02 mm.	5.02
2 mm.	2.52 mm.	5.04
3 mm.	1.63 mm.	4.89
5 mm.	1.07 mm.	5.35
10 mm.	.510 mm.	5.1

The constancy of the product of spark length and critical pressure in the case of carbonic acid is very marked.

Carr has also given curves for the connection between spark length and pressure for H_2S , SO_2 , CO_2 , C_2H_2 , O_2 , N_2O ; these are shown in Fig. 118.

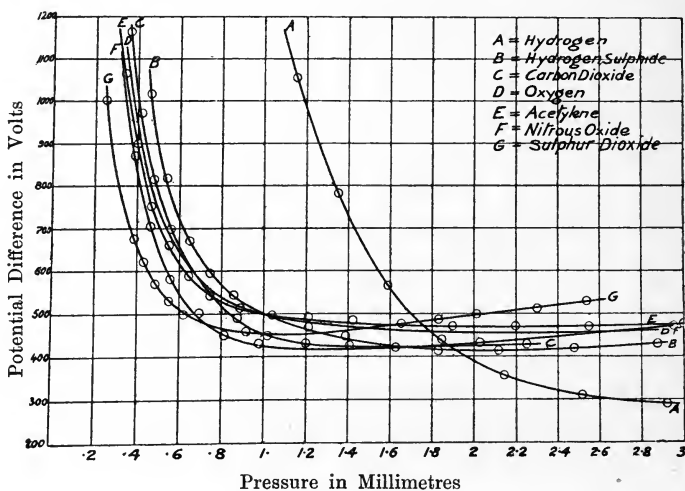

Fig. 118.

The spark length for these gases was 3 mm.

Very careful experiments on the relation between the pressure and the spark potential were made by Strutt* for air, hydrogen, nitrogen, and helium; the experiments on nitrogen and helium are especially interesting, as the minimum spark potential in these gases was found by him to be greatly affected by minute traces of impurity. Thus the presence of a very minute quantity of oxygen in nitrogen increased the minimum spark potential from 251 volts to 388 volts. Thus nitrogen from which the oxygen had been removed by passing the gas over metallic copper gave a minimum spark potential of 388 volts, the value of this potential for a specimen of nitrogen prepared from air by the absorption of the oxygen by alkaline pyrogallol was 347 volts; when, however, the oxygen was more completely removed by bubbling the gas repeatedly through the liquid alloy of sodium and potassium the minimum spark potential fell to 251. The curves obtained by

* Hon. R. J. Strutt, *Phil. Trans.* 193, p. 377, 1900.

Strutt for nitrogen are shown in Fig. 119. Curve No. 2 refers to the purest specimen, curve No. 1 to a specimen which had been passed several times through the sodium and potassium alloy, but

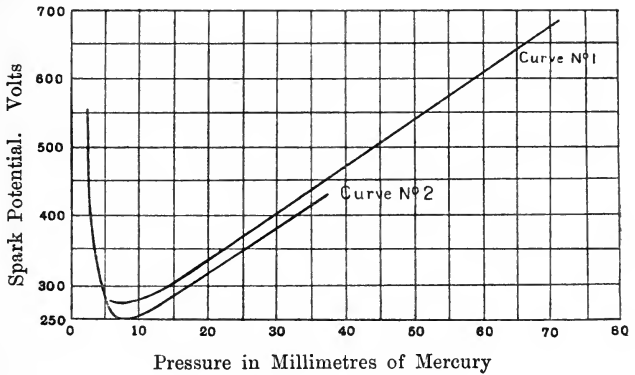

Fig. 119. Nitrogen.

not so often as that to which curve No. 2 relates: the minimum spark potential for this specimen was 276 volts. The curves after passing the critical pressure are parallel.

The discharge through helium, which was also studied by Strutt, presents many interesting features. Ramsay and Collie* first drew attention to the ease with which the discharge passed through

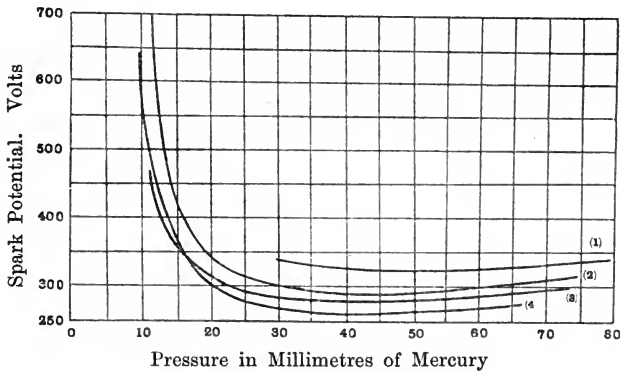

Fig. 120. Helium.

helium. Strutt's experiments, the results of which are represented in Fig. 120, show that for a given length of spark the critical

* Ramsay and Collie, *Proc. Roy. Soc.* lix. p. 257, 1896.

pressure is exceedingly high, being about five times that of air for the same spark length and more than twice that of hydrogen. The great effect of small impurities on the minimum spark potential is shown by the different curves in Fig. 120, which refer to samples purified in different ways: the smallest value of this potential obtained by Strutt was 261 volts.

218. We have seen that the product of the critical pressure and the spark length is constant and is also independent of the nature of the electrodes, it is thus a property of the gas; the following table contains the values of this product q , calculated from the measurements of Carr and Strutt, and also the mean free paths (λ) of the molecules of the gases at atmospheric pressure; these with the exception of helium are taken from the table in O. E. Meyer's *Kinetische Theorie der Gase*, p. 142, that of helium is deduced from Lord Rayleigh's* experiments on the viscosity of helium: though these free paths are taken for a particular pressure, the ratio of the free paths of the molecules of different gases is independent of the pressure. The numbers in column (3) are the spark length in millimetres multiplied by the critical pressure measured in millimetres of mercury:

Gas	Minimum spark potential	q	$\lambda \times 10^5$ cm.	$10^5 \times \lambda/q$
Air	341 S.	5·7	·95	·17
Nitrogen.....	251 S.	6·7	·98	·14
Oxygen	455 C.		1·05	
Hydrogen	{ 302—308 S }	14·4	1·8	·12
	{ 278 C. }			
Carbonic acid.....	419 C.	5·1	·68	·13
Sulphur dioxide.....	457 C.	3·3	·48	·14
Nitrous oxide.....	418 C.	5	·68	·14
Sulphuretted hydrogen	414 C.	6	·628	·10
Acetylene	468 C.			
Helium	261 S.	27	2·6	·10

The letters S. and C. indicate that the measurements were made by Strutt or Carr: no very great accuracy can be claimed for the values of q , as the determination of the critical pressure is difficult; a small error in the determination of the spark potential near this pressure would lead to a large error in the value of the

* Lord Rayleigh, *Proc. Roy. Soc.* lxix. p. 198, 1896.

critical pressure. Taking this into account, I think the differences shown in the preceding table for q/λ from the constant value 1.3 are not, except in the case of sulphuretted hydrogen and helium, greater than might be explained by errors of experiment. In the two exceptions sulphuretted hydrogen and helium there are special circumstances which make us hesitate to accept the results as final without further experiment. Sulphuretted hydrogen is decomposed by the spark, hydrogen being liberated; if such a decomposition had occurred in the experiments we have used for the determination of q , the spark would have passed through a mixture of hydrogen and sulphuretted hydrogen, the hydrogen would increase the critical pressure and hence the value of q . Again as Strutt's experiments show, the numbers for helium are very greatly affected by the presence of small amounts of impurity, so that it would hardly be safe to draw conclusions from this gas unless the free path determination had been made with the same specimen of gas as the electrical determinations.

We may, I think, conclude that for a large number of gases the value of q/λ is approximately constant, *i.e.* that with a given spark length the critical pressure is proportional to the mean free path of the molecules of the gas.

Paschen's Law.

219. As the result of a series of very numerous experiments on the relation between spark potential and pressure, Paschen* came to the conclusion that the spark potential depended only upon the product of the pressure and the spark length: *i.e.* upon the mass of gas between unit area of the electrodes. Thus, if the spark length d and pressure p of the gas are both altered, but in such a way that their product does not change, the spark potential V will remain constant; or in other words V is a function of pd .

The following results taken from Paschen's paper show how nearly the law is obeyed over the range of pressures studied by him; all these pressures, it ought to be noticed, are considerably above the critical pressures. V is the spark potential measured in electrostatic units, p the pressure measured in cm. of mercury, and d the spark length in cm.: the electrodes in these experiments were spheres 1 cm. in radius.

* Paschen, *Wied. Ann.* xxxvii. p. 79, 1889.

Air: $pd = 7.5$

p	d	V
10	0.75	16.23
15	0.50	16.54
20	0.38	16.75
25	0.30	17.00
30	0.25	16.83
40	0.17	16.86
50	0.15	16.68
75	0.1	16.33
	Mean	16.65

Air: $pd = 20$

p	d	V
28.6	0.7	34.30
33.3	0.6	34.63
40.0	0.5	35.12
50.0	0.4	34.77
66.66	0.3	35.39
	Mean	34.64

Hydrogen: $pd = 7.5$

p	d	V
10	0.75	9.50
15	0.50	9.32
20	0.38	9.47
25	0.30	9.59
30	0.25	9.58
40	0.187	9.69
50	0.15	9.90
75	0.10	10.44
	Mean	9.68

Hydrogen: $pd = 20$

p	d	V
28.6	0.7	19.12
33.33	0.6	19.25
40.00	0.5	19.43
50.00	0.4	19.43
68.66	0.3	20.00
	Mean	19.45

Carbonic acid: $pd = 7.5$

p	d	V
12.5	0.6	16.45
15.0	0.5	16.48
20.0	0.38	17.02
25.0	0.30	17.92
30.0	0.25	17.79
40.0	0.187	18.33
50.0	0.15	17.77
75.0	0.10	17.21
	Mean	17.37

Carbonic acid: $pd = 20$

p	d	V
33.33	0.6	33.03
40.00	0.8	32.86
50.00	0.4	33.46
66.66	0.3	34.11
	Mean	33.6

The relation between the spark potential and the product pd is shown in the curves for air, hydrogen, and carbonic acid in

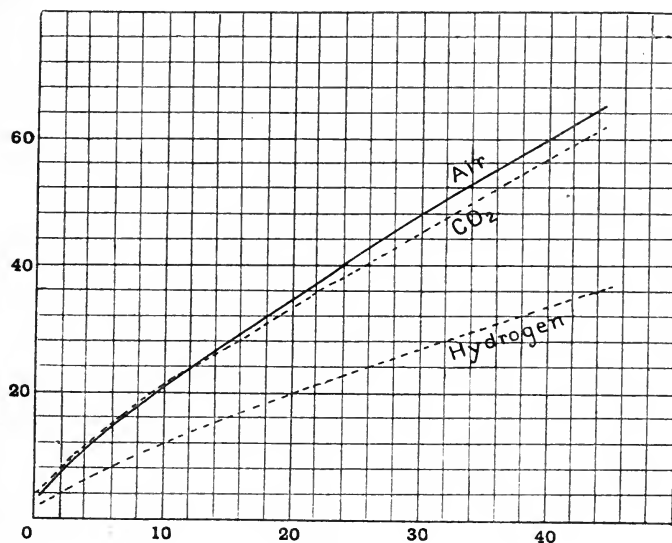

Fig. 121.

Fig. 121, the ordinates are the spark potentials in electrostatic measure, the abscissæ the values of pd .

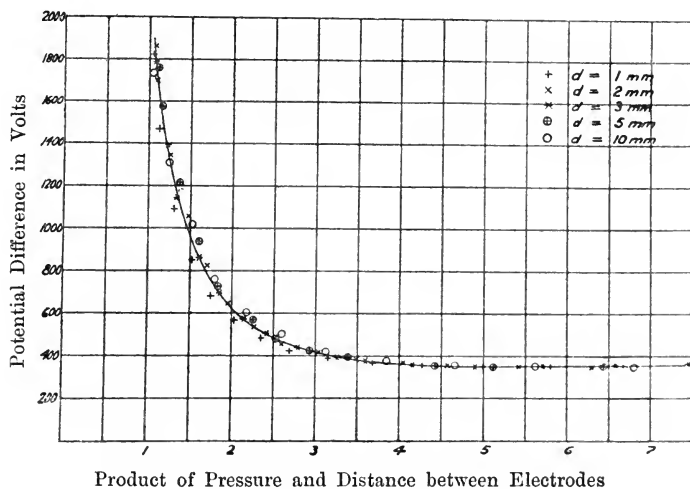

Fig. 122. Air.

Paschen's experiments were all made at pressures considerably greater than the critical pressure; it has, however, quite recently been shown by Carr (*l.c.*) that Paschen's law holds at all pressures. This is very clearly shown by the curves in Figs. 122, 123, which

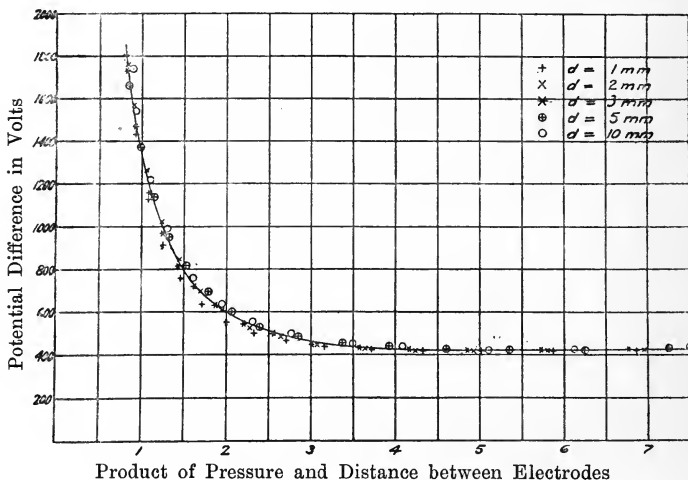

Fig. 123. Carbon Dioxide.

represent the relation between the spark potential V (in this case measured in volts) and the product pd (p was measured in *millimetres* of mercury and d in millimetres); five different values of d were used, ranging from 1 to 10 mm.; the results of these are represented on the curve by symbols attached to the points on the curve determined by the various experiments. It will be seen that the points for all the spark lengths all lie on the same curve, and in this case the range of pressures extended far below the critical pressure. The results of Paschen's law are very important; we see that to find the spark potential corresponding to any spark length and any pressure it is only necessary to possess the results of experiments made with a constant spark length over the whole range of pressures. We see, too, that it follows from this law that the critical pressure must vary inversely as the spark length, a result for which as we have seen there is direct experimental evidence. It follows too from this law that if we know the values of the spark potential required to produce a spark of constant length for all pressures we can deduce the value of the spark potential for a spark of any length at any pressure.

Potential difference required to produce very short sparks.

220. Earhart* has made a series of experiments on the difference of potential required to produce sparks whose length is comparable with the wave-length of sodium light; the electrodes used were steel spheres, and the connection between the spark potential and the distance between the spheres is shown in Fig. 124, in which the abscissæ are the spark potential and the ordinates the shortest distance between the spheres. In consequence of the

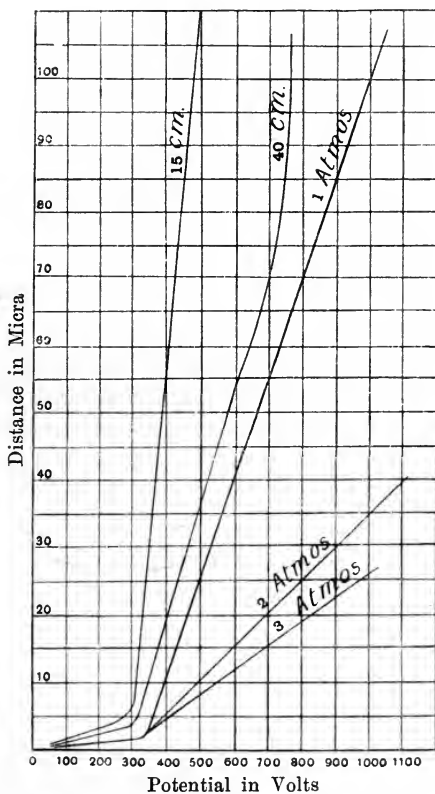

Fig. 124.

curvature of the electrodes, the least distance between the spheres is not necessarily equal to the spark length; thus when the distance is less than the critical spark length the spark will pass.

* Earhart, *Phil. Mag.* vi. 1, p. 147, 1901.

not across the shortest distance, but across a place where the distance is equal to the critical spark length. Thus Earhart's curves do not show the increase in potential difference with diminishing distance between the electrodes as they would have done if they had been plane: the most interesting feature of the curves is the very rapid diminution in the spark potential when the distance between the electrodes falls to less than about 3×10^{-4} cm.; when the distance is less than this the spark potential falls off rapidly with the distance, and seems from Earhart's results to become directly proportional to the distance. The smallest potential difference actually measured was 32 volts when the distance between the electrodes was 3×10^{-5} cm.: this is only about one-tenth of the minimum spark potential. Earhart made some observations on the effect of pressure; diminution of the pressure from three atmospheres to one atmosphere did not seem to affect the discharge potential when the electrodes were very close together; when the pressure was diminished below one atmosphere however the discharge potential also diminished. An inspection of the curves suggests that the character of the discharge changes when the electrodes are brought within a certain distance of each other, or what is equally consistent with the curves, when the average electric intensity, F , between the plates reaches a certain value (about a million volts per cm.): when F has once reached this value Earhart's experiments suggest that the discharge is determined by the condition that F , *i.e.* V/d , if V is the potential difference and d the distance between the electrodes, should have this value. These experiments raise many important points, and it is to be hoped that they will be carried much further.

The following considerations seem to afford a possible explanation of the behaviour of the discharge when the electrodes are very close together. We have had occasion before to make use of the hypothesis that in a metal, even at ordinary temperature, free corpuscles are moving about in every direction; if these corpuscles could escape from the metal under ordinary conditions the metal would be unable to retain a charge of negative electricity. Now one of the reasons the corpuscles do not escape is that as soon as they leave the metal there is an electrostatic attraction between the corpuscle and the metal equal to $e^2/4r^2$, where e is the

charge on the corpuscle and r the distance of the corpuscle from the surface of the metal; this attraction, unless the kinetic energy with which the corpuscle leaves the metal exceeds a certain very high limit, will drag the corpuscle back into the metal. Let us now suppose that an external electric force F acts on the corpuscle, tending to make it move away from the metal; then if Fe is comparable with $e^2/4r^2$, the external field will give appreciable assistance to the corpuscle in escaping from the metal, and will enable corpuscles to leave the metal, whose kinetic energy is too small to allow them to escape in the absence of an external field. If Fe is comparable with $e^2/4r^2$, F must be comparable with $e/4r^2$. Now in electrostatic measure $e = 3.4 \times 10^{-10}$, let us put $r = 10^{-7}$, then $e/4r^2 = 8.5 \times 10^3$. Now in Earhart's experiments F was about 10^6 volts per cm., or in electrostatic measure 3.3×10^3 ; this is more than one-third of the value of $e/4r^2$, so that if, as is quite possible, r is somewhat greater than 10^{-7} , the pull exerted by the external field would be able to drag the corpuscles away from the metal: as soon however as corpuscles can leave the electrode, that electrode will act like a cathode, and a discharge of negative electricity will pass from this to the opposite electrode. If this explanation is correct the discharge across these very small distances is entirely carried by the corpuscles and no part of it by positive ions; in the discharge we have previously considered, corpuscles and positive ions both take a share in carrying the discharge.

Since the publication of the first edition of this book some interesting experiments on the potential difference required to produce very short sparks have been made at Chicago University by Kinsley and Hobbs. Kinsley*, who worked with exceedingly short sparks, the spark length in some cases being as small as 3×10^{-7} cm., and the sparking potential only one volt, found that while each set of experiments gave a linear relation between the spark potential and the spark length, the slope of the line graphically representing this relation varied with the treatment the electrodes had received, *i.e.* with the way they had been cleaned and polished. This is perhaps scarcely to be wondered at, as deposits of moisture, etc., on the electrodes comparable in thickness with the spark length would quite escape detection by

* Kinsley, *Phil. Mag.* [6], ix. p. 692, 1905.

optical means. Kinsley calls attention to a characteristic peculiarity of these short sparks; when once a spark has passed, the insulation between the electrodes is destroyed, the surfaces cohere and a metallic bridge seems to be formed between them and they have to be separated by a distance much greater than the original spark length before the coherence is destroyed.

Hobbs*, who worked with sparks considerably longer than those used by Kinsley, and who did not meet with the same variations as long as the electrodes remained unchanged, observed the exceedingly important and suggestive fact that when once the spark length is reduced to the point at which sparks begin to pass with diminished potential, the relation between the spark length and the potential difference is independent of the pressure and nature of the gas, while it does depend upon the nature of the metal of which the electrodes are made. This is clearly shown by the curves in Figs. 125, 126, 127. Fig. 125 gives the relation between the potential difference and the spark length for air at different pressures, Fig. 126 the relation for different gases and Fig. 127 that for different electrodes. The constant value before the dip is due to one of the electrodes being spherical and the other plane, thus by choosing different paths the spark can vary its length within

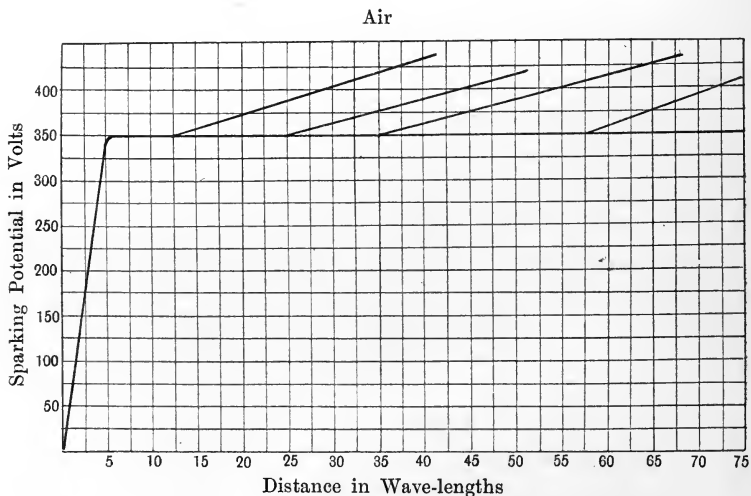

Fig. 125.

* Hobbs, *Phil. Mag.* [6], x. p. 617, 1905.

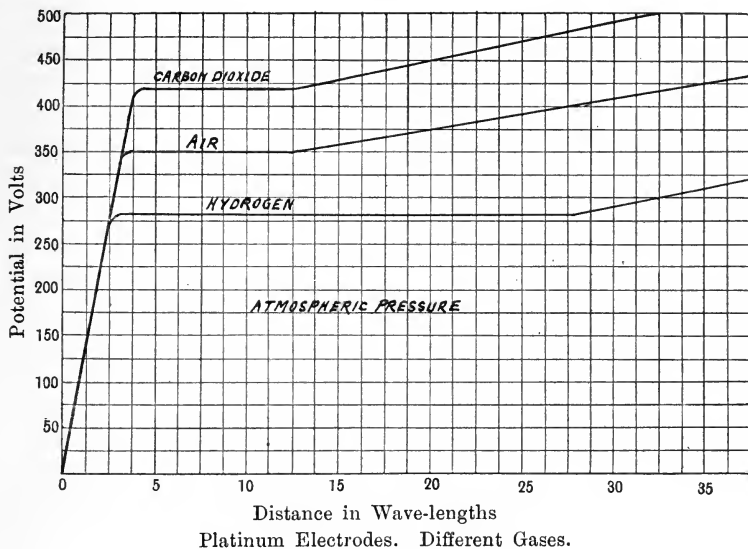

Fig. 126.

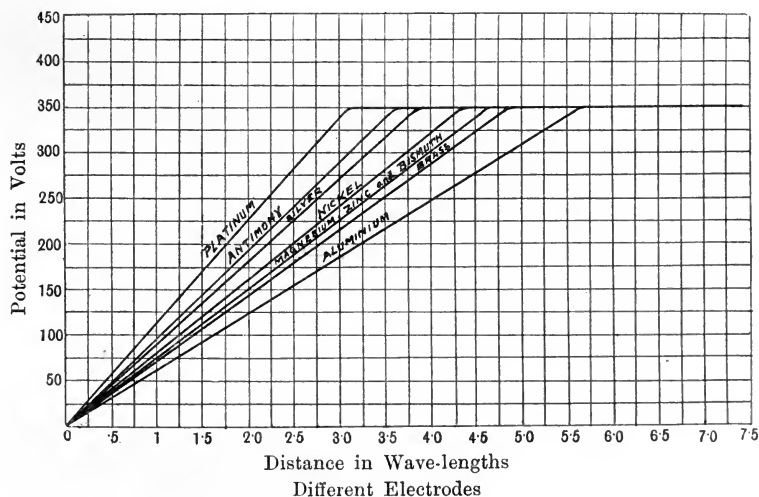

Fig. 127.

wide limits, it chooses the path for which the potential difference is least, thus unless the sparks are very short the potential difference will be the minimum potential difference discussed in § 217, and the increase of potential observed with sparks between

parallel flat electrodes, when the spark length is diminished, will not occur. We see from these results that the passage of the spark in the second stage is determined by the condition that the electric force between the plates should have a constant value depending on the metal of which the plates are made but not upon the pressure or nature of the gas between them. This result confirms the view expressed in the first edition of this book, that the spark is carried in this case by carriers dragged by the electric field out of the metal and not out of the gas. It would be interesting to see whether these carriers are corpuscles or a mixture of negatively electrified corpuscles and positively electrified atoms. This could be tested by making the two electrodes of different metals; if all the carriers were corpuscles the potential difference would depend only upon the metal used for the negative electrode; if they were all positively electrified atoms then only the positive electrode would be active, which if they were a mixture both electrodes would affect the potential.

If a field of the strength measured by Hobbs, about 100 volts per 10^{-4} cm., is sufficient to tear the carriers from the metal, then if we separate two metal electrodes by a solid dielectric and apply a field of this strength, if some of the carriers were corpuscles these would be dragged through the dielectric so that with a field of this strength the leakage of electricity through the dielectric ought to be much greater than for weaker fields.

According to the results given by Almy* it would be possible to apply fields of this strength to mica, quartz, and ebonite; it is perhaps more than a chance coincidence that the discharge passes through many solid and liquid dielectrics, for fields just a little less intense than that under consideration. It is, I think, probable that the process by which discharge takes place through solid and liquid dielectrics is analogous to that which produces these short sparks, *i.e.* that the corpuscles are dragged out of the atom by the electric field rather than by collision with other corpuscles.

* Almy, *Ann. der Physik*, i. p. 508, 1900.

Discharge when the electric field is not uniform.

221. Baille* and Paschen† have made some very interesting experiments on the potential difference required to spark between spheres small enough to make the variations in the strength of the electric field considerable. Baille's results are given in table A, Paschen's in table B:

A. POTENTIAL DIFFERENCES.

Pressure 760 mm., Temp. 15°—20° C.

Spark Length in cms.	Planes	Spheres 6 cm. diam.	Spheres 3 cm. diam.	Spheres 1 cm. diam.	Spheres .6 cm. diam.	Spheres .35 cm. diam.	Spheres .1 cm. diam.
.05	8.94	8.96	9.18	9.18	9.26	9.30	9.63
.10	14.70	14.78	14.99	15.25	15.53	16.04	16.10
.15	20.20	20.31	20.47	21.28	21.24	21.87	19.58
.20	25.42	25.59	25.95	26.78	26.82	27.13	21.91
.25	30.38	30.99	31.33	32.10	32.33	31.96	23.11
.30	35.35	36.12	36.59	37.32	37.38	36.29	24.12
.35	40.45	41.45	41.47	42.48	42.16	39.39	25.34
.40	45.28	46.34	46.77	47.62	46.34	41.77	26.03
.45	50.48	51.46	51.60	51.56	50.44	43.76	26.62
.40	44.80	45.00	45.00	45.50	44.80	41.07	26.58
.45	49.63	50.33	49.63	52.04	48.42	43.29	28.49
.50	54.35	55.06	54.96	54.66	53.25	47.21	30.00
.60	63.82	65.23	65.23	65.23	59.69	53.75	31.51
.70	74.09	75.40	73.79	72.28	64.22	56.47	32.92
.80	84.83	87.98	84.76	77.61	67.75	58.79	33.82
.90	94.72	97.44	94.62	80.13	70.56	59.09	34.93
1.00	105.49	112.94	104.69	83.05	72.38	59.49	36.24

We see from the tables that with a given spark length between two equal spheres, one charged and insulated and the other put to earth, the potential difference varies with the diameter of the spheres; starting with planes the potential difference at first increases with the curvature and attains a maximum when the sphere has a certain diameter. This critical diameter depends upon the spark length, the shorter the spark the smaller the critical diameter.

* Baille, *Annales de Chimie et de Physique* [5], xxv. p. 486, 1882.

† Paschen, *Wied. Ann.* xxxvii. p. 79, 1889.

B. SHORT SPARKS.

LONG SPARKS.

Spark Length in cms.	Spheres 1 cm. radius	Spheres .5 cm. radius	Spheres .25 cm. radius
.01	3.8	3.42	3.61
.02	5.04	5.18	5.58
.03	6.62	6.87	6.94
.04	8.06	8.82	8.43
.05	9.56	9.75	9.86
.06	10.81	10.87	11.19
.07	11.78	12.14	12.29
.08	13.40	13.59	13.77
.09	14.39	14.70	14.89
.10	15.86	15.97	16.26
.11	16.79	17.08	17.26
.12	18.28	18.42	18.71
.14	20.52	20.78	21.26

Spark Length in cms.	Spheres 1 cm. radius	Spheres .5 cm. radius	Spheres .25 cm. radius
.10	15.96	16.11	16.45
.15	21.94	22.17	22.59
.20	27.59	27.78	28.18
.25	32.96	33.42	33.60
.30	38.59	39.00	38.65
.35	43.93	44.32	43.28
.40	49.17	49.31	47.64
.45	54.37	54.18	51.56
.50	59.71	59.03	54.57
.55	64.60	63.35	57.27
.60	69.27	67.80	59.95
.70	78.51	75.04	63.14
.80	87.76	81.95	66.39
.90			68.65
1.00			70.68
1.20			74.94
1.50			79.42

The results given in these tables show that when the spheres are very small the potential difference required to produce a spark

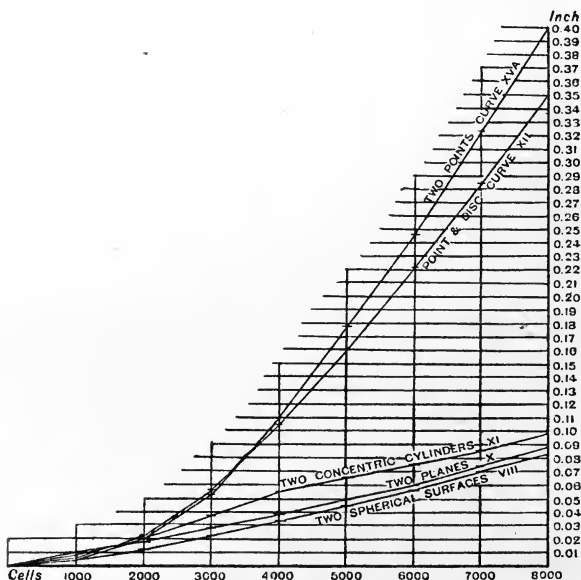

Fig. 128.

of given length is, if the spark is not too short, very much less than the potential required to produce the same length of spark between parallel planes, and that the spark potential difference with points as electrodes only increases slowly with the length of the spark. The effect of the shape of the electrode on the spark length is shown by the curves represented in Fig. 128, which is taken from a paper by De la Rue and Müller*. The curves give the relation between spark potential and spark length for two planes, two spheres one 3 cm. in radius, the other 1.5 cm. in diameter, two coaxial cylinders, a plane and a point, and two points.

222. Schuster† has, by the aid of Kirchhoff's solution of the problem of the distribution of electricity over two spheres, calculated from Baille's and Paschen's results the maximum electric intensity in the field before the spark passed: the results for Baille's experiments are given in the following table.

Spark Length in cms.	Planes	Spheres 6 cm. diam.	Spheres 3 cm. diam.	Spheres 1 cm. diam.	Spheres .6 cm. diam.	Spheres .35 cm. diam.	Spheres .1 cm. diam.
.05	179	180	186	190	197	206	292
.10	147	149	153	163	176	198	376
.15	135	138	141	157	170	206	425
.20	127	131	137	154	170	219	460
.25	122	127	134	154	180	236	478
.30	118	124	130	156	189	253	494
.35	116	122	129	159	197	263	516
.40	113	122	129	164	204	272	528
.45	112	120	127	166	214	278	540
.40	112	118	124	157	197	268	539
.45	110	119	122	167	206	275	578
.50	109	117	125	166	218	296	608
.60	106	116	125	181	233	327	639
.70	106	117	126	188	234	339	667
.80	106	123	130	192	250	349	685
.90	105	120	132	191	255	349	708
1.00	106	128	133	194	258	349	733

It will be seen that the smaller the spheres, *i.e.* the more irregular the electric field, the greater the maximum electric

* De la Rue and Müller, *Phil. Trans.* 1878, Pt. I. p. 55.

† Schuster, *Phil. Mag.* v. 29, p. 182, 1890.

intensity. We must be careful to distinguish between the electric field before the spark passes and the electric field during the discharge or even during the interval between the application of the potential difference and the passage of the discharge, for during this interval ions are moving about in the field and producing fresh ions; both of these effects will modify the distribution of the electric field. Thus to take an example, suppose we have a negatively electrified point near to a positively electrified plate; if there are no ions in the field the electric force would be a maximum at the point, and would steadily diminish as we approach the plate; if, however, there are ions present in the neighbourhood of the point, the negative ions will be repelled from the point, while the positive ions will be pulled into it; this will have the effect of increasing the electric intensity at a distance from the point at the expense of that close to the point: if the negative ions congregate at the plate, so as to form a layer of negative electrification close to the plate, the electric intensity at the plate may rise to very high values. This is what actually occurs, for Mr Blyth has measured at the Cavendish Laboratory the distribution of electric intensity between a point and a plate when the discharge is passing, and has shown that it is large close to the point, is then comparatively small for some distance but becomes large again close to the plate.

Thus if there is any preliminary ionisation it does not follow that the maximum electric intensity when the spark passes is that calculated by the use of Kirchhoff's solution. Russell* has shown that in the cases when the preliminary ionisation is likely to be small and the maximum electric intensity in the spark therefore the same as that calculated by the theory, the maximum electric intensity is independent of the spark length, and the condition for discharge is that this intensity should rise to a definite value. When the conditions are such that the spark passes between points without any preliminary brush or glow discharge Vöege† has shown that the potential difference for a spark of length d can be expressed by the formula

$$V = 4800d + 24000,$$

where V is expressed in volts and d in centimetres.

* Russell, *Phil. Mag.* [6], ii. p. 237, 1906.

† Vöege, *Ann. der. Phys.* xiv. p. 556, 1904.

The alteration of the electric field during the 'lag' will explain why, when one or both of the electrodes are small, a spark does not necessarily pass even although the potential difference between an electrode A and a point P near to A (calculated on the assumption that there are no ions in the field) is greater than that required to produce a spark of length AP between plane electrodes; for during the 'lag' the movement of the ions in the field may have so reduced the potential difference between A and P that it is less than that required to produce a spark of length aP .

Although the processes going on during the lag may reduce the inequalities in the electric field between small electrodes, they cannot be expected to remove them entirely, and when the field is far from uniform, as is the case with pointed electrodes, we can easily see that the potential difference required to produce a long spark is less than that required to produce a spark of the same length between plane electrodes. For let the curve APQ (Fig. 129) represent the distribution of potential between small electrodes A, B , and let CD be the curve which represents the potential

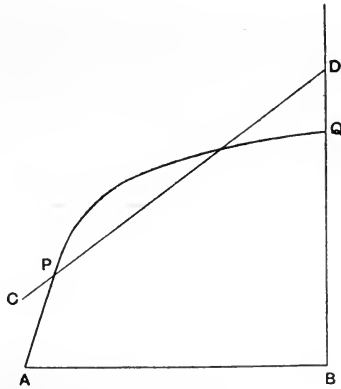

Fig. 129.

difference required to produce a spark in a uniform field (the ordinate of a point on CD represents the spark potential required to produce a spark whose length is equal to the abscissa of the point); then we see that although the potential difference BQ between the small electrodes may be less than BD , that required to produce a spark of length AB in a uniform field, the two curves

may intersect; if they do so at P , then a spark will pass from A to P , the whole potential difference will be thrown on the region between P and B , so that the strength of this part of the field will increase and the spark will travel on to B .

223. When the electrodes are of different sizes Faraday* found that the spark potential is different according as the smaller electrode is positive or negative; De la Rue and Müller† also observed the same effect; according to Wesendonck‡ this difference only occurs when a brush discharge accompanies the spark, when the conditions are such that the discharge passes entirely as a spark the spark potential is the same whichever way the spark passes.

Spark Potential in different Gases.

224. For pressures considerably greater than the critical pressure the relation between the spark potential and the spark length is a linear one; if V is the spark potential measured in electrostatic units and x the spark length at atmospheric pressure measured in centimetres, then

$$V = ax + b.$$

The experiments by Baille, Liebig, Paschen, Orgler give the following values for the constants a and b in hydrogen, air, and carbonic acid.

Gas	BAILLE		LIEBIG		PASCHEN		ORGLER	
	a	b	a	b	a	b	a	b
Air	99·6	5	87·4		92·5		93·6	
Hydrogen ...			55·8		43·0		46·3	
Carbonic acid			91·8		91·1		85·6	

Wolf§, who measured the spark potential required to produce a spark 1 mm. long at pressures varying from 1 to 5 atmospheres, found that (as we should expect from Paschen's law) the relation at these high pressures between spark potential and pres-

* Faraday, *Experimental Researches*, § 1480.

† De la Rue and Müller, *Phil. Trans.* 1878, Pt. I. p. 55.

‡ Wesendonck, *Wied. Ann.* xxviii. p. 222.

§ Wolf, *Wied. Ann.* xxxvii. p. 306, 1889.

sure is a linear one; if V is the spark potential in electrostatic measure and x the pressure in atmospheres, then Wolf found that V was given by the following expressions:

$$\text{For hydrogen} \quad V = 6.509x + 6.2$$

$$\text{For oxygen} \quad V = 9.6x + 4.4$$

$$\text{For air} \quad V = 10.7x + 3.9$$

$$\text{For nitrogen} \quad V = 12.08x + 5.0$$

$$\text{For carbonic acid} \quad V = 10.22x + 7.2.$$

If F is the average electric force between the electrodes in these experiments, then $F = 10V$.

The order of the spark potential for different gases, as will be seen from the preceding table, depends upon the pressure; thus at the pressure of 1 atmosphere V for CO_2 is greater than V for air, while at high pressures it is less.

225. Bouty* has made a series of experiments on the electric field required to make a gas into a conductor, using a method which dispensed with the use of metallic electrodes. In this method the gas at a low pressure is contained in a glass vessel with parallel sides, and this vessel is placed in the space between two parallel plates parallel to the walls of the vessel, the difference of potential between these plates is increased until the gas in the glass vessel becomes luminous, indicating that a discharge is passing through it; the strength of the electric field, *i.e.* the electric force (not the potential difference), when this occurs, is called by Bouty the *cohésion diélectrique* of the gas. A very considerable number of gases were examined by this method. Bouty found that the *cohésion diélectrique* F for gases up to 6 cm. pressure could be represented by the formula

$$F = a + bp,$$

where a and b are constants and p is the pressure. When F is measured in absolute electrostatic units and p in atmospheres, Bouty found that

$$\text{For hydrogen} \quad F = 1.4 + 63.33p$$

$$\text{For air} \quad F = 1.593 + 119.09p$$

$$\text{For carbonic acid} \quad F = 1.703 + 144.4p;$$

he compares these expressions with those given by Wolf and points out that while the coefficients of p are not so very different

* Bouty, *C. R.* 131, p. 469, 1900.

the constant terms are of quite a different order; he ascribes this difference to the electrodes in Wolf's experiments being metal, while in his experiments they were glass; it seems to me that the following explanation is more probable. If V is the potential difference required to produce a spark of length l through gas at a pressure p considerably greater than the critical pressure, then we have approximately, if A and B are constants,

$$V = A + Blp;$$

since we know by Paschen's law that V is a function of lp ; hence F , the average electric intensity when the spark passes, is given by the equation

$$F = \frac{A}{l} + Bp,$$

hence the constant term varies inversely as the length of the spark while the coefficient of p is independent of the spark length. In Wolf's experiments the spark length was only 1 mm., while the distance between the plates in Bouty's experiments was much greater so that the difference in the spark length would explain the difference in the constant term, and it is not necessary to ascribe it to the nature of the electrodes. Bouty* has determined the constants, a , b , in the expression $F = a + bp$ for the *cohésion diélectrique* for a number of vapours; the results are given in the following table. Bouty's measurements were made at pressures ranging from .0055 cm. to 2 cm. of mercury. The constants apply when the pressure is measured in cm. of mercury and F in volts per cm.

Vapour of	a	b
Water	333	500
Methyl-alcohol ...	375	616
Ethyl-alcohol.....	364	800
Ether	360	1000
Methyl formate...	364	1020
Ethyl propionate	312	1083
Acetone	355	1100
Ethyl formate ...	360	1110
Methyl acetate ...	369	1250
Carbon bisulphide	330	1510
Toluol	380	1610
Benzol.....	377	1670

* Bouty, *C. R.* 131, p. 503, 1900.

It will be seen that the values of a vary very little in comparison with those of b . The values of b are in nearly every case in the same order as those of $1/\lambda$, where λ is the mean free path of the molecules of the gas, and are in many cases roughly proportional to this quantity.

226. v. Röntgen* arrived at the conclusion that the spark potential for a constant spark length was inversely proportional to the mean free path of the molecules of the gas through which the spark passed; we have seen, however, that the ratio of the spark potential for different gases varies with the pressure and the spark length, so that this statement does not give complete expression to the laws of the spark-discharge. If we look at the question from the point of view of Paschen's law we see that from that law

$$V = f\left(\frac{x}{\lambda}\right),$$

where x is the spark length and λ the mean free path of the molecules of the gas; if the spark potential for different gases depended only upon the mean free path of the molecules of the gases the function f would be the same whatever were the nature of the gas; but, if this were the case the minimum potential required to produce a spark would be the same for all gases, a result which is inconsistent with the determinations made of this quantity. When the spark length is much greater than the critical value V , the potential difference required to produce a spark of length x may be expressed by the linear relation

$$V = A + B\frac{x}{\lambda},$$

where λ is the mean free path of the molecules of the gas. In the following table, p. 470, the relative values of B for a number of gases are given, the value for air being taken as unity.

There are thus very decided variations in the value of B for different gases. The results for helium and argon are very remarkable, they show that for a given increase in the potential difference, the increase in the spark length in these gases will be about ten times that in air.

* Röntgen, *Göttingen Nach.* 1878, p. 390.

We shall see that on the theory of the discharge given later, B in the above formula is the potential difference through which a corpuscle must fall in order to acquire enough energy to begin to ionise the molecules of the gas by collision.

Gas	B gas/ B air				
	PASCHEN	STRUTT	ORGLER *	RITTER†	BOUTY‡
H ₂	1·01		1·04		1·00
CO ₂	·61		·604		·65
Cl ₂				·843	
C ₂ H ₄				·632	
He		·3		·23	
Arg					·07
Hg. Vap					·76

227. Natterer§ tested for a large number of gases the length of spark produced at constant pressure by a small induction coil; the measurements made by this method are of necessity exceedingly rough but they are for many gases the only measurements we possess relating to the passage of the spark. Part of Natterer's results are given in the following table, the temperature when not stated is to be taken as about 20° C., the spark lengths are in millimetres.

It will be noticed that the spark lengths are short in vapours of complicated chemical constitution in which the mean free paths are small; the halogen elements chlorine, bromine and iodine seem to exert a great influence in shortening the spark, these elements and their compounds have short free paths.

Natterer found that the spark length was exceptionally long in the monatomic vapours of mercury and cadmium, we have seen that it is also long in the monatomic gas helium.

* Orgler, *Ann. der Phys.* i. p. 159, 1900.

† Ritter, *Ann. der Phys.* xiv. p. 118, 1904.

‡ Bouty, *Journal de Physique* [4] 2, p. 401, 1903.

§ Natterer, *Wied. Ann.* xxxviii. p. 63, 1889.

Gas	Spark length	Gas	Spark length
H ₂	15-20	HCN (80° C.)	2-3
N ₂	10-15	CO	10-14
NO	9-14	C ₂ H ₄	8-13
O ₂	8-10	C ₂ H ₆	10-13
HCl	5-7	CH ₃ OH (100° C.)	9-12
Cl ₂	2-4	CO ₂	8-11
HBr	2-3·5	CH ₃ ·CHO (100° C.)	6-8
HI	1·5-2	C ₂ H ₅ OH (110° C.) ...	7-9
Br ₂ (100° C.)	2-3	CH ₃ Cl	8-11
I ₂ (230° C.)	2·5-3	C ₂ N ₂	1·5-2
H ₂ O (130° C.)	4-7	(CH ₃) ₂ CO (100° C.)	6-9
H ₂ S	3-5	C ₂ H ₅ CHO (100° C.)	4-7
N ₂ O	3-5	C ₆ H ₅ Cl	4-7
SO ₂	1·5-2	(C ₂ H ₅) ₂ O (100° C.) ...	5-8
HgCl ₂ (271° C.)	2-2·5	CS ₂ (100° C.)	2-3
NH ₃	5-8	C ₆ H ₆ (110° C.)	7-9
PH ₃	4-7	C ₆ H ₆ S (110° C.)	4-5
S ₂ Cl ₂ (135° C.)	1·75-2	C ₂ H ₃ O ₂ C ₂ H ₅ (110° C.)	3-7
PCl ₃ (137·5° C.)	1·5-2	C ₂ H ₅ Br (100° C.)	3-3·5
AsCl ₃ (181·5° C.)	1·25-1·5	CHCl ₃ (100° C.)	1·75-2
PBr ₃ (271° C.)	1·75-2	C ₂ H ₅ Br (100° C.)	2·25-2·75
SiF ₄ (101° C.)	5-7	(CH ₃) ₂ CHBr (100° C.)	2-2·5
PCl ₃ O (153° C.)	2·25-2·5	CH ₃ I (100° C.)	2-2·25
SiCl ₄ (170° C.)	1·75-2	CCl ₄ (110° C.)	1·5-1·75
SnCl ₄ (260° C.)	1·5-1·75	C ₂ H ₅ I (100° C.)	1·75-2
CH ₄	7-10	CHBr ₃ (180° C.)	2-2·5
C ₂ H ₂	3-4	Hg(C ₂ H ₅) ₂ (195° C.)	6-7

Theory of the Electric Discharge through Gases.

228. It will assist us in coordinating the very varied phenomena attending the discharge of electricity through gases, if we at this stage endeavour to form some idea of the mechanism by which the discharge is produced. A theory of the discharge was given by the author in a paper read before the Cambridge Philosophical Society, Feb. 1900, and published in the *Philosophical Magazine*, [5] 50, p. 278, 1900. On this theory the conduction through gases is due to the presence in the gas of ions produced by the electric field itself.

We have seen that a gas is ionised, when cathode rays, *i.e.* rapidly moving corpuscles, pass through it; these cathode rays when their velocity is accelerated or retarded give out Röntgen rays, and these rays also ionise gases through which they pass. When a current of electricity passes through a gas, it is carried by

moving corpuscles and positive ions, the velocity of these depending on the strength of the electric field. The moving corpuscles are cathode rays, these ionise the gas directly by striking against the molecules, and indirectly by means of the Röntgen rays which are produced when the cathode rays come into collision with the molecules of the gas: the Röntgen rays produced in this way constitute Wiedemanns' Entladungstrahlen. Thus when there are any corpuscles present to begin with, an electric field, by setting these in motion with sufficient velocity, may produce a new supply of corpuscles, and these again may produce another generation of corpuscles and so on. It will be noticed that the collisions are the source of the ionisation, not only when this is produced directly by the impact of cathode rays, but also when it is due to the Röntgen rays, for it is by the collisions that the Röntgen rays originate. Thus when an electric force acts upon a gas in which there are corpuscles, these corpuscles will be the parents of others, and on this account the number of corpuscles will increase; on the other hand the recombination of corpuscles with positive ions to form neutral systems, and with uncharged molecules to form massive negative ions, will reduce the number of free corpuscles; if the rate of recombination exceeds the rate of production, any corpuscles originally present in the gas will tend to disappear and the gas will cease to conduct electricity, while if the rate of production exceeds the rate of recombination the number of corpuscles will increase and the gas will become a better and better conductor; in order that it should remain in a steady state the rate of recombination must equal the rate of production.

Let us now endeavour to find an expression for the energy available for ionisation: to simplify the reasoning let us suppose that the electric force X is everywhere parallel to the axis of x if λ is the free path of a corpuscle in the gas the energy of the corpuscle when it collides with the molecule of the gas will be proportional to $Xe\lambda$; the investigations we have given of the ionisation produced by cathode rays of different speeds, p. 378 show that the amount of this energy which is available for ionisation is a somewhat complicated function of the energy possessed by the corpuscle before collision; for small values of this energy the energy I available for ionisation is proportional to E , the

energy of the corpuscle, but as E increases I attains a maximum value after which it diminishes as E increases. We can show also that the energy given out as Röntgen rays varies in a similar way, attaining a maximum for a particular value of E . Let $\phi(E)$ be the amount of energy E available for ionisation; if n is the number of corpuscles per unit volume, u the velocity of the corpuscle, the number of collisions made by the corpuscle per cubic centimetre per second is nu/λ , hence the energy available for ionisation is

$$\frac{nu}{\lambda} \phi(E).$$

Now let us consider the number of ions produced by this energy; since ionisation requires a finite amount of energy, if $\phi(E)$ is less than a certain value no ions will be produced, but if the energy exceeds this value there will be ionisation increasing with the value of $\phi(E)$.

The amount of ionisation produced by a given amount of energy will evidently depend upon the nature of the gas, it may however, when there is considerable current through the gas, also depend upon the work done by the electric field on the gas; for we must remember that the molecules of the gas are exposed to the action of both cathode and Röntgen rays, and a molecule even though it may not be actually ionised by the absorption of these rays, may if it has any power of storing energy acquire internal energy and thus when any fresh radiation comes along may fall an easier victim than a molecule in the normal state. To put the same argument in a different form, suppose that an atom gets ionised when its internal energy reaches a critical value, then if it has any power of storing up energy its ionisation may be due to the combination of energy it has acquired by previous absorption of Cathode and Röntgen rays with the energy given to it by the rays falling upon it at the instant of ionisation.

229. We may express this by saying that the number of ions produced per unit volume per second is $\frac{nu}{\lambda} F(E, nuE)$, E being equal to $Xe\lambda$. When the current through the gas is small, we may neglect the effect of the energy stored up in the atoms of the gas; the number of corpuscles produced by each collision will

depend upon E alone, the number produced per second per cubic centimetre of gas will be equal to

$$\frac{nu}{\lambda} f(E), \text{ i.e. to } \frac{nu}{\lambda} f(Xe\lambda).$$

The number of corpuscles will diminish through their combination with positive ions or with neutral molecules, as the latter enormously outnumber the former, the combination with the molecules will be the most important; the number of collisions between the corpuscles and molecules per second per cubic centimetre of gas is nu/λ , if a fraction γ of these results in recombination the number of corpuscles which are lost per c.c. per second is $\gamma \frac{nu}{\lambda}$. Hence taking the gains and losses together we see that the rate of increase of the corpuscles is equal to

$$\frac{nu}{\lambda} (f(Xe\lambda) - \gamma).$$

Hence by the equation of continuity we have

$$\frac{dn}{dt} + \frac{d}{dx}(nu) = \frac{nu}{\lambda} (f(Xe\lambda) - \gamma),$$

when the current is steady, this equation becomes

$$\frac{d}{dx}(nu) = \frac{nu}{\lambda} (f(Xe\lambda) - \gamma),$$

and when the electric field is uniform this may be written as

$$\frac{d}{dx}(nu) = \alpha \cdot nu,$$

where α is independent of x and is equal to $(f(Xe\lambda) - \gamma)/\lambda$.

The solution of this equation is

$$nu = Ce^{\alpha x};$$

nu is the quantity of negative electricity passing in unit time through unit area of a plane at right angles to the axis of x at a distance x from the origin, and can be measured by placing a metal plate at this distance, connecting it with an electrometer, and measuring by means of this instrument the rate at which negative electricity is reaching the plate. A very valuable series of experiments on this effect have been made by Townsend* and

* Townsend, *Phil. Mag.* vi. 1, p. 198, 1901.

Townsend and Kirby*, who have determined the values of α for gases under different pressures and for electric fields of different intensities. The following are the values of α found by Townsend for air :

X volts per cm.	Pressure .17 mm. α	Pressure .38 mm. α	Pressure 1.10 mm. α	Pressure 2.1 mm. α	Pressure 4.1 mm. α
20	.24	—	—	—	—
40	.65	.34	—	—	—
80	1.35	1.3	.45	.13	—
120	1.8	2.0	1.1	.42	.13
160	2.1	2.8	2.0	.9	.28
200	—	3.4	2.8	1.6	.5
240	2.45	3.8	4.0	2.35	.99
320	2.7	4.5	5.5	4.0	2.1
400	—	5.0	6.8	6.0	3.6
480	3.15	5.4	8.0	7.8	5.3
560	—	5.8	9.3	9.4	7.1
640	3.25	6.2	10.6	10.8	8.9

230. Thus we see that for a given value of X , α begins by increasing with the pressure, it attains a maximum at a particular pressure, and then diminishes as the pressure increases; we see too that the larger the value of X the higher the pressure at which α is a maximum. The values given for α at the two lowest pressures show that, as the force is increased, α approaches a constant value.

These results follow at once from the value we have obtained for α , viz.

$$\alpha = \frac{f(Xe\lambda) - \gamma}{\lambda}$$

If X is constant, then at the pressure when α is a maximum,

$$\frac{d\alpha}{d\lambda} = 0,$$

or
$$\frac{f'(Xe\lambda)Xe}{\lambda} - \frac{(f(Xe\lambda) - \gamma)}{\lambda^2} = 0 \dots \dots \dots (1),$$

where
$$f'(Xe\lambda) = \frac{d \cdot f(Xe\lambda)}{d \cdot Xe\lambda} :$$

* Townsend and Kirby, *ib.* p. 630

equation (1) may be written

$$Xe\lambda f''(Xe\lambda) = f'(Xe\lambda) - \gamma \dots \dots \dots (2).$$

This equation determines the value of λ when α is a maximum; we see from the form of the equation that the solution of (2) is of the form

$$Xe\lambda = c,$$

where c is independent of both X and λ ; thus the value of λ , when α is a maximum, is inversely proportional to X , and since λ is inversely proportional to the pressure, it follows that the pressure at which α has its maximum value is proportional to X .

Townsend has shown how from the measurements of α we can deduce the free path of the corpuscle. If the ionisation is due to the collision of the corpuscle with the molecules, then unless a corpuscle can detach by one collision more than one corpuscle, the maximum number of corpuscles produced will be equal to the number of collisions; in this case we see that $\alpha = 1/\lambda$; hence α when it becomes independent of the strength of the field is equal to the reciprocal of the mean free path, *i.e.* to the number of collisions made by the corpuscle in moving over 1 cm. Thus, from the table on p. 475, we may infer that a corpuscle makes about 3.25 collisions per cm. when moving through air at a pressure of .17 mm. of mercury or 19 per cm. when the pressure is 1 mm. Townsend has shown that the numbers of collisions determined in this way agree well with the number deduced from the Kinetic Theory of Gases for the collisions between a body of negligible size and one of the size of a molecule of air. The number of collisions made by a corpuscle moving through air at a pressure of 1 mm. of mercury, as determined by the Kinetic Theory, is about 21 per cm. of path. Townsend and Kirby have shown that the numbers of collisions made by a corpuscle moving through hydrogen or carbonic acid at this pressure are respectively 11.5 and 29: these, again, agree well with the values deduced from the Kinetic Theory.

When we are dealing with corpuscles moving with the velocity of those in the Lenard rays, *i.e.* with velocities between 10^9 and 10^{10} cm./sec., the number of ions produced is much smaller than those produced by the comparatively slow corpuscles dealt

with in the preceding experiment: thus, Durack* has shown that a corpuscle moving with a velocity of 5×10^9 cm./sec. only produces about $\cdot 4$ ion when moving through 1 centimetre of air at the pressure of 1 mm. of mercury, and with the still more rapidly moving corpuscles shot out from radium the ionisation is still smaller. The effect of velocity on the ionisation was considered on p. 378.

231. In the experiments just referred to the currents were very small, the initial supply of corpuscles being obtained from metals exposed to ultra-violet light or from gases under the action of Röntgen rays, in such cases there is, when the potential difference is considerably less than that required to spark through air in its normal condition, no indication of instability in the current, nor is there any appreciable luminosity in the gas. We get a much closer approximation to the conditions existing in luminous discharges, such as sparks or electrical discharges through gases at low pressures, when we use a more abundant supply of corpuscles. Such a supply is very conveniently obtained by a method due to Wehnelt†, in this method the cathode is a platinum wire coated with a thin film of lime and raised to incandescence by an electric current. Wehnelt has shown that the incandescent lime emits copious streams of corpuscles, producing under comparatively small potential differences very large currents. I have found this method of the greatest assistance in studying the properties of the electric discharge, the conditions are easily controlled and the characteristic features of the discharge can be obtained with potential differences small enough to be measured with great accuracy.

To study the ionisation produced in the gas by the electric field I used a tube in which the lime covered cathode was fixed, while the anode, a flat disc, could be moved backwards and forwards, and the distance between the electrodes adjusted to any required value without altering the temperature of the cathode or the pressure of the gas; a series of measurements of the relation between the current through the tube and the potential difference between the electrodes was made for three distances, 1 mm., 5 mm., 10 mm., between the anode and the cathode; an example of such

* J. J. E. Durack, *Phil. Mag.* vi. 4, p. 29, 1902.

† Wehnelt, *Ann. der Phys.* xiv. p. 425, 1904.

a series is given in Table 1, the pressure of the air in the tube was in this case about .2 mm. of mercury.

TABLE 1.

Potential difference in volts between anode and cathode	Distance between Electrodes		
	1 mm.	5 mm.	10 mm.
	Galvanometer deflections	Galvanometer deflections	1 cm. = 2×10^{-7} amp.
0	0 cm.	0 cm.	0 cm.
10	.2	1.6	.5
15	1.0	5.3	1.9
20	2.4	10.7	3.8
25	6.7	22.4	7.8
30	19.9	45.1	14.3
35	56.3 (anode glow)	113 (anode glow)	39.3
37	—	—	170 (anode glow)
40	117	252	244
45	172	348	411
50	188	352	414
52	—	458 (discharge)	504 (discharge)
55	203		
56	396 (discharge)		

These results are represented by the curves in Fig. 130.

The table shows clearly the ionisation produced by the electric field, for the currents for the same potential difference were always greater when the distance between the electrodes was 5 mm. than when it was 1 mm., although in this case the average electric force was much greater for the short distance than for the large. The ionisation by the field set in in this case with potential differences less than 10 volts.

The flat part of the curves indicating a stage where the ionisation increases very slowly with the potential difference is represented as we have seen in the results obtained at low pressures with small currents. One of the most interesting features of these curves is the very rapid increase of current which occurs when luminosity sets in, in some cases at this stage the currents increase

about fortyfold for an increase of potential difference of less than $1/10$ of a volt: this enormous increase in the current involves of course a great increase in the amount of ionisation. A characteristic and suggestive feature is the abruptness with which the

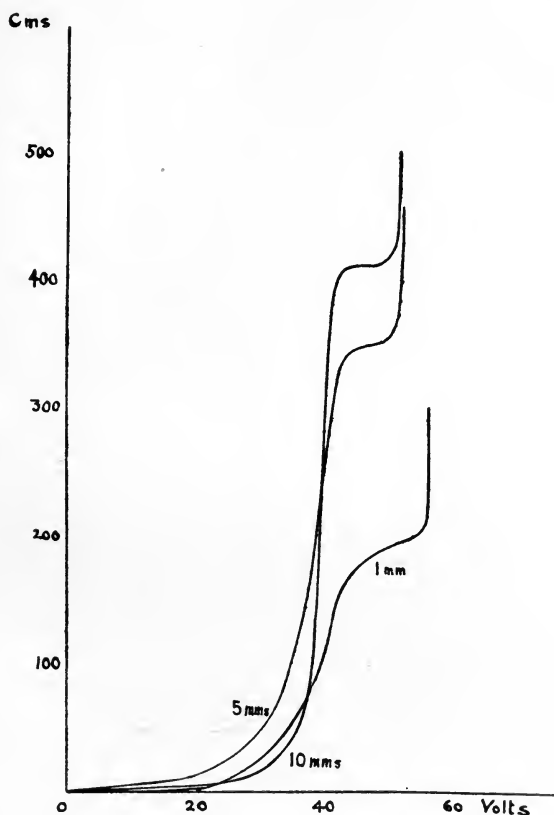

Fig. 130.

luminosity sets in; with small potential differences the whole discharge is dark, as the potential difference increases a purplish glow appears very gradually at the anode; this is not accompanied by any abrupt increase in the current; still increasing the potential, we have a stage in which all the luminosity in the gas is confined to this anode; suddenly however a blue glow quite distinct in colour and appearance from that at the anode springs from the cathode, accompanied by a large increase in the current.

Under favourable circumstances the appearance of this luminosity is exceedingly abrupt, a change of $1/10$ of a volt being sufficient to convert the discharge from a state in which no such luminosity could be detected even in a dark room to one when it was visible in broad daylight from a considerable distance.

The strength of the electric field at which this luminosity appears depends very largely on the current passing through the gas; this is shown by the curves in Fig. 130, but still more plainly in Fig. 131, which represents the change in the potential current

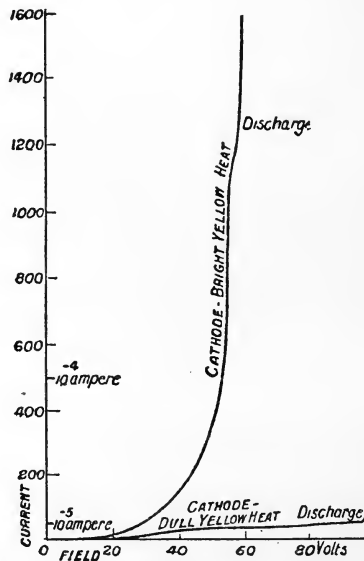

Fig. 131.

curves produced by diminishing the supply of corpuscles by lowering the temperature of the cathode; it will be seen that the potential difference required to produce luminosity with the small current is much greater than that required with the large. It is easy by altering the temperature of the cathode to pass from a state of things where a potential difference of twenty volts will produce this luminosity to one where a potential difference of several hundred is unable to do so.

We can also show the effect of current density without altering the temperature of the cathode by placing near the tube an

electromagnet, so arranged that the lines of magnetic force are parallel to the line joining the cathode and anode in the discharge tube. The effect of the magnetic force is to make the corpuscles run along the lines of force, and thus without altering the number of corpuscles emitted by the cathode it concentrates their paths and so increases the current density in the tube. When the magnet is 'on,' ionisation and luminosity occur in the tube with a lower potential than when it is 'off,' and it is easy to arrange matters so that, keeping the potential difference constant, the discharge is luminous when the magnet is on and dark when it is off. When the potential difference is too small to produce a bright discharge even when the magnet is on, the current through the tube is often greater when the magnet is on than when it is off. By placing the magnet so that the lines of magnetic force are across the line joining the anode and cathode we can render the paths of the corpuscles more diffuse than they would be without the magnetic field, so that the maximum current density is diminished by the magnet. In this case it requires a larger potential difference to produce a luminous discharge with the magnet on than with it off. Similar effects produced by a magnet on another kind of discharge are described in my 'Recent Researches,' p. 105.

232. The fact that the strength of the electric field when luminosity sets in depends upon the current density is I think an illustration of the principle enunciated in § 228, that the discharge produces a cumulative effect on the molecules of the gas in its immediate neighbourhood, and that the luminosity of an atom need not be the result of a *single* collision between a corpuscle and the atom. For if the luminosity were the result of one collision, then, since the energy of the corpuscle depends only upon the electric field and not upon the current density, the effect of increasing the current density would merely be to increase in the same proportion the number of luminous atoms; while as a matter of fact if the potential difference between the electrodes is kept constant and the current increased by raising the temperature of the cathode, the increase in the luminosity is greater out of all proportion than the increase in the current. From the abruptness with which the luminosity sets in, it would seem as if just before the discharge some of the atoms of the gas are in a critical condition, so that a

very slight increase in the strength of the electric field makes the equilibrium of the atom unstable, an explosion occurs resulting in an expulsion of corpuscles, producing an increase in the current, and such a shaking up of the atom that the energy radiated by the corpuscles in it is sufficient to produce luminosity. Thus the luminosity and ionisation which accompanies it may be regarded as arising, not from the corpuscles in the atom being dragged out by the direct action of the electric field, or from being knocked out by rapidly moving corpuscles striking against them, but rather from an explosion in the atom, due to the atom having absorbed so much internal energy that its equilibrium becomes unstable. We have already seen reasons for supposing that in the case of secondary Röntgen radiation and the emission of corpuscles by metals exposed to ultra-violet light something of this kind takes place.

To get a more definite conception of the way the instability arises, let us suppose that for the atom to become unstable and luminous its internal energy must increase until it reaches a definite value E_1 . If the energy possessed by a corpuscle were within certain limits, the effect of one collision of the corpuscle with an atom might be to give to the atom enough internal energy to make it luminous. But even if the corpuscle were less energetic, and in one collision gave a smaller amount of internal energy to the atom, it would still communicate some energy to it, and if the atom had any power of storing up energy, this would form a contribution towards the critical amount of energy required to make the atom luminous.

The atom after having had this energy communicated to it would not, as long as it retained any of it, require as much energy to make it luminous as before. The atom too might acquire energy not merely by its own collisions with corpuscles but also by the collisions of corpuscles with neighbouring atoms. Such collisions would generate soft Röntgen rays the energy of which might be absorbed by the neighbouring atoms and help to raise their energy to the critical point. The energy in these rays might by itself raise the internal energy of the atoms to this critical value or else raise it so nearly to this value that a collision with a corpuscle would give it enough energy to carry it past the critical stage. The rate at which energy comes to an atom, from collisions of corpuscles with itself and with neighbouring atoms,

will depend upon the rate at which energy is communicated by the electric field to the gas, *i.e.* it will depend upon $F \times nu$, where F is the electric force in its neighbourhood and nu the flow of corpuscles through unit area, and not merely on F itself. The atom will radiate away some of its internal energy; if the rate of this radiation at any time is proportional to E , the internal energy possessed by the atom at that time, say equal to βE , then if q is the rate at which internal energy is being communicated to the atom, we have

$$\frac{dE}{dt} = q - \beta E,$$

so that if E vanishes with t ,

$$E = \frac{q}{\beta} (1 - e^{-\beta t}).$$

Thus q/β is the limit to the internal energy acquired by the atom, and the atom will or will not acquire the critical amount of energy E_1 , according as q is greater or less than βE_1 , in the first case the atom will become luminous while in the second it will not. As q depends upon nu as well as upon F , we see that when nu is large the atom may become luminous with smaller electric fields than when nu is small. This result is a very marked feature of the discharge.

233. In the cases we have been considering, there was a source of corpuscles, in one case the hot lime, in the other Röntgen rays or ultra-violet light, independent of the electric field; this field, acting on the corpuscles produced by these agents, gives them enough energy to produce new ions by collision with the molecules of the gas through which they are moving; in this way the number of corpuscles is greatly multiplied and they become even in comparatively weak fields numerous enough to carry large currents and give rise to the luminosity characteristic of many kinds of discharge. If however there is no supply of corpuscles except those produced by the field itself, the casual presence of a few corpuscles in the gas when the field was first applied could not give rise to a permanent current through the gas. For these corpuscles would under the action of the electric field be pushed away from the cathode, and as there is no source of corpuscles in their rear would not be renewed, thus though in consequence of ionisation by collision many more corpuscles might reach the anode than were

originally present in the gas, the supply would give out after a time proportional to that required by a corpuscle to travel from one electrode to the other. The conductivity of the gas would however be maintained if the positive ions could produce ions by collision either with the molecules of the gas or with the cathode itself, for in this case as the positive ions moved backwards they would supply corpuscles to take the place of those expelled by the electric field. We have evidence that the positive ions in very strong electric fields can produce corpuscles both by collision with the molecules of a gas and with a metal electrode. The first proof of ionisation by collision of positive ions with the molecules of a gas was obtained by McClelland*, who measured the relation between the current and the potential difference when the anode was a hot platinum wire and the cathode a coaxial metal tube at the temperature of the room. The hot wire gives out as we have seen positive ions, these are repelled from the wire and carry the current through the gas. The relation between the current and the potential difference is represented by the curve in Fig. 132, in this case the pressure of the gas was $\cdot 75$ mm.

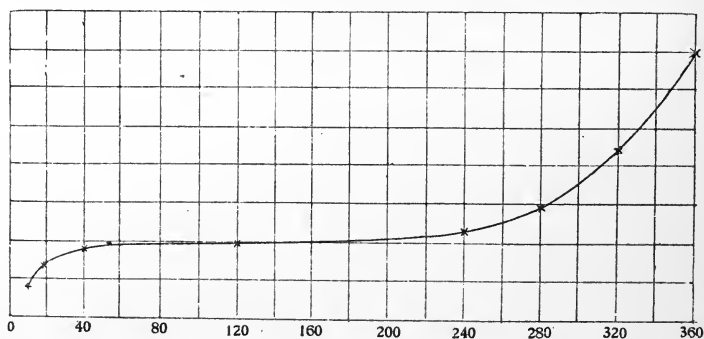

Fig. 132.

We see from this figure that the current gets saturated when the potential difference is about 80 volts and does not appreciably increase until the potential difference is 200 volts, after this it increases rapidly, indicating that ionisation by the electric field has set in, and as only positive ions start from the hot wire the ionisation must be produced by the agency of the positive ions. We see that ionisation does not begin until the potential difference is

* McClelland, *Proc. Camb. Phil. Soc.* xi. p. 296, 1901.

very large. The following experiment made by the author* shows directly the ionisation produced by the collision between rapidly moving positive ions and the molecules of a gas, and also the liberation of corpuscles by the impact of positive ions against a metal plate.

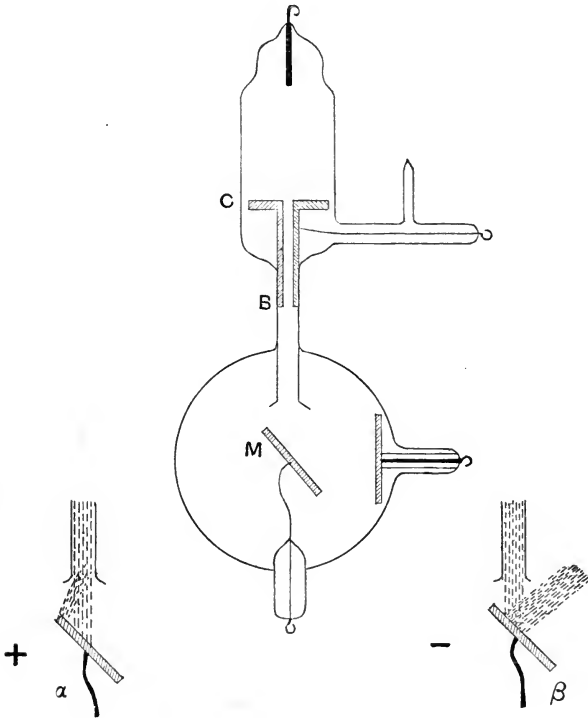

Fig. 133.

C is the cathode of a discharge tube containing gas at a low pressure, the anode is the wire at the top; the brass tube *B* is fitted into a hole in *C* so that positive ions coming from the anode to the cathode may travel down the tube and fall upon the plate *M*; this plate can be charged positively or negatively by means of a wire attached to it and passing out of the tube. The discharge through the tube was produced either by an induction coil or by a Wimshurst machine, the results were the same whichever instrument was used. The cathode *C* was earthed and a strong transverse magnetic force applied to *B* to prevent any cathode rays due to a reversal of the coil passing down the tube. That the

* J. J. Thomson, *Proc. Camb. Phil. Soc.* xiii. p. 212, 1905.

positive ions produce corpuscles when they impinge against the metal plate M can easily be shown by charging M negatively, say to a potential of 80 volts; then, proceeding from the part of the plate struck by the positive ions, a pencil of feebly luminous rays can be seen, presenting an appearance like that shown in Fig. 133, β : this pencil can by applying a magnet be shown to consist of corpuscles, for it is very easily deviated by the magnet and the direction of deflection shows that the rays are negatively charged. These rays are not projected from the plate with any great velocity, this is proved by the fact that they are completely stopped when the plate is charged positively to a potential of 2 or 3 volts.

The appearance of the beam of positive ions when M is charged positively shows that corpuscles are produced by the passage of the positive ions through the gas before they strike against the metal, for in this case the boundary of the beam of positive ions becomes fluffy and bends towards the positive plate as in Fig. 133, α ; the fluffy boundary is very susceptible to magnetic forces and the direction of the displacement shows that it is formed by corpuscles.

Austin* has also recently shown that the impact of positive ions against a metal plate makes it emit corpuscles.

234. Townsend† has measured the number of ions produced by the collision of positive ions in air and hydrogen, and Hurst‡

Air, $p=2$ mm.		Hydrogen, $p=8$ mm.		CO ₂ , $p=2$ mm.		Nitrogen, $p=4$ mm.	
X	β	X	β	X	β	X	β
700	·0282	525	·0475	1400	·0085	525	·033
		700	·059			700	·049
		1050	·164	CO ₂ , $p=1$ mm.		Nitrogen, $p=2$ mm.	
Air, $p=1$ mm.		Hydrogen, $p=4$ mm.		700	·0041	350	·025
350	·0141	350	·0295	875	·0138	525	·06
395	·022	525	·082	1050	·0353	Nitrogen $p=1$ mm.	
437	·0345	700	·214	CO ₂ , $p=.5$ mm.		350	·099
480	·048	Hydrogen, $p=2$ mm.		525	·0174	525	·15
525	·066	262	·041	700	·06	Nitrogen, $p=.5$ mm.	
Air, $p=.66$ mm.		350	·107	875	·079	262·5	·074
350	·049	Hydrogen, $p=1$ mm.		CO ₂ , $p=.25$ mm.			
437	·084	262	·202	525	·089		
525	·12	350	·33				

* Austin, *Phys. Rev.* xxii. p. 312, 1906.

† Townsend, *Phil. Mag.* [6] 6, p. 598, 1903.

‡ Hurst, *Phil. Mag.* [6] 11, p. 535, 1906.

the number in CO_2 and nitrogen at different pressures and in electric fields of different strengths, some of their results are given in the Table on the preceding page: X represents the force acting on the positive ion expressed in volts per centimetre, β the number of ions produced by a positive ion per cm. of path, and p the pressure.

It will be noticed that the positive ions produce many more ions in hydrogen than they do in air, and a comparison with the results given on p. 475 shows that the number produced by the positive ions is small compared with that produced by the corpuscles; the values of β for nitrogen are considerably larger than the corresponding values for air.

235. Before attempting to obtain by the principles we have been discussing the connection between spark potential, spark length and pressure it will be helpful to consider some facts as to the distribution of electric force along the spark, obtained by the study of the discharge at low pressures when the structure of the discharge is much more obvious than it is at atmospheric pressure. This structure as we shall see later shows many variations, but an example which may be taken as typical is that shown in Fig. 134.



Fig. 134.

The distribution of electric intensity along the line of discharge is shown in Fig. 135. Next to the cathode there is a dark space

called the Crookes dark space, the thickness of which does not depend upon the distance between the electrodes, then comes a luminous piece called the negative glow, then comes a dark space

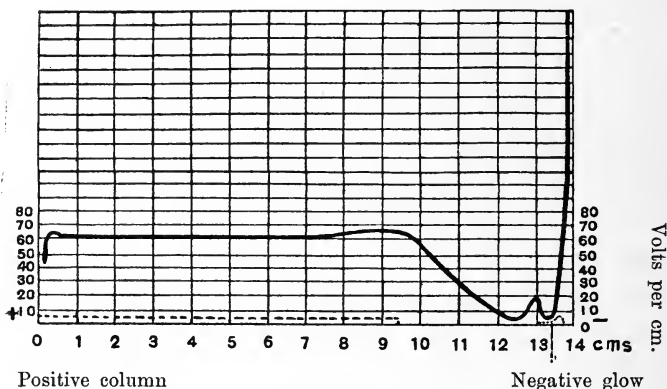

Fig. 135.

called the Faraday dark space, and then a stretch of luminosity reaching to the anode, called the positive column. From the curve giving the electric intensity we see that this is approximately uniform along the positive column; but that in the Crookes dark space the electric intensity is very much greater. The potential difference between the cathode and the negative glow, called the cathode potential fall, is as we shall see later independent of the pressure of the gas and of the distance between anode and cathode, as long as this is greater than the thickness of the dark space. Recent measurements made by Strutt have proved that the cathode fall of potential is equal to the minimum spark potential. We see, too, that it is only in the Crookes dark space that the electric intensity is greater than in the uniform positive column, it is therefore only in this space that the positive ions would be likely to produce fresh ions by collisions with molecules of the gas. To sum up we have a uniform electric intensity along the positive column and a variable but very much greater intensity inside the Crookes dark space. The thickness of the dark space does not depend upon the distance between the electrodes, so that the further these are apart the longer the region of uniform electric intensity along the positive column.

The distribution of electric force given in Fig. 135 shows that it is only close to the cathode that the positive ions can, in a space comparable with the free path of an ion, fall through the potential

difference necessary to give them enough energy to produce ions by collision with molecules of the gas or by impact against a metal plate. As it is only in a thin layer of gas close to the electrode that the positive ions can produce fresh ions by collisions with the gas, the number of ions produced in this thin layer will probably be very small compared with those produced by collision with the cathode itself, and in any case since the seat of production of corpuscles by the collision of positive ions is close to the surface of the cathode, the mathematical development of the consequences of this production will proceed along the same lines whether the gas produces an appreciable fraction of the corpuscles or not.

Suppose then we have two parallel metal plates with a strong electric field between them, then when a current of electricity passes through the gas between the plates, the positive ions are driven up against the cathode with such a high velocity that they cause the cathode to emit a stream of corpuscles. These corpuscles driven off from the cathode acquire under the electric field sufficient energy to ionise the gas, producing positive ions which strike against the cathode and produce corpuscles by their impact. Thus the corpuscles driven from the cathode and the positive ions in the gas are mutually dependent on each other, the positive ions producing the corpuscles and the corpuscles the positive ions; the two streams, positive ions in one direction, corpuscles in the opposite, are inseparably connected and if one disappears the other must disappear also.

This mutual dependence of the corpuscles and the positive ions is shown in a very beautiful way, in some experiments made by

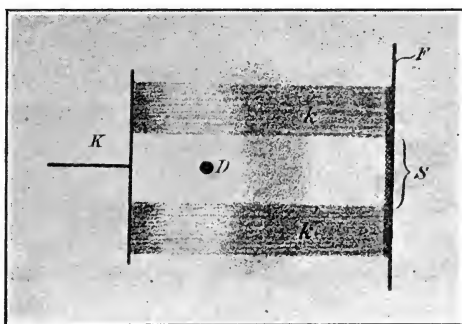

Fig. 136.

Schuster* and Wehnelt† on the effect of placing solid obstacles in the Crookes dark space, these obstacles cast a shadow on the cathode and there is no emission of cathode rays from the region of this shadow. This effect is illustrated in Fig. 136, taken from Wehnelt's paper; in this figure D is the obstacle, K the cathode.

236. We shall now proceed to calculate the relation between V the potential difference and d the distance between the plates; we shall suppose that the current is small so that there are not enough ions between the plates to appreciably disturb the uniformity of the electric field: thus the potential difference between the cathode and a point distant x from it will be $\frac{Vx}{d}$. If n is the number of corpuscles and u the velocity of the corpuscles at this point the number of positive ions produced by them in a layer of thickness δx is proportional to $nu\delta x$, let it be equal to $\alpha nu\delta x$; if the positive ions had an uninterrupted fall to the cathode they would reach it with an amount of energy $\frac{Vxe}{d}$, where e is the charge on the ion, but the energy will be less than this (1) because the ions lose some of their energy by collision before they reach the cathode and (2) because some of the ions recombine during the journey and so do not reach the cathode at all; we shall suppose that on the average the energy possessed by the positive ions when they reach the cathode is $\frac{Vex}{d} \epsilon^{-\beta x}$, thus the energy given to the cathode in unit time by the positive ions is

$$\int_0^d \alpha nu \frac{Vex}{d} \epsilon^{-\beta x} dx,$$

we have also

$$\frac{d}{dx}(nu) = \alpha nu,$$

thus

$$nu = n_0 u_0 e^{\alpha x},$$

where $n_0 u_0$ is the stream of corpuscles coming from the cathode: but the emission of corpuscles from the cathode is due to the impact of the positive ions; if we suppose that the number of corpuscles emitted in unit time is proportional to the energy given

* Schuster, *Proc. Roy. Soc.* xlvi. p. 557, 1890.

† Wehnelt, *Wied. Ann.* lxvii. p. 421, 1899.

up to the cathode by the positive ions in that time we have

$$n_0 u_0 = k \int_0^d \alpha n u \frac{V e x}{d} \epsilon^{-\beta x} dx,$$

where k is a constant.

Substituting for nu the value $n_0 u_0 \epsilon^{\alpha x}$ we get

$$\begin{aligned} 1 &= k \frac{V e}{d} \alpha \int_0^d \epsilon^{\alpha x} x \epsilon^{-\beta x} dx, \\ &= k \frac{V e}{d} \alpha \left\{ \frac{d}{\alpha - \beta} \epsilon^{(\alpha - \beta)d} - \frac{\epsilon^{(\alpha - \beta)d}}{(\alpha - \beta)^2} + \frac{1}{(\alpha - \beta)^2} \right\}, \end{aligned}$$

or

$$V = \frac{\alpha - \beta}{\alpha} \frac{1}{k e} \left\{ \frac{1}{\epsilon^{(\alpha - \beta)d} - \frac{\epsilon^{(\alpha - \beta)d}}{d(\alpha - \beta)} + \frac{1}{d(\alpha - \beta)}} \right\} \dots\dots(1).$$

This equation gives the relation between the potential difference and the distance between the electrodes.

Now α is proportional to $1/\lambda$, and β to $1/\lambda'$, where λ is the mean free path of a corpuscle and λ' that of a positive ion in the gas; as long as we keep to the same gas both λ and λ' will be proportional to L the mean free path of a molecule of the gas, thus both α and β are proportional to the pressure, and therefore $(\alpha - \beta)/\alpha$ will be independent of the pressure; we see from (1) that V is a function of pd , where p is the pressure, thus Paschen's law is obeyed.

We see that when $d = 0$, V is infinite, thus it would be impossible to produce indefinitely short sparks by the mechanism we are discussing; when we considered, see p. 455, such sparks we suggested that they arose in a different way.

The denominator of the right-hand side of equation (1) is a maximum and therefore V is a minimum, when d has the value determined by the equation

$$\frac{d}{dx} \left(\epsilon^x - \frac{\epsilon^x}{x} + \frac{1}{x} \right) = 0,$$

where x is written for $(\alpha - \beta)d$. Thus x is a solution of the equation

$$\epsilon^x (x^2 - x + 1) = 1,$$

or $x = -1.8$ approximately, thus the spark length for minimum potential is $\frac{1.8}{\beta - \alpha}$, and the minimum potential V_0 is given by

the equation

$$V_0 = \frac{\beta - \alpha}{\alpha} \frac{2 \cdot 2}{ke} \dots\dots\dots(2).$$

Since α and β are both inversely proportional to the mean free path of the molecules of the gas, *i.e.* are directly proportional to the pressure, the critical spark length on this theory would vary inversely as the pressure, this as we have seen is the case. Since $\frac{\alpha}{\beta - \alpha}$ is independent of the pressure, the minimum potential difference required for discharge will be independent of the pressure.

If l is the critical spark length, and V_0 the minimum spark potential, we have, by equation (2) putting $\alpha = 1/\lambda$, where λ is the mean free path of a corpuscle in the gas at the critical pressure,

$$V_0 = \frac{\lambda}{l} \frac{1 \cdot 2}{ke}.$$

Now by the definition of k , $1/ke$ is the potential difference through which one positive ion must fall to liberate one corpuscle from the cathode, if we call this potential difference U , we have

$$V_0 = 1 \cdot 2 \frac{\lambda}{l} U.$$

Since l is considerably greater than λ , V_0 is less than U . For air λ/l is about 10, so that $V_0 = \cdot 12U$.

237. So far we have supposed that the ionisation produced by the positive ions takes place at the surface of the cathode, we can easily extend the method so as to take into account the ionisation produced by the positive ions throughout the volume of the gas.

Let m be the number of positive ions per unit volume, w their velocity, the number of collisions made per sec. per c.c. by these ions will be proportional to mwp , where p is the pressure of the gas; let the number of ions which in one second will result from these collisions be γmw , γ will be a function of the p and of the strength of the electric field, it will vanish when the strength falls below a certain critical value depending on the pressure. Let as before n be the number of corpuscles per c.c., u their velocity and anu the number of ions which in one second results from the collisions

between the corpuscles and the gas. The number of ions produced per sec. per c.c. is equal to

$$\alpha nu + \gamma mw,$$

hence when things are in a steady state we have by the equation of continuity

$$\frac{d}{dx}(nu) = \alpha nu + \gamma mw,$$

$$-\frac{d}{dx}(mw) = \alpha nu + \gamma mw,$$

$$e(nu + mw) = i,$$

where i is the current per sq. centimetre and e the charge on an ion.

Hence we have

$$\frac{d}{dx}(nu) = (\alpha - \gamma) nu + \frac{\gamma i}{e},$$

the solution of which is, when the field is uniform so that α and γ are independent of x ,

$$enu = C e^{(\alpha - \gamma)x} - \frac{\gamma i}{\alpha - \gamma},$$

where C is a constant of integration.

If there is no emission of positive ions from the anode, then when $x = d$, $enu = i$; determining C from this condition we have

$$enu = \frac{i}{\alpha - \gamma} \{ \alpha e^{(\alpha - \gamma)(x-d)} - \gamma \};$$

the flow of corpuscles from the cathode is got by putting $x = 0$ in the expression for nu and is therefore equal to

$$e \frac{i}{(\alpha - \gamma)} \{ \alpha e^{-(\alpha - \gamma)d} - \gamma \}.$$

This, on the assumption of the preceding paragraph, is equal to k times the energy given to the cathode per second.

We can calculate this energy as before; the number of positive ions produced per second in a layer of thickness dx at a distance x from the cathode is

$$\frac{d}{dx}(nu) dx, \text{ i.e. } \frac{i}{e} \alpha e^{(\alpha - \gamma)(x-d)} dx,$$

the energy given up by these to the cathode is

$$\frac{i}{e} \alpha \epsilon^{(\alpha-\gamma)(x-d)} \frac{Vex}{d} \epsilon^{-\beta x} dx,$$

hence the energy given to the cathode per second by the positive ions is

$$i\alpha \frac{V}{d} \epsilon^{-(\alpha-\gamma)d} \int_0^d \epsilon^{(\alpha-\gamma)x} x \epsilon^{-\beta x} dx,$$

and therefore

$$\frac{i}{\alpha-\gamma} (\alpha \epsilon^{-(\alpha-\gamma)d} - \gamma) = ki\alpha \frac{Ve}{d} \epsilon^{-(\alpha-\gamma)d} \int_0^d \epsilon^{(\alpha-\gamma)x} x \epsilon^{-\beta x} dx,$$

or

$$\frac{\alpha - \gamma \epsilon^{(\alpha-\gamma)d}}{\alpha - \gamma} = k\alpha \frac{Ve}{d} \left\{ \frac{d}{\alpha - \gamma - \beta} \epsilon^{(\alpha-\gamma-\beta)d} - \frac{\epsilon^{(\alpha-\gamma-\beta)d}}{(\alpha - \gamma - \beta)^2} + \frac{1}{(\alpha - \gamma - \beta)^2} \right\} \dots (3),$$

an equation giving V/d in terms of d , when we know the expression for γ in terms of V/d .

We see from this equation that V is infinite when $d = 0$, and when d is infinite, hence again there will be a minimum potential difference and a critical spark length; we see too from the equations that the minimum potential will be less when both γ and k are finite than when either vanishes.

The left-hand side of equation (3) cannot be negative, the term ϵ^{ad} increases rapidly with d so that when the distance between the plates is a very large multiple of the mean free path of a corpuscle, the left-hand side would become negative unless γ were exceeding small. For values of d , large compared with the critical spark length, the right-hand side of (3) is

$$k\alpha \frac{Ve}{d(\alpha - \gamma - \beta)^2},$$

hence remembering that γ is small compared with α equation (3) becomes

$$\gamma = \alpha \epsilon^{-ad} - k\alpha^2 \frac{Ve}{d} \frac{\epsilon^{-ad}}{(\alpha - \beta)^2} \dots \dots \dots (4).$$

Now γ is a function of V/d , and in the expression for γ in powers of V/d the coefficients of V/d will not, like that of V/d on

the right-hand side of (4), diminish as d increases, hence when d is very large we may neglect the second term on the right-hand side of (4) and the equation reduces to $\gamma = \alpha e^{-ad}$.

This equation enables us to find V/d , if we know the way the ionising power of the positive ions depends on the strength of the electric field. When d is very large we have $\gamma = 0$, hence discharge will begin practically as soon as the field is strong enough to give the positive ions any ionising power at all.

In this case the strength of the electric field is uniform from one electrode to another, this must be the case unless there is free electricity between the electrodes, and when the field is uniform the positive ions produce ions all along the spark. To maintain the discharge it is sufficient that the positive ions should produce fresh ions in the neighbourhood of the cathode, the cathode will then be analogous to the hot lime cathode described on page 477, and a very moderate electric field between this and the anode will be sufficient to produce the discharge. Thus if instead of having the field uniformly distributed from anode to cathode we concentrate the field near to the cathode, leaving the rest of the field comparatively weak, a smaller potential difference will maintain the discharge than if the field were uniform. This concentration of the field requires the presence of large quantities of free ions near the cathode, and until these accumulate the field will be uniform. If the uniform field to begin with were strong enough to make the corpuscles produce ions by their collisions, but not strong enough to make the positive ions do so, there would be a finite accumulation of free ions, the amount of which would depend on the number of corpuscles present originally and upon the strength of the field: if this accumulation were sufficient to make the field close to the cathode strong enough to give rise to ionisation by positive ions a current would pass; if not there would be no discharge, and the potential difference between the electrodes would have to increase until the positive ions produced other ions by collision, *i.e.* would have to increase until γ became finite. When once a spark passes, ions are produced in great abundance and there is an ample supply to produce the requisite concentration at the cathode; thus after a spark has once been started it may happen that a smaller potential difference is sufficient to maintain it, or produce another spark following soon after the first.

The difference between a continuous discharge and the first spark is well shown in the difference between the appearance presented by the discharge through a gas at low pressure of a continuous current, and an instantaneous discharge produced by discharging a charged Leyden jar of large capacity across an air gap placed in series with the discharge tube; the first discharge shows the highly differentiated appearance represented in Fig. 134, the second is a uniform column of light stretching without any dark space from cathode to anode.

238. There are some cases in which a field sufficiently intense to cause corpuscles to produce ions might produce a continuous discharge without the necessity of the positive ions acting as ionisers; thus if the lines of electric force formed closed curves, as they do when the field is produced by electromagnetic induction, the corpuscles travelling round these, and not as in the case of discharge between electrodes being driven out of the gas into electrodes, would go on producing a continually increasing supply of other corpuscles and a discharge would pass. Another case is when the electric force is continually changing its direction; thus suppose *A* and *B* are the electrodes and to begin with *A* is the cathode, let the field be sufficiently strong for the corpuscles to produce ionisation, by collisions, when the field is applied the number of corpuscles between the plates will increase and there will be many more corpuscles in the neighbourhood of *B* than there were originally, if the field continued in one direction these would be driven into *B* and disappear from the gas; if we reverse the field before this occurs then the corpuscles near *B* will be driven back towards *A* and will produce other corpuscles; if we again reverse the field before these have reached *A*, they will again be driven back and produce other corpuscles, in this way the number of corpuscles in the field will increase in geometrical progression and a discharge will ultimately pass. A rapidly alternating potential difference may thus produce a discharge while a constant potential difference of the same magnitude would be unable to do so.

If the supply of ions is sufficient to make the electric field near the cathode so strong that the positive ions can ionise the gas, the potential will be distributed so that, starting from the cathode, there is a rise of potential equal to the minimum spark

potential in a distance equal to the critical spark length, in this region there is rapid production of corpuscles, which stream out towards the anode; as we have got this supply of corpuscles it is not necessary that the rest of the field should be strong enough to make the positive ions act as ionisers, indeed there would be a current if no further ionisation even by corpuscles took place, but in this case there would be an excess of negative electricity along the path of the corpuscles and the intensity of the electric force would increase rapidly towards the anode.

If, as in the case shown in Fig. 135, the electric force in the part of the field not in the immediate neighbourhood of the cathode is uniform, there can be no free electricity in this part of the field, so that positive ions as well as corpuscles must be present, thus the corpuscles must produce ionisation; when the conditions do not alter with the distance from the anode $d(nu)/dx = 0$, hence, see page 473 we have

$$F(Xe\lambda, i) = \gamma,$$

the solution of this is $X\lambda = c$, where c may involve i , the intensity of the current through the gas; thus along the uniform column $X = \frac{c}{\lambda}$, and the fall of potential along this column is, if l is the length of the column, $Xl = \frac{cl}{\lambda}$, hence if V is the difference of

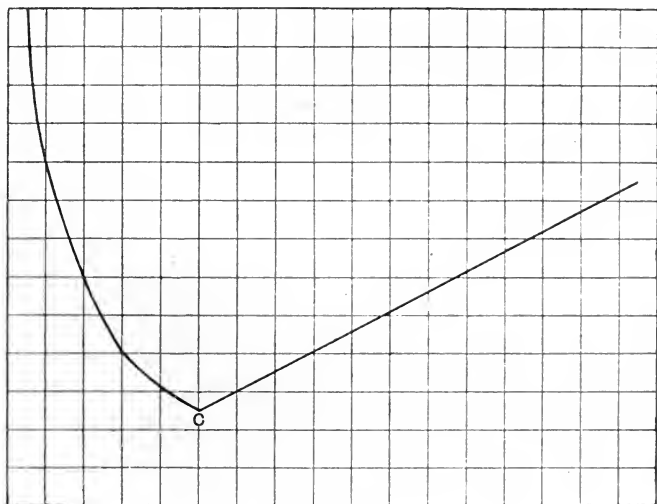

Fig. 137.

potential between the electrodes, V_0 the minimum spark potential, then

$$V = Xl + V_0 = \frac{cl}{\lambda} + V_0 \dots\dots\dots(2);$$

if we combine the results represented by this equation with those for sparks shorter than the critical value, the connection between spark potential and spark length will be represented by a curve such as that represented in Fig. (137), this it will be seen presents the characteristics of the curves given by Carr.

It must be remembered that these results refer to the continuous discharge, it may, as was pointed out, require a much greater potential difference to produce the first spark, where positive ions may have to produce other ions all along their paths.

Discharge of Electricity from Points.

239. A very interesting case of electric discharge is that between a sharply pointed electrode, such as a needle, and a neighbouring metallic electrode of considerable area. In this case when the current is small the luminosity is confined at atmospheric pressure to the neighbourhood of the electrode, the current through the rest of the gas is carried almost entirely by ions of the same sign as the charge on the point.

Chattock (see page 68) has shown that the velocity of these ions under unit electric force is the same as that of the ions produced by Röntgen or Becquerel rays, and Townsend (see page 39) has shown that the charge on the ions is also the same. If the point is placed at right angles to a large metal plane, then for electricity to stream from the point the potential of the point must exceed that of the plane by an amount called by v. Röntgen* the minimum potential; this minimum potential depends upon the sharpness of the point, the pressure and nature of the gas and the sign of the electrification of the point, being less if the point is negatively than if it is positively electrified; according to Warburg†, the minimum potential does not depend upon the distance of the point from the plane; Sieveking‡ found that this was only

* v. Röntgen, *Göttingen Nach.* p. 390, 1878.

† Warburg, *Wied. Ann.* lxvii. p. 69, 1899.

‡ Sieveking, *Ann. der Phys.* i. p. 299, 1900.

true when the distance between the point and the plane was considerable, for short distances the minimum potential increased rapidly with the distance. When the potential difference between the point and the plane exceeds the 'minimum potential' a current of electricity passes from the point to the plane; the magnitude of this current for a given potential difference between the point and the plane rapidly diminishes as the distance from the plane increases: Warburg (*l.c.*) has shown that if d is the shortest distance between the point and the plane, then for a given difference of potential the current is proportional to $1/d^{3.17}$, this law holds whatever be the sharpness of the point.

Value of the Minimum Potential.

240. As this depends upon the sharpness of the point we can only compare the values of this quantity for the same point under different circumstances. The following table gives the value for the minimum potential with the same point at different pressures as determined by Tamm*:

Pressure in cm. of mercury	Point -	Point +
76	2140 volts	3760 volts
70	2135 "	3755 "
60	2105 "	3705 "
50	2035 "	3585 "
40	1905 "	3350 "
30	1690 "	2970 "
20	1360 "	2390 "
10	910 "	1580 "

Thus the change in the minimum potential with the pressure is very slow when the pressures are high but becomes much faster at lower pressures.

The ratio of the minimum potential for positive and negative points is approximately the same at all pressures. Observations of the minimum potential in different gases have been made by v. Röntgen† and by Precht‡; the results of their observations are

* Tamm. *Ann. der Phys.* vi. p. 259, 1901.

† v. Röntgen, *Göttingen Nach.* 1878, p. 390.

‡ Precht, *Wied. Ann.* xlix. p. 150, 1893.

given in the following table, the numbers in the first two columns are due to v. Röntgen, those in the third and fourth to Precht.

Gas	Minimum potential, point +		Minimum potential, pressure 760 mm.	
	Pressure 205 mm.	Pressure 110 mm.	Point +	Point -
H ₂	1296 volts	1174 volts	2125 volts	1550 volts
O ₂	2402 "	1975 "	2800 "	2350 "
CO	2634 "	2100 "		
CH ₄	2777 "	2317 "		
NO	3188 "	2543 "		
CO ₂	3287 "	2655 "	3475 "	2100 "
N ₂			2600 "	2000 "
Air			2750 "	2050 "

Gorton and Warburg* give the following values for M the minimum potential from the same point in different gases.

Gas	Pressure 760 mm.			Pressure 485 mm.		
	+ M	- M	$\frac{+M}{-M}$	+ M	- M	$\frac{+M}{-M}$
H ₂	1370	1140	1.20	1120	1000	1.12
N ₂	1930	1400	1.36	1630	1200	1.36
O ₂	2550	1950	1.31	—	—	—
Air	2250	1660	1.35	1930	1500	1.29
Cl ₂	2680	1900	1.41	2400	1660	1.45
Br ₂				2500	1700	1.47
I ₂				2620	1870	1.40

Ewers† has recently shown that if M_A is the minimum potential at the pressure p_A , M_B that at the pressure p_B , then

$$M_A - C = (M_B - C) \sqrt{\frac{p_A}{p_B}},$$

where C is independent of the pressure.

* Gorton and Warburg, *Ann. der Phys.* xviii. p. 1905.

† Ewers, *Ann. der Phys.* xvii. p. 781, 1905.

Connection between Potential Difference and Current.

241. Warburg (*l.c.*) found that using the same point and keeping it at the same distance from the plate the relation between the current i and the potential V can be expressed by the relation

$$i = aV(V - M),$$

where M is the minimum potential. Sieveking* considered that the linear relation $i = b(V - M)$ represented his experiments with sufficient accuracy: in a recent paper by Tamm† this question is discussed, and a formula of the type of Warburg shown to give better agreement: in place of the minimum potential M Tamm writes $\frac{1}{2}(M_1 + M_2)$, where M_1 is the potential at which the discharge begins when the potential is gradually increased, M_2 that at which it leaves off when it is gradually lowered; the two are not identical, the latter being the smaller: the application of the formula in this form is limited to potential differences considerably greater than M .

Ewers‡ has shown that for the monatomic gases Helium and Argon, at all temperatures and pressures,

$$i^{\frac{1}{2}} = aV + b.$$

This relation holds for diatomic gases at low pressures and at low temperatures, at higher temperatures and pressures the relation for these gases is

$$i^{\frac{2}{3}} = a'V + b'.$$

The current with the same potential difference increases as the pressure diminishes, this is shown by the following results due to Tamm (*l.c.*). (See Tables, p. 502.)

It will be noticed that the current with the point positive is always less than that with the point negative, the potential difference being the same in the two cases. The increase of the current as the pressure diminishes is more rapid at small pressures than at high pressures; the current seems to be roughly proportional to the reciprocal of the pressure, while at low pressures it varies as the square of this quantity.

* Sieveking, *Ann. der Phys.* i. p. 299, 1900.

† Tamm, *Ann. der Phys.* vi. p. 259, 1901.

‡ Ewers, *Ann. der Phys.* xvii, p. 781, 1905.

Tamm gives as the relation between i_x the current at a pressure of x centimetres, and i_{76} the current at 76 cm. pressure, the potential difference being V in both cases, the empirical equation

$$i_x = i_{76} \left\{ \frac{76}{x} - \sqrt[3]{\frac{V}{10^5} \log \frac{76}{x}} \right\}^2.$$

Current in micro-ampères.

Potential difference... Pressure	- 4000	- 6000	- 8000	- 10000
76	1.4	4.2	8.0	13.4
70	1.6	4.6	8.6	14.5
60	2.0	5.7	10.5	17.6
50	2.6	7.8	13.7	22.8
40	3.7	11.3	20.4	33.7
30	6.8	19.5	35.3	58.0
20	14.6	44.7	80.9	134.2

Potential difference... Pressure in cm. of Hg.	+ 4000	+ 6000	+ 8000	+ 10000
76	0.7	2.1	4.8	9.3
70	0.8	2.3	5.1	10.1
60	1.0	2.8	6.3	12.3
50	1.3	3.8	8.2	16.0
40	1.9	5.6	12.3	23.5
30	3.3	9.7	21.1	40.4
20	7.3	22.4	48.0	93.0

242. The relation $\sqrt{i} = aV + b$ is, as the following investigation shows, the one indicated by theory when the current is carried entirely by ions of one sign.

Relation between the current from a point and the potential difference between the point and the plane to which it discharges.

In order to simplify the mathematical analysis we shall take a case which, while presenting the same physical features as the point discharge from a needle, is yet from its symmetry more amenable to calculation, the case is that of the discharge from a very fine wire discharging to a coaxial cylinder. Almy* has made

* Almy, *American Journal of Science* [4], xii. p. 175, 1902.

a series of experiments on this kind of discharge. Let us take a point on the wire as the origin for polar coordinates and let r be the distance of a point in the gas from the wire, R the electric force at this point and ρ the density of the electrification, then we have

$$\frac{d}{dr}(Rr) = 4\pi\rho r \dots\dots\dots(1).$$

When we get beyond the region of the spark the discharge will be carried by ions of one sign, hence if ι is the current per unit length of the wire, u the velocity of the ions, we have

$$\iota = 2\pi r u \rho ;$$

but $u = kR$, where k is the velocity of the ion under unit force, hence we have from equation (1)

$$\frac{d}{dr}(Rr) = \frac{2\iota}{kR} ;$$

integrating this equation, we get

$$(Rr)^2 = \frac{2\iota}{k} r^2 + C \dots\dots\dots(2),$$

where C is a constant. To determine C , let a be the smallest value of r , for which the ions are all of one sign (a will exceed the radius of the wire by a quantity of the order of the minimum spark length); when $r = a$, R will be comparable with the electric force required to produce a spark; thus R will at atmospheric pressure be greater than 10^2 in electrostatic units: in these units k for air at this pressure is 450, hence unless ι were comparable with the value 2×10^6 in electrostatic measure, *i.e.* with $\frac{2}{3} \times 10^{-3}$ ampères, which is much larger than the currents used by observers of the spark discharge, $(2\iota/k)a^2$ will be small compared with $(Ra)^2$, *i.e.* C will be approximately independent of the current, and at the surface of the wire C will be large compared with $\frac{2\iota}{k} r^2$.

At the surface of the cylinder, on the other hand, in general, $2\iota r^2/k$ will be large compared with C , for suppose the radius of the cylinder were 10^3 times that of the wire, then a current of a few micro-coulombs per second (which is of the order of the currents used by Tamm in his experiments) would make $2\iota r^2/k$ at the surface of the cylinder very large compared with $(Ra)^2$ and therefore with C .

If V is the potential at the distance r from the wire, we have from (2)

$$\frac{dV}{dr} = \frac{1}{r} \left\{ \frac{2\iota}{k} r^2 + C \right\}^{\frac{1}{2}};$$

integrating this equation we find, if V' is the potential difference between the cylinder and the point near the wire where the current begins to be carried by ions of one sign, and b is the radius of the cylinder,

$$V' = \left\{ \frac{2\iota}{k} b^2 + C \right\}^{\frac{1}{2}} - \left\{ \frac{2\iota}{k} a^2 + C \right\}^{\frac{1}{2}} + \frac{1}{2} \sqrt{C} \log \frac{\left\{ \frac{2\iota}{k} b^2 + C \right\}^{\frac{1}{2}} - C^{\frac{1}{2}}}{\left\{ \frac{2\iota}{k} b^2 + C \right\}^{\frac{1}{2}} + C^{\frac{1}{2}}} - \frac{1}{2} \sqrt{C} \log \frac{\left\{ \frac{2\iota}{k} a^2 + C \right\}^{\frac{1}{2}} - C^{\frac{1}{2}}}{\left\{ \frac{2\iota}{k} a^2 + C \right\}^{\frac{1}{2}} + C^{\frac{1}{2}}},$$

where ι is so large that $2\iota b^2/k$ is large compared with C ; this becomes approximately,

$$V' = \left(\frac{2\iota}{k} b^2 \right)^{\frac{1}{2}} + \frac{1}{2} \sqrt{C} \log \frac{2C}{\frac{\iota}{k} a^2};$$

the second term on the right-hand side varies very slowly with ι , treating it as a constant and writing α for this term, we get

$$\frac{2\iota}{k} b^2 = (V' - \alpha)^2 \dots\dots\dots(1);$$

if V is the potential difference between the wire and the cylinder we have seen that $V = V' + V_0$, where V_0 is the least potential that can produce a spark (for air it is about 351 volts), thus we have from (1)

$$\iota = \frac{k}{2b^2} (V - V_0 - \alpha)^2 \dots\dots\dots(2),$$

so that for large values of V , ι varies as V^2 ; thus the current varies as the square of the potential difference. Almy* found that the current was proportional to $V(V - \beta)$, thus for values of V large compared with β it is proportional to V^2 ; according to

* Almy, *American Journal of Science* [4], xii, p. 175, 1902.

Almy's experiments the current is more nearly proportional to the inverse cube of the radius of the cylinder than to the inverse square as indicated by equation (2); it is to be noted that any want of symmetry in the apparatus which would make the discharge tend to concentrate on a particular radius would make the current vary more rapidly with the radius than if the discharge were quite symmetrical. We see from equation (2) that the current varies as k , the velocity of the ion under unit force, thus since the negative ion moves faster than the positive, the discharge under given potential should be greater when the point is negative than when it is positive; from Tamm's observations the ratio of the negative current to the positive in air at atmospheric pressure is equal to 1.44, this is not far from the ratio of the velocities of the negative and positive ions for dry air.

Again, since ι is proportional to k , and k is inversely proportional to the pressure, the current should vary inversely as the pressure when the potential difference is large; a reference to the table on page 502 will show that although this is approximately true at high pressures it ceases to be an approximation to the truth when the pressure is low, when the current varies more nearly as the inverse square of the pressure. At low pressures and with large currents the discharge is accompanied by luminosity right up to the plate; an example of this is shown in Fig. 138, taken from a paper by v. Obermayer*: the appearance presented by the

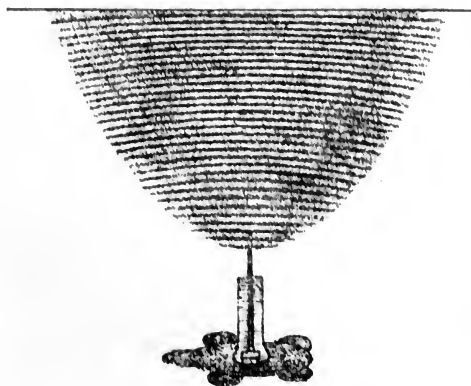

Fig. 138.

* v. Obermayer, *Wien. Sitzungsberichte*, c. p. 127, 1891.

discharge suggests that ionisation is taking place at the plate as well as at the point, in which case ions of both signs would be present between the plate and the point, and our investigation which is founded on the supposition that the current is carried entirely by ions of one sign would not apply. Even at atmospheric pressure there is evidence in some cases of the presence of ions of opposite sign to that of the electrification of the discharging point: thus C. T. R. Wilson* notices a case in which when a positive point was discharging into his expansion apparatus (see p. 166) an expansion which was sufficient to bring down negative but not positive ions produced a cloud, showing that negative ions were present; a similar effect has also been observed by N. R. Campbell†.

We shall see that from a spark rays are given out (Entladungstrahlen) which can ionise a gas; some rays are thus given out from the small spark at the end of the discharging point, and these rays may in certain cases help to produce appreciable ionisation at a considerable distance from the point. The discharge from a point seems to possess very considerable actinic power‡.

243. Warburg§ has shown that the presence of minute traces of oxygen in gases such as hydrogen or nitrogen produces a great diminution in the current from a negative point while it has but little effect on that from a positive one; thus the removal of a trace of oxygen from nitrogen increased the current from a negative point in that gas *fifty* times; this may be taken as indicating that oxygen has a great tendency to collect round the carriers of the negative charge and either make them less efficient as ionisers or else make them move more slowly in the electric field. It is probable too that the oxygen increases the difficulty of getting the corpuscles from the point into the gas as Warburg has shown that the presence of oxygen produces a large increase in the cathode fall of potential in vacuum tubes.

244. Warburg|| has investigated the proportion of current received at different portions of the plane opposite the electrified

* C. T. R. Wilson, *Phil. Trans.* A, vol. cxcii. p. 403, 1899.

† Campbell, *Phil. Mag.* [6], vi. p. 618, 1903.

‡ Cook, *Phil. Mag.* [5], xlvii. p. 40, 1899. Leduc, *Éclair. Électr.* xxi. p. 144, 1899.

§ Warburg, *Ann. der Phys.* ii. p. 295, 1900.

|| Warburg, *Wied. Ann.* lxvii. p. 69, 1899.

point; he finds that the amount received per unit area at a point Q on the plane is proportional to $\cos^m \theta$, where θ is the angle QPO , P being the electrified point and O the normal from P on the plane, the electrified conductor is supposed to be at right angles to the plane; he finds that m for a negatively electrified point is equal to 4.65, for a positively electrified point 4.82, and that it is independent of the sharpness of the point.

The Electrical Wind.

245. The current of electrified ions which constitutes the discharge from the point sets the air in the neighbourhood in motion. For when the ions have settled down into the state in which their velocity is proportional to the electric force acting upon them the mechanical force acting upon them is transferred to the air through which they are moving, this gives rise to currents of air directed from the point, and these air currents are what is known as the electrical wind. This motion of the air forwards is accompanied by a reaction on the point, tending to drive it backwards. This reaction has been measured by Arrhenius*, who finds that when positive electricity is escaping from a point into air the reaction tending to drive the point backwards is, when the current is kept constant, proportional to the pressure of the gas, and for different gases (air, hydrogen, and carbonic acid) at the same pressure varies as the square root of the molecular weight of the gas. The reaction when an equal current of *negative* electricity is escaping from the point is much less, the proportion between the two depending on the pressure of the gas; thus in air at a pressure of 70 cm. the reaction on the positive point was 1.9 times that of the negative, at 40 cm. 2.6 times, at 20 cm. 3.2 times, at 10.3 cm. 7 times, and at 5.1 cm. 15 times the reaction of the negative point. The reaction on the discharging point is due to the repulsion between the electrified point and the ions carrying the discharge; we can easily calculate this force. Suppose that the needle from which the electricity is discharged points in the direction of the axis of z ; let ρ be the density of the ions at any part of the field, Z the electric force at the same point, then F , the force parallel to z acting on the ions, is equal to

$$\iiint Z \rho dx dy dz;$$

* Arrhenius, *Wied. Ann.* lxxiii. p. 305, 1897.

but if w is the velocity of the ion parallel to z , $w = kZ$, where k is the velocity of the ion under unit electric force; substituting this value for Z we get

$$F = \iiint \frac{w}{k} \rho dx dy dz;$$

but if i is the current

$$i = \iint w \rho dx dy,$$

hence if k is constant throughout the field

$$F = \frac{i}{k} \int dz \dots\dots\dots(1).$$

The reaction on the point is equal to F , hence for a constant current F varies inversely as k ; this conclusion agrees when the point is positively electrified with the results of Arrhenius's experiments. For let us first consider the effects of pressure, k varies inversely as the pressure; hence F should be directly proportional to the pressure, this is in agreement with Arrhenius's result; next consider the reaction of different gases; if we refer to the values given on page 80, we see that the velocities of the ions under unit electric force are roughly inversely proportional to the square roots of the densities of the gases, hence F should be approximately directly proportional to the square roots of these densities. Since the velocity of the negative ion is greater than that of the positive the reaction on the negative point should be less than that on the positive; the ratio of the reaction on the positive point to that on the negative is however much greater than the ratio of the velocity of the negative ion to that of the positive. We have seen however reasons for believing that a rapid condensation of the gas takes place around the newly-formed negative ions after they are produced at the point, so that the velocity of the negative ion will be greater at first than after it has been for some time in the gas; it is only however for these aged ions that we know the velocity; while in the case of the point discharge a large part of the reaction will be due to the more rapidly moving freshly-formed ions in the immediate neighbourhood of the point, so that the value of F will be less than that determined by equation (1) when we substitute for k the observed velocity of the negative ion.

Discharge from a point whose electrification is rapidly changing sign.

246. If a point is charged up to a high and rapidly alternating potential, such as can be produced by the electrical oscillations started when a Leyden jar is discharged, then in hydrogen, nitrogen, ammonia, and carbonic acid gas, a conductor placed near the point gets a negative, while in air and oxygen it gets a positive charge*. Himstedt† has shown that the distribution of electrification in these gases differs only in degree; he finds that in air and oxygen, although the electrification is positive near the point, yet it changes sign as we recede from it and ultimately becomes negative; while in hydrogen and the other gases mentioned above we get positive electrification if we go close up to the point; the difference between the gases is that in air the place where the electrification changes sign is some distance from the point, while in hydrogen it is close up to it. This outer zone of negative electrification is what we should expect from the greater velocity of the negative ions, for under an alternating electric field the amplitude of the path of the faster ions would be greater than that of the slower, and thus at a distance from the point greater than the amplitude of the slower ions there would be nothing but negative electricity. The determination of the distance at which the electrification changes sign would be a very complicated investigation, as it would involve in addition to the relative velocities of the positive and negative ions the difference in the values of the current proceeding from the point according as it is positively or negatively electrified, as well as the difference in the minimum potential at which the discharge begins.

247. The condition of a point from which electricity is discharging seems to suffer some modification as the discharge goes on, and this gives rise to variations in the current: Precht‡ found that a point from which positive electricity had been discharged sometimes got hollowed out into a kind of crater, as if some of the

* Harvey and Hird, *Phil. Mag.* [5], xxxvi. p. 45, 1893. Himstedt, *Wied. Ann.* lii. p. 473, 1894. J. J. Thomson, *Phil. Mag.* [5], xl. p. 511, 1895.

† Himstedt, *Wied. Ann.* lxxviii. p. 294, 1899.

‡ Precht, *Wied. Ann.* xlix. p. 50, 1893.

metal had been torn away; he found that a negatively electrified point did not suffer any change of shape.

Theory of the discharge from fine points.

248. We may suppose that the escape of electricity from a sharp point occurs in the following way. When the electric field at the point reaches a certain intensity a short spark passes from the point to the air a little distance away, along the path of this spark ions are produced, positive as well as negative; if the point is positively electrified the positive ions are driven out from this region into the surrounding gas and under the influence of the electric field find their way to the metal plate to which the point is discharging; if the point is negatively electrified it is the negative ions which are driven to the plate, and which carry the electricity which is discharging from the point.

Let us apply these considerations to explain some of the features of the discharge. We shall first consider the strength of the field required to produce the small spark from the point.

The relation between the potential difference required to produce a spark and the spark length is (see page 497) represented by a curve similar to α , Fig. 139, where the ordinates represent the

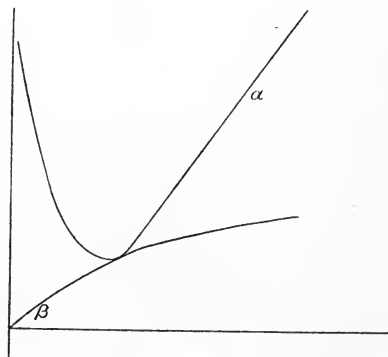

Fig. 139.

spark potential and the abscissæ the spark length. Let us suppose that the point is equivalent in its electrical effect to a small sphere of radius a ; thus if V is the potential of the sphere the

potential difference between the sphere and a point at a distance x from its surface is $V \frac{x}{a+x}$; let the equation to the curve β (Fig. 139) be $y = V \frac{x}{a+x}$, then if the curve β intersects the curve α a spark will pass from the point, if the curves do not intersect no spark will pass, the smallest value of V which will produce a spark is when the corresponding curve β just touches the curve α . Now when a is very small dy/dx for β is very small compared with y/x , but for the curve α it is only in the neighbourhood of the minimum spark potential that this is the case, hence we conclude that when β touches α it does so close to A , the point corresponding to the critical spark lengths x_0 and to V_0 the minimum potential difference required to produce a spark, hence we have approximately

$$V \frac{x_0}{a+x_0} = V_0,$$

$$V = \left(1 + \frac{a}{x_0}\right) V_0.$$

V_0 here is the value of the minimum potential required to produce a spark; we see that V diminishes as a diminishes, *i.e.* the sharper the point the smaller the discharge potential; it also diminishes as the critical spark length increases, and as the critical spark length is greater at low pressures than at high the minimum potential will diminish as the pressure diminishes. In consequence of the conductivity of the gas round the point, the radius of the sphere taken as equivalent in its electrical action to the point may be considerably larger than the actual radius of the point, and the proportions between these quantities may depend upon the pressure of the gas.

*Difference between the minimum potential for positive
and negative points.*

249. The minimum potential required for the discharge of positive electricity from a point is greater than that for negative: this is, I think, consistent with the preceding view, for the minimum potential difference V_0 is determined by the condition that the electric field near the electrode should be strong enough to enable

the positive ions to produce an adequate stream of corpuscles. Now when the point is the cathode the positive ions have two opportunities of producing corpuscles, (1) by impact with the electrode, (2) by impact with the molecules of the gas; while when the point is the anode only the second of these is available; this would have the effect of making V_0 for the positive point greater than for the negative and thus making the minimum potential required for point discharge greater.

The condition we have just investigated only ensures that electricity should be able to escape from the point, it does nothing to ensure that the discharge should be luminous. The experiments which have been made on the discharge relate wholly to cases in which a glow appears at the point; we have already seen (p. 478) that when luminosity sets in there is a great increase in the ionisation and in the current, hence the current in the dark stages of the discharge may well have escaped detection. We shall now proceed to investigate the condition that luminosity may appear at the point. We gave reasons for thinking that the appearance of luminosity was due to the molecules of the gas acquiring a finite amount of energy; now the energy acquired by the molecule will be proportional to the rate at which energy is communicated to the gas: consider the gas enclosed between the point and the space separated from it by a distance equal to the critical spark length, the difference of potential between the point and the outer boundary is V_0 the minimum spark potential: if i is the current through the gas the work done per second in this region is $V_0 i$; if d is the critical spark length, a the radius of the point, the volume of this region is, if d is small compared with a , equal to $4\pi a^2 d$ and if n is the number of molecules in unit volume of gas the number of molecules in the region is $4\pi a^2 d n$, hence the work done in this region per molecule per second is $V_0 i / 4\pi a^2 d n$; we have seen reasons for supposing that the condition for luminosity is that this should reach a definite value; since d is proportional to λ the mean free path, and λ is proportional to $1/n$, $d n$ will be independent of the pressure, hence the condition for luminosity is that $V_0 i = c a^2$, where c is constant as long as the gas remains the same.

We have seen however that

$$i^{\frac{1}{2}} = \left(\frac{k_0}{p}\right)^{\frac{1}{2}} C(V - V'),$$

where C is a constant, k_0 the velocity of the ion under unit electric force at unit pressure, V the potential of the point, V' a constant, hence the condition $V_0 i = ca^2$ is equivalent to

$$V = V' + \frac{p^{\frac{3}{2}} c^{\frac{3}{2}} a}{k_0^{\frac{1}{2}} C V_0^{\frac{1}{2}}} \dots\dots\dots(1).$$

Hence if V_A is the potential of the point when luminosity appears at a pressure p_A , V_B the potential for the pressure p_B ,

$$V_A = V' + \sqrt{\frac{p_A}{p_B}} (V_B - V').$$

This is the relation between the potential and the pressure which Ewers has verified over a wide range of pressures.

Since the velocity of the negative ion is greater than that of the positive, the second term in equation (1) will, other things being the same, be less when the point is negatively charged than when it is positively charged; this is one reason why the potential required to produce luminous discharge from a positive point is greater than that required for a negative one.

250. The appearance of the discharge between a point and a plate undergoes very interesting changes as the potential difference between the point and the plate is gradually increased. Take for example the case of a negatively electrified point in front of a plane, when first the discharge sets in the ionisation and luminosity are confined to the region close to the point, the electric field is very weak except in this neighbourhood, and in this case the current is carried entirely by negative ions. These negative ions produce a distribution of free negative electricity between the point and the plate; this electrification alters the distribution of the electric field, tending to make the electric force increase in the neighbourhood of the plate; the field near the plate will get more and more intense as the current and the density of the free electricity increase, until it gets so large that it produces ionisation and luminosity at the plate, and a glow appears at the anode. The current will no longer be carried entirely by negative ions for positive ions produced at the anode will travel back to the cathode: the relation between the current and the potential difference will be changed by the participation of ions of both signs in the discharge. The positive electricity streaming back from the anode

will affect the distribution of the electric force, tending to make it increase towards the cathode; the force near the cathode increases until it gets large enough for corpuscles to produce ions by collision in the neighbourhood of the cathode; as these ions produce other ions the current and the luminosity around the cathode increase rapidly, and we get a new stage in the discharge. This stage is exceedingly well-marked at low pressures and occurs with great abruptness: the current rapidly increases and at low pressures may become so large that the cathode gets red hot by the impact on it of the positive ions; the supply of corpuscles at the cathode is increased since the incandescent metal gives out corpuscles on its own account, thus since an increase in the current will increase the corpuscles given out in this way, and the increase

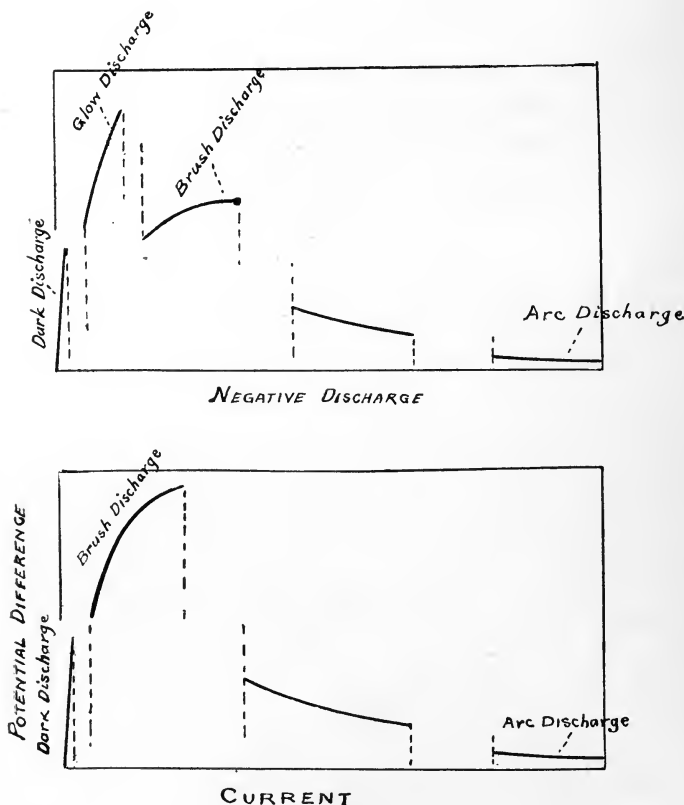

Fig. 140.

in these corpuscles will lead to an increase in the current, the conditions will become unstable, the current will rapidly increase and an arc discharge will pass, the potential difference falling to a very small value, the supply of corpuscles now being produced from the incandescent cathode and not by ionisation by collision in the electric field. The general character of the change in the relation between the potential difference and the current as the character of the discharge changes is indicated in Fig. 140, taken from a paper by Töpler*.

251. Analogous changes in the discharge take place if we replace the point by a thin incandescent platinum wire coated with lime, and in this case the distribution of the electric force is much more easily studied than with the point as the changes take place with much smaller potential differences. I have been able in this way to study the gradual transition of the discharge from the first appearance of the anode glow to the development of the luminosity round the cathode. It is possible to get in this way an intermediate stage in which the discharge presents the appearance shown in Fig. 141. Here there is a crescent-shaped luminous patch

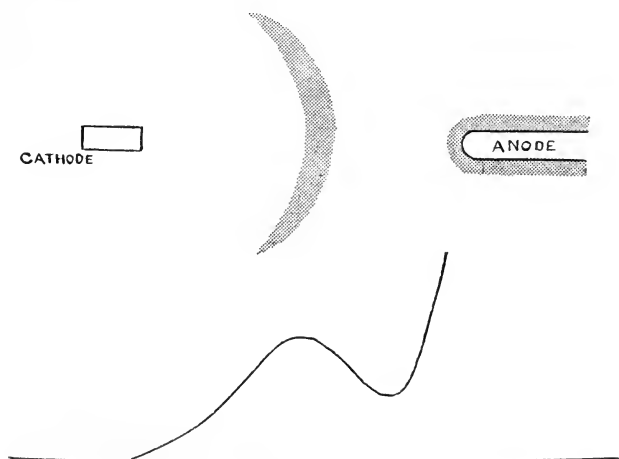

Fig. 141.

between the anode and the cathode; the measurement of the electric force between the electrodes showed that the free electricity has produced the distribution represented by the lower curve in

* Töpler, *Ann. der Phys.* vii. p. 477, 1902.

Fig. 141, the electric force having a maximum value at the luminous crescent; thus in this region the electric force due to the free electricity has risen to the value at which luminosity and ionisation set in, producing the isolated luminous meniscus; as the current is increased this meniscus approaches the cathode; when it arrives at a short distance from it, the change to the form in which there is a great development of negative glow sets in, and there is a great change in the appearance of the discharge and in the distribution of the electric field.

The ionisation in the patch in Fig. 141 makes this portion of the gas act as an anode and the free electricity due to the ions coming from it may cause the electric field between it and the cathode to rise again to a value when ionisation sets in, producing a second isolated luminous meniscus. In this way we may get a succession of striations causing the discharge to resemble that shown in Fig. 138.

Earhart's experiments (p. 455) seem to indicate that when the electric force reaches a certain very high value the ions can come from the metal; it would be interesting to further test this view by seeing if a moderate potential was able to produce a discharge from an exceedingly fine point in a good vacuum.

Pressure in the Spark.

252. The ions in the electric field acquire kinetic energy and as the pressure in a gas is proportional to the kinetic energy per unit volume the pressure along the path of the spark will be increased. This increase in pressure may be very large; for it is easy to show that the kinetic energy given to the ions, when a quantity of electricity equal to Q passes through the spark, is equal to VQ , where V is the spark potential. To take an example, let us suppose that we have a spark one cm. long through air at atmospheric pressure, and that we discharge by this spark the charge in a condenser of 1000 cm. capacity charged to the potential difference required to produce the spark; this potential difference is about 30000 volts, *i.e.* 100 in electrostatic units, hence in this case $V = 10^2$ and $Q = 10^3 \times 10^3$, thus the energy given to the gas is 10^7 ergs. Now if this energy were distributed throughout 1 c.c. of gas it would increase the pressure by 6.6 atmospheres, it is

however confined to the very much smaller volume traversed by the spark, the pressure in this region being proportionately greater; to take $\frac{1}{100}$ of a c.c. as the volume of gas traversed by the spark would probably be a very large over-estimate, and yet even if the volume were no less than this the initial pressure along the path of the spark would be 660 atmospheres. This high pressure would spread as a pulse from the region of the spark gap, the pressure in the pulse, when this had got so far from the spark gap that it might be regarded as spherical, varying inversely as the square of the distance from the spark gap.

A well-known instance of the effects produced by this pressure is what is called the 'electrical bomb,' where a loosely-fitting plug in a closed vessel is blown out when a spark passes through the vessel. The effect can easily be observed if a pressure-gauge, in which the pressure is indicated by the motion of a small quantity of a light liquid, is attached to an ordinary discharge-tube, the pressure in the gas being most conveniently from 2 to 10 mm. of mercury. At the passage of each spark there is a quick movement of the liquid in the gauge as if it had been struck by a blow coming from the tube; immediately after the passage of the spark the liquid in the gauge springs back within a short distance of its position of equilibrium and then slowly creeps back the rest of the way. This latter effect is probably due to the slow escape of the heat produced by the passage of the spark; the gauge behaves just as it would if a wave of high pressure rushed through the gas when the spark passed. The increased pressure due to the discharge has been described by Meissner* and by De la Rue and Müller†.

The existence of a pulse spreading from the spark has been beautifully demonstrated by Töpler‡ who studied by the method of instantaneous illumination the region round the spark immediately after it had passed. As the density of the air in the pulse differs from that of the surrounding gas, the pulse is optically different from the rest of the field and so can be made visible. Fig. 142 *a*, taken from Töpler's paper, represents the appearance

* Meissner, *Abhand. der könig. Gesellschaft Göttingen*, xvi. p. 98, 1871.

† De la Rue and Müller, *Phil. Trans.* 1880, p. 86.

‡ Töpler, *Pogg. Ann.* cxxxi. pp. 33, 180, 1867; cxxxiv. p. 194, 1868.

of the field looking so as to see the whole length of the spark, Fig. 142 *b* the appearance when the spark is looked at end-on.

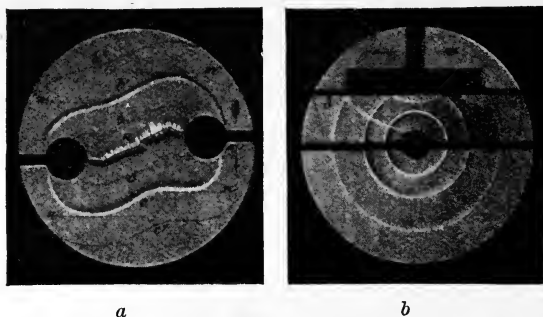

Fig. 142.

Töpler noticed that the initial disturbance close to the spark-gap showed periodic expansions and contractions, as if the regions of greatest disturbance were distributed at equal intervals along the length of the spark. There was an exceptionally large protuberance in the neighbourhood of the cathode.

In an experiment due to Hertz, which also illustrates well the explosive effects due to the spark, the explosion seemed to be more vigorous at the anode than at the cathode* ; in this experiment the anode was placed at the bottom of a glass tube with a narrow mouth, while the cathode was placed outside the tube and close to the open end. The tube and the electrodes were in a bell-jar filled with dry air at a pressure of 40—50 mm. of mercury. When the discharge from a Leyden jar charged by an induction coil passed through the tube, the glow accompanying the discharge was blown out of the tube and extended several centimetres from the open end ; the effect was not so marked when the electrodes were reversed.

Haschek and Mache†, by measuring the pressure at the surface of a vessel through which sparks from a high tension transformer were passing, have calculated the pressure in the spark ; with brass electrodes and sparks 3 mm. long they estimated the pressure of the spark in air at a pressure of 704 mm. of mercury as 51.7 atmo-

* Hertz, *Wied. Ann.* xix. p. 87, 1893.

† Haschek and Mache, *Wied. Ann.* lxxviii. p. 740, 1899.

spheres, in carbonic acid at the same pressure 52·2 atmospheres, and in coal gas as 72·7 atmospheres; they found that the pressure in the spark was, as might be expected from the diminution in the spark potential, less when the pressure of the gas through which the spark passed was low than when it was high: thus in one of their experiments the pressure in the spark was estimated by them to be 27·2 atmospheres when the pressure of the air was 585 mm. of mercury, when the air pressure was reduced to 96 mm. of mercury the spark pressure fell to one atmosphere. They found too that the spark pressure depended upon the nature of the electrodes; thus under similar conditions they found that the spark pressures in air with electrodes of carbon, iron and brass were respectively 124, 79, 64 atmospheres. When as in these experiments sparks follow each other in rapid succession, the spark is carried to a considerable extent by the metallic vapour from the electrode.

Haschek and Exner* and Mohler† have published estimates of the spark pressure derived from observations of the displacement of the lines in the spectrum of the spark due to the electrode. Humphreys‡ has shown that the effect of increased pressure in the vapour of a metal is to displace the lines towards the red end of the spectrum, and has measured the displacement for various pressures; hence if we assume that the displacement of the lines in the spark spectrum is due to the pressure of the spark, by measuring this displacement we can deduce the pressure in the spark.

The magnitude of the pressures in the spark explains the mechanical effects produced by sparks, such as the perforation of pieces of cardboard or thin plates of glass.

Heating Effects produced by Sparks.

253. A large part of the energy given to the ions during the discharge will appear as heat and will raise the temperature of the gas and the vessel in which it is contained. Measurements of the heat produced by sparks have been made by Riess§,

* Haschek and Exner, *Wien. Sitzungs.* cvi. p. 1127, 1897.

† Mohler, *Astrophysical Journal*, iv. p. 175, 1896.

‡ Humphreys, *Astrophysical Journal*, vi. p. 169, 1897.

§ Riess, *Reibungselektricität*.

Paalzow*, G. Wiedemann†, Naccari and Bellati‡, Poggendorff§, Dewar||, Rollmann¶, Naccari**, Villari††, Mugna‡‡: measurements in absolute measure have been made by Heydwiller§§ and Kauffmann|||. These experiments have mostly been made on the heat developed by the sparks produced by discharging Leyden jars; the most definite result obtained is that the heat produced in the spark gap is only a small fraction of the energy in the jar before it was discharged. The discharge of the jar is oscillatory, so that in this case we have a series of sparks following one another across the gap in quick succession; under these circumstances there is a great tendency for the spark to change into an arc, and in the arc the potential difference between the electrodes, and therefore the heat produced by a given current, is very much less than for the spark. The relation between the electromotive force and the current in the case of the discharge through gases is in general so different from that for metals that it is somewhat misleading to speak of the resistance of the spark gap: it may, however, give some idea of the small amount of energy dissipated in the spark gap to say that the heating effect for sparks six millimetres long has been found in some cases investigated by Miss Brooks¶¶ to be not greater than that which would have occurred if a wire about 2 ohms resistance occupied the position of the spark.

254. Schuster and Hemsalech*** have made some very interesting researches on the constitution of sparks following rapidly one after another, such as are produced by the oscillatory discharge of a Leyden jar. The sparks were photographed on a rapidly moving film mounted on the rim of a wheel making about 30 revo-

* Paalzow, *Pogg. Ann.* cxxvii. p. 126, 1866.

† G. Wiedemann, *Pogg. Ann.* clviii. p. 35, 1876.

‡ Naccari and Bellati, *Beib.* ii. p. 720, 1878.

§ Poggendorff, *Pogg. Ann.* xciv. p. 632, 1855.

|| Dewar, *Proc. Roy. Soc. Edin.* vii. p. 699, 1872.

¶ Rollmann, *Pogg. Ann.* cxxxiv. p. 605, 1868.

** Naccari, *Att. di Torino*, xvii. p. 1, 1882.

†† Villari, *Beib.* iii. p. 713; iv. p. 404; v. p. 460; vi. p. 699; vii. p. 782.

‡‡ Mugna, *Beib.* vi. p. 953.

§§ Heydwiller, *Wied. Ann.* xliiii. p. 310, 1891; lxi. p. 541, 1897.

||| Kauffmann, *Wied. Ann.* lx. p. 653, 1897.

¶¶ Miss Brooks, *Phil. Mag.* vi. 2, p. 92, 1901.

*** Schuster and Hemsalech, *Phil. Trans.* 1899, vol. cxciii. p. 189.

lutions per second; the motion of the film was at right angles to the length of the spark, so that the line traced on the film by a source of light moving with finite velocity along the spark length would be inclined to the direction of the spark, and its inclination would (if the velocity of the film were known) give the velocity of the source of light. By sending the light from the spark on its way to the film through a spectroscope the velocity corresponding to any line in the spectrum could be determined.

The conclusion arrived at by the authors from these experiments is that the first spark passes through air, but that if the sparks follow each other in rapid succession (as they do when produced by the oscillatory discharge of a Leyden jar) and are not too long, the succeeding ones pass through the vapour of metal, the electrodes being vaporised by the heat produced by the first spark. This view is confirmed by a very interesting experiment made by the authors: they found that if self-induction was put into the spark circuit by which the jars were discharged the air lines almost disappeared from the spectrum of the spark while the metal lines were very bright: the self-induction increases the time the oscillations last and so enables the vapour of the metal to get well diffused through the spark gap, the discharge passing for by far the greater part of the time through the vapour so that most of the energy is spent in heating this and not the air.

The authors found that the velocity of the metallic vapours in the spark was greater for the metals of low atomic weight than for those of high; thus the velocity of aluminium vapour was 1890 metres per second, that of zinc and cadmium only about 545.

The very interesting result was obtained that the velocities of the vapours of some metals and especially of bismuth indicated by some of the lines in the spectrum were not the same as those indicated by other lines, thus in bismuth some of the lines indicated a velocity of 1420 metres per second, others a velocity of only about 550, while one line ($\lambda = 3793$) gave a still smaller velocity. This result raises some very interesting questions, as for instance whether bismuth is a mixture of different elements, some of the lines in the spectrum being due to one constituent, others to the other constituents; another possibility is that the molecules even of an element are not all of the same kind, and that the different

lines in the spectrum are emitted by molecules of different kinds; we should also get a similar effect if the relative intensities of the lines varied greatly with the kinetic energy possessed by a molecule; if for example the intensity of a line α was very much greater than that of a line β , for a rapidly moving molecule, and very much less for a slowly moving one, then, if the molecules of the vapour were projected with different velocities, the line α would indicate a higher velocity than β . There are some reasons for thinking that many of the lines in spectra obtained by arcs and sparks originate from systems formed during the discharge and not from the normal atom, if this were the case we could easily understand why different lines should indicate different velocities.

Schenck* has also observed the appearance presented in a rapidly rotating mirror when the alternating current produced by discharging a number of Leyden jars passes across an air space, he found that the discharge presented three characteristic features, (1) a thin bright line followed in some cases at intervals of half the period of the discharge by fainter lines, (2) bright curved streamers starting from the negative terminal, the velocity of the particles in the streamers falling off rapidly as they receded from the pole, (3) a diffused glow lasting for a much longer period than either of the preceding. These three constituents give out quite different spectra.

Effect of a Magnetic Field on the Spark.

255. We shall see later on that a magnetic field produces a very great effect on the discharge through gases when the pressure is low. At atmospheric pressure, however, the effects on the spark itself are very slight, although the halo of luminous gas which surrounds the course of the sparks when a number of sparks follow each other in rapid succession is drawn out into a broad band by the magnetic field. This halo, it may be observed, is deflected by a current of air though the spark itself is not affected. Precht† has observed a distinct effect of a magnet on a spark at atmospheric pressure when the sparks pass between a sharp point

* Schenck, *Astrophysical Journal*, xiv. p. 116, 1901.

† Precht, *Wied. Ann.* lxvi. p. 676, 1896.

and a blunt wire; the spark is deflected by a transverse magnetic field in the same direction as a flexible wire conveying a current in the same direction as that passing through a spark would be deflected. He found, too, that the magnetic field affected the spark potential; thus when the distance between the electrodes was 8 mm. and the transverse magnetic force 7017, he found that when the pointed electrode was the anode, the rounded one the cathode, the magnetic field reduced the spark potential from 8670 volts to 7520 volts, while when the point was cathode, the rounded electrode anode the same magnetic field *increased* the potential from 6250 to 6450 volts.

Appearance of Long Sparks.

256. When sparks are of considerable length they exhibit a branched appearance, as shown in Fig. 143, the branches pointing

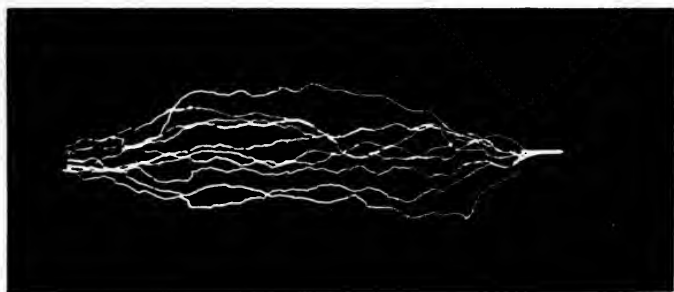

Fig. 143.

to the negative electrode; the electricity flowing along those branches which terminate abruptly must ultimately find its way to the electrodes by a dark discharge. The appearance of the spark is different at the positive and negative terminals, there is a single straight stem at the positive, while at the negative the discharge is divided into several threads. The spark along its course exhibits abrupt changes in direction as if it made its way by a series of jumps rather than as an uninterrupted stream.

TABLE I. *Air.* (Carr.)

Spark Length = 1 mm.		Spark Length = 2 mm.		Spark Length = 3 mm.		Spark Length = 5 mm.		Spark Length = 10 mm.	
Pressure in mm. of Mercury	Spark Potential in Volts	Pressure in mm. of Mercury	Spark Potential in Volts	Pressure in mm. of Mercury	Spark Potential in Volts	Pressure in mm. of Mercury	Spark Potential in Volts	Pressure in mm. of Mercury	Spark Potential in Volts
150	1510	20	620	51	1480	7.34	600	7.09	831
120	1265	13.2	527	41.5	1275	4.61	504	4.12	645
90	1025	8.73	455	31.5	1015	2.95	418	2.39	504
61	784	5.52	400	21.4	790	1.85	368	1.39	420
40.8	634	4.11	373	14.1	630	1.57	356	.982	372
21.6	489	3.16	355	9.31	526	1.34	349	.805	355
19.4	477	2.71	351	5.99	452	1.14	352	.679	348
12.4	417	2.32	357	3.84	405	.982	359	.562	351
7.77	367	2.02	371	2.51	371	.839	370	.466	359
6.66	357	1.75	389	1.88	361	.714	388	.384	377
5.80	352	1.52	419	1.89	356	.607	427	.312	425
4.98	349	1.30	460	1.64	358	.517	484	.259	504
4.27	355	1.13	534	1.42	364	.440	575	.219	605
3.67	368	.982	654	1.22	375	.375	705	.180	757
3.15	392	.857	826	1.06	397	.321	935	.152	1020
2.70	429	.750	1042	.928	441	.276	1223	.125	1315
2.35	481	.643	1312	.804	494	.232	1585	.105	1730
2.02	558	.549	1695	.710	576	.216	1774		
1.74	681	.536	1829	.616	691				
1.51	855			.536	863				
1.29	1090			.465	1092				
1.12	1463			.411	1395				
1.05	1826			.357	1786				

TABLE II. *Air*. (Carr.)

Spark Length = 1 mm.		Spark Length = 2 mm.		Spark Length = 3 mm.		Spark Length = 5 mm.		Spark Length = 10 mm.	
Product of Pressure and Spark Length	Spark Potential in Volts	Product of Pressure and Spark Length	Spark Potential in Volts	Product of Pressure and Spark Length	Spark Potential in Volts	Product of Pressure and Spark Length	Spark Potential in Volts	Product of Pressure and Spark Length	Spark Potential in Volts
150	1510	40	620	153	1480	36.7	600	70.9	831
120	1265	26.4	527	124.5	1275	23.0	504	41.2	645
90	1025	17.4	455	94.5	1015	14.7	418	23.9	504
61	784	11.0	400	64.2	790	9.25	368	13.9	420
40.8	634	8.22	373	42.3	630	7.85	356	9.82	372
21.6	489	6.32	355	27.9	536	6.70	349	8.05	355
19.4	477	5.42	351	17.9	452	5.70	352	6.79	348
12.4	417	4.64	357	11.5	405	4.91	359	5.62	351
7.77	367	4.04	371	7.53	371	4.19	370	4.66	359
6.66	357	3.50	389	6.54	361	3.57	388	3.84	377
5.80	352	3.04	419	5.67	356	3.03	427	3.12	425
4.98	349	2.60	460	4.92	358	2.58	484	2.59	504
4.27	355	2.26	534	4.26	358	2.20	575	2.19	605
3.67	368	1.96	654	3.66	375	1.87	705	1.80	757
3.15	392	1.71	826	3.18	397	1.60	935	1.52	1020
2.70	429	1.50	1042	2.78	441	1.38	1223	1.25	1315
2.35	481	1.28	1312	2.41	494	1.16	1585	1.05	1730
2.02	558	1.09	1695	2.13	576	1.08	1774		
1.74	681	1.07	1829	1.84	691				
1.51	855			1.60	863				
1.29	1090			1.39	1092				
1.12	1463			1.23	1395				
1.03	1826			1.07	1786				

TABLE III. *Carbon Dioxide.* (Carr.)

Spark Length = 1 mm.		Spark Length = 2 mm.		Spark Length = 3 mm.		Spark Length = 5 mm.		Spark Length = 10 mm.	
Product of Pressure and Spark Length	Spark Potential in Volts	Product of Pressure and Spark Length	Spark Potential in Volts	Product of Pressure and Spark Length	Spark Potential in Volts	Product of Pressure and Spark Length	Spark Potential in Volts	Product of Pressure and Spark Length	Spark Potential in Volts
19.8	516	42.6	802	26.2	674	45.5	790	72.7	993
12.6	480	27.6	645	16.7	563	28.8	674	42.6	790
9.41	443	17.5	519	10.6	477	18.2	579	24.3	656
6.83	425	10.8	464	6.75	427	11.6	498	14.4	553
5.86	421	8.04	439	5.73	420	7.25	438	8.60	473
5.02	419	6.92	426	4.89	419	6.25	423	6.12	428
4.31	420	5.90	421	4.23	425	5.35	421	5.10	423
3.73	427	5.04	419	3.60	432	4.59	428	4.09	440
3.18	443	4.30	420	3.06	449	3.93	441	3.40	470
2.73	475	3.68	427	2.62	487	3.39	464	2.80	506
2.34	503	3.16	443	2.27	542	2.86	495	2.39	563
2.00	559	2.68	473	1.95	599	2.46	533	1.96	639
1.72	636	2.32	525	1.67	699	2.09	599	1.62	761
1.47	763	1.96	605	1.44	815	1.80	704	1.34	973
1.26	916	1.69	702	1.26	971	1.55	820	1.11	1219
1.08	1127	1.45	847	1.08	1162	1.33	969	.946	1550
.946	1432	1.25	1026	.942	1445	1.16	1159	.892	1730
.817	1801	1.07	1258	.822	1756	.98	1373	.820	
		.910	1574	.842		.845	1663		
		.842	1762			.820	1770		

TABLE IV. *Hydrogen.* (Carr.)

Spark Length = 1 mm.		Spark Length = 2 mm.		Spark Length = 3 mm.		Spark Length = 5 mm.		Spark Length = 10 mm.	
Product of Pressure and Spark Length	Spark Potential in Volts	Product of Pressure and Spark Length	Spark Potential in Volts	Product of Pressure and Spark Length	Spark Potential in Volts	Product of Pressure and Spark Length	Spark Potential in Volts	Product of Pressure and Spark Length	Spark Potential in Volts
21.7	328	46	435	40.8	415	68	469	75.3	526
16.2	300	29.6	360	25.6	356	46.7	415	43.7	427
11.9	281	22.0	323	16.2	301	30.1	350	25.5	335
10.3	278	16.1	299	13.9	286	19.0	300	17.7	299
8.94	287	13.9	285	12.0	278	16.4	287	14.6	283
7.74	306	11.8	279	10.3	282	14.0	281	12.2	287
6.52	335	10.0	284	8.79	292	12.0	282	10.1	295
5.57	374	8.60	293	7.56	310	10.2	285	8.46	313
4.73	487	7.44	305	6.45	356	8.80	293	7.00	343
4.11	649	6.46	333	5.55	440	7.55	305	5.75	426
3.54	905	5.54	399	4.77	564	6.30	345	4.70	595
3.04	1275	4.72	523	4.05	780	5.45	410	3.90	850
2.60	1781	4.06	727	3.48	1054	4.64	539	3.30	1142
		3.46	1010	3.00	1382	4.04	706	2.76	1477
		2.96	1380	2.58	1789	3.50	975	2.64	1710
		2.66	1746			3.00	1373		
						2.58	1775		

CHAPTER XVI.

DISCHARGE THROUGH GASES AT LOW PRESSURES.

257. WHEN the electric discharge passes through a gas at a low pressure differences in the appearance of the discharge at various points in its path become very clearly marked. The discharge (Fig. 144) presents the following features: starting from the cathode *l* there is a thin layer of luminosity spread over its



Fig. 144.

surface, next to this there is a comparatively dark space, called the Crookes dark space, the width of which depends on the pressure of the gas, increasing as the pressure diminishes; it also

as Schuster* has shown depends, under some conditions, on the intensity of the current; the boundary of the dark space is approximately the surface traced out by normals of constant length drawn to the surface of the cathode; beyond the dark space there is a luminous region called the 'negative glow'; beyond this again is another comparatively dark region called by some writers the 'second negative dark space' and by others the 'Faraday dark space,' its length is very variable even when the pressure is constant; beyond this again there is a luminous column reaching right up to the anode and called the 'positive column'; when the current and pressure are within certain limits this column exhibits remarkable alternations of dark and bright spaces, these are called striations and are shown in Fig. 145.

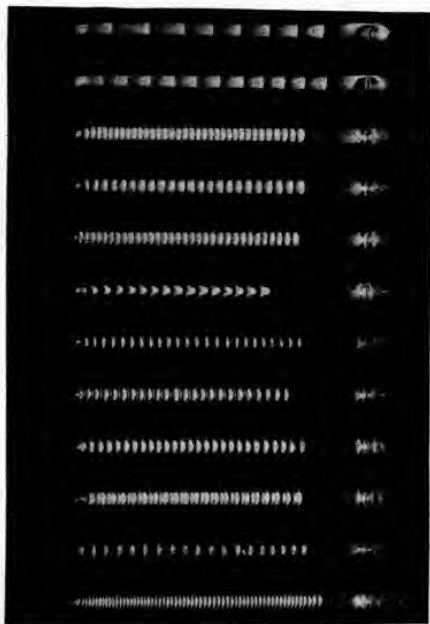

Fig. 145.

The figure is taken from a paper by De la Rue and Müller, *Phil. Trans.* 1878, pt. 1, p. 155. In long tubes the positive column

* Schuster, *Proc. Roy. Soc.* xvii, p. 557, 1890

constitutes by far the greater part of the discharge, for the Crookes space, the negative glow, and the Faraday dark space do not depend markedly upon the length of the tube, so that when the length of the discharge is increased, the increase is practically only in the length of the positive column; thus for example in a tube used by the writer about 15 metres long the positive column occupied the whole of the tube with the exception of two or three centimetres close to the cathode.

Distribution of the Electric Force along the discharge.

258. The electric force varies greatly along the discharge; it has been measured by Hittorf*, Graham†, A. Herz‡, Skinner§, and H. A. Wilson||. The method employed by these observers was to measure the potential acquired by a metal wire placed in various positions along the line of discharge, if the potential of the wire is the same as that of the gas with which it is in contact we get from these observations the means of determining the distribution of electric force along the tube. As an example of how this method is carried out in practice we may take the apparatus used by H. A. Wilson and shown in Fig. 146. The discharge

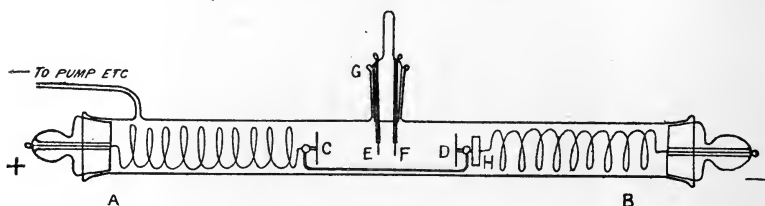

Fig. 146.

passed between two aluminium discs *C* and *D* supported by thin glass rods which kept them a constant distance apart. Flexible wire spirals connected these electrodes with wires sealed through the ends of the tube. A piece of iron *H* was fixed to the frame carrying the electrodes and enabled it to be moved along the

* Hittorf, *Wied. Ann.* xx, p. 705, 1883.

† Graham, *Wied. Ann.* lxiv, p. 49, 1898.

‡ A. Herz, *Wied. Ann.* liv, p. 246, 1895.

§ Skinner, *Wied. Ann.* lxxviii, p. 752, 1899.

|| H. A. Wilson, *Phil. Mag.* v, p. 505, 1900.

tube by means of a magnet. Two electrodes E, F about 1 mm. apart were fused through the side tube G ; these electrodes were connected with a quadrant electrometer whose deflection gave the difference of potential between E and F , and hence the electric force at this part of the tube. By moving the framework, EF could be brought into any part of the discharge between C and D , and thus the distribution of electric force between the electrodes mapped out. Another method which has been used is to keep the electrodes C and D fixed and move E, F by attaching them to a support floating on the top of a column of mercury the height of which could be altered.

For methods such as those just described to be successful the secondary electrodes must take up the potential of the gas with which they are in contact; to enable them to do this quickly there must be a plentiful supply of both positive and negative ions in the gas to give up their charges to the wire and thus raise or lower its potential to equality with the surrounding gas; the results obtained seem to justify the assumption that at moderate pressures the secondary electrodes do in most parts of the discharge acquire the potential of the gas, but the method is a dangerous one when the pressure is very low, or when the wire is placed in the Crookes space where the conductivity is very low.

Thus, to take an extreme case, suppose that a secondary electrode is placed in an enclosure in which there are torrents of negative ions but no positive ones, then the wire will go on receiving negative electricity until it gets so highly charged that it is able to repel the negative ions sufficiently to prevent any more striking it; when this stage is arrived at its potential may be lower than that at any point in the enclosure previous to its introduction.

259. I have suggested for discharge at low pressures the use of a method in which the deflection of the cathode rays is used to measure the strength of the electric field. The apparatus used to carry out this method is shown in Fig. 147. A and B are the electrodes kept at a constant distance apart and attached to springs, by means of which they can be moved along the tube. E and F are side tubes placed in line with each other,

in *E* cathode rays are produced by a Wimshurst machine, a pencil of these rays passes through a small hole in the disc *G*, traverses the electric discharge passing between *A* and *B*, then

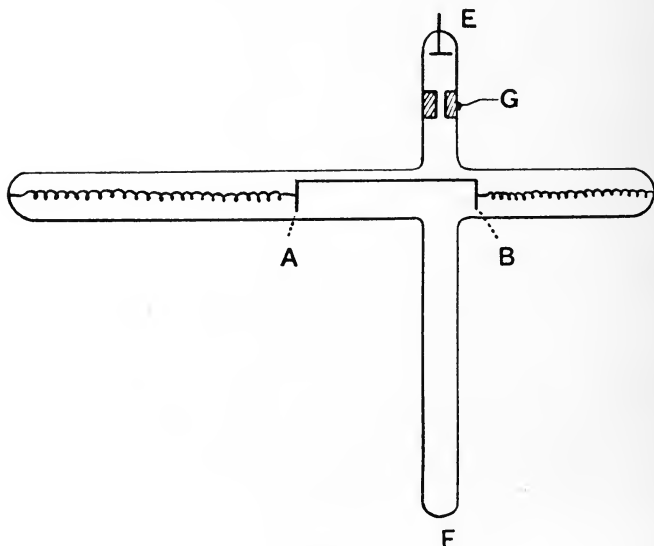

Fig. 147.

travels down the tube *F* producing a bright patch on a phosphorescent screen placed at the end of the tube. As the cathode rays are deflected by the electric force along the line of discharge the patch on the screen will be deflected from the position it occupies when the discharge is not passing; by measuring this deflection we can determine the electric force at the part of the discharge traversed by the rays; by moving the electrodes *A* and *B* along the tube we can map out the electric field at all parts of the discharge. Mr Strachan at the Cavendish Laboratory has in this way obtained the distribution of electric force in gases at low pressure.

260. The distribution of electric force in a discharge tube under various circumstances as to pressure and current is represented in the following figures in which the ordinates represent the value of the electric force at a point in the tube whose position is fixed by the abscissa. From these curves we infer that the

electric force is very large indeed in the Crookes dark space, diminishes rapidly towards the negative glow, and in the negative glow itself it is very small; it reaches a minimum either in the glow itself or in the portion of the Faraday dark space just outside the negative glow, after which it increases, towards the positive column; in the case of a uniformly luminous positive column (Fig. 148) the electric force is constant along it until we get quite

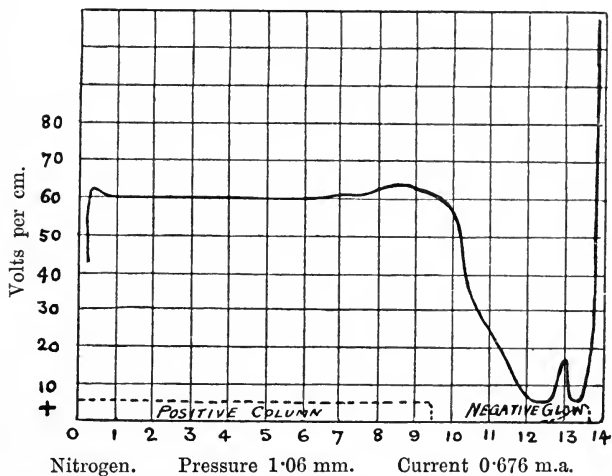

Fig. 148.

close to the positive electrode; a sudden jump in the potential, called the anode fall of potential, occurs quite close to the anode;

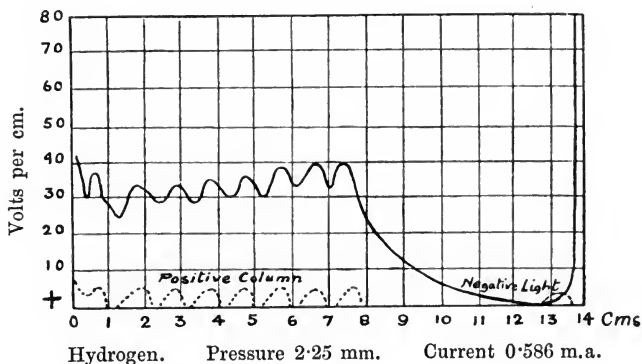

Fig. 149.

in many of Wilson's experiments this drop was preceded by the electric force falling to an exceedingly low value; in some cases indeed it was apparently reversed; it is not certain however that this apparent reversal may not have been due to disturbances produced by the introduction of the wires, &c., used to measure the potential. When the positive column was striated then, as we see from Fig. 149, the alternations of luminosity in the positive column are accompanied by alternations in the value of the electric force, maxima of the electric force occurring at the

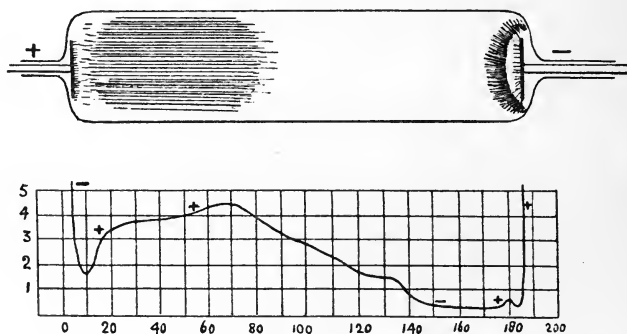

Fig. 150.

bright parts of the striæ, minima at the dark parts. Graham showed that when the gas was impure there were considerable variations in the electric force even in the luminous positive column; this is shown in Fig. 150 and Fig. 151, which repre-

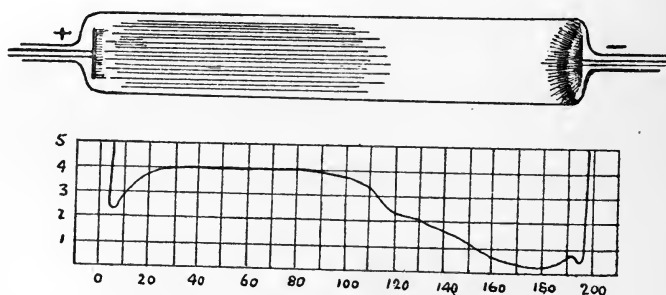

Fig. 151.

sent the distribution of electric force in an impure gas and in one which had been carefully purified. When there is no positive

column there is no region of constant intensity between the anode and the negative glow.

If X is the electric force, supposed parallel to x , and ρ the density of the electrification, then from the equation

$$\frac{dX}{dx} = 4\pi\rho$$

we see that the slope of the curves for X enables us to find the excess of the positive over the negative ions at each point of the discharge; an inspection of the curves shows that there is a very large excess of positive over negative in the Crookes dark space; in the negative glow the positive and negative ions are about equal in number; in the Faraday dark space there is an excess of negative ions; in the uniform positive column the two kinds of ions are about equal in number, while in a striated positive column there is a negative charge on the cathode side of the bright part of a striation and a positive charge on the anode side.

261. *Distribution of electric force near the cathode.* The electric field in the neighbourhood of the cathode has been the subject of many researches. Hittorf* showed that the potential difference between the cathode and a point in the negative glow was independent of the current, provided this was not great enough to cause the negative glow to enclose the whole of the cathode. When that stage was reached the potential between the cathode and the glow increased with the current. Thus if the cathode is a wire, then when the current is small the negative glow only surrounds the tip of the wire; as the current is increased the negative glow encloses more and more of the wire, but it is not until the glow reaches the end of the cathode that the difference of potential between the cathode and the glow begins to be affected by the current. This difference of potential is called the cathode fall of potential. Warburg† showed that it was independent of the pressure of the gas, and that the potential fall was practically the same whether platinum, zinc, copper, silver or iron electrodes were used; it was, however, considerably less when the electrodes were

* Hittorf, *Wied. Ann.* xx. p. 705, 1883.

† Warburg, *Wied. Ann.* xxxi. p. 545, 1887; xl. p. 1, 1890.

made of aluminium or magnesium. Mey* has recently shown that the cathode fall of potential depends more than had been supposed on the nature of the cathode, and that it falls to comparatively low values for the strongly electro-positive alkali metals (see also Lyman, *Proc. Camb. Phil. Soc.* XII. p. 45, 1902). With zinc, copper and iron electrodes the cathode fall of potential is often abnormally small when the electrodes are new; it rises however to its normal value after the electrodes have been used for some time. Warburg ascribes this effect to the presence of a thin layer of oxide on the new electrode, which gets removed in course of time by the disintegration which occurs when the metal is used as a cathode. Hittorf† discovered that the cathode fall became exceedingly small when the cathode was raised to a red heat. Goldstein‡ and Warburg (*loc. cit.*) found that the diminution in the cathode fall became much less when the heating was continued for a long time. It is worthy of remark in this connection that the emission of negative electricity from an incandescent wire often falls off very considerably after long-continued heating. Warburg found that a trace of impurity in the gas produced surprisingly large effects on the cathode fall of potential. Thus he found that the cathode fall in nitrogen which contained traces of moisture and oxygen was, with a platinum cathode, 260 volts, while the same nitrogen, after being very carefully dried, gave a cathode fall of 343 volts; thus a mere trace of moisture had diminished the cathode fall by 25 per cent. As long as the total quantity of water vapour is small, the lowering of the cathode fall does not seem to depend much upon the amount of aqueous vapour present; when however there is much water vapour present the fall is greater than in pure nitrogen; thus in a mixture of aqueous vapour and nitrogen in which the pressure due to the aqueous vapour was 2.3 mm., that due to the nitrogen 3.9 mm., the cathode fall was 396 as against 343 in nitrogen with a trace of oxygen; the increase in the cathode fall was, however, not nearly so great as that in the potential differences along the positive column. In hydrogen Warburg found that a trace of aqueous vapour *increased* the cathode fall of potential.

* Mey, *Verhand. Deutschen Physikalischen Gesellschaft*, v. p. 72, 1903.

† Hittorf, *Wied. Ann.* xxi. p. 133, 1884.

‡ Goldstein, *Wied. Ann.* xxiv. p. 91, 1885.

Warburg* also investigated the effect of removing from the gas all traces of oxygen. This was done by depositing on the inside of the tube a thin layer of sodium, the layer was formed by placing the tube in sodium amalgam, heating the glass and sending a current of electricity from the amalgam through the hot glass to an electrode inside the tube: the sodium thus deposited combined with any oxygen there might be in the tube. The removal of the oxygen produced a very great effect on the potential fall; thus in nitrogen with platinum electrodes the cathode fall was reduced by the removal of a trace of oxygen from 343 to 232 volts, while with magnesium electrodes the cathode fall when there was no oxygen was 207 volts. In hydrogen free from oxygen the cathode fall was 300 with platinum electrodes and 168 with magnesium electrodes; thus with platinum electrodes the cathode fall is greater in hydrogen than in nitrogen, while with magnesium electrodes it is less. The results given in the tables on p. 486 show that the pressure of oxygen diminishes the ionising power of the positive ions.

The following table contains the results of the measurements of the cathode fall of potential in various gases by Warburg (*loc. cit.*), Capstick† and Strutt‡; it also contains the measurements by

Gas	Cathode fall in volts Platinum electrodes			Cathode fall with aluminium electrodes. WARBURG	Minimum po- tential differ- ence required to produce a spark. STRUTT
	WARBURG	CAPSTICK	STRUTT		
Air	340—350	341
H ₂	about 300	298	...	168	302—308
O ₂	369
N ₂	230 if free from O	232	...	207	251
Hg vapour	340
Helium	226	...	261—326
H ₂ O	469
NH ₃	582

Strutt of the least potential difference able to produce a spark through the various gases. We see from the results that there is

* Warburg, *Wied. Ann.* xl. p. 1, 1890.

† Capstick, *Proc. Roy. Soc.* lxiii. p. 356, 1898.

‡ Strutt, *Phil. Trans.* cxiii. p. 377, 1900.

very considerable evidence in favour of the view that the minimum potential difference required to produce a spark through a gas is equal to the cathode fall of potential in that gas.

The influence of the material of the electrode is shown by the results quoted in the following table which is due to Mey (*l.c.*).

CATHODE FALL.

Gas	Electrode										
	Pt	Hg	Ag	Cu	Fe	Zn	Al	Mg	Na	Na-K	K
O ₂ ...	369
H ₂ ...	300	...	295	280	230	213	190	168	185	169	172
N ₂ ...	232	226	207	178	125	170
He ...	226	80	78.5	69
Arg...	167	100

Capstick found that if in dry gases a trace of oxygen was present the cathode fall was approximately the same as in pure oxygen. This is borne out by the results of the experiments of Warburg already quoted on the effect produced by a trace of oxygen in the presence of nitrogen. When water vapour is present it would appear from Warburg's experiments that this effect of the oxygen is to a large extent neutralised. We have already (p. 506) alluded to Warburg's experiments on the great diminution in the rate of escape of negative electricity from a point in nitrogen produced by the presence of a trace of oxygen; it seems probable that this effect is connected with that of a trace of oxygen on the cathode fall. The latter effect can hardly be due to any oxidation of the electrode, for Warburg has shown that the potential fall at slightly oxidised surfaces is *less* than that at bright ones.

262. For the compound gases H₂O and NH₃ the cathode fall seems to obey the additive law, thus the cathode fall in H₂O = cathode fall in H₂ + $\frac{1}{2}$ cathode fall in O₂, while the cathode fall in NH₃ = $\frac{1}{2}$ cathode fall in N₂ + $\frac{3}{2}$ cathode fall in H₂; the connection between the cathode fall in a gas and its chemical composition suggested by the two results just quoted is not confirmed by the observations of Matthies* on the cathode fall

* Matthies, *Ann. der Phys.* xvii. p. 675, 1905.

in the compound gases HgCl_2 , HgBr_2 , HgI_2 . For these gases the cathode fall of potential in air with a platinum cathode are respectively 365, 395, and 432 volts, while the cathode fall for mercury vapour is 340 and for iodine vapour 377. The experimental difficulties are, however, very great when compound gases are used, as with these gases it is exceedingly difficult to get a continuous discharge. If a circuit containing a telephone is placed in series with the discharge tube, Capstick found that it is almost impossible to get the telephone silent when a compound gas is in the tube, while there is no difficulty whatever in doing so with an elementary gas. The singing of the telephone indicates that the discharge is intermittent, and when this is the case the cathode fall cannot be measured. Carr came to the conclusion that the minimum spark potential followed the additive law.

263. *Current density at the cathode.* H. A. Wilson* has measured the current density at a cylindrical wire cathode when the negative glow does not envelop the whole of the negative electrode. Under these circumstances the glow assumes the appearance shown in Fig. 152, its shape resembling a test tube with a well marked lip at the end furthest from the anode; as the current increases the glow reaches further along the electrode, the length

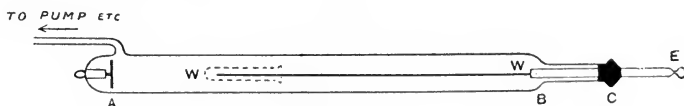

Fig. 152.

of the glow being proportional to the current. Wehnelt† has shown that the discharge from the cathode is confined to the area covered by the glow and that the current density is constant over this area; this shows that the current density at the cathode is independent of the total current flowing through the tube, provided that this is not so large as to make the glow envelop the whole of the cathode. Wilson made a series of experiments in air at different pressures, ranging from 6.7 mm. to .023 mm., and found that if C is the total current flowing through the tube in milliamperes,

* H. A. Wilson, *Phil. Mag.* vi. 4, p. 608, 1902.

† Wehnelt, *Ann. der Phys.* vii. p. 237, 1902.

l the length of wire covered by the glow in centimetres, d the diameter of the wire in centimetres, p the pressure of the gas in mm. of mercury, then $C/l\pi(d + \cdot 05)p$ is approximately constant and equal to $\cdot 4$; this result indicates that the current density at a point $\cdot 25$ mm. from the surface of the cathode is constant when the pressure is constant whatever the diameter of the wire, and is proportional to the pressure when this alters. It is remarkable that the current density is the same for aluminium as for platinum electrodes, though the cathode fall is different. An inspection of Wilson's numbers shows that though C/p is approximately constant there is a tendency for it to slowly decrease to a minimum and then slightly increase again.

264. *The distribution of electric force in the dark space and negative glow.* The first determination of the electric force in the dark space was made by Schuster*, who showed that if V is the difference of potential between the cathode and a point in the dark space or negative glow at a distance x from the cathode, then the relation

$$V = V_0 (1 - e^{-kx}),$$

where V_0 is the cathode fall and k a constant (for constant pressure), represented very approximately the results of his experiments.

This distribution of potential would, since $\frac{d^2 V}{dx^2} = -4\pi\rho$, where ρ

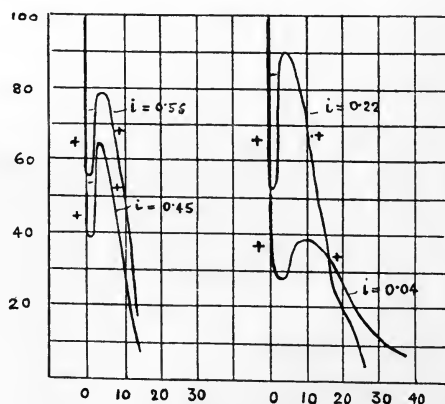

Fig. 153.

* Schuster, *Proc. Roy. Soc.* xlvii. p. 526, 1890.

is the density of the free electricity, involve in the dark space the existence of a positive charge of electricity, whose density decreases in geometrical progression as the distance from the cathode increases in arithmetical progression.

Graham*, who also measured the distribution of the electric force in the dark space near the cathode in nitrogen, obtained for the distribution of potential results represented by the curves in Fig. 153. From these curves it would follow that although throughout the greater part of the dark space the electrical charge is positive, there is a layer of negative electricity just in front of the cathode. Wehnelt has repeated Graham's experiments without finding the nicks in the curve near the cathode; he ascribes them to the two exploring wires not being in the line of the current. Wehnelt gives the following curves as representing the distribu-

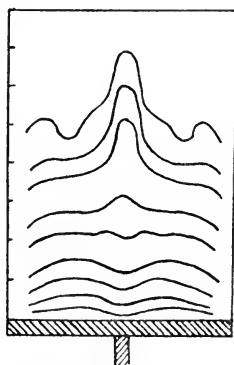

Fig. 154.

tion of the equipotential surfaces near the cathode; they probably are influenced to some extent by the walls of the tube. Both Schuster and Graham found that the electric force increased very rapidly close to the cathode; it was however very appreciable throughout the dark space. Skinner†, in some recent experiments, came to the conclusion that the whole of the cathode fall takes place quite close to the cathode, and that the electric force in the rest of the dark space is exceedingly small. I think the latter result must be due to the exploring wire not having

* Graham, *Wied. Ann.* lxiv. p. 49, 1898.

† Skinner, *Phil. Mag.* vi. 2, p. 616, 1902.

taken up the potential of the gas around it; for Strachan, using the method described on page 532, has found in agreement with Schuster and Graham that although the force increases exceedingly rapidly near the cathode, it is quite appreciable throughout the rest of the dark space.

265. The cathode fall of potential ceases to be constant when the negative glow covers the whole of the electrode, or when it reaches to the walls of the tube; its value under these circumstances is always greater than the normal fall and may rise to a very high value. Stark* has given the following formula connecting the cathode fall of potential K with the intensity of the current when this is large enough to cover the whole of the cathode with negative glow

$$K = K_n + \frac{k}{pf^{\frac{1}{2}}} (C - xpf)^{\frac{1}{2}},$$

where K_n is the normal cathode fall, p the pressure of the gas, f the area of the cathode, C the current through the tube, and k and x constants.

266. *Thickness of the dark space.* As the pressure diminishes the dark space gets broader and broader: the connection between the pressure of the gas and the width of the dark space has been investigated by Puluz†, Crookes‡, and more recently by Ebert§. According to Ebert the width of the dark space is not in general inversely proportional to the pressure of the gas, *i.e.* directly proportional to the mean free path of the molecules of the gas. The law found by Ebert when the cathode was so remote from the walls of the tube that the latter did not exert any restriction on the growth of the negative glow may be expressed as follows.

Let d_1, d_2 be the thicknesses of the dark space in the same gas at the pressures p_1, p_2 respectively, then

$$\frac{d_1}{d_2} = \left(\frac{p_2}{p_1}\right)^m,$$

where m is a positive quantity in general less than unity; he

* Stark, *Physikalische Zeitschrift*, iii. p. 274, 1902.

† Puluz, *Wien. Sitz.* lxxx. p. 874, 1880.

‡ Crookes, *Phil. Trans.* clxx. p. 138, 1879.

§ Ebert, *Wied. Ann.* lxix. pp. 200, 372, 1899.

found that for the gases examined, air, O₂, H₂, N₂, CO, and CO₂, there was a discontinuity in the relation between d and p when a certain pressure Π , different for the different gases, was reached, the value of m for pressures greater than Π differing from its value for lower pressures; thus to take oxygen as an example, Ebert found that for pressures greater than .7 mm. of Hg m had the value .459, while for lower pressures m was equal to .738. It is remarkable that the pressure .7 mm. is the pressure at which Bohr*, Baly and Ramsay† found a discontinuity in the relation between the pressure and the volume of the gas to occur. Battelli‡ also obtained this result. Lord Rayleigh§, who made a very careful examination of the relation between the pressure and the volume of oxygen, was unable to detect any such discontinuity. Newall|| discovered that the electrodeless discharge through oxygen behaved very differently according as the pressure was greater or less than a certain critical pressure which was about .7 mm. Ebert¶ gives the following values for Π , the pressure at which the change in the law connecting p and d appears, and for d the thickness of the dark space at a pressure of 1 mm.

Gas	Π	d
H ₂	2.0 mm.	3.8
CO	1.3 mm.	2.6
N ₂	1.0 mm.	2.2
CO ₂	1.1 mm.	2.1
Air	0.9 mm.	1.9
O ₂	0.7 mm.	1.6

He states that Π is approximately proportional to the reciprocal of the linear dimensions of the cathode; if this is the case there seems no reason for connecting Π with the stage where there is a change in the relation between the pressure and volume of the gas.

* Bohr, *Wied. Ann.* xxvii. p. 459, 1886.

† Baly and Ramsay, *Phil. Mag.* v. 38, p. 307, 1894.

‡ Battelli, *Physikalische Zeitschrift*, iii. p. 17, 1901.

§ Rayleigh, *Phil. Trans.* A. 196, p. 205, 1901.

|| Newall, *Proc. Camb. Phil. Soc.* ix. p. 295, 1897.

¶ Ebert, *Verhand. Deutsch. Physik. Ges.* ii. p. 99, 1900.

267. The following results taken from Ebert's paper will give some idea of the thickness of the dark space d at different pressures p in different gases.

Air

p in mm. of Hg	2.06	1.24	0.61	0.47	0.27	0.19
d in mm.....	1.2	1.8	2.4	3.1	4.6	7.0

Oxygen

p	1.18	0.73	0.45	0.29	0.183	0.129	0.083	0.051
d	1.64	2.09	2.93	4.16	5.48	7.69	10.43	14.3

Hydrogen

p	3.05	2.04	1.37	0.95	0.72*	0.54	0.40
d	1.5	2.0	2.8	4.0	5.0	5.6	7.0

Nitrogen

p	2.85	1.91	1.25	0.82	0.54*	0.35	0.26
d	1.0	1.5	2.0	2.7	4.0	6.5	8.0

The results for hydrogen and nitrogen are plotted in Fig. 155, where the ordinates represent the thickness of the dark space and the abscissæ the reciprocals of the pressure. It will be seen that the points representing the experiments at the higher pressures lie very well on straight lines, while at lower pressures they no longer do so. The pressures when the curvature becomes marked are close to the pressures called by Ebert the 'critical pressure.' He found that as the pressure diminished the potential

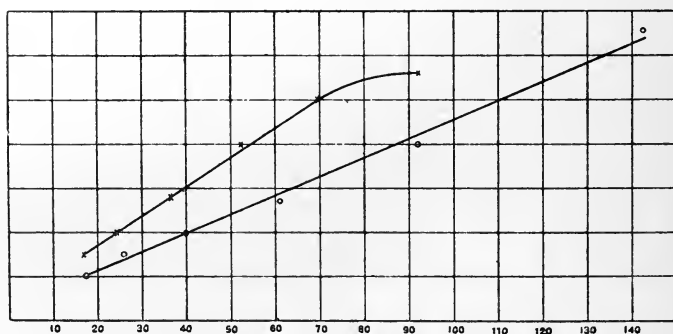

Fig. 155.

difference between the terminals at first diminished until this critical pressure was reached; when the pressure was still further reduced the potential difference *increased* as the pressure was

diminished. The critical pressure was found to depend upon the size of the vessel, the larger the vessel the lower the critical pressure. The critical pressure marks the stage when the walls of the vessel begin to restrict the formation of the glow and to complicate the phenomena. In studying the laws governing the formation of the dark space it is better to confine ourselves to pressures higher than the critical pressure, when the walls of the tube do not exert any influence. Confining our attention to such pressures, I am inclined to interpret Ebert's experiments somewhat differently from Ebert himself. His experiments show, I think, that d , the thickness of the dark space, may be expressed in the form

$$d = a + \frac{b}{p},$$

where p is the pressure, and a and b are constants. If λ is the mean free path of a molecule of the gas, λ is proportional to $1/p$, and the preceding equation may be written in the form

$$d = a + \beta\lambda \dots \dots \dots (1),$$

or the dark space measured from a distance a in front of the cathode is proportional to the mean free path of a molecule of the gas. If we plot the curve in which the ordinate is the thickness of the dark space and the abscissa the mean free path of a molecule of the gas, then taking λ for nitrogen at atmospheric pressure to be equal to 9.86×10^{-6} cm. and for hydrogen to 1.85×10^{-5} cm. (see Meyer, *Kinetische Theorie der Gase*), we find that the curves for hydrogen and nitrogen are almost identical; this indicates that in equation (1) the constants a and β are the same for the two gases, *i.e.* that if instead of measuring the dark space from the cathode itself we measure it from a constant distance from the cathode the thickness of the dark space bears to the mean free path of the molecules of the gas a ratio which is the same for these gases. The discharge in fact behaves as if the negative carriers came from a region a little in front of the cathode, and not from the cathode itself. H. A. Wilson's experiments on the current density at the surface of the cathode suggest the same view; the value of a , the constant in equation (1) as given by the curves in Fig. 155, is about .4 mm. The thickness of the layer at the surface, of which Wilson found the current density to be constant, is in air .25 mm.: these two quantities are of the same order, and we

cannot claim for the value of a as determined by the curve in Fig. 155 any great accuracy, as a slight error in the observations might produce a large percentage error in a ; for this reason I think it possible that the identity of the values of a found for hydrogen and nitrogen may be partly accidental, and more experiments are needed before it can be considered as established that a is the same for all gases. It would be interesting to see if the thickness of the velvety glow which covers the surface of the cathode is equal to a . When the negative glow covers the whole of the cathode the thickness of the dark space depends upon the current through the tube as well as the pressure of the gas, hence in order to get the simplest relation between the thickness of the dark space and the pressure, the current through the tube should be small, so that the current density at the cathode may be constant. Ebert's experiments were made with large currents.

Connection between the thickness of the dark space and the free path of a corpuscle.

268. The mean free path of a hydrogen molecule at 0° C. and 760 mm. pressure is 1.85×10^{-5} cm. (Meyer, *Kinetische Theorie der Gase*). The mean free path of a corpuscle will be greater than this, first because the corpuscle is smaller than the molecule; if for the sake of definiteness we take the view that the collisions between two molecules and between a corpuscle and a molecule are analogous to those between two elastic spheres, then, neglecting the radius of a corpuscle in comparison with that of a molecule, the distance between the centres of a molecule and a corpuscle when in collision will be half the distance between the centres of two molecules when in collision. Now the free path is inversely proportional to the square of the distance between the centres when the spheres are in collision; thus the free path of the corpuscle will be four times that of the molecule. Again, under the electric field the corpuscles move with a velocity very great compared with the average velocity of translation of the molecules, so that the latter may be considered to be at rest. Maxwell* has shown that the free path of a body moving through a collection of molecules at rest is $\sqrt{2}$ times the free path if the molecules were moving with an average velocity of translation equal to that

* Maxwell, *Collected Papers*, vol. i. p. 386.

of the moving body; thus the mean free path of a corpuscle moving through hydrogen at 0° C. and 760 mm. pressure will be $4\sqrt{2} \times 1.85 \times 10^{-5}$ cm.; the free path at a pressure of 1 mm. will therefore be $4\sqrt{2} \times 1.85 \times 760 \times 10^{-5}$ cm., or about $\cdot 8$ of a millimetre. The thickness of the dark space in hydrogen at this pressure reckoned from a distance $\cdot 4$ mm. from the cathode is about 3.3 mm., or roughly four times the mean free path of the corpuscle; thus the thickness of the dark space is a quantity of the same order of magnitude as the free path of a corpuscle calculated on the very special hypothesis used above.

Schuster* found that the thickness of the dark space depended to some extent on the current passing through the gas, increasing slightly with an increase in current. Wehnelt† on the other hand found that the dark space contracted as the current increased; this seems to indicate that the dark space may have a stationary value for some particular current, increasing or decreasing with the current, according as the current is on one side or the other of this particular value. The increase in the thickness of the dark space as the current diminishes is shown in a very striking way when a hot lime cathode is used. Starting with a large current and gradually diminishing it the dark space may be seen to expand to several times its original thickness before the current becomes too small for the luminous discharge to pass.

269. Disintegration of the cathode. When the discharge passes through the tube portions of metal shoot out normally from the cathode and form a thin metallic film on the walls of the tube or any body in the neighbourhood of the cathode; indeed thin metallic films for semi-transparent mirrors are now frequently made by placing a piece of glass in a vacuum tube near a cathode made of the metal it is wished to deposit and sending a current through the tube. The amount of metal shot off from the cathode depends on the pressure of the gas in the tube, it is much greater at low pressures than at high. It depends also on the nature of the gas; thus there is very little disintegration of aluminium electrodes in air, but a large amount in the monatomic gases, helium, argon and

* Schuster, *Proc. Roy. Soc.* xlvii. p. 556, 1890.

† Wehnelt, *Physikalische Zeit.* ii. p. 518, 1901.

mercury vapour. It depends largely on the nature of the metal. According to Crookes* the order of the metals in descending order of disintegration is Pd, Au, Ag, Pb, Sn, Pt, Cu, Cd, Ni, In, Fe. Granqvist† found that the order depended on the pressure of the gas. Thus at high pressures he found that Pt lost more than Au, at low pressures less. His results showing the connection between disintegration and pressure are represented by the curves in Fig. 156, where the ordinates are the loss of weight in milli-

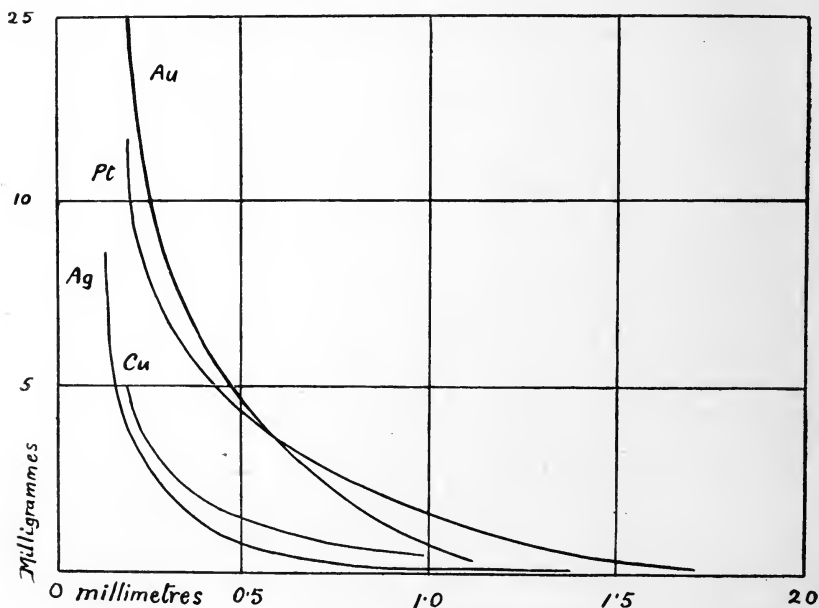

Fig. 156.

grammes in an hour for electrodes 12 mm. long, 4.8 mm. broad, and .06 mm. thick when a current of 2.46 milliampères passed through the tube, and the abscissæ the pressures. Granqvist found also that the loss in weight in a given time is proportional to the square of the current when the pressure is constant. Crookes found that if the cathode consisted of the alloy of gold and aluminium discovered by Roberts-Austen the gold was deposited while the aluminium was not; thus the composition of the cathode was changed by the discharge. The amount of metal

* Crookes, *Proc. Roy. Soc.* 1. p. 88, 1891.

† Granqvist, *Oefversigt. Kgl. Vetensk. Akad. Forh. Stockholm*, 1898, p. 709.

volatilised from a cathode is very much greater than that from the same wire when incandescent; thus Granqvist* found that he got as much from a cathode in a few minutes as he got from the same wire when incandescent and without charge, or when used as an anode, in twelve hours. The streams of metal from the cathode are deflected by a magnet, although not to anything like the same extent as the cathode rays.

Holborn and Austin † have made some very interesting experiments on the amount of disintegration of cathodes of different metals under similar electrical conditions. They used a constant current density of about 1 milliampère per square centimetre of cathode surface; this current density is large enough to make, at the pressures they employed, the cathode potential fall depend upon the pressure, so that by altering the pressure they could obtain large variations in this fall. When the tube was filled with air, they found that y , the loss of weight in 30 minutes from circular cathodes 1 cm. in diameter, could for platinum, silver (one sample), copper and nickel be represented by the formula

$$y = 0.0016 \frac{A}{n} (V - 495) \dots \dots \dots (1);$$

for silver (another sample), bismuth, palladium, antimony and rhodium the relation was

$$y = 0.0018 \frac{A}{n} (V - 495) \dots \dots \dots (2).$$

V is the cathode fall of potential in volts, A the atomic weight of the metal, and n its valency: other metals such as iron, aluminium and magnesium do not follow either of these laws. The normal cathode fall was about 360 volts so that the disintegration of the cathode does not become appreciable until the cathode fall considerably exceeds its minimum value. For those metals which follow the laws (1) or (2) we see that with the same current and cathode fall the weight of cathode disintegrated is proportional to the weight of those metals which would be deposited in voltmeters placed in series with the discharge tube, the weight disintegrated is only equal to the amount deposited for a particular value of the cathode fall; in Holborn and Austin's

* Granqvist, *Kgl. Akad. Stockholm*, liv. p. 595, 1897.

† Holborn and Austin, *Wissenschaft. Abhand. der Physik. Tech. Reichanstalt*, Bd. iv. p. 101, 1903.

experiments this value was about 1000 volts, for smaller values of this fall the amount disintegrated was much less while for larger values of the fall it was greater than the amount deposited; this shows that the current through the tube is not transmitted from the cathode to the gas entirely by the metal given off from the cathode, and indeed there is no evidence that the disintegration of the cathode plays an important or even an appreciable part in the transmission of the current.

In hydrogen the disintegration is less than in air and Holborn and Austin were unable to find any trace of a law similar to that expressed by equations (1) and (2).

The case of hydrogen is an interesting one because there is evidence that the presence of this gas in the metal used for the cathode and its expulsion when the discharge passes has great influence upon the discharge. The cathode, especially when the pressure is not so low that the current density is small, emits considerable quantities of hydrogen. This question has been investigated by Skinner*; in his experiments the discharge tube was filled with helium at the comparatively high pressure of 3 mm. of mercury, the current density was not great enough to affect the cathode fall which was normal. The helium was carefully purified and when first the discharge passed through the tube the spectrum was free from the hydrogen lines, if the discharge continued hydrogen lines soon appeared and the pressure of the tube increased owing to the emission of hydrogen. The rate at which the hydrogen was evolved was measured, and it was found that it gradually decreased as the duration of the discharge increased. If the current was stopped and the electrodes given a rest for a day or so, then, even though the cathode had not been in contact with hydrogen, on starting the current the initial rate of evolution of hydrogen was as great as when the cathode was first used. The amount of hydrogen that can be got out of a cathode in this way is very large, thus from a silver electrode .15 c.c. in volume Skinner obtained about 2 c.c. of hydrogen at atmospheric pressure, without any indication that the supply was in any way exhausted. At certain stages the rate at which hydrogen was evolved from the cathode was equal to the rate at which it was liberated from a voltameter placed in series with the

* Skinner, *Phys. Review*, xxi. p. 1, 1905.

tube. Skinner concludes from this that the hydrogen carries the negative electricity from the cathode to the gas. I do not think we have any evidence of this any more than in the analogous case of the disintegration of metallic cathode, in fact the evolution of hydrogen and the disintegration of metal seem to be quite analogous, the former being most prominent when the potential fall is small, the latter when it is large.

The effect of hydrogen on the discharge is, I think, closely related to the effect produced by hydrogen on the emission of negative corpuscles from hot metals.

H. A. Wilson (see p. 202) has shown that the presence of hydrogen in a hot platinum wire enormously increases the rate at which corpuscles are emitted by the wire. From this we may conclude that it is much easier to get corpuscles from a cathode charged with hydrogen than from one from which the hydrogen is expelled. The cathode fall of potential depends upon the energy which a positive ion must communicate to the cathode in order to make it emit a corpuscle, thus if the cathode contains hydrogen the cathode fall will be less than it would be if the gas were removed. The hydrogen charged cathode may be regarded as made up of two substances, one the metal with a large cathode fall of potential, the other hydrogen with a low fall, and it will behave approximately as a hydrogen cathode, the hydrogen furnishing the corpuscles necessary for the maintenance of the current, the hydrogen atoms being ionised by collision with the positive ions striking against the cathode, and getting so much energy communicated to them that they are able to escape from the cathode. It is not until the cathode fall gets very high that the metal of the cathode gets ionised and disintegrated. The evolution of hydrogen with low cathode fall may be looked upon as the disintegration of a hydrogen cathode, when the cathode fall gets greater we get superposed on this the disintegration of the metallic part of the cathode. It would be interesting to make measurements of the cathode fall of potential for metals free from hydrogen, the difficulties of getting rid of the hydrogen are however very great. I described (*Phil. Mag.* Oct. 1897), some time ago, some experiments which indicated that the absorption of gas had a great effect upon the cathode fall. The origin of the hydrogen found in metals has not yet been satisfactorily explained, and the

amounts of it present are often surprisingly large. Skinner found for example that the alloy of sodium and potassium even when distilled in a vacuum gave off hydrogen at a constant rate, and I have observed similar effects with sodium, these metals are known to absorb hydrogen but their affinity for it must be greater than is ordinarily supposed for them to acquire such large stores with such few opportunities. Skinner* has shown that with carbon electrodes nitrogen is given off by the cathode. Cunningham† has studied the evolution and absorption of nitrogen by carbon electrodes, he found that nitrogen freshly discharged from carbon transmitted the electric discharge more easily than ordinary nitrogen.

270. *Absorption of gas produced by the discharge.* When the discharge passes through a tube containing gas at a low pressure, the pressure in many cases continually diminishes. This effect is very well known with the tubes used to produce Röntgen rays, the pressure of the gas in these tubes diminishes with the use of the tube until it gets so low that the discharge refuses to pass, and fresh gas has to be frequently introduced into the tube either through hot platinum or by heating the walls of the tube to prevent the vacuum getting too high. The amount of gas that can be disposed of in this way is very considerable, in one case I measured many cubic centimetres of gas at atmospheric pressure were absorbed in the tube without any indication that the rate of absorption was falling off.

The absorption of gas during the discharge has been studied by Willows, Riecke and Skinner. Willows' experiments suggest that a large part of the absorption is due to chemical combination between the walls of the tube and some substance produced when the discharge passes through the gas. He found that with a constant current the rate at which the gas disappeared depended upon the kind of glass of which the tube was made, thus with soft soda glass, hydrogen, air and nitrogen were absorbed with equal rapidity, while with lead glass the absorption with hydrogen was so small that it was overpowered by the evolution of gas from the cathode, with air and nitrogen on the other hand the absorption was only about ten per cent. less than with soda glass. On heating

* Skinner, *Phys. Review*, xxi. p. 169, 1905.

† Cunningham, *Phil. Mag.* [6], ix. p. 193, 1905.

the tube in which the absorption had taken place a little gas was given off from the glass but the amount recovered in this way was only a small fraction of that absorbed. Silvering the inside of a lead glass tube produced very little effect upon the rate of absorption. Absorption takes place though more slowly when the electrodeless discharge is used so that it can not wholly be due to absorption by the electrodes. Nor is it due to the escape of gas through the walls of the tube, for I have found that when fresh gas is introduced into a tube and absorbed the weight of the tube increases by the weight of gas so introduced.

The amount of gas absorbed in this way is only a small fraction of that which would be liberated in a voltameter by the current passing through the discharge tube.

Mey has shown that the liquid alloy of Na and K when used as a cathode absorbs all gases except argon, helium and the other inert gases, it thus affords a convenient means of purifying these gases.

The Faraday dark space and the Positive Column.

271. Measurements of the electric force in the Faraday dark space were first made by Hittorf*. Graham† and H. A. Wilson‡ also made numerous determinations of the force in this as in other parts of the discharge, while Skinner§ has recently investigated the influence of pressure and of the magnitude of the current on the force in the dark space and on its length. The results of Skinner's experiments, which were made on carefully purified nitrogen, and with disc electrodes of considerable area, are represented in Fig. 157. An inspection of these curves shows that when the pressure is kept constant the width of the Faraday dark space increases as the current increases. (The boundaries of the dark space were found by Skinner to be at the points corresponding to the intersection of the straight line ll with the curves giving the electric force.) The current drives, as it were, the luminous positive column back on the anode, until with the largest current used the

* Hittorf, *Wied. Ann.* xx. p. 705, 1883.

† Graham, *Wied. Ann.* lxiv. p. 49, 1898.

‡ H. A. Wilson, *Phil. Mag.* [5], xlix. p. 505, 1900.

§ Skinner, *Phil. Mag.* [5], l. p. 563, 1900.

luminous positive column was reduced to a patch close to the anode. With the same current the width of the dark space is greater at low pressures than at high.

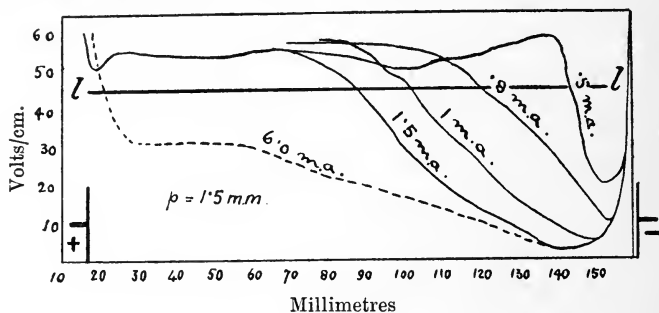

Fig. 157.

Skinner made an interesting experiment in which the gas in the tube was shielded from any disturbance travelling normally from the cathode. The cathode was a disc placed with its plane in the axis of the tube. This was surrounded by a piece of glass tubing, the axis of the tube being at right angles to the disc; thus any disturbance travelling from the cathode at right angles is prevented from reaching any but a small part of the gas between the electrodes. With this apparatus it was found that the luminous positive column occupied nearly the whole of the space up to the cathode: the dark space was very small, and increased but little with an increase in the current. Skinner observed that (with a tube of the normal type with the electrodes facing each other) when once by means of a large current the luminous positive column had been driven back on the anode, the gas took a considerable time before it recovered the power of transmitting a luminous discharge; the time required for the recovery depended upon the time the large current had been kept flowing through the tube. Skinner mentions times of one or two hours as having been required in some of his experiments. It would be interesting to try if this effect occurred if the tube were immersed in liquid air which might be expected to condense complex gases formed by the discharge.

Since with the exception of the cathode dark space the only dark part of the discharge is that where the curve representing the electric force is below the line U (Fig. 157), it follows from

Skinner's experiment that there is luminosity at all parts of the tube (with the exception of the cathode dark space), when the electric force exceeds a certain value depending on the pressure.

The Positive Column.

272. The potential gradient along a uniform unstriated positive column is uniform; its value has been investigated by Hittorf*, A. Herz†, Graham‡, Wilson§, Skinner||, Heuse¶, Matthies**, and in air at atmospheric pressure by Kaufmann††, Stark‡‡, Stuchtey§§. The potential gradient in the positive column depends (1) upon the diameter of the discharge tube, (2) upon the pressure and nature of the gas through which the discharge is passing, and (3) upon the current passing through the gas.

The potential gradient diminishes as the diameter of the discharge tube increases, as the following table (p. 556) given by Herz (*loc. cit.*) shows. The influence of the size of the tube is not confined to tubes which are so narrow that their diameter is comparable with the mean free path of the molecules and corpuscles in the tube, but extends to the cases when the diameter of the tube is hundreds of times the mean free path. The results in the table relate to pure nitrogen; v is the potential gradient in volts per centimetre, $2R$ the diameter of the tube (the current passing through the tube was in all cases 1.2 milliamperes), p is the pressure of the gas expressed in millimetres of mercury, and b the constant occurring in the equation

$$v - v_0 = -b(i - i_0),$$

which according to Herz represents the relation between the

* Hittorf, *Wied. Ann.* xx. p. 726, 1883.

† Herz, *Wied. Ann.* liv. p. 244, 1895.

‡ Graham, *Wied. Ann.* lxiv. p. 49, 1898.

§ Wilson, *Phil. Mag.* [5], xlix. p. 505, 1900; *Proc. Cam. Phil. Soc.* xi. pp. 249, 391, 1902.

|| Skinner, *Phil. Mag.* [6], xi. p. 616, 1901.

¶ Heuse, *Ann. der Phys.* v. p. 678, 1901.

** Matthies, *Ann. der Phys.* xvii. p. 675, 1905; xviii. p. 473, 1905.

†† Kaufmann, *Phys. Zeit.* iv. p. 578, 1903.

‡‡ Stark, *Phys. Zeit.* iv. p. 535, 1903.

§§ Stuchtey, *Inaug. Diss.* Bonn, 1901.

gradients v and v_0 corresponding to the currents i and i_0 ; in this equation i and i_0 are expressed in milliamperes.

p	v			
	$2R=10$ mm.	$2R=15$ mm.	$2R=20$ mm.	$2R=25$ mm.
8.0	...	156.8
7.5	...	148.4
7.0	144.4	140.1
6.5	139.2	131.9
6.0	132.6	123.8
5.5	126.1	115.8
5.0	118.2	107.8
4.5	109.4	99.9	97.7	...
4.0	99.7	92.2	89.3	...
3.5	89.2	84.5	80.5	...
3.0	77.7	76.1	71.2	...
2.5	...	66.2	61.5	60.2
2.0	...	55.4	51.4	48.7
1.5	...	43.6	40.8	37.5
1.0	29.8	26.9
b	10.0	8.5	3.5	3.4

The potential gradient in the positive column increases with the pressure; the results of Herz's experiments are represented by the curves in Fig. 158, in which the ordinates represent the potential gradient and the abscissæ the pressure, the dotted curve relates to experiments with hydrogen, the others to experiments with nitrogen in tubes of different dimensions, the curves seem very approximately linear. H. A. Wilson* concluded from his experiments that the potential gradient in the positive column was proportional to the square root of the pressure; the linear relation $v = a + bp$, where v is the potential gradient, p the pressure and a and b constants, represents the results of his experiments almost equally well.

Herz showed that under similar conditions as to pressure and current the potential gradient in nitrogen was 1.4 times that in hydrogen. He found that a trace of aqueous vapour had no effect upon the gradient in the positive column, but that the

* H. A. Wilson, *Proc. Camb. Phil. Soc.* xi. pp. 249, 391, 1902.

presence of a small quantity of oxygen in the nitrogen increased the potential gradient.

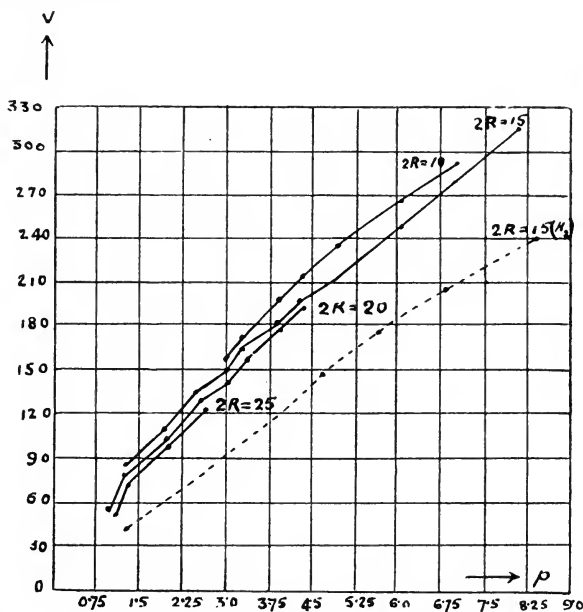

Fig. 158.

The magnitude of the potential gradient in the positive column in different gases is given in the following tables, the first of which is due to Matthies* and the second to Heuse†.

TABLE I. (Matthies.)

Current through tube .25 milliamperes. Diameter of tube 3.5 cm.

Pressure in mm. of Hg	Potential gradient in volts per centimetre						
	Cl ₂	HgCl ₂	Br ₂	HgBr ₂	I ₂	HgI ₂	N ₂
0.1	25	38	—	73	—	29	—
0.4	40	66	45	139	50	53	17
0.9	72	127	98	227	64	114	32
1.4	120	150	145	259.5	75	147	43
1.9	139	202	170	—	110	165	54
2.35	175	222	195	—	142	188	62
3.0	200	263	221	—	200	251	77

* Matthies, *Ann. der Phys.* xviii. p. 473, 1905.† Heuse, *Ann. der Phys.* v. p. 678, 1901.

TABLE II. (Heuse.)

Current through tube 0.52 milliampères.

	Mercury	Helium	Helium	Hydrogen	Nitrogen
Pressure	13.1	12.5	8	8.37	8.0
Diameter of tube	24 mm.	25	25	15	15
Potential gradient	16.9	34	22.7	112	156.8

The gradients in the monatomic gases mercury vapour and helium are very small compared with those in hydrogen and nitrogen. Bouty's experiments indicate that the gradient is small also in argon, the case with which tubes filled with neon become luminous makes it probable that in this gas the potential gradient is less even than in helium.

Relation between the potential gradient and the current.

273. From the relation $v - v_0 = -b(i - i_0)$ given by Herz it would follow that the potential gradient in the positive column continually increases as the current diminishes. H. A. Wilson has however shown recently that the potential gradient attains a maximum value for a certain value of the current and that when the current falls below this value the potential gradient rapidly diminishes. Matthies in his study of the discharge through the halogens also found cases in which the potential gradient increased with the current.

When the positive column is striated the variations in the luminosity are accompanied by variations in the electric intensity, the places of maximum luminosity are places of maximum potential gradient; this is clearly shown by the curve in Fig. 149, which is one given by Wilson for the striated discharge in hydrogen.

Anode drop in potential.

274. Skinner* has shown that there is a finite difference in potential between the anode itself and a point in the gas close to the anode. The magnitude of this drop in potential was investigated by him for the discharge through pure nitrogen,

* Skinner, *Wied. Ann.* lxxviii. p. 752, 1899; *Phil. Mag.* [6], viii. p. 387.

hydrogen, and oxygen; he found that it was independent of the current density, in hydrogen and oxygen it was independent of the pressure, in nitrogen it seemed to increase slightly with the pressure, it is possible however that this increase is due to secondary effects. The anode fall depends to a small extent upon the metal of which the anode is made, being greatest for aluminium and magnesium, for which the cathode fall of potential is least; the value of the anode drop in different gases and for different metals are given in the tables on page 560 along with Skinner's determination of the cathode potential fall. It will be observed that the anode drop is much smaller than the cathode one, it is also much more abrupt; there does not seem any region comparable in dimensions with the cathode dark space in which the drop of potential occurs; in none of the experiments hitherto made has it been found possible to get so close to the anode that the potential of the exploring wire differed by less than the anode fall of potential from the potential of the anode.

The differences between the anode fall for different metals is exceedingly small, hardly more than the contact difference of potential between various metals. In chlorine, bromine, iodine and the vapours of HgCl_2 , HgBr_2 , HgI_2 , the anode fall has according to Matthies very large values.

There is frequently a region in which the electric intensity is very small just in front of the anode; in some of the experiments made by H. A. Wilson, the electric intensity was apparently negative; we must remember that the introduction of the exploring wire disturbs the field, and if there are only ions of one sign present does not measure the potential, and that this reversal of the electric intensity may be due to this cause.

Number of ions at various points along the discharge.

275. H. A. Wilson* has made a series of investigations on this point; his method was to determine the current flowing between two small parallel platinum plates, the planes of the plates being parallel to the current flowing through the tube, a small potential difference (that due to one Clark's cell) was maintained between the plates, previous experiments having shown

* H. A. Wilson, *Phil. Mag.* [5], xlix. p. 505, 1900.

TABLE I. *Anode fall in volts.*

Gas	Gas pressure (mm. of Hg)	Pt	Ag	Au	Cu	Fe	Ni	Bi	Sb	Sn	Pb	Cd	Zn	Al
Hydrogen ...	1.73	18.0	18.4	20.1	18.9	22.1		19.9	20.6	20.8	20.3	20.7	20.4	20.1
	1.71	18.4	18.8	19.5	19.7	18.5	19.9	18.0				19.9	20.2	20.1
	1.70	17.3	17.7	20.7	20.0		19.3					19.1	19.1	19.7
Nitrogen ...	1.39	18.8	19.1	21.1	19.7	19.7	20.3				20.6	19.7	19.6	22.2
	1.37	18.5	18.6	19.9	19.0	19.4	19.4				20.0	19.1	18.5	21.9
Oxygen	1.20	22.2		24.3	23.2	23.8	23.5		23.5	24.2		24.2		23.9

TABLE II. *Cathode fall in volts.*

Gas	Gas pressure	Pt	Ag	Au	Cu	Fe	Ni	Bi	Sb	Sn	Pb	Cd	Zn	Al
Hydrogen ...	2.03	399	406	386			397			389	382	359	326	269
Nitrogen ...	1.23	252	258	258	258	255	237				243	266	265	217
Oxygen	1.21	362	371	364	350	339	331			360	370	349	347	302

that with potential differences of this order the current was proportional to the potential difference, and therefore that the presence of a field of this intensity did not appreciably reduce the number of free ions. Under these circumstances if n_1 , n_2 are the numbers of positive and negative ions respectively, k_1 , k_2 the velocities of these ions under unit electric force, the current between the plates is proportional to $k_1 n_1 + k_2 n_2$. The results of Wilson's experiments are represented in Fig. 159. It will be

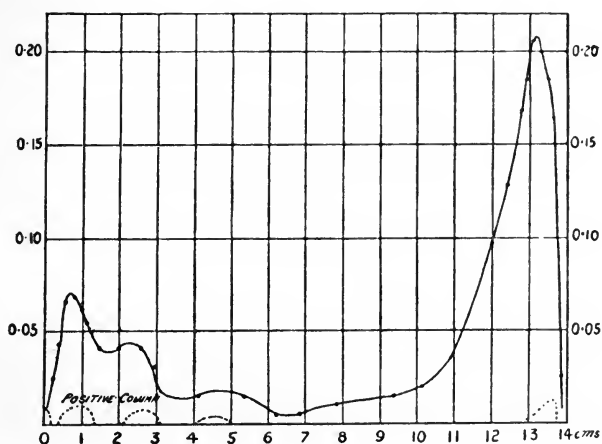

Fig. 159.

noticed that the current is very small in the cathode dark space, rises to its maximum value in the negative glow, sinks again in the Faraday dark space and increases in the positive column, while in the striated discharge the current is a maximum in the luminous parts of a striation, a minimum in the dark ones.

276. It is interesting to compare the distribution of the electric intensity along the tube with these transverse currents. If X is the force along the tube, i the current through unit area, and if the velocity of the ions is proportional to the electric force at the point, then we have

$$X (k_1 n_1 + k_2 n_2) = i;$$

as i is constant along the tube, $k_1 n_1 + k_2 n_2$ should be inversely proportional to X ; as $k_1 n_1 + k_2 n_2$ is proportional to the transverse current, we should expect the maxima for the transverse current

to coincide with the minima for X . An inspection of the curves will show that this is not the case; thus the electric intensity in the Faraday dark space is less than in the positive column; the transverse current is also less, instead of being greater as indicated by the preceding reasoning. Again, both the electric intensity and the transverse current are greater at the bright parts of a striation than at the dark; in fact, luminosity seems to be accompanied by abnormally great transverse currents; it was this that led H. A. Wilson to suggest that the transverse current in the luminous parts was increased by secondary ionisation due to the illumination of the testing electrodes by the luminosity of the discharge. Skinner has suggested as another explanation for the discrepancy between the values of X and the transverse current that the velocity of the ions may not be proportional to the electric force; that, for example, though the electric force in the Faraday dark space is very small the ions there may be moving with high velocities which they acquired in moving through the strong electric field in the cathode dark space; thus the number of free ions necessary to carry the current may be very considerably less than that calculated from the assumption that the velocity was that due to the electric force in the Faraday dark space. If this were the explanation of the distribution of the transverse force, then the velocity of the ions in the Faraday dark space ought to be greater than in the uniform positive column. Now we can get information about the distribution of the velocity of the ions at different parts of the tube by measuring the 'Hall effect.' H. A. Wilson* has shown that when a magnetic force acts at right angles to the current passing through a vacuum tube, then a difference of potential proportional to the magnetic force is established between two electrodes, placed so that the line joining them is at right angles both to the current and to the magnetic force. The theory of this effect, called the 'Hall effect,' has been given in Art. 127; we showed that when equal quantities of positive and negative ions are present, then if Z be the difference of potential between two electrodes 1 cm. apart due to a magnetic force H , then

$$\frac{Z}{H} = \frac{1}{2} (u - v),$$

* H. A. Wilson, *Proc. Camb. Phil. Soc.* xi. pp. 249, 391, 1902.

where u and v are respectively the velocities of the negative and positive ions. Thus a series of measurements of Z along the tube will enable us to deduce the distribution of velocities;

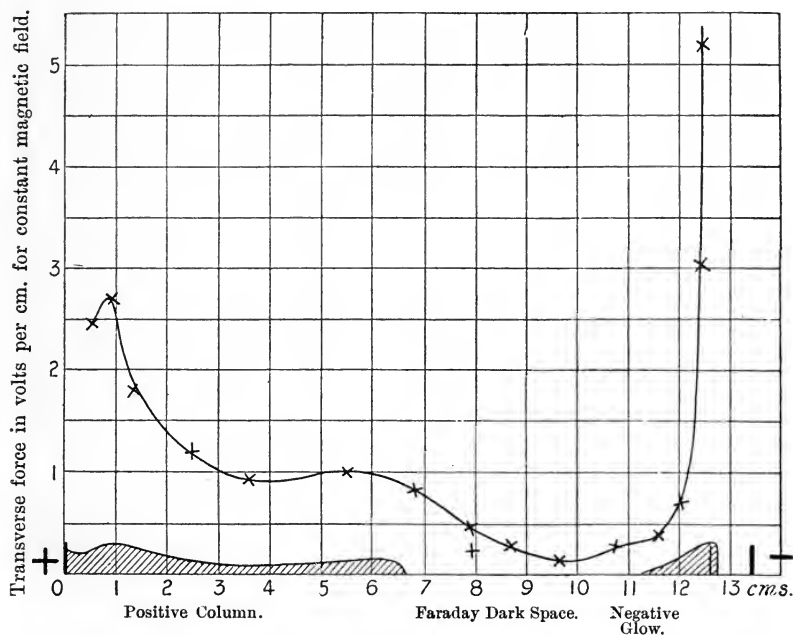

Fig. 160. Discharge in Air. Pressure 0.5 mm. Magnetic Field 22.1.

such measurements have been made by H. A. Wilson, and his results are represented in the curves given in Figs. 160 and 161.

It will be seen that the curves are similar in character to those giving the distribution of electric force; thus the value of Z in the Faraday dark space is less than in the positive column, and in a striated discharge Z , like X , is a maximum at the bright parts of the striation, a minimum at the dark. These results seem to indicate that though a certain amount of lag between the values of X and the velocity of the ions is probable, especially at low pressures, it is not sufficiently large to explain the discrepancies between the curves for X and those for the transverse currents; it must be remembered however that the interpretation of the Hall effect in cases where the electric field is not uniform is difficult and often ambiguous (see p. 247).

On Wilson's hypothesis that there is an additional ionisation due to the incidence of the light from the discharge on the metal of the electrodes, the current between electrodes made of wire-gauze might be expected to be less than that between solid electrodes, as the area of metal exposed to the light is so much less in the first case than in the second.

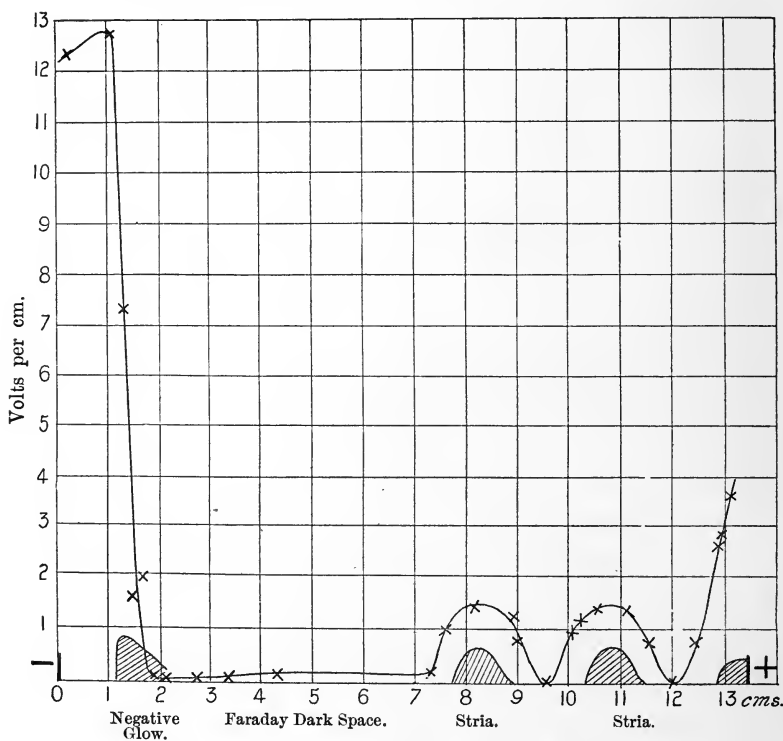

Fig. 161. Discharge in Air. Pressure 0.3 mm. Magnetic Field 29.4.

The striated discharge.

277. This form of discharge, examples of which are represented in Fig. 145, taken from papers by De la Rue and Müller*, has from its very striking and beautiful character attracted a great deal of attention. It only occurs, or at any rate is only well developed, when the pressure of the gas and the current through

* De la Rue and Müller, *Phil. Trans.* 1878, pt. i. p. 155.

the tube are within certain limits; it does not however depend upon the means used to produce the discharge; thus we get striations in discharges produced by induction coils, electric machines, or large batteries of storage or voltaic cells.

The striations are especially well developed in mixed gases, especially those which contain organic vapours, such as turpentine. Indeed some physicists consider they would not occur in perfectly pure gases*; it is however certain that they occur in gases which have been purified with the greatest care; according to Morren they do not occur in oxygen. Crookes† observed in a tube containing hydrogen three sets of striations, one set red, another blue, and the third grey; by spectroscopic examination he showed that the luminosity in the first set was due to hydrogen, that in the second to mercury vapour, and that in the third to hydrocarbons. It will be noticed from Fig. 145 that in some cases the striæ seem to occur in sets of two or three individual striæ situated quite close together. It will be seen that the luminous parts of the striæ are curved; the concavities being turned towards the positive electrode. When the tube is not of uniform width the striations are nearer together in the narrower than in the broad parts of the tube.

278. Investigations on the conditions determining the distance between successive striations have been made by Goldstein‡, and by R. S. Willows§. Goldstein came to the conclusion that if d and d_0 were the distances between the striations at the pressures p and p_0 , then

$$\frac{d}{d_0} = \left(\frac{p_0}{p}\right)^m,$$

where m is a quantity less than unity (compare Art. 266). The distance between the striations increases as the pressure diminishes, but the percentage change in the distance is not so great as that in the pressure.

Willows found that in nitrogen the distance between the striæ increases with the current. Beginning with the smallest current capable of maintaining the discharge the distance at first increases

* E. C. Baly, *Phil. Mag.* xxxv. p. 200, 1893.

† Sir W. Crookes, *Proc. Roy. Soc.* lxix. p. 399, 1902.

‡ Goldstein, *Wied. Ann.* xv. p. 277, 1882.

§ Willows, *Proc. Camb. Phil. Soc.* x. p. 302, 1900.

very rapidly with the current. The rate of increase falls off however as the current increases; the connection between the current and the distance between the striæ in nitrogen is represented by the curve in Fig. 162.

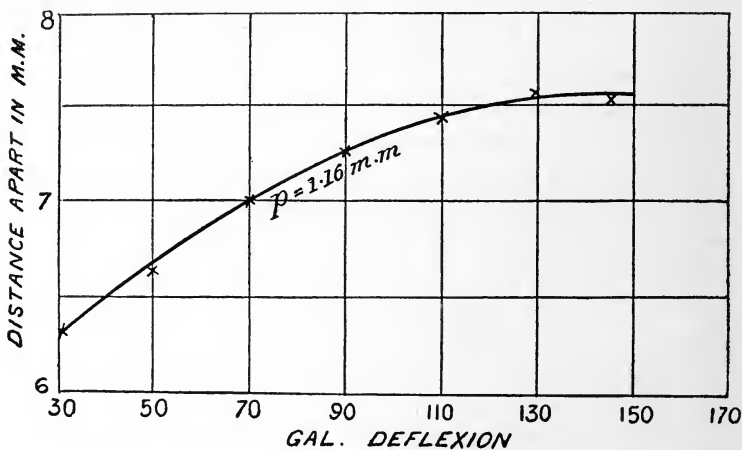

Fig. 162.

In hydrogen the distance between the striæ at first increases with the current; it then attains a maximum, and then any

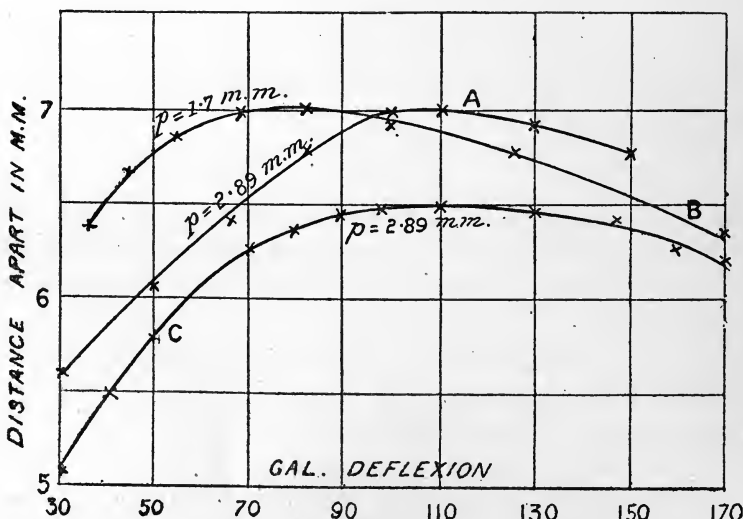

Fig. 163.

further increase in the current produces a diminution in the distance between the striæ—the lower the pressure the smaller the current for which the distance between the striæ is a maximum. At very low pressures this current may be very little larger than the smallest current consistent with a continuous discharge, so that at these pressures the phase where an increase in current causes the striæ to separate may be almost effaced. The relation between the current and the distance between the striæ for hydrogen at two different pressures in a tube 12 mm. in diameter is shown in Fig. 163. The terminals for curves *A* and *B* were aluminium wires, for *C* they were aluminium discs.

By comparing these results with those for the thickness of the cathode dark space we see that under similar conditions as to pressure and current the distance between the striæ is considerably greater than the thickness of the dark space.

Influence of the size of the discharge tube.

279. The wider the tube the greater the distance between the striæ. According to Willows (*l.c.*) this distance is never greater than the diameter of the tube. When the striæ reach to the sides of the tube Goldstein showed that the ratio of the distances between the striæ for two given pressures is independent of the diameter of the tube. Another way of stating Goldstein's law is that the constant *m* which occurs in the equation

$$\frac{d_1}{d_0} = \left(\frac{p_0}{p_1}\right)^m$$

(see Art. 278) is independent of the size of the tube.

Influence of the nature of the gas.

280. According to Willows the distances between the striæ in different gases under the same conditions as to pressure and current are not very different. At pressures between 1 mm. and .5 they are somewhat further apart in hydrogen than in air or nitrogen. The rate of alteration of the distance with the pressure is however greater in the denser gases than in hydrogen. The range of pressure over which striations can be obtained is much greater in hydrogen than in air.

281. The striæ are most readily developed at the negative end of the positive column. Thus if the pressure be gradually reduced to that at which striation occurs, the first appearance of striation is the formation of a single stria at the end of the positive column. Successive striations are then formed until the whole of the positive column is striated. The stria at the negative end of the positive column always retains some individuality; thus its distance from its next neighbour is greater than the average distance; it is also often brighter than the other striæ.

Effect of a sudden contraction in the discharge tube.

282. Goldstein* found that in a tube with a constriction, such as that in Fig. 164, the end of the constriction next the anode

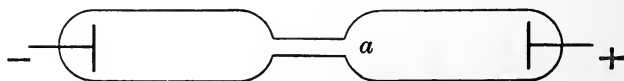

Fig. 164.

behaved like a cathode, *i.e.* that there was a dark space, negative glow, and Faraday dark space close to *a*; and that these were affected by a magnetic field in just the same way as if they had been produced by a metallic cathode. Lehmann† made a series of experiments with perforated diaphragms stretching across the discharge tube. He found on the side of the diaphragm next the anode the negative glow and the Faraday dark space; the cathode dark space was however absent. In the experiment represented in Fig. 165 the diaphragm was a porcelain sieve. He made other



Fig. 165.

experiments with tubes having several perforated metallic diaphragms stretching across them. These diaphragms were connected with wires fused through the tube so that they could be connected up in various ways. If the diaphragms were all insulated the

* Goldstein, *Wied. Ann.* xi. p. 832, 1880.

† Lehmann, *Ann. der Phys.* vii. p. 1, 1902.

appearance of the discharge was as represented in Fig. 165. On the anode side of each diaphragm there was the negative glow and the Faraday dark space, but no cathode dark space. If however two of the diaphragms were connected together by a metallic wire outside the tube, as Fig. 166, there was negative light but no dark

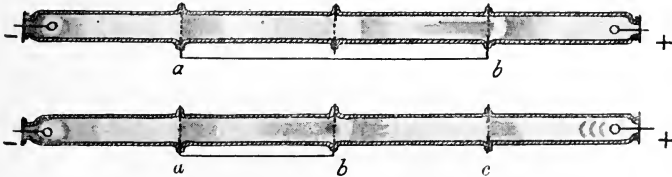

Fig. 166.

space on the right of the diaphragms *a* and *c*; there was however a well-defined dark space on the right of *b*. In this case some of the current instead of passing through the tube might pass through the wire outside, and at *b* would have, as at the cathode *k*, to pass from the metal to the gas. At the other diaphragms we may suppose the current went through the holes in the diaphragm.

283. Alternations in the luminosity of the discharge, similar in appearance to those observed in the striated positive column at

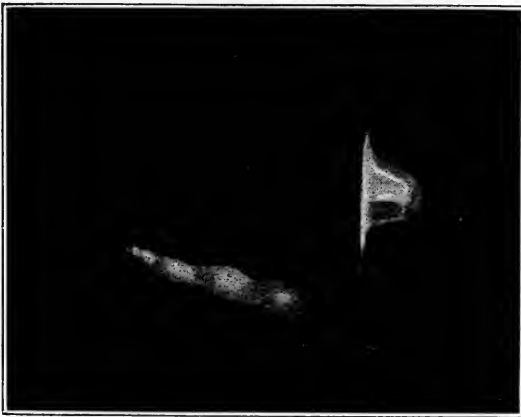

Fig. 167.

low pressures, occur in certain cases in the discharge through gas at atmospheric pressure. Thus Töpler* found that if several

* Töpler, *Wied. Ann.* lxxiii. p. 109, 1897.

large Leyden jars were discharged across a spark gap, a plate of semi-insulating material such as basalt being inserted between the terminals, the portion of the discharge between the negative electrode and the plate showed distinct striations. Fig. 167 is copied from a figure given by Töpler. The discharge of an induction coil through the flame of a candle gives a bright discharge traversed by dark spaces as in Fig. 168.

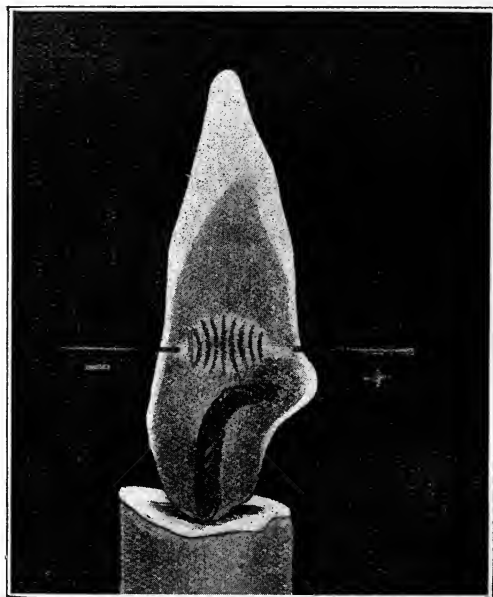

Fig. 168.

Distribution of temperature along the line of discharge.

284. The average temperature of the gas in a discharge tube through which a luminous discharge is passing is often less than 100°C . Thus E. Wiedemann* proved that the average temperature of air at a pressure of 3 mm. in a tube conveying a luminous discharge was less than 100°C . Hittorf† measured the temperature in a discharge tube at three places, (1) in the positive column, (2) in the negative glow and (3) in the Crookes dark space, and

* E. Wiedemann, *Wied. Ann.* vi. p. 298, 1879.

† Hittorf, *Wied. Ann.* xxi. p. 123, 1884.

found that it was highest in (3) and lowest in (1). E. Wiedemann* showed that the distribution of temperature along the tube depended materially upon the pressure, and that while at low pressures the temperature of the cathode was higher than that of the anode, the reverse was true at pressures greater than 26 mm. Wood† made a very complete survey of the temperature in a discharge tube by means of a bolometer, which, floating on a barometer column of mercury, could be placed in any position in the tube. He found that in the unstriated discharge the temperature is constant in the positive column, diminishes in the Faraday dark space until it reaches a minimum just on the anode side of the negative glow, and then rapidly increases in the dark space next the cathode. In the striated discharge the temperature is greater in the luminous parts than in the dark. In no case did the bolometer indicate a temperature of more than 100° C. The bolometer temperature is of course the average temperature of all the molecules in a considerable space, and the fact that the average temperature is low does not preclude a few of the molecules possessing an amount of kinetic energy very much greater than that corresponding to the

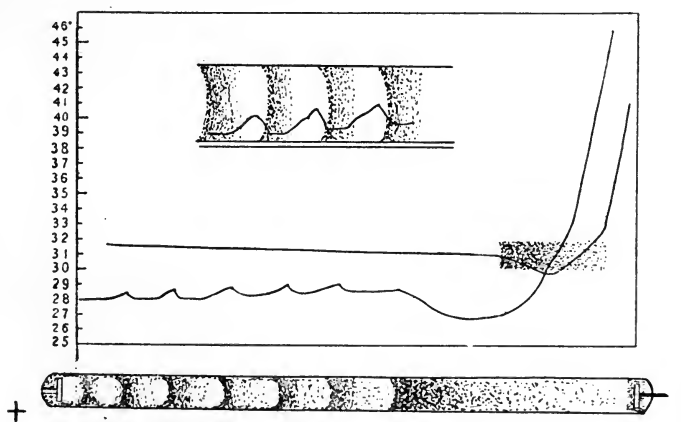

Fig. 169.

temperature indicated by the bolometer. The distribution of temperature along the tube in a striated and an unstriated discharge is indicated by the curves in Fig. 169. It will be seen on com-

* E. Wiedemann, *Wied. Ann.* x. p. 202, 1880.

† Wood, *Wied. Ann.* lix. p. 238, 1896.

paring these with the curves given for the distribution of electric force along the tube that the two curves are very similar. As the rate of work done by the current at any point of its path is proportional to the product of the current and the electric force, or since the current is constant, to the electric force, if all the work were converted into heat the curves for temperature would be similar to those for electric force. As this is very approximately the case we conclude that in tubes of moderate pressure the greater part of the electrical work appears as heat in the gas at places not very distant from where the work is done.

Action of a magnetic field on the discharge.

285. It is convenient to consider separately the action of the magnetic force on the various parts of the discharge. We shall begin with the negative glow. Plücker* showed that under a magnetic field the glow distributed itself in just the same way as a collection of iron filings having perfect freedom of motion; thus the bright boundary of the negative glow coincides with the lines of magnetic force passing through the end of the negative electrode.

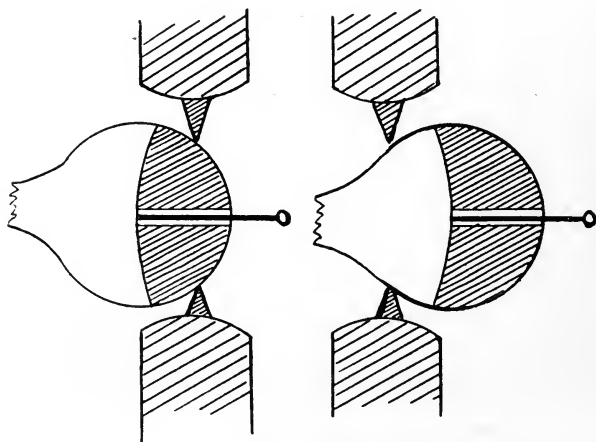

Fig. 170.

This effect is illustrated in Figs. 170, 171, and 172, which are taken from Plücker's paper. In Figs. 170 and 171 the lines of magnetic

* Plücker, *Pogg. Ann.* ciii, p. 88, 1858.

force are transverse to the current, while in Fig. 172 they are more or less along it. The negative glow in fact behaves as if its

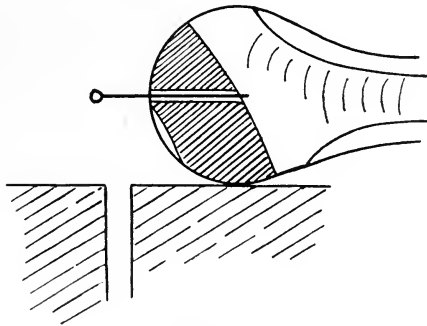

Fig. 171.

luminosity were produced by something moving along the lines of magnetic force. If the direction of the magnetic force is along

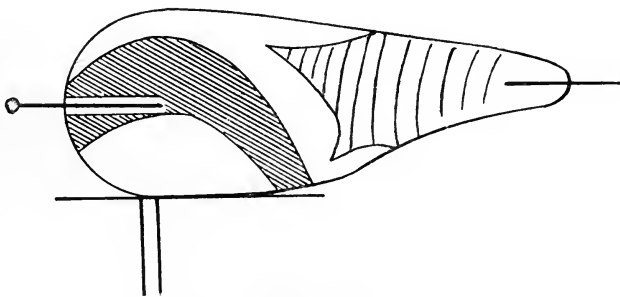

Fig. 172.

the line of discharge the negative glow spreads further down the tube and the positive column is driven back; if the magnetic force

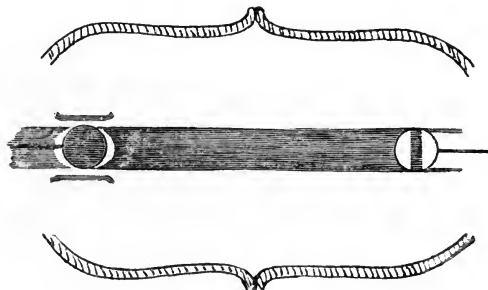

Fig. 173.

is at right angles to the tube, the negative glow follows the lines of force across the tube and does not extend so far down as when there is no magnetic field; the positive column now comes further down the tube towards the cathode, and if it is striated new striations appear. These effects are illustrated by Figs. 173 and 174,

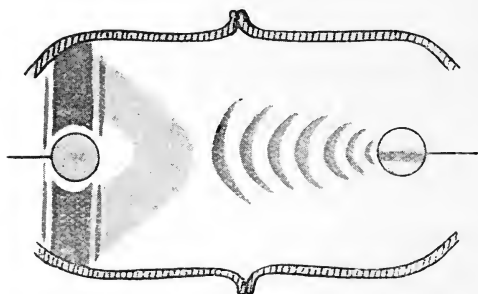

Fig. 174.

which are due to Lehmann*. Fig. 173 represents the case when the magnetic force is along, Fig. 174 when it is across the tube.

286. Magnetic force affects the disposition of the glow over the surface of the cathode as well as its course through the gas. Thus Hittorf† found that when the negative electrode is a flat vertical disc and the discharge tube is placed so that the disc lies axially between the poles of a strong electromagnet, the disc is cleared of glow except on the highest point on the side most remote from the anode or the lowest point on the side nearest to it, according to the direction of the magnetic force. In another experiment Hittorf, using as cathode a metal tube about 1 cm. in diameter, found that when the axis of the cathode was at right angles to the line joining the poles of an electromagnet the cathode was cleared of glow in the neighbourhood of the places where the normals are at right angles to the lines of magnetic force. Both these results are what we should expect if the glow were due to charged particles projected normally from the cathode. The effect of a magnetic field on the disposition of the glow over the cathode has also been investigated by Schuster‡.

* Lehmann, *Ann. der Phys.* vii. p. 1, 1902.

† Hittorf, *Pogg. Ann.* cxxxvi. p. 221, 1869.

‡ Schuster, *Proc. Roy. Soc.* xxxvii. p. 317, 1884.

287. The positive column is also affected by the magnetic field, the general effect being that the column is bent into a curve resembling the path of a positive particle under the action of the magnetic field and the electric force in the tube (see Art. 51). When the negative glow is deflected the positive column bends towards the place where the negative glow reaches the walls of the tube; this effect is shown in Fig. 175, which is due to Lehmann. There is often a dark space separating the ends of the negative glow and the positive column, as if the area of contact of the former with the glass acted like a secondary cathode.

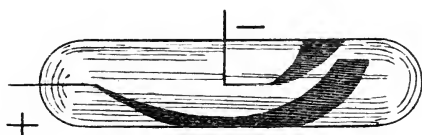

Fig. 175.

Effect of magnetic force on the striations.

288. The influence of the magnetic field on the striations has been carefully studied by Spottiswoode and Moulton*, and by Goldstein†; the conclusion they arrived at was that the bright parts of the striations, like the negative glow, set themselves along the lines of magnetic force, each bright part setting along the line of magnetic force passing through it and being separated by a dark space from its neighbour. As very important deductions have been made from this behaviour of the striæ, we quote the description of this effect given by Spottiswoode and Moulton and by Goldstein. The former say: "If a magnet be applied to a striated column it will be found that the column is not simply thrown up or down as a whole, as would be the case if the discharge passed in direct lines from terminal to terminal threading the striæ in its passage. On the contrary, each stria is subjected to a rotation or deformation of exactly the same character as would be caused if the stria marked the termination of flexible currents, radiating from the bright head of the stria behind it and terminating in the hazy inner surface of the stria in question. An

* Spottiswoode and Moulton, *Phil. Trans.* Part I. p. 205, 1879.

† Goldstein, *Wied. Ann.* xi. p. 850, 1880.

examination of several cases has led the authors of this paper to conclude that the currents do thus radiate from the bright head of a stria to the inner surface of the next, and that there is no direct passage from one terminal of the tube to the other." Goldstein gives the following description of the behaviour of the striated column under magnetic force: "The appearance is very characteristic when in the unmagnetized condition, the negative glow penetrates beyond the first striation into the positive column. The end of the negative glow is then further from the cathode than the first striation or even, if the rarefaction is suitable, than the second or third. Nevertheless the end of the negative glow rolls itself under the magnetic action up to the cathode in the negative curve which passes through the cathode. Then separated from this by a dark space follows on the side of the anode a curve in which all the rays of the first striation are rolled up, then a similar curve for the second striation, and so on." We shall have occasion to refer to this point again when we consider the theory of the discharge.

289. Paalzow and Neesen*, who investigated the effect of a magnetic field in helping or retarding the discharge, found that when the lines of force are parallel to the line of discharge, the nature of the effect depends upon pressure; if p_0 is the pressure at which the discharge first begins, p_m the pressure when the current through the tube is a maximum, and p_n the lowest pressure at which the discharge passes, then for pressures between p_0 and p_m the magnetic force retards the discharge, while if the pressure is between p_m and p_n it helps it; thus the magnetic field produces in this case the same effect as an increase in pressure. The same results are true if the anode alone is exposed to the magnetic force; if only the cathode is exposed to this force the preceding results hold if the field is weak; if the field is very strong, however, the effects produced are just the opposite, the magnetic field producing the same effect as a diminution in pressure.

When the lines of magnetic force are at right angles to the discharge the magnetic field at all pressures retards the discharge. They found that the effect of the magnetic field was not instantaneous, often taking several seconds before producing its normal

* Paalzow and Neesen, *Wied. Ann.* lxiii. p. 209, 1897.

effect. This lag is a very frequent phenomenon in the discharge tube; it generally can be explained by the effects produced by previous sparks; thus as it is easier for one discharge to follow another than to be the first to pass through the tube, the magnetic field might not be able at once to stop the discharge if a strong discharge had just previously passed through the tube, though it might be able to prevent a discharge starting in the tube.

The author showed many years ago that the passage of the electrodeless discharge was hampered by a transverse magnetic field and facilitated by a longitudinal one.

290. Willows*, who also investigated the effect of a transverse magnetic field on the potential difference between the terminals of a discharge tube containing gas at a low pressure, found that when the magnetic force is confined to the neighbourhood of the cathode the potential difference is diminished by the magnetic field when the pressure is low and increased when it is high. The effect is represented in the curves in Fig. 176, the scale of

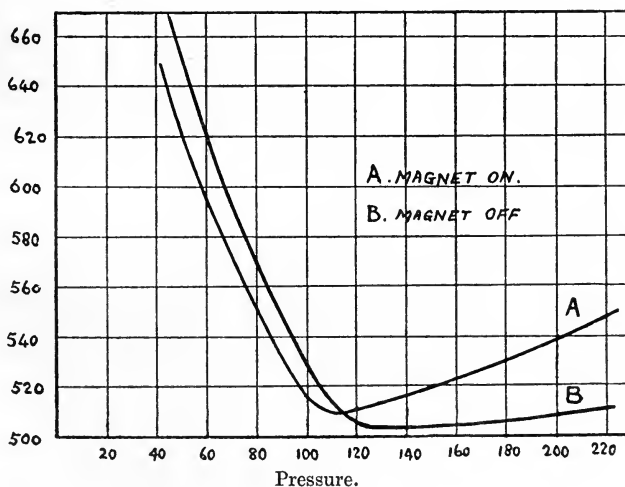

Fig. 176.

pressures is such that a pressure of 1 mm. of mercury is represented by 223. The pressure at which the curve for the magnet on intersects that for the magnet off, increases as the magnetic

* Willows, *Phil. Mag.* vi. 1, p. 250, 1901.

force increases and decreases when the current through the tube decreases. When the magnetic force is concentrated at any part of the tube except the cathode it always increases the potential difference.

Willows also investigated the effect of a uniform transverse magnetic field on the distribution of electric force between the terminals; the results of his experiments are represented by the curves in Fig. 177; the magnetic field diminishes to a considerable extent the great drop in the electric force which occurs in the negative glow.

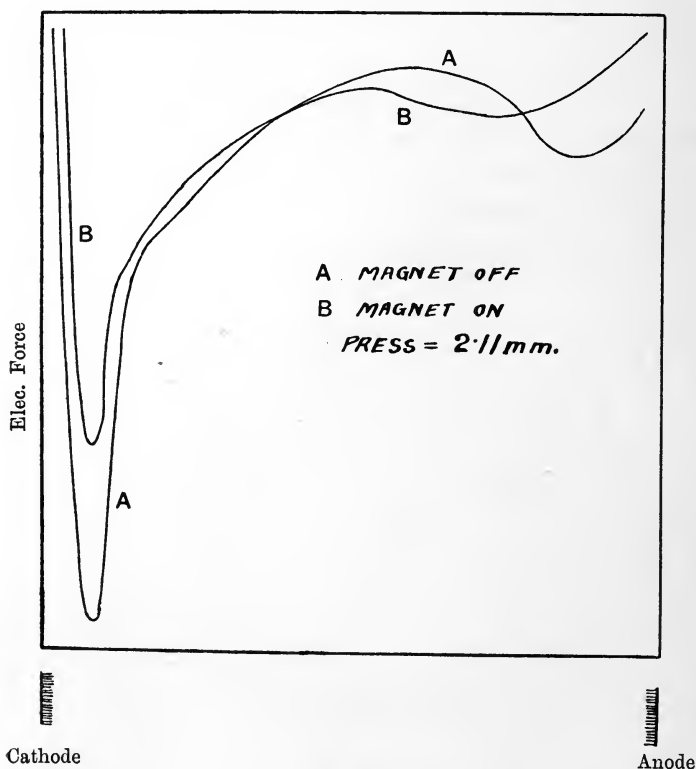

Fig. 177.

291. Birkeland* has shown that in a tube containing gas at a very low pressure a strong magnetic force parallel to the line of dis-

* Birkeland, *Comptes Rendus*, cxxvi. p. 586, 1898.

charge produces an enormous diminution in the potential difference required to spark through the tube; the potential difference when the magnetic force at the cathode reaches a critical value falling to less than one-tenth of its previous value. Almy* has shown that this effect can be produced by a transverse magnetic force as well as by a longitudinal one, and that the sudden diminution in potential is accompanied by a change in the appearance of the discharge, the magnet causing the discharge to change from a form in which it passes from the whole of the cathode to one where it is concentrated in one or more bright streams. This change in the appearance of the discharge, and also the diminution in the potential difference between the terminals, can be produced without the aid of the magnet by covering the outside of the tube in the neighbourhood of the cathode with tinfoil connected with the cathode. Almy showed that the effect of the magnet did not arise from the charges of statical electricity which accumulate on the glass of the tube, by showing that it took place when the cathode was placed inside a metal cylinder which was used as the anode.

292. We have already (see p. 443) described the appearance presented by the discharge when the terminals are placed very near together, an interesting modification of such an experiment is shown in Fig. 178, which represents an experiment made by

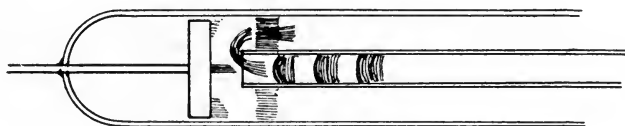

Fig. 178.

E. Wiedemann† in which the anode was enclosed in a narrow glass tube which dipped into the cathode dark space; it will be noticed that the positive light turns round after leaving the tube and joins the negative glow.

* Almy, *Proc. Camb. Phil. Soc.* xi. p. 183, 1901.

† E. Wiedemann, *Wied. Ann.* lxiii. p. 242, 1897.

*Discharge produced by very rapidly alternating
electromotive forces.*

293. E. Wiedemann and Ebert* and Himstedt† have made some very interesting experiments when the discharge was sent through the tube by the very rapidly alternating forces produced by discharging a condenser; in Wiedemann and Ebert's experiments the terminals were connected with the terminals in a Lecher's bridge arrangement producing electrical oscillations whose time of swing was only about 10^{-8} seconds. In Himstedt's experiments the alternating forces were produced by a Tesla transformer. The appearance presented by the tube is shown in Fig. 179; it will be seen that both electrodes show only the phenomena associated with a cathode, *i.e.* we have the dark space, the negative glow, and the

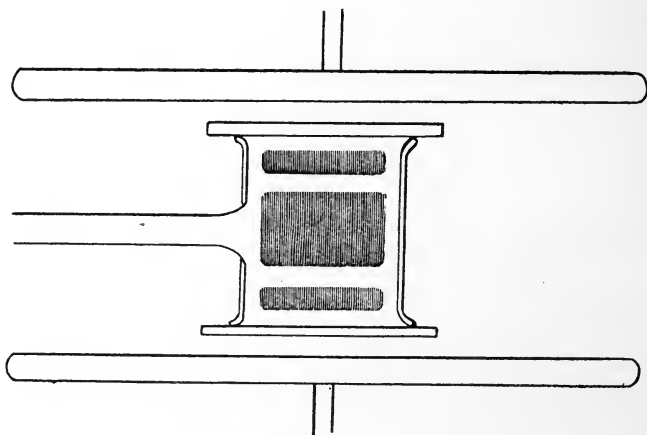

Fig. 179.

Faraday dark space, but no positive light; the latter is represented by the luminosity in the middle of the tube; this disappears at very low pressures. The thickness of the dark space next the electrode diminishes as the rapidity of the oscillations increases.

294. The description given above of the steady discharge through gases at low pressures, shows that it possesses a very

* E. Wiedemann and Ebert, *Wied. Ann.* i. pp. 1, 221, 1893.

† Himstedt, *Wied. Ann.* lii. p. 473, 1894.

complicated structure, thus we have the cathode dark space, the negative glow, the Faraday dark space and the positive column; accompanied by large differences in the electric force in these various regions. The variations in X , the electric force along the line of discharge, involves a distribution of free electricity with a density proportional to dX/dx : for this free electricity to accumulate ions must move from one part of the tube to another, and this process will require a finite time. If electricity is supplied to the electrodes of the discharge tube with great rapidity, if for instance a large battery of Leyden jars is discharged through the tube, the difference of potential between the electrodes may rise to a very high value before the ions have time to arrange themselves in the distribution corresponding to the steady current; in such a case as this the whole of the tube may be subjected to a very intense and approximately uniform electric field, intense enough to make the positive ions produce other ions by collision; when this is the case the current rapidly increases to very large values and we get the discharge passing as a uniform luminous column stretching from one electrode to the other and without any of the structure possessed by the steady discharge.

Relation between Current and Potential Difference.
'Characteristic' curve.

295. The relation between the current through the tube and the potential difference between the electrodes is often very complicated, depending on the pressure of the gas and the size and shape of the discharge tube. We can see that this must be the case, for when the current is increased the cathode fall of potential may be increased while the potential gradient along the positive column is diminished; whether the total potential difference between the electrodes is increased or diminished will depend upon the relative magnitude of these effects. For some values of the current an increase in the current through the tube involves an increase in the potential difference, while at other stages, as for example when the current is very large and passes as an arc, the potential difference diminishes as the current increases. The curve of which the ordinate is the potential difference between the electrodes, and the abscissa the corresponding current, is often called the characteristic curve for the discharge, and when it is

known, the current sent through the tube by any external electromotive force can readily be calculated.

Thus let E_0 be the electromotive force of the battery used to send the current through the tube, R the resistance of the leads, i the current through the tube, then the difference of potential between the terminals of the tube is $E_0 - Ri$, and if $E = f(i)$ is the equation to the characteristic curve we have

$$E_0 - Ri = f(i)$$

as the equation to determine i and therefore also E the potential difference between the electrodes. As we do not know an algebraic expression for $f(i)$ which would include all ranges of current, a graphical method of solution has to be employed.

Let ABC be the characteristic curve, draw the straight line LM whose equation is

$$E = E_0 - Ri,$$

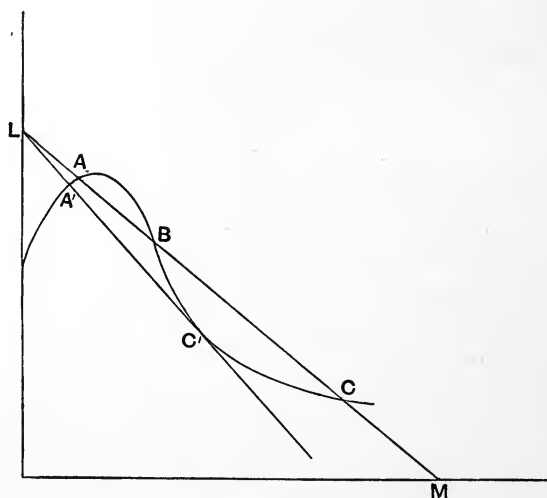

Fig. 180.

the points if any where this straight line cuts the curve will give the possible values of i and E , the current through the discharge tube and the difference of potential between its terminals. Some of these values may correspond to an unstable condition and be impossible to realise. To find which points correspond to a stable and which to an unstable condition we may proceed as follows: if

the current is increased by δi the increase in the electromotive force which has to be overcome by the battery is $R\delta i + \frac{dE}{di} \delta i$ or $(R + \frac{dE}{di}) \delta i$, if $R + \frac{dE}{di}$ is positive there will be an unbalanced electromotive force round the circuit tending to diminish the current and the increase in the current will be stopped, so that the conditions will be stable; if however $R + \frac{dE}{di}$ is negative there will be an unbalanced electromotive force tending still further to increase the current so that the current will increase still further and the conditions will be unstable. Thus for stability $R + \frac{dE}{di}$ must be positive, this condition was first given by Kaufmann*. We see from this that when the discharge is stable, the straight line $E = E_0 - Ri$ must, at the point where it cuts the characteristic curve, be steeper than the tangent to the characteristic curve. Thus of the points A, B, C where the line cuts the curve in Fig. (180), A and C are stable and B unstable. The state of things represented by a point P on a position of the characteristic curve where the slope is downward cannot exist unless there is in the external circuit a resistance greater than that represented by the tangent of the inclination of the tangent to the curve at P to the horizontal axis.

If the external electromotive force is given and the resistance in the leads gradually increased, the straight line LM will become steeper and steeper, C will move to the left so that the current will diminish; when the line is so steep that it touches the characteristic curve at C' , the limiting condition will be reached, any further increase in the current will make the condition represented by A' the only possible one for equilibrium, thus on passing through the position when the line is a tangent to the curve there will be an abrupt change in the current and in the nature of the discharge. Thus if the BC part of the curve corresponded to the luminous discharge, the A part to the dark discharge, we see that for a given value of the external electromotive force there is a minimum value of the current for the luminous discharge; if the current is reduced below this value the discharge ceases to be luminous.

* Kaufmann, *Ann. der Phys.* ii. p. 158, 1900.

If the characteristic curve is like Fig. 181, which if the parts were curved instead of straight would not be very unlike that for the discharge from an incandescent lime cathode; AB representing

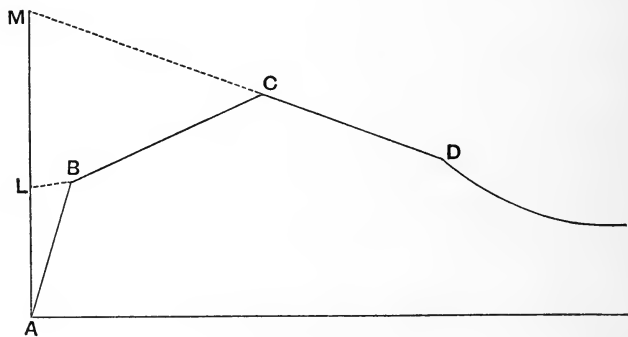

Fig. 181.

the dark discharge, BC the discharge with an anode glow but no cathode glow, CD the discharge with the cathode glow, and DE the arc discharge; we see that the stage AB can be got for all values of E_0 by taking suitable values of R and for all values of R by taking suitable values of E_0 ; the stage BC can be got for all values of $E_0 > AL$, by taking suitable values of R , and for all values of R by taking suitable values of E_0 ; the stage CD can only be got when the external resistance is greater than the tangent of the angle between CD and the horizontal and when the external electromotive force is greater than AM .

Some interesting examples of characteristic curves for the discharge through gases at low pressures are given by Riecke in the *Annalen der Physik*, b. 4. p. 592. 1901.

CHAPTER XVII.

THEORY OF THE DISCHARGE THROUGH VACUUM TUBES.

296. WE shall now proceed to apply the theory of the spark discharge given on p. 487 *et seq.* to explain some of the phenomena observed when the discharge passes through a vacuum tube containing gas at a low pressure. We have regarded the spark discharge as originating in the ionisation of the gas by moving ions, the small negative ions—the corpuscles—being more efficient ionisers than the positive ones, which have a greater mass. If, however, the ionisation in an electric field not exposed to external ionising agents, such as Röntgen rays, were solely due to the collisions of corpuscles with the molecules of the gas we could not have a continuous current through the gas. For suppose, to begin with, there were a few corpuscles between the electrodes, then if the negative electrode is on the right the electric field will set the corpuscles moving to the left, and if it were strong enough ionisation would occur between the positive electrode and the place from which the original corpuscles started. The new corpuscles produced by the collisions of the original ones with the molecules of the gas would themselves produce new ions, but all these would be formed to the left of the birthplace of the ions which produced them; there would thus be a gradual exodus of corpuscles towards the positive electrode while the gas round the negative electrode would in time be deprived of corpuscles and would cease to conduct, and by hypothesis it could no longer be ionised as all the negative ions would have been driven to the positive electrode.

We have seen that in every gas 'spontaneous' ionisation is continually taking place, and it might be urged that this process would furnish a supply of negative ions which would rapidly

multiply by collisions with the molecules of the gas, and so furnish a supply of carriers sufficient for the current through the tube. If this were the case however the potential difference between the electrodes would vary rapidly with the current, in reality however the variation is very slight.

Again, the current under a given difference of potential would depend upon the amount of the spontaneous ionisation, *i.e.* the ionisation independent of the electric field; we can however increase the latter a hundredfold by exposing the gas in the discharge tube to the action of Röntgen rays without producing any appreciable increase in the current passing through the gas. To account for the phenomena of the discharge we must have ionisation produced by the electric field itself close to the cathode; we shall suppose that this ionisation is produced by the positive ions, and although these require a much greater amount of energy before they can act as ionisers than do the corpuscles, yet the very intense electric field which exists close to the cathode is sufficient to give them, when under its influence they have come up to the cathode, all the energy they require.

There are several ways in which these rapidly moving positive ions might produce fresh negative ions; the two that most naturally suggest themselves are, (1) that the positive ions by collision ionise the molecules of the gas near the cathode, (2) that the positive ions by striking against the surface of the cathode communicate so much energy to the corpuscles contained in the layer of metal close to the surface of the cathode that they are able to escape from the metal, just as they are able to escape from a metal when it is raised to incandescence.

The consequences will be very much the same whichever of these views we take; for the strength of the electric field increases so quickly near the surface of the cathode that the kinetic energy possessed by the positive ions, when they arrive quite close to the surface, will be enormously greater than when they are just a little further off, so that any ionisation produced by the collision of these positive ions with the molecules of the gas will be practically confined to the layer of gas close to the surface of the cathode. It is possible that the luminous glow which spreads over the cathode marks the seat of this ionisation. Thus whether

we suppose the positive ions to act according to the method (1) or (2) we have negative ions starting from close to the surface of the cathode; these are driven from it by the electric field and soon acquire such velocities that they ionise the gas through which they pass, producing a supply of positive ions which are attracted by the electric field up to the cathode, there to produce a fresh supply of negative ions.

Thus the positive and negative ions in the space close to the cathode are on this view mutually dependent; if the supply of either is stopped, that of the other at once fails. This is very well illustrated by the experiment represented in Fig. 136, p. 489, in which an obstacle placed in the dark space throws a shadow as it were backwards and forwards; the obstacle stops the supply of positive ions to a portion of the cathode (the portion in shadow); this portion is no longer able to send out negative ions, in fact it ceases to act as an electrode.

The discharge can take place when the positive ions act as ionisers in the region close to the cathode, even though these ions do not produce new ions in other parts of the field. Thus it is only close to the cathode that the electric field need be very intense, in the remainder of the tube it need not rise above the value required to make the corpuscles produce ions. This concentration of the electric field at the cathode involves also great concentration of ions and this accumulation of ions will require time. If the gas originally contains only a few ions and the electric field is only applied for a very short time, there will be no time for this concentration of ions to take place and the field will be approximately uniform from one electrode to the other; if the discharge were to take place under these circumstances the electric force would have to be great enough all along the line of discharge to make the positive ions produce fresh ions; in this case the discharge would not show the differentiations characteristic of the steady state. When once the discharge has passed it may leave behind it so many ions that a discharge following shortly after may pass with a very much smaller potential difference; as the positive ions left behind by moving up to the cathode, may make the field at the cathode much more intense than the average field throughout the tube.

The conditions for luminosity in the discharge.

297. As luminosity is one of the most characteristic features of the discharge the conditions under which it occurs are of great interest. We have given on p. 481 reasons for believing that the production of the luminosity does not depend entirely upon the kinetic energy of the corpuscles moving through the gas; this kinetic energy is independent of the current provided the electric force remains the same; the current however as well as the electric force affects the luminosity, and if we double the current density of the stream of corpuscles passing through the gas we may do far more than double the luminosity. The abruptness with which the luminosity appears, suggests that the luminous stage is reached when the internal energy of an atom reaches a certain critical value; it may reach this value as the result of one collision with a corpuscle, but if the atom possesses any power of storing up energy it may also reach this value by combining the energy it has stored up from previous collisions of corpuscles, either with itself or with neighbouring atoms, with the energy it receives just before luminosity.

Spectroscopy furnishes many instances in which an increase in the density of the current of corpuscles changes not merely the intensity but also the character of the radiation; the most conspicuous instances of this are argon and the heavier inert gases. If the current density through a discharge tube containing argon is gradually diminished the colour of the discharge changes from a bright blue to a bright red, and the spectra are entirely different; the changes in the electric force in the tube are not considerable. I have found that for a current density intermediate between the limits required to fully develop the blue or red discharge there is a very marked diminution in the luminosity of the tube; with such a density it required a much longer exposure to photograph the spectrum than it did with current densities either considerably greater or considerably less.

Changes in the spectra produced by changing the current density occur in the cases of many other gases and vapours.

298. The electric force required to produce luminosity is often greatly diminished by an increase in the current density; an

increase in current density is accompanied by an increase in the work done by the electric forces per unit volume of the gas in the discharge tube, and therefore in the temperature of the gas; it might therefore be thought that it was the temperature of the gas which increases the luminosity. This view would I think be misleading: the increase in the mean temperature of the gas in the discharge tube is often quite small, less than two or three hundred degrees centigrade, and we might heat up the tube by a Bunsen burner to a higher temperature than this without affecting the luminosity; when the gas is heated in this way the energy is given to the gas in the form of increased energy of translation of its molecules, and although in accordance with Boltzmann's law a certain proportion of this is transformed into the internal energy of the atoms the amount of internal energy acquired in this way would be very small compared with that required to make the gas luminous. The conditions are quite different when the gas is heated by the electric discharge; in this case through the collisions of corpuscles with the atoms of the gas the greater part of the energy communicated to the gas is initially internal energy of the atom, and although this ultimately gets transformed to temperature energy the average internal energy in the atom for the same final temperature is far greater than if the energy were first communicated to the gas in the form of temperature energy and then transformed into internal energy. Thus if the luminosity depends upon the internal energy the same rise of temperature will produce a much greater effect when the heating is produced by the electrical discharge than when it is produced directly by thermal means.

The large and sudden increase which often occurs when luminosity sets in indicates that the gas on becoming luminous emits ions freely. It may be that in the luminous gas a far larger number of molecules are luminous and emit ions than are struck by corpuscles. The molecule may acquire internal energy by absorbing the radiation emitted when corpuscles collide with neighbouring molecules, this energy may accumulate until it reaches the critical value necessary for luminosity and ionisation. The ionisation of such molecules is only indirectly produced by collision.

Origin of the dark space.

299. Let us now consider in more detail the ionisation produced by the negative ions coming from the cathode. The primary ones which start from or near the surface will in consequence of the very intense electric field which exists close to the cathode be shot out with very great velocity, they will therefore be cathode rays of a very penetrating kind; such rays in a given length of path do not produce so much ionisation as those moving with a smaller velocity. Let us now consider the case of a corpuscle produced by the collision of one of the primary ones with a molecule some little distance in front of the cathode; this 'secondary' corpuscle will start from a field much less intense than that from which the primary corpuscle started, it will therefore not acquire nearly so great a velocity; it will correspond to a much more easily absorbed kind of cathode ray, and will therefore in a given length of path produce many more ions. Again, the corpuscles produced by the 'secondary' corpuscles or by the primary ones at a greater distance from the cathode will in consequence of their smaller velocity be still more easily absorbed, and therefore produce still more ions per unit of path. Thus the amount of ionisation will be small in the strong parts of the field near the cathode, but will increase with great rapidity when we get to the weaker parts. Thus if ionisation were accompanied by luminosity the places close to the cathode where the electric field is strong would be dark, while the luminosity would increase with very great rapidity in the places more remote from the cathode where the electric field is weaker; the increase would be so rapid that the contrast and line of demarcation between the light and dark places would be sharply marked.

The sharp contrast between the very feeble luminosity in the dark space and the brightness of the negative glow, is an illustration of the abruptness with which the luminous discharge starts into existence and to which we have already alluded on p. 480. A slight increase in the strength of the electric field or of the current may make all the difference between a brightly luminous discharge and one which is hardly visible.

The transition from a non-luminous to a luminous discharge depends on the current density of the stream of corpuscles as well

as upon the strength of the electric field, thus the boundary of the negative glow on the cathode side will be a surface where the current density is constant as well as the potential. Thus while there is any space on the cathode not covered by the negative glow, the current density will remain constant all over the negative glow and any increase in the total current through the tube will be accompanied by a corresponding increase in the area of the cathode covered by the negative glow. When the cathode is entirely covered by the glow an increase in the current must be accompanied by an increase in the current density, and this increase is accompanied by a considerable increase in the cathode fall of potential. One cause of this increase is the increase in the density of the free electricity in the region round the cathode; this increase will make the changes in electric potential as we move up to the cathode more rapid.

The density of the current at the cathode when the negative glow does cover the electrode is constant, and as Stark* has shown depends upon the pressure, it increases with the pressure for all gases, and for air, as Stark and H. A. Wilson† have shown, it is directly proportional to the pressure. The following considerations will show that we should expect the limiting current density to increase with the pressure. Let the discharge take place between two parallel plates at right angles to x , let V be the value of the potential at a distance x from the cathode, ρ the density of the free electricity, then

$$\frac{d^2 V}{dx^2} = -4\pi\rho.$$

Now the structure of the region round the cathode is approximately on a scale proportional to λ , the mean free path in the gas, so that $V = f\left(\frac{x}{\lambda}\right)$ where f does not depend upon the pressure, since $1/\lambda$ is proportional to p we may write $V = F(xp) = F(\xi)$, hence

$$\frac{d^2 V}{dx^2} = p^2 \frac{d^2 F}{d\xi^2} = -4\pi\rho,$$

thus for the same value of ξ , *i.e.* at corresponding points, ρ will be proportional to the square of the pressure; thus the density of the ions in the neighbourhood of the cathode rapidly increases with the

* Stark, *Physikalische Zeitsch.* iii. p. 274, 1902.

† H. A. Wilson, *Phil. Mag.* [vi], iv. p. 602, 1902.

pressure, the current however will be proportional to the product of the density of the ions and their velocity: we have seen that an increase of pressure produces a great increase in the density; if the strength of the electric field remained the same an increase in the pressure would diminish the velocity; the greatest effect the pressure could produce would be to make the velocity vary inversely as the pressure; this would only occur if the field were as strong at low pressures as at high, which is not the case, and even if it were the diminution in the velocity produced by the increased pressure would not be sufficient to counteract the increase in the density of the ions, so that the current would increase with the density.

300. The scarcity of the negative ions in the strong field close to the cathode and their rapid increase in the weaker parts of the field towards the negative glow are strikingly shown in some experiments made by the writer*. In these a discharge tube was used similar to that shown in Fig. 182, *C* is a floating cathode

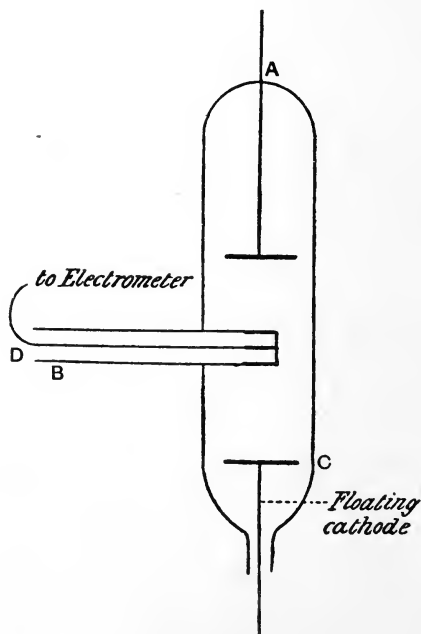

Fig. 182.

* J. J. Thomson, *Phil. Mag.* vi. 1, p. 361, 1901.

which can be raised or lowered in the tube, *A* is the anode, and *B* a closed metal vessel provided with a window covered with very thin aluminium foil. The impact of negative ions on this window was found to generate rays which penetrated the tinfoil and ionised the gas in the closed vessel. This gas therefore conducted electricity, and if the electrode *D* was charged and connected with an electrometer, the charge leaked from it, the rate of leaking indicating the amount of ionisation in the gas, care being taken to charge up the electrode to a sufficiently high potential to produce the saturation current through the gas. The rays are very easily absorbed, this is clearly shown by diminishing the pressure of the gas in the closed vessel *B* and observing the rate of leak at different pressures. As long as the rays are entirely absorbed in passing through the gas in the vessel, the number of ions in the vessel, and therefore the saturation current, will be independent of the pressure of the gas; as soon however as the pressure gets so low that the rays pass through the gas without much absorption, the saturation current becomes proportional to the pressure. The following table, which gives the variation of the saturation current with the pressure, shows that it is not until the pressure gets low that the saturation current is affected by the pressure, hence we conclude that the radiation produced by the impact of the negative ions against the window can only penetrate through a few millimetres of air at atmospheric pressure:

Pressure in vessel <i>D</i> (thickness of vessel 1 cm.)	Saturation current
770 mm.	87
270 "	90
100 "	64
45 "	37
10 "	11
5 "	3

The intensity of the rays produced by these negative ions depends very much upon the distance of the window from the cathode. This is clearly shown by the following table, the results of which are represented by the curve in Fig. 183, in which the

ordinates represent the amount of ionisation in the vessel and the abscissæ the distance from the cathode.

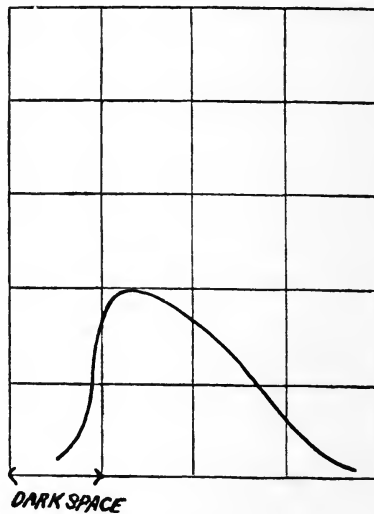

Fig. 183.

Pressure in discharge tube '6 mm. Width of dark space 6 mm.

Distance of window from surface of cathode	Ionisation in vessel <i>D</i> (arbitrary units)
3	21
4	54
5	105
6	195
8	150 ?
10	180
20	66
30	40
40	25

It will be seen that the effect of the rays produced by the impact is small close to the cathode, increases very rapidly as we approach the negative glow, attains a maximum in the glow, and then quickly drops down to a very small value; in fact the effect produced by the collision of the negative ions against the window varies in the same way as the amount of ionisation produced

according to the theory given on p. 590, by the collision of the corpuscles with the molecules of the gas.

The fact that the ionisation inside the vessel *D* increases and decreases with the luminosity in the discharge might lead to the suspicion that the ionisation inside *D* was not due to rays generated by the impact of negative ions against the window, but to the light coming from the gas; that it is in reality due to the former and not to the latter cause is shown by the following experiment. The tube was placed in a field of magnetic force, the lines of magnetic force being parallel to the window in the box *D*; the magnetic field concentrates the negative glow and increases its luminosity, so that if the ionisation in the box were due to the luminosity and not to the impact it should be increased by the magnetic field; on the other hand, since the negative ions move parallel to the lines of magnetic force, and therefore parallel to the window, the impact of the ions against the window is stopped, so that if this is the cause of the ionisation inside the box it should be very much diminished by the field; on trying the experiment it was found that the magnetic field almost entirely stopped the ionisation.

301. On the theory we are discussing the negative glow is due to the ionisation brought about by collisions between molecules of the gas and corpuscles which have started some distance from the cathode, such corpuscles being the descendants, so to speak, of the corpuscles which started from close to the cathode and which move with very much greater velocity than the glow-producing corpuscles which have started in a much weaker electric field. The thickness of the dark space will evidently be greater than the mean free path of a corpuscle, for this would be the approximate magnitude of the dark space if the negative glow were produced by collisions with the corpuscles from the cathode; the greater the mean free path the further will the negative glow be from the cathode, and we should expect from the preceding theory a linear relation between the thickness of the dark space and the mean free path.

The corpuscles which start from close to the cathode being but little absorbed may sometimes pass right through the negative glow, as in the case of the discharge studied by E. Wiedemann

and represented in Fig. 144, p. 528. These corpuscles are the cathode rays which we shall discuss in chapter XIX.

302. When ionisation takes place in the region round the cathode the positive ions move towards the cathode, while the negative ones move away from it; this produces an excess of positive electricity in the gas near the cathode. In consequence of this positive charge the electric force diminishes as we recede from the cathode. When the electric field sinks below a certain value it can no longer communicate to the corpuscles sufficient energy to make them act as ionisers, so that after the field has sunk to this value the ionisation will cease; it would be more accurate to say that the ionisation will cease soon after the field has reached this value, for the corpuscles may retain for some little distance the energy they acquired in stronger parts of the field and so continue to act as ionisers for a short distance in the weak field. The limit of the negative glow, furthest from the cathode, marks on our view the place where the current of corpuscles and their velocity sink below the values required to produce luminosity.

303. Let us now consider what would happen in the gas between the anode and the negative glow g . Let us suppose for a moment that there is no ionisation taking place between g and the anode. Then as the current will be carried by ions dragged by the electric field from the region of ionisation between g and the cathode, all the ions between g and the anode will be negative ions, so that there will be a negative charge in the gas to the left of g ; but a negative charge involves an increase in the electric force as we go from g towards the anode, and if the anode is far enough away the electric field may increase to such an extent that it is again able to give to the negative corpuscles sufficient kinetic energy to make them ionisers. When this happens the gas again becomes luminous, and we have in fact a repetition of the process occurring in the negative glow. The increased ionisation in the luminous part of the discharge will diminish the strength of the electric field until this gets so weak that no further ionisation takes place, the luminosity again ceases and the current will again, as in the Faraday dark space, be carried by ions produced elsewhere; there will also, as in that space, be an excess of negative ions, this will cause the electric force again to increase,

ionisation accompanied by luminosity will recur, and the process will be repeated right up to the anode; we thus get bright and dark patches as in the striated positive column. On this view the luminous portions of the striations correspond to the negative glow, the intervening dark spaces to the Faraday dark space, the process taking place along the positive column being a repetition of that taking place near the cathode. The similarity between the striated positive column and the phenomena at the cathode has been insisted on by several observers, notably by Spottiswoode and Moulton*, Goldstein†, and Lehmann‡. Goldstein's statement is very clear and explicit, he says, "Jede einzelne Schicht des positiven Lichtes ist ein dem früher sogenannten negativen oder Kathodenlichte entsprechendes Gebilde, und das geschichtete positive Licht besteht eigentlich aus einer Aufeinanderfolge von Komplexen negativen Lichtes§." Several observers have regarded the behaviour of the positive column as necessarily implying a discontinuity in the discharge. Thus Spottiswoode and Moulton from the behaviour of the striated column liken the transmission of electricity along the positive column "to an action consisting of an independent discharge from one stria to the next, and the idea of this action can perhaps be best illustrated by that of a line of boys crossing a brook on stepping stones, each boy stepping on to the stone the boy in front of him has left." On the view we have indicated above a striated discharge need not necessarily be discontinuous.

304. We saw in Art. 43 that when the velocity of the ions is proportional to the electric force the curve representing the relation between the electric force at a point and the distance of that point from one of the electrodes is convex to the axis when the ionisation in the gas is greater than the recombination of the ions, and concave when it is less. The curve representing the distribution of electric force along the striated positive column is however (see Fig. 149) concave at the bright parts of the stria where we have supposed the ionisation to be greatest, and convex at the dark parts where the ionisation is least. In a case, however,

* Spottiswoode and Moulton, *Phil. Trans.* Part I. p. 205, 1879.

† Goldstein, *Wied. Ann.* xi. p. 831, 1880; xii. pp. 90, 249, 1881.

‡ Lehmann, *Die Elektrischen Entladungen.*

§ Goldstein, *Berlin. Monatsber.* May 4, 1876.

like that of a striated discharge where the pressure of the gas is low, and the free path of a corpuscle therefore considerable, the velocity of a corpuscle at a point will depend not only upon the magnitude of the electric force at that point, but also upon the forces which acted upon it before it reached the point: thus the conditions upon which the investigation in Art. 43 is based need not apply in this case.

Case when the discharge is not striated and the positive column is of uniform intensity.

305. The corpuscles are continually recombining, so that unless there is fresh ionisation their number must continually diminish: if the rate of ionisation is equal to that of recombination the number of corpuscles will remain constant. Thus if, when the ionisation begins at the anode end of the Faraday dark space, the strength of the field is such that the number of ions produced by it in unit time is just equal to the number which recombine in that time, the number of ions, the strength of the field, the amount of ionisation, and therefore the luminosity will be constant all along the line of discharge, and we shall have the case of the uniform positive column. The diminution in the electric force which occurs when the current is increased (see p. 558) follows from the principle (see p. 480) that ionisation takes place more easily when the current density is large than when it is small.

Anode fall of potential.

306. Let us consider a point P close to the anode A , then the current at P is carried by negative corpuscles produced further from the anode than P and by positive ions either coming out of the anode or produced from the gas between P and A . That a considerable supply of positive ions is produced within a short distance of the anode is proved by the fact that in the uniform positive column the electric force is constant within a short distance of the anode, and when this is the case there are as many positive as negative ions per unit volume of the gas. Thus if the ions are produced in the gas the ionisation in the gas near the anode must be so intense that in an exceedingly thin layer of gas

there are sufficient positive ions produced to neutralise the electrostatic effect of the negative ones moving up to the anode. Now under these conditions, if i is the current, k_1 , k_2 , the velocities of the positive and negative ions respectively, the number of positive ions which cross unit area of the uniform positive column in unit time is $k_1 i / (k_1 + k_2) e$, where e is the charge on an ion. Suppose w is the work required to ionise a molecule of the gas, then in the thin layer referred to an amount of work equal to $w k_1 i / (k_1 + k_2) e$ must be done by the electrical field in unit time; but if V is the difference of potential between the two sides of this layer (one of these sides is the anode), the electrical work done in unit time is $V k_2 i / (k_1 + k_2)$, since the quantity of negative electricity entering this layer in unit time is $k_2 i / (k_1 + k_2)$; hence supposing all the electrical work is spent in ionising the gas, we have

$$\frac{V k_2 i}{(k_1 + k_2)} = \frac{k_1 w i}{(k_1 + k_2) e},$$

or

$$V e = \frac{k_1}{k_2} w;$$

this is an inferior limit to V , since it is obtained on the assumption that all the work is spent in ionising the gas: we have thus a finite drop in the potential at the anode. If we proceed on the other supposition, that the positive ions come from the anode, just as we have seen positive ions do come out of metal, or out of the gases absorbed by metal when the temperature is above a dull red heat, the preceding investigation will still apply, if w stands for the energy required to eject an ion from the metal, so that in this case again there is a finite drop of potential at the anode. On this view if we produce independently of the electric field a discharge of positive ions from the anode we ought to diminish the anode fall of potential. I have found that this is the case. Aluminium phosphate when heated to redness gives out a large supply of positive ions. I found that when the anode in a discharge tube was a wire coated with aluminium phosphate and heated to a red heat, the anode fall was greatly reduced.

It ought to be noticed that unless positive ions come from the anode the ordinary method of measuring the anode fall by determining the potential of a wire in the gas near the anode is

not reliable, as in this case there will only be negative ions round the wire and its potential will not be that of the gas (see p. 531).

Action of magnetic force upon the discharge.

307. We have seen (see Art. 57) that when a charged particle moving through a gas is acted upon by both electric and magnetic forces, it will follow the lines of magnetic and not of electric force, provided RH is a large quantity; here H is the magnetic force, and R the velocity acquired by an ion under unit electric force. Another way of expressing the same result is to say that a charged particle, moving with the velocity v , will follow the lines of magnetic force if mv/eH , the radius of the circle into which the path of a free particle is bent when moving at right angles to the magnetic force, is small compared with the mean free path of the particle. The result when put in this form is obvious, since (see p. 106) the free paths of the particles are spirals round the lines of magnetic force, and as the radii of these spirals are small compared with the length of the mean free path the only direction in which the particles make any appreciable progress is that of the magnetic force. The negative particles will be much more likely than the positive to follow the lines of magnetic force; for in the first place, the mean free path of the negative particles is greater than that of the positive, and secondly, the value of m/e is much less for the negative than for the positive particles. Thus we may expect the negative particles to follow the lines of magnetic force, even when the motion of the positive ones is but little affected by the magnetic field. The tendency of the negative particles to follow the lines of magnetic force is strikingly shown by the behaviour of the negative glow in a strong magnetic field, when as Plücker has shown (see p. 572), the boundary of the glow coincides with a line of magnetic force.

308. Since the negative particles are much more affected than the positive by a magnetic field, if the proportion of the current carried by the negative ions varies at different points in its course the current will be much more deflected by the magnetic field in some places than in others. This is exactly what happens in the striated discharge; for suppose A and B are the bright parts of two consecutive stria, then since by hypothesis there is

ionisation in A , many more negative particles will leave A from the anode side than enter it from the cathode side; thus the proportion of the current carried by the negative ions will be much greater on the anode side of the bright patches than on the cathode side; the portion of the current on the anode side of a bright patch will therefore be much more affected by the magnetic field than that on the cathode side: the general effect of this will be much the same as if the current were discontinuous, and this, as we have seen (see p. 597), corresponds to the behaviour of the striated column in the magnetic field.

Effect of a constriction in the tube.

309. Goldstein (see p. 568) has shown that on the anode side of a constriction we get negative glow; this is what we should expect on the preceding theory, for the electric force in the constriction will be greater than in the wider parts of the tube: there are several lines of reasoning by which we may show that this must be the case; in the first place the current density in the constriction is greater than in the rest of the tube; thus if there are in the constricted part the same number of ions per cubic centimetre as elsewhere, the velocity of the ions must be greater; for this to be the case the electric force must be greater also; or again, if the density of the ions is greater in the constriction than in the wide parts of the tube, then since the ions are produced by the electric field the larger number of ions will involve a more intense electric field. Thus, as the force in the constriction is greater than in the rest of the tube the corpuscles which emerge from the constriction on the anode side will in the constriction have acquired a large amount of kinetic energy, and will therefore, like the corpuscles in the negative glow, produce great ionisation with its attendant luminosity.

Another reason for the electric force in a narrow tube exceeding that in a wide one is that in a narrow tube the loss of ions by diffusion to the walls of the tube is greater in the narrower tubes. When the discharge is in a steady state the rate of production of ions must equal the rate at which they disappear. In an open vessel the ions disappear by recombination with other ions or with molecules of the gas, but in tubes some of the ions diffuse to the

sides of the vessel and become neutralised; the narrower the tube the greater will be the loss from this cause. Thus since the rate of disappearance of the ions is greater in narrow tubes than in wide ones the rate of production and therefore the electric force must also be greater. When the effect of diffusion is neglected we saw (p. 497) that for a steady state

$$F(Xe\lambda, i) = \gamma.$$

When we take diffusion into account we can easily show that this equation is modified into the form

$$F(Xe\lambda, i) = \gamma + A \frac{\lambda^2}{d^2} \frac{1}{k_0 X},$$

when k_0 is the velocity of the negative ion under unit electric force, λ the mean free path of the negative ion, d the diameter of the tube and A a constant. If $F(Xe\lambda)$ is a linear function of $Xe\lambda$ this equation may be written

$$\frac{X}{p} = C + \frac{D}{d^2 p X},$$

when C and D are constants. In wide tubes for small currents X is approximately proportional to the pressure.

Entladungstrahlen.

310. E. Wiedemann* discovered that an electric spark emits something which is propagated in straight lines, is stopped by all solids and liquids, and which possesses the power of exciting thermoluminescence (see page 624) in suitable bodies; he called this radiation from the spark 'Entladungstrahlen.' Hoffmann†, who subsequently investigated this question, showed that 'Entladungstrahlen' are emitted by discharges through vacuum tubes as well as by sparks, and that this radiation is not deflected by a magnet; he found that the radiation is absorbed by carbonic acid gas to a much greater extent than by oxygen. The writer‡ showed that these 'Entladungstrahlen' possess the power of ionising the gas through which they pass, so that a part, though often only a small part, of the ionisation in the tube is due to these rays. The rays

* E. Wiedemann, *Zeitschr. f. Electrochemie*, p. 159, 1895.

† Hoffmann, *Wied. Ann.* lx. p. 269, 1897.

‡ J. J. Thomson, *Proc. Camb. Phil. Soc.* x. p. 74, 1899.

are given out by the luminous parts of the discharge, *i.e.* by the luminous positive column and especially by the luminous parts of the discharge near the cathode; they are not, however, given out by the Faraday dark space. As these rays help to ionise the gas the whole of the ionisation has not to be done by the collisions; so that the strength of the field required to produce discharge will be a little less than that calculated on the collision hypothesis; the difference will increase with the strength of the current, so that the Entladungstrahlen would tend to make the potential gradients in the tube diminish as the strength of the current through the tube increases.

311. We shall see that when the motion of a charged ion is accelerated the ion emits radiation analogous to Röntgen rays, the energy emitted per unit time being $2e^2f^2/3V$, where e is the charge on the ion, f its acceleration, and V the velocity of light. As the ions carrying the current in the discharge tube are continually being accelerated by the electric force, and frequently, in addition, have their velocities suddenly altered by the collisions they make with the molecules of the gas, during which time their accelerations are very great, they will emit radiation, which will be most intense where the electric force is greatest; this radiation is, I think, Wiedemann's Entladungstrahlen.

CHAPTER XVIII.

THE ELECTRIC ARC.

312. IN the electric spark and the discharge from a point the difference of potential between the electrodes is several hundred volts, while the current is only a fraction of a milliampère; in the case we now proceed to consider,—the electric arc,—where the electrodes are in a state of incandescence, the potential difference is very much smaller, while the current is enormously greater, often amounting to many ampères. We can produce the arc discharge if we take a battery of cells of small resistance, numerous enough to give a potential difference of 60 to 80 volts, and connect the electrodes with two carbon terminals which are at first pushed against each other, a current of electricity flows through the carbons and warms the junction; if while the current is still passing the carbons are drawn apart a bright discharge which may carry a current of many ampères passes from one carbon terminal to the other. This discharge, which is called the electric arc, is characterized by intense heat and light which make it of great practical importance. The main sources of the light are the extremities of the carbon rods which are in a state of vivid incandescence. The temperature of the extremity of the positive terminal is much higher than that of the negative; according to Violle* the temperature of the former is about 3500° C., that of the latter about 2700° C., while the temperature of the arc itself he found to be higher than that of either terminal. The terminals if similar to begin with soon present marked differences in their appearance, the extremity of the positive terminal gets hollowed out into a crater-like shape, while the negative terminal if pointed to begin with remains so. Both terminals in general lose weight, the positive, however, far more than the negative. The appearance of the terminals is shown in Fig. 184; these figures are due to

* Violle, *Comptes Rendus*, cxv. p. 1273, 1892.

Mrs Ayrton*. *a* and *b* represent the appearance when the arc is quiet, *d* when it is giving out a hissing sound; in some cases a mushroom-shaped body forms at the end of the negative terminal.

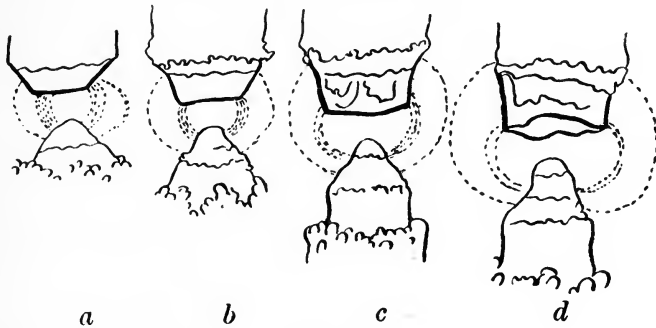

Fig. 184.

The temperature of the crater of the positive terminal remains practically constant even when the current varies, thus Waidner and Burgess† found that when the current was increased from 15 to 30 ampères the temperature of the anode only increased by 70°; an increase of current increases the area of the luminous crater, but the amount of light given out by each unit area remains unaltered; the temperature of the crater is probably the temperature at which carbon melts or volatilizes. E. W. Wilson‡ has shown that when the arc passes through gas at a very high pressure, say 20 atmospheres, the luminosity of the positive crater is sensibly less than at atmospheric pressure; in a later paper he gives reasons for thinking that this may be explained by the increased absorption of light by the gas surrounding the arc.

Connection between the difference of potential between the electrodes, the length of the arc, and the current.

313. If V is the potential difference between the terminals, l the length of the arc, Fröhlich† showed that the linear relation,

$$V = m + nl,$$

* Mrs Ayrton, *Proc. Inst. Electrical Engineers*, xxviii. p. 400, 1899.

† Waidner and Burgess, *Phys. Rev.* xix. p. 241, 1904.

‡ E. W. Wilson, *Proc. Roy. Soc.* lviii. p. 174, 1895; lx. p. 377, 1897.

§ Fröhlich, *Elektrotechnische Zeitschrift*, iv. p. 150, 1883.

where m and n are constants, *i.e.* independent of l , exists between V and l . Mrs Ayrton* has shown that both m and n are functions of the current i passing through the arc, and that

$$V = \alpha + \frac{\beta}{i} + \left(\gamma + \frac{\delta}{i} \right),$$

where $\alpha, \beta, \gamma, \delta$ are constants.

Ayrton† made a long series of experiments on the relation between the potential difference and the current through the arc; some of the curves representing the results of these experiments are given in Fig. 185, where the ordinates represent the potential

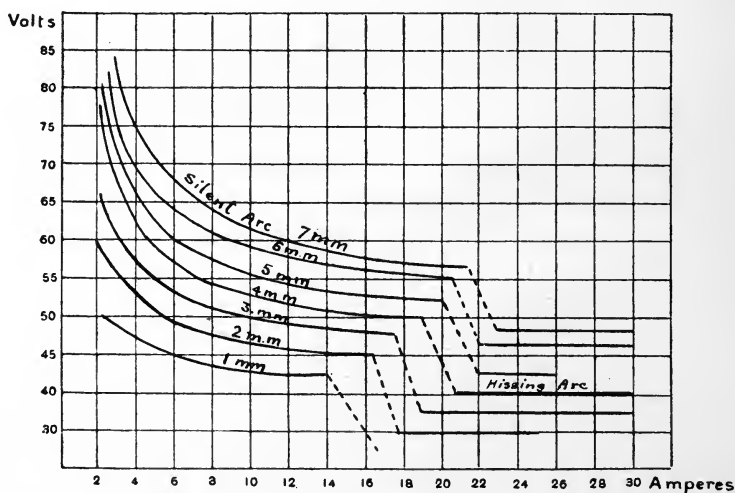

Fig. 185.

difference and the abscissae the current; it will be seen from these curves that for a quiet arc an increase in current is accompanied by a decrease in the potential difference, while in the hissing arc the potential difference is independent of the current.

The constants m and n in Fröhlich's formula have been measured by several experimenters, by Fröhlich himself, Edlund‡,

* Mrs Ayrton, *The Electric Arc*, chap. iv.

† W. E. Ayrton. Mrs Ayrton, *The Electric Arc*.

‡ Edlund, *Pogg. Ann.* 134, pp. 251, 337, 1868.

Peukert*, v. Lang†, Gross and Shephard‡, Nebel§, Arons||, Luggin¶; for carbon electrodes in air at atmospheric pressure m is about 39 volts, varying somewhat with the size and purity of the carbons; it is diminished by soaking these in salt solution; the value of n given by different experimenters varies considerably, this may be due to their having used currents of different intensities, as Mrs Ayrton has shown that it depends upon the current, diminishing as the current increases. When metallic instead of carbon terminals are used the value of m depends upon the metal being in general larger the higher the temperature at which the metal volatilizes; the values in volts found by v. Lang** for m for terminals of different substances are as follows: C = 35, Pt = 27·4, Fe = 25, Ni = 26·18, Cu = 23·86, Ag = 15·23, Zn = 19·86, Cd = 10·28. Lecher†† gives Pt = 28, Fe = 20, Ag = 8. Arons‡‡ found for Hg the value 12·8, in this case the fall of potential along the arc itself was abnormally small. In interpreting these results it is important to notice that with some terminals the arc is intermittent. Lecher has shown that this is the case with iron or platinum terminals, and Arons that it is so with mercury terminals; no intermittence has been detected with carbon, silver or copper terminals. The potential differences given above are mean values, and if the arc is intermittent they may differ greatly from the actual potentials during the passage of the arc.

If the two terminals are of different materials the potential difference may depend upon the direction of the currents; this is especially the case when one of the electrodes is carbon and the other metal; the arc passes much more easily when the carbon is the negative terminal and the metal the positive one than it does in the opposite direction. So marked is this effect that if such a pair of terminals is connected up with an alternating electromotive force the arc may pass only in the direction in which the carbon is the negative terminal, the potential difference being

* Peukert, *Zeitschrift für Elektrotechnik, Wien*, iii. p. 111, 1885.

† v. Lang, *Wied. Ann.* xxvi. p. 145, 1885; xxxi. p. 384, 1887.

‡ Gross and Shephard, *Proc. Amer. Acad. of Sciences*, 1886, p. 2.

§ Nebel, *Centralblatt für Elektrotechnik*, viii. pp. 517, 619, 1886.

|| Arons, *Wied. Ann.* lviii. p. 73, 1896.

¶ Luggin, *Wien. Ber.* xeviii. p. 1192, 1889.

** v. Lang, *Wied. Ann.* xxxi. p. 384, 1887.

†† Lecher, *Wied. Ann.* xxxiii. p. 609, 1888.

‡‡ Arons, *Wied. Ann.* lviii. p. 73, 1896.

insufficient to drive it the opposite way. For experiments on this point we may refer to papers by Blondel*, by Duddell and Marchant†, and by Eichberg and Kallir‡.

Non-arcing Metals.

314. With some metals as terminals the arc has a great tendency to go out and is only maintained with difficulty; brass, cadmium, and bismuth are examples of such metals; in some cases this is a very useful property, it has been investigated by Wurtz§: a great deal depends upon the size and shape of the electrodes, as well as the material of which they are made; conditions which promote a rapid flow of heat from the hot extremities of the terminals are favourable to the extinction of the arc.

Effect of pressure on the potential difference in the arc discharge.

315. The potential difference is not independent of the pressure of the gas through which the arc passes. Duncan, Rowland and Todd|| have made an extensive series of experiments on this

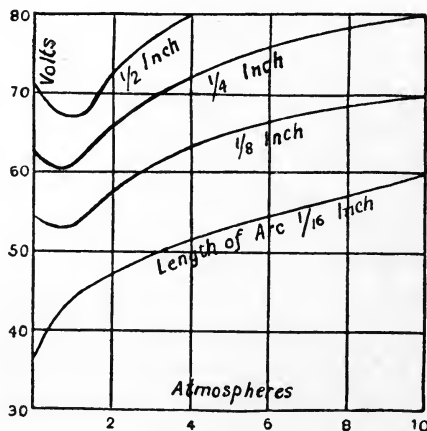

Fig. 186.

* Blondel, *Comptes Rendus*, 127, p. 1016, 1898; 128, p. 727, 1898.

† Duddell and Marchant, *Inst. Elect. Eng.* xxviii. p. 1, 1899.

‡ Eichberg and Kallir, *Wien. Sitz.* 107, p. 657, 1898.

§ Wurtz, *Lum. El.* xlv. p. 79, 1892.

|| Duncan, Rowland and Todd, *Electrician*, xxxi. p. 60.

point; the results of some of their experiments are represented graphically in Fig. 186: it will be seen from the curves that for short arcs the potential difference increases continuously with the pressure, while for longer arcs there is a critical pressure at which the potential difference is a minimum; this critical pressure seems to increase with the length of the arc.

Hoerburger* has also determined the effect of pressure on the potential difference; he finds the potential difference to diminish with the pressure of the surrounding gas until this falls to a certain value, in his experiments 1 mm. of Hg, when the potential difference becomes independent of the pressure.

Effect of the nature of the gas on the potential difference.

316. The nature of the gas affects the arc, thus it is difficult to get good arcs in pure hydrogen; this may be due in part at least to the more rapid convection of heat from the terminals in this gas. Arons† has measured the potential difference required to produce an arc 1.5 mm. long, carrying a current of 4.5 ampères between terminals of different metals in air and pure nitrogen; his results are given in the following table:

Terminal	Potential difference		Terminal	Potential difference	
	Air	Nitrogen		Air	Nitrogen
Ag	21	?	Pt	36	30
Zn	23	21	Al	39	27
Cd	25	21	Pb		18
Cu	27	30	Mg.....		22
Fe	29	20			

The case of silver is interesting as, though it gives good arcs in air, Arons could not obtain an arc in pure nitrogen; he ascribes this to the absence of any chemical combination between the silver and the nitrogen; he was able in the case of the other metals to get evidence of the formation of nitrides. With the

* Hoerburger, *Beiblätter* xxix. p. 883, 1905.

† Arons, *Ann. der Phys.* i. p. 700, 1900.

exception of copper the potential differences in nitrogen are smaller than in air, the difference being very noticeable in the cases of iron and aluminium.

Arons also made a series of experiments in hydrogen, but found the greatest difficulty in producing the arc in this gas, and could only obtain it by using large currents and having the gas at a low pressure; cadmium, zinc, and magnesium gave the best arcs in hydrogen.

We must in the case of the arc remember that since the metal or the carbon volatilizes the arc goes through a mixture of the vapour of the metal and the air, nitrogen or hydrogen in which the terminals are immersed, so that the conditions of the experiment are very complicated; the presence of this vapour makes ambiguous the interpretation of the effect of changes of pressure in the gas around the terminals, as we do not know the pressure of this vapour.

317. The distribution of potential between the terminals generally shows the following characteristics: there is a considerable fall of potential close to the anode, a smaller one close to the cathode, and a very gentle potential gradient in the space between the terminals; the general nature of this distribution is shown by the curve in Fig. 187: the curve shows many of the characteristics

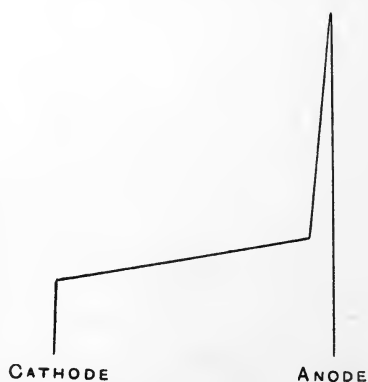

Fig. 187.

of the distribution of potential between two hot electrodes in flames; see p. 233.

Luggin* found that with carbon terminals and a current of 15 ampères there was a fall of potential of 33·7 volts close to the anode, and one of 8·7 close to the cathode. The difference between the potential falls at the anode and cathode is not so large with iron or copper electrodes as it is with carbon. With mercury terminals Arons found that the cathode fall was 5·4 volts, the anode fall 7·4 volts. When the current is increased so much that the discharge passes from the quiet to the hissing arc there is a sudden fall of potential. Luggin† and Mrs Ayrton‡ have shown that this diminution in the potential occurs almost entirely at the anode, the potential gradients in the other parts of the discharge being but little affected.

318. Some experiments which are very suggestive as to the parts played by the two terminals in the arc discharge have been made by Fleming§. In these experiments a third exploring carbon electrode was used which was either inserted in the arc, or what was often more convenient, placed outside the undisturbed path of the arc, and the arc directed on to it by means of a magnet. Fleming found that when the third terminal was connected with the negative terminal of the arc by a circuit which contained a battery of a few cells and a galvanometer to register the current, a current passed round the circuit under a very small electromotive force when the direction of the current was from the cold electrode placed in the arc through the arc to its negative terminal and then through the galvanometer, but that it would not pass in the other direction: another way of stating this result is to say that with one electrode hot and the other cold, a current can pass in the direction in which the negative electricity comes from the hot electrode into the gas, but not in the other direction. Thus although in ordinary arcs the positive terminal is the hotter, this experiment shows that a high temperature of the negative electrode is the essential condition for the arc discharge, and that if we can keep the temperature of the negative terminal up by independent means we can get a discharge, even although the

* Luggin, *Centralblatt für Elektrotechnik*, x. p. 567, 1888.

† Luggin, *Wien. Sitz.* xviii. p. 1192, 1889.

‡ Mrs Ayrton, *The Electric Arc*.

§ Fleming, *Proc. Roy. Soc.* xlvii. p. 123, 1890.

temperature of the positive electrode is comparatively low. No arc, however, will pass if the negative terminal is cold.

Fleming found that if he connected the exploring electrode up to the positive electrode, without introducing any battery into the circuit, enough current passed through the exploring electrode to ring an electric bell or light an incandescent lamp placed between the electrode and the positive terminal; but that no appreciable current passed if the electrode were connected with the negative instead of the positive terminal: this result indicates that the potential of the spare electrode is brought nearly to an equality with that of the cathode. From these experiments Fleming concluded that the arc discharge consists of a torrent of negatively electrified particles of carbon shot off from the cathode, these carry the current and striking with great violence against the anode hollow it out, just as a body is hollowed out when struck by a sand blast.

319. The phenomena connected with the discharge of electricity from incandescent bodies (see Chapter VIII.) seem to me to indicate a somewhat different explanation of the arc discharge. We saw that an incandescent body such as a piece of carbon, even when at a temperature far below that of the terminals in the arc discharge, emits negatively electrified corpuscles at a rate corresponding to a current of the order of an ampère per square centimetre of incandescent surface, and that the rate of emission increases very rapidly with the temperature; thus at the temperature of the negative carbon in the arc the rate of emission probably corresponds to a current of a large number of ampères per square centimetre of hot surface. If then a piece of carbon were maintained by independent means at this high temperature and if this were used as the negative electrode, a current could be sent through a gas to another electrode, whether this second electrode were cold or hot.

Let us first suppose that the anode is cold, then the current would be carried entirely by negative ions, there would be free negative ions in the space between the electrodes, these would cause the electric force to increase as we pass from the cathode to the anode and would make the current increase rapidly with the potential difference. Now suppose that the anode becomes hot and that

there is some gas in contact with it which can be ionised, yielding a supply of positive ions; this current will no longer be carried entirely by negative ions, though inasmuch as (p. 242) the velocity of the negative ion at these high temperatures is very much greater than that of the positive, by far the larger part of the current is carried by the negative ions. The presence of the positive ions, however, modifies very considerably the distribution of potential between the electrodes: the positive ions diffuse into the region of the discharge until they are sensibly equal in number to the negative ions; when this is the case the electric force is sensibly uniform between the terminals except close to the electrodes, and we have a distribution similar to that given in Fig. 52, p. 233, which is taken from a paper by H. A. Wilson on the conductivity through hot gases, and represents the distribution of potential between two hot electrodes: by comparison with Fig. 187 it will be seen that this bears a great resemblance to the distribution of potential between the terminals in the arc discharge. The view we take of the arc discharge is that it is similar to the discharge between the incandescent terminals just considered, the only difference being that in the flame the temperature of the terminals is maintained by independent means, while in the arc it is maintained by the work done by the discharge itself; this requires that the potential difference between the electrodes and the current passing between them should not sink below certain values. On the other hand, when the temperature is maintained by external aid the smallest potential difference is able to send a current.

On this view the cathode is bombarded by the positive ions which maintains its temperature at such a high value that negative corpuscles come out of the cathode; these, which carry by far the larger part of the arc discharge, bombard the anode and keep it at incandescence; they ionise also either directly by collision or indirectly by heating the anode, the gas or vapour of the metal of which the anode is made producing in this way the supply of positive ions which keep the cathode hot. It will be seen that the essential feature in the discharge is the hot cathode, as this has to supply the carriers of the greater part of the current in the arc; the anode has in general to be hot, otherwise it could not supply the positive ions which keep the cathode hot; in such a case as that of a third electrode put in the arc and acting as one of the anodes we may regard the discharge as having two

anodes, and as one is sufficient to keep the cathode hot we can get the arc to pass to the other anode even although it is cold*.

We can trace the transition from the glow to the arc discharge very conveniently by using as cathode a lime-covered platinum wire heated to redness by an electric current and having a thermo-junction fused on to the platinum to measure the temperature; the anode is a cold metal plate and the gas in the discharge tube was at a low pressure. The electrodes are connected up with a battery of cells, and the number of cells in the battery gradually increased. The early stages when the number of cells is small has already been described (see p. 477); in these stages the temperature of the cathode is not appreciably increased by the current; if the number of cells in the battery is steadily increased a stage is reached when the temperature of the cathode begins to increase; the increase in the current through the tube is now very rapid, while the potential difference between the anode and cathode, in spite of the increase in the electromotive force in the rest of the circuit, falls very quickly; the increase in the temperature of the cathode and the current through the tube goes on with great rapidity, the cathode soon gets quite hot and the current rises from a few milli-ampères to several ampères, the potential difference between the cathode and anode falling to about 30 volts. The high temperature of the cathode is due to its bombardment by positive ions; at this stage we may switch off the current used to heat the cathode, and the cathode will remain hot and the arc continue to pass.

If we raise by the current the temperature of the cathode to a white heat before applying the field the arc will begin almost immediately; the experiment in this form is difficult as the wire cathode has to be thin if it is to be made hot enough by the current and generally melts after the arc has passed for a few seconds.

320. The conditions that determine the current when a given electromotive force acts round the whole circuit of the

* Stark, in a paper (*Ann. der Phys.* 12, p. 673, 1903) published almost simultaneously with the first edition of this book, gave a theory of the arc which in its main features agrees with that just given. See also Stark and Cassuto, *Phys. Zeits.* v. p. 264, 1904

arc are that the work supplied to the cathode and anode should be sufficient to maintain them at incandescence. Although we have not the data which would make a numerical calculation possible, yet an expression in an analytical form of these conditions may serve to make the preceding theory clearer and more definite.

We have seen that the number of corpuscles emitted in one second by unit area of a hot body increases very rapidly with the temperature, being represented with considerable accuracy by a formula of the form $A\theta^{\frac{1}{2}}\epsilon^{-\frac{w}{\theta}}$, where θ is the absolute temperature; we shall call this function $f(\theta)$, then if θ is the temperature and ω_1 the area of the luminous part of the cathode the number of corpuscles coming from the cathode in one second is equal to $\omega_1 f(\theta)$. If i is the current, R_1, R_2 the velocities of the positive and negative ions under unit electric force, the part of the current carried by the negative ions is $R_2 i / (R_1 + R_2)$, and this when divided by e , the charge on an ion, is equal to the number of negative ions passing a section of the arc per second; hence we have

$$\frac{R_2}{R_1 + R_2} \frac{i}{e} = \omega_1 f(\theta) \dots\dots\dots(1).$$

Let us now consider the temperature equilibrium of the cathode. Let $\omega_1 \phi(\theta)$ be the rate at which it is losing heat by radiation and conduction, w the work expended when the cathode emits one corpuscle, then to maintain thermal equilibrium the rate at which energy must be given to the cathode is

$$\frac{w}{e} \frac{R_2}{R_1 + R_2} i + \omega_1 \phi(\theta);$$

this work has to be supplied by the positive ions coming up to the cathode in unit time; the number of such ions is

$$\frac{R_1}{R_1 + R_2} \frac{i}{e}.$$

We shall suppose that the energy they possess is got in passing through the fall of potential at the cathode; let this fall be denoted by E_0 , then equating the rate at which energy is communicated to the cathode to the rate at which the cathode is losing energy we get

$$E_0 \frac{R_1}{R_1 + R_2} i = w \frac{R_2}{R_1 + R_2} \frac{i}{e} + \omega_1 \phi(\theta),$$

or
$$E_0 = \frac{w R_2}{e R_1} + \omega_1 \frac{R_1 + R_2}{R_1} \frac{\phi(\theta)}{i} \dots \dots \dots (2).$$

Let θ_1 be the temperature and ω_2 the area of the hot part of the anode, $\omega_2 \psi(\theta_1)$ the rate at which it is losing energy by radiation, conduction, and vaporisation, W the amount of work required to produce a positive ion.

The number of positive ions produced in unit time is

$$\frac{R_1 i}{R_1 + R_2 e};$$

thus the work absorbed per second at the cathode is

$$\omega_2 \psi(\theta_1) + \frac{R_1}{R_1 + R_2} \frac{W i}{e}.$$

The number of negative ions striking against the anode in unit time is

$$\frac{R_2 i}{R_1 + R_2 e};$$

let us suppose that the energy with which they strike against the anode is that due to passing through the anode fall of potential E_1 ; equating the rate at which the anode is losing energy to that at which it is gaining it we have

$$E_1 \frac{R_2}{R_1 + R_2} i = W \frac{R_1}{R_1 + R_2} \frac{i}{e} + \omega_2 \psi(\theta_1);$$

thus
$$E_1 = \frac{W R_1}{e R_2} = \omega_2 \frac{\psi(\theta_1)}{i} \frac{R_1 + R_2}{R_2} \dots \dots \dots (3);$$

θ_1 , as we have seen, does not depend on the current but only on the material of which the anode is made.

If E is the external electromotive force acting on the circuit, R the resistance of the leads, then $E - Ri$ is the potential difference between the arc terminals; when the arc is so short that we may neglect the changes in potential along the arc, apart from those at the anode and cathode, this difference of potential is equal to $E_0 + E_1$; hence we have

$$E - Ri = E_0 + E_1 \dots \dots \dots (4);$$

thus we have four equations (1), (2), (3), and (4) to determine the four quantities θ , i , E_0 , and E_1 .

Mrs Ayrton has shown that ω_2 the area of the crater is a linear function of the current and may be represented by an equation of

the form $\omega_2 = a + bi$; if ω_1 follows the same law then equations (2) and (3) suggest that $E_0 + E_1$ will be of the form $\alpha + \frac{\beta}{i}$, where α and β are independent of i , and this is in accordance with the results of the experiments made on the relation between the current through the arc and the potential difference between its terminals.

321. Taking the equation

$$E = Ri + \alpha + \frac{\beta}{i} \dots\dots\dots(5),$$

we see that the graph representing this relation is a hyperbola. E has a minimum value at the point A , this value is

$$2\sqrt{\beta R} + \alpha.$$

The portion of the graph to the left of A corresponds to an unstable state, for suppose the current is changed from i_0 to $i_0 + x$ and

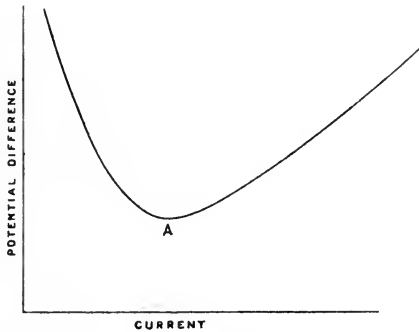

Fig. 188.

that there is self-induction L in the external circuit, let E' be the steady electromotive force due to batteries, &c., in this circuit, then from (5) we have

$$E' - L \frac{dx}{dt} = R(i_0 + x) + \alpha + \frac{\beta}{i_0 + x},$$

or when x is small

$$-L \frac{dx}{dt} = x \left(R - \frac{\beta}{i_0^2} \right),$$

or

$$x = C \epsilon^{\frac{t}{L} \left(\frac{\beta}{i_0^2} - R \right)}.$$

Now to the left of A , $\frac{\beta}{i_0^2} - R$ is positive, hence x will increase indefinitely with t and the current will be unstable; to the right of A this quantity is negative and x will diminish to zero as the time increases, the current under these conditions will be stable. Thus for stability the current cannot be less than its value at A , i.e. $(\beta/R)^{\frac{1}{2}}$, hence if i_m is the minimum current, E_m the minimum external electromotive force, we have

$$i_m = (\beta/R)^{\frac{1}{2}},$$

$$E_m = 2(\beta R)^{\frac{1}{2}} + \alpha,$$

or if the external electromotive force is E the arc will go out if the resistance R in the external circuit is greater than

$$\frac{(E - \alpha)^2}{4\beta}.$$

Thus as one numerical example let us take the case of the arc 6 mm. in length for which the curve representing the relation between the current through the arc and the potential difference between the terminals is represented in Fig. 185, page 106; from the curve we find that $\beta = 3.4 \times 10^8$ in absolute measure; we may take α as about 40 volts, or in absolute measure 4×10^9 , if E the electromotive force in the external circuit is 80 volts or 8×10^9 absolute units; we find that the arc will go out if the resistance is greater than

$$\frac{16 \times 10^{18}}{4 \times 3.4 \times 10^8} = 1.2 \times 10^{10} = 12 \text{ ohms.}$$

322. Another way of treating the problem of the arc graphically is, instead of tracing the curve

$$E = Ri + F(i),$$

where $F(i)$ is the potential difference between the terminals of the arc when it is carrying the current i , to trace the curve

$$y = F(i)$$

and the straight line

$$y = E - Ri;$$

if these intersect in two points P and Q (Fig. 189) we can show as before that the state corresponding to P is unstable, and that the current under the given external electromotive force and resistance

is represented by the abscissa of the point Q ; if the resistance is too great the line may not cut the curve at all, while if it is too small the point Q may be so far away that the corresponding value of the current may be too great for a silent arc and a hissing arc will necessarily be formed.

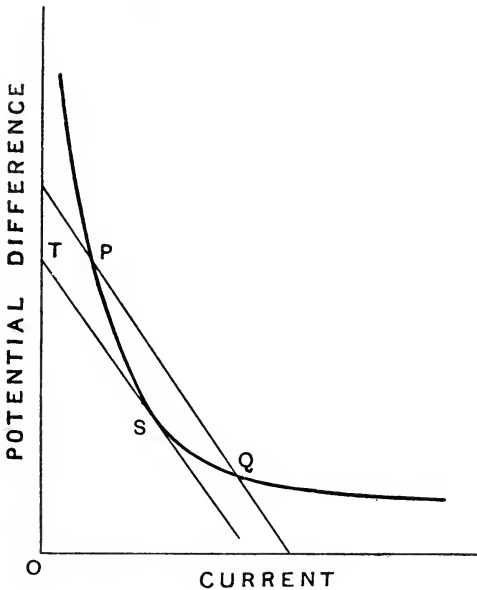

Fig. 189.

The minimum current for a given external resistance is got by finding the point S when the tangent to the curve is parallel to the line $y = -Ri$. The current at S is the minimum current, and the value of OT , T being the point where the tangent at S intercepts the axis $i = 0$, is the minimum external electromotive force.

To find the maximum value of R for which the arc can exist under a given external electromotive force E_1 take $ON = E_1$, and from N draw a tangent to the curve; let this tangent cut the axis $y = 0$ in M , then ON/OM is the required resistance.

Hissing Arcs.

323. When the current is increased beyond a certain value, the potential difference between the terminals falls in the case of

carbon electrodes by about 8 or 10 volts and does not change when the current is increased; when in this state, the arc emits a hissing sound. Mrs Ayrton*, who has made a study of the hissing arc, has shown that it occurs when the incandescence of the anode covers such a large area that it expands beyond the crater up the sides of the terminal: see Fig. 184, *c* and *a*, which represent the appearance of the arc in the hissing and quiet stages. The hissing of the arc is closely connected with the oxidation of the terminal by the air; for when the incandescence extends up the sides of the carbon, the glowing carbon is no longer completely protected by the carbon vapour from oxidation. It is then that the arc hisses. Mrs Ayrton has shown that if the arc is formed in a closed vessel an increase of current ceases to make it hiss as soon as the oxygen in the vessel has been burnt up; whenever, however, fresh oxygen is introduced into the vessel the hissing recommences.

We can see why chemical combination should tend to diminish the potential difference between the terminals of the arc, for the heat evolved by the burning of the terminals would tend to maintain them at incandescence, so that the whole of the energy required for this purpose would no longer have to be supplied by the electric field.

Trotter† has shown that parts of the arc are in rapid motion in the unstable state between the hissing and the quiet arc.

Effect of a magnetic field on the arc.

324. The arc is deflected by a magnetic field in the same direction as a flexible conductor would be if it carried a current flowing in the same direction as that through the arc. The curved course corresponds to a longer path and the effect of the magnetic field on the potential difference is of the same character as an increase in the length of the arc, and just as it is possible to extinguish an arc by increasing its length, so the arc can be blown out by the application of a strong magnetic field.

* Mrs Ayrton, *The Electric Arc*.

† Trotter, *Proc. Roy. Soc.* lvi. p. 262, 1894.

CHAPTER XIX.

CATHODE RAYS.

325. So many observations have been made on these rays, and such important conclusions drawn from them, that it is convenient to devote a separate chapter to their consideration. We have already in Chapter XII discussed the reflection and absorption of these rays, in this Chapter we shall consider their other properties and the methods by which they are produced.

The cathode rays were discovered by Plücker* in 1859; he observed on the glass of a highly exhausted tube in the neighbourhood of the cathode a bright phosphorescence of a greenish-yellow colour. He found that these patches of phosphorescence changed their position when a magnet was brought near to them, but that their deflection was not of the same nature as that of the rest of the discharge which we have seen he had carefully studied. Plücker ascribed the phosphorescence to currents of electricity which went from the cathode to the walls of the tube and then retraced, for some reason or another, their steps.

The subject was next taken up by Plücker's pupil Hittorf†, to whom we owe the discovery that a solid body placed between a pointed cathode and the walls of the tube casts a well-defined shadow, the shape of the shadow only depending upon that of the body, and not upon whether the latter be opaque or transparent, an insulator or a conductor. This observation was confirmed and extended by Goldstein‡, who found that a well-marked, though not a very sharply defined shadow was cast by a small body near the cathode, whose area was much greater than that of the body: this was a very important observation, for it showed

* Plücker, *Pogg. Ann.* 107, p. 77, 1859; 116, p. 45, 1862.

† Hittorf, *Pogg. Ann.* 136, p. 8, 1869.

‡ Goldstein, *Berl. Monat.* p. 284, 1876.

that the rays producing the phosphorescence came in a definite direction from the cathode. If the cathode were replaced by a luminous disc of the same size no shadow would be cast by a small object placed near it, for though the object might intercept the rays which came normally from the disc, yet enough light would be given out sideways by other parts of the disc to prevent the shadow being well marked. Goldstein, who introduced the term 'Kathodenstrahlen' for these rays, regarded them as waves in the ether, a view which received much support in Germany. A very different opinion as to the origin of the rays was expressed by Varley*, and later by Crookes†, who advanced many and weighty arguments in support of the view that the cathode rays were electrified particles shot out from the cathode at right angles to its surface with great velocity, causing phosphorescence and heat by their impact with the walls of the tube, and suffering a deflection when exposed to a magnetic field by virtue of the charge they carried. The particles in this theory were supposed to be of the dimensions of ordinary molecules; the discovery made by Hertz‡ that the cathode rays could penetrate thin gold-leaf or aluminium was difficult to reconcile with this view of the cathode rays; although it was possible that the metal when exposed to a torrent of negatively electrified particles acted itself like a cathode and produced phosphorescence on the glass behind. The measurements described in Chapter V. of the mass of the particles carrying the charge show that though the cathode rays do consist of negatively electrified particles, the particles are not of the dimensions of even the smallest molecules, having a mass only about one-thousandth part of that of a molecule of hydrogen. We shall now proceed to describe the properties of the cathode rays in detail, beginning with that which led to their discovery, viz. the phosphorescence they produce when they fall on solids.

326. The colour of the phosphorescent light they produce when they fall on glass depends upon the nature of the glass; thus with soda glass the light is yellowish-green, with lead glass it is blue. A very large number of bodies become phosphorescent when exposed to these rays; indeed, this phosphorescence often

* Varley, *Proc. Roy. Soc.* xix. p. 236, 1871.

† Crookes, *Phil. Trans.* Pt. I. 1879, p. 135; Pt. II, 1879, p. 641.

‡ Hertz, *Wied. Ann.* xlv. p. 28, 1892.

affords a convenient means for detecting the rays: as phosphorescence is very easily excited in potassium platino-cyanide a screen of this substance is often used to detect the rays. The spectrum of the light given out by bodies when phosphorescing under bombardment by these rays is generally a continuous one. Sir William Crookes* has shown that when the cathode rays fall on some of the rare earths, such as yttrium, the substance gives out a spectrum with bright bands; he has founded on this observation a spectroscopic method which is of the greatest importance in the study of the rare earths†. These earths are luminous when raised to a high temperature as in the mantles of Welsbach burners; there is, however, a marked difference between the incandescence produced in this way and that produced by cathode rays; thus in the Welsbach burner the addition of 1 per cent. of ceria to thoria increases the luminosity elevenfold as compared with that of pure thoria. Campbell Swinton‡ has shown, however, that it produces no appreciable change in the luminosity under cathode rays: again, in the flame pure ceria gives about as much light as pure thoria, while under cathode rays pure thoria gives a brilliant light, and pure ceria practically no light at all.

327. The impact of the cathode rays produces in some cases very definite chemical changes; thus Goldstein§ has shown that the haloid salts of the alkali metals change colour when exposed to the rays; thus for example, crystals of rock-salt acquire under the rays a beautiful violet tint; this tint is not permanent, though under certain circumstances the rate of decay is exceedingly slow: thus there are at the Cavendish Laboratory some of these crystals, which, corked up in a test-tube but not kept in the dark, have retained a strong coloration for more than seven years: exposure to moisture causes the colour to fade away rapidly. Lithium chloride is especially easily coloured; if a beam of cathode rays is slowly moved over the salt by a magnet the path of the beam traces out a coloured band over the surface of the salt. Similar changes in colour can be produced by chemical means; thus if sodium chloride is heated up with sodium vapour it gets coloured in much the same way as if it were exposed to cathode

* Crookes, *Phil. Trans.* Pt. II. 1879, p. 661.

† *Ibid.* Pt. III. 1883; Pt. II. 1885.

‡ Campbell Swinton, *Proc. Roy. Soc.* lxx. p. 115, 1900.

§ Goldstein, *Wied. Ann.* liv. p. 371, 1898.

rays; the coloured salt is also produced at the cathode in the electrolysis of haloid salts. The coloured salt also occurs native. According to E. Wiedemann and Schmidt* the coloration is due to the formation of a sub-chloride. Elster and Geitel† discovered that these coloured salts are very photo-electric, discharging negative electricity when exposed to light; behaving, in fact, as if they contained traces of the free metal. The glass of a vacuum tube also acquires a violet tint after long use.

328. The power of the glass to phosphoresce is deadened by long exposure to cathode rays: this is very beautifully shown in an experiment made by Crookes‡; the shadow of a mica cross was thrown upon the walls of the tube; after the discharge had been running for some time the cross was shaken down or a new cathode in a different part of the tube was used; the pattern of the cross could still be traced on the glass, but it was now brighter than the rest of the glass instead of darker as before. The portions outside the original pattern got tired by the bombardment, and so in the second part of the experiment phosphoresced less brightly than the portions inside the original shadow which were now bombarded for the first time. Crookes found that this change in the phosphorescence of the glass persisted even after the glass had been fused and again allowed to cool.

329. Villard§ found that cathode rays exert a reducing action; thus if they fall upon an oxidised copper plate, the part exposed to the rays becomes bright. In considering the chemical effects produced by the rays we ought not to forget that the incidence of the rays is often accompanied by a great increase in temperature, and that some of the chemical changes may be secondary effects due to the heat produced by the rays. Platinum after long exposure to the rays gets covered with platinum black.

Thermoluminescence.

330. In some cases, even when no visible coloration is produced, the behaviour of the body after exposure to the rays shows that it

* Wiedemann and Schmidt, *Wied. Ann.* liv. p. 262, 1895; lxiv. p. 78, 1898.

† Elster and Geitel, *Wied. Ann.* lix. p. 487, 1896.

‡ Crookes, *Phil. Trans.* Pt. II. p. 645, 1879.

§ Villard, *Journal de Physique*, 3^{me} Série, t. viii. p. 140, 1899.

has been changed. A very striking instance is the case called by E. Wiedemann* 'Thermoluminescence.' Some bodies, after exposure to cathode rays, are found to possess for some time the power of becoming luminous when their temperature is raised to a point

Substance	Cathode phosphorescence	After-glow	Thermo-luminescence
CaSO ₄	faint yellowish red	none	none
CaSO ₄ +x MnSO ₄	intense green	strong green	intense green
SrSO ₄	none
SrSO ₄ +x MnSO ₄	bright red	perceptible	perceptible
BaSO ₄	faint dark violet
BaSO ₄ +x MnSO ₄	dark blue	faint	very faint
MgSO ₄	red	perceptible	feeble
MgSO ₄ +1% MnSO ₄ ...	intense dark red	persistent	intense red
ZnSO ₄	bright, white	persistent	white
ZnSO ₄ +1% MnSO ₄ ...	intense red	very persistent	very strong red
Na ₂ SO ₄	bluish	faint	bright
Na ₂ SO ₄ +0.5% MnSO ₄	intense brownish yellow	strong	bright yellow
CdSO ₄	yellow	persistent	bright yellow
CdSO ₄ +1% MnSO ₄ ...	intense yellow	very persistent	intense yellow
CaFl ₂	faint bluish	very faint	faint
CaFl ₂ +x MnFl ₂	intense green	persistent	intense green

far below that at which they become luminous when in their normal state; they retain this property for weeks, and even months, after exposure to the rays. The substances in which this property is most highly developed belong to the class of bodies called by Van 't Hoff† solid solutions; these are formed by precipitating simultaneously from a solution two salts, one greatly in excess

* E. Wiedemann and Schmidt, *Wied. Ann.* liv. p. 604, 1895.

† Van 't Hoff, *Zeitschr. f. physik. Chem.* v. p. 322, 1890.

of the other. The influence of a slight trace of a second substance on the phosphorescence produced while the rays are playing on the substance, the after-glow, which lingers for a time after the rays are stopped, and the thermoluminescence is shown by the preceding table, due to E. Wiedemann and Schmidt*. By the symbol $\text{CaSO}_4 + x \text{MnSO}_4$ is meant a 'solid solution' of a trace of MnSO_4 in a matrix of CaSO_4 .

The 'Entladungstrahlen' (see p. 602) also give rise to thermoluminescence, as Wiedemann found that any of the preceding substances showed thermoluminescence if sparks were produced close to them.

331. We may compare the after-glow observed with these solids with that which is observed when the electric discharge passes through certain gases which are found to remain luminous for a considerable time after the discharge has passed through them. It is not necessary that the discharge should consist of cathode rays; most kinds of discharges will produce this after-glow if the pressure is suitable; it is exceptionally conspicuous in electrodeless discharges and is especially well developed in oxygen and cyanogen, gases which polymerise with great ease. I think there are strong reasons for believing that the after-glow is very closely connected with the power some gases possess of polymerising and forming complex molecules; and that the gradual return of the gas from its polymerised to its normal form is accompanied by the emission of light.

332. Like the thermoluminescence of solids, the after-glow in gases seems to be increased by the presence of small quantities of impurities; thus it is brighter in oxygen with a little nitrogen than in pure oxygen. Newall† discovered a very remarkable effect connected with the after-glow in oxygen; he found that with the electrodeless discharge the after-glow was only developed when the pressure was between the limits '6 mm. and '01 mm. If the discharge is sent through the gas at a pressure not between these limits, there is no glow, but if after the discharge has ceased the pressure is altered so as to come within the limits the gas at once begins to glow, suggesting that the polymerised form is stable, *i.e.*

* Wiedemann and Schmidt, *Wied. Ann.* lvi. p. 201, 1895.

† Newall, *Proc. Camb. Phil. Soc.* ix. p. 295, 1897.

does not go back into the normal form except between the limits $\cdot 6$ mm. and $\cdot 01$ mm. It may be mentioned that this is the region of pressure in which some observers, though not all, have observed large departures from Boyle's law.

In the case of phosphorescent solids and liquids we may regard the phosphorescence as arising in the following way. The cathode rays or Entladungstrahlen ionise the substance, causing complex substances to be formed which phosphoresce as they break up into their original constituents; some of these complex molecules are unstable at the temperature of the room and at once begin to decompose, giving rise to the after phosphorescence of the glass, etc.; others are stable at ordinary temperatures, but are unstable and decompose at high temperatures; these produce thermoluminescence.

333. M^cClennan* has shown that some salts, especially the sulphates of potassium, barium, strontium and calcium, after exposure to cathode rays, or to the radiation from a spark, possess the power of discharging a positively electrified body placed near them in a gas at low pressure, behaving in fact as if they were photo-electric bodies exposed to the action of ultra-violet light, *i.e.* they emit slowly moving negatively electrified corpuscles. M^cClennan made experiments to show that there was no emission of ultra-violet light from the heated salts. There does not seem to be any connection between the powers of salts to produce the effect discovered by M^cClennan and their power of producing thermoluminescence: as M^cClennan found that many salts which glowed strongly when heated did not give his effect, which was given by some salts which hardly showed any thermoluminescence.

Thermal effects produced by the rays.

334. The cathode rays heat bodies on which they fall, and if the rays are concentrated by using a portion of a hollow cylinder or spherical shell as a cathode, platinum may be raised to incandescence, thin pieces of glass fused, and the surface of a diamond charred.

* M^cClennan, *Phil. Mag.* vi. 3, p. 195, 1902.

Measurements of the amount of heat developed by the rays have been made by E. Wiedemann and Ebert*, E. Wiedemann†, and Ewers‡. A simple example will give some idea of the amount of energy carried by the rays. If n is the number of corpuscles striking a body in unit time, m the mass of a corpuscle, and v its velocity, then E the energy possessed by the corpuscles striking the body in unit time is $\frac{1}{2}nmv^2$; if all the corpuscles coming from the cathode are caught by the body and e is the charge on a corpuscle, then $ne = I$, the current carried by the corpuscles; thus $E = \frac{1}{2}I \frac{m}{e} v^2$: now 10^{-5} ampères is not an exceptionally high value for I , and if $v = 5 \times 10^9$ cm./sec. we get, since $m/e = 6 \times 10^{-8}$, $E = 12.5 \times 10^5$; thus the energy possessed by the corpuscles striking the body per minute would be about one calory.

335. The impact of the corpuscles does more than heat the body, it makes it phosphoresce, it produces Röntgen rays, and causes the body to emit cathode rays. Interesting information is afforded by measuring the heat produced by the cathode rays, and also the charge of electricity brought to the body by the rays; such measurements have been made by the author§, and later in greater detail by Cady||. Cady's method was to measure (1) the heat produced in a bolometer strip against which the rays struck, and (2) the negative charge acquired by the bolometer per second; the latter, it is important to notice, need not be the same as the charge carried by the corpuscles striking the body in one second, for some of the corpuscles may rebound from the body without giving up a charge, or the impact of the rays may cause the body to give out cathode rays, carrying from it a negative charge, or positively electrified atoms, giving to it an additional negative charge; thus if I is the charge carried by the corpuscles, i that acquired by the bolometer per second, then I is not necessarily the same as i . If V is the potential difference between the electrodes in the tube, then the energy carried by the corpuscles is VI . Cady measured the ratio of Vi to Q the

* Wiedemann and Ebert, *Sitz. der phys. med. Soc. Erlangen*, Dec. 1891.

† E. Wiedemann, *Wied. Ann.* lvi. p. 61, 1898.

‡ Ewers, *Wied. Ann.* lxi. p. 167, 1899.

§ J. J. Thomson, *Phil. Mag.* v. 44, p. 293, 1893.

|| Cady, *Drudes Ann.* i. p. 678, 1900.

mechanical equivalent of the heat developed in unit time; he found that this ratio depends greatly upon the value of i ; as long as i is large it is greater than unity, diminishing as i diminishes; when i gets very small (less than 10^{-7} ampères), the ratio becomes constant and equal to $\cdot 83$; as the ratio is less than unity it follows that there is an emission of negative electricity from the bolometer, either by the reflection of the cathode rays, or by the emission of secondary cathode rays from its surface. We have seen that the measurement of i and V does not give the energy reaching the surface through the cathode rays; a slight modification of the experiment would, however, give the data by which this energy could be determined; all that is necessary would be to surround the bolometer by an insulated Faraday cylinder, into which the rays were admitted through a small opening, and then to measure the charge received by this cylinder in unit time.

E. Wiedemann* has shown that the energy spent in producing phosphorescence is but a small fraction of the incident energy.

Mechanical effects produced by the rays.

336. A secondary result of the thermal effects produced by the rays are the very interesting mechanical effects which have been especially studied by Crookes† and Puluz‡. A typical example of these is afforded by the well-known experiment due to Crookes represented in Fig. 190, where the axle of a very light

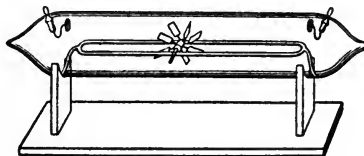

Fig. 190.

mill with a series of vanes is mounted on glass rails, in a vacuum tube; when the discharge passes through the tube the cathode rays strike against the upper vanes and the wheel rotates and travels from the negative to the positive end of the tube.

* E. Wiedemann, *Wied. Ann.* lxvi. p. 61, 1898.

† Crookes, *Phil. Trans.* 1879, pt. i. p. 152.

‡ Puluz, *Radiant Electrode Matter*. Physical Society's Reprint of Memoirs, p. 275.

A simple calculation will show that we cannot ascribe the rotation to the momentum communicated to the vanes by the impact of the corpuscles against them; for, take the case when the rays are so powerful that they carry the very large current of 10^{-5} ampères, and that they move with the very high velocity of 10^{10} cm./sec.: if N is the number of corpuscles striking a surface in unit time, m the mass of the corpuscles; then supposing the corpuscles to rebound from the surface with a velocity equal to that with which they impinge against it, the momentum communicated to the surface in unit time is $2Nm10^{10}$; if e is the charge carried by a corpuscle, then Ne is the current carried by the rays, in our case 10^{-6} in absolute measure; hence the momentum communicated to the surface per second is equal to $2\frac{m}{e}10^4$ dynes, or as $m/e = 6 \times 10^{-8}$, to 2×10^{-3} dynes: this is equivalent to a difference of pressure on the two sides of a vane 1 sq. cm. in area of one-five-hundred-millionth part of an atmosphere; an effect altogether too small to explain the movement of a body such as that represented in Fig. 190. This movement is probably due to an effect similar to that observed in a radiometer, as the impact of the cathode rays will make one side of the vanes much hotter than the other. Starke* has shown that when the vanes are arranged so that the radiometer effect is eliminated, the mechanical effect is exceedingly small—in his experiments, where the current carried by the cathode rays was 10^{-7} ampères and the potential difference 10,000 volts—certainly less than 10^{-4} dynes.

Electric charge carried by the cathode rays.

337. The fact that the cathode rays carry a negative charge of electricity was proved in a very direct way by Perrin†. Fig. 191 represents a modification of his experiment. The rays start from the cathode A and pass through a slit in a brass rod B , which fits tightly into the neck of the tube; this rod is connected with the earth and used as an anode; the rays after passing through the slit enter the spherical vessel C . In this vessel there are two coaxial metal cylinders, the outer one D connected with the earth, the inner one E carefully insulated and connected with an

* Starke, *Ann. der Phys.* iii. p. 101, 1900.

† Perrin, *Comptes Rendus*, cxxi. p. 1130, 1895.

electrometer. The cylinders are placed so as to be out of the direct line of fire of the rays. When the discharge passed through the tube and the cathode rays passed horizontally through

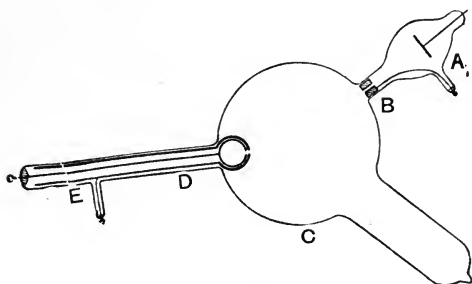

Fig. 191.

the vessel *C*, the inner cylinder *E* received a small, but only small, negative charge. The cathode rays were then deflected by a magnet; their path could be inferred from the position of the phosphorescent patch on the walls of *C*; when the deflection was increased, so that the position of the patch showed that the rays had fallen on the opening of the cylinders, there was a very great increase in the negative charge received by *E*; when the rays had been so much deflected that the phosphorescent patch fell below the slit the negative charge in the cylinder *E* again disappeared. This experiment shows that the rays carry a negative charge, as it proves that the negative electrification follows exactly the same course as the rays producing the phosphorescence on the glass.

This experiment also shows that the cathode rays make the gas through which they pass a conductor of electricity; for if in the experiment the discharge is kept continuously passing through the tube and the cathode rays deflected until they pass into the cylinder, the negative charge on the cylinder will rise to a certain value, beyond which it will not increase however long the discharge may be kept running; this shows that the gas round the cylinder is a conductor, and the steady state of the cylinder is reached when it loses as much electricity by conduction through the gas as it gains from the cathode rays. The same thing is shown when the cylinder is given a negative charge before the discharge through the gas begins: if this charge is less than a certain value the

cathode rays will increase the charge; if however it is greater than this value, the cathode rays will diminish the charge until it falls to this critical value.

An interesting way of showing the deviation of the cathode rays under an electric field is to produce a narrow pencil of the rays from a spot of lime on a strip of platinum foil heated to redness by an electric current; if this strip is used as a cathode a thin sharply-defined pencil of rays will start from the patch of lime; if, as in the arrangement shown in Fig. 192, a metal plate *B* is placed near the path of the rays, then if this is charged negatively the cathode rays will be bent from the plate as in the

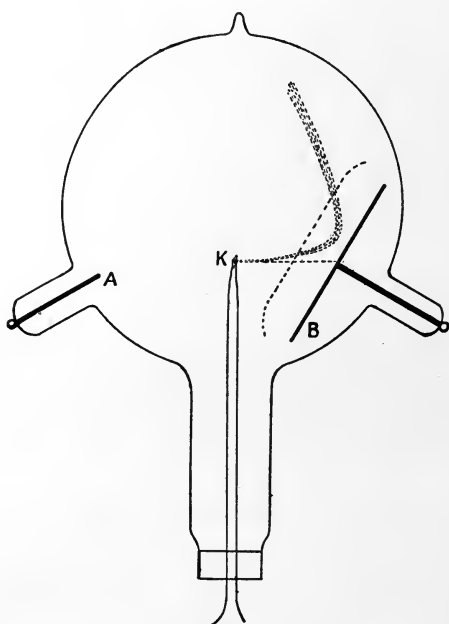

Fig. 192.

figure and their path can readily be traced by the luminosity they produce in the gas. The hot lime enables us to produce rays with a smaller potential difference than could be used with a cold cathode so that the velocity of the rays is smaller and their deviation in a given electric field larger than is the case for rays produced in an ordinary vacuum tube.

The pencil of rays is very sensitive to the influence of magnetic force and bends into beautiful curves and spirals when a magnet is brought near to it.

Magnetic Spectrum of Cathode Rays.

338. Birkeland* found that when the cathode rays are produced by means of an induction coil, a patch of cathodic phosphorescence is not merely displaced by a magnetic field, but is broken up into several distinct patches; thus, for example, if there is originally a narrow straight band of phosphorescence, then under the magnetic field several parallel bright bands of phosphorescence separated by comparatively dark spaces are observed. This is called the magnetic spectrum. I have obtained similar effects by deflecting the rays by electric instead of magnetic forces. This splitting up of the rays shows that the original bundle of cathode rays is not homogeneous, but is made up of groups moving with different, and finitely different, velocities; each group being differently deflected, the slower ones more than the faster. Strutt† has shown that the magnetic spectrum is due to the want of uniformity necessarily associated with the use of an induction coil, which produces a discontinuous discharge, and that if the cathode rays are produced by a large electrostatic machine, or a large number of storage cells, either of which gives a continuous discharge, the phosphorescence is not broken up into separate patches by a magnetic or an electric field.

Path of the Cathode Rays in the Discharge Tube.

339. The cathode rays are deflected by an electric force; thus, as the electric field is very intense in the Crookes dark space, the rays as they pass through this space will, unless the lines of force in it are straight (this is approximately the case when the cathode is a large plane disc), be deflected and their paths will not coincide with the normals to the cathode at their point of projection. The amount of deflection of the path from this normal will depend mainly upon the rate at which the

* Birkeland, *Comptes Rendus*, cxxiii. p. 92, 1897.

† Strutt, *Phil. Mag.* v. 48, p. 478, 1899.

intensity of the electric field diminishes as we recede from the cathode: if, as in the case when the pressure is not very low, the field close to the cathode is very much more intense than that at some distance away from it, the corpuscles will acquire so much energy while still close to the cathode that they will not be much deflected by the comparatively feeble fields traversed by them during the rest of the journey; in this case the paths of the rays will be approximately the normals to the cathode, so that if the cathode is a hollow spherical bowl the rays will travel along the radii of the sphere and will be brought to a focus at its centre. If however the strength of the field only changes slowly as we recede from the cathode, we shall get much greater deviation than in the last case, for not only will the velocity they acquire while still close to the cathode be smaller, but also the deflecting force when they get away from the cathode will be greater. The paths of the rays will now be no longer along the normals because of the deflecting force, nor will they, owing to the inertia of the corpuscles, be along the lines of force unless these are straight. The paths of the corpuscles will be between the normal and the lines of force; for example, in the case of the hollow bowl, the path will be between the normal CP and the line of force PQ (Fig. 193); thus, if the

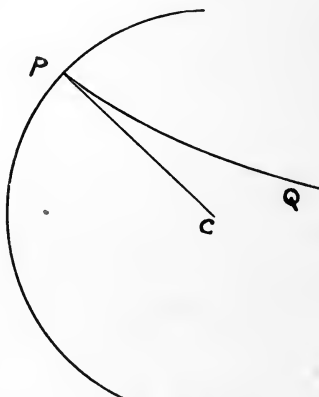

Fig. 193.

paths cross the axis of the bowl at all, they will do so at points on the far side of the centre. It is well known that when, as in the bulbs used for producing Röntgen rays, a cathode of this kind

is used, the 'focus' gets further from the cathode as the exhaustion is increased. Goldstein*, who made a series of beautiful experiments on the phosphorescent patterns produced by curved cathodes of different shapes, showed, by using an unsymmetrical cathode, that the rays crossed when the pressure was comparatively high, but did not do so at very high exhaustions. The appearance of the cathode rays from a curved cathode is shown by the diagrams in Fig. 195, p. 636, taken from a paper by Campbell Swinton†; it will be seen that this is very different from that which would result if the rays travelled along the normals to the cathode.

340. The motion of the corpuscles in a vacuum tube offers a fine field for the application of Hamilton's Principle of Varying Action: for since the cathode is an equipotential surface, and the corpuscles leave that surface normally and with equal amounts of energy, their paths will, by the Principle of Varying Action, be the orthogonal trajectories of a system of surfaces.

341. We have regarded the cathode rays as originating from positive ions which were formed by the cathode rays themselves at a distance from the cathode. If however the path PQ of the cathode ray is curved (Fig. 194), and if the positive ion is pro-

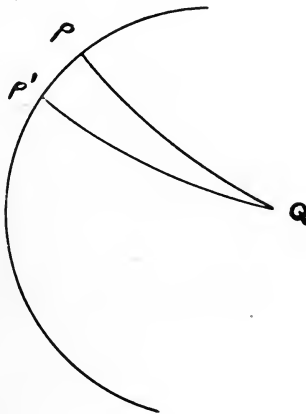

Fig. 194.

* Goldstein, *Wied. Ann.* xv. p. 254, 1882.

† Campbell Swinton, *Proc. Roy. Soc.* lxi. p. 79, 1897.

duced at Q , then, in consequence of the difference in mass between the positive and negative ions, the path of the positive ion up to the cathode will not be QP , but some other path such as QP' ; thus the cathode rays produced at P will, when the paths are not straight lines, give rise to positive ions which will help to make cathode rays which start not from P but from some other point P' .

The distance between the places where the positive ions strike the cathode and the origin of the cathode ray producing these ions will be greatest for the rays which start from near the boundary of the cathode, as these travel through the part of the electric field where the lines of force are most curved; there will thus not be many positive ions striking against the outer parts of the cathode, on this account the rate of emission of the cathode rays increases as we approach the centre of the cathode; on the other hand, if the cathode is curved the electric force close to the cathode will be a minimum at the centre, so that on this account the rays would be fewer along the axis; taking both these effects into consideration we should expect there would be a tendency for the rays to attain a maximum at some place intermediate between the centre and edge of the cathode.

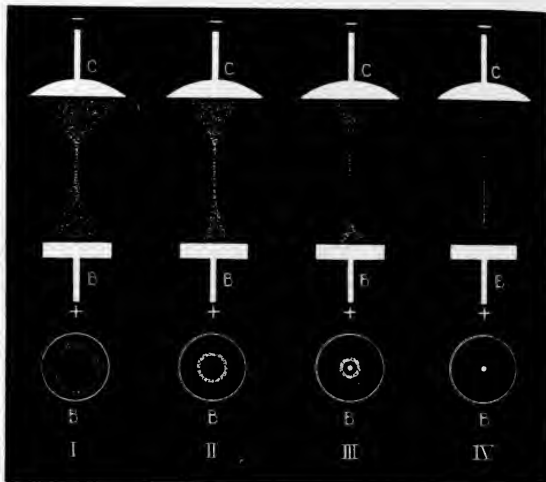

Fig. 195.

The observations of Campbell Swinton* establish the existence of such an effect; he found that with concave cathodes, when the pressure of the gas is within certain limits, the cathode rays do not form a solid pencil but are condensed into a hollow conical shell. He proved this by means of the phosphorescence produced by these rays on a carbon plate whose plane was at right angles to the cathode: the phosphorescent patch was a circular ring with in some cases a bright spot at the centre. The appearance of the phosphorescence is represented in Fig. 195.

This hollowness of the bundle of cathode rays was found by Campbell Swinton to depend on the curvature of the cathode, it did not occur when this was plane.

Repulsion of Cathodic Streams.

342. Goldstein† found that when in a discharge tube there are two cathodes connected together, the cathodic rays from one cathode are deflected when they pass through the dark space surrounding the other cathode.

One of Goldstein's experiments was as follows: two cathodes were used, one a hollow metal cylinder *a*, from which a pencil of cathode rays issued, producing luminosity in the gas through

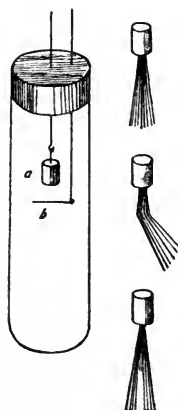

Fig. 196.

* Campbell Swinton, *Proc. Roy. Soc.* lxi. p. 79, 1897.

† Goldstein, *Eine neue Form der elektrischen Abstossung.*

which they travelled; the other cathode (*b*) was a wire at right angles to the axis of the bundle of rays proceeding from *a*; when *b* was disconnected from *a* the path of the rays from *a* was straight, but when *a* and *b* were connected the cathode rays from *a* were bent sharply away when they approached *b*. Goldstein found that the amount of deflection did not depend on the material of which the cathodes were made, nor on the nature of the gas through which the rays passed. The deflection ceased if the deflecting cathode was surrounded by a screen of some solid substance.

Another example of the deflection of two cathode streams is afforded by an experiment made by Crookes* ; *a* and *b* (Fig. 197) are two metal discs, either or both of which can be made into

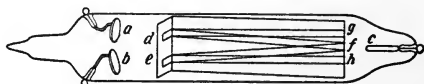

Fig. 197.

cathodes, a diaphragm with two holes cut in it is placed in front of these discs, and the path of the rays through the tube is marked out by the phosphorescence they excite in a chalked plate inclined at a small angle to their path. When *a* is the cathode and *b* is idle the rays travel along the path *df*, while when *a* is idle and *b* the cathode they travel along *ef*. When, however, *a* and *b* are cathodes simultaneously the paths of the rays are *dg* and *eh* respectively, the two streams having apparently repelled each other. Crookes attributed the divergence of the rays to the repulsion between the negative charges of electricity travelling along with them. E. Wiedemann and Ebert†, however, by a modification of this experiment, have shown that this is not the cause of the repulsion; they provided the holes *d* and *e* with shutters, and found that when *a* and *b* were simultaneously cathodes *eh* was the path of the rays through *e*, whether the window at *d* was open or shut, although when it was shut there were of course no cathode rays travelling along *dg* to deflect those passing through *d*, showing that the deflection of the rays has its origin in the space between *a* and *d*.

* Sir W. Crookes, *Phil. Trans.* 1879, part ii. p. 652.

† Wiedemann and Ebert, *Wied. Ann.* xlvi. p. 158, 1891.

The effects we have been describing can all be explained by the electrostatic repulsion of the negative electricity travelling along the cathode rays, by the strong electric field which surrounds a cathode; this repulsion is appreciable only when the rays from one cathode pass through the dark space of the deflecting cathode, because, as we have seen, the intensity of the electric field is very much greater in the dark space than it is at any other part of the discharge; we have, on page 531, discussed a method of using this deflection of the cathode rays for measuring the strength of the electric field in the tube.

Canalstrahlen or Positive Rays.

343. When a perforated cathode is used, there may, if the pressure is between certain limits, be observed luminous streams passing through the holes in the cathode, emerging on the side of the cathode remote from the anode, and travelling in straight lines, as in Fig. 198; these were first observed by Goldstein*,

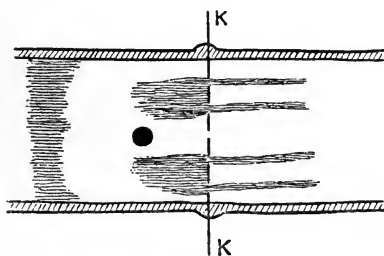

Fig. 198.

and called by him Canalstrahlen. They excite phosphorescence on the part of the glass against which they strike, and if this glass is soda glass the places struck by these rays show, when observed through the spectroscope, the sodium lines. Wehnelt† has shown that when these rays strike against a copper plate they oxidise it; the cathode rays, as we have seen (p. 624), reduce an oxidised plate. Schmidt‡ has shown that the oxidation of metals by the Canalstrahlen is not due to the impact of the rays but is an indirect effect due to the rays producing active oxygen when

* Goldstein, *Berlin Sitz.* xxxix. p. 691, 1886; *Wied. Ann.* lxiv. p. 45, 1898.

† Wehnelt, *Wied. Ann.* lxvii. p. 421, 1899.

‡ Schmidt, *Ann. der Phys.* ix. p. 703, 1902.

they pass through the gas; he showed this by casting a shadow on the copper plate by interposing between it and the rays a solid obstacle, the part of the plate in shadow was as much oxidised as that exposed to the direct impact of the rays. In hydrogen Schmidt observed that the Canalstrahlen exert a reducing effect.

Though these rays are much less deflected than the cathode rays by electric and magnetic fields, they do suffer appreciable deflection, and W. Wien has shown (see p. 146) that the direction of these deflections indicates that the Canalstrahlen consist of *positively* charged particles; he has measured, by the method indicated in Chap. V., the ratio of the charge to the mass, and finds for the maximum value of this quantity 10^4 , which is the ratio of the charge to the mass for the hydrogen ion in the electrolysis of solutions. Wien found that, in addition to the rays which give this limiting value to e/m , there were always other rays present which gave smaller values for e/m , and that there was no evidence that the change in this quantity was discontinuous, which it would be if the charge could only change by multiples of e and the mass by multiples of m . I have observed similar variations in the value of e/m for the positive ions given off from incandescent wires; I think this variation is probably due to the positive ions losing their charges before they reach the glass where they produce phosphorescence, or by having their mass increased on the journey by the adhesion of one or more molecules; what is measured in these determinations is the ratio of the *mean* value of e to m ; if now the positive ion gets neutralised by a negative charge or has its mass increased before it reaches the glass, then the mean value of e would be smaller than if it retained its original charge and mass up to the moment of impact. We must remember that the gas through which the Canalstrahlen move is ionised, and that there are plenty of corpuscles about to neutralise the positive charge. It may be urged that if the ions had lost their charge before striking the glass, they would not be able to produce phosphorescence, since, as far as our knowledge extends, phosphorescence is not produced by the impact of uncharged molecules; but, according to Wien's determination, the positive ions in the Canalstrahlen are moving with a velocity of more than 10^8 cm./sec.: we have no experience of

molecules moving with anything like this velocity; the shock of the collision might be sufficient to ionise the molecule afresh, and thus produce in the neighbourhood of the place of impact effects analogous to those produced by the collision of charged ions.

344. Several experiments have been made by W. Wien*, Ewers† and Villard‡ to detect the positive charge carried by the Canalstrahlen by catching, as in Perrin's experiment on the negative charge carried by the cathode rays (see p. 630), the Canalstrahlen in a Faraday cylinder, and observing the charge acquired by that cylinder. The aforesaid physicists differ in their interpretation of the results they obtain; all agree that under certain circumstances the Faraday cylinder, placed behind a perforated cathode, receives a positive charge of electricity, but while Wien and Ewers think that this charge is carried by the Canalstrahlen, Villard is of opinion that it is a secondary effect due to the slow diffusion into the cylinder of ions from other parts of the tube. In his experiments he found that the Canalstrahlen were able to penetrate into the cylinder for some time before it gave any indication of a positive charge, indeed if the discharge only lasted a short time, the positive charge in the cylinder first appeared some little time after the discharge had stopped. It seems possible that while the discharge is passing, the gas in the tube is too good a conductor to allow the charge on the cylinder to accumulate; just as in Perrin's experiment the conductivity of the gas prevents the negative charge on the cylinder rising above a certain value, however long the cathode rays are kept playing on the cylinder; when the discharge stops, the gas recovers its insulating power, and the cylinder can retain any charge that diffuses into it; if this view is correct, the positive charge observed in the cylinder is due mainly, at any rate, to diffusion and not to convection by the Canalstrahlen.

In spite of the indecisive results obtained by this experiment, the magnetic and electric deflections obtained by W. Wien seem conclusive evidence that the Canalstrahlen carry a positive charge.

* W. Wien, *Wied. Ann.* lxxv. p. 445, 1898.

† Ewers, *Wied. Ann.* lxxix. p. 167, 1899.

‡ Villard, *Journal de Physique*, [3], t. viii. pp. 5 and 140, 1899.

On the view of the discharge given in Chap. XV. there is a stream of positively charged molecules moving towards the cathode, causing this to emit cathode rays; if the cathode is perforated, part of this stream may pass through the holes, producing in the gas behind the cathode luminosity, forming in fact the Canalstrahlen, or positive rays as we may call them, if we think this view of their constitution sufficiently established.

Luminosity produced by Cathode Rays and Canalstrahlen.

345. The differences between the luminous effects produced by cathode rays and Canalstrahlen are very marked. They can be investigated very conveniently by means of a tube like that represented in Fig. 133, with this arrangement the lower plate, *M*, is struck by Canalstrahlen when *C* is the cathode and by cathode rays when *C* is the anode. If a layer of lithium chloride is placed on the plate, then when struck by Canalstrahlen it shines with a bright red light and the red lines of the lithium spectrum are very bright; if the direction of the discharge is reversed so that the lithium chloride is struck by cathode rays, its colour changes from bright red to steely blue, giving out a faint continuous spectrum but not the lithium lines. The lithium chloride after long bombardment by Canalstrahlen blackens and the lithium lines become much fainter than they were originally, this blackening takes place whether the tube is filled with hydrogen or with air.

Goldstein* has shown that many metals when used as cathode give out a line spectrum under bombardment by Canalstrahlen, the spectrum is especially bright when the tube is cooled by liquid air.

In some cases the Canalstrahlen excite the metallic lines more strongly in compounds of the metal than in the metal itself, thus if we bombard the surface of the liquid alloy of sodium and potassium with Canalstrahlen the specks of oxide floating on the surface shine out with a bright yellow light and show the *D* lines of sodium strongly, the clean parts of the surface on the contrary are hardly luminous at all, and I have never been able to see the *D* lines on this part of the surface. This difference may

* Goldstein, *Phys. Zeits.* vi. p. 14, 1905.

be due in part to the sodium being much more volatile than the oxide, so that an atom of sodium struck by the Canalstrahlen may volatilise and get away from the surface, while a molecule of oxide would be fixed, thus the light might be much more concentrated when the surface struck is not volatile than when it is easily vaporised.

Stark* has shown that the lines in the spectrum given out when the Canalstrahlen are produced in hydrogen at a low pressure, show the Döppler effect, *i.e.* that the lines are displaced owing to the motion of their source; the velocity calculated from the displacement of the lines agrees well with the velocity of the Canalstrahlen calculated from the cathode fall of potential. Professor Hull, in some experiments recently made at the Cavendish Laboratory, found that this effect was very much more marked in hydrogen than in either helium or mercury vapour in which the effect, if it exists at all, is exceedingly small.

* Stark, *Phys. Zeits.* vi. p. 892, 1905.

CHAPTER XX.

RÖNTGEN RAYS.

346. RÖNTGEN found in 1895 that when the pressure in a discharge tube is so low that the walls of the tube are vividly phosphorescent, rays which are propagated in straight lines come from the tube; these rays illuminate a screen made of phosphorescent substance, and affect a photographic plate placed in their path. Röntgen showed too that these rays were not entirely stopped even by substances opaque to ordinary light, such as the flesh of the hand, and that if the hand is placed between the bulb and a phosphorescent screen, the shadow cast by the flesh is not so dark as that cast by the bones, and thus the shape of the latter can be distinguished. The rays which produce these effects are now called Röntgen rays. The character of the rays depends greatly upon the state of the tube in which they are produced; if the pressure in the tube is very low, so that the potential difference between its terminals is very large, the rays are much more penetrating than when the pressure of the gas is higher, and the potential difference between its electrodes smaller; very penetrating rays are sometimes called hard rays, the more easily absorbable rays, soft ones. We have already seen that even the rays emitted at any one time by the same tube are not all of one type (see p. 292).

A good many of the properties of the Röntgen rays have been already discussed in connection with the power they possess of ionising a gas through which they pass; we shall now consider the other properties of these rays.

Röntgen showed, and the observation has been confirmed by very many subsequent experimenters, that the rays are not bent

when going from one medium to another, and therefore that they suffer no deviation after passing through a solid prism.

We have seen (p. 308) that Röntgen rays when they strike against a solid, a liquid, or even a gas, generate secondary rays which in the case of impact against a solid or a liquid are of a much less penetrating character than the incident ones; the incidence of Röntgen rays on the surface of a solid will therefore give rise to radiation proceeding from the surface; by far the greater part of this 'reflected' radiation is diffuse, *i.e.* though the incident rays are all travelling in one direction, the 'reflected' rays will spread out in all directions. The question as to whether this 'diffuse return' of the rays, as Sir George Stokes called it, is accompanied by specular reflection, in other words, whether there is an excess of the reflected rays in the direction in which the angle of reflection is equal to the angle of incidence, is one on which observers disagree. Lord Blythswood* and Rood† have obtained photographs in which there is evidence of this effect; other observers have, however, been unable to detect it. The specular reflection must in any case be small, since the transparency of a powder is the same as that of the same bulk of material when solid, and the definition through it as good.

No evidence of any polarisation of the primary rays has been obtained; the opacity of two crystals of tourmaline or of herapathite, placed one on the top of the other, is the same when the axes of the crystals are crossed as when they are parallel.

The Röntgen rays increase the electrical conductivity of badly conducting liquids as well as of gases‡, they increase also the electric absorption of solids. Curie§ has lately shown that the rays from radium also produce the same effect on liquids.

Source of the Rays.

347. By taking photographs of a card pierced with pinholes, and drawing the lines joining the photograph of a hole with the hole itself, and finding their points of intersection, it has been

* Lord Blythswood, *Proc. Roy. Soc.* lix. p. 330, 1896.

† Rood, *Silliman's Journal*, [4], ii. p. 173, 1896.

‡ J. J. Thomson, *Nature*, lv. p. 606, 1897.

§ Curie, *Comptes Rendus*, cxxxiv. p. 420, 1902.

shown that the spot struck by the cathode rays is the place from which the Röntgen rays originate. Thus when the rays strike the walls of the tube, the phosphorescent part of the glass is the origin of the rays; when a 'focus tube,' *i.e.* one with a hollow cathode, and a plate of some infusible substance placed where the cathode rays converge, the part of the plate struck by the cathode rays is the source of the Röntgen rays. Campbell Swinton* has shown that cathode rays impinging normally on the plate are more effective in producing Röntgen rays than those which strike obliquely against the plate. The Röntgen rays produced when the cathode rays strike against a plane area come off approximately uniformly in all directions. This is shown by the following experiment: a hemispherical photographic film is placed so that its centre is at *C*, a point on a metal plate struck by cathode rays travelling in any direction; the Röntgen rays starting from the plate affect the film, and when the photograph is developed its intensity is found to be approximately uniform until we approach quite close to the line where the plane of the plate intersects the film. When the rays are produced by the impact of the cathode rays against the glass walls of the tube more rays appear to come out from any place normally than obliquely; this is, however, a secondary effect due to the absorption of the rays by the glass through which they have to pass; as the rays which come out obliquely have to pass through a greater thickness of glass than those which emerge normally they are more enfeebled by the absorption due to the glass.

Velocity of Propagation of Röntgen Rays.

348. Experiments to determine the velocity of the Röntgen rays have been made by Brunhes† and Blondlot‡. Marx§ has recently determined the velocity of the Röntgen rays by a method based on the following principle. Let *A* (Fig. 199) be a Röntgen ray bulb, having the terminal *K* attached to a vibrating electrical system with a known period, say a Lecher bridge; when *K* is cathode the anti-cathode *C* will emit Röntgen rays, and these

* Campbell Swinton, *Proc. Roy. Soc.* lxxiii. p. 432, 1898.

† Brunhes, *Comptes Rendus*, cxxx. p. 169, 1900.

‡ Blondlot, *Comptes Rendus*, cxxxv. p. 666, 1902.

§ Marx, *Ann. der Phys.* xx. p. 677, 1906.

rays when they fall upon a metal plate will, as we have seen, cause it to emit a stream of corpuscles; if the plate on which the rays fall is positively electrified the emission of these corpuscles will

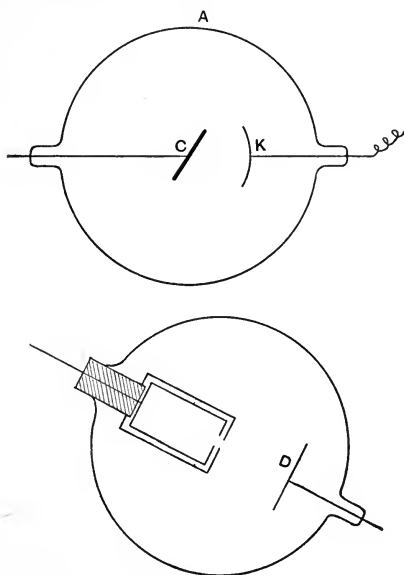

Fig. 199.

be retarded. *D* is a metal plate placed in the path of the rays coming from *C* and opposite to this plate there is a Faraday cylinder *F* connected with an electrometer which measures the negative charge received by the cylinder. *D* is connected with the same Lecher bridge arrangement as *K* so that there is a definite phase relation between their potentials. The negative charge received by the cylinder will be a maximum when *D* is negatively electrified when the Röntgen rays fall upon it, a minimum when *D* is positively electrified. To fix our ideas, suppose that *K* and *D* are always at the same potential, when *K* is a cathode Röntgen rays start from *C* and some time after fall upon *D*; in the time taken for the rays to travel from *C* to *D* the electrical system changes its phase and when the rays strike *B* it may be positively electrified and retard the emission of the corpuscles, if however the time taken by the rays to go from *C* to *D* is equal to, or a multiple of, the time of vibration of the electrical system then when the rays strike *D* it will be negatively

electrified and the negative charge received by the cylinder will be a maximum, hence if we adjust the distance between *C* and *D* so that the charge given to the electrometer in a given time is a maximum and if we know the time of vibration of the electrical system we can calculate the velocity of the Röntgen rays.

To carry out this method in practice many refinements are necessary for which we must refer to Marx's paper. The result of Marx's investigation is that the velocity of the Röntgen rays through air is equal to the velocity of light.

Diffraction of Röntgen Rays.

349. Many experiments have been made to test whether, as in the case of light, there are both inside and outside the boundary of the shadows cast by very small objects, variations in the intensity of the rays corresponding to the well-known diffraction fringes. Röntgen*, who investigated this point, was never able to satisfy himself that the effects he obtained were undoubtedly due to diffraction. Fomm† observed in the photograph of a narrow slit light and dark bands which looked like diffraction bands, but observations with different sized slits showed that this could not be their origin, and Haga and Wind‡ have explained them as contrast effects. These observers, who have made long-continued researches on this subject, have obtained with a narrow V-shaped slit, only a few thousandths of a millimetre broad at its widest point and made of platinum plates about half a millimetre thick, effects which would be produced by diffraction, and which have not been explained in any other way. The image of such a slit is shown on a greatly magnified scale in Fig. 200§: this diagram



Fig. 200.

* Röntgen, *Wied. Ann.* lxiv. p. 18, 1898.

† Fomm, *Wied. Ann.* lix. p. 350, 1896.

‡ Haga and Wind, *Wied. Ann.* lxxviii. p. 884, 1899.

§ Wind, *Physikalische Zeitschrift*, ii. p. 292, 1901.

represents one of the photographs with its vertical dimensions magnified two hundred times, while the horizontal dimensions are only doubled. The broadening of the narrow part of the shadow is the effect relied upon for showing the diffraction. To obtain a similar amount of broadening with light of a definite wave length, the length of the wave would have to be of the order 2×10^{-8} cm. If we regard the Röntgen rays as due to discontinuous pulses, this will be the order of the thickness of the pulse for the particular rays under consideration.

350. We have no evidence that the Röntgen rays suffer any deflection when passing through magnetic fields strong enough to produce very large deflections of cathode rays.

CHAPTER XXI.

PROPERTIES OF MOVING ELECTRIFIED BODIES.

351. As Röntgen rays are produced when the cathode rays strike against an obstacle, and as the cathode rays consist of negatively charged particles, it is of interest to examine the effects which are produced when the motion of a charged particle is suddenly stopped.

When a particle with a charge e of electricity is moving uniformly parallel to the axis of z with a velocity w , it produces at a point whose coordinates relative to the particle are x, y, z , a radial electric polarization equal to

$$\frac{e \cdot V}{4\pi (V^2 - w^2)^{\frac{1}{2}}} \left\{ \frac{x^2 + y^2 + z^2}{\left(x^2 + y^2 + \frac{V^2}{V^2 - w^2} z^2 \right)^{\frac{3}{2}}} \right\},$$

and a magnetic force whose components α, β, γ parallel to the axes of x, y, z respectively are given by the equations

$$\alpha = - \frac{eVw}{(V^2 - w^2)^{\frac{1}{2}}} \frac{y}{\left\{ x^2 + y^2 + \frac{V^2}{V^2 - w^2} z^2 \right\}^{\frac{3}{2}}},$$

$$\beta = \frac{eVw}{(V^2 - w^2)^{\frac{1}{2}}} \frac{x}{\left\{ x^2 + y^2 + \frac{V^2}{V^2 - w^2} z^2 \right\}^{\frac{3}{2}}},$$

$$\gamma = 0,$$

V being the velocity of propagation of electrodynamic disturbances through the medium surrounding the sphere (see *Recent Researches in Electricity and Magnetism*, pp. 18, 19).

When w the velocity with which the particle is moving is small compared with V , the radial electric polarization becomes

$$\frac{e}{4\pi} \frac{1}{\{x^2 + y^2 + z^2\}},$$

the same as when the particle is at rest; and the components of the magnetic force are given by

$$\alpha = -ew \frac{y}{(x^2 + y^2 + z^2)^{\frac{3}{2}}},$$

$$\beta = ew \frac{x}{(x^2 + y^2 + z^2)^{\frac{3}{2}}},$$

$$\gamma = 0.$$

352. In an electric field in which the components of the electric polarization are f, g, h , those of the magnetic induction a, b, c , there is mechanical momentum, the components U, V, W of which per unit volume are given by the equations

$$U = cg - bh,$$

$$V = ah - cf,$$

$$W = bf - ag$$

(see *Recent Researches*, p. 13).

Substituting the expressions we have given for the polarization and magnetic force due to the moving charged particle and integrating throughout the space outside a small sphere of radius a described round the electrified point, we find if P, Q, R are the components of the resultant momentum of the medium outside the sphere in this direction,

$$P = 0, \quad Q = 0,$$

$$R = \frac{1}{2} \frac{\mu e^2}{a} \frac{V^2}{(V^2 - w^2)^{\frac{1}{2}}} \left\{ \mathfrak{S} \left(1 - \frac{1}{4} \frac{V^2}{w^2} \right) + \frac{1}{2} \sin 2\mathfrak{S} \left(1 + \frac{1}{2} \frac{V^2}{w^2} \cos 2\mathfrak{S} \right) \right\} \dots\dots\dots(1),$$

where μ is the magnetic permeability of the medium and

$$\sin \mathfrak{S} = \frac{w}{V}$$

(see *Recent Researches*, p. 21); when w is small compared with V , the value of R reduces to

$$\frac{2}{3} \frac{\mu e^2}{a} w.$$

Thus if m' is the mass of the particle the momentum due to its motion is not $m'w$ but in virtue of the momentum in the electromagnetic field

$$m'w + R,$$

or when w is small

$$\left(m' + \frac{2}{3} \frac{\mu e^2}{a}\right) w.$$

Thus the particle will in this case behave as if its mass were increased by $\frac{2}{3} \frac{\mu e^2}{a}$.

353. In the general case when w is not small, let χ denote $m'w + R$ and suppose the particle is acted on by a magnetic force H at right angles to its direction of motion, the mechanical force acting upon the particle is Hew , hence if in the time δt the direction of motion is deflected through an angle $\delta\theta$ we have

$$\chi \delta\theta = Hew \delta t;$$

if δs be an element of the path, ρ its radius of curvature, then

$$\delta\theta = \frac{\delta s}{\rho} = \frac{w \delta t}{\rho},$$

hence

$$\rho = \frac{\chi}{He};$$

but if e/m is the ratio of the charge to the effective mass then

$$\rho = \frac{mw}{He},$$

hence

$$m = \frac{\chi}{w} = m' + \frac{R}{w}.$$

Now from the expression (1) for R we see that when w approaches V , R/w increases rapidly, hence if what we may call the electrical mass is comparable with the mechanical, we should expect m/e would vary with the velocity of the particle, increasing as the velocity increases. From the expression given for R we see that it is only with particles moving with velocities comparable with that of light that we could expect to get measurable

variations in the value of m/e ; happily particles travelling with these speeds are furnished by radium and the value of m/e for these rapidly moving molecules has been made the subject of a most interesting research by Kaufmann*.

354. The method used by Kaufmann is illustrated in Fig. 201.

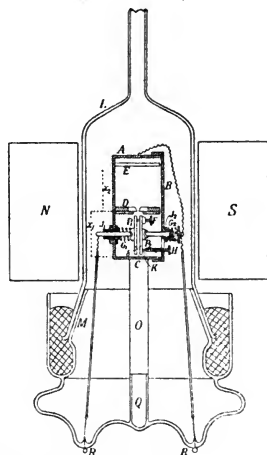

Fig. 201.

A small piece of radium was placed at C in a vessel from which the air was extracted, the radiations from the radium passed through a strong electric field in the space between the parallel plates P_1 , P_2 which were $\cdot 1525$ cm. apart and maintained at a potential difference of 6750 volts, they then passed through a small hole D in a diaphragm and then on to a photographic plate E ; during the whole of their journey from C to E the rays were under the influence of a magnetic field produced by the electromagnet NS ; the deflection due to the magnetic field was at right angles to that due to the electric. If the electric and magnetic fields were not in action all the rays from the radium would strike the photographic plate at the same point, when however the rays are exposed to the electric and magnetic fields the deflection will depend upon the velocity, so that the rays of different velocities will now strike the plate at different points and the impression produced by the radium on a plate will be a

* Kaufmann, *Göttingen Nach.* Nov. 8, 1901.

curved line; by measuring the photograph the deflection due to the magnetic field and also that due to the electric field can be found, and from these deflections (see Chap. V.) the values of v the velocity of the particles and the corresponding value of e/m can be found. Kaufmann found that when his plates were exposed for several days he got a clearly defined curve from which he deduced the following values of e/m and v .

$v \times 10^{-10}$	$e/m \times 10^{-7}$
2.83	.63
2.72	.77
2.59	.975
2.48	1.17
2.36	1.31

It is clear from these numbers that e/m diminishes as the velocity of the particle increases, so that if e remains the same the value of m increases with the velocity. As this increase must be due to the 'electrical mass' it follows that the electrical mass must be comparable with the mechanical mass. To find the proportion between the two, we must make some assumption as to the distribution of electricity on the corpuscle. Kaufmann assumed that the distribution was the same as if the corpuscle were a conducting sphere; the electrical field due to a moving conducting sphere has been solved in great detail by Searle*. On this supposition Kaufmann calculated from his experiments that the electrical mass of a slowly moving corpuscle was about $\frac{1}{3}$ of the mechanical mass. He points out that the proportion will depend upon the assumption made as to the distribution of electricity over the corpuscle whether for example the electrification is distributed over a spherical surface or throughout the volume of a sphere or over an ellipsoid, and in a later paper he shows that his experiments are consistent with the view that the whole of the mass is electrical.

There does not seem to me any reason for attributing electrical conductivity to the corpuscle itself, and if the charge on the corpuscle is the smallest charge that can exist it does not seem logical to make this charge up into smaller ones and find the

* Searle, *Phil. Mag.* v. 44, p. 340, 1897.

effect by integrating and I prefer to take another view of the electric field due to a corpuscle and to assume that it coincides with that part of the field, due to a point charge, which is outside a small sphere of radius a having the point charge for centre. On this supposition the electrical mass is R/w where R is given by equation (1), p. 651. Using this formula I have calculated, *on the supposition that the whole of the mass is electrical*, the ratios of the masses of the corpuscles moving with the velocities occurring in Kaufmann's experiments to the mass of a corpuscle moving with an exceedingly small velocity; the values of this ratio (ρ) are given in the following table, ρ' are the values observed by Kaufmann.

$v \times 10^{-10}$	ρ'	ρ
2.85	3.1	3.09
2.72	2.42	2.43
2.59	2.0	2.04
2.48	1.66	1.83
2.36	1.5	1.65

Thus the observed and calculated values of ρ do not differ by more than 10 per cent., suggesting that all the mass of the corpuscles is electrical in its origin. On this supposition the mass of a slowly moving corpuscle is $\frac{2}{3} \frac{\mu e^2}{a}$ or $m/e = \frac{2}{3} \mu e/a$, from the known values of m/e and e we find a to be about 10^{-13} cm. As the mass of a corpuscle has been seen to have an electrical origin the question naturally suggests itself whether the masses of all bodies may not have the same origin.

355. The phenomena we have described in the earlier part of the book show that corpuscles are a constituent of all bodies, so that part of the mass of these bodies is due to the corpuscles and is therefore electrical: it is easy to imagine a form of atom for which the whole mass would be electrical. For suppose that the atoms are made up of a large number of negatively electrified corpuscles each corpuscle being associated with its corresponding positive charge, and suppose that these positive charges are spread over a much greater volume than the corpuscles, the aggregation thus formed would consist of a distribution of positive electricity through

a sphere, the corpuscles being distributed through the sphere in such a way as to be in equilibrium under their own repulsions and the attractive force to the centre of the sphere arising from the positive electrification, in fact we should get an atom similar to that described by Lord Kelvin in his paper "Æpinus Atomized" (*Phil. Mag.* Mar. 1902). If the radius of the sphere occupied by the positive electrification is large compared with the radius of a corpuscle, it is easy to show that the mass of the atom will only differ slightly from the sum of the masses of the individual corpuscles considered as discrete systems. Thus in any aggregation or dissociation of a system of atoms the changes in the mass would, since the number of corpuscles remains unaltered, be exceedingly small in comparison with the whole mass of the atoms in any particular state. If however the whole of the mass were due to the corpuscles, the number of corpuscles in the atom would have to be much greater than the investigations of Arts. 161 and 192 show to be the case.

356. There is another point of view from which we may regard the question of electrical mass which may perhaps be most easily explained by considering the simple case of a moving charged particle. If a, b, c are the components of the magnetic induction, f, g, h those of the polarization, *i.e.* the number of Faraday tubes passing through unit area at right angles to their length, then (see *Recent Researches*, p. 13) the components of the momentum in the field are

$$cg - bh, \quad ah - cf, \quad bf - ag.$$

The magnetic field is due to the motion of the Faraday tubes, and if the charged point is moving parallel to the axis of z with a velocity w we have (see *Recent Researches*, p. 8)

$$a = -4\pi\mu wg,$$

$$b = 4\pi\mu wf,$$

$$c = 0,$$

where μ is the magnetic permeability of the medium through which the Faraday tubes are moving. Substituting these values for a, b, c in the expressions for the components of the momentum we find that these become

$$-4\pi\mu wfh, \quad -4\pi\mu wgh, \quad 4\pi\mu (f^2 + g^2 + h^2)w - 4\pi\mu h^2w.$$

Thus the resultant momentum is at right angles to the direction of the Faraday tube and is in the plane through the tube and the direction of motion of the particle; the magnitude of the resultant momentum is

$$4\pi\mu(f^2 + g^2 + h^2) w \sin \theta,$$

where θ is the angle between the Faraday tube and its direction of motion, thus $w \sin \theta$ is the velocity of the tube at right angles to its length. Hence we see that the momentum in the field is the same as would exist if the Faraday tubes carry with them when they move at right angles to themselves a mass of the ether equal per unit volume to $4\pi\mu(f^2 + g^2 + h^2)$, while when the tubes move parallel to their length they do not drag any ether along with them. The momentum in the field is the momentum of this bound ether. Thus on this view the electrical mass of a charged body represents the mass of the ether dragged along or imprisoned by the Faraday tubes associated with that body. I have discussed this point at greater length in *Electricity and Matter*.

Effect of suddenly stopping a moving charged particle.

357. The author gave an analytical investigation of this question in the *Philosophical Magazine* for Feb. 1897; the following geometrical treatment of the same problem is based upon the method of Faraday tubes. Let us consider the case of a charged point moving so slowly that the Faraday tubes are uniformly distributed, and suppose the point to be suddenly stopped, the effect of stopping the point will be that a pulse travels outwards from it with the velocity V , but as the Faraday tubes have inertia they will until the pulse reaches them go on moving uniformly with a velocity w parallel to the axis of z , *i.e.* they will continue in the same state of motion as before the stoppage of the point. Let us consider the behaviour of a tube which, at the moment of stopping the charge, had the position PQ , and consider the state of things after an interval t from the stoppage; a pulse whose thickness δ depends on the time taken to stop the particle will have travelled out to a distance Vt . In front of this pulse the motion of the tubes will not have been affected, *i.e.* they will have travelled parallel to themselves through a distance wt parallel to the axis of z ; behind the pulse the tube will have been brought to rest along the line it occupied when the point was stopped,

thus the portions behind and in front of the pulse will be represented by $ON, P'Q'$ in Fig. 202. Hence to preserve the continuity

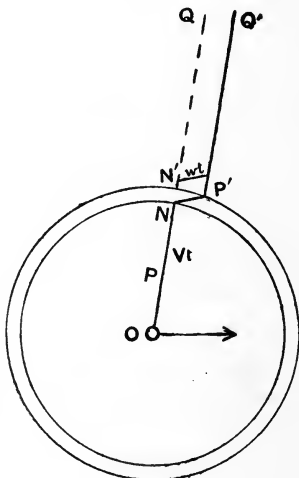

Fig. 202.

of the tube it must bend sharply round in the pulse itself, so that now the tube has a considerable tangential component. The stoppage of the point will thus produce a tangential component in the electric force which we proceed to calculate, supposing that the pulse is very thin so that the tube in it may be regarded as approximately straight. Then

$$\frac{\text{tangential electric polarization}}{\text{normal electric polarization}} = \frac{P'N}{N'N} = \frac{w \sin \theta t}{\delta} \dots\dots(1),$$

where t is the time which has elapsed since the stoppage of the particle and δ is the thickness of the pulse.

The right-hand diagram in Fig. 203 shows the configuration of the tube at the times when, if the particle had not been stopped, it would have been at o', o'', o''' .

Since the normal electric polarization at a distance r from the particle is equal to $e/4\pi r^2$, and, if V is the velocity of propagation of the disturbance, $Vt = r$, we have from (1)

$$\text{tangential electric polarization} = \frac{e}{4\pi r \delta} \frac{w \sin \theta}{V};$$

as this electric polarization is moving at right angles to itself

with a velocity V , it produces a magnetic force equal to $4\pi V$ times the polarization, *i.e.* to $\frac{e}{r\delta} w \sin \theta$, the direction of this force is at right angles both to the polarization and velocity of the

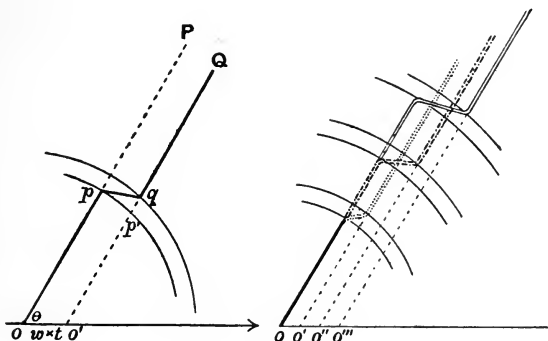

Fig. 203.

tubes; the force is thus in the direction opposite to the magnetic force before the particle was stopped. Hence in the pulse we have (1) a tangential electric polarization equal to $ew \sin \theta / 4\pi r \delta V$, and (2) a magnetic force equal to $ew \sin \theta / r \delta$; as these only vary inversely as the distance from the particle while the polarization and magnetic force before the particle was stopped varied inversely as the square of the distance, their magnitudes in the pulse will except in the immediate neighbourhood of the particle be very great compared with their values outside the pulse. Thus the stoppage of the charged particle is accompanied by the propagation outwards of a thin pulse of very intense electric and magnetic force; pulses produced in this way constitute, I believe, the Röntgen rays. It will be seen that on the Electromagnetic Theory of Light the pulses which we suppose to constitute the Röntgen rays are in many respects identical with waves of visible light; both consist of electric and magnetic forces at right angles to each other and to the direction of propagation; the difference between the Röntgen rays and a beam of sodium light is that the thickness of the Röntgen ray pulse is very small compared with the wave-length of sodium light, and that in the Röntgen rays there is not that regular periodic character occurring in a train of waves of constant wave-length. Sir George Stokes in

the Wilde Lecture given before the Manchester Philosophical Society showed that many of the differences between Röntgen rays and ordinary light, such for example as the absence of refraction, could be explained by the theory that the Röntgen rays consisted of pulses whose thickness was very small compared with the wave-length of visible light.

A very complete investigation of the diffraction of Röntgen rays from this point of view has been given by Sommerfeld*.

358. If H is the magnetic force in the pulse the energy per unit volume of the pulse is $\frac{\mu}{4\pi} H^2$ (half of this is due to the magnetic and half to the electric field); substituting the value given for H and integrating throughout the volume of the pulse we find that the energy in the pulse is

$$\frac{2}{3} \frac{\mu e^2 w^2}{\delta}.$$

Thus the amount of energy radiated away in the pulse varies inversely as the thickness of the pulse, and the thickness of the pulse depends upon the abruptness with which the particle is stopped; if the stoppage is very abrupt the pulse is thin, if it is gradual it is wide. The amount of energy radiated away in Röntgen rays bears to the energy in the field the ratio of $2a$ to δ , where a is the radius of the corpuscle (see p. 652). If δ is equal to $2a$ then all the energy (assuming that the mass of the particle arises wholly from electrical causes) will be radiated away; with thicker pulses only a portion of the energy is radiated, the rest is absorbed where the particle is stopped.

359. In the preceding investigation we have supposed that the velocity of the particle is small compared with the velocity of light, the same method will however apply when this limitation is removed.

Mr Searle has shown in this way that the tangential electric polarization is equal to

$$\frac{e}{4\pi r \delta} \frac{w \sin \theta}{V - w \cos \theta},$$

a result first obtained by Dr Heaviside by another method (*Electrician*, Oct. 11, 1901).

* Sommerfeld, *Physik. Zeit.* (1) p. 105, (2) p. 55, 1900.

360. When the particle moves with the velocity of light the electric and magnetic forces before the stoppage are confined to a plane through the centre of the sphere at right angles to its direction

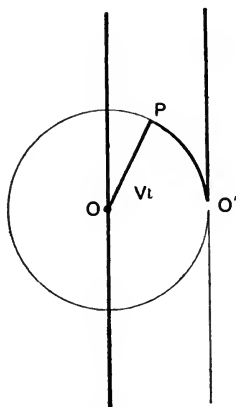

Fig. 204.

of motion. To find the effect at a time t after the stoppage of such a particle we apply the same principle as before, that outside a pulse whose radius is Vt the field is the same as if the particle had gone on moving uniformly with the velocity it had when stopped, and that between the charged particle and the pulse the distribution of Faraday tubes is uniform. Thus we shall find a deformation of the Faraday tubes such as is shown in Fig. 205; the plane of magnetic and electric force travels on as if the particle had not

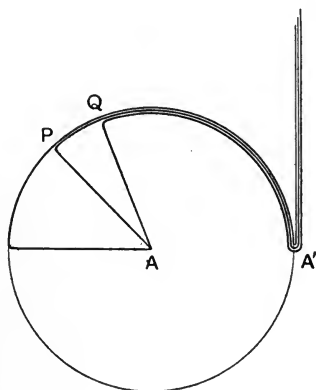

Fig. 205.

been stopped, since it always keeps just outside the sphere of radius Vt and there is in addition a spherical pulse formed by the parts joining the Faraday tubes inside the sphere to those outside.

361. To find the magnitude of the tangential polarization T we may proceed as follows. Consider an element of the pulse $ABCDEFGH$ formed by the intersection of two meridian planes $ABFE$, $DCGH$ inclined at an angle $\delta\phi$ and two cones $BCGF$, $ADHE$ whose semi-vertical angles are θ and $\theta + d\theta$ with the outer and inner spheres bounding the pulse, then since there is no free electricity inside this element the number of lines of force which leave the face $BCGF$ must equal the sum of the numbers entering the faces $ADEH$ and $EFGH$; hence if δ is the thickness of the pulse, T the tangential polarization, we have

$$\frac{d}{d\theta}(T\delta r \sin \theta d\phi) d\theta = \frac{e}{4\pi r^2} r d\theta r \sin \theta d\phi,$$

or
$$\frac{d}{d\theta}(T\delta r \sin \theta) = \frac{e}{4\pi} \sin \theta,$$

or
$$T = \frac{e}{4\pi r \delta} \frac{1 - \cos \theta}{\sin \theta},$$

and H the magnetic force in the spherical pulse is given by the equation

$$H = \frac{eV}{r\delta} \frac{1 - \cos \theta}{\sin \theta}.$$

Magnetic and Electric Forces due to the acceleration of charged particles.

362. In the investigation in Art. 357 we supposed that the particle was reduced to rest; exactly the same method will however give us the effects produced when smaller changes in the velocity of the particle occur and when the velocity of the particle is altered without being destroyed. We saw in Art. 357 that when a particle moving with a velocity w is reduced to rest, *i.e.* when a change w is produced in the velocity, a tangential electric polarization T and a tangential magnetic force H are produced which, at a distance r from the particle, are at the time r/V after stopping the particle given by the equations

$$T = \frac{ew \sin \theta}{4\pi r \delta V}, \quad H = \frac{ew \sin \theta}{r \delta};$$

if τ is the time taken to stop the particle, δ (the thickness of the pulse) is equal to $V\tau$, hence we may write

$$T = \frac{ew \sin \theta}{4\pi V^2 r \tau}, \quad H = \frac{ew \sin \theta}{r V \tau}.$$

If now the velocity of the particle instead of being diminished by w in the time τ is increased by δw in the same time, we can prove by exactly the same method that there will be a tangential electric polarization T' and a magnetic force H' given by the equations

$$T' = -\frac{e\delta w \sin \theta}{4\pi V^2 r \tau}, \quad H' = -\frac{e\delta w \sin \theta}{r V \tau};$$

since δw is the increase in the velocity in the time τ , $\delta w = f\tau$, where f is the acceleration of the particle; hence substituting this value for δw , we have

$$T' = -\frac{ef \sin \theta}{4\pi V^2 r}, \quad H' = -\frac{ef \sin \theta}{r V},$$

thus an accelerated charged particle produces in the surrounding field tangential, magnetic, and electric forces which vary inversely as the distance from the particle.

By Poynting's theorem the rate at which energy is flowing radially through unit area of surface is $V^2 T' H'$; integrating this expression over the surface of a sphere having its centre at the particle, we find that the rate at which energy crosses the surface is $\frac{2}{3} \frac{e^2 f^2}{V}$, a result given by Larmor (*Phil. Mag.* v. 44, p. 503, 1897).

363. The radiation of energy from the moving charged particle will modify its motion; thus supposing the particle to have the mass m and to be acted upon by a uniform force X , then if v is the velocity of the particle the kinetic energy is $\frac{1}{2}mv^2$ and the acceleration is $\frac{dv}{dt}$; suppose that in time δt the particle moves over a distance δx , the work done on the particle by the external force is $Xe\delta x$, this work must equal the increase in the kinetic energy plus the energy radiated away in time δt , hence

$$Xe\delta x = \delta(\frac{1}{2}mv^2) + \frac{2}{3} \frac{e^2}{V} \left(\frac{dv}{dt}\right)^2 \delta t,$$

or
$$Xev = mv \frac{dv}{dt} + \frac{2}{3} \frac{e^2}{V} \left(\frac{dv}{dt}\right)^2 \dots\dots\dots(1);$$

we see from this equation that if the particle starts from rest its acceleration is initially zero instead of Xe/m .

Solving equation (1), we find

$$t = \frac{2}{3} \frac{e^2}{V} \frac{1}{m} \left\{ \log \frac{Xe}{Xe - m \frac{dv}{dt}} + \frac{m \frac{dv}{dt}}{Xe - m \frac{dv}{dt}} \right\} \dots\dots\dots (2).$$

Thus if T is the time required for the acceleration to reach half its final value Xe/m , we have $T = \frac{2}{3} \frac{e^2}{V} \frac{1}{m} \{\log_e 2 + 1\}$.

The following are a series of corresponding values of $t / \frac{2}{3} \frac{e^2}{Vm}$ and $m \frac{dV}{dt} / Xe$.

$t / \frac{2}{3} \frac{e^2}{Vm}$	$m \frac{dV}{dt} / Xe$
0	0
·217	·1
·473	·2
·783	·3
1·177	·4
1·693	·5
2·416	·6
3·537	·7
5·611	·8
11·302	·9
∞	1·0

Thus, until a time comparable with e^2/Vm has elapsed, the acceleration of the particle and therefore the rate at which it is losing energy by radiation will be small compared with their final values; thus if a pulse of electric force passes over a charged particle a much smaller proportion of the energy in the pulse will be radiated away if the pulse is so thin that the time taken for it to pass over the particle is comparable with T than will be radiated from the thick pulses whose time of transit is much longer, for then the thin pulses will have much greater penetrating power than the thick ones. The expression given in Art. 161 for the coefficient of absorption of Röntgen rays only applies to the case when the pulse is so thick that the time taken for it to pass over a charged particle is large compared with e^2/mV , the coefficient of absorption for thinner pulses is much smaller.

INDEX.

The numbers refer to the pages.

- α rays 333, 355 et seq.
 - value of e/m for 356
 - penetrating power of 359
 - absorption of 361
 - theory of 370
 - range of 365
 - ionisation due to 367
 - positive electrification on 373
- Absorbed gas, emission of by hot wires 215
- Absorption of cathode rays 375
 - of α rays 361
 - theory of 370
 - of β rays 375 et seq.
 - of γ rays 405
 - of Röntgen rays 292, 301
 - of light, connection between and photo-electric effects 257, 258
 - of gas during discharge 552
- Actinium 350, 353
- Additive property, absorption of Röntgen rays an 305
 - ionisation produced by Röntgen rays an 300
 - cathode fall of potential an 538
 - minimum spark potential an 539
- After-glow in gases 626
- Aitken effect of dust on clouds 165, 215
- Alkali metals, conductivity of salts of 239
 - effect of cathode rays on 623
 - photo-electric effects of 251
- Allen, H. S., ions produced by secondary Röntgen radiation 315
- Allen and Rutherford, rate of escape of electricity through air 5
- Almy, discharge from fine wire 502, 504
 - effect of magnetic force on discharge 579
 - strength of solid dielectrics 460
- Alternating current, discharge of from point 509
 - through gas at very low pressure 580
- Anode fall of potential 558
- Arc, electric 604 et seq.
 - appearance of 605
- Arc, distribution of potential between terminals 610
 - exploring electrodes in 611
 - effect of pressure on potential difference 608
 - hissing 619
 - intermittence of 607
 - magnetic field effect on 620
 - potential difference in different gases 609
 - potential falls at anode and cathode 610
 - relation between potential difference, current, and length of arc 605 et seq.
 - temperature of 604
 - theory of 612
 - with terminals of different metals 607
- Arons, potential difference for arc in different gases 609
 - relation between potential difference and current in arc 608
- Arrhenius, conductivity of flames 232, 236
 - electrical wind 507
- Aurora Borealis 198
- Aselmann, electrification by bubbling through water 429
- Atmospheric electricity 3, 179
- Atom, number of corpuscles in 327, 381
- Atomic disintegration 353
- Atomic weight of radium 351
- Aurora Borealis 198
- Austin, emission of corpuscles by impact of positive ions with solids 486
- Austin and Holborn, disintegration of cathode 549
- Austin and Starke, reflection of cathode rays 400
 - velocity of reflected cathode rays 401
- Ayrton (Mrs), appearance of electric arc 605
 - hissing arc 619
 - potential drop at anode 611

- Ayrton (W. E.), relation between current and potential difference in arc 606
- β rays 334
 absorption of 375
 reflection of 390
- Baille, spark potential 436, 440, 466
 discharge in a non-uniform field 461
- Baker, effect of moisture on chemical combination 172
- Baly, striated discharge 565
- Baly and Ramsay, critical pressure in oxygen 543
- Barkla, scattering of Röntgen rays 308
 secondary Röntgen rays 321
 polarization of Röntgen rays 322
- Barus, electrification of a steam jet 163
 electrical conductivity due to phosphorus 423
- Battelli, critical pressure in oxygen 543
- Beattie, ionisation produced by heating salts 425
- Becker, ratio of charge to mass of a corpuscle 130
 effect of β rays on solids and liquids 331
 absorption of cathode rays 387
- Becquerel, ratio of charge to mass for negative ions from radium 140
 ratio of charge to mass for α rays from radium 357
 reflection of β rays 390
- Bemont, discovery of radium 350
- Benoist, ionisation of gas by Röntgen rays 293
 absorption of Röntgen rays 304
- Berliner, gases from incandescent solids 215
- Bidwell, electrical conductivity due to phosphorus 423
- Birkeland, effect of magnetic force on discharge 578
 magnetic spectrum of cathode rays 633
- Bloch, velocity of ions produced by chemical action 422
 ionisation produced by phosphorus 423
- Blondel, arc with terminals of different metals 608
- Blondlot, conductivity of hot air 188
 velocity of Röntgen rays 646
- Blyth, distribution of potential in spark discharge 464
- Blythwood (Lord), reflection of Röntgen rays 645
- Bohr, critical pressure in oxygen 543
- Bouty, spark potential 436, 467
 connection between spark potential and pressure 467
- Boys, leakage of electricity through air 2
- Bragg and Kleeman, absorption of α rays 361
- Branly, electrification by incandescent solids 191
- Braun, electrification by flames 231
 ionisation in explosive wave 229
- Breisig, photo-electric effects in different gases 269
- Brillouin, photo-electricity of ice 239
- Brooks (Miss), heat produced in sparks 520
- Brooks and Rutherford, molecular weight of radium emanation 352
- Brunhes, velocity of Röntgen rays 646
- Bubbling through water, electrification due to 427
- Buisson, effect of ultra-violet light on air 170
 photo-electric effect in gases 253
 velocity of negative ions due to ultra-violet light 260
- Bumstead, heat developed by Röntgen rays 320, 330
- Bumstead and Wheeler, molecular weight of radium emanation 352
- Burgess and Waidner, temperature of terminals in arc 605
- γ rays 405 et seq.
- Cady, thermal effects due to cathode rays 628
- Campbell, radio-activity of ordinary matter 414 et seq.
 ions produced by spark discharge 506
- Campbell and Wood, variation in ionisation inside a closed vessel 418
- Campbell Swinton, hollowness of pencil of cathode rays 637
 path of cathode rays 635
 production of Röntgen rays 646
 phosphorescence under cathode rays 623
 reflection of cathode rays 398
- Canalstrahlen 146, 639
 magnetic deflection of 640
 positive charge carried by 146, 641
 oxidation by 639
 luminosity produced by 642
- Cantor, relation of oxidation to photo-electric effects 289
- Capstick, cathode fall of potential 538
- Carey-Foster and Pryson, connection between spark potential and spark length 440
- Carr, spark potential 436, 441, 444, 445
 effect of material of electrodes on spark 437
- Cathode, current density at 539
 disintegration of 547
 distribution of potential near 535
 fall of potential 535

- Cathode, fall of potential depends on
 nature of cathode 536, 538
 on impurities in the gas 536
 effect of current on 542
- Cathode rays 621 et seq.
 absorption of 375
 emission of slow 373
 from uranium 384
 ionisation due to 383
 effect on salts of alkali metals 623
 reducing action of 624
 luminosity produced by 642
 mechanical effects due to 629
 thermal effects due to 627
 electric charge carried by 630
 mass of corpuscles in 117 et seq.
 reflection of 397
 magnetic spectrum of 633
 scattering of 404
 transmission of 375 et seq.
 velocity of reflected 401
 velocity after transmission 388
 repulsion of streams of 637
 determination of c/m for 117 et seq.
- Cavallo, ionisation by incandescent
 solids 188
- Characteristic curve for discharge 581
- Charge, electric, carried by an ion, de-
 termination of 150 et seq.
 electric, on ions 76
 determination of ratio of charge
 to mass of negative ion at low
 pressures 117 et seq.
 for corpuscles emitted by ra-
 dium 140
- Chattock, velocities of ions from point
 discharge 68 498
- Chemical action, effect of on steam jet 164
 electrification due to 420
 Canalstrahlen 639
 cathode rays 624
- Child, potential gradient in ionised gas 81
- Chrystal, connection between spark po-
 tential and spark length 440
- Clouds produced by chemical action 164
 formed round ions 150
 relative efficiency of positive and
 negative in producing 175
 produced by incandescent wires 215
- Clouds produced by gases liberated by
 electrolysis 421
- Cohésion diélectrique* 467
- Collie and Ramsay, discharge through
 helium 449
- Collision, ionisation by 270, 472 et seq.
 484
- Coloration of salts of alkali metals
 produced by cathode rays, 623
- Colson, nuclei from metals 172
- Condensation around positive and nega-
 tive ions 175, 176
- Conduction of electricity through air 1
 et seq.
- Conductivity of gases, properties of 9
 removed by filtering 11
 electric field 11
 various ways of producing 9
 relation between current and
 potential difference 13, 92
 air 1 et seq.
 air in caves and cellars 7
 air at first increases with time in
 a closed vessel 6
- Conductivity of flames 228 et seq.
 produced by bubbling through water
 427
- Conduction, effect of emission of cor-
 puscles on electric conduction
 through solids 207
- Constitution of sparks 520
- Constriction in tube, effect of on dis-
 charge 568
- Cook, actinic power of spark discharge 506
- Cooke, effect of screens on leak inside
 a closed vessel 6, 411
- Corpuscles,
 from hot wires 197
 from oxides 191, 201, 477
 given out by metals exposed to
 ultra-violet light 267
 given out by metals exposed to
 Canalstrahlen 485
 given out by radio-active substances
 139
 slowly moving 373
 number in an atom 327, 381
 in motion ionise a gas 270, 472
 et seq.
- Coulier, effect of dust on clouds 165
- Coulomb, leakage of electricity through
 air 1
- Critical spark length 440
 pressure for spark discharge, 445,
 492
- Crookes (Sir W.), insulation of a good
 vacuum 6
 dark space 487, 528
 disintegration of cathode 548
 striations 565
 cathode rays 622
 phosphorescence under cathode rays
 623
 mechanical effects due to cathode
 rays 629
 repulsion of cathodic streams 638
- Crowther, absorption of β rays 384
- Cunningham, absorption of nitrogen by
 carbon electrodes 552
- Curie (M. and Mme), discovery of radium
 349
 atomic weight of radium 351
 activity of radium 351
 character of radium radiation 351
 negative corpuscles given out by
 radium 139, 351
 radio-active gas from radium 351

- Curie (M. and Mme), induced radio-activity due to radium 351
ionisation due to uranium ionisation 336
- Curie (Mme), discovers polonium 350
absorption of rays from polonium 361
- Curie, effect of radium rays on conductivity of liquids 645
- Curie and Sagnac, negative electricity given out by plates exposed to Röntgen rays 316
- Current, connection with potential difference for discharge through a gas 13, 92
for discharge through flames 236
saturation 13
- Current, variation of, with potential difference for leak due to ultra-violet light 258
connection between, and spark potential for point discharge 502
current density at cathode 539
effect of, on cathode, fall of potential 542
- Currents, air caused by motions of ions 78
- Dark space, Crookes' 487, 528
thickness of 542
connection with mean free path of molecules of the gas 546
relation of to current 547
theory of 590
Faraday's 488
- Debiere, actinium 350, 352
- Demarcay, spectrum of radium 350
- Des Coudres, velocity of cathode rays 131
after transmission through metal plates 390
 e/m for α rays from radium 357
- Dewar, heat produced by spark 520
- Diffraction of Röntgen rays 648
- Diffusion of ions 30
coefficients of 37
of gases 40
- Dike, variation in induced radio-activity 418
- Discharge from points 498
- Discharge, electric, through gas at low pressure 488, 528 et seq.
theory of 585 et seq.
- Discharge, striations in 564
- Disintegration of cathode 547
- Disintegration of incandescent wires 215
- Distance between striations 565
- Döppler effect with Canalstrahlen 643
- Dorn, negative ions given out by plate exposed to Röntgen rays 316
velocity of corpuscles in secondary Röntgen radiation 317
heat produced by Röntgen rays 330
- Drops, electrification of 173
- Duddell and Marchant, arc with terminals of different metals 608
- Dufay, ionisation by incandescent solids 188
- Duncan, Rowland, and Todd, effect of pressure on potential difference in the arc 608
- Durack, ionisation by rapidly moving corpuscles 477
- Duration of conductivity of gases 10, 18
- Dust, effect of on rate of leak through gases 7
on rate of recombination of ions 19
on clouds 165
- Du Tour, ionisation by incandescent solids 188
- Earhart, spark potential for very short sparks 455
- Ebert, escape of electricity at high altitudes 4
thickness of dark space 542
- Ebert and E. Wiedemann, effect of ultra-violet light on sparks 432
thermal effects due to cathode rays 628
discharge at low pressures by rapidly alternating currents 580
repulsion of cathode streams 638
- Edison effect 195
- Edlund, relation between potential difference and current in arc discharge 606
- Eichberg and Kallir, arc with terminals of different metals 608
- Electric field, effect of on conductivity of gases 11
force, distribution of, in discharge 530
in Crookes' dark space 540
in Faraday dark space 553
positive column 555
in flames 232
- Electric discharge through gases at low pressures 488, 528 et seq.
theory of 585 et seq.
- Electrical wind, 507
- Electricity, one fluid theory of 161
effect of on steam jet 163, 164
- Electrification of gases liberated by electrolysis 421
due to bubbling through water 173, 427
due to chemical action 420
effect of on condensation of drops 185
- Electrodeless discharge
glow produced by 626
effect of magnetic force on 577
- Electrolysis, charge on gas liberated by 421

- Electrolytic gas, clouds produced by 421
- Elster and Geitel, leakage of electricity through open air 3
 air in caves and cellars 7
 ionic theory of atmospheric electricity 179
 ionisation by incandescent solids 188 et seq.
 ionisation produced by phosphorus 423
 gases from incandescent solids 215
 effect of magnet on leak from hot wire 222
 photo-electric effects 250, 257
 effect of plane of polarisation on 279
 temperature on 283
 radio-activity of air absorbed in the ground 412
- Emanation from thorium 337
 density of 352
- Emanation from radium 351
 density of 352
- Emanium 353
- Energy in Röntgen rays 328
- Enright, electrification from chemical action 420
- Entladungstrahlen 602
- Erman, electrification by flames 231
- Eve, reflection of cathode rays 390
 ionisation by Röntgen rays 299
- Ewers, thermal effects due to cathode rays 628
 positive charge carried by Canalstrahlen 641
 point discharge 500, 501, 513
- Exner and Haschek, pressure in sparks 519
- Faraday, influence of successive sparks 431
 dissymmetry of discharge 466
 dark space 488, 553
- Fatigue in discharge by ultra-violet light 263, 287
- Filtering, effect of on conduction through gases 11
- Flames, source of ionisation in 234
 conductivity of 228
 velocity of ions in 240
 ionisation in gases from 228 et seq.
 distribution of electrification in 232
 effect of electric field on 230
 theory of discharge through 95
- Fleming, Edison effect 195
 exploding electrode in arc 611
 theory of arc 612
- Fluid theory of electricity 161
- Fluorescence, connection of with photo-electric effects 289
- Fomm, diffraction of Röntgen rays 648
- Force, electric distribution of in discharge tube 530
- Force, in positive column 555
 in Faraday dark space 553
- Foster (Carey-), connection between spark potential and spark length 440
- Free-path, connection of with critical spark length 450, 469
 with electric force in discharge 490, 497
 thickness of dark space 546
- Fröhlich, relation between potential difference and current in arc 605
- Galt, electrification due to bubbling 428
- Garrett and Willows, ionisation produced by heating salts 425
- Gases, rates of normal leak through different gases 6
 given out by incandescent solids 215
 photo-electric properties of 252
 current through hot 224
- Gates (Miss), ionisation produced by hydration of quinine sulphate 425
- Gehrcke, velocity of reflected cathode rays 401
- Geitel, rate of leak from a charged body in air 4
- Geitel and Elster, see Elster and Geitel
- Giese, electrification by flames 228, 232
- Giesel, Emanium 352
- Godlewski, absorption of β rays 384
- Goldstein, effect of temperature on cathode fall of potential 536
 distance between striations 565
 effect of constriction in tube on discharge 568
 magnetic force on striations 576
 similarity between striations and effects at cathode 597
 cathode rays 622
 effect of on salts of alkali metals 623
 reflection of 398
 phosphorescent patterns produced by 635
 repulsion of cathodic streams 637
 Canalstrahlen 639
 spectrum due to 642
- Gorton and Warburg, point discharge 500
- Graham, distribution of electric force in discharge tube 530
 near cathode 541
 in Faraday dark space 553
 positive column 555
- Granqvist, disintegration of cathode 547
- Gross and Shephard, relation between potential difference and current in arc 607
- Guthrie, ionisation by incandescent solids 188
- Haga and Wind, diffraction of Röntgen rays 648

- Hall-effect in gases 244 et seq.
 in discharge tube 562
- Hallwachs, photo-electric effects 250, 257
 photo-electric fatigue 288
- Hankel, electrification by flames 231
- Harnuzescu, ionisation of gases by
 Röntgen rays 293
- Harvey and Hird, discharge of alternating current from a point 509
- Haschek and Mache, pressure in spark 518
 and Exner, pressure in spark 519
- Heat produced by spark 519
 Röntgen rays 320, 330
 cathode rays 627
 effect of on cathode fall of potential 536
- Helium, spark potential in 448
 discharge through 449, 469
 viscosity of 450
- Helmholtz (R. von), effect of electricity on a steam jet 163
 and Richarz, electrification of steam jet 164
 formation of clouds by chemical action 164
- Hemsalech and Schuster, constitution of sparks 520
- Henry, phosphorescence of sulphide of zinc 332
- Henry (J.), photo-electric effect of gases 253
- Hertz, photo-electric effects 250
 effect of ultra-violet light on spark 432
 explosive wave in spark 518
 penetration of thin metal by cathode rays 622
- Herwig, electrification by flames 231
- Herz, distribution of electric force in discharge 530
 in the positive column 555
- Heuse, electric force in positive column 555
- Heydwiller, heat produced by sparks 520
- Himstedt, discharge of alternating current from a point 509
 alternating currents through gases at low pressures 580
- Hird and Harvey, discharge of alternating current from a point 509
- Hissing arc 619
- Hittorf, leakage of electricity through air 2
 effect of salts on conductivity of flames 210
 electrification by flames 231
 difficulty of producing short sparks 443
 distribution of electric force in discharge 530
 cathode full of potential 535, 536
- Hittorf, electric force in Faraday dark space 553
 positive column 555
 temperature in discharge tube 570
 action of magnet on distribution of glow over cathode 574
 cathode rays 621
- Hobbs, potential difference required to produce short sparks 457, 458
- Hoerbürger, effect of pressure on arc 609
- Hoffmann, Entladungstrahlen 602
- Holborn and Austin, disintegration of cathode 549
- Holmgren, electrification by shaking wet cloth 173
- Holtz, electrification by flames 230
- Hoor, photo-electric effects 250
 influence of temperature on 283
- Horton, effect of emission of corpuscles on electrical conductivity 207
- Hot gases, leak of electricity through 224
- Huff, *e/m* for α rays from polonium 359
- Hull Döppler, effect in Canalstrahlen 643
- Humphreys, effect of pressure on spectrum 519
- Hurst, ionisation by collision of positive ions 486
- Hydration, ionisation produced by 425
- Hydrogen, effect of on emission of corpuscles from hot wires 202
- Impurities in gas, effect of on point discharge 506
- Incandescent solids, ratio of charge to mass of corpuscles produced by 139
 solids, ratio of charge to mass for positive ions produced by 149
 ionisation by 188 et seq.
 corpuscles emitted by 194
 positive ions produced by 213
 nature of positive ions given out by 217
 gases given out by 215
- Induced radio-activity from thorium emanation 340
 duration of 342
 time taken to produce 343
 penetrating power of 344
 due to radium 351
 rate of decay of 352
- Intermittence of arc discharge 607
- Ionisation by incandescent solids 188 et seq.
 by collision of corpuscles 270, 472 et seq.
 by collision of positive ions 274, 284
 by Röntgen rays 293
 variation of with temperature 294

- Ionisation by Röntgen rays, variation of
 pressure 293
 in different gases 298, 304
 an additive property 300
 by cathode rays 387
 by α rays in different gases 369
 by β rays in different gases 381
 by ultra-violet light 250
 in explosive wave 229
 by chemical action 420
 by phosphorus 423
 by quinine sulphate 425
 by heating salts 425
- Ions 12
 explain conductivity of gases 14
 theory of conduction through air
 by 14
 rate of recombination of 19
 rate of diffusion of 30
 size of 27, 41, 73
 velocity of 42-73
 difference of velocities of positive
 and negative 48 et seq.
 velocity of in flames 60, 240
 salt vapours 240
 point discharge 68
 charge on 76, 150 et seq.
 mathematical theory of conduction
 by 84
 motion of in magnetic field 104-116
 motion of under both electric and
 magnetic forces 111
 ratio of mass to charge for negative
 in cathode rays 117 et seq.
 ratio of mass to charge for negative
 produced by ultra-violet light 135
 incandescent wire 139
 radio-active substances 139
 positive ratio of charge to mass 149
 given out by radium 355
 in Canalstrahlen 147
 by incandescent ions 148
 positive produced by hot wire 213,
 217
 work required to produce 202, 307
 condensation round 166
 number of, produced by secondary
 Röntgen radiation 315
 negative given out by metals ex-
 posed to Röntgen rays 316
 number of in various parts of dis-
 charge 559
- Jaffe, leak in $\text{Ni}(\text{CO})_4$ 6
- Jaumann, effect of rapid variations in
 potential on spark 434
- Johnson, effect of rapid variations in
 potential on spark 435
- Kalähne, ionisation produced by quinine
 sulphate 425
- Kallir and Eichberg, arc with terminals
 of different metals 608
- Kaufmann, ratio of mass to charge of
 ion 122, 128
 characteristic curve 583
 heat produced by discharge 520
 scattering of cathode rays 404
 effect of velocity on mass of cor-
 puscle 653
 electric force in positive column 555
- Kelvin (Lord), electrification by shaking
 mercury 173
 effect of surface tension on forma-
 tion of clouds 179
 negative electrification due to bub-
 bling 427, 428
 spark potential 444
- Kiessling, effect of dust on clouds 165
- Kinsley, potential required to produce
 short sparks 457
- Kirkby and Townsend, ionisation by
 collision 475
- Knoblauch, photo-electric effects 252
 relation of oxidation to 289
- Kosters, electrification due to bubbling
 421, 428
- Kreusler, photo-electric current through
 gases 262
 photo-electric fatigue 288
- Laby, ionisation in different gases by
 Röntgen rays 304
 ionisation in different gases by α
 rays 369
- Ladenburg, action of ultra-violet light
 275-279
 photo-electric fatigue 288
- Lag of electric spark 432 et seq.
- Lang (v.), relation between potential dif-
 ference and current in arc 607
- Langevin, recombination of ions 21, 71
 velocity of ions 64
 secondary Röntgen rays 315
 ionisation produced by 304
- Laplace, electrification due to chemical
 action 420
- Larmor, radiation from an ion 663
- Lavoisier, electrification due to chemical
 action 420
- Leakage of electricity through air 1 et seq.
 in closed vessels 4
- Le Bon, ionisation produced by hydration
 425
- Lecher, intermittence of arc 607
- Lehmann, appearance of short sparks 442
 effect of constriction on discharge
 568
 action of magnet on discharge 574
 similarity between striations and
 effects at the cathode 597
- Leithausers, velocity of cathode rays
 after transmission through metals
 375, 388
- Lenard, ratio of mass to charge of ion
 in Lenard rays 123, 124

- Lenard, ratio of mass to charge of ion in cathode rays produced by ultra-violet light 137
 effect of ultra-violet light on gases 171
 electrification by splashing 173, 427
 photo-electric effects in gases 253
 effect of pressure on photo-electric leak 263
 absorption of Lenard rays 381
 transmission of cathode rays 381, 383
 velocity of corpuscles emitted when metals are exposed to ultra-violet light 275
 photo-electric fatigue 288
 reflection of cathode rays 403
 Lenard and Wolff, clouds formed by ultra-violet light 164
 Length of spark, relation of to spark potential 436
 Liebig, spark potential 436, 439, 466
 Linss, leakage of electricity through air 3
 Luggin, relation between potential difference and current in arc 607
 potential drop at anode and cathode in arc discharge 611
 Luminosity due to Canalstrahlen 642
 cathode rays 642
 in electric discharge 481, 588
 Lyman, cathode fall of potential 536

 McClean, electrification due to bubbling through water 428
 McClelland, velocity of ions in flames 60, 229
 recombination of ions 17
 ions produced by incandescent wires 91, 210
 ionisation by positive ions 221, 484
 reflection of β rays 390
 absorption of γ rays 409
 McClelland and J. J. Thomson, absorption of Röntgen rays 292
 McClennan, discharge produced by bodies after exposure to cathode rays 627
 existence of penetrating radiation 410
 McClennan and Burton, effect of walls of vessel on leak 411
 McClung, recombination of ions 17
 effect of pressure on rate of recombination of ions 20
 effect of temperature on the rate of recombination of ions 23
 effect of temperature on the ionisation of a gas 294
 ionisation by Röntgen rays 299
 McClung and Rutherford, absorption of Röntgen rays 303
 energy in Röntgen rays 330

 Mache and Haschek, pressure in spark 518
 Mackenzie, e/m for positive ions from radium 149, 357
 Magna, heat produced by electric discharge 520
 Magnetic deflection of rays from radium 140
 Magnetic field, effect of on leak from hot wire 221
 effect of on lag of spark 434
 spark 522
 arc 620
 discharge in vacuum tubes 572 et seq., 600
 on distribution of glow on cathode 574
 on negative glow 572
 on positive column 575
 on striations 575
 motion of ions 104
 theory of effect on discharge 600
 spectrum of cathode rays 633
 Makover, effect of pressure on induced radio-activity 348
 molecular weight of radium and thorium emanation 351
 Marchant and Duddell, arc with terminals of different metals 608
 Marx, distribution of temperature in discharge through hot gases 226
 transverse velocity of ions in magnetic field 244
 conduction through flames 232
 velocity of ions in flames 243
 velocity of Röntgen rays 646
 Mass of a corpuscle 160
 effect of velocity on 653
 Matteucci, leakage of electricity through air 2
 conductivity due to phosphorus 423
 Matthies, electric force in positive column 555
 cathode fall in compound gases 538
 anode fall in compound gases 559
 Meissner, formation of clouds 164, 422
 pressure in spark 516
 Merritt, velocity of reflected cathode rays 401
 Metals, nuclei from 172
 non-arcing 608
 Mey, cathode fall of potential 536, 538
 Mie, relation between current and potential in ionised gas 94
 Minimum potential for point discharge 498
 spark discharge 444, 450
 Mixtures, secondary radiation from 395
 absorption by 305, 385
 Möhler, pressure in spark 519
 Moisture, effect of, on sparks 431
 lag of sparks 432

- Moisture, effect of, on cathode fall 536
Molecular weight of radium emanation 351
 thorium emanation 351
Molecules, number of in cubic centimetre of gas 77, 160
Moreau, velocity of ions in flames 75, 244
 conduction through flames 232
Motion of ion under magnetic force 104-116
 and electric forces 111
Moulton and Spottiswoode, effect of magnetic force on striations 575
 similarity between effects at cathode and striations 597
Müller and De la Rue, effect of nature of electrodes on spark potential 437
 discharge between pointed electrodes 462
 dissymmetry of discharge 466
 pressure in spark 516
 striated discharge 529, 564
Nabl, effect of pressure on rate of recombination of ions 20
Naccari, conductivity due to phosphorus 423
 heat produced by sparks 520
Naccari and Bellati, heat produced by sparks 520
Nahrwold, leakage of electricity through air 2
 gases from incandescent solids 215
Narr, leakage of electricity through air 2
Natterer, spark length in different gases 470
Nebel, relation between potential difference and current in arc 607
Neesen and Paalzow, effect of magnetic field on discharge 576
Negative ions, velocity of 58
 condensation round 175, 186
Negative glow 488
 action of magnet on 572
Neureneuf, electrification in flames 230
Newall, electrodeless discharge 543
 after-glow in gases 626
Niepce de St Victor, photographic effect of uranium nitrate 333
Nitrogen, spark potential in 448
Non-arcing metals 608
Number of molecules in a cubic centimetre of gas 77, 160
Obermayer, discharge from a point 505
Orgler, spark potential 436, 466
Owen, formation of clouds 216
 emission of positive ions 213
 value of e/m for corpuscles from a Nernst filament 139
 emission of corpuscles from Nernst filaments 201
Owens, radio-activity of thorium 337
Oxidation by Canalstrahlen 639
 connection of with photo-electric effects 289
Oxides, electrification from incandescent 191, 201, 477
Paalzow, heat produced by spark 520
Paalzow and Neesen, effect of magnetic force on discharge 576
Paschen, spark potential 436, 466
 discharge in a non-uniform field 461
Paschen's law 451 et seq.
Peace, potential required to produce sparks 436
 effect of material of electrode on spark potential 437
Perrin, effect of pressure on ionisation by Röntgen rays 293
 temperature on ionisation by Röntgen rays 294
 ionisation of different gases by Röntgen rays 298
 secondary Röntgen radiation 308
 electric charge carried by cathode rays 630
Pettinelli and Marolli, discharge from hot electrodes 226
Peukert, relation between potential difference and current in the arc 607
Phosphorescence 332
 and photo-electric effects 289
 caused by cathode rays 622
Phosphorus, conductivity due to 423
Photo-electric effects 250 et seq.
 duration of 287
 effect of gas films on 276
 influence of temperature on 283
 influence of plane of polarisation on 279, 283
 connection with phosphorescence and ionisation 289
 connection with oxidation 289
 fatigue 287
 properties of gases 252
Plücker, action of magnet on discharge 572
 discovered cathode rays 621
Poggendorff, heat produced by spark 520
Point discharge 498 et seq.
 velocity of ions from 68, 498
 connection between spark potential and current 501
 effect of impurities on 506
 with alternating currents 509
 theory of 510
Polarisation of light, effect of plane of on photo-electric effects 279, 283
Polonium 350, 352
Positive column 555
 effect of magnet on 575
Positive ions, velocity of 58

- Positive ions, ratio of charge to mass 146, 149
 near hot wire 213, 217
 from ultra-violet light 253
 from radium 149
 ionisation by 274, 284
 rays 642
- Potential, distribution of in spark discharge 464
 in ionised gas 81
 near hot electrode 225
 minimum spark potential 444, 450
 cathode fall of 535
 anode fall of 558
- Pouillet, electrification by flames 230
 chemical action 420
- Precht, effect of magnetic force on spark 522
 point discharge 499
 effect on point 504
- Precht and Runge, atomic weight of radium 351
- Preece (Sir W.), Edison effect 195
- Pressure, effect of, on leak through air 6
 on rate of recombination of ions 20
 on ionisation by Röntgen rays 293
 ultra-violet light discharge 263
 spark potential 444 et seq.
 critical pressure for sparks 445, 497
 potential difference in arc 609
 potential gradient in positive column 556
 in spark 516
- Priestley, ionisation by incandescent solids 188
- Pringsheim, relation between current and potential difference in an ionised gas 101
 effect of moisture on chemical combination 172
 discharge through hot gases 211
- Przibram, condensation on ions 187
- Puluz, mechanical effects due to cathode rays 629
- Quinine sulphate, ionisation due to 425
- Radiation α and β from radio-active substance 333
- Radiation from an ion 663
 from ordinary materials 410 et seq.
- Radio-active emanations 337, 351, 353,
 gas in water 412
- Radio-activity of uranium 332
 thorium 336
 radium 349
 polonium 352
 actinium 353
 emanium 353
 of ordinary matter 410
- Radio-activity, induced 340
 duration of 342
 time taken to develop 343
 penetrating power of 344
- Radium, positive ions given out by 355
 discovery of 349 et seq.
 spectrum of 351
 atomic weight of 351
 types of radiation given out by 351
 radiation, absorption of 367
 emanation 352
 persistence of emanation 352
 radiation, effect of on liquids 645
- Ramsay and Baly, critical pressure of oxygen 543
- Ramsay and Collie, discharge through helium 449
- Ratio of charge to mass for corpuscles 117 et seq.
 positive ions 146, 149, 355
- Ratio of velocities of positive and negative ions 48-58
- Rayleigh (Lord), viscosity of helium 450
 critical pressure of oxygen 543
- Recombination of ions 15
 rate of 17, 20, 23, 71
 affected by dust 19
 theory of 24
- Reflection of cathode rays 390
 β rays 390
 Röntgen rays 645
- Reiger, value of e/m for corpuscles 139
- Reinold and Rücker on surface tension 183
- Reiss, heat produced by sparks 519
- Repulsion of cathode rays 637
- Richardson, ionisation from incandescent solids 194
 emission of positive ions from hot wires 213
- Richarz, condensation produced by Röntgen rays 165
- Richarz and Helmholtz, effect of electrification and chemical action on a steam jet 163, 164
- Riecke, absorption of gas in discharge tube 552
 characteristic curves 584
- Righi, photo-electric effects 250
 effect of temperature on 283
 ionisation of gases by Röntgen rays 293
 ionisation in closed vessels 411
 effect of material of electrode on spark potential 437
- Ritter, spark potential in different gases 470
- Robb, connection between current and potential difference in an ionised gas 95
- Rollman, heat produced by spark 520
- Röntgen rays 291, 644 et seq.
 absorption of 292, 301, 304
 ionisation of gases by 293, 298

- Röntgen rays, ionisation of gases, effects of pressure and temperature on 293, 294
 effect on steam jet 165
 clouds 168
 secondary 308 et seq. 394
 in air 309
 tertiary 330
 reflection of 645
 source of 645
 theory of 659
 velocity of 646
 diffraction of 648
 effect on solids and liquids 331, 645
- Röntgen (v.), connection between electric strength and mean free path 469
 point discharge 498, 499
- Rood, reflection of Röntgen rays 645
- Rowland, Duncan, and Todd, effect of pressure on potential difference in arc discharge 608
- Rücker and Reinold, on surface tension 183
- Rue (De la) and Müller, effect of material of electrode on spark potential 437
 sparks between pointed electrodes 462
 dissymmetry of electric discharge 466
 pressure in sparks 516
 striated discharge 529, 564
- Runge and Precht, atomic weight of radium 351
- Russell (A.), maximum electric intensity in spark 464
- Russell (W. J.), nuclei from metals 172
- Rutherford, velocity of ions 43, 47, 58, 61
 current from incandescent wire 209, 221
 recombination of ions 17, 19
 connection between current and potential difference 101
 effect of ether on velocity of negative ions 42
 ionisation of different gases by Röntgen rays 298
 absorption of Röntgen rays 301
 of uranium radiation 333
 of β rays 380
 ionisation due to uranium radiation 333, 336, 368
 positive ions given out by radium 149, 355, 374
 radio-activity of thorium 337
 emanation from thorium 337
 induced radio-activity from thorium 340
 properties of 343
 penetrating power of 344
 velocity of positive ions producing induced radio-activity 345
 penetrating power of α radiation 359
 absorption of γ rays 409
- Rutherford and Allen, rate of leak of electricity through air 5
- Rutherford and Miss Brooks, molecular weight of radium emanations 352
- Rutherford and Cooke, effect of walls of vessel on leak 6, 410
 effect of screens on rate of leak 6
- Rutherford and McClung, absorption of Röntgen rays 303
 energy in Röntgen rays 330
- Rutherford and Soddy, atomic disintegration 353
- Sagnac, secondary Röntgen rays 308
 tertiary Röntgen rays 330
- Sagnac and Curie, negative ions given out by plate exposed to Röntgen rays 316
- Salt vapours, conductivity of 236 et seq.
 maximum current carried by 249
- Saturation current 13
- Scattering of cathode rays 404
- Schenck, constitution of spark 522
- Schmidt, photo-electric effects 252
 relation of fluorescence and ionisation to photo-electric effects 289
 radio-activity of thorium 336
 oxidation by Canalstrahlen 639
 ionisation produced by phosphorus 423
- Schmidt and E. Wiedemann, coloration produced by cathode rays 624
- Schuster, ratio of charge to mass of an ion 127
 shadow thrown on cathode 490
 discharge in a non-uniform field 462
 thickness of Crookes dark space 529
 distribution of potential near cathode 540
 influence of current on dark space 547
 action of magnet on distribution of glow over cathode 574
- Schuster and Hemsalech, constitution of sparks 520
- Schweidler (v.), current and potential difference curve 13
 discharge by ultra-violet light 260, 261
 effect of pressure on 263, 266
 photo-electric fatigue 288
- Secondary Röntgen rays 308, 394
 theory of 321
- Seitz, transmission of cathode rays 375, 382
 ratio of charge to mass of a corpuscle 130
- Shadow on cathode 490
- Shephard and Gross, relation between potential difference and current in arc 607
- Sieveking, point discharge 498
- Simon, ratio of charge to mass of corpuscle 128
- Simpson, variation in induced radio-activity 418

- Skinner, distribution of electric force
 along discharge 530
 near cathode 541
 in Faraday dark space 553
 anode fall of potential 558
 emission of hydrogen from cathode
 550
 absorption of gas during discharge
 552
- Smithells, Dawson, and Wilson, conductivity of salt vapours 240
- Soddy and Rutherford, atomic disintegration 353
- Sodium emission of corpuscles from 203, 205
- Sodium and potassium alloy, absorption of gases by 553
- Sommerfeld, diffraction of Röntgen rays 660
- Source of Röntgen rays 645
- Spark discharge 430 et seq.
 effect of moisture of 431
 lag of 432
 influence of ultra-violet light on 433
 effect of rapid changes in potential on 434
 theory of 471, 490
- Spark length, critical 440
- Spark potential 436 et seq.
 effect of material of electrode on 437
 connection with spark length 439 et seq.
 pressure 444 et seq.
 minimum 444
 in a non-uniform field 450, 461
 for very short sparks 455 et seq.
 tables of 524 et seq.
- Sparks, pressure in 516
 heat produced by 519
 constitution of 520
 very short 455 et seq.
 through solids 460
 effect of magnetic field on 522
- Spectrum of radium 350
- Spottiswoode and Moulton, effect of magnetic force on striation 575
 similarity between striations and effects at cathode 597
- Stark, cathode fall of potential 542
 Döppler effect with Canalstrahlen 643
 Conduction through flames 232
- Starke, reflection of cathode rays 399
 conduction through flames 232
 pressure due to cathode rays 630
- Starke and Austin, reflection of cathode rays 400
- Steam jet, effect of electricity on 163
 incandescent wire on 164
 chemical action on 164
 Röntgen rays on 165
- Stewart, gases from incandescent solids 215
- Stokes (Sir G. G.), motion of an ion in magnetic field 107
 velocity of falling drop 150
 theory of Röntgen rays 659
- Stoletow, photo-electric effects 250, 257
 connection between current and potential difference for leak caused by ultra-violet light 258
 effect of pressure on photo-electric leak 263, 272
 temperature on photo-electric leak 283
- Strachan, distribution of electric force in discharge 532
- Striations 529, 564
 distance between 565
 effect of size of discharge tube and pressure on distance between 567
 effect of nature of gas on 567
 magnetic force on 575
 in gas at high pressures 569
- Strutt (Hon. R. J.), absorption of α rays 367
 absorption of β rays 383
 emission of positive ions by hot wires 213
 spark potential 436
 in different gases 448
 cathode fall of potential 537
 ionisation by Röntgen rays 299
 magnetic spectrum of cathode rays 633
 effect of walls of vessel on leak 411
 radio-activity of rocks 412
- Stuchtey, force in positive column 555
- Supersaturation of salt solutions 186
- Surface tension, Reinold and Rücker on 183
 effect of on condensation 183
- Swyngedaauw, effect of ultra-violet light on sparks 432
 effect of rate of variation of potential on spark discharge 434
- Tables of spark potential 524
 of values of e/m 145
 of velocities of the ions 80
- Tamm, point discharge 499, 501
- Temperature, influence of
 on photo-electric effects 283
 on ionisation by Röntgen rays 294
 on rate of recombination of ions 23
 of terminals in arc 604
 distribution of along line of discharge through gas at low pressures 571
- Tertiary Röntgen radiation 330
- Theory of discharge by ultra-violet light 267

- Theory of conduction of electricity by ions 84
 conduction of electricity through flames 95
 of effect of ions on condensation 179
 of difference between positive and negative ions in promoting condensation 186
 of absorption of α rays 370
 of absorption of cathode rays 375
 of Röntgen rays 659
 secondary radiation 321
 spark discharge 471, 490
 point discharge 510
 arc discharge 612
 discharge through gas at low pressures 585 et seq.
- Thermoluminescence 625
- Thorium, radio-activity of 336
- Todd, Rowland, and Duncan, effect of pressure on potential difference in arc discharge 608
- Töpler, various types of discharge 515
 pressure waves produced by sparks 518
 striations at high pressures 569
- Townsend, current and potential difference curve 13
 rate of recombination of ions 20
 diffusion of ions 32
 formation of clouds 164, 421
 secondary Röntgen radiation 311
 electrification due to chemical action 420
 charge on gas liberated by electrolysis 421
 velocity of ions produced by chemical action 422
 ionisation by collision 474, 486
- Townsend and Kirkby, ionisation by collision 475
- Transparency to Röntgen rays, coefficients of 304
- Tufts, conduction through flames 232
 effect of lime on the cathode fall of potential in flames 238
- Tyndall, clouds produced by light 170
- Ultra-violet light, ratio of charge to mass for corpuscle produced by 135, 137
 effect of on condensation of clouds 164, 255
 on air 170
 ionisation due to 250 et seq.
 positive ions produced by 253
 action on gases 255
 theory of discharge due to 267 et seq.
 effect of, on lag of spark 433
- Uranium, radiation from 332
- Vacuum, insulation of 6
- Varley, relation between potential difference and current for conduction caused by ultra-violet light 266, 269
 photo-electric fatigue 288
- Varley, Cromwell, cathode rays 622
- Velocity of ions 42 et seq.
 methods of measuring 43, 45, 47, 48, 58, 61, 64, 67, 68
 difference between positive and negative ions 48
 ratio of 58
 table of 80
 in point discharge 68
 from incandescent solids 192
 produced by chemical action 422
 in salt vapours 240
 in flames 243
 of corpuscles emitted by action of ultra-violet light 275
 of corpuscles emitted by action of Röntgen rays 317
 cathode rays 131
 Röntgen rays 646
 of α rays 149, 355
 positive ions producing induced radio-activity 345
 corpuscles, effect of on ionising power 378, 477
- Villard, reducing action of cathode rays 624
 electrification due to Canalstrahlen 641
- Villari, heat produced by discharge 520
- Vincent, clouds produced by ultra-violet light 170, 255
- Violle, temperature of arc 604
- Voege, spark potential 464
- Waidner and Burgess, temperature of arc 604
- Walker, G. W., connection between current and potential difference in an ionised gas 95
- Walter, discharge before passage of spark 434
- Warburg, leakage of electricity through air 2
 lag of the spark 432
 effect of ultra-violet light on 433
 moisture on 434
 magnetic force on 434
 effect of impurities on point discharge 506
 cathode fall of potential 535, 536
- Warburg and Gorton, point discharge 500
- Water, electrification due to 427
 radio-active gas in 412
- Watson, ionisation by incandescent solids 188

- Waves in air produced by sparks 518
- Wehnelt, shadow cast on cathode 490
- discharge from cathode 539
- distribution of potential near cathode 541
- influence of current on thickness of dark space 547
- value of e/m for corpuscles from hot lime 139
- emission of corpuscles from oxides 201, 477
- oxidation by Canalstrahlen 639
- Wesendonck, dissymmetry of discharge 466
- Wiechert, ratio of charge to mass of an ion 130
- Wiedemann (E.), temperature of gas conveying electric discharge 570
- constricted discharge 579
- Entladungstrahlen 602
- thermoluminescence 625
- thermal effects due to cathode rays 628
- energy required to produce phosphorescence 629
- Wiedemann (E.) and Ebert, discharge at low pressures by rapidly alternating current 580
- thermal effects due to cathode rays 628
- repulsion of cathode streams 638
- effect of ultra-violet light on spark 432
- Wiedemann (E.), and Schmidt, coloration produced by cathode rays 624
- thermo-luminescence 626
- Wiedemann (G.), heat produced by sparks 520
- Wien, ratio of charge to mass for positive ion 146
- Canalstrahlen 641
- Wigger, absorption of γ rays 409
- Willows, distance between striations 565
- absorption of gas in discharge tube 552
- effect of size of discharge tube on striæ 567
- influence of nature of gas on striæ 567
- effect of magnetic field on discharge 577
- Willows and Garrett, ionisation produced by heating salts 425
- Wilson (C. T. R.), leakage of electricity through air and other gases 4, 6
- condensation of clouds round ions 150, 153, 166
- nuclei from metals 172
- Wilson (C. T. R.), relative efficiency of positive and negative ions in producing clouds 175
- action of ultra-violet light on gases 255
- ions produced by point discharge 506
- Wilson (H. A.), ratio of mass to charge on corpuscle 122
- effect of dissolved salt on formation of clouds 172, 421
- velocity of ions in salt vapours 240
- discharge through flame gases 243
- distribution of potential in hot gases 233
- velocity of ions in flames 209, 240
- conductivity of flames 232
- current through salt vapours 236, 249
- distribution of electric force in discharge 530
- current density at cathode 539
- electric force in Faraday dark space 553
- positive column 555
- distribution of ions along discharge 559
- Hall effect in gases 562
- charge on the ion 158
- potential distribution near hot electrode 225
- leak from hot wire 212
- emission of positive ions from hot wires 213
- effect of hydrogen on leak from hot wires 202
- Wind, electrical 507
- Wind and Haga, diffraction of Röntgen rays 648
- Wolf, relation of spark potential to pressure 467
- Wood, distribution of temperature along line of discharge 571
- Wood (A.) and Campbell, effect of screens on ionisation in a closed vessel 411
- diurnal variation of ionisation 418
- Wulf, effect of gas films on photo-electric effects 276
- Wurtz, non-arcing metals 608
- Zeleny, velocity of positive and negative ions 45-58
- currents in gas caused by motion of ions 78
- potential gradient in ionised gas 81
- effect of temperature on photo-electric effects 283

CAMBRIDGE PHYSICAL SERIES.

The Times.—"The Cambridge Physical Series.. has the merit of being written by scholars who have taken the trouble to acquaint themselves with modern needs as well as with modern theories."

Conduction of Electricity through Gases. By J. J. THOMSON, D.Sc., LL.D., Ph.D., F.R.S., Fellow of Trinity College and Cavendish Professor of Experimental Physics, Cambridge, Professor of Natural Philosophy at the Royal Institution, London. Second Edition. Demy 8vo. viii + 678 pp. 16s.

Extract from Preface to Second Edition.—"I have made many additions to this edition, and a considerable part of it has been re-written in the hope of introducing new material in a more logical and connected form than could be done by merely adding new paragraphs to the old edition. This has increased the size of the book; on the other hand the publication, since the first edition of this book, of Rutherford's *Radio-activity* has enabled me to omit some matter fully treated by Rutherford."

CONTENTS.

I. Electrical Conductivity of Gases in a normal state.	X. Ionisation by Light. Photo-Electric Effects.
II. Properties of a Gas when in the conducting state.	XI. Ionisation by Röntgen Rays.
III. Mathematical Theory of the Conduction of Electricity through a Gas containing Ions.	XII. Rays from Radio-active Substances.
IV. Effect produced by a Magnetic Field on the Motion of the Ions.	XIII. Power of the Elements in general to emit ionising radiation.
V. Determination of the Ratio of the Charge to the Mass of an Ion.	XIV. Ionisation due to Chemical Action, the bubbling of air through water, and the splashing of drops.
VI. Determination of the Charge carried by the Negative Ion.	XV. Spark Discharge.
VII. On some Physical Properties of Gaseous Ions.	XVI. Discharge through Gases at Low Pressures.
VIII. Ionisation by Incandescent Solids.	XVII. Theory of the Discharge through Vacuum Tubes.
IX. Ionisation in Gases from Flames.	XVIII. The Electric Arc.
	XIX. Cathode Rays.
	XX. Röntgen Rays.
	XXI. Properties of Moving Electrified Bodies.
	Index.

PRESS NOTICES OF THE FIRST EDITION.

Times.—"It is difficult to think of a single branch of the physical sciences in which these advances are not of fundamental importance. The physicist sees the relations between electricity and matter laid bare in a manner hardly hoped for hitherto....The workers in the field of Science are to-day reaping an unparalleled harvest, and we may congratulate ourselves that in this field at least we more than hold our own among the nations of the world."

Engineering.—"The subject with which it deals is, perhaps, the most vitally important in the whole field covered by the name "physics" to-day... No one will doubt that for such a work the best possible author is Professor J. J. Thomson. For it is to him, more than to any other person, that we owe the rapid progress that has been made in recent years in this subject.... The work is one of the highest importance, and must be given a prominent place among the standard literature of modern science."

CAMBRIDGE PHYSICAL SERIES.

A Treatise on the Theory of Solution, including the Phenomena of Electrolysis. By WILLIAM CECIL DAMPIER WHETHAM, M.A., F.R.S., Fellow of Trinity College. Demy 8vo. x + 488 pp. 10s. net.

Athenæum.—"The choice and arrangement of the matter included are alike excellent... Mr Whetham's book is probably the most complete and satisfactory treatise on the subject in any language and as such is sure to enjoy a wide popularity."

Nature.—"The treatment throughout is characterised by great clearness, especially in the physical and mathematical portions, so that the volume may be warmly recommended to students of chemistry."

Electricity and Magnetism: an Elementary Text-book, Theoretical and Practical. By R. T. GLAZEBROOK, M.A., F.R.S., Director of the National Physical Laboratory and Fellow of Trinity College, Cambridge. Crown 8vo. Cloth. 1—440 pp. 7s. 6d.

PREFACE. Some words are perhaps necessary to explain the publication of another book dealing with Elementary Electricity. A considerable portion of the present work has been in type for a long time; it was used originally as a part of the practical work in Physics for Medical Students at the Cavendish Laboratory in connexion with my lectures, and was expanded by Mr Wilberforce and Mr Fitzpatrick in one of their Laboratory Note-books of Practical Physics.

When I ceased to deliver the first year course I was asked to print my lectures for the use, primarily, of the Students attending the practical classes; the lectures on Mechanics, Heat and Light have been in type for some years. Other claims on my time have prevented the issue of the present volume until now, when it appears in response to the promise made several years ago.

Meanwhile the subject has changed; but while this is the case the elementary laws and measurements on which the science is based remain unaltered, and I trust the book may be found of service to others besides my successors at the Cavendish Laboratory.

The book is to be used in the same way as its predecessors. The apparatus for most of the Experiments is of a simple character and can be supplied at no great expense in considerable quantities.

Thus the Experiments should all, as far as possible, be carried out by the members of the class, the teacher should base his reasoning on the results actually obtained by his pupils. Ten or twelve years ago this method was far from common; the importance to a School of a Physical Laboratory is now more generally recognized; it is with the hope that the book may be of value to those who are endeavouring to put the method in practice that it is issued now.

EXTRACTS FROM PRESS NOTICES.

Athenæum.—"If the nature of the book be taken into consideration, it will be found unusually free from the influence of the examination spirit. The writing is bright and interesting, and will stimulate a desire, we think, for further study."

Guardian.—"Every schoolmaster and teacher who has under consideration the selection of a text-book for his better students should most certainly look into this book. The information is everywhere absolutely sound and reliable."

CAMBRIDGE PHYSICAL SERIES.

Heat and Light. An Elementary Text-book, Theoretical and Practical, for Colleges and Schools. By R. T. GLAZEBROOK, M.A. Crown 8vo. 5s.

Also in separate volumes :

Heat. 230 pp. 3s.

Light. 213 pp. 3s.

Mechanics and Hydrostatics. An Elementary Text-book, Theoretical and Practical, for Colleges and Schools. By R. T. GLAZEBROOK, M.A. Crown 8vo. 8s. 6d.

Also in separate volumes :

Part I. **Dynamics.** 256 pp. 4s.

Part II. **Statics.** 182 pp. 3s

Part III. **Hydrostatics.** 216 pp. 3s.

EXTRACTS FROM PRESS NOTICES.

“Schools and Colleges will certainly benefit by adopting this book for their students.” *Nature*.

“Mr Glazebrook’s volumes on Heat and Light deal with these subjects from the experimental side and it is difficult to admire sufficiently the ingenuity and simplicity of many of the experiments without losing sight of the skill and judgment with which they are arranged.” *Saturday Review*.

“The books almost cover the advanced stages of the South Kensington prospectus and their use can certainly be recommended to all who wish to study these subjects with intelligence and thoroughness.” *Schoolmaster*.

“Mr Glazebrook’s great practical experience has enabled him to treat the experimental aspect of the book with unusual power and it is in this that the great value of the book as compared with most of the ordinary manuals consists.” *Educational Review*.

“The book is very simply and concisely written, is clear and methodic in arrangement...We recommend the book to the attention of all students and teachers of this branch of physical science.” *Educational News*.

“We wish Mr Glazebrook every success on the extension of his practical system to all the Colleges and Schools of the country. It is the only way in which the interest of the student can be awakened and the study of the subject made popular and real.” *Technical World*.

“It will be especially appreciated by teachers who possess the necessary apparatus for experimental illustrations.” *Athenæum*.

“Text-books on this subject are generally too simple or too elaborate for a conception of elementary mechanical principles. This book cannot fail to recommend itself therefore for a first course preliminary to the study of physical science. No other book presents in the same space with the same clearness and exactness so large a range of mechanical principles.” *Physical Review*.

“Marked ability has been shewn in the development of the subject of Statics in the present volume...The collected examples for students’ exercises are excellent.” *Glasgow Herald*.

CAMBRIDGE PHYSICAL SERIES.

General Editors: F. H. NEVILLE, M.A., F.R.S. and
W. C. D. WHETHAM, M.A., F.R.S.

Mechanics. By JOHN COX, M.A., F.R.S.C., Macdonald
Professor of Experimental Physics in McGill University, Montreal.
Demy 8vo. pp. xiv + 332. 9s. Net.

Athenæum.—"It may reasonably be hoped that this endeavour to bridge over the gulf which has hitherto separated theory from practice in respect of the principles of mechanics, by showing their intimate connexion, and to present the subject in a more living and attractive form, by drawing attention to the gradual stages and methods by which the early investigators discovered the laws which govern the science, will meet with the success which it deserves."

The Study of Chemical Composition. An Account of
its Method and Historical Development, with illustrative quotations.
By IDA FREUND, Staff Lecturer and Associate of Newnham College.
Demy 8vo. xvi + 650 pp. 18s. Net.

Saturday Review.—"Written from a broad, philosophical standpoint, we know of no book more suited for the student of chemistry who has attained a sound general knowledge of the science, and is now ready to appreciate a critical discussion of the methods by which the results he has learnt have been built up, thereby fitting himself for the real world of investigation on his own account."

A Treatise on the Theory of Alternating Currents.

By ALEXANDER RUSSELL, M.A., M.I.E.E.
Vol. I. Demy 8vo. pp. 408. 12s. Net.
Vol. II. pp. xii + 488. 12s. Net.

Scotsman.—"The volume is not only rich in its own substantive teaching, but well supplied with references to the more remote authorities upon its subject. It opens an important and valuable contribution to the theoretical literature of electrical engineering."

Radio-activity. By E. RUTHERFORD, D.Sc., F.R.S., F.R.S.C.,
Macdonald Professor of Physics, McGill University, Montreal. Demy
8vo. Second Edition. Revised and enlarged. xiv + 580 pp. 12s. 6d.
Net.

Extract from Preface to the Second Edition.—"The rearrangement is so extensive as to constitute almost a new work."

Nature.—"Professor Rutherford's book has no rival as an authoritative exposition of what is known of the properties of radio-active bodies. A very large share of that knowledge is due to the author himself. His amazing activity in this field has excited universal admiration."

The Theory of Experimental Electricity. By
W. C. D. WHETHAM, M.A., F.R.S., Fellow of Trinity College.
Demy 8vo. xii + 334 pp. 8s. Net.

Guardian.—"We strongly recommend this book to those University Students who require an introduction to modern scientific electricity. The research atmosphere of Cambridge is here brought before us, and the student is guided into the paths along which great progress has been made in recent years."

CAMBRIDGE UNIVERSITY PRESS WAREHOUSE,

C. F. CLAY, MANAGER,

London: FETTER LANE,

Glasgow: 50, WELLINGTON STREET.

ALSO

London: H. K. LEWIS, 136, GOWER STREET, W.C.

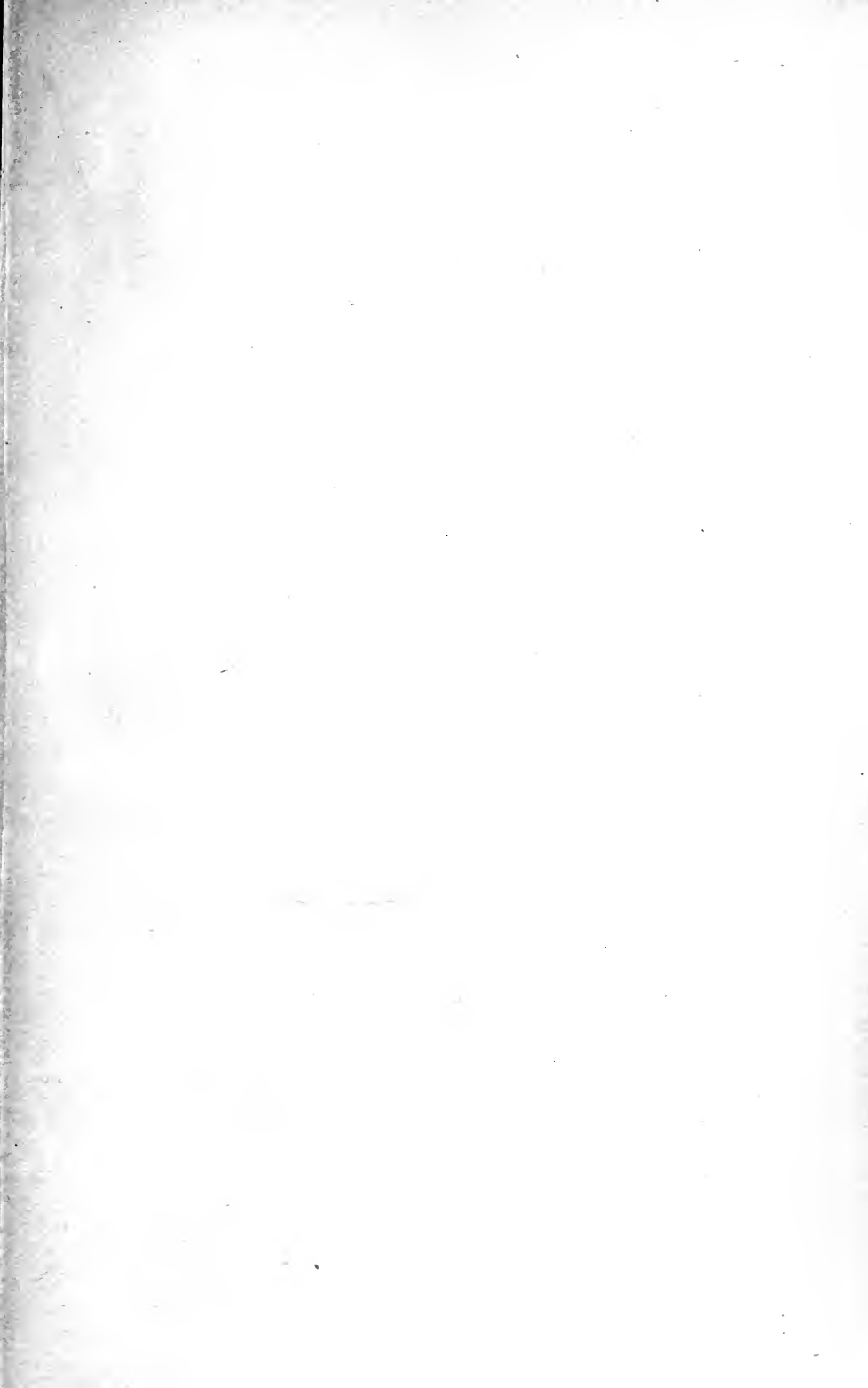

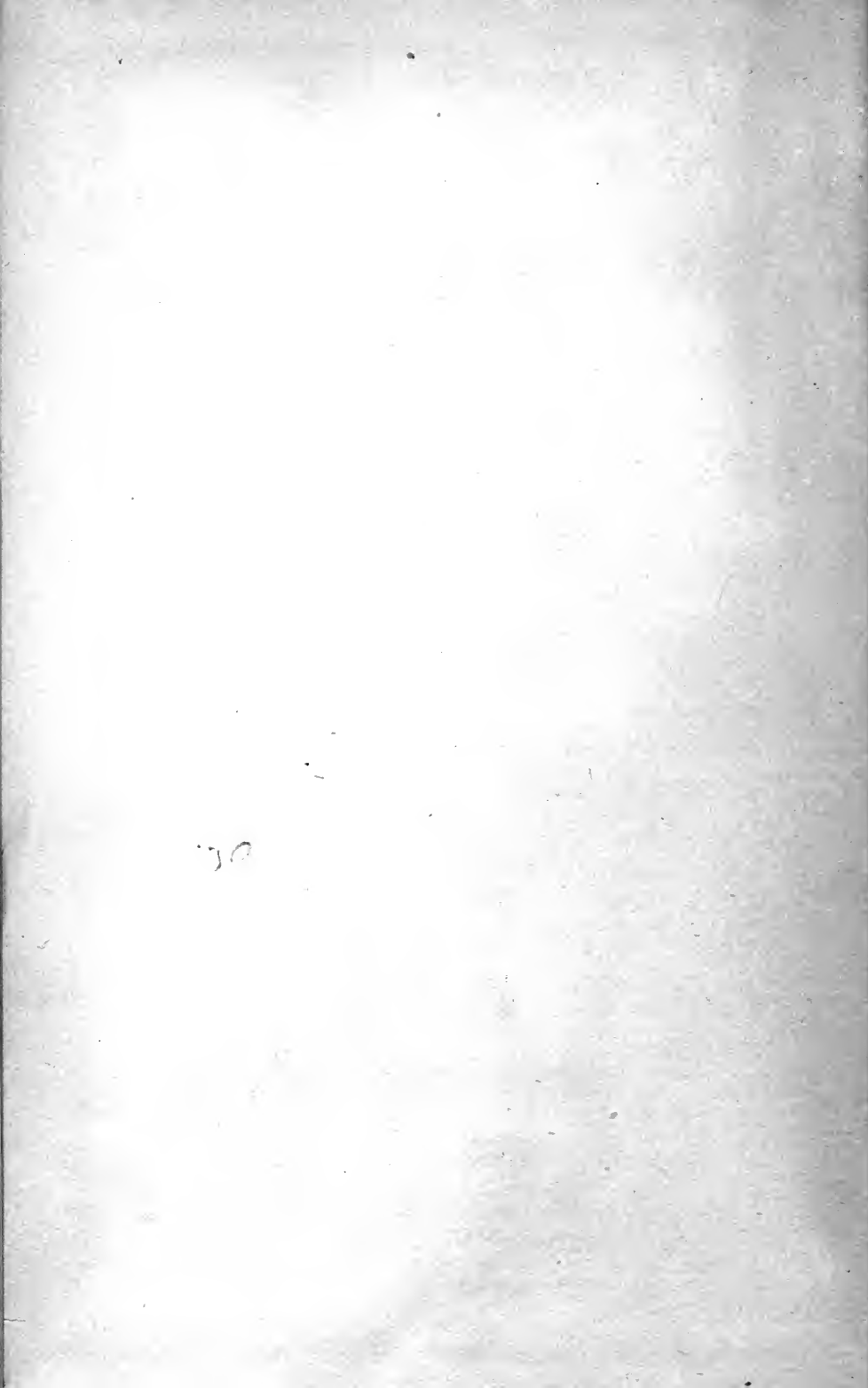

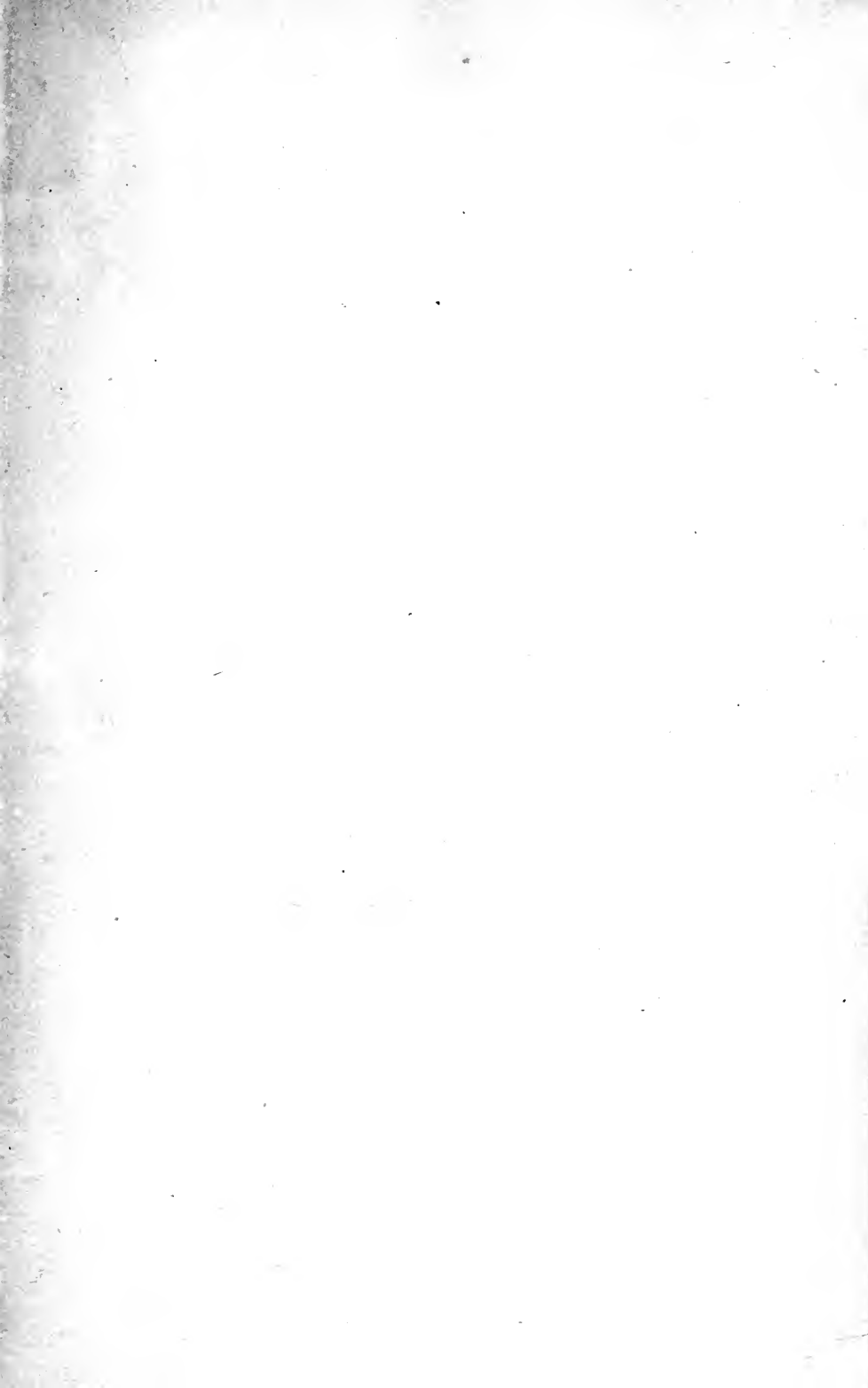

THE UNIVERSITY LIBRARY
UNIVERSITY OF CALIFORNIA, SANTA CRUZ
SCIENCE LIBRARY

This book is due on the last **DATE** stamped below.
To renew by phone, call **459-2050**.
Books not returned or renewed within 14 days
after due date are subject to billing.

SCI. LIB.

QC711.T5 1906 Sci



3 2106 00241 4792

π

