

University of Illinois
Library at
Urbana-Champaign
ACES

UNIVERSITY LIBRARY

UNIVERSITY OF ILLINOIS AT URBANA-CHAMPAIGN

The person charging this material is responsible for its renewal or return to the library on or before the due date. The minimum fee for a lost item is **\$125.00, \$300.00** for bound journals.

Theft, mutilation, and underlining of books are reasons for disciplinary action and may result in dismissal from the University. *Please note: self-stick notes may result in torn pages and lift some inks.*

Renew via the Telephone Center at 217-333-8400, 846-262-1510 (toll-free) or circlib@uiuc.edu.

Renew online by choosing the **My Account** option at: <http://www.library.uiuc.edu/catalog/>





Handwritten scribbles at the top of the page.

UNIVERSITY OF ILLINOIS

Agricultural Experiment Station

BULLETIN No. 102

THE CONSTRUCTION OF SILOS

BY WILBER J. FRASER

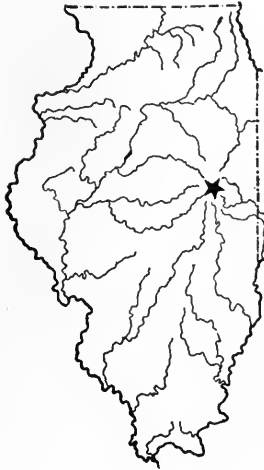

URBANA, ILLINOIS, JUNE, 1905

SUMMARY OF BULLETIN No. 102

INTRODUCTION.—The object of this bulletin is to direct attention to some important points in building silos, both in material used and in manner of construction. Page 1

ESSENTIALS OF A SILO.—To preserve the silage perfectly the silo wall must be rigid and air-tight. Page 1

LOCATION.—That the labor of feeding may be reduced to the minimum, the silo should be placed as near the manger as possible. Page 3

FORM OF SILO.—It is practically impossible to construct a square wood silo with rigid walls, and as silage usually spoils more or less in the corners, it is perfectly clear that the round silo is the only proper form. Page 7

PROPORTION AND CAPACITY.—The deeper the silo the greater the pressure and the more compactly will the silage be pressed together. To be well proportioned, the height should not be more than twice the diameter. Table 1 gives the capacity of silos. Page 7

	Page 7
Round Wood Silo Plastered with Cement	Page 11
Foundation	Page 11
Sill and studs	Page 13
Lath and plaster	Page 18
Ventilation	Page 20
Sheeting	Page 22
Itemized cost	Page 24
Concrete Silos	Page 32
Brick Silos	Page 35
Stone Silos	Page 36
Stave Silos	Page 37

THE CONSTRUCTION OF SILOS

BY WILBER J. FRASER, CHIEF IN DAIRY HUSBANDRY

INTRODUCTION

There has been much discussion through the agricultural press and at farmers' institutes concerning the importance of the silo and the advantages and disadvantages of the different styles of construction. As yet, however, comparatively few dairymen and stock raisers of Illinois fully appreciate the value of silage, and as there are not one-tenth as many silos in the state as the economy of silage as a feed, especially for dairy cows, would warrant, the Experiment Station has deemed it wise to issue two bulletins on this subject.

Bulletin No. 101, recently published, discusses the subject of crops for the silo and cost of filling. The aim of this bulletin is to direct attention to some of the essential points in silo construction and also to show the serious defects in some styles of silos, both in the material used and in the manner of construction. Cheap silos which are poorly built have done much to injure the cause of silage, for since they do not preserve their contents perfectly there is necessarily great loss. The problem is, therefore, to build an enduring, air-tight, rigid structure at least expense.

ESSENTIALS OF A SILO

There are several points that must be closely observed in making silage if it is to be well preserved, and the neglect of any one of these will make, in the final result, the difference between success and failure. These essentials are close packing, when the crop is at the proper stage of maturity, in an air-tight structure having perfectly rigid walls.

The stage of maturity and method of packing were treated in Bulletin No. 101 (a copy of which can be obtained from the Illinois Experiment Station, Urbana, Illinois.) Of equal if not greater importance, is the proper construction of the silo. If the sides of the silo are not air-tight, the air which passes through will cause the silage to spoil, and if the walls are not perfectly rigid, the pressure of the silage will cause them to spring out, allowing the air to enter between the silage and the wall. In either case the result will be the same—decayed silage.



CUT 1.—LARGE CEMENT SILO TO WHICH COW STABLE IS TO BE EXTENDED.

The outward pressure on the wall of a silo filled with cut corn is about 11 pounds for every foot in depth; making a pressure of 110 pounds at a depth of 10 feet; 330 pounds at a depth of 30 feet; and the enormous pressure of 440 pounds per square foot at a depth of forty feet. This increase in pressure as the depth increases must be considered in silo construction and the lower portion made much the stronger.

Before building a silo the most careful attention should be given to location, size, form, and method of construction. These will differ somewhat according to locality and individual needs. A brief discussion of these questions follows:



CUT 2.—TWO ROUND SILOS FORMING END OF BARN.



CUT 3.—SILO LOCATED AT INTERSECTION OF COW STABLES.

LOCATION

As silage contains about 80 percent water it is a heavy feed to handle and, to avoid unnecessary labor in feeding, the silo should be placed as near the manger as possible, preferably at one end of the feeding alley. If the silo is inside the barn the silage chute should be provided with a door which should be kept closed to prevent the silage odors from entering the barn at milking time, thus avoiding the possibility of their being absorbed by the milk.



CUT 4 —OCTAGONAL SILO LOCATED IN CORNER OF BARN.

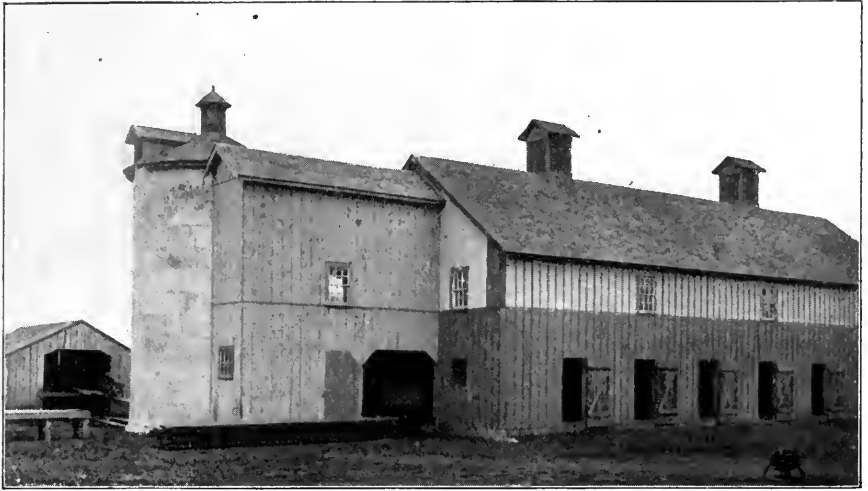

CUT 5.—SHOWING CONNECTION OF SILO WITH BARN.

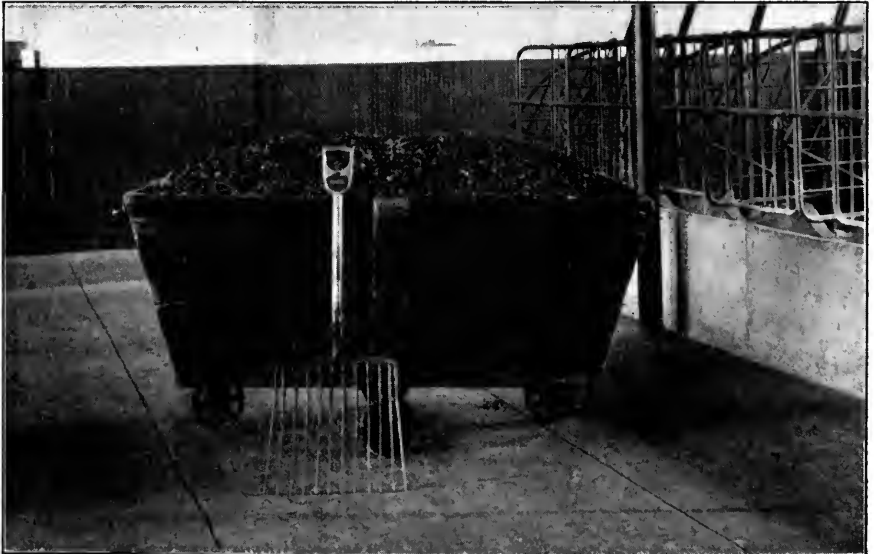

CUT 6.—SILAGE CART FOR USE ON CEMENT FLOOR.

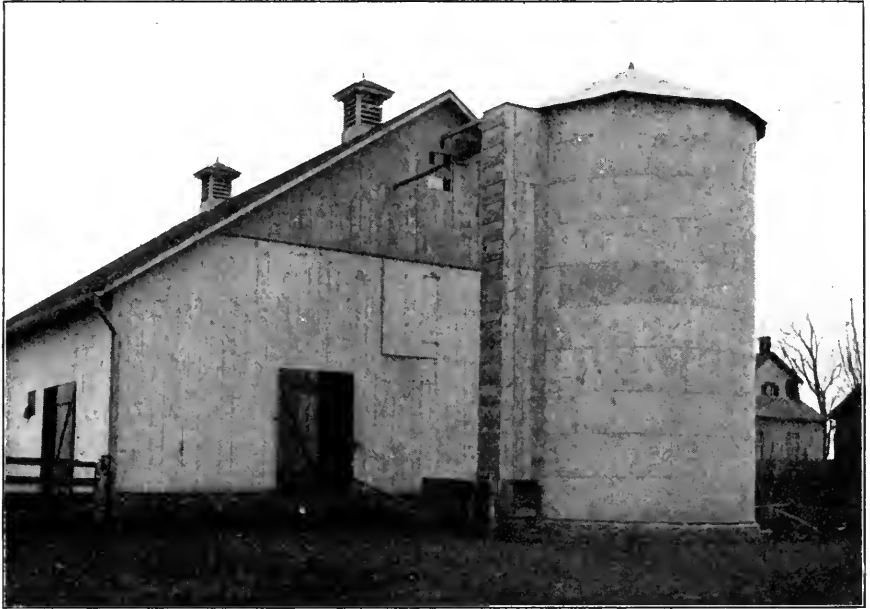

CUT 7.—WHERE NECESSARY TO FILL HAY LOFT FROM END OF BARN AT WHICH SILO IS LOCATED, A MOVABLE TRACK AND CAR MAY BE USED TO CARRY SILAGE TO MANGER.



CUT 8.—SILAGE CAR TO RUN ON MOVABLE TRACK.

Where there is a smooth level floor from the silo through the feeding alley, a cart similar to the one shown in Cut 6 will prove a great convenience in feeding. When built outside the barn the silo should be within a few feet of it and connected by a covered passage. Where it is desired to drive up to the barn with grain only, the arrangement may be as in Cut 5. If it is necessary to fill the hay loft from the end of the barn at which the silo is located, a movable track for the silage car can be arranged to extend from the silo to the barn, (Cut 7) with a car constructed as shown in Cut 8. Cuts 1, 2, 3, and 4 show how silos may be conveniently located.



CUT 9.—CHEAP OCTAGONAL SILO WHICH DID NOT PRESERVE ITS CONTENTS PERFECTLY. THIS IS NOT A GOOD SHAPE EVEN WHEN PROPERLY CONSTRUCTED.

FORM OF SILO

Nearly every one who builds a silo adds some new feature, giving rise to a great variety of shapes and methods of construction. Before building a silo it is well to consider both the advantages and the disadvantages of the different styles, as well as the cost of each. It should be borne in mind, however, that no silo is cheap, no matter how small the first cost, if it does not preserve the silage perfectly. The first silos in this country were usually built inside the barn and consequently the square form was commonly used in order to utilize the space more completely. The square silo has not proved satisfactory, however, as it is practically impossible to build this form so that the side walls will not spring out and allow the air to pass down between the silage and the wall, which invariably results in the rotting of the silage. Another difficulty with the square form is that the silage does not settle readily in the corners and there is consequently considerable loss from this cause. Square silos having heavy cement walls are shown in Cut 10, but even these have cracked, allowing the air to enter.

An example of great loss owing to the form and faulty construction came under the writer's notice a few years ago when a square silo with a capacity of fifty tons, was built with air-tight, but not rigid walls. Simply the springing of the sides of the silo allowed the air to gain access to the silage to such an extent that the entire fifty tons spoiled completely. Since for mechanical reasons it is practically impossible to build a square wood silo with perfectly rigid walls, the round silo is the only proper form.

Silage has been put up at the University for the past seventeen years. The first silos were square and built inside the barn. These were made of two thicknesses of $\frac{7}{8}$ inch flooring with paper between. After having been used seven or eight years the double walls began to show signs of decay, and after nine years the walls were so badly rotted that the silo was useless. If silos are to be built of wood the wall should be of but one thickness. The difficulty with double walls is that moisture gets in between the two layers of wood and as it does not dry out readily, decay follows rapidly.

PROPORTION AND CAPACITY OF SILOS

To obtain satisfactory results, silage must be in perfect condition when fed. Since fermentation soon takes place when silage is exposed to the air, the silo should not be of too great diameter.

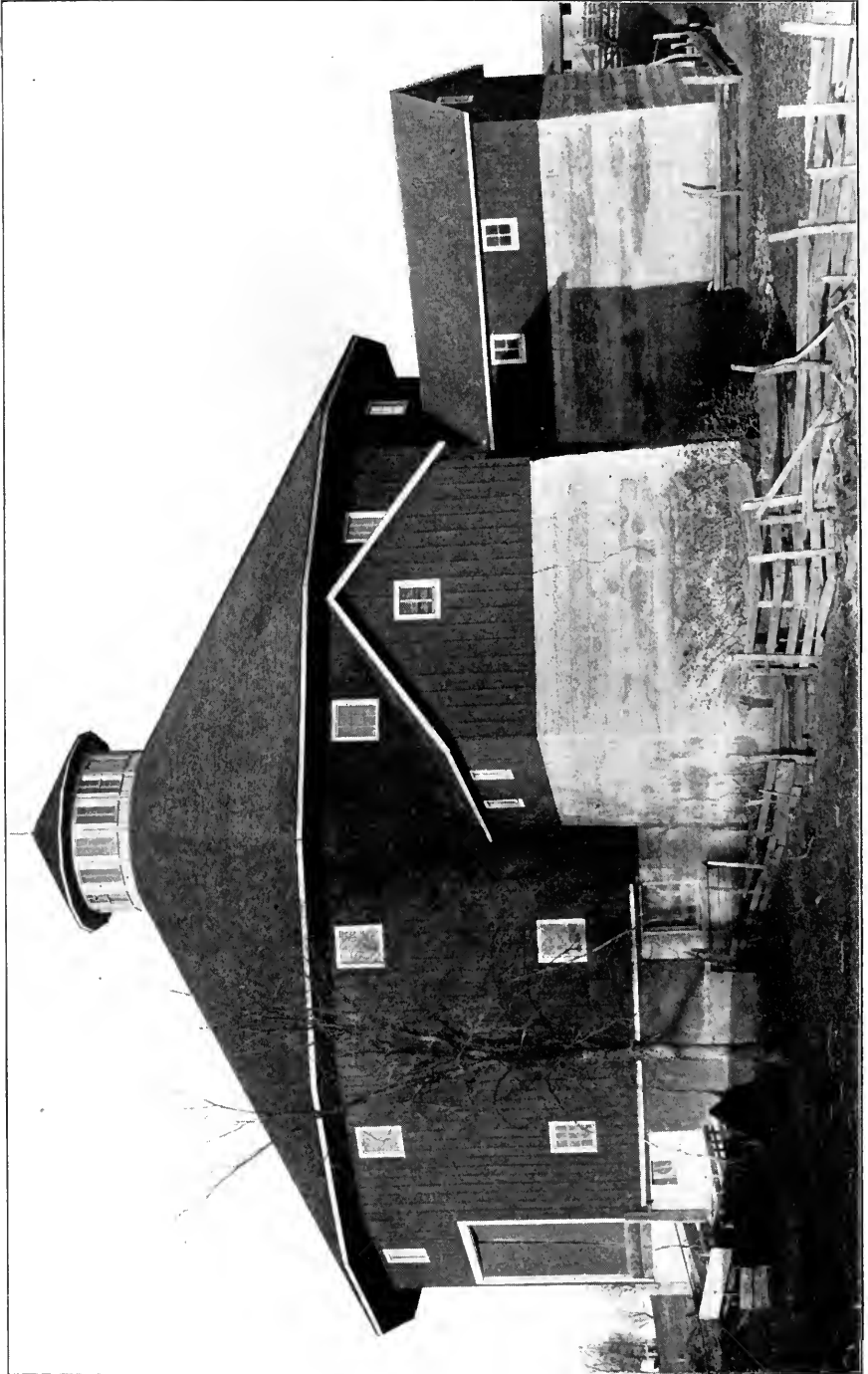

CUT 10.—SQUARE CEMENT SILOS CONNECTED WITH BARN. NOT PROPER SHAPE AND TOO SHALLOW.

Not more than eight square feet of surface should be allowed for each cow in winter, then, when feeding 40 pounds of silage per cow, a layer about $1\frac{1}{2}$ inches deep would be fed off daily. When silage is fed in summer it is advisable that the exposed area be not over half this size so that a layer three inches deep may be used daily. However much stock is to be fed, a silo 20 to 22 feet in diameter is as large as should be built. If a silo is of greater diameter than this, much of the silage is at too great distance from the door, increasing the labor of removal.

The deeper the silo the greater the pressure and the more compactly will the silage be pressed together, hence the larger the amount that can be stored per cubic foot. For example, a silo 20 feet in diameter and 40 feet deep will hold twice as much as one of the same diameter and 25 feet deep. This shows the economy of reasonably deep silos. To be well proportioned the height should not be more than twice the diameter. No silo should be less than 30 feet deep and to get sufficient depth for a silo not over 12 feet in diameter, it may be placed 4 or 5 feet into the ground.

The number of tons of silage needed can readily be estimated from the size of the herd and the amount to be fed daily. Even where it is desired to feed as much silage as possible not more than 40 pounds per cow should be fed daily. In Illinois, silage will usually be needed from about October 20 to May 10, or 200 days. Each cow should have an allowance then of 200 times 40 pounds which is 8,000 pounds of silage, or four tons per cow for the year. A herd of ten cows will require a silo holding 40 tons; a herd of 30 cows 120 tons; 50 cows 200 tons; and 100 cows 400 tons. Where young stock is raised an allowance should be made for them. From the amount of silage needed the dimensions of a silo of the required capacity may be determined from Table I, which gives the capacity in tons of silos of different diameters and depths. These estimates apply to silos filled with well matured corn that has been allowed to settle forty-eight hours and then refilled. It is evident that to get this rated capacity a silo which had been filled rapidly must be refilled after settling forty-eight hours.



CUT II.—BRICK FOUNDATION 4¼ FEET DEEP, 2X4 SILL IMBEDDED IN CEMENT ON TOP.

TABLE 1. APPROXIMATE CAPACITY IN TONS OF CYLINDRICAL SILOS OF DIFFERENT DIAMETERS AND DEPTHS. COMPUTED FROM KING'S TABLE

(The diameter is shown at the top of the columns and depth at the left)

INSIDE DIAMETER IN FEET.													
Depth Ft.	10	11	12	13	14	15	16	17	18	19	20	21	22
20	26.2	31.6	37.7	44.2	51.2	58.8	67	75.6	84.7	94.4	104.6	115.3	126.6
21	28.0	33.8	40.3	47.2	54.8	62.9	71.6	80.8	90.6	100.9	111.8	123.3	135.3
22	29.9	36.2	43.0	50.5	58.6	67.4	76.5	86.4	96.8	107.9	119.6	131.8	144.7
23	31.9	38.6	45.9	53.9	62.5	71.7	81.6	92.1	103.3	115.1	127.5	140.6	154.3
24	33.8	40.9	48.7	57.2	66.3	76.1	86.6	97.8	109.6	122.1	135.3	149.2	163.7
25	35.8	43.3	51.6	60.5	70.2	80.6	89.6	103.6	116.1	129.3	143.3	158.0	173.4
26	37.9	45.9	54.7	64.2	74.4	85.5	97.2	109.8	123.0	137.1	151.9	167.5	183.8
27	40.1	48.5	57.7	67.7	78.6	90.2	102.6	115.8	129.8	144.7	160.3	176.7	194.0
28	42.2	51.1	60.8	71.3	82.7	95.0	108.1	122.0	136.8	152.4	168.9	186.2	204.3
29	44.4	53.7	63.9	75.0	87.0	99.9	113.7	128.3	143.9	160.3	177.6	195.8	214.9
30	46.6	56.4	67.2	78.8	91.4	105.0	119.4	134.8	151.1	168.4	186.6	205.7	225.8
31	48.8	59.1	70.3	82.5	95.7	109.8	124.9	141.1	158.2	176.2	195.2	215.3	236.3
32	51.1	61.9	73.6	86.4	100.2	115.1	130.9	147.8	165.7	184.6	204.6	225.5	247.5
33	53.4	64.6	77.0	90.3	104.8	120.5	137.8	154.6	173.2	193.1	214.1	235.8	258.7
34	55.8	67.5	80.3	94.3	109.3	126.0	142.8	161.6	180.8	201.7	223.6	246.2	270.0
35	58.2	70.4	83.7	98.3	114.0	131.6	148.9	168.7	188.3	210.5	232.2	256.8	281.5
36	60.6	73.0	86.9	102.2	118.3	136.3	154.7	175.9	196.3	219.4	242.0	267.5	292.1
37	63.1	76.0	90.4	106.1	123.1	142.1	160.8	183.2	204.3	228.0	251.9	278.4	303.9
38	65.5	79.0	94.0	110.3	127.9	148.0	167.0	190.7	212.4	237.2	261.9	289.4	315.9
39	67.9	82.0	97.3	114.5	132.8	154.0	173.5	198.3	220.6	246.5	272.0	300.5	328.1
40	70.3	85.1	101.1	118.8	137.8	160.1	180.0	205.0	228.9	255.9	280.2	311.8	340.4

ROUND WOOD SILO PLASTERED WITH CEMENT

The silo described below, which is 20 feet in diameter and 34½ feet deep, having a capacity of 228 tons, was built at the University of Illinois the summer of 1903. The first silos of this kind built in the state, so far as known by the writer, were three erected by Mr. H. B. Gurler of DeKalb in 1897. (This is the style of construction frequently referred to as the Gurler silo.) These three silos have been filled every year and have given most excellent satisfaction. It seems probable that silos of this construction will not only preserve the silage perfectly but will prove to be lasting as well as economical for most sections of the state. As few silos of this type have as yet been built in Illinois, a detailed description of the one at the University is given.

The excavation and foundation were made by cutting a circle 20 feet 10 inches in diameter and four feet deep, and laying up a four-inch brick wall against the clay. (Cut 11.) This wall was slushed in full on the back side with mortar so that every brick had a full

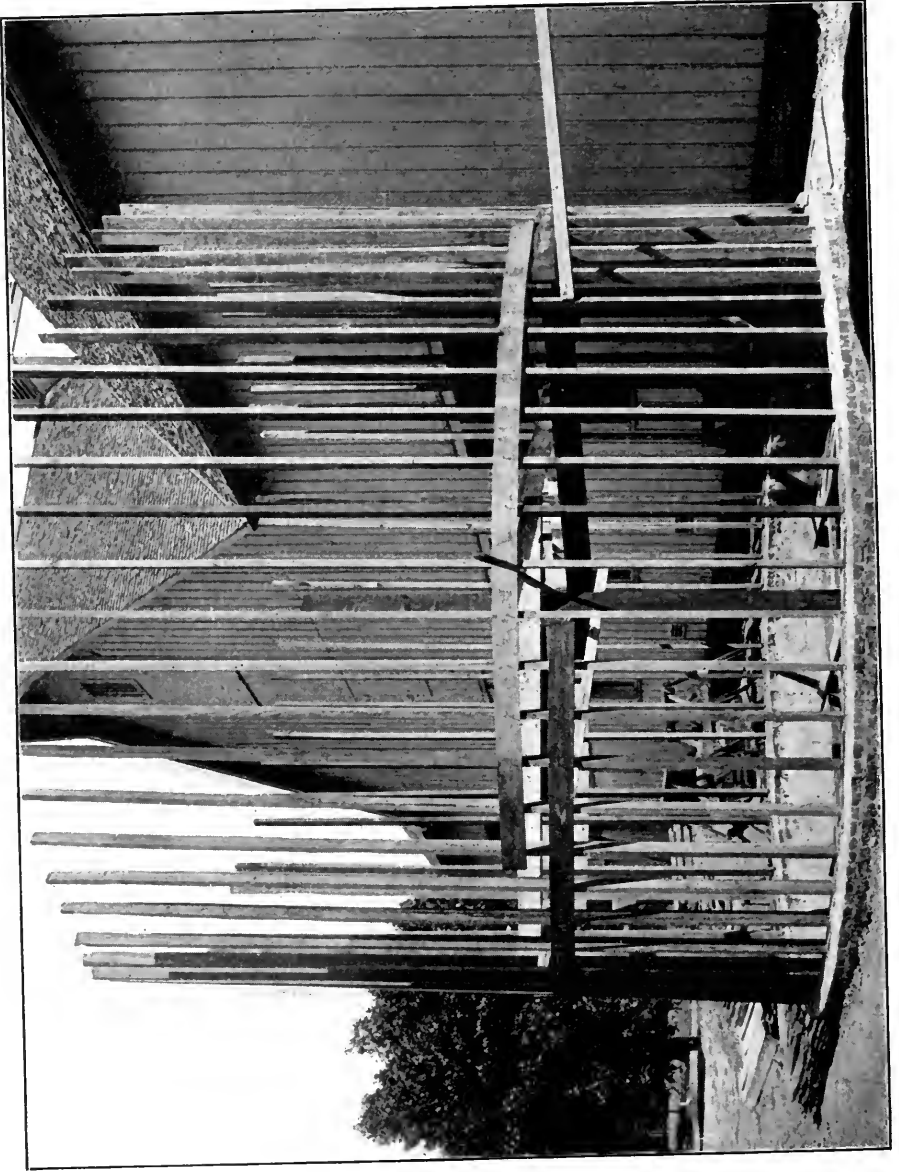

CUT 12.—2X4 STUDS SET ON SILL AND PLUMBED TO HEIGHT OF SIX FEET.

bearing against the clay to resist the great outward pressure of the silage. Where the clay is solid a two-inch brick wall is quite sufficient. Three feet from the bottom and within one foot of the top of the ground the wall was thickened to eight inches and carried up six inches above the grade line. Where the grass is not kept down around the silo the brick wall should be higher to protect the wood from dampness.

When a silo is placed in the ground, unless there is good natural drainage through the subsoil, tile must be laid to drain the bottom or difficulty is almost sure to be experienced with water in the pit.

The wall of this silo should have been strengthened by imbedding an iron hoop in it just above the ground, for an eight-inch brick wall does not have sufficient strength to withstand the outward pressure of the silage at such a depth. This silo wall has cracked slightly in two or three places.

The sill was made of 2x4's cut into two foot lengths; these were thoroughly imbedded in mortar on top of the wall. The upper two feet of the wall was laid in mortar made of one part Portland cement to two parts of sharp sand, and the entire foundation was plastered with a thin coat of this mortar.

The studs, which were 16 foot 2x4's, were set on the sill and toenailed to it. A large post sixteen feet long was set in the ground in the center of the excavation, and boards extending from this to the studs about six feet above the foundation, held the studs perpendicular to this height. (Cut 12.) A half-inch board was then bent around the outside of the studs at this height and the studs were tacked to it as fast as they were plumbed. These boards held the studs perpendicular and in a circle to a height of six feet. The lining, which was $\frac{1}{2}$ x6 inches 16 feet long, made by splitting common fencing with a saw, was put on the inside, beginning at the bottom. (Cut 13.) The upper portions of the studs were then plumbed and held in place by pieces radiating from the post in the center and by boards sprung on the circumference of the silo. (Cut 13.) To insure uniform strength throughout the silo, care must be exercised to break joints when ceiling.

Staging was carried up on the inside as fast as the ceiling. When the top of the first studs was reached, the upper studs were spiked to the sides of the lower, allowing them to lap two feet, and another section was plumbed. (Cut 14.) The ceiling was continued on the inside to within six inches of the top, and the plate, which consisted of 2x4's cut into two-foot lengths, was then spiked on top of the studs. (Cut 15.)

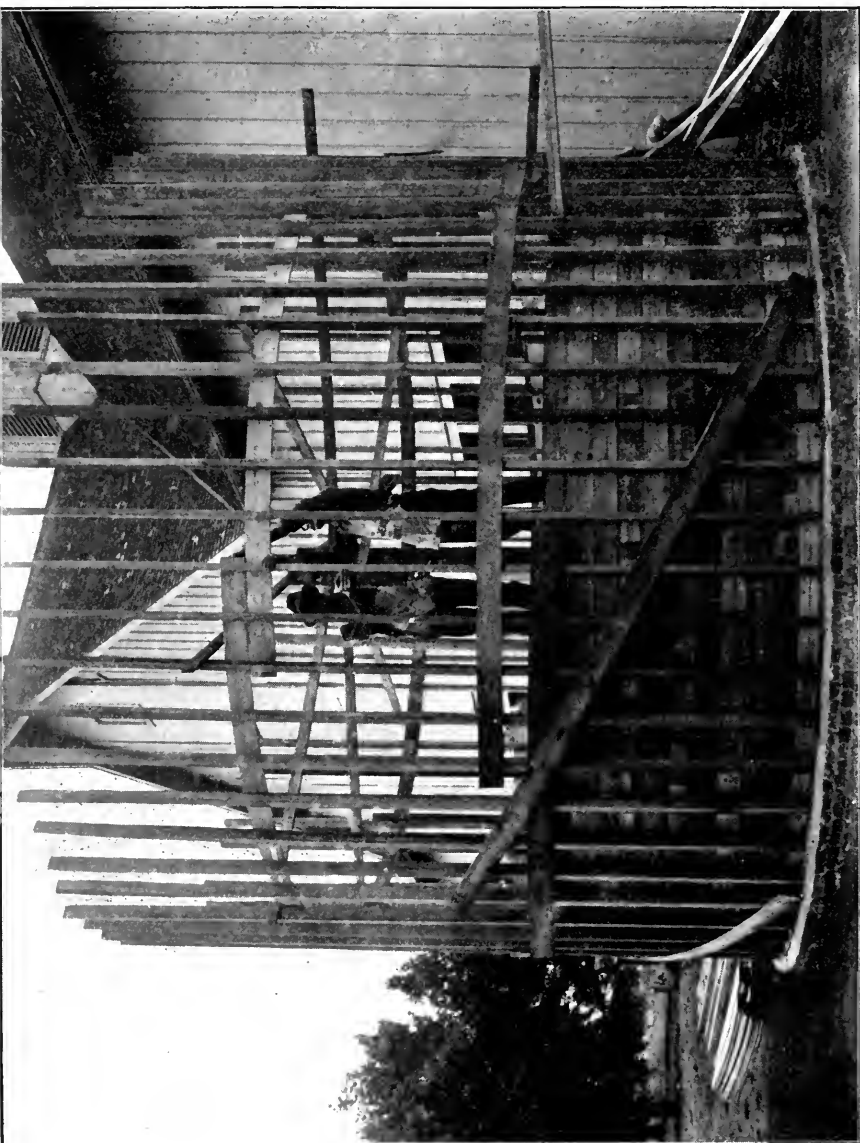

CUT 13.—SILO CEILED ON INSIDE TO HEIGHT OF SIX FEET. PLUMBING SECOND SIX FEET OF STUDS.

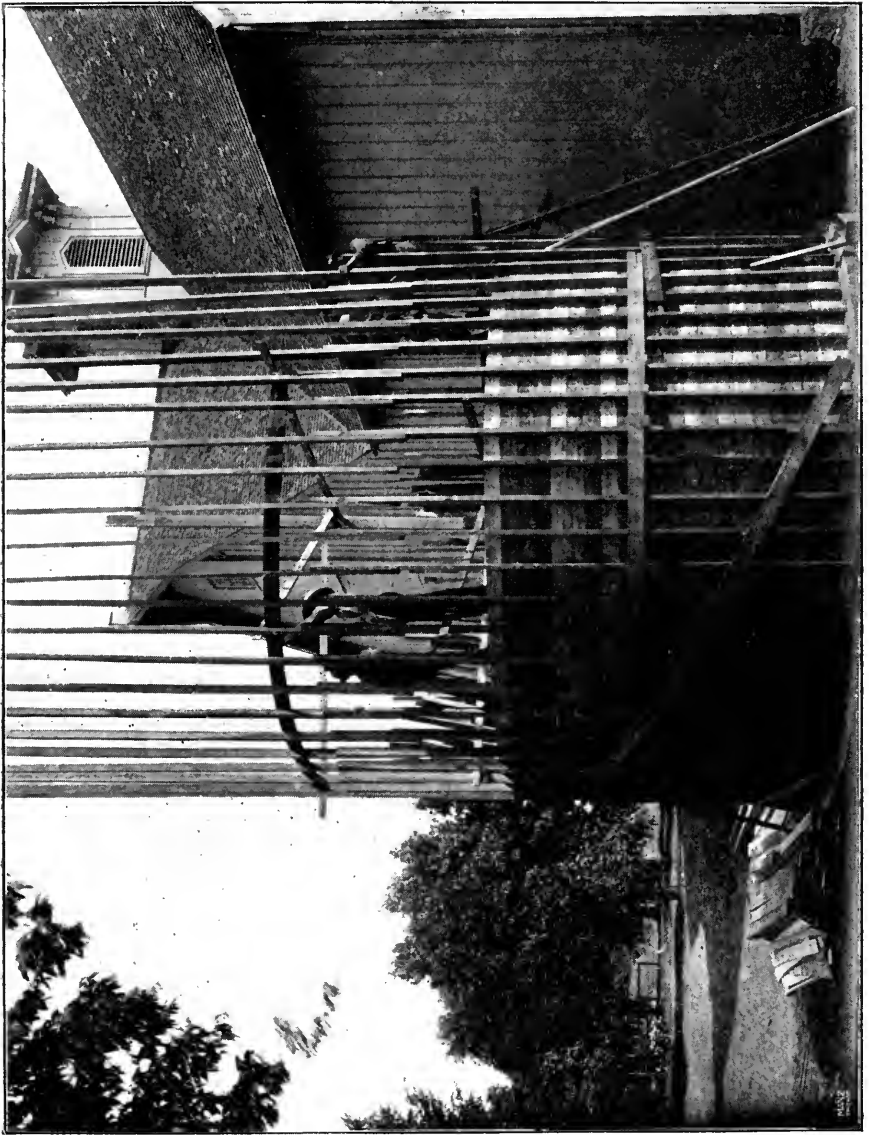
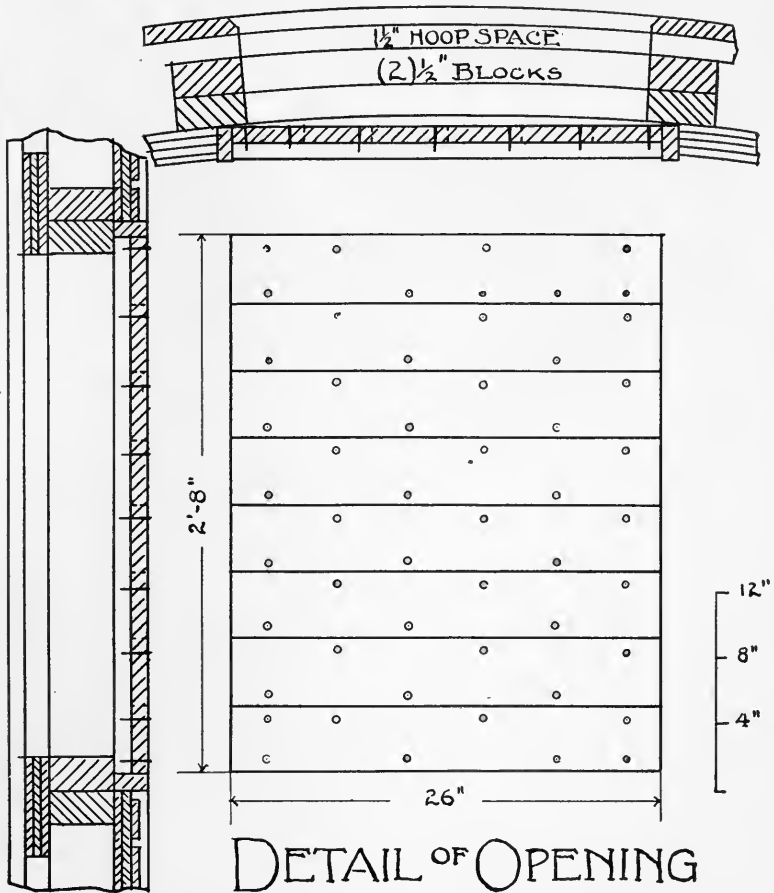

FIG. 14.—DRAWING UP SECOND SECTION OF STAVES ON RIGHT; PLUMBING STAVES ON LEFT.



CUT 15.—INSIDE CEILING COMPLETED. CONDITION IN WHICH THE SILO STOOD FOR SIX WEEKS AFTER FILLING.



CUT 16.—SHOWING CONSTRUCTION OF DOOR AND DOOR FRAME.

On each side of the line of doorways were set two 2x4's spiked together to make 4x4's. These were placed so that the edge of the 2x4's faced the doorways leaving the flat side for the doors to rest against in resisting the pressure from the silage. In this way there was no crack through the 4x4's where the plaster and doors join. (Cut 16.)

As the silo was partially cut in two on the side where the openings were left, it was necessary to reinforce it between the doors. The strongest, cheapest, and most satisfactory way to do this was to ceil that side of the silo with an extra thickness from the bottom to the top, using half-inch lumber, the same as that with which the silo was lined. The doorways were, of course, left in the middle of

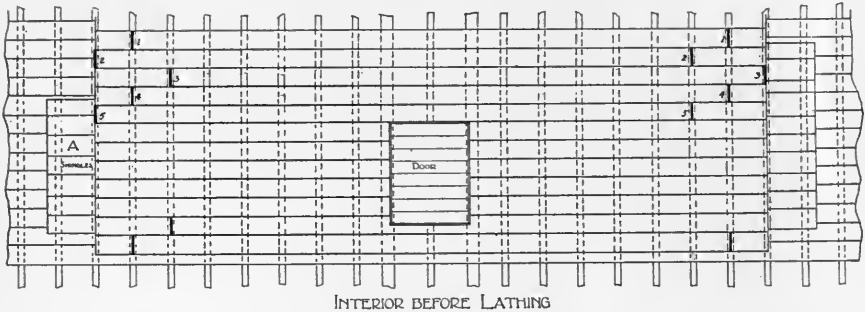

CUT 17.—DETAIL OF EXTRA LINING SHOWING METHOD OF REINFORCING THE SIDE OF SILO IN WHICH DOORWAYS WERE LEFT. FIGURES INDICATE ENDS OF BOARDS SHOWING METHODS OF BREAKING JOINTS ON INNER LINING.

this extra ceiling and the spaces between the doors were thus covered with two thicknesses, with no broken joints for 14 feet, as shown in Cut 17. The ends of the boards of this inner lining broke joints on three studs so that all of the strain at the end of these boards should not come at one stud. These irregular ends were filled out with short pieces so that the edge of the extra thickness would come in a straight line. Since this inner ceiling left a jog of a half inch, the thick edge of common shingles was butted against the ends of the half-inch boards, thus running the extra thickness down to a feather-edge and making an apparently even surface on which to lath. (Cut 17.)

The silo was then lathed with common four-foot lath, breaking joints as shown in Cut 18, and nailing the lath solid to the half-inch ceiling without furring out. It is usually recommended in lathing silos that the edges of the lath be cut on a bevel so that when nailed to the wall a dove-tailed joint is formed for the mortar, or that the lath be set out on furring strips so that the mortar may clinch behind the lath. Experience shows that this is entirely unnecessary.

The plaster was made of one part Portland cement to two parts of good sharp sand. Two coats of this mortar were used making the plaster a full half-inch thick over the lath. The second coat extended continuously from the bottom of the brick work to the top of the silo, uniting the foundation and the superstructure and giving an air-tight wall for the entire silo.

Four doors were made of two thicknesses of common flooring run in opposite directions with tar paper between. These doors are each 20 inches wide, $2\frac{1}{2}$ feet high, and are four feet apart. The top of the upper door is five feet below the plate, but by the time the silo

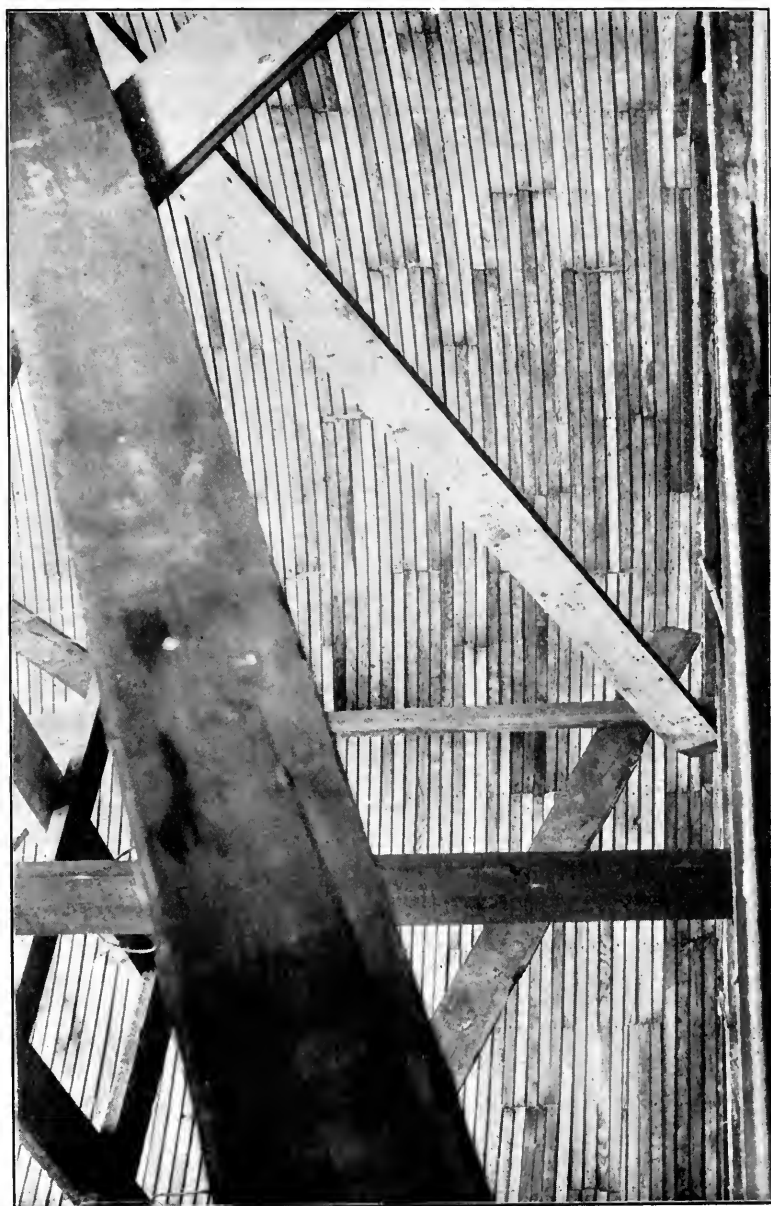

CUT 18.—INTERIOR OF SILO SHOWING LATH AND STAGING.

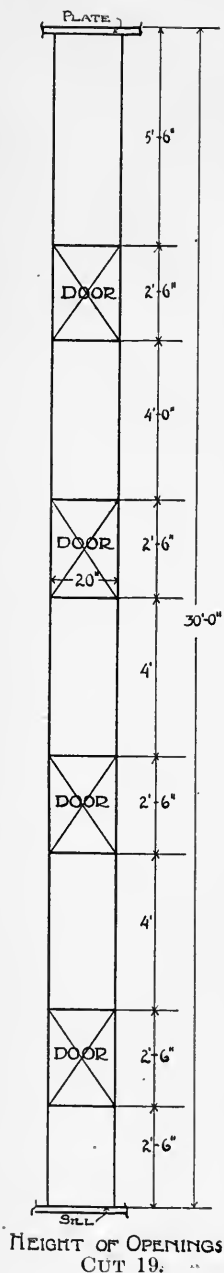

is opened the silage has usually settled nearly to the top of the upper door so that but little silage has to be removed before the door can be taken out. The size and location of the four doors are shown in Cut 19 and a section of one of them in Cut 16.

Authorities on silo construction have erroneously stated that for silos 20 feet in diameter and 30 feet deep, three thicknesses of half-inch lumber are required to give sufficient strength. This silo is 30 feet in height above the foundation and as the pressure of silage at this depth is 330 pounds per square foot there is a tensile pull on the sides of the bottom foot of a silo of these dimensions of 3300 pounds. In this lower foot to resist this strain, there are, of course, two boards each one-half inch thick and six inches wide, making a total area of six square inches of lumber. On account of the great tensile strength of wood it was thought that this one layer of half-inch lumber would be sufficient to withstand the strain. To determine if this were true, the silo as shown in Cut 15 was filled and after standing six weeks did not show the slightest sign of giving in any particular.

In order to preserve the silo in good condition it is absolutely necessary that the half-inch lumber with which the silo is ceiled, be protected from dampness. To this end the plaster must be of good quality and kept perfectly water-tight by cementing up any cracks that may appear, so that the wood shall receive no moisture from the silage. The wall must also be ventilated, for by allowing a free circulation of air between the sheeting and the lining, the lumber will be kept dry. In this silo a two-inch space was left at the top above the plaster and below the plate. In this way the air was allowed free access to enter from the bottom, between the outside covering and the inside lining, and pass into the silo through the openings at the top. These spaces were covered with heavy wire netting of one-third inch mesh to keep out rats and mice. (Cut 20.)

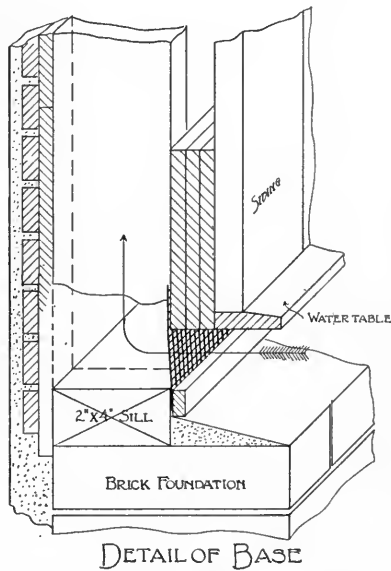
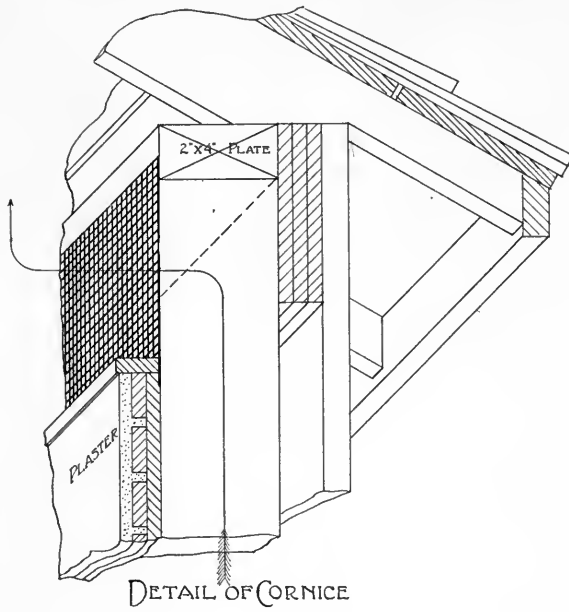

CUT 20.—DETAIL AT TOP AND BOTTOM OF SILO SHOWING SYSTEM OF VENTILATING THE WALL. OPENINGS COVERED WITH WIRE NETTING TO KEEP OUT RATS AND MICE.

Theoretically the outside covering should be put on horizontally so that the strength of the material which forms the cover might add to the strength of the silo. There are, however, several practical difficulties in putting sheeting on in this manner. The lumber cannot be more than a half-inch thick and spring to a circle twenty feet or less in diameter, and any siding as thin as this, which is carried in stock, is practically clear lumber and necessarily high priced. Another difficulty is that the only half-inch stuff that can be purchased at the lumber yard, which will make a water-tight cover, is common house siding. This, in order to be sprung to a circle, must be rabbeted on the back side of the thick edge so as to fit over the thin edge of the board below and allow the siding to lie flat against the studs. Rabbeted siding cannot usually be obtained at a lumber yard and it is extra trouble and expense to have this work done at a mill. Another serious difficulty in putting the siding on horizontally is that at the end of each board there is a strong outward pull against the nail heads and as soon as the boards become slightly decayed at the ends they are likely to pull off over the nails.

Owing to these objections and to the fact that it was our aim to use, as nearly as possible, lumber that is carried in stock by all lumber yards, it was decided to put hoops on the outside and build them up of the same half-inch material as the inside sheeting. This was done by using three thicknesses and breaking joints, thus making a strong six-inch hoop $1\frac{1}{2}$ inches thick. Seven of these were placed around the silo between the doors to make a continuous even surface on which to nail the sheeting. The silo was sheeted up and down with common 1x12 barn boards 14 and 16 feet long, and the cracks were covered with common three-inch battens.

Some silos are sheeted on the outside with the same half-inch lumber as is used on the inside, having the edges cut to a bevel so that the cracks slant outward and downward. The same difficulties are encountered here, however, as were mentioned above and such siding is not perfectly water-tight as the rain may drive in between the cracks. When the siding is put on horizontally it should be carried up as fast as the ceiling inside, thus obviating the necessity of building staging on the outside.

After the silo wall was completed a conical shingled roof was put on, a chute built over the doors through which the silage is thrown down, and the small space between the silo and the barn roofed over, connecting the two. The silo was then completed ready for painting. (Cut 21.)

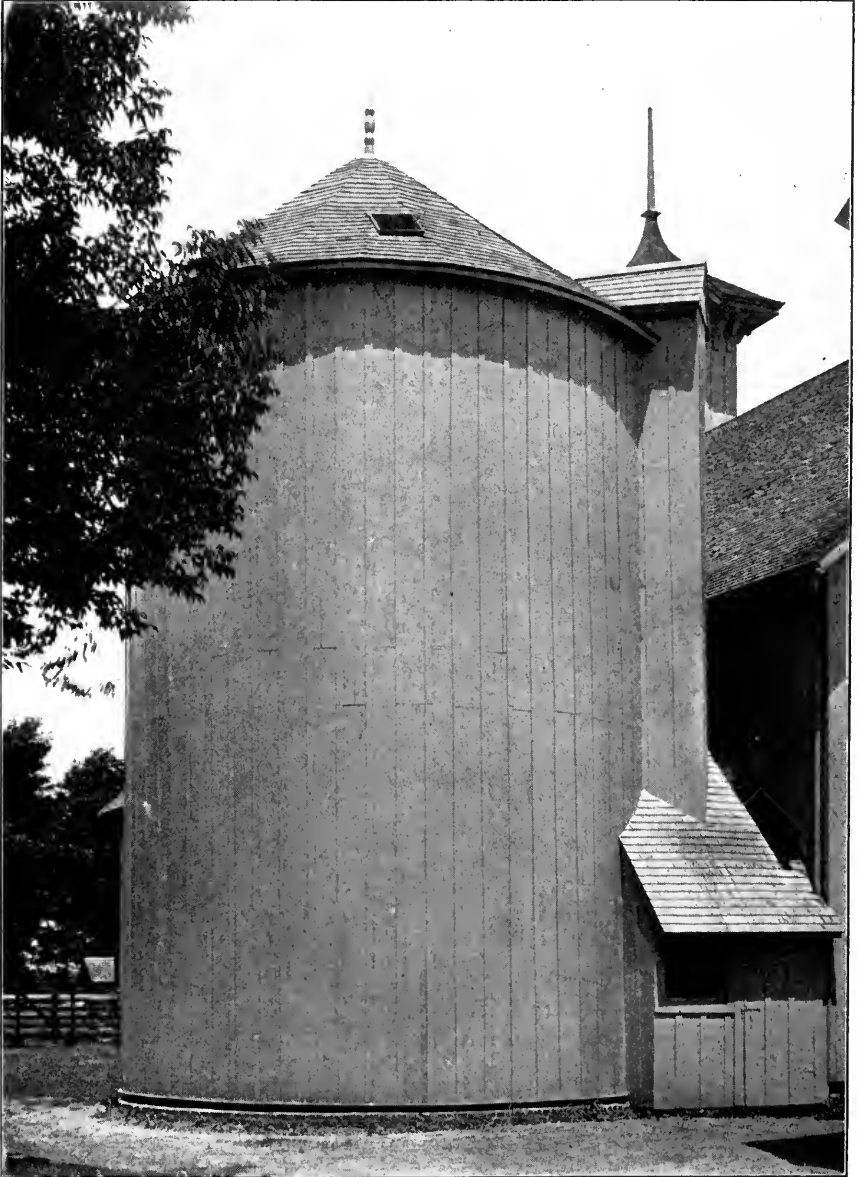

CUT 21.—THE SILO COMPLETE, SHOWING CHUTE THROUGH WHICH THE SILAGE IS THROWN DOWN, AND CONNECTION WITH THE BARN. THE SMALL DOOR IN THE ROOF IS TO ADMIT BLOWER PIPE WHILE FILLING.

The silo has been filled twice and both years the silage has kept perfectly from the bottom to the top, even next the wall and against the doors. As before mentioned the top of the brick wall cracked, as it was not reinforced, and the silage spoiled slightly at this place, but this can easily be remedied another year.

In the spring of 1904 when the cows were turned out to pasture, about seven feet of silage remained in the silo. The small silo for summer feeding was then opened and the rotten silage from the top of the small silo was distributed over the good silage in the large silo to the depth of about six inches. This was thoroughly soaked and tramped firmly. When ready to fill again in the fall there were about eight inches of rotten silage to remove, only two inches of the good silage having spoiled. Fresh corn was run on the top of this and the whole kept perfectly. When feeding out, scarcely any trace of spoiled silage was to be found at the union of the silage of the different years.

The cost of this silo, which was 20 feet in diameter and 34½ feet deep, holding 228 tons, was \$383.00 or \$1.68 per ton capacity.

ITEMIZED COST OF SILO

Foundation—

Excavating 4 feet deep and laying wall		
35 hours at 30 cents	\$10.50	
70 hours at 15 cents	10.50	
2,000 brick at \$7.25	14.50	
2 barrels cement at \$2.00	4.00	
2 barrels lime	1.55	\$41.05

Superstructure—

139—2x4—16 feet, 1,482 feet at \$20.00	\$29.64	
252—½x6—16 feet, 2,016 feet at \$14.00	28.22	
4 doors 20x30 inches double, 33⅓ at \$23.0077	
3,100 lath at \$4.50 per M	13.95	
11 barrels cement at \$2.00	22.00	
6 yards sand at \$1.25	7.50	
Carpenters, 67 hours at 30 cents	20.10	
Labor, 148 hours at 15 cents	22.20	
Plastering, 28 hours at 40 cents	11.20	
Tender, 35 hours at 15 cents	5.25	160.83

Sheeting—

7 hoops—84— $\frac{1}{2}$ x6—16 ft. 672 ft. @ \$14.00.	9.41	
61—1x12—16 ft. 976 ft. at \$24.00.....	23.42	
61—1x12—14 ft. 854 ft. @ \$24.00.....	20.50	
61 battens $\frac{1}{2}$ x3—16 ft. 244 ft. @ \$22.00..	5.37	
61 battens $\frac{1}{2}$ x3—14 ft. 214 ft. @ \$22.00.....	4.70	
65 ft. 2 $\frac{1}{2}$ in. water table @ \$3.00 per C.....	1.95	65.35

Roof—

18—2x4—14 ft. 168 ft. @ \$19.00.....	3.19	
3—2x4—12 ft. 24 ft. @ \$19.00.....	.46	
4,000 shingles @ \$3.20 per M.....	12.80	
35 roof boards 1x6—16 ft. 280 ft. @ \$16.00..	4.48	
Cornice, 5—1x12—16 ft. 80 ft. @ \$24.00...	1.92	
Ornamental post in center.....	.90	23.75

Chute—

5—2x4—14 ft. 47 ft. @ \$19.00.....	.89	
12—1x12—16 ft. 192 ft. @ \$24.00.....	4.61	5.50

Carpenter work on roof, sheeting of silo and chute—

54 hrs. @ 30c.....	16.20	
120 hours @ 25c.....	30.00	46.20

Hardware—

Nails.....		
50 lb. 8d common @ 3c.....	1.50	
2 lb. 10d common @ 5c.....	.10	
8 lb. 3d cut @ 4c.....	.32	
6 lb. 6d cut @ 4c.....	.24	
4 lb. shingle @ 4c.....	.16	
2 lb. long finishing @ 5c.....	.10	
Wire netting—		
63 sq. ft. $\frac{1}{3}$ in. mesh @ 5 $\frac{1}{2}$ c.....	3.47	5.89

Painting—

Priming coat,		
9 gal. oil @ 50c.....	4.50	
29 lb. yellow ocher @ 5c.....	1.45	
25 hours labor @ 15c.....	3.75	
Paint and labor, two coats.....	25.00	34.70

Total cost..... 383.27

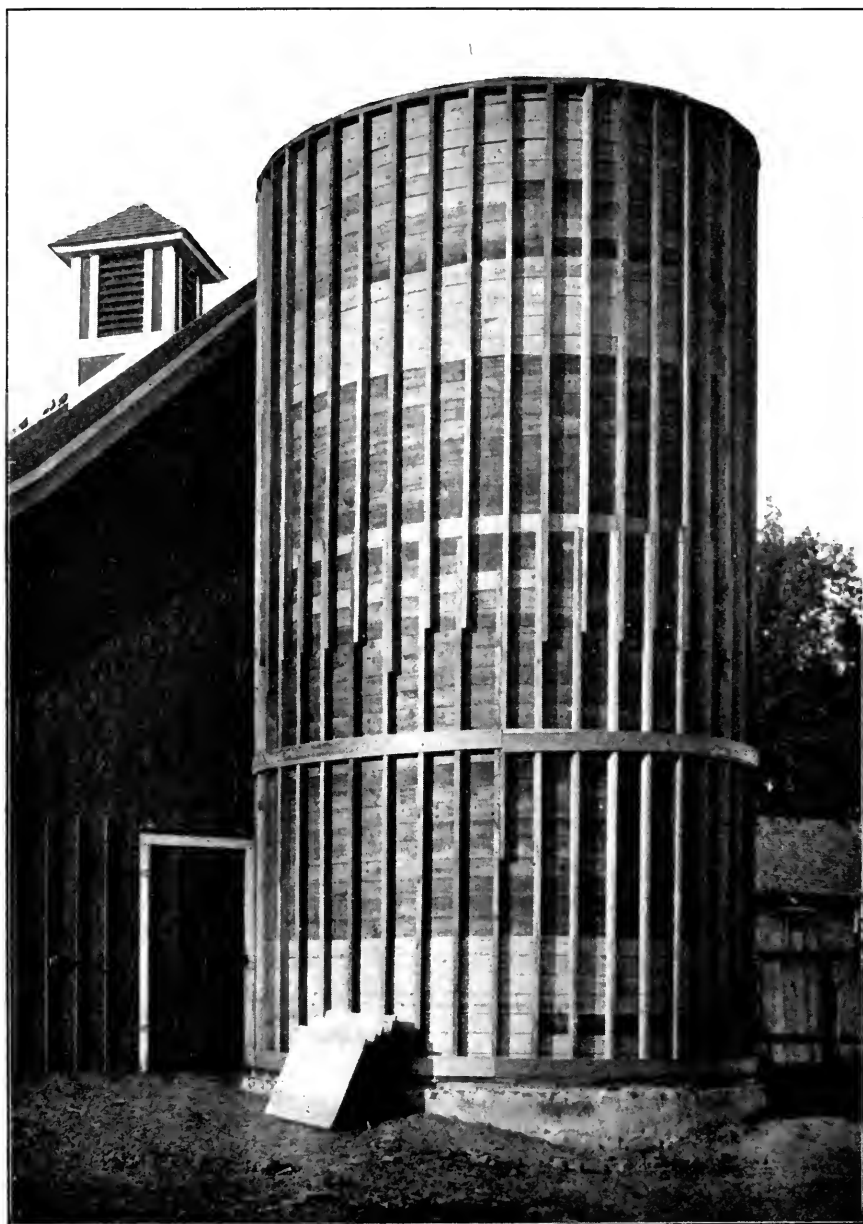

CUT 22.—SILO CEILED ON THE INSIDE WITH TWO THICKNESSES OF HALF-INCH LUMBER WITH PAPER BETWEEN. BARN WAS BUILT OVER SILO LATER.

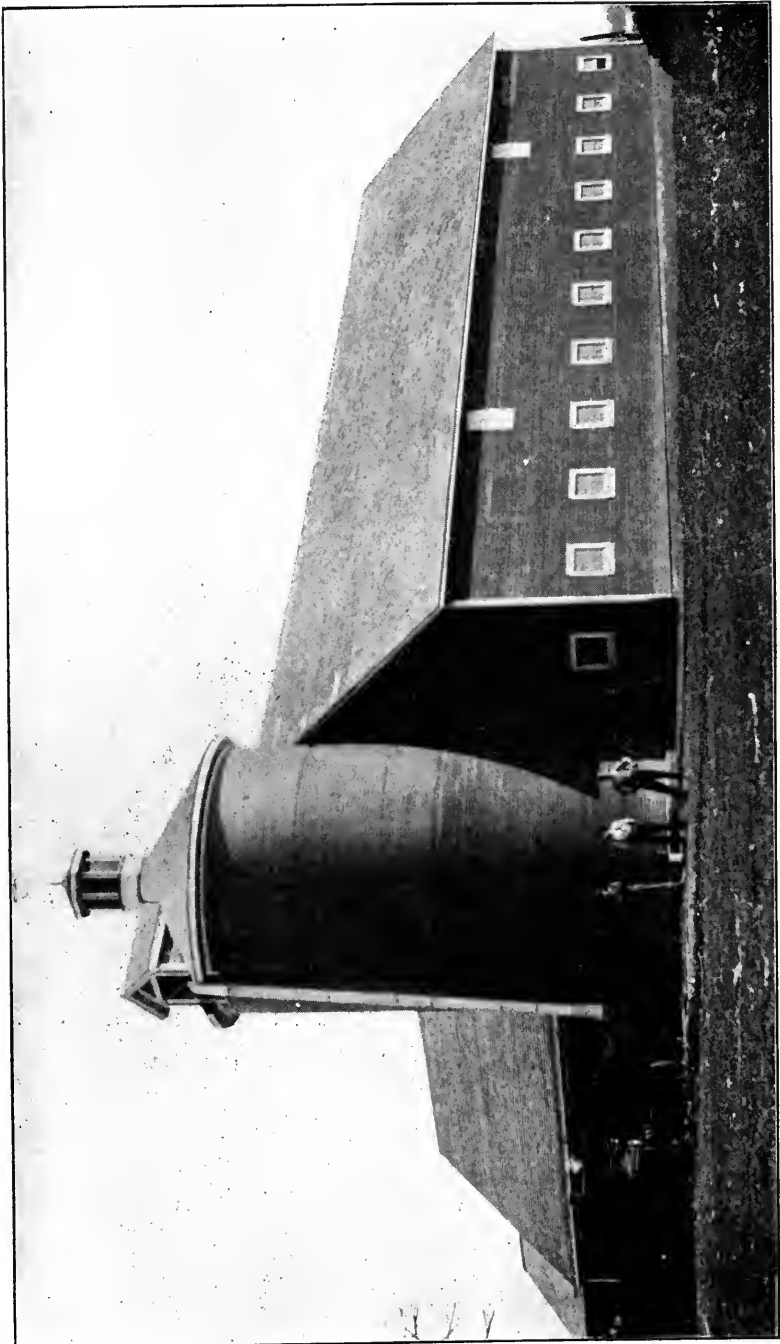

CUT 23.—SAME CONSTRUCTION AS SHOWN IN CUT 22. COVERED ON OUTSIDE WITH BEVELED HALF-INCH LUMBER.

Many silos are built similar to the one just described excepting that in place of the lath and cement plaster the silo is ceiled with another thickness of half-inch lumber, using water-proof paper between. That the lining shall be tight, the boards must be of the same width and it is necessary to have the lumber, dressed so that the boards will be of the same thickness and will lie closely together. This makes a fairly good silo for a few years, if built of durable wood, but it is practically as expensive and does not preserve the silage so thoroughly.

The exterior covering of this style of silo may be the same as for a plastered silo. If built inside the barn no roof or outer sheet-



CUT 24.—TWO SILOS OF SAME CONSTRUCTION AS SHOWN IN CUT 22, SHEETED WITH HALF-INCH LUMBER; ONE ON LEFT ALSO COVERED WITH TAR PAPER.

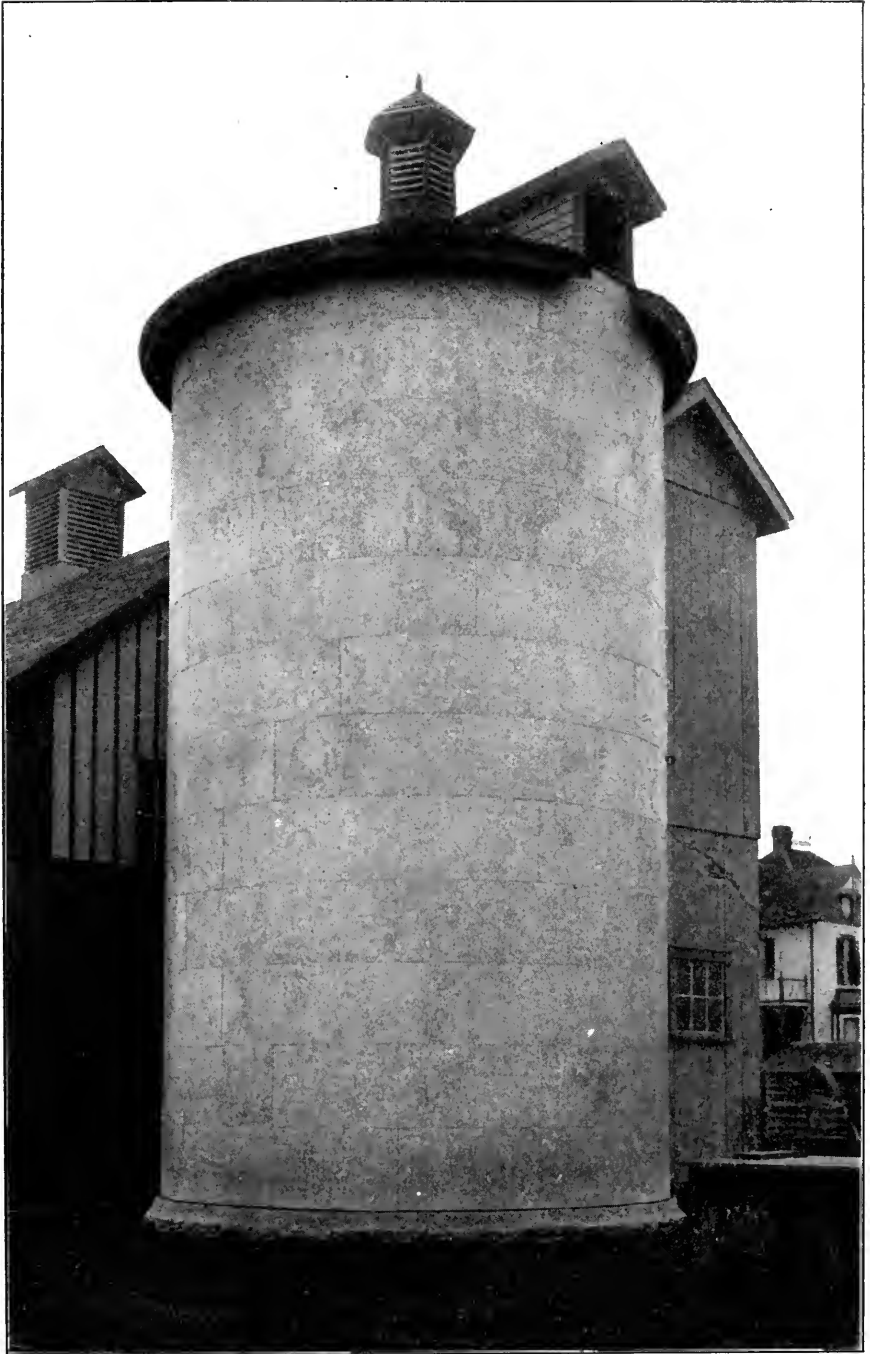

CUT 25.—SAME CONSTRUCTION AS SHOWN IN CUT 22; SHEETED WITH HALF-INCH LUMBER TO A HEIGHT OF SIX FEET AND COVERED WITH GALVANIZED IRON. AN EXPENSIVE COVERING BUT DURABLE AND SAVES PAINTING

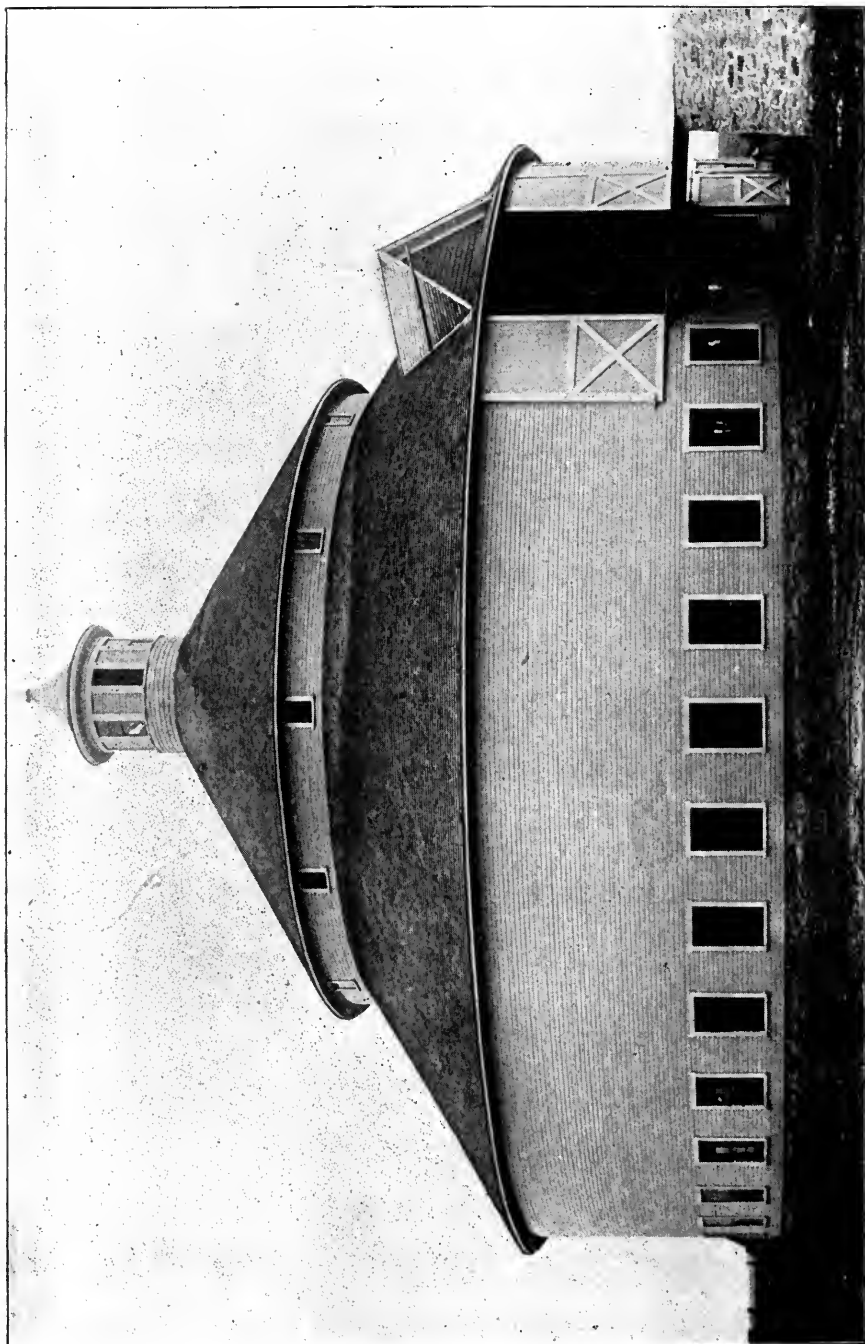

CUT 26.—A CIRCULAR DAIRY BARN WITH SILO IN CENTER 24 FT. IN DIAMETER AND 45 FT. DEEP.
SAME CONSTRUCTION AS SHOWN IN CUT 22.

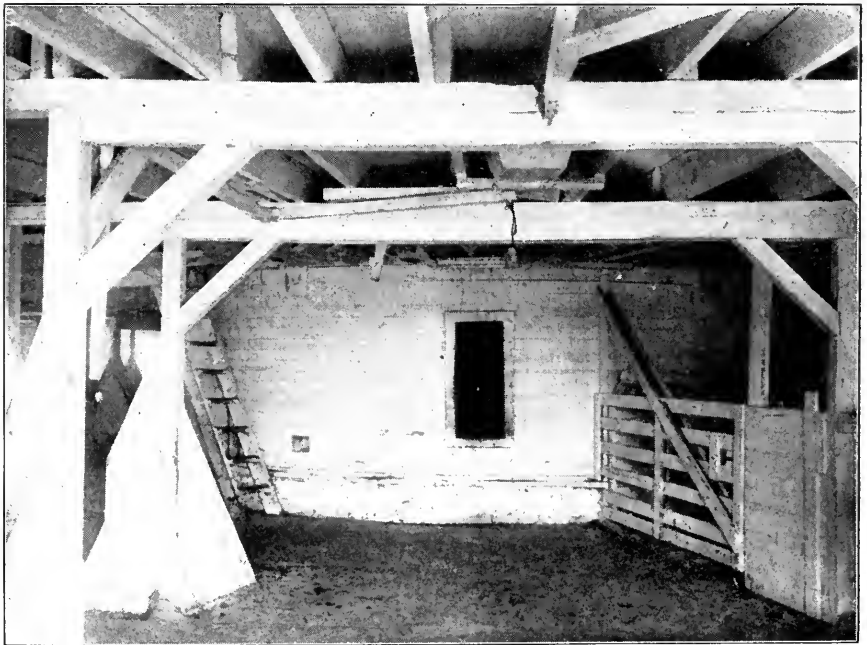
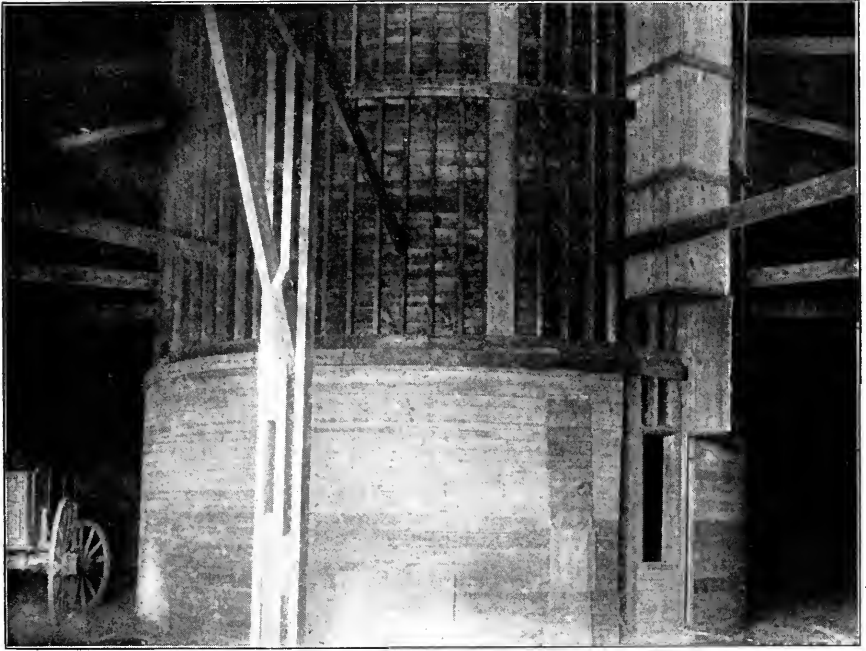

CUT 27.—SILO IN CENTER OF BARN SHOWN IN CUT 26. UPPER PORTION IN HAY LOFT, LOWER PORTION IN COW STABLE.

ing is necessary. In Cut 22 is shown a silo of this construction where the barn is built over it. Cut 23 shows a silo of this style ceiled with beveled half-inch lumber. In Cut 24 are shown two silos of the same construction sheeted with half-inch lumber; one being covered with tarred felt.

The silo shown in Cut 25 is sheeted with half-inch lumber to a height of six feet and the entire surface is covered with galvanized iron. This makes a good covering but it is rather expensive as the iron costs about 5 cents a square foot.

From what we now know, the round wood silo plastered with cement seems to be the best construction, but the indications are that when we learn to handle concrete to the best advantage this will be the material for building silos.

CONCRETE SILOS

Silos built of concrete have been 30 feet deep with the wall not more than six inches thick at the base and tapering to four inches at the top. Where gravel or crushed stone can be obtained at a reasonable price it may be advisable to make the walls slightly thicker, and in cold climates they should be built with a dead-air space in the wall to prevent the silage from freezing. In any event there should be enough heavy wire or iron rods imbedded in the wall to withstand the strain of the silage; unless this is done cracks are likely to appear. The amount of wire necessary in each case will depend upon the size and depth of the silo. The wall should be plastered on the inside with one part of Portland cement to two of good sharp sand troweled to a smooth surface. This will resist the action of the acid in the silage.

Cut 28 shows an all-concrete silo 20 feet in diameter and 42 feet deep. The wall is 22 inches thick for the first 14 feet, 19 inches thick the next 14 feet, and 16 inches thick the upper 14 feet. This silo cost approximately \$1200, and as it holds 334 tons, the cost per ton was \$3.59. While the first cost of this silo was high it may prove economical in the end as it should stand for more than a hundred years.

It is essential that a concrete, stone, or brick silo have a good foundation, otherwise it is likely to settle unevenly and cracks will appear in the wall, giving the air a chance to enter. If the silo is put at least three feet into the ground this assures a firm footing and also adds to the depth of the structure.

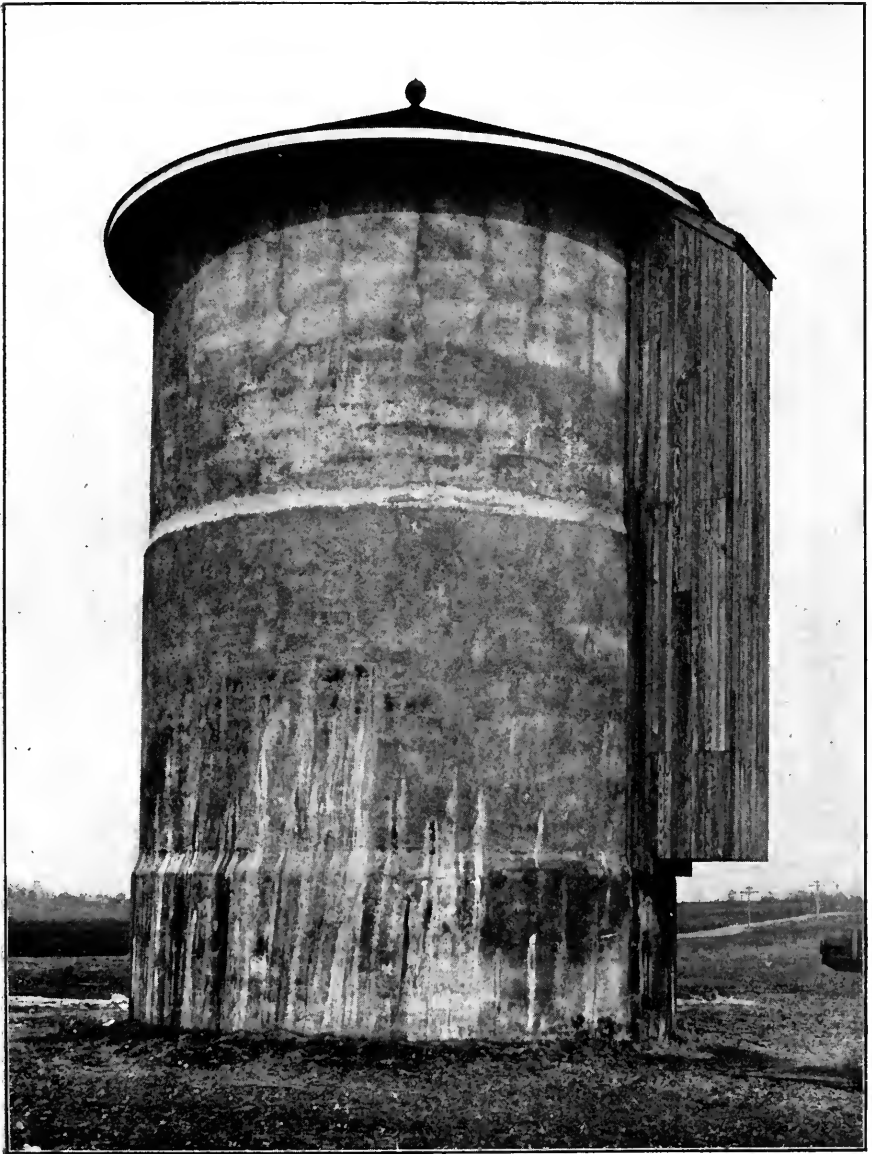

CUT 28.—CONCRETE SILO 20 FEET IN DIAMETER AND 42 FEET DEEP;
CAPACITY 334 TONS.

There are great possibilities in reinforced concrete and a circular structure is the best to be easily reinforced. Silos have been built of concrete but usually with solid walls and much thicker than necessary. The method of construction heretofore has in most cases been cumbersome, requiring a large amount of lumber to construct the forms. With unskilled labor the question of concrete silos is still a problem. Good grades of cement are now manufactured in the state and are becoming much cheaper. Machines have already been made with which reinforced continuous hollow walls are built with comparative ease, and when we learn how to handle cement to the best advantage possible this will, undoubtedly, be the silo of the future, especially in sections where sand and gravel or crushed stone are abundant.



CUT 29.—BRICK SILO WITH DEAD-AIR SPACE IN WALL.

We expect to investigate the subject of concrete silos during the coming year and erect one or two small ones of this construction at the University.

BRICK SILOS.

Where brick is cheap and stone and gravel scarce, a brick silo may be the most economical. In large brick silos the wall is usually built with three or four courses of brick at the base and made a course thinner at various heights until reaching the upper ten feet, which need not be more than eight inches thick. Cut 29 shows a brick silo built on this plan. This silo rests upon a seven-foot stone



CUT 30.—STONE SILO 18 FEET 10 INCHES IN DIAMETER AND 30 FEET DEEP;
CAPACITY 156 TONS. COST ABOUT \$600

foundation 18 inches thick; six feet of it being below the ground. Upon this are laid three courses of brick, the middle course being of brick tile which contains a dead-air space and thus prevents freezing to a great extent. This wall extends twelve feet above the foundation and from that point to the top, two courses of brick are used with one and a half inch air space between. One silo 16 feet in diameter and 30 feet deep, built in this manner, holds 120 tons and cost \$250, or \$2.08 per ton. Another silo of the same depth and 19 feet in diameter holds 168 tons and cost \$350, or \$2.08 per ton, the same as the smaller silo.

STONE SILOS

Where stone can be easily and cheaply obtained silos may be built of this material. Cut 30 shows a stone silo which is 18 feet 10 inches in diameter and 30 feet deep, holding 156 tons. The wall of this silo is two feet thick and extends five feet into the ground. The portion below the surface is made of hardheads while that above is of quarry stone obtained from a neighboring farm. The inside is plastered with Portland cement. The first door is 2x6 feet, the next 2x3 and the upper 2x4 feet. This silo cost \$500 besides the



CUT 31.—STONE SILO 20 FEET IN DIAMETER AND 32 FEET DEEP;
CAPACITY 204 TONS. COST NEARLY \$700.

labor of the owner which amounted to about \$100, making the total cost \$600, or \$3.64 per ton capacity. Although the material may be cheap and close at hand the expense of elevating heavy stone for so thick a wall and the employment of a stone mason, which is high priced labor, make a stone silo expensive.

The silo shown in Cut 31, is 20 feet in diameter and 32 feet deep, having a capacity of 204 tons. This silo extends eight feet into the ground, which is too deep, requiring extra labor in removing the silage. The wall of the lower 12 feet is 24 inches thick and above this it is 18 inches. The wall is plastered with a half-inch coat of cement and the bottom is covered with three inches of concrete. Iron rods were laid in the wall just above and below the doors. The stone cost \$3.50 per cord and was hauled seven miles. Sixty-three loads of sand were bought at ten cents a load and hauled four miles. The total cost for material, masons, and carpenter, was \$535, but this does not include excavating, the hauling of material, tending masons, and boarding men. If all these expenses were included it would probably make the total cost about \$700.

Stone silos preserve the silage perfectly and are permanent, requiring little outlay for maintenance; the only objection being the excessive first cost.

STAVE SILOS

There are cases where a cheap, temporary silo may be economical and of great advantage, for example, a farmer may expect to build a new barn in a different place and want a silo near the old barn for a few years only; or a renter may wish a temporary silo and then if he moves in a short time he can take the lumber from a stave silo with him.

The objections to a stave silo are that the staves shrink during dry weather when the silo is empty and unless the hoops are tightened there is a possibility of the silo being racked or blown over. If the hoops are tightened when the staves are dry, there is then danger of the hoops bursting when the silo is filled and the staves again become saturated with moisture. An example of this came under the writer's notice recently when the second morning after a silo was filled, the owner found half the hoops had burst. It will be noticed in the illustrations of stave silos that where they had been put up for any length of time the staves had shrunk allowing the hoops to drop from their original position. A stave silo is usually much

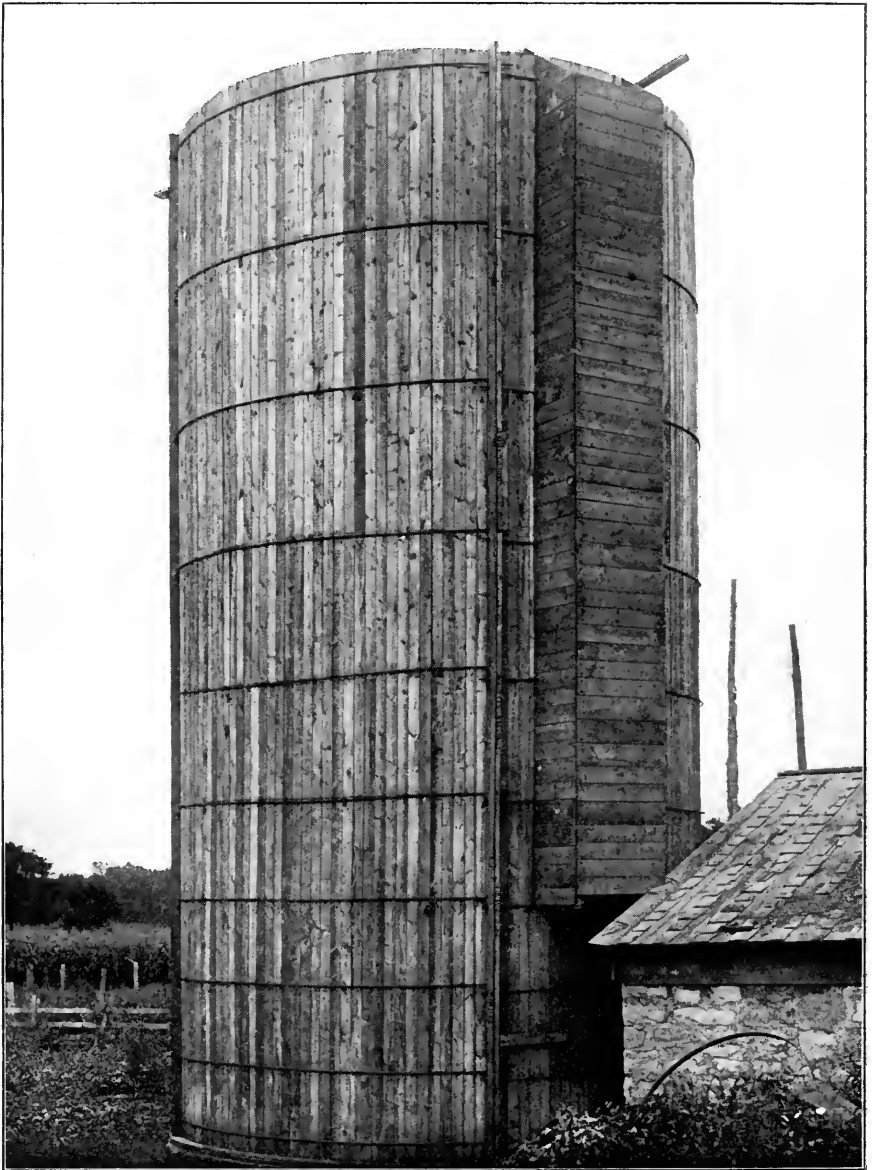

CUT 32.—STAVE SILO WITHOUT ROOF, 16 FEET IN DIAMETER AND 34 FEET DEEP; CAPACITY 150 TONS. TO BE RECOMMENDED ONLY WHERE A TEMPORARY SILO IS DESIRED.

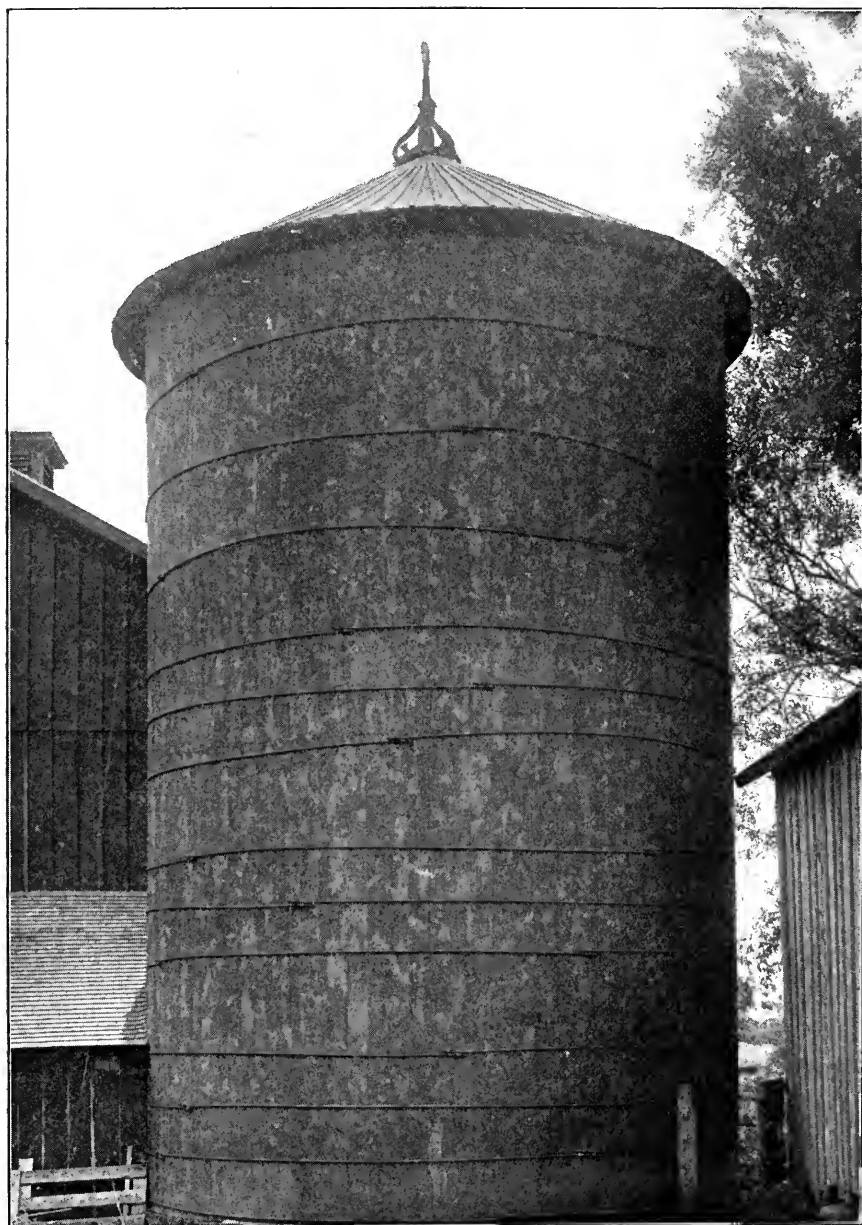

CUT 33.—STAVE SILO 20 FEET IN DIAMETER AND 34 FEET DEEP; CAPACITY 224 TONS. THE STAVES HAVE SHRUNK WHEN EMPTY ALLOWING HOOPS TO DROP FROM ORIGINAL POSITION.

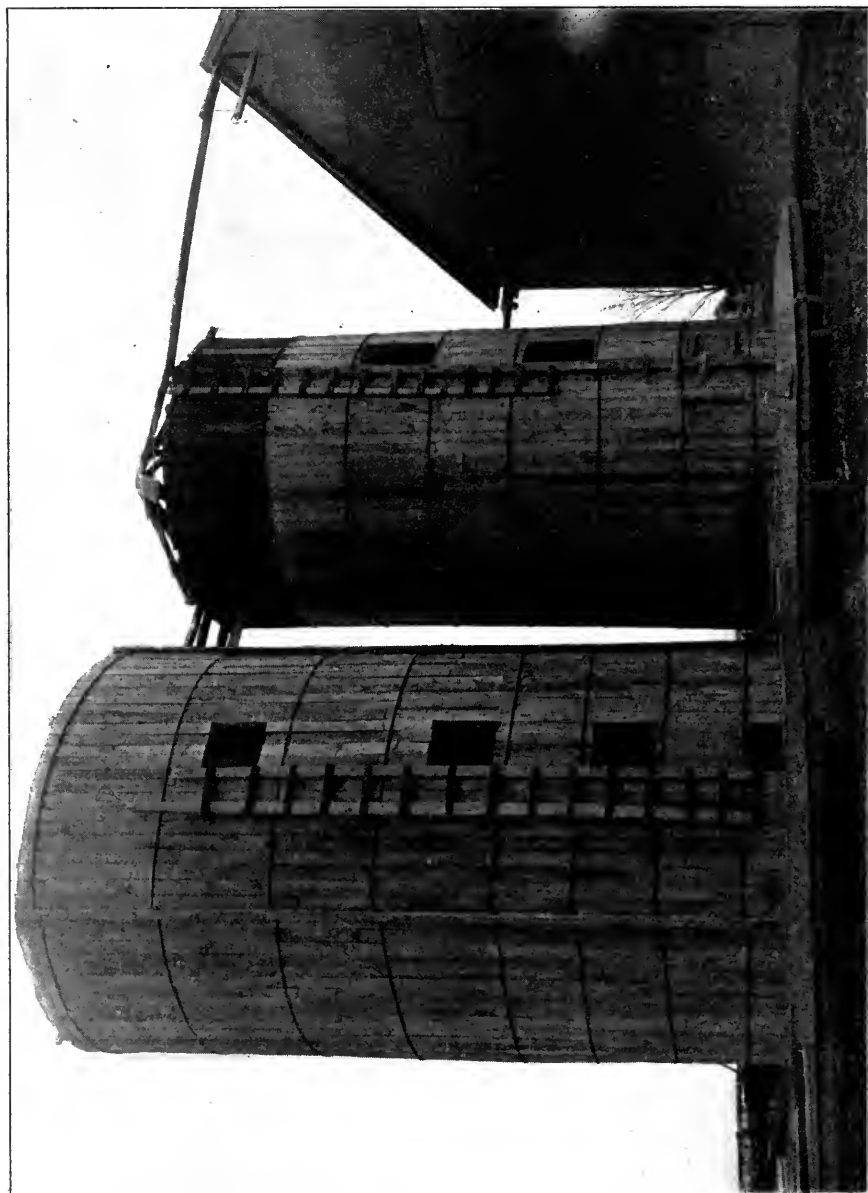

CUT 34.—NOT SUFFICIENTLY STABLE AND TOO SHORT LIVED. ALTHOUGH IN USE BUT A FEW YEARS, SILO ON LEFT BLEW DOWN SOON AFTER PHOTOGRAPH WAS TAKEN.

more satisfactory if a building is built over it for protection, but this makes it expensive.

Cut 32 shows a stave silo recently built. This silo is 16 feet in diameter, 34 feet deep, and has a capacity of 150 tons. The foundation, which extends two feet into the ground, is a brick wall that was laid up by the owner. The silo was built by two carpenters in nine days at \$2.50 a day each, making \$45 paid out for labor. The lumber cost \$80, the iron hoops \$20, and nails and spikes \$2. There being no roof the silo above the foundation cost, including labor, \$147. If the brick had been purchased and the labor of excavating for the foundation and laying the brick charged for, the total cost of the silo would have been approximately \$170 without a roof, or \$1.13 per ton.

The staves were rough white pine, 2x4, 14 and 18 feet long to make the required height. Four 4x6 uprights were placed on the foundation in the circle 90 degrees apart, holes having been bored in them to receive the iron hoops which had threads cut on the ends. The staves were then set in the circle alternating in length so as to break joints. As each 2x4 was set up it was fastened to the next one by means of six inch spikes which were driven through the 2x4's edgewise. Spiking in this way makes the silo much more rigid and it is not so likely to be racked or blown down when empty. When all the staves were in place the silo was tightened by turning up the nuts at the ends of the iron hoops on either side of the 4x6's. The hoops are much closer together at the bottom than at the top to give the added strength necessary where the pressure is the greatest.

Four doors 18 inches wide and two feet high were cut in the side, one above the other, about six feet apart. Outside of these was built a chute to prevent the silage from being blown away when thrown down.

There are several firms who manufacture stave silos and send them out in any size desired, ready to set up. Many of these are made of durable wood and give good satisfaction. One of these silos is illustrated in Cut 33.

While it is true that a stave silo may be used to advantage in some cases, yet where a permanent silo is desired either the wood silo plastered with cement, or the grout, or brick structure will undoubtedly prove most satisfactory, both on account of greater permanency and the better preservation of the silage.



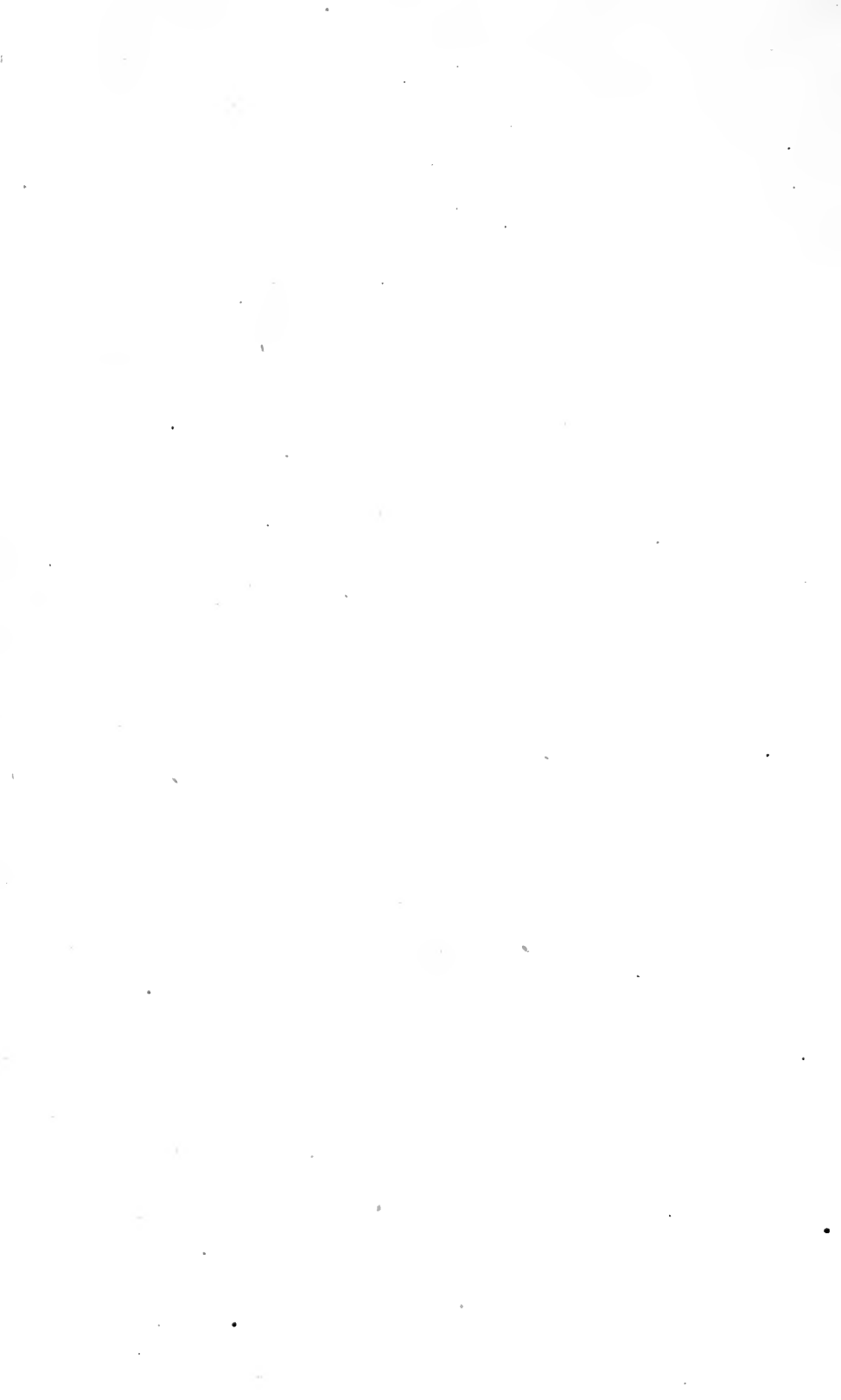



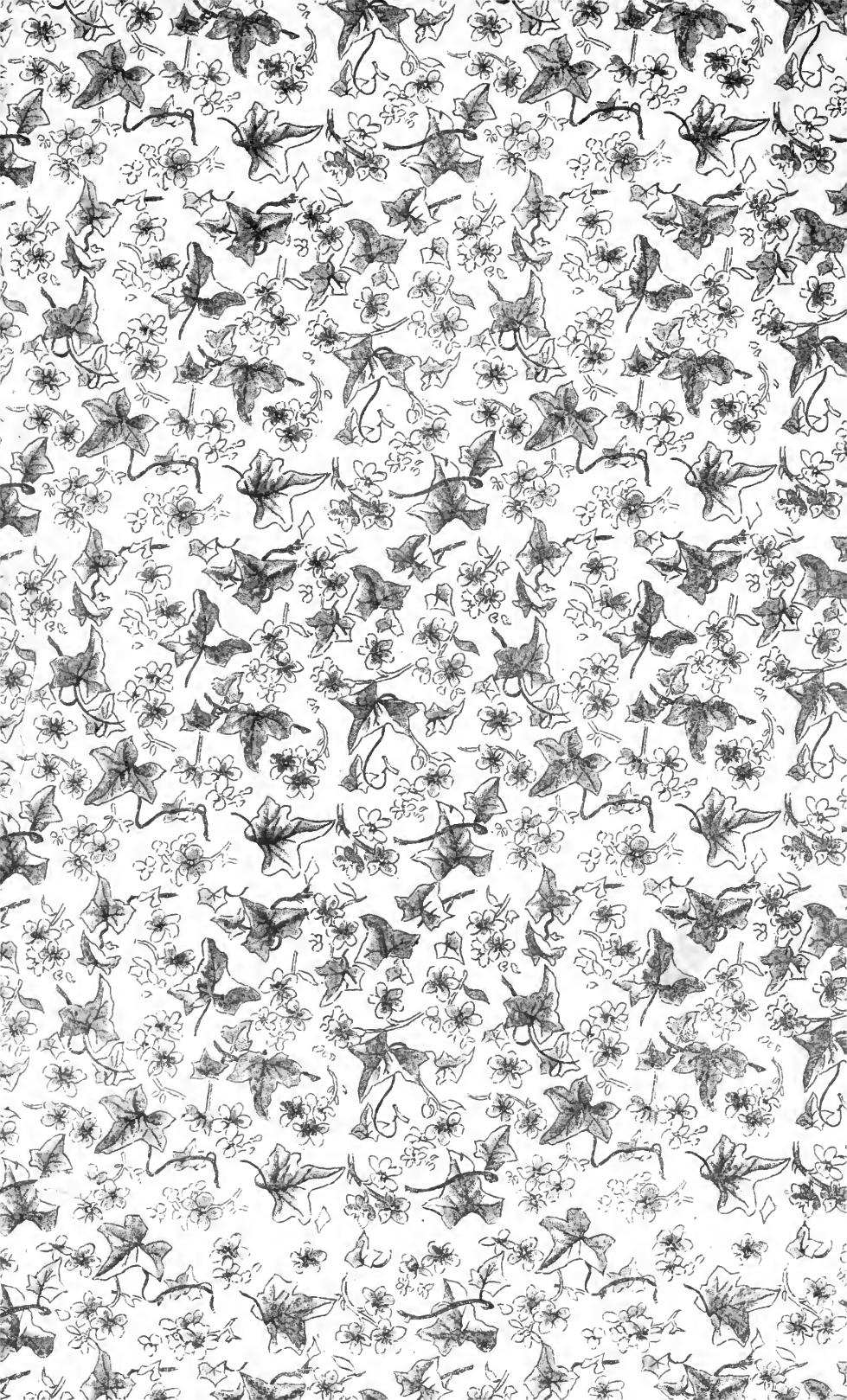

UNIVERSITY OF ILLINOIS-URBANA



3 0112 078530372