

COLUMBIA LIBRARIES OFFSITE
HEALTH SCIENCES STANDARD



HX00025275





COLUMBIA UNIVERSITY
DEPARTMENT OF PHYSIOLOGY
THE JOHN G. CURTIS LIBRARY

John J. Curtis

437 West 59th St.

N.Y.

Digitized by the Internet Archive
in 2010 with funding from
Columbia University Libraries

A COURSE OF
ELEMENTARY
PRACTICAL HISTOLOGY



UNIVERSITY OF CHICAGO
COLLEGE LIBRARY

A COURSE
OF
ELEMENTARY
PRACTICAL HISTOLOGY

BY
WILLIAM FEARNLEY

London
MACMILLAN AND CO.
AND NEW YORK
1887

YUOJOI8YH30THE81M7AS0
YH88VLD / 1E8UJ09

QM 555
F31

RICHARD CLAY AND SONS,
LONDON AND BUNGAY.

Dedicated

TO

E. KLEIN, M.D., F.R.S.

WITH THE MOST SINCERE REGARDS

OF HIS PUPIL

THE AUTHOR.

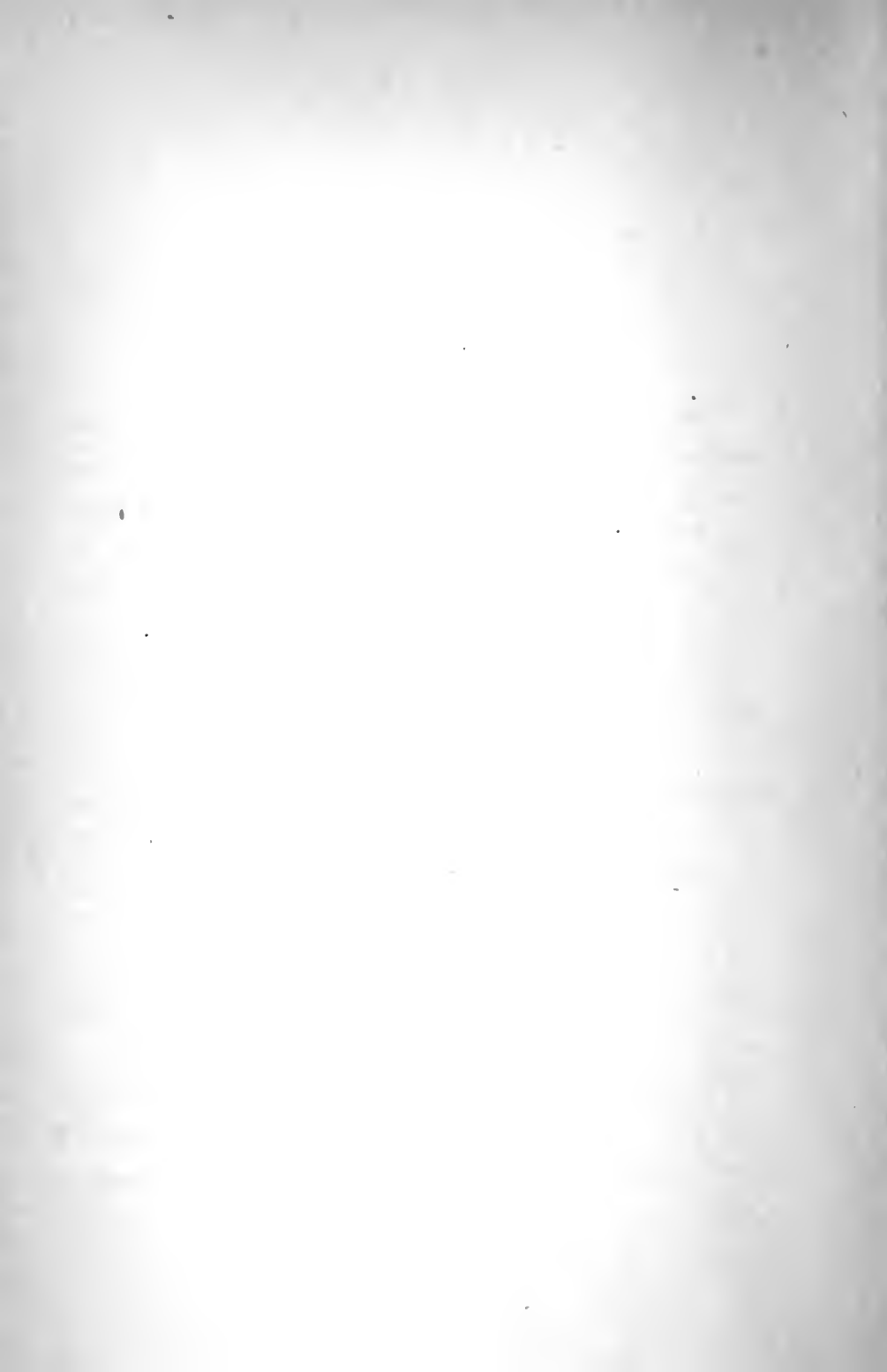

PREFACE

THIS work is not only intended for medical students working in a well-furnished laboratory under a teacher, but for students of all denominations who can command the means and have the wish to construct for themselves a histological cabinet for study and future reference.

With this object in view it differs from all other textbooks of histology in several particulars, but notably these : It contains a list of all the apparatus required ; the classification of the structures which have to be collected is novel ; and it contains much detail in the various processes anticipating the absence of a teacher.

Every process has been thoroughly tested, so that however imperfect these processes may be, such as they are, they can at least be relied upon.

The work should be gone through thus : First collect the necessary apparatus ; next work through the exercises ; then collect and prepare the tissues ; and finally

prepare the permanent slides. Few of the demonstrations of Part II. can be prepared altogether beforehand : most will require some preparations at the time ; but this in the nature of the case is unavoidable.

Amongst many others I am more especially indebted to the writings of the following physiologists : Brunton, Foster, Frey, Huxley, Klein, Purser, Ranvier, Rutherford, Schäfer, and Stirling.

I am also indebted to Mr. Martin J. Cole for some of the processes, and to Mr. T. P. Collings for the able manner in which he has executed the drawings and wood-engravings.

In conclusion I ask much forbearance on the part of teachers, students, and readers generally, and inform them that the immense amount of laboratory work and the recording of results have all been conducted between the numerous and unavoidable interruptions of a family medical practice.

W. F.

LONDON, *1st May*, 1887.

CONTENTS.

PART I.

	PAGE
A. MICROSCOPY	1—33
B. APPARATUS, REAGENTS, AND SOME MINOR OPERATIONS	34—61
C. TEASING	61—63
D. IRRIGATING	63
E. GASES AND VAPOURS	64
F. APPLYING HEAT TO TISSUES	65
G. INJECTING	65—83
H. DISSECTING	88—92
I. HARDENING AND SOFTENING	93—102
J. EMBEDDING	102—117
K. SECTION-CUTTING	117—131
L. STAINING	132—141
M. DEHYDRATING AND CLEARING	142—143
N. MOUNTING	144—150
O. PRACTICAL EXERCISES	150—161
P. THE COLLECTION AND PREPARATION OF MATERIAL	162—204
Q. TWO SHORT METHODS OF PREPARING SECTIONS.	204—207

PART II.

	PAGE
INTRODUCTION	209
I. THE VEGETABLE CELL	211—215
II. THE ANIMAL CELL	216—219
III. AMPHIBIAN AND HUMAN BLOOD-CORPUSCLES .	220—222
IV. ACTION OF REAGENTS ON BLOOD-CORPUSCLES .	223—227
V. EPITHELIUM	227—232
VI. AREOLAR AND ADIPOSE TISSUE	232—235
VII. WHITE FIBROUS AND YELLOW ELASTIC TISSUES	235—238
VIII. CARTILAGE	238—242
IX. BONE	243—247
X. DEVELOPMENT OF BONE	248—251
XI. MUSCLE	251—255
XII. NERVE-FIBRES	256—259
XIII. BLOOD-VESSELS	260—262
XIV. LYMPH SPACES AND CHANNELS	263—265
XV. LYMPHATIC GLANDS, TONSILS, AND THYMUS .	266—268
XVI. SKIN, HAIR, AND NAILS.	269—277
XVII. TRACHEA, BRONCHI, AND LUNGS	278—282
XVIII. THE TEETH AND TONGUE	283—286
XIX. THE SALIVARY GLANDS AND THE PANCREAS .	287—288
XX. ŒSOPHAGUS, STOMACH, AND DUODENUM . .	289—292
XXI. SMALL AND LARGE INTESTINES	293—297
XXII. THE LIVER	298—302
XXIII. THE DUCTLESS GLANDS	303—306
XXIV. THE KIDNEYS	307—312
XXV. THE URETER, BLADDER, AND MALE GENERA- TIVE ORGANS	313—317
XXVI. THE FEMALE GENERATIVE ORGANS. . . .	317—324
XXVII. TERMINATIONS OF NERVE-FIBRES . . .	324—326

CONTENTS.

xi

	PAGE
XXVIII. THE SPINAL CORD, NERVE-CELLS, AND GANGLIA	327—332
XXIX. ORGANS OF TASTE AND SMELL	333—335
XXX. ORGANS OF VISION }	336—346
XXXI. „ „ }	336—346
XXXII. ORGANS OF HEARING	346—354
XXXIII. THE BRAIN AND MEDULLA OBLONGATA }	354—356
XXXIV. „ „ „ „ }	354—356
APPENDIX	357—359



PRACTICAL HISTOLOGY.

PART I.

A.—MICROSCOPY.

A 1.—**The Laboratory.** A room of the house facing the north should, if possible, be chosen. It need not be a large room, but it should be provided with a large cupboard and plenty of shelving and have a cold-water tap in it.

It ought to have a long and broad fixed work-table, of sufficient height, a hand-breadth below the worker's elbow, to allow work to be conducted with comfort in the standing position. It is convenient to have a wooden, rectangular, oblong trough let into it to act as a nest for the microscope and the microscope-lamp. This trough should be about one-fourth wider than the base of the microscope, and should have its long axis the whole breadth of the table: its depth may be six cm. The microscope need never be removed from this recess, but should be covered by a large old silk handkerchief when not in use.

A 2.—**An Index Needful.** There are so many little things required in a histological laboratory, few of these being required for use at any one time, that drawers and shelves are especially needful. An index, such as a "Where is it?"—a book sold by stationers for registering addresses—is almost an essential. The drawers and shelves must be labelled with distinctive marks, such as letters of the alphabet or numerals; then everything taken into the laboratory whose proper place is not on the work-table should have a place in a drawer or shelf selected for it, and the thing under its proper index letter; thus, paraffin melting at 37° C. under letter P, put in its own place. Whenever this particular paraffin is wanted the index shows its whereabouts, and it should be put back in its place after use by reference to the index if necessary. This simple precaution will save time and keep the laboratory free from accumulations of odds and ends which invariably get in one's way whilst working.

A 3.—**A Diary is Essential.** When hardening or treating tissues in any way, so many hours or so many days are prescribed. We perhaps place fifty tissues in five or six different media on the same day: the times of changing and the media into which they are to be changed must be arranged at the time. When these very various times come it is impossible to remember. We therefore turn to the various days and mark down what is to be done. This necessitates a daily reference to the diary to see what requires doing. After clearing the work-table for the day's work, a most necessary proceeding for those not

gifted with the habit of putting away everything at the time of using, the very first operation should be a reference to the diary, and a carrying out of the things to be done as therein indicated for that day. All resolutions, *e.g.*, to let a tissue have a day's or two days' further immersion in its present medium, should be noted at the time, and placed under the proper day, a day to come of course. Both diary and index should be kept either upon the work-table or within easy reach.

A 4.—**The Compound Microscope-Stand.** The following advice is intended for those who know little or nothing of the instrument, and is therefore dogmatic rather than argumentative.

Every microscopist, excluding those who merely seek amusement from the instrument, uses a small simple stand for the greater portion of his work; but when he is obliged to use powers higher than an eighth and bring out their full capabilities he requires a more complicated and therefore more expensive stand. Now, this requires more money than the average student of medicine can afford; therefore it is customary to recommend a small stand which will do, as above stated, the greater portion of the work, and to show the student those rarer microscopical features requiring very high powers with a more complicated instrument, the property of the laboratory or of his teacher. This work is intended as much for junior practitioners working in a private laboratory of their own as for medical students so called, therefore, whilst placing the small working stand, as it is entitled to be placed, in the

front rank, the more complicated instrument will also be recommended.

First, then, a small working stand is a prime necessity. There are scores of these to be bought, of different patterns, but the one which comes nearest to my idea of a good stand is the recently-introduced "Star" instrument of R. and J. Beck.

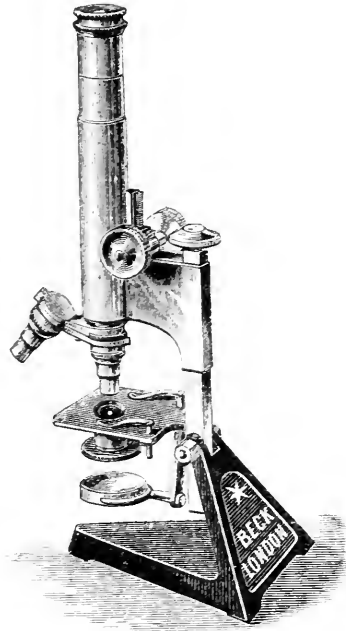

FIG. 1.—Beck's "Star" microscope.

This instrument, shown by Fig. 1, is made with a simple draw-tube coarse adjustment as well as with a rack-and-pinion one as shown. The latter is to be preferred on account of its allowing the use of the double nose-piece carrying the two working powers constantly in use.

A 5.—**Substage Condenser.** With small working stands not fitted for a substage condenser of the best kind, Wenham's half sphere is excellent, and costs only five shillings. It is used by simply touching its flat surface with the tip of the tongue, and making this surface adhere to the under surface of the slip, immediately beneath the object to be illuminated. Some small

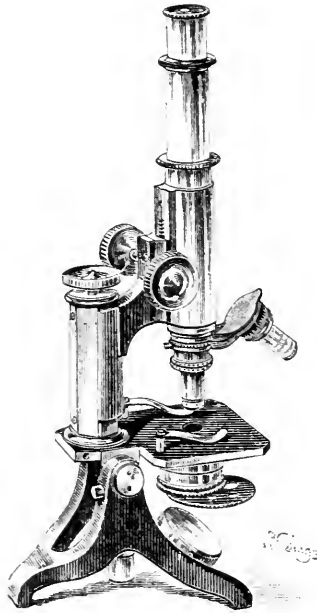

FIG. 2.—Baker's student's microscope.

stands have an adapter to receive one of the objectives as a condenser: a one-fourth, one-fifth, or one-sixth inch objective makes a very good condenser. Such a stand is shown by Fig. 2, made by Baker, of High Holborn, with which I have worked for some years.

A 6.—**The Stand Condenser.** This is by no means a necessity, but for high-power work it is of

great use. By its use the greater portion of the rays of light from the lamp-wick can be collected and concentrated on the mirror of the microscope. It should,

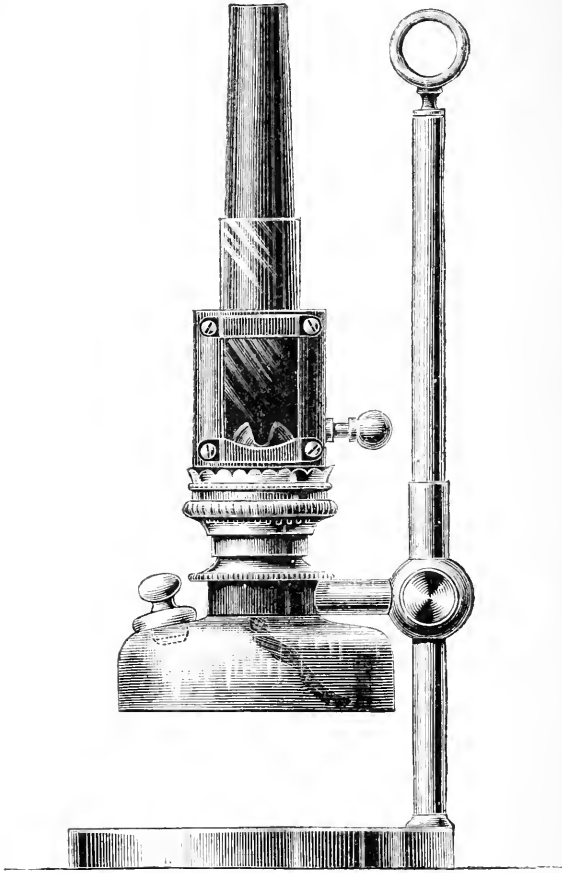

FIG. 3.—Baker's microscope-lamp.

however, when not in use always be put away, and not allowed to stand on the work-table, or it gets in the way.

A 7.—**The Microscope-Lamp.** No better lamp for night-work or dark days can be chosen than the one represented by Fig. 3, and it is not expensive either. It is so constructed that the light may be lowered so near the level of the table that direct illumination, the mirror being pushed aside, can be instantly resorted to when occasion requires.

A 8.—**Eye-pieces or Oculars.** Two eye-pieces are required. They should be the A and C eye-pieces if of English make, or the 2 and 4 if of foreign make. The student will now see that whilst English opticians name their objectives by their focal distances, one-inch, one-sixth inch, &c., and the oculars by letters of the alphabet, the Continental opticians just do the reverse. Another peculiarity is this: an English optician speaks of a deep and shallow eye-piece; by the former he means a powerful and by the latter a weak eye-piece. This nomenclature is puzzling to a beginner, who finds the shallow eye-piece very long and the deep one very short.

A 9.—**The Two Working Powers.** These powers or lenses are in constant use, and should be cleaned and screwed upon a double nose-piece, as we are constantly requiring to use first one, then the other. Thus it is usual to take a general survey of the whole of a tissue, which can only be done with a two-inch, one-inch, or at most a two-thirds or a half-inch; then to inspect a small part of it at closer quarters, which can only be done with a more powerful lens, such as a quarter, fifth, or sixth-inch.

For the low power a two-inch is too low, and we

choose either a one-inch, a two-thirds, or a half-inch. For a higher power, called by authors of histological works high-power, a quarter-inch, a fifth, or a sixth will do. Strange as it may seem, this wide range of choice in the two working lenses is almost a matter of indifference. The usual powers are either the one-inch and the quarter-inch, as recommended by English opticians, or the half-inch and sixth-inch, as recommended by foreign opticians, or those who work with French or German objectives.

The custom of the day is to prefer Zeiss's powers, and laboratories therefore are mostly supplied with his A and D lenses, the former being a two-thirds and the latter a one-sixth inch. If the student chooses English powers, let them be a one-inch and a quarter-inch; if he prefers Zeiss's powers, let them be the A and D lenses, or his AA and DD lenses—these are the same in power, but better lenses, and only cost a few shillings more in each case.

A 10.—The Magnifying Power and Angles of Lenses. If a vulgar fraction having 1 for its numerator be made of the focal distance of the lens, we only require to put a 0 after the denominator to ascertain the magnifying power of the lens. Thus a one-fourth magnifies forty, a one-tenth magnifies 100 times, and so on, and one inch or $\frac{1}{4}$ amplifies ten times.

When, therefore, we remember this, that the power, say a one-fourth power, gives an image of forty diameters only, and we are viewing the object with a one-fourth lens and a C ocular, and perhaps getting an amplification of 200 linear, it is the ocular which is amplifying

the image formed by the lens five times. We must never lose sight of this fact in the choice of our oculars, because the more the image is amplified the less sharp the definition. In other words, when good definition is required we use a weak ocular, such as an A or a B, and we of course have less amplification. On the other hand, when we require high amplification we use a powerful ocular, such as a C or a Continental 4, and we recede, so to speak, from good definition the higher in amplification we go. On this account, lenses or powers are tested by deep or powerful eye-pieces, because it is only a well-corrected lens which will give an image sufficiently perfect to bear high amplification, because of course all the imperfections of an image become more and more prominent the more it is amplified.

Lastly, the angle of aperture has nothing to do with amplification. Thus a cheap one-fourth lens with a low angle, say of 50° , and costing a sovereign, amplifies as much as a one-fourth lens with an angle of 100° , and perhaps costing five sovereigns. Whilst mentioning the subject of angles we may further remark that low-angled lenses have greater penetrating power than higher ones; that is, the focal plane is deeper, or, in other words, the depth of the piece of the object seen at the same time without altering the distance of the lens is greater. For instance, suppose we were viewing with a one-fourth power the letters *a, b, c, d*, placed one under the other, the nearest being *a*. We might see the *a, b, c, d* all at once if the lens had an angle of 50° ; we might see *a, b, c* all at once if the angle were 60° ; *a, b*, if the angle were 90° ; and only *a* if the angle were 100° .

For histological purposes we must not have too high-angled lenses, but we must avoid the low-angled lenses. The one-inch cannot well have too high an angle, the two-third inch should have an angle of 36° , the half-inch 40° , the one-fourth inch 75° to 90° , the one-sixth inch 110° , the one-eighth inch 110° to 120° . The angles of the oil-immersions we shall refer to afterwards, when discussing special lenses.

A 11.—**The High-Power Lens.** An exceedingly small but important proportion of histological work can only be done by the use of a high power, such as a twelfth or fifteenth-inch. All powers higher than an eighth should have water or oil between their front lens and the object viewed, because water and oil refract light more strongly than air. When nothing is placed between the lens and the object viewed, the lens is called a dry lens, because air only is interposed; when oil or water is interposed, the lens is called either a water-immersion or an oil-immersion lens, according to the medium used.

A 12.—**Some Good Dry Lenses.** Swift and Son's new high-angled one-inch lens is a most remarkable one. This and Zeiss's D or DD form an excellent set of working lenses.

Zeiss's A and D, or AA and DD, are much used in English laboratories.

Beck's half-inch at 40° and their one-sixth inch are excellent as every-day powers.

Any one of the above sets screwed on a double nose-piece, other things being equal, will satisfy all the needs of the histologist. If the student hesitates as to choice,

he had better adopt the street urchin's mode of settling the matter by tossing up one of the coins of the realm.

A 13.—**Immersion Lenses.** All powers higher than a sixth, or at most an eighth, should be oil-immersion lenses. Dry or air lenses are quite superseded by immersion lenses, and of the two forms of immersion lenses, water and oil, water-immersions are almost things of the past, and quite as much superseded by oil-immersions as dry or air lenses are superseded by immersions.

Up to a few years ago it was thought that immersion lenses owed their superiority to the greater amount of light they transmitted by working in a medium, water or oil, with higher refractive properties than air. The history of the discovery that this was not the cause of their superiority is exceedingly interesting. This history was published at length in the *Journal of the Royal Microscopical Society*, by the able editor, Mr. Frank Crisp. I have to thank Mr. Crisp for the loan of the woodcuts in illustration of the subject:

If between the reflecting-mirror and the stage of the microscope we interpose a very small opening in the diaphragm, and on the stage lay a grating of ruled lines, on removing the eye-piece and looking down the tube we observe a series of images of the aperture, like Fig. 4, all circular in homogeneous light, but the outer ones consisting of spectra in white light. The small pencil admitted through the diaphragm is "diffracted." We next lay upon the stage a slide, such as Fig. 5, consisting of, let us say, a

circle containing both wide and narrow lines ruled on glass. Removing the eye-piece as before, we have of course, on looking down the tube, the appearance presented in Fig. 6, the coarse lines giving diffraction spectra twice as close and numerous as those caused by

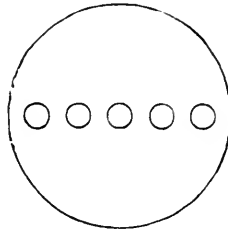

FIG. 4.

the fine lines. The reason for this we have already seen; the present point is, what influence these diffracted rays have upon the image, and it is here that the experiments just referred to are so important and

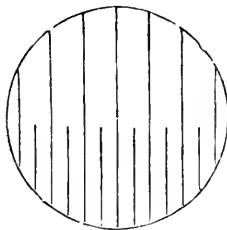

FIG. 5.

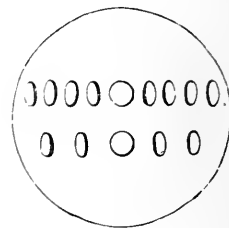

FIG. 6.

interesting. First of all, by a diaphragm at the back of the objective, such as that in Fig. 7, let us cover up *all* the diffraction spectra, allowing only the direct or central white pencil to reach the conjugate focus, or

image-point. On replacing the eye-piece, all the fine ruling has disappeared, leaving only the general outline of the object, as in Fig. 8. By suppressing the diffracted rays, therefore, the fine detail or structure of an object is obliterated.



FIG. 7.

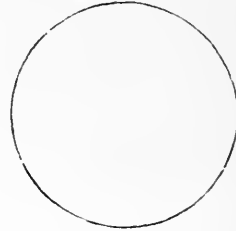

FIG. 8.

Secondly, let us adjust behind the objective a diaphragm like Fig. 9, which allows all the lower spectra in Fig. 6 to pass to the image-point, but suppresses every alternate spectrum of the upper set, diffracted

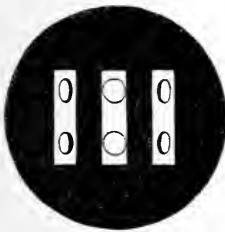

FIG. 9.

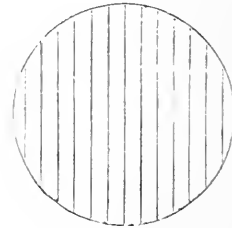

FIG. 10.

by the coarse lines. The image now appears as in Fig. 10, the upper set of lines to all appearance being identical with the lower set. Precisely in the same way, if we substitute a diaphragm like Fig. 11, stopping

off yet another half of the alternate spectra, the lines are again apparently doubled, and we "see" Fig. 12, though the actual object remains the same. In these experiments therefore, while retaining the central pencil of light

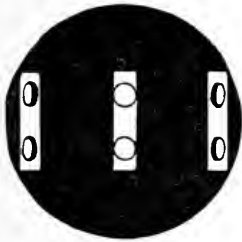

FIG. 11.

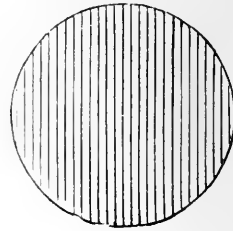

FIG. 12.

throughout, we have *created* apparent detail or structure in the object by suppressing certain of the spectra.

Still further, however, let us take a slide which, when magnified, resembles Fig. 13, or a "crossed grating." We get with this from the small aperture rectangular

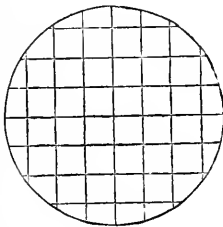

FIG. 13.

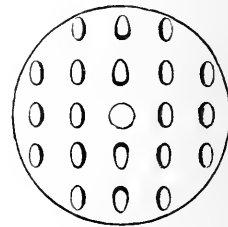

FIG. 14.

spectra somewhat like Fig. 14, but in addition there are other *diagonal* spectra, caused by the regularly-recurring intervals diagonally across the squares. Constructing a diaphragm like Fig. 15, which allows only the

central pencil and two of these diagonal spectra to pass, the vertical and horizontal lines of the object have vanished, to be replaced by Fig. 16. This experiment is troublesome, the diaphragm having to be prepared



FIG. 15.

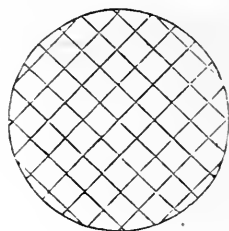

FIG. 16.

with extreme care; but the results, first deduced from theory, have been rigorously verified.

Now the microscopic student knows that many objects, by their minute and regularly-recurring structure, cannot fail to give strong diffractive effects. The well-

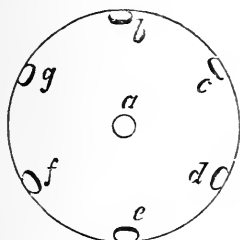

FIG. 17.

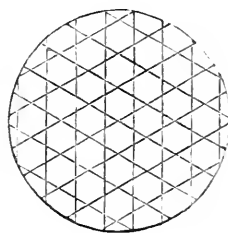

FIG. 18.

known *Pleurosigma angulatum* will serve as an example of the practical effect of the foregoing considerations. It gives three sets of diffractive spectra arranged as in Fig. 17. As each set is produced by something

resembling lines at right angles to it, the three sets of lines in the object must be arranged *mainly* as in Fig. 18; but it will be obvious, from what has gone before, that by selecting different sets of spectra with or without the central beam the apparent images will differ widely. It is also manifest that *all* these images cannot represent the *true* structure. If, however, we are pretty sure that we have all the characteristic spectra, and their position and relative intensity can be calculated, then the resultant image can also be calculated; and *so far* as all the spectra are included it will

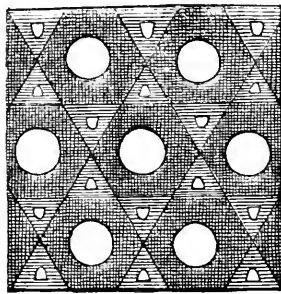

FIG. 19.

represent the real object. Mr. Stephenson¹ records an extraordinary instance of such calculation in the case of this identical *P. angulatum*. A mathematical student who had never seen a diatom, taking the spectra alone, worked out from calculation the drawing given in Fig. 19 as the result. Now, the *small* markings between the hexagons had never been seen in *P. angulatum* by anybody. But on Mr. Stephenson making special examination of a valve, stopping out the central pencil

¹ Journal of the Royal Microscopical Society, vol. i. 1878, p. 186.

so that its superior illuminating effects might not overpower the others, these small markings were found exactly to exist, though they were so faint as to have eluded all observation until mathematical calculation from their spectra had shown that they *must* be there.

The general conclusion is, therefore, that we can have no *true* image of an object whose structure is sufficiently fine to give diffraction spectra, unless *all* the diffracted rays, or rather perhaps all the truly characteristic sets of spectra, are collected; and the image will more or less resemble the object, in proportion as the spectra are all collected, or at least sufficient of these *characteristic* spectra. As we have found before that the finer the grating the more widely deflected are the diffracted spectra, we can now readily understand how, as regards minute structure especially, collection of the widest possible angular field of rays from the object is a point of the utmost importance for correct *delineation*, quite irrespective of greater *illumination*; and it is in this respect that immersion objectives have such an enormous advantage.

Of course these considerations only apply to structure of a certain degree of fineness. With more coarseness, all the diffracted spectra which are visible may be collected by a moderate angle. But when we reach a certain fineness it will be seen that the image in a microscope of small angular aperture can be no true representation of the object at all, but is due to peculiar selective conditions.

This may be well shown by an experiment with

Amphipleura pellucida. With a homogeneous-immersion objective of large aperture, focus the object under an illumination so oblique as to show up all the lines clearly. Then remove the eye-piece as in previous experiments; and, placing the eye at the conjugate focus or image-point of the objective, the direct beam will of course emerge obliquely as a bright spot; whilst on the side of the field, *and close to its margin*, will be seen a faint bluish light, the inner portion of the *first diffraction spectrum*. Only a portion of *one* spectrum, observe; and that so near the margin that it must be lost with any objective of much less angle. If now a small bit of paper be adjusted on the back lens of the objective so as to stop this blue light and no more, the illumination is demolished by an almost infinitesimal portion, and the diatom is still visible, apparently as brightly illuminated as before. But the characteristic *striation*, which caused, and was therefore imaged by, the diffracted light, is gone, just in the same manner as was demonstrated in Figs. 7 and 8.

A 14.—**Some Good Oil-immersion Lenses.** Swift and Son make a good one-twelfth inch with great working distance which only costs £6. Lately, Reichert, of Vienna, has brought out a one-fifteenth costing £9, and one of the same focal distance costing only £5. These are all good lenses. Leitz led the way by bringing out a one-twelfth inch for £5 5s. This is a good lens but for its working distance, which is so short that it renders the lens useless almost. The first three lenses are excellent in every respect; all have good working distances.

A 15.—**Choice Outfits.** For those who can afford it, any one of the three following outfits will leave the purchaser nothing to desire, however affluent in circumstances :—

1. *Beck's Pathological Stand.* This stand is small and answers the double purpose of daily and occasional work.

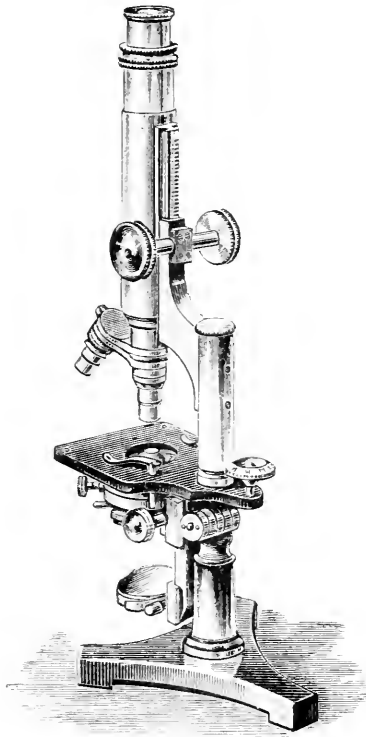

FIG. 20.—Beck's pathological stand.

Their half-inch at 40° and their one-sixth inch should also be taken as ordinary working lenses. Also their highest-angled substage condenser. The glass stage is

a beautiful piece of mechanism, but a plain brass stage is supplied in its place if desired.

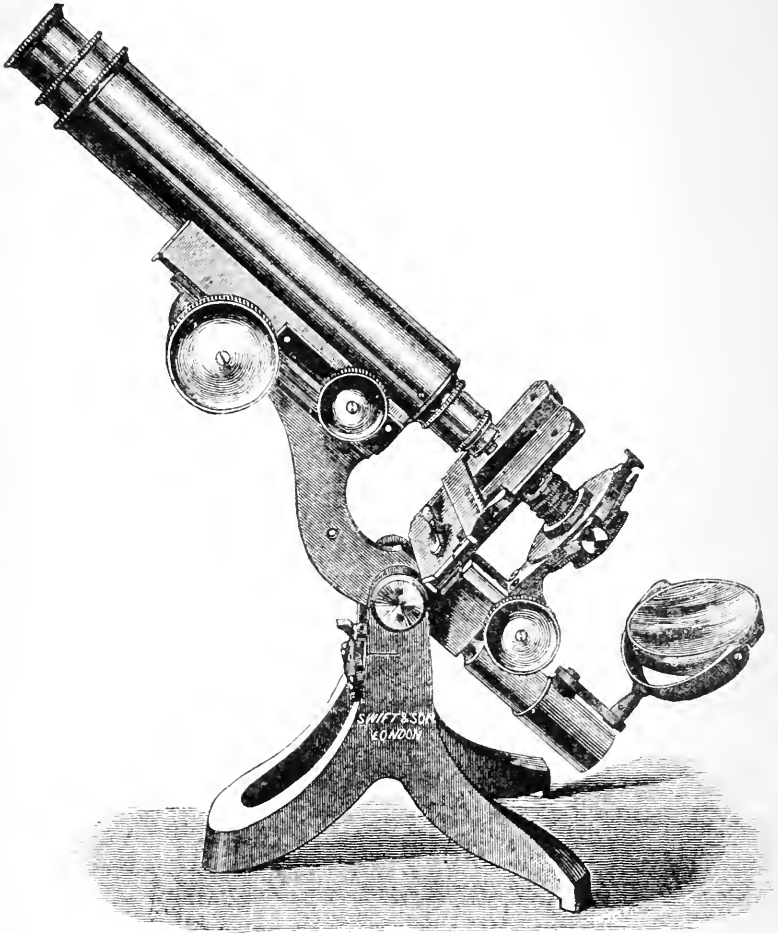

FIG. 21.—Nelson's student's stand.

2. *Nelson's Student's Stand.* This also answers every purpose. Swift's one-inch and their one-fourth inch

should be taken as the working lenses, and their highest-angled substage condenser. It will be seen that the stage is cut away. It is also provided with a sliding bar which acts as a finder when working with high powers, or searching a slide.

3. *Baker's New Stand.* I regret I have no wood-cut of this. It also is an excellent stand. Zeiss's AA and DD lenses should be chosen as the working powers, and Zeiss's condenser.

A double nose-piece to carry the two working lenses is to be added, whichever be chosen.

For a high power, one of the first three oil-immersions I have named should be the high power taken with any of the three outfits. Such outfits cost almost £30, and are not generally bought by students; but those in practice who do not care to be always changing and who want an outfit for life cannot for money be better equipped. The very large elaborate stands are quite unfit for ordinary work, whilst those I have mentioned are very especially suited for ordinary work, and answer every purpose in special work.

A 16.—**The Magnifying Powers of the Microscope.** After obtaining his microscope, oculars, and objectives, one of the first things the student must do is to construct a table of amplifications with all the different combinations at his disposal. Thus, suppose he has Beck's Star microscope, their half-inch and one-sixth inch objectives, and two eye-pieces, he will construct a table like the one we here give.

OBJECTIVE.		EYE-PIECE.	
		Shallow. ¹	Deep. ¹
Tube in	Half-inch
	One-sixth inch	×
Tube out	Half-inch
	One-sixth inch

FIG. 22.

Suppose he has this table completed and suspended within sight of his work-table, and he is using his one-sixth inch objective and a deep eye-piece, with the tube in, then on looking at the table he will see the magnification he is using by looking at the figures where the cross is placed.

To fill up the spaces or figure values left open in the table, take a stage-micrometer divided in 0·1 and 0·01 mm., also a pair of compasses with fine points, then, with the half-inch objective on and the shallow eye-piece in and the tube short and vertical, look down the tube with one eye, keeping the other eye open, and open the compasses until the two points coincide with any two of the lines of the stage-micrometer, taking care to hold the compass-points on a level with the stage-micrometer. Now apply the compass-points to a milli-

¹ A shallow eye-piece is one of low power, and longer in length than a deep (stronger) one.

metre measure, and the apparent size is obtained. This apparent size divided by the real size (number of millimetre spaces of the stage-micrometer which the points of the compass appeared to stretch over) will give the magnifying power. Proceed in the same way for each of the other combinations, and when the card is filled up hang it within sight of the work-table. Of course, should he have more eye-pieces and more objectives, he will simply have to extend the table in a manner at once obvious. Continental eye-pieces are known as numerals, and objectives as letters of the alphabet—a state of things equally easy to tabulate.

A 17.—To Measure Objects under the Microscope. Professor Schäfer¹ advises the following plan:—Put a stage-micrometer (which is a glass slide ruled in the centre with the lines 0·1 and 0·01 mm. apart) under the microscope in such a manner that the lines run left and right (the microscope must not be inclined). Focus them exactly. Put a piece of white card on the table at the right of the microscope. Look through the instrument with the left eye, keeping the right eye open. The lines of the micrometer will appear projected upon the paper. Mark their apparent distance with pencil upon the card, and afterwards make a scale of lines in ink the same interval apart. A magnified representation is thus obtained of the micrometer scale. Mark upon it the number of the eye-piece and of the objective, and the length of the microscope tube. This scale-card will serve for the measurement of any object without the further use of the micrometer. To measure

¹ *Essentials of Histology*, p. 6.

an object, place the scale-card upon the table to the right of the microscope, and view the object with the left eye, keeping the right eye open. The object appears projected upon the scale, and its size in 0·1 or 0·01 mm. can be read off. It is important that the same objective and eye-piece should be employed as were used in making the scale, and that the microscope tube should be of the same length.

A 18.—**Drawing Microscopic Objects.** Without a single exception, every teacher is agreed that nothing impresses the appearance of the structures as seen under the microscope and leads to exact observation so well as sketching these appearances. Every student, whether he can sketch or not, is bound in common justice to himself to sketch in his own way what he sees under the microscope, however clumsily : such sketches impress him as he can be impressed in no other way. If he only draws what he sees, he cannot get wrong, however poor his production. With a very little practice, however, he will soon acquire the habit of sketching ; and will then need some, at all events, of the apparatus here recommended.

1. *Camera Lucida.* The histologist as a rule never works with the tube of his microscope inclined : he nearly always works with the tube vertical, not that the latter position is an easier one, but because the stage of the microscope must be horizontal for dissecting, teasing, examining fluids, and so forth. As many of the structures to be depicted would be disarranged by tilting the microscope tube and with it of course the stage, a prime necessity of his camera lucida must be adapta-

tion for use with a vertical tube. We recommend Zeiss's, as in Fig. 23, and in order that the drawing may be kept within reasonable limits, the drawing-paper has to be elevated.

2. *Wooden Desk.* This is made so as to hold the drawing-paper at an angle of 15° above the level of the stage in front of the microscope, so that the drawing once made may not have to be reduced.

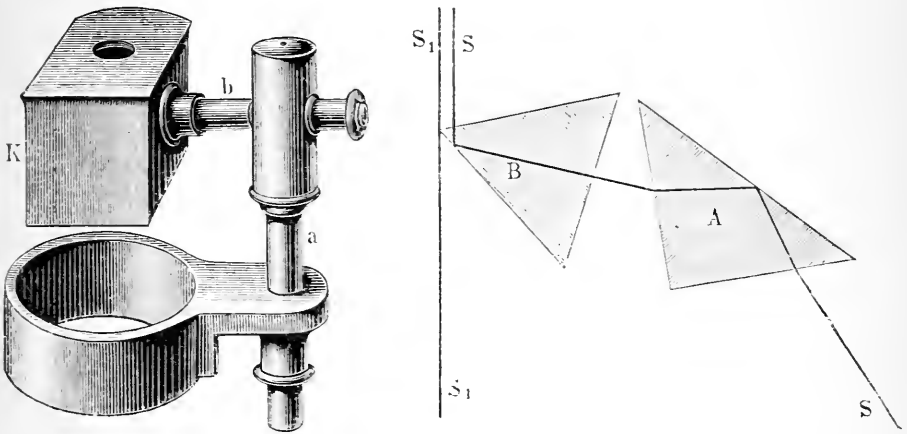

FIG. 23.—Zeiss's camera lucida.

3. *Zinc or Copper Stencil Plate.* This had better be a square with sides of 11 cm., having a circle cut in it 9 cm. in diameter. We use this to make a black border for the drawing before commencing to draw, which will prove of the greatest assistance whilst drawing, as will be presently pointed out.

4. *Paper.* The drawing-paper had better be chosen to take water-colours, then we can if we like use a

little colouring. It should be hard, thin, smooth, and unglazed.

5. *Lead-Pencils.* A HB, also a HHHH pencil, will be required.

6. *Lithographic Pens.* About half a dozen of these should be got, and each well mounted in a separate holder.

7. *Sable Brushes.* We should have at least six of these, with hairs short and coming to a true point. Four are required to be set apart for use with Indian ink, carmine, yellow, and blue respectively. The brushes used for these must not be used for any other colours, and each must be marked with the name of the pigment it is kept for. Besides the four sables set apart as specialists, we require two or three for general use, sables to apply any other of our pigments except the four named above. These must always be rinsed in water, never placed in the mouth.

8. *Pigments.* These should be few and of the best quality, and in cakes, not moist colours. The cakes must be kept well separated to prevent dirtying, or chipping each other. Again, only transparent colours must be chosen. These had better be Payne's grey, Antwerp blue, carmine, scarlet lake, yellow ochre, Hooker's greens No. 1 and No. 2, and raw sienna. The colours to be avoided are those which load and become opaque when dry; such as vermilion, cadmium, the umbers, emerald green, and Vandyke brown. He should test the cakes by taking a perfectly clean porcelain palette, and rubbing a little of each side by side upon it, and allowing all to dry; when dry, reject any if dull and dusty, and have them

exchanged. Lastly, he should buy a piece of the very best Indian ink he can possibly find.

The above are all he will really require, except a palette, india-rubber, an erasing knife, and so forth. Of course, if he intends to sketch without colours, he will at once see that a camera lucida, paper, a stencil plate, and Indian ink, with a sable or two, a support to hold the paper, and the lead-pencils, will only be required.

To those who have never sketched, the following hints will be useful.

First, take a rectangular piece of paper twice the size of the stencil plate; then, having placed the stencil plate upon its left-hand half, run a lead-pencil around its outer square and its inner circle. Flood the space so marked with clean water and a clean large sable; then, when the paper has so far dried as to have a sodden appearance, place it on an inclined plane, such as the wooden desk, and wash over it a solution of Indian ink, made thick and black by a good deal of rubbing down in water. The brush in putting on this or any other wash must be well filled, a commencement made at the top of the surface, and care taken never to retouch the surface already washed over with the sable. If not black enough, a second lot of ink may be washed over after the first has quite dried.

When this black outline is dry, place the paper on the drawing-board, and raise it or lower it as required; the rim of the circle and the rim or margin of the field as seen through the camera must exactly coincide. The student will find the black circle a great help to him in several ways. Just to convince himself, however, let

him try a drawing without its aid. Besides being an aid in drawing, it is optically useful by contrast, and improves his sketch in appearance.

The stand must bear the paper at an angle of about 15°. He then adjusts the lights, taking care to have the paper most illuminated. Then, having a very fine point indeed upon his hardest or HHHH pencil, he commences to draw an outline of what he sees, without removing the point of his pencil from the paper. The moment he has done this—namely, lightly indicated the outlines, or a sufficiency of them, of his object—he removes the camera: it is done with. He now fills in typical parts, after getting from his text-book all information about these, with his pencil, by keeping his eyes alternately on the field and on his paper. If he determines upon using pigments, he should glance over a few simple directions in the most elementary works on the subject, and he will find no difficulty whatever in doing at least as much as is required for educational purposes.

Lastly, he should mark the typical parts with the small letters of the alphabet, and, on the right half of the paper, index or briefly describe each typical part.

I, in the name of all the teachers who ever taught, again assure him that such productions, however clumsy and crude, will impress him more than hours of reading. Before commencing to place letters upon his drawing, he ought to tabulate upon a piece of clean waste paper the typical parts to be indicated, taking the information from a text-book, and arranging them in the order of their importance, as typifying what is to be particularly observed. In other words, the things peculiar to the

tissues should be lettered and described first: for instance, in the case of lung, the bronchi and alveoli, &c., should come before arteries, veins, nerves, or areolar tissue; in kidney, again, the divisions, corticular and medullary, should come before the Malpighian corpuscles and renal tubes, and these again before the epithelia.

He ought in the same circle to sketch bits of important parts under high amplification, and in all drawings indicate the amplification either by the sign of multiplication followed by a numeral, or, what is perhaps better, give the name of the ocular and objective; thus, if he be using Zeiss's glasses, he would put, we will say, Zeiss's AA 2, or simply AA 2, which means of course the AA (two-thirds inch) power and number 2 ocular. If he be using English glasses, he will put, we will say, oc. A, obj. $\frac{1}{4}$. Of course he ought to state whether the tube of the microscope is in or out at the time. By keeping a table of amplifications of his microscope pinned up near his work-table he will see at a glance the value of the indices above described.

A 19.—**Photo-micrography.** The use of dry-plates has simplified this art and brought it within the reach of those whose time is very fully occupied. For truthfulness in detail it is far before sketching; but, unlike sketching, it does not educate the observing faculties, or it does so to a much less extent.

An excellent essay on the process, and the apparatus required, is given in *The Methods of Microscopical Research* (Baillièrè and Co.). It is from the pen of Mr. Frederick Greening, whose beautiful photo-micrographs

illustrate the pathological series of *Studies in Microscopical Science* published by the same firm. This essay is remarkable in several ways: notably in a description of a method to prevent flare in the body tube: in the full explanation of the process, and explanation of points in which beginners get wrong.

Another work, a small three-shilling hand-book on Photo-micrography, by Jennings and Maddox, is published by Messrs. Carter and Piper, 5 Furnival Street, Holborn, E.C., and is more recent than the former.

The camera recommended by Greening is much the same as the one by Swift and Son here shown (Fig. 24). The latter work has a full notice of the remarkably good microscopic object-glasses made by this firm. These objectives are corrected for photo-micrography, which does not make them any the worse for ordinary work with the microscope.

Presuming that the student who wishes to photograph will procure these two works, I shall make no further remarks except to draw attention to a most efficient source of light for photo-micrography. It is an incandescent lamp and constant battery, the latter being the invention of Mr. F. W. Branson, F.C.S. Usually a plano-convex lens is used to converge the light on the object, or substage condenser; but for low powers, instead of an ordinary lamp, an opal or frosted incandescent lamp is used without the intervention of the lens. A switch for making and breaking contact is supplied with it. The quantity of the two solutions required to charge the battery suffices for about fifty hours' light at a cost of about one penny per hour.

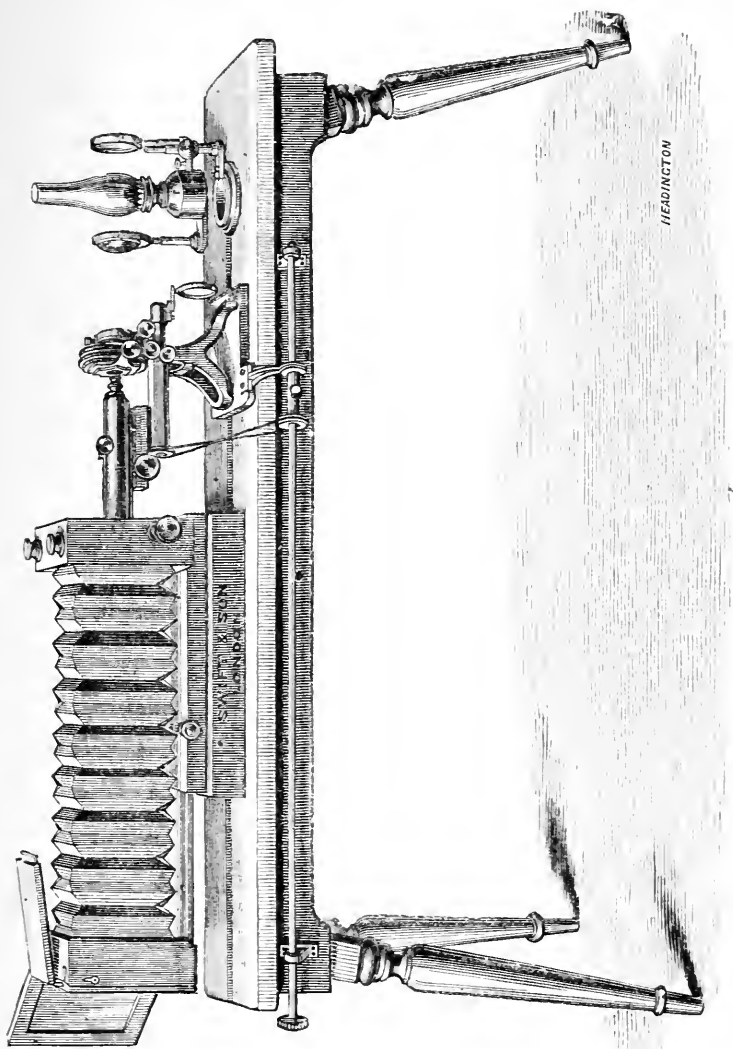

FIG. 21.—Camera and stand

The battery, solutions, lamps, and switch are supplied by Mr. C. Baker, 244 High Holborn, W.C.

In using the battery care is to be taken that a sufficient quantity of current is used; the zincs must be lowered so as to yield a light rich in actinic rays; in fact the nominal light of 5 candle-power may be doubled with advantage. The solutions supplied with

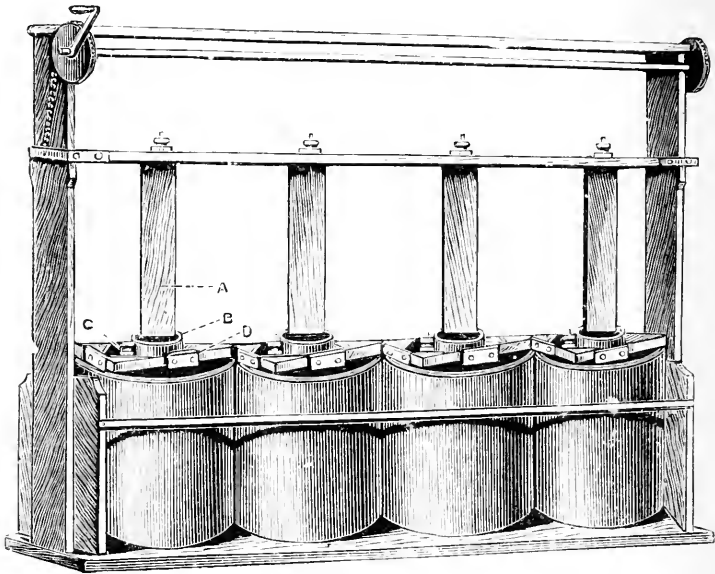

FIG. 25.—Improved constant battery.

the battery obviate the necessity of re-amalgamating the zincs; hence the battery, which is free from fumes, only requires the solutions replacing when these are exhausted.

The current is switched on to the lamp for the purpose of focusing, then broken whilst the sensitive plate is substituted for the focusing screen. The circuit

is once more made during the time of exposure, after which the light is switched off for the closure and removal of the dark slide.

A small shutter fitted below the stage and moved by pneumatic or electric means may be substituted for the switch if desired.

B.—APPARATUS, REAGENTS, AND SOME MINOR OPERATIONS.

B 1.—These are arranged in groups either on account of the sources from which they may be procured, or for other reasons which will appear in each case.

The present list of requisites can all be procured of those opticians who sell microscopes and their belongings.

a. A Compound Microscope, with rack-and-pinion coarse adjustment and double nose-piece: two oculars: two working powers: one high power, not less than one-twelfth inch, which should be an oil-immersion, will be required. A substage condenser, or a substage piece into which the higher of the two working powers can be screwed: a stand condenser: a microscope-lamp: a stage-micrometer, and a camera lucida will also be required.

b. A Dissecting-Microscope. For those who can afford it the one here shown is an excellent instrument, and is supplied with two achromatic lenses marked 10 and 20, indicating the linear amplification in either case. The lower power is by far the most useful, though occasionally the higher power is required.

It may be as well to say that unless the student can afford a really good dissecting microscope, such as the

one here shown, or the one used in the biological class recently conducted by Professor Huxley, and sold by Baker, he had far better learn to dissect with the compound body without any other aid whatever. The reversing of movements and positions is exceedingly confusing at first; but after a very few trials—each trial should not extend over a quarter of an hour—he will

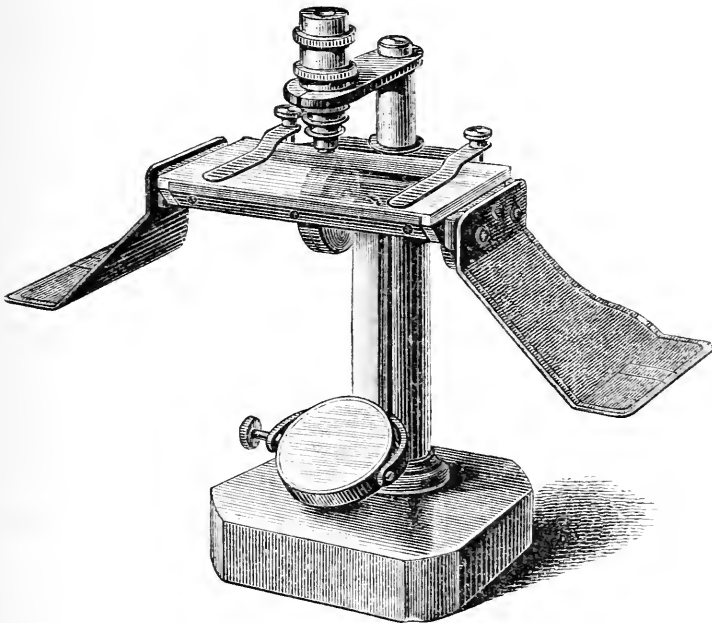

FIG. 26.—Reichert's dissecting-microscope.

get into the way of using the compound body, and in a few weeks become a far better dissector than any one only using an ordinary dissecting-microscope can possibly be. Thus his very poverty will be the means, as poverty frequently is, of making a better man of him in the long run.

c. Glass Slips. In England these are three inches long by one inch broad, and are called three-by-one slips, or simply slips. When they have mounts upon them, they are then called slides. The ones recommended are made of the best flatted crown glass. About 2 gross will be needed, or $1\frac{1}{2}$ gross at least.

d. Cover-Glasses. Only No. 1 covers should be used, and of these all measuring over $\cdot006$ inch are to be placed in a pill-box and not used for permanent slides. These thicker glasses are useful for the rough-and-ready examination of objects; also for use with moist chambers, irrigation, and similar processes. Round covers are to be chosen on account of the extra facility they afford when ringing is required.

The student should get half an ounce each of half-inch and three-fourths inch.

The reason for rejecting covers thicker than $\cdot006$ inch is that objectives with no correction collar are corrected to work through this thickness of glass.

e. Cover-Glass Forceps. Special forceps are sold for grasping and laying on cover-glasses. The forceps have a very broad grasping surface, and can hold the cover firmly without breaking it. Baker sells them.

f. Cover-Glass Measurer. By specially ordering covers of a prescribed thickness, *i.e.* covers not thicker than $\cdot006$ inch, the student can do without a cover-glass measurer. Should he however choose to measure his own covers, the instrument sold by Ross and Co. is the best. It costs two guineas.

g. Watch-Glasses. Half a dozen ordinary-sized and two large-sized watch-glasses will be required.

h. Writing Diamond. It is better to write or scratch the permanent slide with a single mark and to keep a full record of the slide in a book than to label the slide as is usually done. These labels are liable to drop off and can never be made, in many cases, to contain information enough concerning the slide. Labels are indispensable in the case of bought slides of course.

i. Dissecting Case. This must not be such a one as is used by medical students, but must be the one used in biological work. Baker sells the one used in the South Kensington classes. It costs twenty-five shillings, and contains:—A strong pair of scissors; a fine pair; a strong pair of forceps, and a fine pair; two razors; four scalpels; a pair of bone forceps; needles fixed in handles, &c.; all of these being absolutely requisite in our case.

j. Microtome.

k. Hypodermic Syringe. This is required for injecting fluids into the areolar tissue, and other purposes. Messrs. R. and J. Beck sell a good one for five shillings, which they call Koch's syringe, because it can be taken to pieces and sterilised by heat.

l. Beer's Knife. This is useful for cutting fringes off sections whilst they lie on the slip, also for taking away the cornea. It is not indispensable.

m. Bottle of Asphalt.

n. Bottle of Gold Size.

o. Warm Stage. The student should procure a warm stage. That of Reichert is excellent but costly. It is heated by warm water: it has a thermometer, and is altogether a superior instrument. Stanley makes one

for less than half the amount of Reichert's, heated by a flame. This also has a Centigrade thermometer. In case the student should not care to purchase either, he can construct one for himself out of a piece of stout copper plate the thickness of that used by engravers for visiting-cards. The plate is to be cut into a rectangular piece, three inches by two, with a half-inch hole in its centre, and a stout long limb left in the middle of one of the long sides standing out at right angles to the long axis of the piece just described. Cacao butter is used in

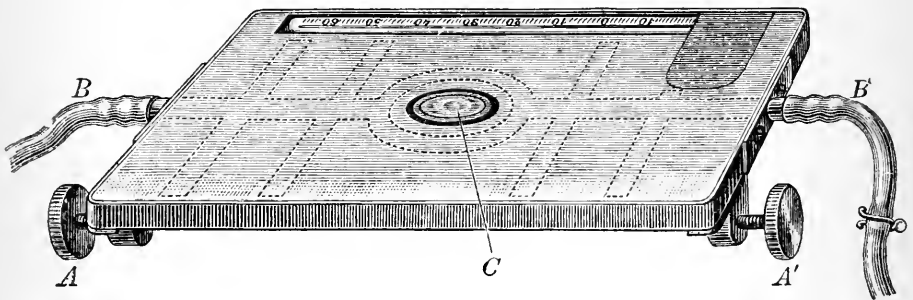

FIG. 27.—Reichert's warm stage.

place of a thermometer. A little piece is placed on the plate near the slip, and the flame of a spirit-lamp is removed when signs of melting appear in the butter.

B 2.—The following articles are grouped because of most, if not all, being sold by dealers in chemical apparatus.

a. Spirit-Lamp.

b. Air-Gas Burner. A small size answers well.

c. Very small Glass Mortar and Pestle.

d. Wash-Bottle. One is here depicted.

e. Gas or Vapour Bottle. This may be like the wash-bottle, with the two tubes reversed. The external end of each tube should have a piece of india-rubber tubing placed upon it, one for a clamp, the other for receiving a further length of glass tubing.

f. Siphon Bottles. Winchester quarts—with sound corks each perforated with two holes, one for air to get through into the bottle, the other to admit a long glass tube reaching to the bottom of the bottle—make good

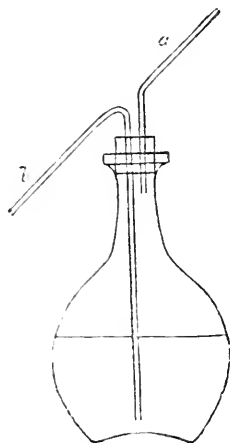

FIG. 28.—Wash-bottle.

bottles for siphon purposes. The glass tube should be bent downwards immediately above the cork, and have upon it a long piece of india-rubber tubing. This requires the use of a clamp, or a stop-cock.

These bottles should be placed aloft, and are useful for holding salt-solution, and for injecting purposes.

g. Drop Reagent Bottles. A very great saving of time and of reagents is effected by the use of a German reagent bottle marked "Patent L—H." These bottles

are made to contain 15, 20, and 30 grammes, the last size being the most convenient. A single drop, or a number of drops, of their contents can be instantly obtained by giving the stopper half a turn and inverting the bottle. Two deep grooves are cut on opposite sides of the lower half of the stopper; then, by giving the stopper half a turn, air enters a hole, *a*, in the middle of the back of the bottle-neck and travels down one groove of the stopper. By inverting the bottle the fluid

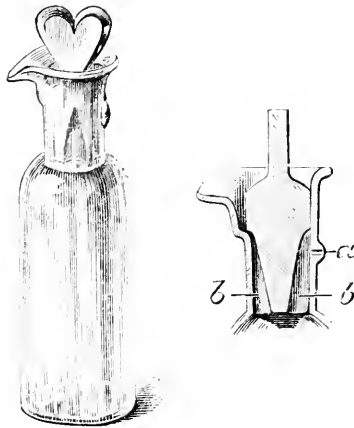

FIG. 29.—Drop reagent and stain bottle.

enters the other groove of the stopper, and gets into a third groove cut in the inside of the neck of the bottle, extending from the lip.

It is impossible to overrate the value of these little bottles in histological work. We must in using them always remember to give the stopper half a turn before replacing them after use: we should also prevent the stoppers getting fixed.

h. Beakers. Two or three beakers, each holding half

a litre, should be obtained. If the student intends bathing tissues in paraffin, three or four very small beakers are useful. These may be less than a fourth the size of the former.

i. Test-tubes. A few of these are desirable. Six are sufficient.

j. Short Test-tubes. These are extremely useful: one is here shown. They are about an inch long,

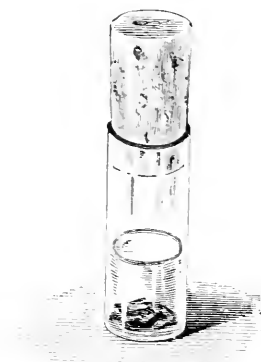

FIG. 30.—Short test-tube.

or little more, and just wide enough to admit a small cork, half to three-quarters of an inch. A dozen will not be too many.

k. Stirring-Rods. One or two of these are required; made of glass, of course.

l. Two Glass Funnels.

m. Nest of Cork-Cutters.

n. Glass Syringe. One holding an ounce is the best size.

o. Glass Tubing. The tubing such as is used for babies' feeding-bottles is best for our purposes. Two pounds should be obtained.

p. A small Three-cornered File. This is required to cut the glass tubing.

q. India-rubber Tubing. The small black tubing such as is used for babies' feeding-bottles is best. About three yards will be needed.

A piece of india-rubber tubing six inches long for fixing to the middle neck of the three-necked Wolff's bottle is also needed. This piece should just admit the nozzle of the Higginson syringe. The air-gas burner will also require a length of india-rubber tubing.

r. Three Brass Clamps. They must be spring clamps.

s. Two White Breakfast Saucers.

t. Pieces of Cork. A few pieces of sheet cork, and a block of cork such as that depicted holding the rat, are needed. Both kinds are sold by leather-sellers.

u. A Set of Gramme Weights and Scales.

v. Measure Glasses. A graduated 500 c.c. measure and a graduated 10 c.c. measure are needed. A graduated 1 c.c. pipette had also better be obtained.

w. A Sand-Bath. This the student can make for himself out of a tin lid which he fills with Calais sand.

x. A Water-Bath. A biscuit-tin, soldered so as to hold water, does admirably.

y. An Iron Tripod. One that will hold the baths will be needed.

B 3.—The next article, distilled water, is about the most important in the histological laboratory. Some wholesale chemists sell a very pure distilled water; but the student had better rig up a small still for himself, unless he is exceptionally placed. When distilled water is not essential, I have used the word tap-water,

or simply water. The distilled water, especially for nitrate of silver staining, must be very pure.

B 4.—The following list of things forms a group because of their being mostly chemicals.

a. Acetic, hydrochloric, nitric, and sulphuric acids are all needed. The acetic must be the glacial kind. A pound of each may be obtained. Each should be in a well-stoppered glass bottle.

b. Ammonium tartrate, half an ounce; powdered white arsenic, half an ounce; borax, half a pound; calcium phosphate, half an ounce, are required.

c. Canada balsam, half a pound; picked gum arabic, one pound, will both be required.

d. Strong solution of ammonia is also needed. About half a pound will be sufficient. It should be in a well-stoppered glass bottle.

e. Sulphate of magnesia, half a pound; potash alum, one pound, will be needed. Both should be powdered.

f. Potassium phosphate, half a pound; shellac, four ounces; sodium carbonate, half a pound; sodium chloride, half a pound; sodium sulphate, half a pound; sulphate of copper, two ounces; finely-powdered zinc white, as it is called, one ounce, will also be needed. Many of the above articles are not needed in such large quantities, but they are mostly so cheap that druggists object to sell less quantities.

B 5.—The following articles are also procured from the chemist: they are all essentials.

Absolute alcohol, one pound; rectified spirit, two pounds; methylated spirit, one gallon; ether, four

pounds; chloroform, half a pound; glycerine, which should be Price's, two pounds; xylol, quarter of a pound; benzol, one pound.

The chloroform may be the methylated of Duncan and Flockhart; the ether may also be Howard's methylated 730, which costs very little, and answers admirably for the freezing microtome. If the ordinary chemist has not the xylol, it will be procured by him.

B 6.—This group contains one or two special articles which the chemist can easily get if he has none in stock. The articles are all essentials.

Picric acid, one pound; chromic acid, quarter of a pound; chromate of ammonium, quarter of a pound; bichromate of ammonium, one pound; bichromate of potash, one pound.

The picric acid in crystal is highly explosive and must be kept away from lights; the chromic acid is highly deliquescent.

B 7.—The following are also essentials.

Rectified oil of turpentine, two pounds; creasote, half a pound; oil of cloves, two ounces; cedar-wood oil, four ounces.

Care is to be taken to have the clove oil and creasote as colourless as possible.

B 8.—The following group is composed of articles used for staining.

a. Carmine, two ounces; hæmatoxylin, one gramme; logwood chips, finely ground, one pound.

Messrs. Richardson, of Friar Lane, Leicester, sell the best carmine I ever use at half-a-crown per ounce.

b. Osmic acid, one gramme ; gold chloride, one gramme ; silver nitrate, two drachms.

The two former are sold in sealed tubes. I would advise the student to purchase a bottle of osmic acid solution, 1 per cent., from the opticians, in preference to dissolving the acid himself.

c. Eosin, iodine green, safranin, rosein, Spiller's purple, anilin blue-black, methyl anilin green ; a few grammes of each will be required.

These should all be from the laboratory of Dr. Georg Grüber, Leipsic. Baker is his agent. Each dye is sold in a small bottle which costs a shilling.

B 9.—A diary ; a "Where is it ?" ; a few sheets of thick, white, bibulous paper ; a sheet or two of paper dead black on one side and gummed on the other ; six camel-hair brushes ; one large camel-hair brush.

Stationers keep these articles. The six camel-hair brushes have hairs half an inch long surrounded by tin and mounted on black wooden handles. In other words, they are small or fine paint-brushes.

The large camel-hair brush is for use when silvering the diaphragm.

B 10.—The following are all requisite :—Cotton-wool, bleached, one sheet ; lillikin pins, a large paper of about 200 ; half a yard of sateen ; half a yard of fine flannel ; one or two knots of white filoselle.

B 11.—*Hot Filter*. This will be needed only if the student intends making his own glycerine jelly. It is made by Messrs. James Allen and Son.

B 12.—Two or three sets of embedding L's. These are sold by the Cambridge Scientific Instrument

Company, St. Tibbs' Row, Cambridge, and cost half-a-crown a pair.

B 13.—Paraffin wax (136° F.), two pounds, (110° F.), two pounds; Allen and Hanburys' chrisma, one pound.

The two paraffins, or paraffin waxes as the makers call them, are sold by Messrs. Johnson and Son, 175 Bishopsgate Street Without, London, E.C. The higher melting-point wax costs eightpence, and the lower sevenpence per pound. The chrisma is sold in four-pound tins.

B 14.—White wax, one pound, and olive oil, one pound, will also be required.

B 15.—Gelatine will be required in two forms if the student makes his own glycerine jelly; thus he will require four ounces of French gelatine, "*colle de Paris*," and two or three two-ounce packets of Swinborne's patent calves'-feet gelatine for making carmine-gelatine injection mass.

Celloidin, two or three tablets, will be required if the student wishes to embed in this elegant and efficient way. E. Schering's celloidin is the best, and may be obtained from Corbyn and Co., Oxford Street.

B 16.—Some pieces of plate glass, each the size of a crown piece, a rasp and a water-of-Ayr stone the student will need if he wishes to make his own preparations of bone and teeth by rubbing down. I advise him not to waste his time doing this, but rather to send a shilling and a penny to Messrs. Cole and Son, 171 Ladbroke Grove Road, London, W., for any specimen of this description he may need.

There is no special educational value in making these preparations.

B 17.—The student will either have to purchase an injecting syringe and cannulæ, or he may get my injecting apparatus: they both cost about the same; but, whilst injecting with the syringe is most uncertain and difficult, injecting by constant pressure is easily acquired and very certain in its results.

Suppose he adopts the constant-pressure method he will require the following apparatus:—

Injecting bath; gas regulator; thermometer; a three-necked and a two-necked Wolff's bottle; a manometer; stop-cock and set of cannulæ; a Higginson's syringe; some copper wire and pliers; also a foot or more of lead pipe the size of the tube used for babies feeding-bottles; and a gas-jet.

The bath is made of copper, tinned inside, by Messrs. James Allen and Son, 21 Marylebone Lane, Oxford Street, London.

The remaining articles are described in their proper places further on in the book. The thermometer should be a Centigrade one registering up to 300° C. It and the gas regulator, which costs half-a-crown, are sold by Cetti, Castle Street, Holborn, London.

It will be seen that the thermometer, which costs six shillings, is indispensable for using with the paraffin bath, and as he can with glass feeding-bottle tubing and a little mercury make the manometer himself, the remaining essentials of the injecting apparatus only cost as much, perhaps thirty shillings, as a good anatomical injecting syringe.

B 18.—The hot-water oven is also made by Messrs. Allen and Son. It or some equivalent will be needed if the student baths his tissues in paraffin.

B 19.—Drawing-materials the student will need. He should look over the article on this subject, and determine what he will require, for himself.

Photographing-material he will also have to arrange for himself. Of course it is only under exceptional circumstances that the student can indulge in photographing his microscopic objectives.

B 20.—The four following articles form a group. He had better make the Farrant's medium himself. Any of the others he can get from Mr. Baker, 244 High Holborn. The xylol balsam is made by Dr. Georg Grübler, the white zinc cement by Mr. Cole, Jun., whose names are to be mentioned, the latter especially, or he may get a white zinc cement that will crack with age.

a. Farrant's Medium. This is almost sure to be unreliable if bought ready made; the student should therefore make it himself. Mr. Cole, Jun., makes an excellent quality thus:—Boil arsenious acid for a few minutes in distilled water in a beaker, then take the liquor so boiled, and when cold add an equal quantity of the best glycerine and mix thoroughly. Next dissolve picked gum arabic in distilled water until the water will dissolve no more. Lastly, mix an equal quantity of the first mixture and the gum solution, and filter through cotton-wool lying in the bottom of a clean glass funnel.

b. Glycerine Jelly. The student should either use

Remington's glycerine jelly, or make it for himself; I advise him to make it himself. The following will be found a good formula and way of making it:—

Take of

Glycerine (Price's)	50 c.c.
Water (thoroughly distilled)	42 c.c.
Carbolic Acid Crystals	2 grms.
Gelatine, gold label or " <i>Colle de Paris</i> "	6 grms.
1 new-laid egg.	

100

Thoroughly soak the gelatine in the water for twelve hours, then melt it in a water-bath, and add the glycerine and carbolic acid to it. Remove the heat at this stage. Now beat well up the shell and white of the egg, and incorporate it well with the mixture, which must only be about 35 C. whilst so doing; the object being to diffuse the fluid albumen thoroughly throughout the mass. Again place the mixture in the water-bath, and apply heat until the albumen becomes flaky; then filter through fine filter-paper in the hot oven, or in the hot filter. The filtrate should be received into a clean, dry, wide-mouthed, ground-stoppered bottle. A small wide-mouthed bottle with an ordinary cork, holding only a few cubic centimetres, should be in regular use to avoid having to frequently heat so large a quantity. The stock bottle should be kept in a cold place always. Care must be taken to thoroughly stir the egg albumen

into the mixture whilst not too warm, otherwise the albumen will coagulate prematurely, and its mission (to entangle and eliminate all floating solid particles, however minute) will not be carried out.

c. Xylol Balsam. To prepare this we take good commercial Canada balsam and expel all moisture from it—render it quite vitreous in fact—and dissolve it in an equal bulk of xylol.

The important step of this process is the drying of the balsam without burning it. In order to do so we apply heat for one hour and a half to a thin layer of the balsam. In operating we must rigidly preserve the two factors (time, one hour and a half; and the thin layer): then success is a certainty, the *amount* of flame and its distance from the balsam being the only uncertain conditions. The author takes a round tin lid two inches and a half in diameter and half an inch deep, and fills this to the brim with good commercial balsam. He then sets this in a thin layer of fine sand (a sand-bath) over a Bunsen's gas-burner, and lights the rose-jet, but turns the gas so low that only a faint blue flame exists. The distance from the upper surface of the rose gas-burner to the bottom of the tin holding the sand is two inches and a half. Success the first time trying under such circumstances is almost a certainty. The balsam should be rejected if, after turning off the gas and allowing the mass to get cold, it is either not perfectly brittle, or tinged with brown. In the first case, when the mass is not quite brittle, the *amount* of flame has been too small; in the last, too great. When success is obtained—the author once baked six lots in succession

as an experiment, the third lot only being a failure—the mass is vitreous, *has not changed colour*, and comes away from the tin by simply pinching the sides of the tin, which fractures the entire mass so that it falls out when the lid is inverted.

As we have said, it must be mixed with an equal quantity of xylol. This is easily done by taking a perfectly clean, dry, cylindrical bottle and filling it one-

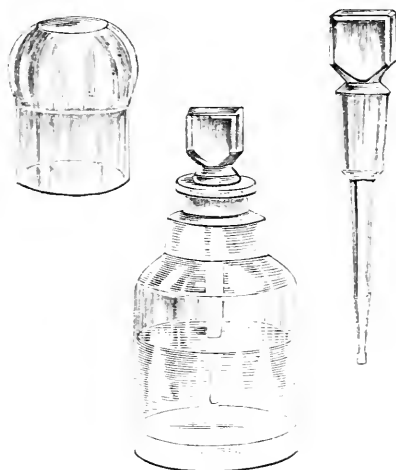

FIG. 31.—Balsam bottle.

third full of xylol, then adding the dried balsam bit by bit with constant shaking until the bottle is two-thirds full.

We keep xylol balsam for use in a glass bottle with a ground-glass stopper and a well-fitting glass cap (see Fig. 31). Another peculiarity of this bottle consists in its having its stopper prolonged as a round glass rod to the

bottom of the bottle. In filling this using bottle from the stock bottle, we must, of course, filter the xylol balsam through filter-paper, the filter-paper being previously wetted with xylol. The glass cap prevents evaporation so that the glass stopper never gets stuck, neither do crusts of dried balsam form around the cork. These bottles are sold by Griffin, Garrick Street, Covent Garden, W.C., who also sells all the chemical apparatus we may require.

d. White Zinc Cement. Amongst the numerous white zinc cements in the market all are worthless except two, so far as I can learn—Cole's and Ziegler's. Mr. Cole, jun., tells me he makes his cement as follows:—He takes a large pickle-jar and fills it with lumps of good commercial dammar and then fills it with benzol. He places the jar in front of a hot fire until the dammar is dissolved. He next takes very finely powdered white zinc and rubs it down in a drying oil, and adds this to the dammar and benzol: lastly, after filtering through dry, clean, thin muslin, he adds a quantity of gold size. This cement never cracks, works beautifully, and what is best of all, it resists the action of oil used with oil-immersion lenses. Baker sells it.

Ziegler keeps his formula to himself, but his production is not nearly so good as Cole's. The only difficulty in making Cole's cement is in getting the zinc of good quality and sufficiently finely ground.

B. 21.—The following articles form a group on account of the fact that the student can easily make each for himself.

Before commencing to make the articles the student

should practise working in glass. A few simple directions are here given.

Glass-working. A knowledge of about half a dozen simple operations on glass tubing is necessary in the histological laboratory. To cut a piece of glass tube, grasp the tube at the part to be cut; then, as the part lies on the edge of the table, the tube being held obliquely, draw one way the edge of a three-cornered file guided by the thumb several times across it: turn the tube round, and do the same on the exactly opposite side, then break it over the edge of the table. To bend glass tubing revolve the tube whilst holding it in an air-gas flame, then quickly withdraw it when the flame is yellow and the tube soft, and gently bend it to the required extent. If at one operation the bend is not sufficient, place it again in the flame. To draw out glass tubing as in pipette-making, hold the tube in both hands as before, and apply it to the air-gas flame between the hands, revolving it of course. When the flame is yellow and the tubing soft, quickly withdraw it and as quickly pull it out straight by grasping firmly and pulling the hands straight apart in the exact line of the tube. The softness of the tube and the rapidity and strength of the pull determine the fineness of the tube resulting: thus, if a capillary tube is needed the tubing must be made very soft by heat, and the pull must be vigorous and commence immediately the tube has left the flame. To render smooth the ends of a tube, hold the end in an air-gas flame gently revolving it the whole time. This will round off the sharp edge, and will tend to cause the end of the tube to collapse, and therefore lessen its

lumen. If the tube be finely drawn like a pipette to begin with, the end of the tube will be sealed by being placed in the flame, unless air be blown through the tube whilst it is held in the flame. To make a **Y**-shaped piece of tubing take a length of tube and apply the flame to the *side* of the tube, keeping the further end of the tube closed with the point of the finger, whilst the mouth is applied to the near end. When the tube is soft, a strong puff of breath blows a glass bubble at the softened part, which bursts and leaves a small hole in the tube. The end of another piece of tube placed over this hole and both held in the flame will seal and amalgamate the pieces of tubing. When cold, a three-cornered file is used for cutting the pieces into the required lengths.

I can imagine the above descriptions causing amusement if read by a glass-worker; but I give them as sufficiently practical and simple, and as answering all the purposes required.

The laboratory must always contain a pound or two of the tubing in lengths of about two, or two and a half feet.

a. Drying Shelves. In working we have constantly to place slips with exposed tissues on them, or slips freshly ringed and therefore wet, out of the way of dust. A convenient set of shelves is made by taking four pieces of thick plate-glass seven inches long by two inches wide, and interposing six pieces of the same plate glass two inches long and half an inch broad, at their ends. Hollis's glue may be used as a cement. The shelves thus made will be more convenient if

raised upon two other pieces of plate glass glued under the ends, of the same size (two inches by half an inch) as the interposing pieces.

b. Mounting Block. It is always quite easy and very desirable to place each section, or piece of tissue, in the exact centre of the slip. I have devised the following contrivance, and find it to answer better than any other. Take two pieces of thick plate-glass each three inches by one, *i.e.* the size of our ordinary slips, and stick them together with Hollis's glue. Then rule with

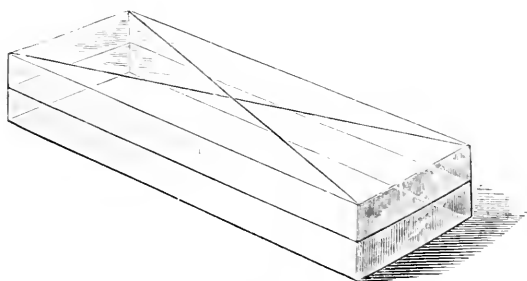

FIG. 32.—Mounting block.

a writing diamond two diagonal lines on one face of this block. Of course where these lines intersect is the centre of the glass and therefore of the slip. Finally rub lamp-black into the diagonal lines. The block may be placed on a white or a black ground in mounting according to requirements. As a rule, however, no special ground is required.

c. Gas or Vapour Cell. Take a slip and ring it with gold size one coat upon another, allowing the last to dry before putting on a fresh one. When it is moderately deep cut a small gap with a knife at opposite

sides of the cell. Now draw out a piece of glass tubing to almost capillary fineness: cut with a three-cornered file through the tube, leaving 1 cm. only at the end of the capillary part. Place a piece of india-rubber tube upon this, then lay the capillary part on the slip, and paint sealing-wax varnish (sealing-wax dissolved in methylated spirit) along the capillary tube and the slip it lies upon to a good substantial depth. Of course the capillary tube is to reach the inner rim of the cell, and should not extend beyond the end of the slip. It is better never to remove the india-rubber tubing.

d. Moist Cell. Bower and Vines, in *Practical Botany* (Macmillan), describe a very useful moist cell as follows:—Cut a piece of thick rough cardboard to the size of the glass slip, and punch a round hole in the centre rather less than a round cover-glass of ordinary size.

When used for a lengthened observation this is to be placed in boiling water to prevent the growth of fungi; otherwise it is only to be dipped in warm or even cold water before use. Water is to be dropped on it to supply the place of that lost by evaporation when using the apparatus.

e. Cell for Cover-Glasses. Before the commencement of each day's work a stock of ready-cleansed covers ought to be prepared for use. These clean covers are conveniently kept between two large clean watch-glasses, placed edge to edge. Such a contrivance is greatly improved by having a hinge of adhesive plaster. This cell is dust-tight, and capable of being kept very clean. Glasses of $\cdot 006$ inch in thickness and under should be

kept in it. All covers thicker than .006 inch should be placed in a pill-box: they are excellent for the rough-and-ready examination of tissues in teasing, irrigating, &c.

f. Moist Chamber. A good moist chamber is made by taking a small earthenware basin and placing wet blotting-paper on the bottom, inside, then inverting over a dish, or plate, or even over the top of the work-table. Articles such as slips with sections on them covered with a large drop of stain, or watch-glasses full of stains, keep well without loss by evaporation for twenty-four hours or longer. Of course the mouth of the basin must touch all round the flat surface on which it rests.

g. Frog Holder. This is described under the article on the Frog further on.

h. To Clean Glass Slips. Place the spoiled slides and dirty slips carefully in an old cigar-box which should be placed near the work-table. When this box is full, its contents are carefully placed in a solution of Hudson's extract of soap in a tureen, and in a day or two cleaned first with a rough cloth, then with a dry cloth, and lastly rubbed bright with chamois leather.

i. To Clean Cover-Glasses. Place them when quite dry in strong sulphuric acid for an hour; pour off the acid; let several lots of tap-water be run through them so as to remove most of the acid; after this lay them on a piece of gauze in a funnel and allow tap-water to run through them till every trace of acid, tested by litmus-paper, is removed. Lastly, remove them to methylated spirit, which should be changed in twenty-four hours in

case of a trace of acid remaining. Keep the glasses in spirit in a wide-mouthed bottle well corked. They should be kept in the spirit till wanted.

Cover-glasses when required should be taken out of the spirit, rubbed bright, and then measured before use. For rubbing the spirit off, and polishing, *sateen* should be used, held between the tip of the index-finger and the thumb. On no account must we bring a second finger into use, otherwise the cover-glass held and rubbed by the three will be broken. The sateen must be scrupulously clean, and used only for this purpose.

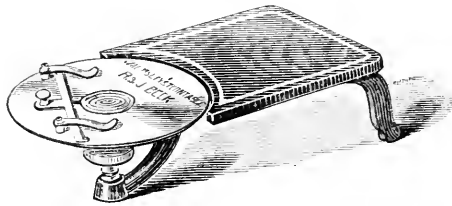

FIG. 33.—Turn-table.

Ringed Slides. A good turn-table is among the most indispensable of the histologist's tools for cell-making, securing mounts against leakage and against the action of the oil used with immersion lenses.

In the choice of a turn-table we must bear this in mind: that the spin we give to the table in using it must always be a gentle spin, not a violent twirl, or our cement will be scattered in a radiating manner all over the slide. If a gentle spin be an absolute essential it follows that the table must run smoothly and revolve for a minute or more without having to be touched

again. Many turn-tables are worthless on this account: they will not revolve beyond half a minute, even with a violent twirl imparted to them.

In ringing avoid putting too much cement in the brush: be careful that the slip does not catch the fingers, or it will be sent spinning far away, and probably spoil the mount upon it: let one coat of cement dry before putting another coat of a different material upon it: be careful to have the cement of proper consistence by adding a little of its own fluid solvent to it if it has become too thick: in centering the slip on the turn-table be careful to see that it is the cover-glass that is centred, *i.e.* the cover-glass ought to coincide with the rings upon the table of the instrument,—a gentle preliminary spin or two is required to determine this. If not centred the cover-glass “wobbles.”

The brush used must be small. One such brush will last a life-time if we are careful to rinse it in the same fluid the cement is dissolved in *immediately* after use each time. We cleanse the brush in benzol after using white zinc cement, or asphalt; and in oil of turpentine after gold size, and so forth.

The cements used are conveniently kept in wide-mouthed, glass-capped glass bottles, in each of which we keep a short length of solid glass rod to stir the cement before use if required.

Cell-making. The simplest form of cell is that made with a fluid put on the slip by means of a turn-table which afterwards solidifies. These are easily made by centering a slip on a turn-table, and ringing it with gold size, asphalt, dissolved caoutchouc, &c. Cells of glass,

brass, tin, or vulcanite, are also easily fixed on the slip by first centering the slip on the turn-table, then making a ring the size of the cell with xylol balsam; placing the slip out of the way of dust for the xylol to evaporate; then warming the slip and sticking on the glass, metal, or vulcanite cell. The base, sides, and top of the cell may finally be coated with any reagent which will be unaffected by the fluids we are about to place in the cell: shellac dissolved in alcohol, for instance.

To Anæsthetise. Chloroform is the best agent to use, for two reasons: it is rapid and pleasant, and it dilates the blood-vessels. If the student has no proper drop chloroform bottle, an ordinary small bottle can be used with a notch cut in the cork to allow of the chloroform escaping in a rapid succession of drops *almost* amounting to a stream.

Dogs and cats should be placed in a thin-sided bag, such as a pillow-slip, and the bag grasped and constricted close above them. The chloroform dropped upon the roof, so to speak, of the bag, that is, immediately beneath the hand, will diffuse itself within the space containing the animal, and anæsthetise it in whatever position it may assume.

Rats, guinea-pigs, and animals about their size are conveniently operated upon in a cigar-box which should have gimlet-holes in its ends. The lid of the box must be detached for greater convenience in catching the animal. Rats running in a box or cage are conveniently caught by laying a stout open brown-paper bag on its side in the box. They run into the bag and are easily inclosed and transferred to the cigar-box.

Frogs, newts, and little creatures like them are conveniently placed under an inverted tumbler into which a few drops of chloroform have been poured. The transparent glass enables us to see when life is extinct, or when profound insensibility has occurred. If from no higher motive the operator will always cause death or profound insensibility before proceeding to do anything to the animal; otherwise reflex action or returning consciousness may cause difficulties to arise and false steps to be taken. This almost universal desideratum of the physiologist is carefully concealed by professional anti-vivisectionists who obtain their livelihood by harrowing the feelings of the public.

C.—TEASING.

C 1.—**Normal Fluids.** When it is not possible or not convenient to submit tissues to hardening or softening processes, which takes time counted by days or weeks—for example, when one is making a post-mortem examination—we can examine in a rough and imperfect manner the so-called fresh tissues by cutting or snipping off a minute piece and teasing it out with needles. The process is called teasing.

In doing so moisture is frequently required by adding fluids that will not alter the structures we are examining, which up to a few minutes or hours ago have been bathed in natural or normal fluids within the body;

hence we imitate this state of things as nearly as possible by using what are called normal fluids. These are—

1. Blood serum.
2. Aqueous humour from a fresh eye.
3. Three-quarter per cent. (.75 p.c.) salt-solution.

Now it is evident that under ordinary circumstances the two former cannot be obtained; therefore we mostly use the last.

C 2.—**Dissociating Fluids.** Sometimes the elements of which a tissue is composed cannot be separated without dissolving the parts which bind them. When this is the case the tissue is cut into little pieces such as are used for teasing, and placed in some dissociating fluid. There are two such fluids of general application, namely—

1. Ranvier's Alcohol.
2. Osmic Acid Solution (.1 to 1 per cent.).

Tissues may be placed in either of these for twenty-four to thirty-six hours, then teased.

Besides the two general dissociating fluids there are several special ones mentioned by some authors. The student will do well to use Ranvier's alcohol for all.

C 3.—**How to Tease a Tissue.** Place the tissue under a lens, and upon a suitable background. Take two needles fixed in handles and gently separate the elements needed, keeping the eye steadily fixed on the work. Practise teasing with the compound body with an inch objective and a weak eye-piece. Ten minutes' practice at a time, for a very few times, suffices to overcome the difficulties of reversed images. When once mastered this method is the most satisfactory of all.

Use the same fluid in teasing as the tissues have last been in (normal, or dissociating). By those who cannot or will not master the process of teasing with the compound body some dissecting microscope must be obtained.

D.—IRRIGATING.

D 1.—**The Irrigation of Tissues.** When we wish to observe the behaviour of tissues when attacked by reagents we run the reagent under the cover-glass and watch the result. Having placed a cover-glass over the tissue to be irrigated and in sufficient proximity with the slip to command the presence of capillarity, we either place a drop of the reagent we wish to irrigate with at one side or edge of the cover-glass and apply a small piece of bibulous paper to the opposite edge, or we partially fill a pipette with the reagent and allow it to descend upon the edge of the cover-glass, using the bibulous paper as before.

A large pill-box full of small triangular pieces of bibulous paper should be kept on the work-table whilst irrigating, and with forceps first one then another corner of the triangle should be presented to the opposite edge of the cover to that at which the reagent enters.

E.--GASES AND VAPOURS.

E 1.—To apply Gases and Vapours. When we wish to observe the behaviour of tissues when gases are presented to them, or affect them by vapours, we use a deep cell with a cover-glass for a roof. Such a cell should be deep, so that the tissue or fluid we are observing may be well surrounded by the gas or vapour, and at the same time these may be supplied in the form of a stream; that is to say, the gas or vapour in the cell or chamber must not be stagnant, but must surround the tissue freely and thoroughly and be able to escape as freely as it entered.

One example will illustrate the process. Suppose we take a drop of blood and we wish to observe the behaviour of the white corpuscles when a gas surrounds any of them, we take not a drop but a droplet in this way: we lightly touch a drop of blood with the middle of the face of a clean cover and a droplet adheres. We now place the cover, droplet downwards, upon the rim of a deep cell, and the droplet is suspended from the roof of the cell, and it can be observed, even its lowest strata, by a moderately high power whilst gas or vapour is admitted to the cell. Solid tissues are treated in the same way; ciliæ, for instance.

F.—APPLYING HEAT TO TISSUES.

F 1.—**To use the Warm Stage.** If the student's means will permit, the warm stage of Reichert, or at least that of Stanley, should be used. Both have good Centigrade thermometers. With the primitive home-made one I have described the amount of heat applied as indicated by the melting of cacao-butter cannot be ascertained with any degree of certainty below or above the melting-point of the butter, which melts at about 35° C.

The same precautions as to taking a droplet and the same methods are to be observed as in the application of gases and vapours, E 1. The droplet or tissue should adhere to the cover and the cover should form the roof of a moderately deep cell.

G.—INJECTING.

G 1.—It is convenient and often necessary to fill the arteries and arterioles of a tissue, or organ, to ascertain their relations to the structure, or the other structures of a part. This is most conveniently done by a mass which will congeal and stiffen in an ordinary tempera-

ture. Such congealing masses are rendered fluid by warmth and coloured by a pigment that will uniformly colour the mass but not escape from the mass and stain the tissues. Such a composition we have in Dr. Carter's carmine gelatine mass which has now become the almost universal injection-mass.

G 2.—Carmine Gelatine Mass. All carmine masses are made after the model of Dr. Carter's mass. Carmine is dissolved in strong ammonia and every trace of this ammonia is got rid of in completing the mass, or the injected specimen will be diffusely stained with the carmine. On the other hand if in getting rid of the ammonia too much acid be used the carmine is precipitated in such coarse granules that the mass cannot be driven into the finer vessels and capillaries.

I make this mass in the following way and claim for the method complete simplicity and certainty :—

Take of

Carmine	3 grammes.
Liq. Ammon. Fort.	6 c.c.
Glacial Acetic Acid	6 c.c.
French Gelatine (gold label)	7 grammes.
Tap-water	80 c.c.

Place the gelatine, cut into small pieces, in 50 c.c. of the water until it has dissolved, or swollen to its utmost, which will take at least six hours.

At the same time put the carmine into a very small clean mortar and crush all the lumps with the pestle and add the ammonia. Let this stand for a couple of hours

or so, and give it a good stir from time to time, after which we may pour it and the remaining water (30 c.c.) into a small clean bottle, using the water for rinsing out the mortar in the process.

In about six hours we place the gelatine and its water in a water-bath, and whilst it is being melted we perform the critical operation on the carmine solution thus:— Hold the carmine bottle in the left hand, using the end of the fore-finger in place of a cork. Take the measured quantity of glacial acetic acid in a small bottle in the right hand, then, in good light, observe the beautiful dark-purple carmine solution. Now add the acid, a very few drops at a time, giving the carmine solution a good shake after each addition, and the very instant it changes colour to a carmine red stop adding the acid.

The difficulties and waste of time and materials frequently experienced in making this mass arise from attempting to filter the carmine and ammonia: from putting the carmine and ammonia into the gelatine solution before neutralising the carmine and in thus having to rely on the sense of smell in distinguishing the acetic from the ammoniacal odour about the point of neutralisation, which is no easy matter.

Immediately before the mixture changes colour the ammonia is neutralised; therefore, when the change has taken place, the solution is very slightly acid, which is what is required.

After the gelatine is thoroughly melted, add the prepared carmine solution to it little by little with constant stirring.

I usually make many times the above quantity, and

pour it into a clean ointment jar; and when it has become cold and stiff, pour methylated spirit on its surface. By placing it thus in a cold place well covered over, it will keep almost any length of time. When it has been made and preserved thus, the spirit is to be poured off and the surface dried with bibulous paper. When required for use, place the jar in warm water for a few minutes, then the mass can be shot out as a solid plug into the water-bath.

Filtering the mass is not required in making it: indeed no filtering at all is required except at the time of using, when it is better to pass it through a layer of fine flannel—wrung out of hot water—in transferring it to the Wolff's bottle.

The best carmine must be used. Glacial, not concentrated, acetic acid is required. The gelatine may either be Coignet's, or Swinborne's patent calves'-feet gelatine. Lastly, tap-water answers the purpose as well as distilled water.

I have kept jars of it ready in the way above described for three years: very likely it will keep good even much longer still, but the place it is kept in must be a cold place, otherwise the gelatine will melt and let the spirit into the mass.

G 3.—Blue Injection-Mass. This mass is also solid at ordinary temperatures. Unfortunately, specimens injected with it are liable to fade in colour: when, however, we are in a position to dip these in oil of turpentine, we can restore the colour wholly, or in part. All specimens injected with the mass should be mounted in the balsam thinned with turpentine.

Take of

Soluble Prussian Blue	2 grammes.
Coignet's Gelatine	7 „
Distilled Water	91 „

Rub down the powder in half the water (in successive portions) in a mortar, and pour the solution into a tall narrow vessel with perpendicular sides. Treat the gelatine with the remaining water as in the case of the carmine mass, and when melted add the blue solution little by little with constant stirring to the dissolved gelatine; then filter through fine flannel.

No alkali must come in contact with the Prussian blue. All vessels must be clean, and rinsed out with acidulated water (2 per cent. HCl solution) immediately before coming in contact with the mass or any portion of it. Distilled water is to be used in its preparation: tap-water will not do.

Most authors direct the watery solution of the blue to be filtered. As this is most troublesome, and takes some hours, we let the solution remain perfectly still in a narrow tall jar; and pipette off, or siphon off the fluid, all but the lowest stratum containing the dregs. The vessel containing the blue should stand quite half an hour unmoved, and care must be taken not to move it during the process of taking out the dissolved portion. Instead of making the blue, it is better to buy the powder ready made. Many gelatines precipitate the Prussian blue; therefore, the French gelatine, sold in clear thin sheets, must be used.

G 4.—**The Injecting Bath.** Some few years ago

I devised what has proved to be a most convenient bath for keeping the gelatine mass and the animal, or part to be injected, warm during the process of injection of the blood-vessels by constant pressure. At first I used a much larger bath, but for the past two years I have found

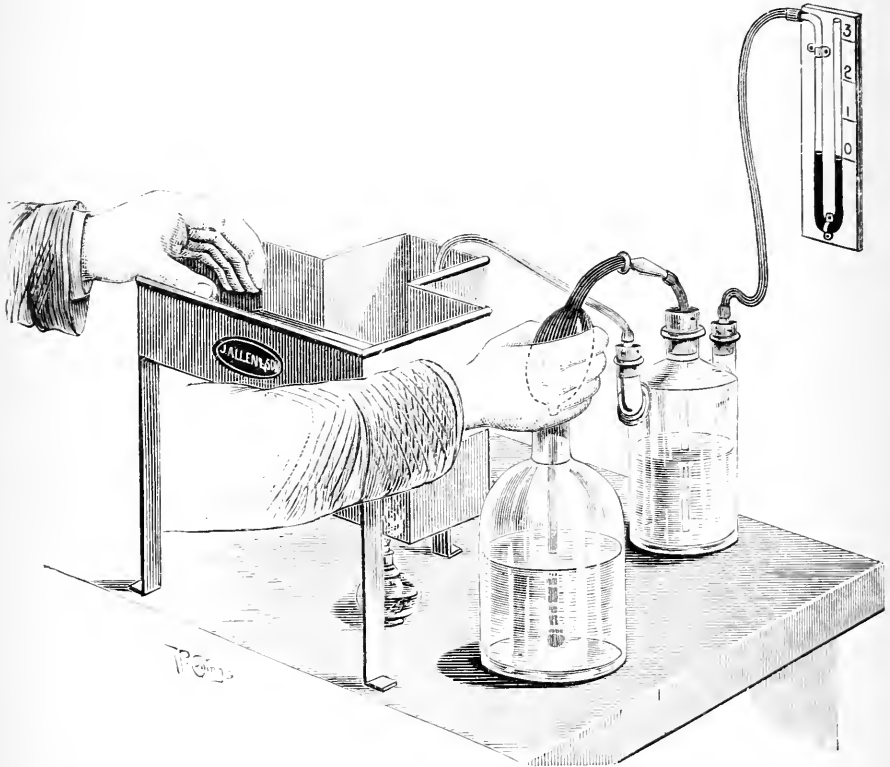

FIG. 34.—Injecting bath, author's pattern.

the present form most convenient in every way. It holds comfortably any animal one wishes to inject, from a full-sized cat or rabbit, downwards. The volume of water used is as small as possible, and easily kept at the

required temperature by a spirit-lamp with a small flame. It has two departments, namely a deep part for submerging the Wolff's bottle containing the mass, which we will call the well; and a shallow part on which the animal is laid, which we will call the shelf. The well and the shelf will be convenient terms in describing its use and structure.

The dimensions of the bath are as follows:—The shelf is 30 cm. long, 15·5 cm. broad, and 9 cm. deep, all inside measurements. The well is 24·5 cm. deep on three of its sides, and of course 24·5 cm. less 9 cm. on that side which communicates with the shelf. The length of the well corresponding to the length measurement of the shelf is 12·5 cm.; and the breadth of the well corresponding to the same way of measuring the shelf is 10 cm. It stands on three iron legs, the one under the well being 8 cm. in length.

This form of bath, and the constant-pressure method described, render injection with congealing masses a very much simpler and more certain method than that by the syringe; indeed the most accomplished injector with the syringe can never be certain beforehand of his results, after many years' practice; whereas the practice we have hereafter prescribed will render any ordinary man an accomplished injector in a week, or less, by the constant-pressure method.

Apparatus used with the Bath. This consists of a water-bottle (see Figs. 34 and 35), to hold about a litre of water or more; a Higginson's syringe; a three-necked Wolff's bottle, which should hold a litre or a little more; a two-necked Wolff's bottle, holding half a litre; a mano-

meter; a spirit-lamp; and glass or brass cannulæ and rubber tubing.

The water-bottle we need say nothing about; the Higginson's syringe also is the ordinary one sold for enemata purposes. It fell to my lot to discover a few years ago this extremely delicate method of applying pressure to the pressure-bottle. The pressure can be applied with such accuracy and delicacy that the

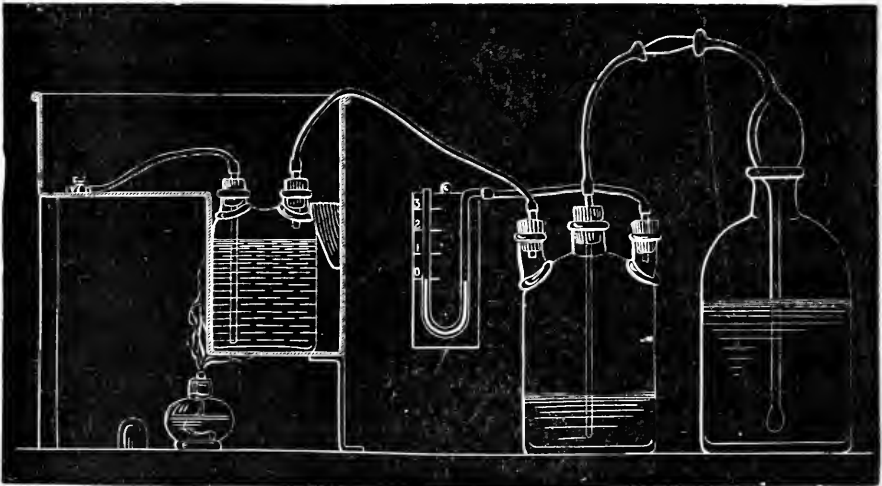

FIG. 35.—Diagram showing injecting apparatus.

mercury in the manometer can be raised almost imperceptibly, or as rapidly as possible, according to requirement. The three-necked Wolff's bottle should be fitted with india-rubber corks, all securely fixed permanently, as they never require to be removed. They should be held down by wire, like soda-water bottle corks. All three corks are perforated and transmit 0.5 cm. glass tubes; the two outer corks have their tubes

short, but the glass tube of the middle cork must extend quite to the bottom of the bottle. It will be seen by the diagram (Fig. 35) that the mass bottle is just the depth of the well of the bath, or rather the well of the bath must be just the depth of the mass bottle, so that the delivery tube from it lies well in the warm water, by being on a level with the bottom of the shelf of the bath. This is important. The mass bottle is a two-necked Wolff's bottle also fitted with india-rubber corks. Half-centimetre glass tubes pass through both corks: one a very short tube, the other continuous with the delivery tube must extend quite to the bottom of the bottle. The cork through which the long tube passes may be permanently wired down, as it never requires to be removed. The other cork, whose short tube is continuous with the pressure-bottle tube, must be removable to admit the filtered gelatine mass.

In using the apparatus the gelatine mass remaining after an injection operation must be poured out, and the bottle well rinsed with two or three lots of very warm water, each lot being allowed to pass through the long glass tube and rubber delivery tube when poured out. This secures a clean bottle ready for the next operation. The top of the long glass tube on which the delivery tube fits is best bent at right angles, which prevents a round elbow of the rubber tubing which might stand above the surface of the warm water. In the diagram the glass tube not being so bent the delivery tube is seen far away above the bottom of the shelf of the bath. For a wedge, to keep this bottle from floating up as the mass leaves it, any piece of

wood or cork can be made to do. The spirit-lamp is an ordinary one. It should be so placed that its flame streams up the inner side of the well of the bath. Two ordinary clamps are required, one for the pressure tube, the second for the delivery tube. The mercurial manometer, made with half-centimetre glass tube, should not be too long a one; then the temptation to apply too much pressure is avoided. One about twenty centimetres is quite long enough. The limb up which the mercury rises should have an index, marked by four distinct straight lines, on the wood which supports the tube, each one inch apart; the lowest line being on a level with the two surfaces of the resting mercury. Therefore, this allows for six inches of pressure. That is to say, when we apply pressure, the ascending mercurial column can rise three measured inches, which equals of course six inches pressure. At the very most we must never give more than five inches pressure, that is, two and a half measured inches of the ascending limb. Therefore we have a measured half inch of manometer to spare. I prefer the marks in inches rather than centimetres, as there are fewer marks, and each mark can be made more distinct, and therefore more easily read at a distance whilst injecting. It is quite easy to determine the relative height when the mercury stands between any two marks without any extra lines.

The cannulæ used (see Fig. 36), may be like the one shown at *a* and sold with anatomical injecting syringes. If so, the stop-cock, *b*, must also go along with them. This has a beveled end for fitting the cannula, and an

end into which fits the beveled end of the syringe. In our case this proximal end is securely fastened into the distal end of the rubber delivery tube with filosselle.

When glass cannulæ are used, as we have always to keep a pound or two of half-centimetre glass tubing in the laboratory, it is quite easy to make them in the same way we make pipettes. We heat as short a length of the tube as possible by revolving it on its long axis in the flame of a spirit-lamp, or a Bunsen's burner which is better; then when the flame is quite yellow the heated tube will be quite soft. Now quickly

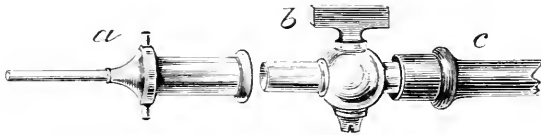

FIG. 36.—Cannula and stop-cock.

remove it from the flame, and with a steady strong pull draw it out in as straight a line as possible. The hotter the length of tube and the more quickly it is drawn out the finer will be the resulting capillary tubing. With a pound of half-centimetre glass tubing and a Bunsen flame we can, in half an hour, draw out some scores of capillary tubes of varying sizes. They will vary very much with the beginner, so that it is quite easy to select a dozen suitable sizes, and cut them with a file in the most suitable part. Each should be cut so as to allow a piece of tube one to two centimetres in length, that has not been drawn out or lessened in diameter, on which to fix our rubber tubing. The drawn-out end of the cannula should, for injecting purposes, be quite

long enough, but no longer than can be avoided. From two to three centimetres is long enough, and yet not so long as to render the cannula fragile. The end cut off with the file should be rubbed smooth on a wetted flag-stone, then held momentarily in the flame.

For injecting very small animals, such as frogs and mice, I much prefer brass cannulæ because the amount of water, or at least non-injecting fluid, which one has to use to fill the glass cannula and its shank and rubber collar, in making connection and excluding air-bubbles, is very great and dilutes the injecting mass too much. The advantages that glass cannulæ have over brass ones are two: we can see when the mass is flowing, and we can choose a larger cannula. Their disadvantages are that they require so much non-injecting fluid to fill them at connection time, and they are more difficult to close when the injection is completed and we wish to disconnect. On the whole, I think I prefer a full set of brass cannulæ and the accompanying stop-cock which usually go with a good anatomical injecting syringe.

The india-rubber tubing should be the black kind used for infants' feeding-bottles. It is best to get a couple of metres of this, as it is used with various instruments. The piece of tube, however, which fits on to the middle neck of the pressure-bottle had better be a wider kind, one centimetre wide, outside measurement, and eight or nine centimetres long. This width just allows the nozzle of the Higginson's syringe to fit tightly. This tube will be of white rubber which has a wire spiral inside to keep open its lumen. This wire of

course must be removed. The half-centimetre glass tubing we have described should be selected, and each tube measured, outside measurement, as it varies in diameter very much. The feeding-bottle tubing is slightly less than half a centimetre wide: this is all the better, as it has to be stretched a little, and therefore fits tighter. It is always best to use a soft ligature when tying this delicate tubing; when tying it is required, filosselle does very well. Hard cotton or ordinary string cuts it. It will be seen that there is only one removable rubber cork, that to the mass bottle already described. After use, before putting the bottle away, this cork should be removed, otherwise it may adhere to the neck of the bottle, and tear when next we wish to take it out. These details, and some details given in the method of injecting, may seem trivial and unnecessary, but we here emphatically say:—Think no attention to minute detail unnecessary in injecting congealing masses into the blood-vessels, or you will fail to get a good injection, and the temper of your temper will be often unnecessarily tried.

¶ 5.—**To inject the Blood-vessels of an Animal with a Congealing Mass.** It will be better to describe this operation in the order of the steps taken.

1. Fill the water-bath with warm water out of a kettle and set a lighted spirit-lamp under the deep well of the bath, as in Fig. 34.

2. Next melt the carmine gelatine mass and filter it into the Wolff's bottle through flannel. Then tightly cork the bottle and sink it in the well of the bath, and wedge it in with a piece of cork or wood. This is done

to prevent the bottle from rising out of the water as the mass leaves it.

3. Arrange the manometer, pressure-bottle, syringe, and water-bottle as in Fig. 34, and thread an aneurism needle with filosselle.

4. Now deeply narcotise the animal—cat, rabbit rat, or guinea-pig. With suitable strong pins pin down on a cork the legs and head as in Fig. 37. That is, a

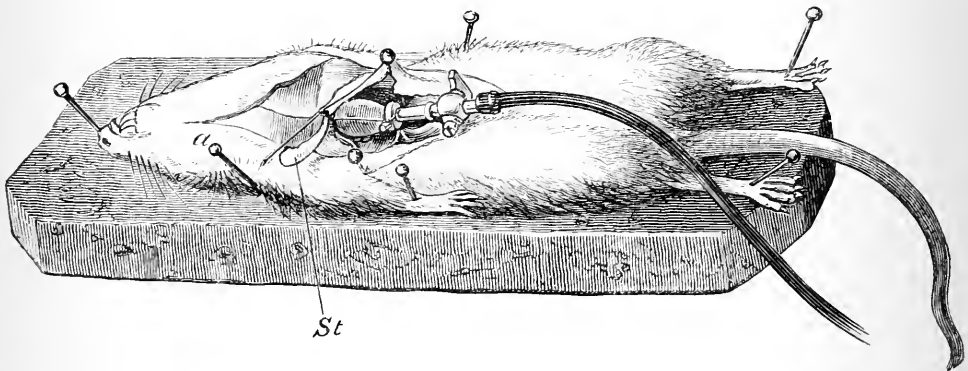

FIG. 37.—Rat ready for injecting.

pin is stuck through each of the four feet, and each foot is stretched downwards. The head is stretched upwards and fastened by a pin through the upper lip. With a pair of scissors incise the skin from the ensiform cartilage to the middle of the neck, and reflect the skin well right and left so as to get a good view of the thorax, especially the sternum and costo-sternal cartilages. Carefully pinch up the flesh over the ensiform cartilage and get one blade of the scissors into the thorax and cut through the costo-sternal cartilages, avoiding the sternum and the ribs, up to the first rib. Then cut through

the costo-sternal cartilages of the remaining side. The sternum, therefore, will now be attached at its anterior extremity only. Now cut away some pericardium, and make a snip into the right ventricle.

5. We next take a ligature and tie it very tightly around the attached end of the sternum. This effectually prevents a fertile source of leakage. Then, instead of cutting the ligature close off, tie a loop and pin this loop down as in Fig. 37, and bring the unattached end of the sternum under it.

6. Now with a gentle stream of water rinse all blood out of the thorax. We do this best by lifting the cork and its load and holding it under a water-tap.

7. The next is a most important step. Snip off the apex of the heart: this reveals the round left ventricular hole and the right ventricular slit. Choose the largest nozzle the aorta will admit, and push it gently into the aorta *viâ* the left ventricle. Then take the aneurism needle, and with a pair of forceps get the filosselle under the aorta without injuring it, and tie it tightly around the aorta which already contains the nozzle.

8. Lift the animal on its cork and place it on the shelf of the bath. The water, quite warm by this time, should cover—just cover—the entire animal.

9. With a pipette that will go to the very end of the nozzle abstract the blood from the nozzle, and also, with the pipette, carefully fill the nozzle with water taken out of the bath. In doing so take plenty of water in the pipette and push it into the aorta and gradually allow the water to flow out as the pipette is withdrawn. The

object is to fill the nozzle with warm water without allowing any pent-up air to remain.

10. Place a clamp on the tube through which the mass will flow, and with the Higginson syringe send sufficient water into the pressure-bottle to raise the mercury in the manometer an inch.

11. The last critical operation has now to be performed; namely, making connection between the animal's blood-vessels and the mass. The nozzle is full of warm water: now grasp the delivery tube with the right thumb and forefinger close to the nozzle, and with the left hand remove the clamp. Allow, by relaxing the grasp slightly, the air to get expelled from the delivery tube, and the moment the mass flows make the connection. The mercury may now be further raised, little by little, using the right hand for this purpose whilst the left grasps the head and keeps the lips apart that the colour of the lips and tongue may be seen. The deathly pale mouth almost instantly begins to blush, much to our relief, for then we know our mass is flowing. The first redness always appears in the gum between the lower incisors. The mercury may, after the first blush is seen, be raised as quickly as we like, to its full extent, four inches, *i.e.* two inches of the one limb of the manometer. Indeed he may raise the mercury to five inches at the very end of the process for a few seconds just before clamping the delivery nozzle.

12. The delivery nozzle, its tube having been clamped, may now be withdrawn, the tied-in nozzle secured, and the cork and animal placed in the coldest stagnant water. Water with lumps of ice in it answers

only be kept up a few seconds, and this just at the very finish. We know that the blood-vessels are distended, by the swollen dark-red appearance of the conjunctivæ. It is only when this stage has been reached that we give the final high pressure. We distend the vessels thus because to fill them only would not do: indeed after the animal has been quite cooled and is ready for dissecting, however distended the vessels may have been in the bath it will be found that now they are only well filled. Should the mass commence running out of the snip in the right ventricle before the vessels are well distended we must ligature the ventricle.

Injecting an entire animal is an easy matter or a very difficult one according to the way we set about it. If the beginner attempts to inject an animal with a congealing mass before he has used plain water, or masses fluid in the cold, he may probably be so disheartened that he gives it up believing that he cannot do it at all. Rats are excellent things to practice upon, and we will venture to say that with a couple of days' practice on rats killed with chloroform, using plain water in place of the gelatine mass—provided the steps are rehearsed with the same exactness necessary to inject as we have described, even to the filling of the bath out of the kettle and the placing of the spirit-lamp under the bath, in fact observing every detail—success is a certainty. We repeat that this rehearsal is laborious: that the bath must be emptied and filled for each operation: the bottle, syringe, tubing fixed *in situ* as if taken from the cupboard for each rat: in short for each rat the whole process and every detail observed until each act is taken automatic-

ally. Suppose success is obtained after two or three rehearsals, we would still advise the student to repeat the process until automatism is obtained.

Résumé. Set the mass to melt in a water-bath : fill the injecting bath with water out of a kettle and set the spirit-lamp going ; filter the mass into Wolff's bottle and apply cork ; wedge the bottle into the bath ; narcotise animal ; if a small animal pin out on cork ; reflect skin and open thorax ; cut away some pericardium and snip right ventricle ; ligature sternum ; remove blood from thorax ; cut off heart apex and tie on nozzle ; remove to bath ; pipette out blood and fill nozzle with warm water ; clamp delivery tube ; raise pressure in bottle ; make connection, and so forth.

The water in the bath may be any temperature from 37° C. to 45° C. The operator may choose either glass or metal cannulæ. An india-rubber collar should be used, whichever he chooses, and this collar as well as the cannula is to be filled with the warm water when connection is made. When the operator is sure of his ground he will find it an advantage to slit the abdominal wall in the middle line and allow the bowels to float in the warm water. Extravasation of mass from too high pressure most frequently occurs in the bowel vessels. Moreover, it is always well to watch how the bowels are receiving the mass.

G 6.—To inject the Blood-vessels of Mammalian Lungs. For this purpose we proceed exactly as if we were about to inject the entire animal with carmine gelatine up to the point of inserting the cannula. Instead of inserting the cannula in the round hole at

best. It may remain an hour or more in this. Then the nozzle having been cut away, the parts may be cut out, placed in 70 per cent. methylated spirit for twenty-four hours, then removed to 90 per cent., there to remain until required for cutting.

It will now be well to go over the steps of the process, and point out the errors to be avoided, and the best way of accomplishing each of the numerous operations. We take them in the same order as before.

1*a*. The flame of the spirit-lamp must be of ordinary size, not too large, or the water will be too hot by the time the animal is ready to be placed in it.

2*a*. The india-rubber cork must be wetted, and gently but firmly screwed into the Wolff's bottle. Of course we suppose the fellow-cork to be already in the Wolff's bottle, and tied down with wire permanently, as its removal is never necessary.

4*a*, 5*a*. The cork used should be 27 cm. by 8 cm. and 1.5 cm. thick. Such pieces are sold in retail leather-shops. In cutting through the costo-sternal cartilages make first a small snip immediately below the ensiform cartilage so that the index-finger of the left hand may be gently inserted into the thorax. The finger is pushed along the costo-sternal cartilages, and the blade of the scissors is run along the finger, thus preventing any injury to the parts the scissors might otherwise inflict. Great care must be taken to avoid cutting too close up to the root of the neck, otherwise vessels will be cut and permit copious leakage. The ligature must be placed as close up to the attached end of the sternum as possible. In opening the thorax thus not a single

vessel is wounded that will allow leakage. The snip in the right ventricle cannot be made too soon; indeed it may be made before putting on the sternal ligature.

6*a*. If the blood that has flowed into the thorax through the snip in the ventricle be clotted, and can be removed with the fingers, we had better not wash it out. But we must have a clear sight of the aorta, which appears as a white vessel at the base of the heart.

7*a*. In drawing the filosselle under the aorta in small animals, such as rats, sometimes the filosselle twists the aorta, that is, turns it round and round its long axis. This may be avoided by making the hole beneath the aorta for the filosselle large enough, then gently seizing the aorta and holding it up a little as the thread is being drawn. The elasticity of the aorta pushes the nozzle out of its lumen: this cannot be helped: it is not very difficult to keep the nozzle pushed up with one's fingers at the same time that the filosselle is being tightened around the aorta.

11*a*. In making connection be careful to keep the delivery tube in the warm water. The delivery tube when once the gelatine mass is in it, flowing or stagnant must always be kept submerged in the warm water for obvious reasons. Should the inner parts of the mouth remain pale and the mercury of the manometer remain fixed, the mass is not flowing. An air-bubble has got into the connection: we must disconnect and get the air-bubble out with the aid of the pipette and warm water. The pressure at two inches and a half must

abdomen close above the diaphragm, or in other words cut the anterior half of the animal away. The reason for the amputation is this:—The liver is extremely lacerable, and in turning up the lobes to get at the bile-ducts any cut-off rib or rigid body touching the liver surely lacerates it. By taking the steps we have directed there remains no source of injury to the liver, as all the ribs are removed and the liver lies on the diaphragm exactly as if contained in a soft flaccid bag. We now turn up and half over the liver lobes and expose the gall-bladder and the common bile-duct: the latter may be seen close to the portal vein. Place a filosselle ligature tightly around the common bile duct. Now cut off the fundus of the gall-bladder and gently press out as much bile as possible; then tie in a cannula exactly as if we were doing the same to the aorta. We now make connection in the manner already described and using a very low pressure, about one inch of mercury, inject our blue mass. Keep the bath going at a proper temperature, and allow the injection to proceed for half an hour or longer at low pressure only. “The blue fluid, driving whatever bile there happens to be left in the ducts before it into the lobules, penetrates first into the interlobular bile-ducts, and from these into the outer parts of the lobules, forcing the bile more and more towards the centre; here of course there is no escape for it except that a little may pass into the lymphatics and blood-vessels through their walls. Hence it will be understood that the injection can only be made to fill the intercellular biliary passages in the outer part of each lobule.”—Schäfer.

The entire part of the animal should be placed in cold stagnant water after we have secured the cannula, or its vessel, and made all sources of leakage secure. When quite cold the liver can be cut out and placed in cold methylated spirit for twenty-four hours, then it should be cut into suitable pieces, and select pieces placed in spirit for a week before cutting.

It is always more satisfactory to inject the bile-ducts of a liver that has had its blood-vessels previously well injected, because our blue mass has less resident bile to encounter, owing to the distended blood-vessels having forced much of the bile out of the liver entirely.

Sections of liver thus injected with Berlin blue must be mounted in turpentine balsam to preserve the colour of the blue as much as possible. Therefore as the turpentine is necessary, the slow mounting or exposure process will not do: the cover must be placed upon the liver section, and turpentine balsam used without previous exposure.

H.—DISSECTING.

H 1.—To dissect and take away Parts of a Small Mammal. When the parts and bits of a small mammal, such as a guinea-pig, rat, rabbit, cat, or small dog, will answer our purpose, we have several advantages; for instance, we can choose our own time:

the apex of the heart, however, we insert it in the slit, the former being the left ventricle leading to the aorta, the latter the right ventricle leading to the pulmonary artery.

1. Melt together, and keep warm till required, cacao butter two parts, lard one part. Have also ready a syringe of some kind, with a nozzle that will enter the trachea of the animal we propose to inject. This syringe should also be kept in the warm water.

2. Now proceed as if to inject the entire animal in every particular, but tie the cannula in the pulmonary artery, *viâ* the right ventricle. Make connection, and inject with carmine gelatine.

3. After making all sources of leakage secure, such as the left ventricle, carefully remove the "pluck" entire, and, still holding it in the warm water, fill the syringe with the butter and lard and inject the lungs through the trachea. Perhaps all parts of the lungs may not receive the mass, but some are sure to do so and thus provide ample material. The greatest care must be taken to avoid over-distension, which would break down the walls of the alveoli.

4. Now place the doubly-injected lungs in cold methylated spirit, which should be changed in twenty-four hours.

5. Cut sections with a razor moistened with spirit, by simply holding a bit of the tissue in the fingers. Even if we could cut too thin sections in this way we must not cut these sections too thin.

6. Transfer the sections to oil of turpentine, which will dissolve away the butter and lard; then transfer

to methylated spirit and stain in Kleinenberg's hæmatoxylin twenty-four hours, and mount in xylol balsam after clearing in clove oil in the usual way. These make most instructive preparations.

¶ 7.—**To inject the Blood-vessels of the Liver.**

The blood-vessels of the liver are nearly always thoroughly injected by the carmine gelatine mass when we have injected the blood-vessels of the entire animal; therefore, all we have to do after injecting the entire animal, when inspection shows the liver to be well injected, is to proceed to inject the bile-ducts with a gelatine mass coloured by 2 per cent. of Berlin blue instead of carmine.

¶ 8.—**To inject the Bile-ducts.** We prefer a rabbit for this purpose, but any other small quadruped will do. First inject the entire blood-vessels, and have in a separate water-bath a 2 per cent. solution of Berlin blue gelatine mass. Make the vessels secure, and disconnect after the injection with the carmine gelatine. Empty the Wolff's bottle of the carmine gelatine, and fill it with the blue mass and make everything ready. We suppose of course that the abdominal wall has been slit up in the middle line, and the liver found well injected with the red mass. Most carefully keep the parts well in the warm water and introduce the finger into the thorax, and cut the walls of its cavity all round close to the diaphragm. Now get two filosselle ligatures, and secure the thoracic aorta and the vena cava which we see stretching like a telegraph-wire from the diaphragm to the heart. Both aorta and cava must be ligatured close to the diaphragm. Now sever the thorax from the

through the entire spinal column and spoil everything. If the student elects to get out the cord by *weakening* the neural arch, after weakening he introduces one blade of the forceps a short way into the neural canal, and seizes the pedicles and bends and breaks them, first right, then left, all the way down. In getting out the brain, he must take away the cranial vault by *little bits*, introducing one blade of the forceps a short way each time with great care.

“Skill to do comes by doing,” and we advise the student to practise upon rats first before attempting to get out a brain and cord for subsequent use.

After placing the brain and cord in the bowl of fluid, a piece of large nerve such as the sciatic, a muscle (one of the thigh muscles chosen with due regard to its entire circumference being suitable for transverse sections mounted whole), a piece of a long bone (the head, neck, and a short length of the adjoining shaft of the thigh for instance), half the lower jaw if the animal be a cat or dog, pieces of skin, the upper lips and upper eyelids, and the nasal septum are to be taken. The remainder of the carcass can be thrown away.

By this time the fluid of the bowl must be changed for clean fluid of the same kind. The parts, well submerged, may remain in this fluid any time not less than six hours nor more than twenty-four, to suit the convenience of the operator.

We now get a wide, shallow vessel, such as a soup-plate, and having poured some Ranvier's alcohol into it prepare the tissues in it as follows:—All parts having a large extent of area but little depth, such as membranes

skin, lips, eyelids, walls of the hollow viscera (alimentary tube, bladder, &c.), are to be pinned out flat on pieces of cork with lillikin pins, or hedgehog spines, taking care to keep mucous surfaces outwards. The solid viscera, such as tongue, liver, spleen, kidneys, brain, spinal cord, &c., must have deep and free incisions made into them in such directions and in such a manner that no part of them is further separated from the hardening agent than a quarter of an inch. In other words, suppose we make incisions across the tongue half an inch apart, no part between the cut surfaces will be further away from the hardening fluid than the distance above prescribed. The direction of all such incisions must be in accordance with the subsequent requirements of section-cutting: this is easily remembered by regarding our knife-blade as a section when we are making these incisions; thus we cut across the long axis of the tongue; across the long axis of a kidney, but across the short axis also; across the long axis of the spleen, and so forth, because we only require cross-sections of the tongue and spleen, but sections both ways of the kidneys. Of course when organs are large, such as most livers, and the kidneys of large quadrupeds, the directions of our incisions are of less consequence provided they are half an inch apart, and deep, so that no bit of tissue is further separated from the hardening fluid than a quarter of an inch.

By bearing in mind the above principles, the student will be quite well able to place properly every part or bit of an animal in its most suitable medium without helplessly depending on detail.

we can kill the animal fasting, or at a suitable time after being fed: we can "fix" the tissues instantly after death, and take what parts and bits we require as our other engagements permit.

The animal after fasting, or being fed, is to be killed by the inhalation of chloroform. We then tie into the aorta, exactly as if about to inject the vascular system with carmine gelatine, a suitable cannula. This must be done instantly after death. The vena cava is to be opened and kept so; then the blood-vessels quickly flushed with salt-solution, and instantly afterwards with our "fixing" fluid (5 per cent. chromic acid solution, picric solution, Müller's fluid). By this means the fixing fluid gets at once into the tissues and "fixes" them.

The siphon bottles form a most convenient means of thus irrigating the tissues with our salt-solution and fixing agent. We are thus free to use those excellent fixing agents (chromic acid and picric acid), which have little penetrating power.

We take a wide shallow earthenware bowl, glazed on the inside, such bowls as are in common household use, and half fill it with the fixing fluid we have been using.

We now make an incision through the skin from the symphysis of the jaw to that of the pubis, and reflect it bilaterally: cut through these symphyses and all the superficial structures in the middle line between them, and completely eviscerate from tongue to anus, leaving nothing but the animal as an empty shell, so to speak, and place the entire viscera in the bowl of fluid.

With a syringe fill the hollow viscera (lungs, parts of

the alimentary tube, bladder, &c.) with the fluid, using whatever ligatures are necessary, and removing urine, faecal matter, &c., with salt-solution. See to it that the fluid in the bowl well covers all the contained parts.

As quickly as possible, get out the eyes, brain, and cord, and place them also in the bowl. In getting out the eyes, cut through each conjunctiva circularly, parallel to the cornea; hook up one by one the ocular muscles and cut through them; sever the optic nerve, and the eye without being crushed is got away. Before placing the eyes in the fluid, make a few meridional incisions through the sclerotic with a sharp razor.

The brain and spinal cord are always difficult to remove without laceration: the secret of success in this operation consists in faithfully carrying out the following principles; we either *weaken* the neural arch by cutting through the *junction* of the spinous processes and laminae, or *directly break* the neural arch by cutting through the *pedicles*. First of all fix the animal back upwards upon something (a piece of cork or a board) with stout pins; divide and well bilaterally reflect the skin from the tip of the nose to the root of the tail, and then get away by cutting and scraping every bit of flesh from the cranial vault and from either side of the superior spinous processes. Thoroughness in doing this will be amply repaid; indeed it is essential to success. Now with suitable shears (bone forceps, or scissors) cut through either the junction of the spinous processes and laminae, or through the pedicles. In small animals, such as rats and mice, unless the flesh be well cleared away and suitable shears are used, it is easy to cut

I 2.—**Laboratory Alcohols.** Students of this course will do well to get their methylated spirit from a first-class firm.

Their rules in the choice of alcohol should be as follows:—

1. Use methylated spirit for making percentage alcohols up to and including 75 per cent.

2. Use methylated spirit for dehydrating sections; it requires fifteen minutes to accomplish the task; whilst absolute alcohol will do the same in five minutes, but do it no better.

3. Never leave a tissue more than twenty-four hours in an alcohol weaker than 75 per cent. unless disintegration is required.

4. In hardening with alcohols where no other reagent is used, commence by placing the fresh tissue in a weaker and pass it through stronger alcohols until 95 per cent. is reached.

5. Always prefer a 95 per cent. alcohol to an absolute alcohol for permanently keeping specimens or sections.

6. Never use methylated spirit for stain mixing.

7. For hardening purposes methylated spirit is in all cases quite good enough.

I 3.—**Ranvier's Alcohol.** This is made by adding two parts of distilled water to one part of absolute alcohol or full strength methylated spirit; usually the latter is taken.

I 4.—**Seventy-five per cent. Alcohol (75 p.c. Alcohol).** This is made by adding 75 parts of alcohol, absolute or methylated, to 25 parts of distilled water.

I 5.—**Ninty-five per cent. Alcohol (95 p.c. Alcohol).** This is made by adding 95 parts of alcohol or methylated spirit to 5 parts of distilled water.

I 6.—**Picric Acid Solution.** Make a saturated watery solution of picric acid with crystals over.

I 7.—**To harden in Alcohol.** Place fresh tissues in 75 per cent. for twenty-four hours, changing the alcohol two or three times. Then transfer to 95 per cent. for a week, or longer if required. The 95 per cent. must be changed daily, but may be made with methylated spirit.

I 8.—**To harden in Picric Acid Solution.** Place minute pieces for a few hours, varying from eight to forty-eight, in changes of the solution.

In all cases the acid may be washed away with tap-water, but the tissues must not be longer exposed to the water than five minutes. They are then transferred to 75 per cent. alcohol, which is to be changed daily for a week or longer. Then they are transferred to 95 per cent. till hardened sufficiently. Some authors say the tissues are to be immersed in changes of alcohol until no more colour comes away. This would require oceans of spirit, and is not necessary.

CLASS II.

I 9.—**Müller's Fluid.** Dissolve 2·5 grammes of bichromate of potash in every 100 c.c. of a 1 per cent. solution of sulphate of soda.

I 10.—**To harden in Müller's Fluid.** This fluid is quite notorious for its penetrating powers, but takes a

I.—HARDENING AND SOFTENING.

Tissues are either too soft or too hard whilst in the fresh state to be cut, prepared, and mounted for permanent preservation and therefore require hardening, in a few cases softening, before we can dispose of them further.

There are two fluids, namely, alcohol and a saturated solution of picric acid, which harden, and which interfere very little or not at all with after staining. There are again, fluids made with chromic acid or its salts which harden and tan the parts, and if not well abstracted by water and alcohol retard or prevent staining. Lastly, there is osmic acid, which hardens and stains at the same time. It will be best to divide these agents into three classes accordingly.

CLASS I.

ALCOHOL AND PICRIC ACID.

I 1.—**Alcohol.** There are three kinds of alcohol used in the histological laboratory, namely, absolute alcohol methylated spirit, and rectified spirit. It is necessary to bear in mind what these alcohols are. Absolute alcohol is alcohol without water or any other mixture. Methylated spirit is alcohol or spirits of wine to which

a little wood naphtha is added to prevent people drinking it and cheating the Excise. Rectified spirit is absolute alcohol with 16 per cent. of water. In other words, absolute alcohol is rectified spirit from which the 16 per cent. of water has been abstracted. All three may be regarded as full strength alcohols where perfect dehydration is needed : in other words, any of the three may be regarded, for our purposes, as 100 per cent. alcohol ; therefore when a percentage alcohol is prescribed, Ranvier's alcohol for example, the one part of alcohol may be absolute, rectified, or methylated as we choose.

Authors who ought to know, Rutherford and Stirling for example, distrust methylated spirit for preserving specimens permanently. Messrs. Cole and Son never use anything else, and their pathological material is kept in the most perfect state possible. I think that any specimens kept in any alcohol whatever must be looked at from time to time, and the spirit changed if a muddiness appears. Whence this muddiness ? those who distrust methylated spirit may ask. The reply is that it will occur occasionally with any alcohol and its specimens, and most likely arises from imperfect hardening of the tissue either from the wrong agents used, or from the tissue not having been put into the hardening agents sufficiently soon after death, in which case the protoplasm has undergone changes which have rendered it beyond preservation.

It is important to remember that in speaking of or prescribing alcohol the full strength is meant, whether that be absolute, methylated, or rectified.

long time, counted by weeks, to harden. Pieces of great size or whole organs may be placed in it, but it is best to be moderate, and cut the pieces into the size of 1 cm. cubes, or pieces of that size if of another shape.

Place the fresh tissue in the fluid, and change the fluid daily if possible, as it hardens quicker. If desired the fluid may be changed at the end of twenty-four hours, then every fourth day, but at least thirty days will usually be required by so doing, whereas if the fluid be changed daily perhaps half the number of days will suffice.

When hardened, place the tissues in running water for an hour, then in 75 per cent. alcohol, changed once or twice, for a few days, then transfer to 95 per cent.

When fat in cells is to be preserved, blackened or not with osmic acid, the tissues hardened in Müller's fluid are not to be placed in spirit.

I 11.—**Klein's Fluid.** Take 2 parts of a one-sixth per cent. watery solution of chromic acid and mix 1 part of methylated spirit with it.

I 12.—**To harden in Klein's Fluid.** Mix the two ingredients fresh each time of using, though the one-sixth per cent. may be kept in quantity already made.

This fluid is of as general application as Müller's fluid. It hardens in from three to ten days, and must be changed at the end of the first twenty-four hours, then daily, or at least every second or third day. The tissues are to be carefully felt and tested daily where chromic acid is used, or they may become brittle and thus spoilt.

The fluid penetrates moderately well, and has the great advantage of bringing the various tissues of which

an organ may be composed to a uniform standard of hardness.

The tissues, after being removed from the Klein, are washed in tap-water for an hour or two, and the hardening completed in alcohol, commencing with 75 per cent.

I 13.—**Bichromate of Ammonia Solution.** This is used as a 2 per cent solution in distilled water.

I 14.—**To harden in 2 per cent. Bichromate of Ammonia.** Place the fresh tissues in the fluid and change the fluid very frequently, daily if possible.

It requires fifteen, twenty, thirty, or more days to harden, the time largely depending upon the frequency of changing the fluid.

The hardening, after getting rid of most of the bichromate with tap-water, is to be completed with alcohols, commencing with 75 per cent.

I 15.—**Chromate of Ammonia.** This is used as a 5 per cent. solution in distilled water.

I 16.—**To harden in 5 per cent. Chromate of Ammonia.** Place the tissues from twenty-four to forty-eight hours in changes of the fluid, then wash a few minutes in tap-water, and complete the hardening in alcohols, commencing with 75 per cent.

This solution is used on account of its property of preserving the intra-nuclear network of nuclei.

I 17.—**Erlicki's Fluid.** Dissolve 2·5 grammes of bichromate of potash and 0·5 gramme of sulphate of copper in every 100 c.c. of distilled water.

I 18.—**To harden in Erlicki's Fluid.** This fluid is used to harden the brain and cord, which it does in about ten days. It will do so in half the time if we care

to take the trouble to keep it at a temperature of about 40° C.

It must be made fresh each time and filtered before use. It must be changed daily or nearly so, and when the tissues are hard enough the fluid is washed away with tap-water and the tissues finished in alcohols, commencing with 75 per cent.

I 19.—**Chromic and Nitric Acid Fluid.** This is made by adding 1 part of strong nitric acid to every 100 parts of a 0·5 per cent. solution of chromic acid.

I 20.—**To use Chromic and Nitric Fluid.** This solution is used for the double purpose of dissolving out the salts of bone effected by the nitric acid, and hardening the bone matrix effected by the chromic acid.

The fresh bone is placed in repeated changes of the fluid, which must be freshly made each time. The bone is tested with a sewing-needle, which should be able to penetrate the bone without meeting with grit, when the processes will have gone far enough. Ten days may be allowed to lapse before commencing the testing process.

The solution is got rid of with tap-water, and the bone placed in alcohols to complete the hardening of the matrix.

If sections of the bone render water in which they are placed acid, the water should be repeatedly changed, or 5 per cent. solution of carbonate of soda may be used.

CLASS III.

I 21.—**Osmic Acid Solution.** This is used as a 1 per cent. solution, which is better purchased ready made. Care is to be taken to thoroughly surround the bottle in which it is kept with black paper so as to exclude every ray of light.

I 22.—**To use Osmic Acid Solution.** It is used to stain fat, which it blackens. It must always be borne in mind that strong alcohols dissolve the fat out of its cells; therefore after hardening a tissue in Müller's or Klein's fluid, the former being best, sections are to be cut without the tissue being further treated, as is usual with alcohols of increasing strength, and placed from one to twenty-four hours in the osmic solution.

When fresh tissues are placed in the solution for hardening and staining only the very smallest bits must be taken, as the acid will not penetrate.

GENERAL REMARKS ON HARDENING.

Choose a cold, dark place for the purpose.

Take the tissues immediately after death, especially in the hot weather of summer, and lose no time in getting them placed in the hardening fluids.

Cut them with a very sharp razor on a wax slab *in the same plane* as that from which sections are to be taken.

Except in the case of Müller's fluid, no tissue must have any portion of its interior further away from the

nearest surface than $\cdot 5$ cm. or at most 1 cm. In other words, no hardening fluid, Müller's excepted, is to be expected to penetrate beyond $\cdot 5$ cm. If a part be further from the fluid than this it may be rotten or spoiled before the fluid reaches it.

Always suspend the tissues in the upper half of the fluid, and never let them lie at the bottom of it. If they have any blood or dirt about them, wash it off gently with normal salt-solution, not with water.

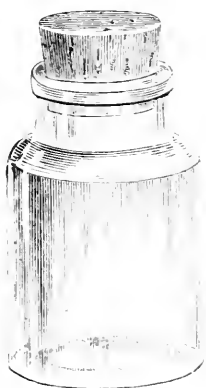

FIG. 38.—Hardening and preserving bottle.

Either place the tissue in a less quantity of the fluid and change this daily, or keep a diary and note in it when each has to be changed, and what fluid is to be used at the change. I much prefer the former method. The two-ounce, wide-mouthed bottles (see Fig. 38) suit admirably for hardening purposes if too much tissue be not placed in any one of them. Half a gross fitted with excellent corks costs six shillings at Messrs. Maw, Son, and Thompson, Aldersgate Street.

On no account keep a tissue or a section in a preservative or hardening fluid that has become muddy.

Label each bottle in a very clear, but thorough manner, or simply label it with a letter or number and keep a full record in a book.

Tissues hardened in alcohol or picric acid have their albumen coagulated ; those hardened in the chromates have their tissues tanned ; therefore when the two former have alone been used the tissues must not be exposed to the softening influences of water, or they go back, that is, become soft again. With regard to those tissues thoroughly hardened by chromates, they can be placed in tap-water, stagnant or running, for hours before being placed in a percentage alcohol.

J.—EMBEDDING.

When sections have to be taken from a piece of tissue it is necessary that the tissue be held firmly, otherwise the knife cannot do its work. There are two methods of embedding, namely simple or peripheral, and interstitial. By simple embedding the periphery only of the substance is grasped : as when we hold a piece of tissue between the thumb and fingers ; or press it between two pieces of carrot, elder pith or amyloid liver ; or pour a liquid over it which will, on becoming cold, harden, such as a mixture of wax and oil. By interstitial embedding is meant the infiltration of the entire tissue with a liquid which on simply changing its physical condition

surrounds and supports every cell and every fibre of the tissue. Thus we place a piece of tissue, after due preparation, in melted paraffin, which will penetrate every space of the tissue however minute; this paraffin on becoming cold resumes the condition of hardness and solidity it had before being melted, and incloses tightly every cell and fibre of the tissue. The same may be said of celloidin dissolved in alcohol and ether, only heat is not applied. The solution penetrates the piece of tissue, and on removing this to the open air the solvents (alcohol and ether) of the celloidin evaporate and leave the celloidin tightly inclosing every cell and fibre. Again, the method of cutting sections in frozen gum is really an instance of interstitial embedding: the liquid gum is first allowed to penetrate the tissue, as much so as the melted paraffin, or the dissolved celloidin; then it is rendered solid by freezing, and the tissue is cut whilst in this condition.

The choice of an embedding method is influenced more by the microtome in which the sections are to be made than by any other consideration. Thus, if a student has a *well* microtome only, he will not think of embedding in gum and syrup to be afterwards frozen; on the other hand, should he possess only a Cathcart's microtome, made for freezing only, he will not think of embedding in carrot, or in wax and oil. If every student had the same microtome, it would only be necessary to describe embedding methods suitable for it; but as there are so many different ones it is necessary here to describe methods of embedding to suit any microtome.

There are two methods of simple or peripheral embedding, and two methods of interstitial embedding, four embedding methods in all, which are thoroughly efficient, each as far as it goes: one or more of these methods will suit any microtome. These are, embedding in carrot, wax and oil, paraffin, and celloidin.

J 1.—**Embedding in Carrot.** Carrots may be obtained all the year round nearly, and with very little practice substances from retina, lung, and testicle to spinal cord and shafts of bone—that is, substances of all shapes and consistences—can be held with sufficiently equable pressure to insure sections being made of any degree of thinness up to about 30μ with the ordinary Stirling well microtome. A set of cork-cutters is required, one piece of which must have the same internal diameter as the well of the microtome. Take a sound carrot as large as required: cut a sound piece out of it one inch and a quarter long: place this piece on one end, and, with the cork-cutter the size of the well of the microtome, cut it to fit the well of the microtome tightly; with a flat-bladed knife divide this piece into two equal semicircular pieces. The further cutting depends on the shape and size of the tissue to be embedded. If a thin flat piece of tissue, such as retina, or cornea, is to be cut, the least possible scraping of the upper half of one of the pieces of carrot only is required. If a piece of lung is to be embedded, a round hole or gauging of the upper part of the face of one of the pieces half the size of this very compressible tissue will be required. If a piece of spinal cord, choose a

cork-cutter slightly less in its internal diameter, and bore or gauge the upper face of one of the pieces of carrot. In short, one only of the two pieces of carrot is to be bored or gauged, and the piece cut out must be very slightly less in the case of firm bodies, and very much less in the case of compressible bodies, so that when the fellow piece of carrot is placed in correct apposition the piece of tissue may be firmly grasped. When the piece of tissue is irregular in shape, the piece of carrot must be cut with a small cork-cutter used as a gauge and the piece placed in the space with or without the fellow piece of carrot from time to time; care being taken to gauge tentatively, to avoid taking too much away from any part. The plug thus made is pressed down into the well of the microtome in such a way that the slit in it points *right and left* as the operator sits, and the half containing the tissue is nearest to the operator. The method of cutting the tissue will be described in another place.

J 2.—Embedding in Wax and Oil. Take equal quantities by weight of white wax and olive oil, and melt them in a porcelain bowl which has a pouring lip and a short handle. If the temperature of the room be above 66° F., a little more wax may be added; if below 56° F., a little more oil. In other words, equal parts by weight make a mixture which cuts admirably in any temperature from 56° to 66° F. The extra hardening, or the extra softening, respectively, by the addition of wax or oil, may quite well be left to guess-work, tempered with ordinary care, as the proportions are after all very elastic; but the *equal quantities* must be the starting-point.

The two substances are amalgamated by being heated over a spirit-lamp, or an air-gas flame. The pipkin should rest on a layer of sand on a metal saucer; in other words on a shallow sand-bath, then as soon as three-fourths of it is melted the flame may be extinguished, and the solid portion, moved about with a needle, will be melted by the already melted mass and the accumulated heat in the sand. Instead of wax and oil, two parts of paraffin wax to one part of chrisma or vaseline may be used; but I prefer the wax and oil.

J 3.—**Bathing in Paraffin.** In those very numerous cases in histology where very thin sections (3μ to 5μ) have to be made it is best to impregnate the tissue with a suitable paraffin before embedding in it. All the tissues required for this purpose can, with a little forethought be collected, prepared, and bathed in a suitable paraffin at one operation. This saves much time and labour: to have every tissue thus required in one bottle is a convenience which every student working privately and every teacher must appreciate. Any bit of tissue so preserved can be taken from the bottle and a section from it; or, in the case of a class, fifty or a hundred sections from it, each not thicker, if occasion requires than 5μ or 3μ , can be under examination in less than a quarter of an hour.

Paraffins of two melting-points should be procured, also some of Allen and Hanbury's chrisma, a very pure kind of vaseline. The paraffin of low melting-point will be about 110° F., that of high melting-point 136° to 140° F. Next to the selection and combination of the paraffins,

or paraffin with vaseline, the temperature in which it has to be cut is the greatest consideration. To avoid having to bath in a paraffin of higher or lower melting-point it is best to provide for cutting at a temperature of 60° F. in the winter months and for a temperature of 70° F. in the summer; because the temperature of the room in either season is easily regulated to these temperatures. Thus, in winter a fire can be lighted if the room is below 60° F., and in the cold weather we often have in summer this can be done and thus bring the room up to 70° F. On the other hand, in hot summer weather if the air of the room has a temperature above 70° F. this will only be during the middle of the day from ten o'clock to four, and even during this time an open window will reduce the temperature so that we can get most perfect sections.

Two parts of the paraffin (136° F.) to one part of the paraffin (110° F.) make a mass which cuts perfectly in a room at 70° F. The lower melting paraffin (110° F.) either alone or with one-fifth of its weight of the higher melting paraffin added, cuts well at 60° F. Equal parts by weight of the 136° F. paraffin and chrisma make a mass which cuts well in a room at 55° F. A convenient apparatus for bathing tissues in melted paraffin is the hot-water oven such as the one shown in the annexed figure. It is made of copper and covered with a jacket of felt. The flame may be either an air-gas burner surrounded by a mica chimney, or an ordinary gas-burner screwed into a coil of lead pipe. I prefer the latter. Page's gas regulator, which is very simple and inexpensive, may be used to regulate the amount of flame required.

To save time the bath has a large kettle of boiling water poured into it, then filled up with cold water. Also to save time the paraffin should be melted in a porcelain

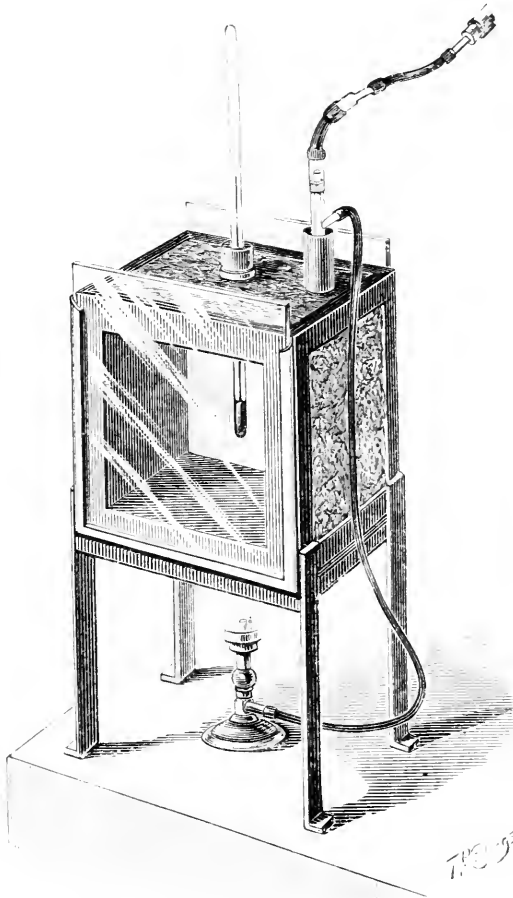

FIG. 39.—Hot-water oven for bathing in paraffin.

pipkin like Fig. 41 before being placed in the bath. We must however in the latter case pour the melted paraffin into the beakers, and allow the amount of extra heat

above the melting-point to escape before placing in the bath. The small beakers, or short flat-bottomed test-tubes, which hold the paraffin should be supported by something well above the bottom of the bath, so that the paraffin is acted upon by the heated air of the bath only.

The thermometer, which had better be a Centigrade one, should be steadily registering the melting-point of the paraffin, or at most 2° above this, for a quarter of an hour at least before placing the tissues in the paraffin. If there be no gas regulator to the metre the operator must be aware of the extra pressure in the gas mains applied on the approach of twilight; thus on two occasions I have left my bath going steadily at 50° C. at 3 p.m. in winter and have returned at 5 o'clock to find it at 64° or so, and of course my tissues all spoiled.

In order to ascertain the melting-point of paraffin—no easy matter—first melt the paraffin in a glass beaker over a spirit-lamp, and allow it to cool a little until signs of congealing appear. Instantly remove it to the water oven, which must be steadily going at the temperature we think nearest the melting-point of the paraffin we are trying. The beaker must be held by a wire frame or tripod well above the bottom of the bath. If in half an hour, not less, the paraffin has congealed it has a higher melting-point; but if it remains fluid it has probably a lower melting-point. After changing the temperature of the bath until the exact melting-point is reached, we ought to remove the beaker and place a few shavings of the paraffin we are trying upon a piece of glass and lay this on the tripod and watch the effects

of the ascertained heat upon it for half an hour or more.

The two paraffins, 110° and 136° F., should be tested on being admitted to the laboratory, and all blended paraffins also. Afterwards they should be placed separately in tin or wooden boxes with their melting-points carefully labelled or scratched upon the box.

The variation of the thermometric reading caused by opening the bath, also by introducing paraffin containing more heat than that required to melt it, are two difficulties in the process. The latter is avoided by taking the precaution above alluded to.

To prepare tissues for the paraffin-bath it is essential that they be thoroughly hardened and thoroughly dehydrated; therefore they must be taken direct, either out of undiluted common alcohol, or absolute alcohol. From the alcohol they are placed directly in creosote, and when thoroughly permeated by this they are, after having all their surfaces touched with bibulous paper to get away as much creosote as possible, placed in the melted paraffin. Thus, suppose we have a cubical-shaped piece of liver 1 cm. in size, a piece of cornea, and a piece of cat's spinal cord 1 cm. in length, to bath in paraffin: the liver will have been hardened in bichromate of potash followed by alcohols of 75 per cent., afterwards full strength; the piece of cornea will probably have been hardened in Müller's fluid, followed by the two alcohols just named; and the spinal cord will probably have been hardened in Erlicki's fluid, followed by the two alcohols. In other words, all three tissues are in common alcohol of full strength or in

absolute alcohol, which has given the last touch of the hardening process to them; therefore, at any moment, they can be taken from the spirit and placed, with as little spirit as possible, in the creosote. The creosote would thoroughly permeate the cornea in half an hour, the spinal cord in two hours; but the liver would require perhaps four to six hours, perhaps longer, therefore we should let all three be in the creosote at least six hours, and longer if our time permitted. Again, the paraffin would permeate the cornea in half an hour, the cord in one hour, and the liver in three hours, perhaps less; but we should allow all three to remain in the paraffin-bath quite three hours, and, better, four hours, to be certain of thorough impregnation.

Suppose, further, we were staining these three pieces *en masse* before bathing, we should take them from the spirit as before, and place them, probably, in borax carmine, or in Kleinenberg's hæmatoxylin. The cornea would require to remain in the stain at least twelve hours, the cord thirty hours, and the piece of liver one hundred hours; therefore, we should let all three remain in the stain four days and nights at least, and, if time permitted, a full week. After taking them out of the stain we should put them in several changes of common alcohol of full strength, to abstract all superfluous colour; this would take twelve hours, and we should let them remain another twelve hours in a fresh lot of alcohol to thoroughly dehydrate, perhaps using absolute alcohol for this last twelve hours. Lastly, we should take them from the alcohol, put them in the creosote, and bath them in the paraffin as already described.

J 4.—**Embedding in Paraffin, Wax and Oil, &c.**

Whether we use wax and oil, paraffin and vaseline, or simple paraffin alone, the process of embedding is the same, therefore one description will do for all. The best way is to make a rectangular trough with either brass embedding **LL**, such as are shown in the annexed figure, or paper, or capsule metal; then, having melted the embedding mass in a porcelain pipkin over a spirit-lamp, or air-gas burner, we pour the mass into the trough so as to overfill it. We now transfix the piece of tissue

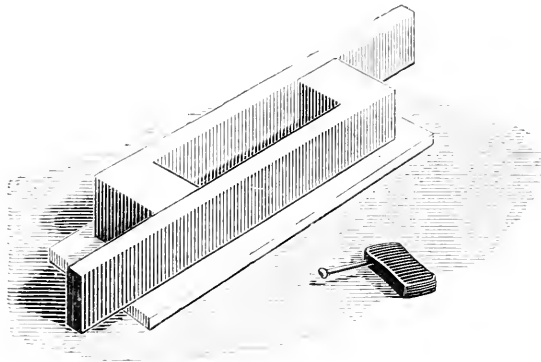

FIG. 40.—Embedding **LL**.

with a lillikin pin in the *direction of the cutting plane* (see Fig. 40), and when congelation shows itself either at the bottom or sides of the trough we instantly insert the piece of tissue into the *middle* of the melted mass and as quickly move it towards the end of the trough until the surface from which sections have to be taken almost touches one or other end of the trough. If the **LL** are used they should be placed in pairs on glass slips. The mass coming in contact with the cold brass and glass

soon congeals: Great care must be taken to avoid placing the tissue in the mass whilst it is too hot: at the same time the mass must be fluid enough, otherwise there will be gaps between the tissue and embedding mass when cold.

If there be no necessity for transfixing the tissue with a pin to keep it in the proper relative position for section-cutting, a heated needle may be used for placing the tissue in position after it has been placed in the trough, taking care not to burn the tissue with too hot a needle.

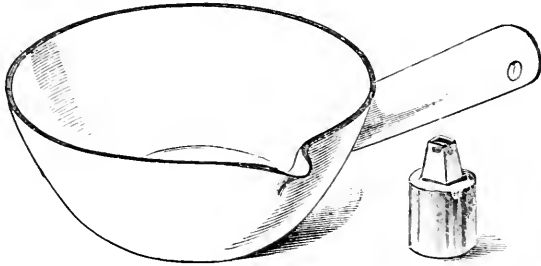

FIG. 41.—Porcelain melting-dish and mounted block.

The embedding mass must be quite cold and set before the mould is removed. To accelerate the cooling the whole may be placed in cold water or under the tap. After the block has been removed it should be placed on a wax slab and pared with either a sharp razor or a scalpel. First commence by paring and exposing the end of the block the tissue is in. When opaque masses, such as wax and oil, are used, the piece of tissue cannot be seen before commencing to cut away the mass; therefore some advise a mark to be scratched on the end of the congealing block. This is scarcely requisite,

because the taking away of a very few shavings from either end of the block reveals the presence or absence of the tissue. About a quarter of an inch of the block to form a base should be left. The end of the tissue from which sections are to be cut must be exposed, then the sides must be pared and bevelled (see Fig. 41) in the case of paraffin embedding when ribbons of sections are to be cut. Care must be taken to avoid weakening by over-paring in the case of wax with oil, or paraffin with vaseline masses.

If the tissue embedded be recognised before sections are taken from it the name can be scratched on the block with a sharp needle before the block is placed in the bottle or box in which it has to be kept. In all cases the name should be scratched upon the block either before or after cutting. The name should consist of two words, the name of the animal and the name of the tissue, thus: aorta Horse, duod : Pig, skin Frog.

J 5.—Embedding in Celloidin. This is a most simple and most effectual method of embedding, but it requires the knife to be moistened with alcohol, and the edge of the knife to move obliquely in cutting; therefore unless the knife be fixed in a frame as in Thoma's microtome it is as impossible to cut thin sections as embedding in carrot; indeed it presents no advantages over embedding in carrot, where the knife is held only by the hand, except in those cases where there is no tissue binding the parts together, as in transverse sections of intestinal villi, &c. When however the knife has a mechanical movement, as thin sections of small area can be obtained by celloidin as in paraffin

embedding. With my Thoma's microtome I can make 5μ , 4μ , and even 3μ sections of tissues embedded in celloidin with ease.

The method of embedding in celloidin is simple in the extreme. The tissue must have been properly hardened, and must have been dehydrated in strong alcohol: then it is transferred to a mixture of equal parts of absolute alcohol and ether in which it must remain at least two hours, though as much longer as the operator chooses. From this it is transferred to a very thin solution of celloidin in equal parts of absolute alcohol and ether in which it must remain twelve hours at least, or as much longer as one likes to keep it. Indeed we may keep tissues permanently in this ready for cutting. We must also keep a thicker solution of celloidin than the above. When we wish to cut the tissue all that is required is to take out with forceps our tissue and place it on a dry, sound cork of suitable size, and wait for a minute or two until evaporation of the solvent has caused a film to form. We then paint it all round and over with the thicker solution, and after waiting about half an hour for evaporation to take place, we either place cork and tissue in strong alcohol until we wish to make sections, or we can take sections from it at once, moistening the knife with strong spirit. If we wish to keep sections thus made unmounted we place them in strong spirit (such as full strength methylated spirit).

If the tissue has not been stained beforehand, we can stain the sections in any stain whatever, and either mount them at once or keep them, stain permitting, in alcohol.

Sections can be mounted in glycerine jelly, Farrant's medium, glycerine, &c., without the celloidin being removed, but when we wish to mount in balsam the celloidin is removed by first placing the section in the centre of the slip, then, with a camel-hair brush, placing clove oil, a powerful solvent of celloidin, *under* the edge of the section, and tilting the slip so that the clove oil, as many lots as are required, may float away the celloidin.

Where Thoma's is the only microtome the student cares to have, embedding in celloidin answers thoroughly for gelatine-injected tissues and in those rare cases where large sections are needed. With the greater proportion of sections (sections of small area and great thinness) the student can please himself whether he baths and embeds in paraffin, or uses celloidin. That is to say, when the student has a Thoma's microtome he can cut everything in celloidin should he choose to do so.

J 6.—**Embedding in Gum Mucilage.** The tissues after being properly hardened must have all spirit removed by placing in repeated changes of tap-water for an hour or longer. The tissues are then placed for at least twelve hours in gum mucilage containing a little simple syrup. The gum mucilage and the syrup are made according to the B.P. formulæ. A convenient way of keeping tissues—I have some now which I first placed in the gum and syrup five years ago—is to take a large pomade-pot and more than half fill it with the gum mucilage, then pour a little syrup to it, and after adding a few crystals of phenol and well-stirring, place the tissues in it. Some tissues, notably those which have

not been hardened by chromic acid or the chromic salts, become soft in the gum and syrup, but most tissues keep in it very well.

Some authors, Stirling for instance, give definite proportions of gum and syrup. This I think is unnecessary. The syrup prevents the gum being frozen too hard. If a little syrup only be added, the tissue may be taken and frozen as it is: if however large proportions of the syrup are taken, the tissue must have the gum and syrup removed by wiping with a soft cloth, then surrounded by gum solution on the microtome.

K.—SECTION-CUTTING.

Before describing any microtome it will be best to describe the general principles of section-cutting.

Just as we take a general survey of a microscopic object, using a low power, before examining a special part with a higher power, so we should expect to require two different kinds of sections—a section of large area and not necessarily very thin, and a section of small area as thin as possible. In practice this is not always required, because the majority of sections although small show the general composition of the structure provided some of the investing membrane be also taken. For example, a small area of liver with its capsule, of tendon with its investing membrane, of

muscle, nerve, &c., assuming all to be cut in the proper direction and the parts judiciously chosen, will represent the whole of the structure, or nearly so.

The thickness of sections is very important, hence the microtome chosen should enable us to form at least an approximate idea of the thickness of the sections we are cutting. The thickness of sections is conveniently reckoned in $1/25,000$ of an inch, which is written by microscopists by the sign μ , an abbreviation standing for micro-millimetre. Thus when we speak of a section ten times the thickness of a micro-millimetre, or $1/2500$ of an inch, we either say shortly 10μ , or we put it in the decimal fraction of a millimetre and call it $\cdot 01$ mm., *i.e.* the $1/100$ of a millimetre.

A table of thicknesses should be suspended near the microtome, something like this:—

3μ	=	$1/8000$	inch.
5μ	=	$1/5000$	„
10μ	=	$1/2500$	„
15μ	=	$1/1600$	„
20μ	=	$1/1200$	„
25μ	=	$1/1000$	„
30μ	=	$1/800$	„
50μ	=	$1/500$	„

This table, though inaccurate, is practically a good one, and by avoiding the amount of hundreds and tens does not unduly distract the already occupied attention.

Can a section be too thin? To this question one can unhesitatingly answer, Yes. For instance, a section to show the injected blood-vessels must contain these

vessels or some of them whole and their branchings also : the liver should be cut as deep as one of its cells : the kidney as deep as any *one* of its tubules ; and the same may be said of a few other tissues, but not all.

In making sections of tissues hardened, and therefore contracted, by reagents, one cannot be guided by the size of the constituents of the tissue whilst in the fresh state ; thus an hepatic cell, according to Quain, is about the $1/1000$ of an inch in diameter ; but the section of a liver hardened in bichromate of potash and cut in any way whatever into sections the $1/1000$ of an inch thick would show liver structure certainly but the cells could not be properly seen. Besides the contraction caused by the hardening processes we must also take account of the further contraction by our embedding agents ; thus, a thoroughly hardened piece of liver after infiltration by paraffin will not be much more than half the bulk it was before being bathed, perhaps two-thirds very nearly represents the size. Compression, however, is not to be confounded with distortion : the almost perfect equality of pressure on all areas of a tissue exerted by paraffin causes no distortion. The same may be said of celloidin.

All tissues cut by the knife held by the free hand in carrot, celloidin, and by freezing, should be cut as thin as it is possible to cut them because by none of these methods can a section be made too thin. A little practice will enable the student to cut sections in carrot the $1/600$ of an inch, and a little thinner in celloidin. By freezing and having the knife or plane iron in the best condition sections $1/800$ or perhaps $1/1000$ of an inch may be cut. The same knife or plane iron however will

cut sections 5μ and 3μ with ease when the tissue is infiltrated with a good paraffin, because, as I have pointed out, every cell and every fibre is surrounded and tightly inclosed by the paraffin.

K 1.—Cutting in Carrot. In order to cut tissues in carrot the carrot itself must be peripherally embedded. If the upper part of the carrot be not tightly surrounded by the well of a microtome, or other contrivance, the tissue will not be held with sufficient firmness. A Stirling's microtome answers best for this purpose. The top should be of brass and sufficiently broad. If a glass top be used the spirit dissolves the cement the top is stuck on with.

Place the carrot with its contents in the well of the microtome in such a way that the half of the carrot holding the tissue is nearest the operator, then the chink in the carrot will point right and left as the operator sits. A large soup-plate of spirit, spirit that is dirty or has been used will do, should be placed on the table in front but a little to the left of the operator, and a saucer of clean spirit on his right. Before every cut the knife is dipped into the spirit in the soup-plate once or twice, and as much of the spirit ladled on to the top of the microtome as will completely flood it. The knife is then laid on the top of the microtome, being lightly held in the right hand, whilst the index-finger of the left is laid lightly on the back of the knife to keep it in contact with the top of the microtome. A to-and-fro movement is then commenced, slowly advancing the edge of the knife towards and through the carrot and tissue. The half of the carrot furthest away from the

operator must be cut through occasionally so as to keep it from getting too high. At other times when the section is completed the bit of loose carrot is picked off it with the index-finger held on the knife, before the section lying on the knife is conveyed to the saucer of spirit.

The knife must be repeatedly stropped, after every few sections in fact. The knife chosen should be one made for the purpose : no other knife will do.

An old pail placed under the microtome is a necessity to catch the spirit. An apron upon the operator is not out of place.

The advantages of cutting by this method are its comparative cheapness; the immediate and direct manner in which a section of a tissue can be got, the tissue being hardened and lying in spirit; and the absence of disintegrating forces. Its one disadvantage, a fatal one too, is that proper thinness is an impossibility. For injected tissues there is no better method: also where we wish extensive sections to show general structure there can be no better method. The staining and clearing of sections cut in this way are conducted away from the slip; therefore the slip and cover are perfectly clean when the mounting has taken place.

Tissues peripherally embedded and requiring the use of spirit during the cutting process whether they are embedded in carrot or in any other way are cut much in the same way as that above described: so are sections embedded in celloidin.

K 2.—Cutting in Wax and Oil. Tissues are cut in wax and oil exactly as if cut in carrot as already

described. If a mixture of paraffin and vaseline is used it makes no difference.

K 3.—Cutting in Paraffin. When tissues are bathed in paraffin before being embedded in it, the knife-edge is moved directly through the tissue, that is it moves in a direction perpendicular to itself. For this reason a plane iron may be used where the cutting instrument is held in the hand and not fixed in any frame.

Small metal cylinders are supplied with microtomes intended for cutting sections of tissues bathed in paraffin. These cylinders are to be filled to overflowing with a good hard paraffin and kept so throughout. When the tissue has been embedded in paraffin, after being bathed in it the paraffin block is pared into the form of a cube having its opposite sides quite parallel. The end holding the tissue we will call the top, the end opposite the top we will call the base, and the remaining planes the sides. Then the paraffin should be, as before described, pared away on a level with the surface of the tissue from which sections have to be taken; but about a quarter of an inch of paraffin should be left between the bottom of the tissue and plane forming the base (see Fig. 41).

When sections have to be cut, the block with the name scratched on it is taken from the box or bottle; a flat-bladed knife is warmed in the flame of a spirit-lamp, or air-gas burner, and applied to the paraffin of the cylinder (which should rest on a level table); then the base of the block is placed on the warm knife and the latter instantly withdrawn. This leaves the block and the paraffin of the cylinder in one piece. The cylinder

and block is placed under the cold-water tap and wiped dry. This process occupies about half a minute or little more.

When ribbons of sections are required, as much paraffin as possible must be pared away from the two sides of the block which will form perpendiculars to the edge of the knife and very little paraffin should be left to form the remaining sides; but these must be strictly parallel. If it be cold weather, perhaps when all this paring has taken place the block must be dipped in a paraffin of low melting-point, and after cooling under the tap again pared. This is frequently requisite because hard paraffin will not ribbon in cold weather; the requisite adhesiveness being deficient, so that a final thin coating of a low melting-point paraffin is required to coat the two sides involved in ribboning.

When the knife has a mechanical movement, and in warm weather anyway, it is just as well that ribbons of sections are advantageous, because we can scarcely avoid the edges of the sections adhering and ribbons forming; therefore the student has no occasion to be afraid of not being able to ribbon.

K 4.—**Cutting in Frozen Gum.** The direction of the knife-edge in cutting sections by the freezing method is of little consequence; but if a razor is used it must have a stout blade, not be hollow-ground, and it will have to travel obliquely, otherwise the edge will dip into the frozen mass and scoop out a mass of tissue.

The pieces of tissue are placed upon the freezing plate and surrounded by fresh gum mucilage so as to give support to the tissue whilst the knife is acting.

When a heap of sections has formed upon the blade of the cutting tool the latter is dipped into tepid water in a soup-plate or a saucer, and the heap swells and disintegrates almost at once, the sections separating as they float away. It is always well to smear a little of the gum or gum and syrup upon the part of the knife the sections accumulate upon. Any number of tissues may be cut on the same day if the sections are poured, water and all, through a funnel into a suitable bottle such as that shown by Fig. 38, and after repeated changing of the water to get away the gum and syrup 95 per cent. alcohol is poured into each bottle. The sections will keep any length of time in this way, and can be stained and mounted as required.

K 5.—To transfer a Section from a Fluid to a Slip. To float the section in a deep enough vessel of water, or spirit, so that the slip can be placed beneath it, is a moderately good way and recommended by very practical authors. The following, I think, is a much better way. Suppose the section to be in a watch-glass filled or half filled with water, or spirit: dip the end of the slip into the fluid, lave the fluid upon the lower third of the slip with a camel-hair brush, then with the brush under it lift the section upon the very bottom of the surface of the slip: lave the fluid a little higher up the slip: then move the section up the freshly laved portion, and so forth, until the centre of the slip is reached. By the time the section reaches the centre of the slip it will be perfectly spread out. Two or three trials of this method, however thin and large the section, will convince the operator of the

superiority of this over the first-named proceeding. The slip must be held as horizontal as possible: it may be held quite horizontally when once the section is wholly on the lower end of the slip. More exact centering, if required, is carried on under water or spirit held by the slip, whilst the latter is on the centering block. Finally, after brushing away the fluid and seeing that the section touches the surface of the slip (is not floating), tilt the slip on end to drain. It should be reared against something, and the lower end should rest on bibulous paper.

K 6.—**The Microtome.** When the student's means will not permit him to buy the great microtome of the day, Thoma's, with its perfect mechanical knife-movement, he had better choose one that is adapted for ether freezing and cutting in paraffin ribbons of sections. One of the following instruments will suit his purpose.

K 7.—**Stirling's Well Microtome**, adapted for freezing and cutting in paraffin, carrot, wax and oil, paraffin and vaseline, celloidin. This is shown by Fig. 42. It has been made at my suggestion by Messrs. Ross and Co., New Bond Street. The threads of the screw are seventy-two to the inch, and the milled head has thirty-six divisions. This gives the classical $\cdot 01$ mm. or 10μ for each division of the milled head.

K 8.—**Cathcart's Ether-Freezing Microtome** is now being made at my suggestion by Mr. C. Baker for cutting ribbons of sections in paraffin as well as ether freezing. Its cost is only half the first-named instrument; indeed it is almost as cheap as any microtome in the market. The screw has fifty threads to the inch,

and the milled head has fifty divisions, thus allowing for the cutting of 10μ sections.

With either instrument a plane iron is used as the cutting tool. It is quite an easy matter to make 5μ sections of tissues embedded after being bathed in paraffin. Half a division has to be guessed upon the screw head with either of these microtomes when 5μ sections are needed.

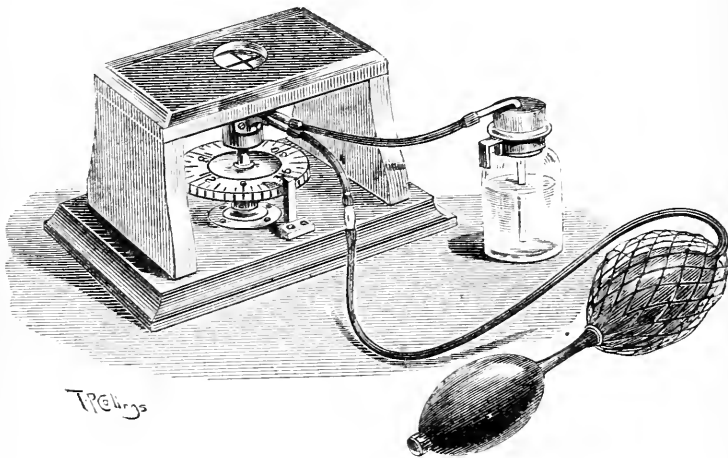

FIG. 42.—Author's pattern of Zeiss's microtome.

K 9.—Grove-Williams' Microtome. The top of the original Williams' ice microtome has, also at my suggestion, had the German nozzles of Cathcart's ether freezer attached to it, and is used with Swift's knife and knife-carrier, now so well known. This microtome is made by several makers, and should be chosen by those who like this form of mechanical knife-movement. Sections are cut in either of the two ways recommended;

but their thickness cannot be measured, which is a drawback.

K 10.—Williams' Freezing Microtome. This is more suitable for a class. The machine has to be filled with a mixture of equal parts of powdered ice and bay-salt before it can be used for freezing, and is therefore not so suitable for cutting frozen sections at a moment's notice as the ether freezer. It is used with Swift's knife and its carrier, and will cut paraffin-embedded tissues as well as the other instruments.

If the student uses this microtome he should put thirty or forty tissues requiring freezing and cutting into the gum and syrup over night; then next day, after filling his machine with ice and salt, take as many bottles (like Fig. 38) as he has tissues, and place the knife with its load of sections in a saucer of water and pour the sections through a funnel into each of the bottles. The water in each bottle is to be frequently poured off and fresh substituted until all gum and syrup is removed, then 95 per cent. alcohol is substituted for the water of each bottle. The sections will keep for years this way. Each bottle should of course be labelled. The sections as required are stained and mounted at any time. Care is to be taken to have an exact bottleful of water in the saucer each time, otherwise in pouring through the funnel, which is done rapidly, there will be an overflow and a waste of sections.

K 11.—Roy's Improved Microtome. I here give an illustration of this microtome as made by the Cambridge Scientific Instrument Company. Roy's old pattern is a great favourite in Germany, where it is known

as Schanze's microtome. This new pattern cuts admirably both by ether freezing and embedded objects.

K 12.—**The Rocking Microtome.** This beautiful instrument is made by the Cambridge Scientific Instrument Company, who give full directions for use with each instrument. For those who can afford two micro-

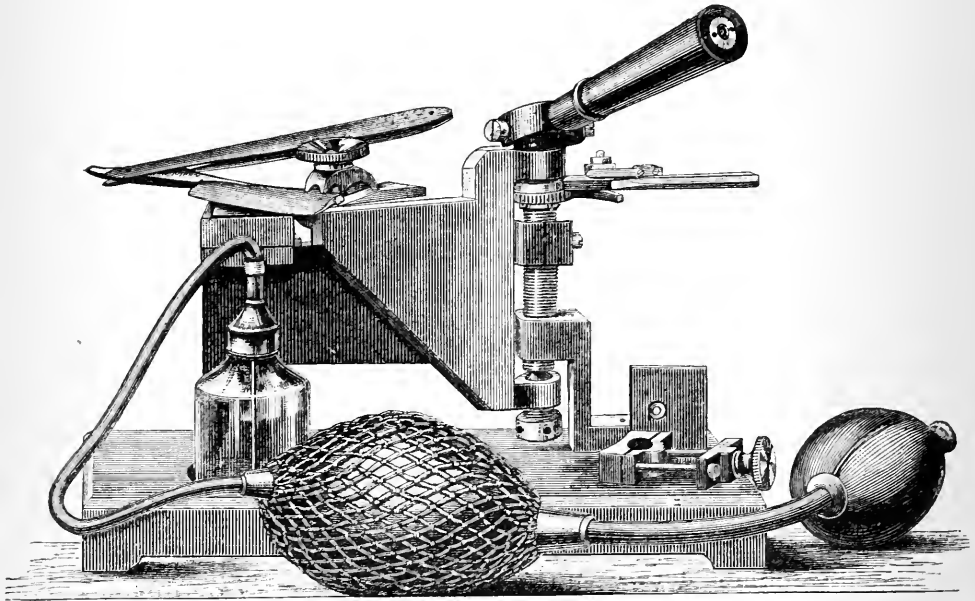

FIG. 43.—Roy's improved microtome.

tomes—namely, the Rocking for cutting paraffin ribbons of sections and the Cathcart for cutting frozen tissues—I advise them to have this combination for two reasons: the Rocking is the most simple and easily managed of any ribbon-cutter, and the ribbons fall into position on the slip, or are easily transferred; secondly, it is far better for the student who wishes to go through a course of

embryology to use the instrument he will almost of necessity have to use when he commences this study.

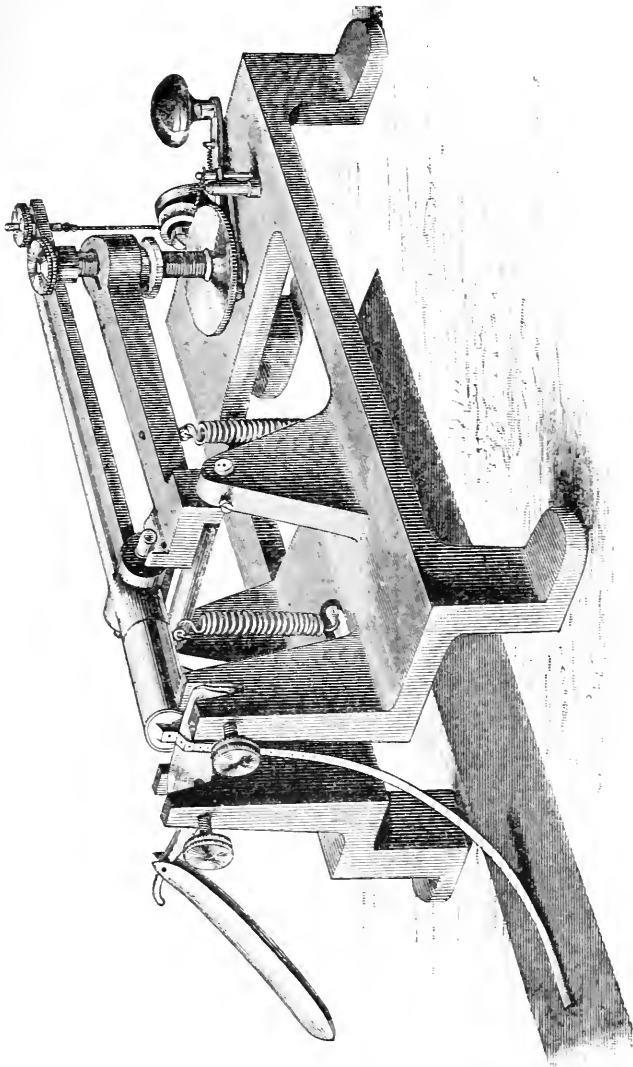

FIG. 44.—The Rocking microtome.

He will thus find his embryological work easy and familiar at the very commencement.

K 13.—**Thoma's Microtome.** This microtome is allowed on all hands to be the most perfect instrument of the day. If the student can afford to purchase it I advise him to get the middle size called 2B in the maker's catalogue. The 2B has ivory let into the iron block which carries the knife. This iron block thus

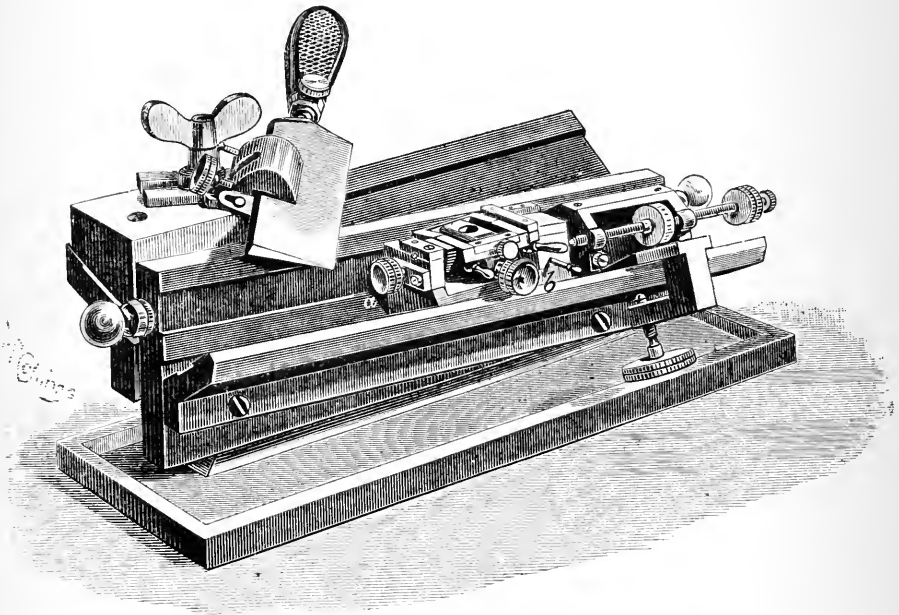

FIG. 45.—Thoma's microtome.

slides easily in the oiled level path. The micrometer-screw, although the instrument is supplied without it, is a necessity really. The knife-holder is the latest contrivance of the Naples Biological Station, and is really excellent.

Should the student purchase this instrument he will

then cut paraffin ribbons for sections of small area and exquisite thinness, such as 5μ and 3μ , but embedded in celloidin, when he requires sections of large area and sections of tissues that have been injected with carmine gelatine.

The instrument has a startlingly bright look suggestive of rust, and should have vaseline smeared over all its bright parts the very day it enters the laboratory. Except wiping dry and placing vaseline upon the knife each time after use there is no cleaning required, even when spirit is used for wetting the knife-blade and the surface of the tissue, if we are careful to adopt the following plan. Get two short flat-bottomed test-tubes (like Fig. 30) and half fill each with common alcohol. Use one of these for wetting the knife and tissue and the other to receive the sections when cut. The former should be held in the left hand close over the knife and tissue whilst the spirit is taken from it with a small camel-hair brush. In practice the test-tube is retained in the left hand and the brush between the lips whilst the micrometer-screw is turned, either by the left hand or the right, the right hand always being used for pulling and pushing the knife-block. The spirit as seldom drops upon the bright parts of the microtome when used in this way as ink falls from the pen upon the paper in the case of the skilled penman.

Thoma's microtome is made by R. Jung, Mekaniker, Heidelberg, and may be obtained through his agent, Mr. C. Baker.

L.—STAINING.

L 1.—**General Remarks on Staining.** Keep all staining solutions in the drop reagent bottles represented by Fig. 29. Cover those bottles which contain the gold, silver, and osmic acid all over with black paper to exclude all light.

The distilled water used for mixing must be of the purest possible quality, trebly distilled.

Where possible stain in a dilute or weak stain for a long time such as twelve hours—then the staining is selective—rather than in a stronger stain which only takes a few minutes (three to thirty) and which is more diffuse.

In making a weak stain pour the diluent into a clean test-tube, then drop the strong stain into it holding it before a window to ascertain the depth of colour, which should never be deep.

Pour the weak stain into a clean watch-glass ; place the tissue in it and set the whole in a moist chamber for the required time.

Sections should never be allowed to lie one upon another during staining.

Never stain any section very deeply except in those cases where aniline dyes are used, which dissolve freely in alcohol. In these cases, where the tissues have to be passed through alcohol for dehydration, the superfluous colour is washed out.

If a carmine or logwood stained tissue be overstained the excess of stain is removed by placing it in a watch-glass of carmine brightening fluid until the excess of stain is removed. A few seconds, up to two or three minutes, are required, during which it should be watched, moved about with a camel-hair brush, and removed the instant decoloration has gone far enough.

Tissues or sections should be clear of acids before being placed in stains. When acids are suspected of being present the tissue or section should be placed for twelve hours in a 5 per cent. solution of carbonate of soda in 75 per cent. alcohol; the soda again being removed by soaking in changes of the alcohol for another twelve hours.

L 2.—Ehrlich's Hæmatoxylin. Dissolve 1 gramme of hæmatoxylin crystals in 100 c.c. of absolute alcohol, then add to this 100 c.c. each of glycerine and distilled water. Saturate with alum with crystals over; then add 0.5 c.c. of acetic acid. Allow this to stand until its greatest depth of colour is attained, about six weeks, giving it an occasional shake during the time. Then filter it. It will never require to be filtered afterwards.

L 3.—Mitchell's Logwood. The following is Mr. Cole, Jun.'s, way of making this delightful stain:—

Moisten with water 16 grammes of well-ground logwood chips, then place them in a bag and run tap-water through them until the water comes through almost colourless. Now spread the chips on a tea-tray and place in the sun and air until quite dry. Take 9 grammes of potash alum and dissolve it in 96 c.c. of distilled water,

and pour this upon the dried chips, contained in a suitable vessel, and allow the whole to remain, giving it an occasional stir, for forty-eight hours. Strain off and add 32 c.c. of glycerine; mix and filter. Before placing it in a well-stoppered bottle add 5 per cent. absolute alcohol to it to keep it.

Dr. Mitchell pointed out that by washing the tannin out of the chips to begin with, the flakey sediment usual to logwood stains could be avoided. He is quite right. I have been acquainted with this stain ever since the inventor published his views, and have never found the flakey sediment or any sediment at all appear. It is a beautiful, soft stain.

It will be seen that a windy sunshiny day must be chosen for the initial stage of its manufacture as it is best to avoid drying the chips by artificial heat.

L 4.—**Borax Carmine.**

Take of

Carmine	3 grammes.
Borax	4 „
Water, distilled . . .	97 „

Mix, and apply heat with constant stirring until steam rises, then add when cold—

Spt. Vini Rect.	70 c.c.
Water, distilled	30 c.c.

Shake it up, then let it stand for thirty-six hours: then filter (Foster and Balfour).

L 5.—**Carmine Brightening Fluid.**

Take of

Hydrochloric Acid (1 per cent. in
distilled water) 1 part.
Spt. Vini Rect. 2 parts.

Mix. Tissues stained in bulk or in sections with carmine, are brightened and any diffuse staining removed by being placed in this fluid.

L 6.—**Picro-carmine Solution.** Make a saturated solution of picric acid in 100 c.c. of distilled water. Add to this 1 gramme of carmine that has been dissolved in a mortar by the addition of 3 c.c. of strong solution of ammonia (Liq. Ammon. Fort.). Allow this mixture to stand for a week, giving it an occasional shake; then evaporate it in a wide shallow evaporating dish, over an air-gas burner to one-fourth its volume; filter this remainder and then evaporate to perfect dryness. The powder remaining is the picro-carminate of ammonia, briefly called picro-carmine.

Place the powder in a bottle, and make a 2 per cent. solution of some of it for use.

L 7.—**Gold Chloride Solution.** Make a 1 per cent. solution in distilled water and keep in a well-closed bottle covered from cork to bottom, over the bottom in fact, with black paper. This black paper can be bought at stationers' gummed on one side. Every place where light can enter is to be made light-tight.

L 8.—**Silver Nitrate Solution.** Make a 1 per

cent. solution in distilled water in a dark room, and place in a bottle surrounded by black paper as in the case of gold solution. This 1 per cent. solution can be diluted as required.

L 9.—**Osmic Acid Solution.** Make a 1 per cent. solution as in the two previous stains, and rigidly exclude light.

This is an exceedingly active poison. It is better to buy the solution ready made.

L 10.—**Eosin.** Fischer, who first introduced this stain, regarded it as a tetrabromide of fluorescein. Although soluble in water and alcohol it is best to separate the colouring-matter from it by precipitation with HCl.

Make a strong watery solution of eosin, then add dilute HCl to it drop by drop until all the colouring-matter is thrown down. Collect the precipitate and wash it, as it lies on a filter-paper in a funnel, with distilled water. Until all the acid is washed out of it the precipitate is not dissolved by the water. The moment the water is coloured by it stop: place the nozzle of the funnel in the neck of a well-stoppered clean bottle, and substitute absolute alcohol for the distilled water. We thus get a solution of the colouring-matter of eosin in absolute alcohol (Purser).

L 11.—**To stain in Ehrlich's Hæmatoxylin.** If possible, that is if time permits, drop the stain into distilled water. It needs no filtering. Place the sections in the dilute stain in a wide shallow vessel such as a watch-glass for twelve hours and set it in a moist chamber. By surrounding a section with a diluted stain

only those parts, like the nuclei, which have strong elective affinities for the stain absorb it.

If the undiluted stain be used care must be taken to prevent overstaining.

Sections stained in Ehrlich must be washed with tap-water, not with distilled water.

L 12.—**To stain in Mitchell's Logwood.** This is a very excellent stain but more diffuse than Ehrlich's. Where a diffuse stain is needed Mitchell's is unequalled. It may be used much in the same way as the other.

If possible mount logwood-stained sections in balsam, not in glycerine or any medium having glycerine in it. Ehrlich's is said to keep well in glycerine mounts, because it is made with glycerine! After admiring the logic one can ask how long Ehrlich's hæmatoxylin has been known at all.

L 13.—**To stain in Borax Carmine.** Pieces of tissue it is intended to stain in bulk before cutting into sections are better stained in borax carmine than in almost anything else. They should not be larger than 1 cm. cubes, and should not remain in the stain less than a week if possible.

Both sections and pieces that have been stained in borax carmine should be brightened by being placed in carmine brightening fluid.

Carmine is amongst the most durable of stains. It can be mounted in glycerine, glycerine jelly, Farrant, or balsam.

L 14.—**To stain in Picro-carmine.** Use a 2 per cent. solution and let the sections remain from half an hour to twelve or more hours according to convenience.

Wash rapidly in water (tap or distilled), then either mount in glycerine jelly, Farrant, or balsam. The Farrant is to be preferred. Sections mounted in this improve very much for a few days.

L 15.—**To stain in Eosin.** Eosin is used as a ground or contrast stain after staining in a selective stain such as logwood. It is only necessary to drop a very little of the alcoholic solution into the absolute alcohol one is using for dehydrating with. Sections may remain in this for any length of time, and may be cleared in either clove or cedar oil.

L 16.—**To stain in Gold Chloride.** There are several ways of using this stain, but two are amply sufficient for our purpose, namely those of Cohnheim and Ranvier.

1. *Cohnheim's Method.*—Place the fresh tissue from twenty to forty minutes in a 0·5 per cent. solution of chloride of gold; then wash well with water and transfer to a saucer of distilled water that has had two or three minims of acetic acid dropped into it, and let this stand near the window until the light reduces the gold, which it does in twenty-four hours or so. The great secret of success lies in washing off the gold solution in the most thorough manner.

This method is useful where no great penetration is required.

2. *Ranvier's Method.*—This method is like the last with this exception: the tissue is immersed in the fresh juice of a lemon for a few minutes and the juice washed off with water before being placed in the gold solution.

The method is used where more penetration is needed, but it cannot be used when an epithelial membrane is present if we wish to preserve the epithelium.

L 17.—**To stain with Silver.** This is done by simply pouring the silver solution (0·25 to 1 per cent.) upon the parts; allowing it to remain five or ten minutes: then washing away with distilled water all the solution not appropriated, and exposing the parts to light to reduce the silver. Again the washing away with water as in the case of gold staining is to be very thorough, otherwise the silver is reduced and lies in patches over parts that it has not stained.

L 18.—**Iodine Green.** Keep as a 0·2 per cent. solution in distilled water with one-fourth its bulk of absolute alcohol added. Alcohol removes the stain very little, so that the sections must not be overstained.

L 19.—**Methyl Aniline Green.** Keep as a 1 per cent. solution in 50 per cent. alcohol. Dehydrate rapidly in absolute, and clear in cedar-wood oil.

L 20.—**Spiller's Purple.** Keep as a 1 per cent. solution in 70 per cent. alcohol in which sections remain for a length of time, not less than twelve hours. Dehydrate in absolute and clear in cedar-wood oil.

L 21.—**Roseine (Magenta).** Keep the stain as a 1 per cent. solution in rectified spirit. Add this to distilled water as required. Schäfer recommends adding a drop to the oil of cloves during clearing where a roseine stain is required.

L 22.—**Safranin.** This is used to stain the intranuclear network of cells. Keep the stain as a saturated solution in absolute alcohol. When used add the

saturated alcoholic solution to an equal quantity of distilled water and let the sections or small pieces of tissue remain in it for twelve hours at least: then transfer to repeated changes of absolute which will abstract all loose stain but will leave the intra-nuclear network stained.

L 23.—**Aniline Blue-black.** Keep the stain as a 0·5 per cent. solution in 70 per cent. alcohol and use it in this solution, or use it as a 0·5 per cent. in distilled water. It is used for the brain and cord.

L 24.—**Staining Sections fixed on Slides.** Sections fixed on the slip after getting away the paraffin in the usual way by moving the slip to and fro in turpentine are easily stained thus. Instantly move the slip to and fro in 95 per cent. common alcohol to get rid of the turpentine: momentarily dip it in 75 per cent. common alcohol: then place a drop or two of the stain (which is dissolved in 75 per cent. alcohol) upon the section and place in the moist chamber until next day. With a wash-bottle containing 75 per cent. common alcohol impinge a stream upon the slip so as to wash away all the loose stain: wave the slip momentarily in the 75 per cent. to make sure of getting rid of any loose stain remaining: then dehydrate in 95 per cent. absolute alcohol for a few seconds, or more if thought necessary: clear in cedar oil for an hour: then mount in xylol balsam.

Except the waiting in the moist chamber this is really a very rapid process. We have two short wide-necked bottles full of 95 per cent. alcohol, one made with common; the other with absolute one wide-

necked bottle of 75 per cent. common alcohol and a similar bottle of turpentine. All can be in the same rack or stand. The wash-bottle of 75 per cent. common alcohol had better be one holding half a litre or so.

If it be a watery stain such as picro-carminé we wish to use, the slip can be dipped in *water* for half a minute *after* washing off the turpentine with the 95 per cent. common alcohol: then the watery stain is washed off with water, and progressive alcohols (75 per cent., 95 per cent.) used afterwards. The dehydration in the 95 per cent. will take two or three minutes: a little longer than in the case of the alcohol stains.

Sections that have gone through alcohols, paraffin, and turpentine do not absorb stains unless in contact with them for a prolonged period, at least twelve hours. Any minute between the twelfth and forty-eighth hour can be chosen for washing off the loose or unabsorbed stain and completing the mount. Turpentine does not dissolve the shell-lac by which the section is fixed on the slip: the 95 per cent. alcohol, especially that made with the absolute, will partially dissolve it if the slip be left in unduly long, for instance, half an hour, for the purpose of dehydrating. The cedar oil takes quite an hour to *clear* the 95 per cent. dehydrated sections; therefore, the slip with the cedar oil on it should be placed in the moist chamber for an hour.

Of course when a *watery* medium, such as Farrant, glycerine, glycerine jelly, &c., is used for mounting, the slip after washing away the loose stain is covered with the mounting medium without passing back through successive alcohols.

M.—DEHYDRATING AND CLEARING.

M 1.—Dehydrating. When sections or pieces of tissue have to be mounted in balsam all water must be abstracted from them. This is called dehydrating, and is usually done by placing them in methylated spirit of full strength for fifteen minutes, or in absolute alcohol for five minutes.

This operation can be performed on or off the slip: if off the slip the spirit is usually placed in a watch-glass and the sections placed in it; if on the slip a large drop or two of the alcohol is placed on the section after the slip has stood on end so that all water has drained away by gravity from the section which will have become sodden. Care is to be taken that the section does not become quite dry, otherwise it will be spoilt.

M 2.—Clearing. Sections after being dehydrated are to be rendered transparent. The process is called clearing. The clearing agents here recommended are clove oil, cedar-wood oil, and oil of turpentine. The objection to oil of cloves is very great: it becomes yellow with age and it abstracts the aniline dyes during the clearing of sections stained with them. The first objection is quite overcome by immersing the section that has been taken from the clove oil in oil of turpentine for a minute or two. This washes away the clove oil and gets rid of any dirt there may be, and the extra opacity imparted by the turpentine is removed by the

little solvent, xylol or benzol, in which the balsam is dissolved in a few hours or less.

Cedar-wood oil does not clear quite so much as clove oil, and it takes a few minutes more to clear. Thus a section that would be cleared in three minutes by clove would probably take ten to clear in cedar-wood oil. Cedar-wood oil is by far the best clearing agent for general purposes because it does not discolour with age, and it has no effect whatever on the aniline dyes.

Oil of turpentine should not be used as a clearing agent except in the case mentioned above, as it causes great shrinkage if a section be left in it beyond a very few minutes. When a Berlin-blue injection has been used, we may clear in turpentine and mount in balsam thinned by it: but why use a blue injection?

Sections are cleared by being placed in the clearing medium contained in a watch-glass, or on the slip by a drop being placed to the edge of the section and allowed to find its way under the section, which it perforates, and then appears on the surface.

Sometimes it is advisable to partially clear. When this is so the clearing process is watched under a low power, and stopped when it has gone far enough, by removing the oil.

To get rid of all clearing oil tilt the slip on end and allow it to stand against something with its lower end resting on bibulous paper. After this we may if we choose lay the slip down on the table and bring two folds of bibulous paper down upon the section twice, using the right hand to exert pressure exactly as if blotting a sheet of note-paper before turning over-leaf

N.—MOUNTING.

N 1.—**The Application of Cover-Glasses.** In all cases the cover-glass should be firmly seized with cover-glass forceps, and applied lever-fashion, the edge of the cover opposite the points of the forceps being made to come in contact with the slip first, then, with this contact as a fulcrum, the edge of the cover seized by the forceps being gradually lowered describes an arc of a circle, until the space between the slip and it is only the breadth of the intervening nib of the forceps. The student will save himself much time and trouble if he will study the physics of this seemingly simple procedure; otherwise he will from time to time have the mortification of seeing air-bubbles in his mounts, or see his sections ruthlessly floated about, and spoilt upon the slide either by disintegration, or overlapping of their parts. The law of capillarity, which will either be his obedient and useful servant, or his aggravating master, is thus stated:—The height to which a liquid rises in a cylindrical tube of a solid which it wets is inversely proportional to the diameter of the tube. That is the law, and let him, if he values his time, make himself thoroughly acquainted with it. This he can do in half an hour, thus:—Take three bright, clean slips: lay one on the table and flood it over with water. Then, placing the other two

together so that their end edges touch at one end only apply their lower edges to the slide with the water upon it, and watch the water rise. The water will be seen to form a curve highest in the narrowest part, and conversely. Now let him seize the approximated edges, so as to *keep* them approximated, whilst he opens and shuts, so to speak, the two slips, by approximating and separating the two movable ends. He will see the wave obeying the law of capillarity already described. He will further see the surface of the wave *when near its highest point*, inclosing air-bubbles. Now let him experiment with two slips only; namely, one upon the table with less water on it, and the other held in his right hand, and applied to the other, distal edge first, lowering it like a cover-glass. The wave, and its relative height, and so forth, is seen as before, and exactly as it really is when we apply a cover-glass. Now, if the wave be not *slowly driven along*, by applying the cover-glass, with firm, steady, slow lowering, and it cannot be in fluids thicker than water, by being simply lowered, as some authors recommend, the cover floats upon the fluid, and air is inclosed along the *whole* breadth of the under surface of the cover; whereas air is only inclosed in the wave we form when at or near its greatest height, and therefore when the cover-glass is nearly horizontal or down. Air-bubbles are expelled with the completion of the laying-down process in the latter case; therefore if air-bubbles are inclosed it is either because the cover was too rapidly lowered, or was not clean, or air was already in the tissue or

the mounting fluid, or we have not previously wetted the cover, as in mounting in glycerine, with distilled water. We have other and very aggravating things done by this wave, which we have seen may be made a useful servant. If the tissue or section be *suspended* in the mounting fluid, instead of lying upon and touching the slip, it will be washed or floated on with the wave, and escape from under the cover-glass altogether, and either doubled up and creased, or disintegrated, according to its constitution. Again, the tissue or section may be lying flat upon the slip, and yet be driven on by the wave. In this case the mounting fluid gets *under*, and lifts up the edge of the tissue or section which it first encounters. This again is our fault, for allowing the edge of the cover which first comes in contact with the slip to make too acute an angle at first with the slip. In such a case the strong capillarity and rapid up-lift of the wave exerts a power which carries the nearest edge of the section upwards, and therefore the entire section is undermined and buoyed up into the wave and away from the surface of the slip.

Half an hour spent in experimenting as I have described, and mastering the very simple phenomena of the *rising* and *progressing* wave caused by the gradual firm lowering of the cover-glass, will save the student many a delicate section, and prevent many unnecessary trials of temper.

N 2.—To mount in Farrant's Medium. Mounting in this medium is, or rather was, more difficult on account of the difficulty of excluding

air-bubbles, than mounting in pure glycerine itself. Lately, however, Mr. Cole, Jun., has discovered a way of avoiding air-bubbles. He takes a wide-mouthed bottle, half full of the medium, and a clean glass funnel with cotton-wool in the bottom; then pours the medium into the funnel. The first drops which filter through contain air; all drops afterwards are free from air-bubbles. He lets fall a drop or two upon a clean, warmed slip; inserts the tissue, taken from freshly distilled, or freshly boiled water, into the medium, then lowers a clean, dry cover, after passing it through a clean flame.

Of course in mounting a series of things one after another the medium has to be poured again and again into the funnel, although the drops come very slowly.

N 3.—To mount in Glycerine Jelly. Put some jelly in a very small wide-mouthed bottle, and place this in a small quantity of water over the flame of a spirit-lamp, or air-gas burner, until the jelly is just melted. The melted jelly is to be removed to the warmed slip in a large quantity, three or four drops, by dipping a piece of feeding-bottle glass tubing into it and placing the top of the index-finger tightly over the top end of the tube. The slip is made hot in the same flame that is keeping the jelly liquid, and the jelly is transferred to it, and the section or tissue placed in the jelly, then a cover-glass, rapidly passed through the flame, is lowered upon it.

N 4.—To mount in Glycerine and in Watery Media. Mounting in glycerine, or in glycerine containing 1 per cent. of formic acid, is frequently recom-

mended by high authorities. I here give directions which will be found as efficient as any, perhaps. First of all, *never attempt to mount in glycerine without using a cell*. He who determines to mount in glycerine should keep ready for use plenty of slips with gold-size ring-cells on them.

Place the tissue in good distilled water, or water that has had all air expelled by recent boiling: take a slip with a hard ring-cell of gold-size upon it and ring it with a very little fresh gold-size: place a large drop of glycerine in the cell and put the section out of the airless water into it and spread it out, or arrange it; then take a very clean, bright cover, and after dipping it in the distilled water put it in place, taking care to make it adhere to the cell all round. The oozed glycerine can be washed off with water blown from a wash-bottle, the slip dried and rung first with gold-size and lastly with Cole's white zinc cement. Care should be taken to select covers as wide as the widest part of the gold-size cell.

Mounting in watery media is performed in the same way.

N 5.—To Mount in Balsam by Cole's Exposure Method. Some twenty years ago Mr. Cole, Sen., discovered the following very beautiful method of mounting in balsam. It consists in placing the dissolved balsam on a cover-glass, then placing the section in this layer of balsam and allowing all the balsam solvent to evaporate, and finally turning the cover-glass over upon a clean, warmed slip.

The process is carried out thus:—Take as many clean

cover-glasses as we have sections to mount and place them (two, three, or four) on a slip, making each adhere to the slip by breathing upon it. Next spread dissolved balsam on each cover-glass, leaving a sufficiently wide peripheral border dry for the forceps to grasp. When every cover has thus been treated, place the sections upon them: place each slip with its load of cover-glasses between shelves out of the way of dust for three or four up to twenty-four hours, according to the operator's convenience, then take as many clean slips as we have loaded covers, warm the slips and turn over the covers upon them. A small drop of dissolved balsam is placed on the rim of the cover at the opposite pole to that seized by the forceps, immediately before the cover is turned over on to the warm slip. The operator will soon find the necessity of this.

By this method slips with their mounts can be cleaned with spirit without fear of disarranging the cover-glass within a few hours of the time the covers are turned over.

Cover-glasses in balsam mounts that have been put up by the ordinary immediate method not unfrequently remain treacherously mobile for weeks and months unless some balsam that has oozed beyond the edge of the cover has been allowed to remain and harden, when the otherwise loose cover will be wedged in by a hard rim of dry balsam.

N 6.—To clean Mounted Slides. If balsam be the medium used, and the cover-glass is firm, place the slides in a soup-plate or saucer and pour methylated spirit over them: then in a few minutes take them out

one at a time and rub them with a rag dipped in the spirit : afterwards with dry chamois leather.

If Farrant's medium have been used, cleaning may take place the day after mounting by dipping the slip in cold water and lightly brushing away with a camel-hair brush all oozed medium, then polishing with dry chamois leather.

If glycerine jelly have been used, in a few minutes the cleaning may take place by holding the slide by its two ends in the left hand and scraping a flat-bladed knife along the surface towards the cover-glass, whose edge the knife should touch each stroke.

Mounts with Farrant, glycerine jelly, glycerine, and watery media must always be ringed with a good cement. Balsam mounts never require this precaution, but are no worse for it.

O.—PRACTICAL EXERCISES.

The following exercises ought to be gone through before attempting to prepare the tissues.

Exercise I.—Take a hundred new slips and clean them if required. Set them up on their edges, and be careful in handling them to grasp them only by their edges.

Take a camel-hair brush and some gold-size, and with a turn-table ring *every* slip, making the rings the size

of the round covers used, a few of each. Place each out of the way of dust.

Clean a hundred cover-glasses and place them in a watch-glass cell. They must not be handled except by the cover-glass forceps after being cleaned.

Take fifty of the ringed slips, the turn-table, the gold-size, and the camel-hair brush and refresh the rings with gold size in sets of sixes. Take each slip so heated, place it on the centering block, and place a suitably sized cover-glass upon the refreshed ring, as in mounting in glycerine and watery media.

Take the remaining fifty and treat them in sets of sixes as before; but place a drop of glycerine in the ringed cell before putting on the cover-glass. When all are gone through, put each slip under the cold-water tap, or direct a stream of water from a wash-bottle upon it, to wash away all oozed glycerine, drying each slip with a soft cloth.

Take the first set of fifty slips and ring them *all* with white zinc cement. After all are finished, begin and ring them with asphalt. The white zinc cement must be placed upon the periphery of the cover, extending slightly on to the slip on the one hand, and very slightly over the rim of the cover on the other. In other words, the ring must be broad. The asphalt ring, on the other hand, is to be narrow, and quite upon the white zinc ring.

Take the second set of fifty slips—those with glycerine under the covers—and ring them all with gold-size; then ring with white zinc cement, and lastly with asphalt, like the other set. The primary ringing with

gold size prevents the glycerine from leaking. Glycerine jelly is used by some for this purpose, so is liquid French glue, the latter being the best of all, though gold-size is quite reliable.

Finally, place the hundred slips in a soup-tureen filled with a strong solution of Hudson's extract of soap in water, and let them remain.

Exercise II.—Take a bundle of glass tubing such as is used for babies' feeding-bottles.

1. Cut with a three-cornered file one tube into twenty or thirty pieces.

2. Take another tube and bend it at *several* places and at different angles by means of an air-gas burner or a spirit-lamp; the former is best.

3. Take another tube and draw it out into capillary tubes such as are used in vaccination. This is extremely simple; the tube being drawn out *quickly* whilst either in the flame when soft or just outside the flame. Make a bundle of capillary tubes and put them away.

4. Take other tubes and draw them out into pipettes of various sizes. The tube must be removed from the flame before the drawing apart of the two hands takes place. It will be noticed that unless the pull given be *strong* and take place *immediately* the glass is out of the flame, and unless the glass be well *softened* the tube cannot be drawn. Make a large quantity of pipettes of various sizes cutting them into proper lengths with a three-cornered file and rounding off their sharp edges in the flame. Preserve the pipettes.

5. Make several Y-shaped pieces of tubing and select some of the more perfect for preservation.

6. Purchase four rats and place them in a cage which the vendor will lend. If not a simple cage is readily made, or may be bought for about a shilling. If possible rats should be kept in the laboratory always, or in any suitable dry place. They only require to have a piece of loaf given to them once a day: the piece being about one-third the size of themselves. It should be put under the water-tap and about half soaked through with water before being dropped into the cage. No water or milk or any other fluid must be given, and the cage is to be kept as dry as possible, otherwise the fur of the rats will stand on end and they will not thrive or feel well.

Exercise III.—1. Catch a rat; anæsthetise it; pin it out on cork, then open the thorax and insert and tie a cannula into the aorta, *viâ* the ventricle, exactly as if about to inject the blood-vessels with carmine-gelatine, taking quite as much care and using the same materials (filoselle, &c.).

2. Remove the cannula; open the abdomen along the middle line; snip off the fundus of the gall-bladder and tie a cannula in it. After this ligature the common bile-duct. These steps are those taken in injecting the bile-ducts.

3. Get a bowl of water and take away the parts of the animal as in H 1. Get out the brain and cord carefully. Lastly get another bowl of water and cut away parts of the organs in the bowl as exactly and with as much care as if about to preserve them permanently.

4. Take the kidneys and boil them for two hours, or two hours and a half if they are large. Bury the remainder of the organs.

5. Cut both kidneys across their long axis into pieces a centimetre thick or rather less, and place in 75 per cent. alcohol for twenty-four hours.

Exercise IV.—1. Make a siphon bottle of a Winchester quart and place it on a shelf two or three feet above the operating-table. Tie in a stop-cock, like that used for injecting, at the end of the india-rubber tubing. With suction get the water into the tube so that when the tap of the stop-cock is turned the water will flow.

2. Catch and anæsthetise a rat; pin it out on cork; open the thorax and tie a cannula into the aorta as in last exercise. Fill the cannula with water, using a suitable pipette. This is to displace all air. Now give a half turn to the stop-cock from the siphon bottle so that the water escapes in large drops or more, then make connection and turn on the water by quite opening the stop-cock. Snip the right ventricle when it is distended and allow the water to run freely through the systemic vessels. If the water does not run, most probably there has been a blood-clot left in the cannula, or the air has not been entirely displaced by the water before making connection.

3. Turn off the water at the stop-cock; disconnect; take out the cannula; open the abdomen and tie a cannula into the gall-bladder, then place a ligature around the common bile-duct, but only give it one turn of a knot and leave this slack. Make connection with the siphon as before; then tighten the ligature.

4. Lastly, carry out the No. 3 of last exercise very carefully and thoroughly, and bury all the parts at the finish. This may seem wasteful, but there is no part

of manipulative histology requiring more tact than cutting up or taking away suitable pieces of organs for future treatment.

5. Take the kidneys in 75 per cent. alcohol and place them in 95 per cent. alcohol.

Exercise V.—1. Take another rat, and go through every step of Exercise IV., trying to do everything neatly, efficiently, and making as little mess of the hands, table, &c., as possible.

2. Take the kidneys from the 95 per cent.; place them in several changes of tap-water for half an hour, then place them in the gum and syrup until next day.

3. Clean the slips and covers placed in the Hudson's Extract solution, and put them away ready for future use.

Exercise VI.—Take one kidney, and cut it up into two or three hundred good sections, with an ice or an ether freezing microtome. Place the sections in a short wide-mouthed bottle, thus:—Take a saucer; measure a bottleful of water, and pour the water into the saucer; cut the sections; put them in the saucer of water; take a funnel and pour the sections boldly out of the saucer into the bottle. The reason for measuring the water is to have no overflowing of the bottle, and consequent escape of sections. Pour off the water and renew it several times at intervals so as to get away all gum and syrup; then place weaker, then stronger alcohols on the sections until 95 per cent. is reached. Lastly, put them away until wanted.

Exercise VII.—1. Take a saucer of water, a

camel-hair brush, and some slips. Remove twenty or more sections one by one from the bottle and place each in the water.

2. Take a slip, a watch-glass, and a camel-hair brush. Fill the watch-glass with water; transfer a section from the saucer to the watch-glass with the brush, then practise transferring the section from the watch-glass to the centre of the slip. A thick section should first be chosen, then a thin one, then a very thin one. The section each time should be noticed as to its position on the slip, and its position verified by placing the slip on the centering block. Repeat the transference as often as is necessary for a perfect mastery of the operation, as it is very important.

3. Melt some glycerine jelly by placing an ounce bottle of it with a wide mouth in a beaker containing water. The beaker and contents are to be placed on an iron rest over a spirit-lamp, or air-gas burner. Take care to avoid making the jelly too hot. Get a piece of pipette tubing about six inches long, and smoothed but not contracted ends, and clean it and put it in the jelly. Take more sections from the bottle and put them into the saucer; there ought to be about fifty in all. Now take fifty clean slips and round cover-glasses and mount fifty sections in glycerine jelly thus:—Place the mounting block and a clean slip on the table very near each other and for each mount: (*a*) clean a cover and put it on the edge of the cleaned slip slightly hanging over; (*b*) place a clean slip in the flame of a spirit-lamp for ten or fifteen seconds, then put it on the mounting block; (*c*) get out some jelly with the

glass tubing, by blocking up the upper end with the index-finger, whilst the lower is immersed half an inch in the jelly, and quickly transfer the jelly to the centre of the slip, slightly allowing a spreading movement; (*d*) with a section-lifter and a needle fixed in a handle get out a section from the saucer, and *slide it* into the jelly on the slip *edge first*, so as to carry no air-bubbles; (*e*) lastly, quickly grasp the cleaned cover with the cover-glass forceps and pass it rapidly through the flame of the spirit-lamp before placing it in position.

Three points require special attention in mounting in glycerine jelly:—first, to clean and make ready a cover as the first act of the operation; second, to see that plenty of the jelly is landed on the slip; third, to see that the section rests on the slip, and is not merely floating in the jelly, before lowering the cover-glass.

Exercise VIII.—Practise staining with logwood, carmine, and an aniline dye which washes out of the section as it passes through subsequent processes, Spiller's purple for instance.

1. Take two or three watch-glasses, fill them with distilled water, then empty them into a clean small bottle, and drop logwood stain into this until a deep tint is obtained. Shake the bottle, then filter the diluted stain into the watch-glasses. Transfer sections to one watch-glass, and see that the sections do not lie one upon another; place the watch-glass over white paper, holding it about two inches above the paper, and so practise judging the proper depth of

colour required without removing the sections from the stain. The instant the sections are the desired depth of colour pipette off or pour off the stain and pour on distilled water, two or three lots, to wash away any stain that is simply adherent and not incorporated by the section. Some logwood stains, Ehrlich's for instance, are to be followed by tap-water as a wash. After washing away the adherent stain, pour upon the section a 1 per cent. solution of hydrochloric acid to brighten the colour; watch the effect carefully, then, the instant the brightening has gone far enough, pour off or pipette off the acidulated water, and again pour on several lots of water (tap, or distilled) to get rid of the acid. *Dehydrate* the sections by pouring full strength methylated spirit upon them and letting it remain fifteen minutes or use absolute alcohol, and let it remain five minutes; either will do. The sections may remain in the spirit hours, days, years, any length of time, if the stain—as in the case of logwood, carmine, &c.—is not washed out by the alcohol. Now take as many clean slips as there are sections; remove each section to the centre of a slip with the camel-hair brush, taking care to have the section placed as it ought to be in relation with the two axes of the slip; set each slip having a section upon it on end, leaning against some object and its lower end resting on blotting-paper; when the section upon the slip is sodden, place a drop of *clearing* oil (clove, cedar-wood, &c.) under one of its margins, and tilt the slip so that the oil gets all under it and permeates the section. Lastly, drain off all the oil by setting the slip on end as before, then place the slip on the table and

bring a double fold of blotting-paper firmly upon it, in two fresh places as if drying or blotting ordinary writing before turning over-leaf. This leaves the section sodden almost to dryness. Now quickly put on a drop of xylol balsam and a cover-glass, taking care to press home the cover so that it rests on the section and the section throughout rests on the slip. Air-bubbles may be present, but they always escape.

Care must be taken to prevent rapid *drying* of the section after it is landed upon the slip from the alcohol. On no account preserve any section to which this accident has occurred. As soon as the section becomes sodden it is dry enough for the clearing oil. Again, if clove oil be used as a clearing agent take care to remove all of it or the section will turn yellow with time.

2. Repeat the last set of operations with another lot of sections and another of the watch-glass contents.

3. Take six clean slips and perform the *staining*, *dehydrating*, and *cleaning* upon each thus: take a slip, lift an unstained section from the spirit into a saucer of water to get rid of the spirit, then with a camel-hair brush transfer it to the centre of the slip; drain away the water; put two or three drops of logwood stain mixed with water and filtered upon the section; watch the colour of the section; wash off simply adherent stain, and go through the entire processes as before, only doing all on the slip.

4. Take three clean watch-glasses and place some *solution* of carmine in them (carmine *dissolved* in ammonia, or in borax), then transfer sections from the

spirit to these solutions of carmine. Take one watch-glass of sections in the stain and let the sections imbibe as much carmine as they will, then pour off or pipette off the carmine solution and wash off adherent stain with several lots of water as in logwood staining. Now take an acid solution (5 per cent. HCl in water 1 part, methylated spirit 2 parts) and pour some upon the sections in the watch-glass and notice their colour and their giving up of the simply adherent or loosely held carmine and the instant they are of a salmon colour pour off the acid solution and pour on several lots of water to get rid of every trace of acid. Lastly, proceed exactly as if the sections were stained with logwood; see *ante*.

In the choice of a carmine stain notice the solvent of the carmine (ammonia, borax, &c.): it is the solvent, not the carmine, that we have to beware of. If ammonia has been used it will injure the sections or tissues if it exists in the stain in great quantity. It is usual to let a carmine stain where ammonia has been used stand in a bottle with the cork or stopper out so that the superfluous ammonia may escape. Borax is used as a solvent where tissues are stained in bulk on account of its penetrating qualities. It is used also for sections.

The principle of staining in carmine and in many other stains is this: to allow the tissues to imbibe and incorporate as much stain as they can hold. The protoplasm of the cells will incorporate the stain most and hold it the fastest, and the formed material (fibres) next. Both cells and fibres will *incorporate* more stain than they can hold fast, and some stain will also simply

adhere to them, therefore we have three degrees of staining :—

1. Stain incorporated and tenaciously held.
2. Stain incorporated but loosely held.
3. Simply adherent stain.

Water washes off simply adherent stain ; appropriate reagents (acidulated water, or alcohol only) abstracts loosely incorporated stain.

Practice alone will enable the student to stop the process of stain removal at the correct moment. With the unaided eye, or under a low power of the microscope (simple or compound) the stain abstraction is watched and the process arrested at the proper moment.

Exercise IX.—Take more sections and practise staining in Spiller's purple ; washing off the superfluous stain and taking the requisite steps and mounting in balsam.

Exercise X.—Procure a few frogs and kill each by anæsthetising. Use a moist chamber and take bits of muscle, nerve, &c., and practise teasing. Take drops of fresh blood and practise irrigating with the salt-solution slightly coloured with ink. Take other drops and practise the application of gases and vapour. Take further drops and practise the application of heat.

P.—THE COLLECTION AND PREPARATION OF MATERIAL.

The sources from which specimens are taken are so varied that an attempt at classification could only end in failure. I shall therefore give them in the order which offers most facility in preparation, by placing those first which require the longest time to prepare. It will be seen that I have grouped the knacker's yard products, and the slaughter-house products, as there are journeys to be made in each case. The Roman numerals refer to the demonstrations in Part II. : the letters and figures within brackets refer to the hardening reagents.

HORSE.

- VII. 4.—(C 1, 3.) Ligamentum nuchæ.
 „ 5, 6.—(I 19.) Ligamentum nuchæ.
 VIII. 1.—(I 6.) Tracheal Rings.
 „ 2.—(I 6.) Costal Cartilages.
 „ 3.—(I 6.) Epiglottis.
 „ 5.—(I 6.) Intra-artic. Cartil. of Stifle Joint.
 IX. 4.—(I 19.) Parietal Bone.
 XII. 1.—(I 13.) Metacarpal Nerve.
 „ 2.—(I 13.) Metacarpal Nerve.

- XIII. 1.—(I 11.) Metacarpal Artery and Vein.
 „ 2.—(I 13.) Mesentery, piece of (containing Artery and Vein).
 XV. 2.—(I 11.) Axillary Gland.
 XXIII. 3.—(I 11.) Supra-renal Body.
 XXV. 1.—(I 15.) Ureter.
 XXVI. 4.—(I 15.) Fallopian Tube.
 XXVIII. 2.—(I 3.) Spinal Cord (Cervical Region).
 XXX. 5.—(I 11.) Eye (section through, see note below).

Notes.—The student should go to the knacker himself and ask leave to visit the yard. Having got leave, ask when killing-day is, usually on Monday. The student should ask the men to point out old horses so that he may avoid taking parts from them. The men will also point out the parts, such as *stifle* joint, *knee* joint, and other parts to which stable terms are applied.

A sharp razor, a strong sharp scalpel, a strong sharp pair of scissors, and a strong pair of forceps must be taken; also a short wide-mouthed bottle (one holding about a litre) full of salt-solution, and the parts put into it there and then. A slab of paraffin or white wax may be taken to cut upon. Immediately on arrival at home the parts are to be placed in their appropriate fluids after being properly cut into bits the size required, usually about 1 cm. cubes.

VII. 5, 6.—Pieces (cubes) about 1 cm. in size are to be placed for seven days in this fluid; then washed twenty-four hours under a tap and placed in 95 per cent. alcohol.

VIII. 1, 2, 3, 5.—Care must be taken to cut the bits in the same plane as the intended sections and very thin (0.5 cm. perhaps) as the picric solution does not penetrate very well.

IX. 4.—This is required for free periosteum ; therefore the bone must remain in the fluid until well decalcified. After this it must be placed in changes of Ranvier's alcohol for some days until little pieces of periosteum can be ripped off with fine forceps. Stain and mount in Farrant, using a shallow cell.

XII. 1, 2 ; XIII. 1.—Ask the men to point out the "fetlock" joint, then on the outside of the joint nearer the back than the front there is a depression. The metacarpal artery, vein and nerve, lie close together, in the order V A N in passing *over* this joint to reach the foot. Try to get a length of them out without separating them. It is quite easy to do so.

XIII. 2.—The piece of mesentery chosen should contain an artery and vein. Pin it out on cork, and float it on the bichromate solution. Some sections, transverse of course, should be placed in osmic acid to show fat in cells. Indeed the sections are as useful for showing fat in cells as for showing a small artery and vein. The stain, logwood for instance, stains the nucleus of the fat-cells.

XV. 2.—The fore-limb of the horse is always separated from the body by the knacker's men ; therefore the glands, large ones, are found on the inside of the large fleshy shoulder, using the term shoulder in the meaning of the butcher.

XXV. 1.—This should be *slightly* distended with the

solution, then tied so that the epithelia get the full benefit of the solution.

XXVIII. 2.—The knacker's men readily get out pieces of the cervical spinal cord. Short (0·5 cm.) transverse sections are to be placed forty-eight hours in the fluid. Pieces are then snipped out of the anterior horn of grey matter, and placed in 2 per cent. solution of picro-carmin for twelve hours or so, then multipolar nerve-cells are picked out of the pieces with needles (using a dissecting-microscope) and mounted in Farrant in a shallow cell.

XXX. 5.—The two eyes should be cut with a razor the instant the animal is dead, thus: separate the eyelids, and hold the eye steady with one hand (the left), then with a bold sweep cut the eye across a little behind the junction of the cornea with the sclerotic so that the lens, iris, and cornea are taken away. When the whole has been in the hardening fluid three days, shell out the lens, then replace in the fluid. Before making sections, cut the parts in two with strong sharp scissors. Small bodies, *corpora nigra*, will be seen on the free (pupil) edge of the iris.

CALF.

VII. 1.—(I 9.) Tendo Achilles.

XV. 4.—(I 1.) Thymus Gland.

PIG.

VIII. 4.—(I 6.) Ear Lobe.

XX. 6.—(I 11.) Duodenum.

XXI. 1, 2, 3.—(I 11.) Jejunum.

XXII. 2, 3.—(I 13.) Liver.

XXXI. 5.—(I 11.) Retina.

SHEEP.

IX. 1. Shin-bone (see note below).

„ 2, 3.—(I 19.) Shin-bone (see note below).

XVI. 5.—(I 11.) Hoof.

XXVI. 1. Ovum.

OX.

XXVI. 1.—(I 11.) Cervix Uteri.

Notes.—Exactly the same remarks apply to the butcher's slaughter-house as were made regarding the knacker's yard with regard to asking permission,

instruments and salt-solution to be taken, gratuity and so forth.

XX. 6.—A piece of duodenum is opened up with scissors, and the surface gently washed in salt-solution; then pieces are pinned out on cork and placed in the fluid.

XXI. 1, 2, 3.—The jejunum receives the same treatment as the duodenum; but regarding 2 (horizontal sections) the pieces must be infiltrated with some mass which, after the sections are made, will hold the pieces (villi and crypts of Lieberkühn) together. Paraffin or celloidin are the best: gum-solution will do, but is not so good.

XXII. 3.—The piece should be taken half-way between the surface and root of the liver, and should include—preferably have in its centre—a moderately large portal canal and contents.

XXXI. 5.—The entire posterior half of the eye is to be taken and hardened, but, and this is important, the entire eye with incisions through the sclerotic is to be placed for forty-eight hours in the solution before the eye is cut in two, otherwise the retina gets detached and collapses.

IX. 1.—A fresh shin-bone is sawed into short lengths (0·5 c.m.); these are at once put into water for three months, the water being changed now and then. They are now placed in the open air to dry and bleach. Now rub a fine face on each on a water-of-Ayr stone wetted with water; stick each on a piece of plate-glass by means of stick Canada balsam, heated, the fine face nearest the glass. Rub each down very thin on a rasp, afterwards

rub on a water-of-Ayr stone wetted with water. When the bone is so thin as to be almost invisible float it off with spirit; place in gum solution and take the requisite steps and mount in xylol balsam.

IX. 2, 3.—These had better be mounted in glycerine jelly.

XVI. 5.—The hoof should have sections taken from its upper fourth.

XXVI.—Prick a ripe Graafian follicle of a fresh ovary with a needle and catch the contents in a short test-tube containing a trace of osmic acid in distilled water. Decant the water after standing for some minutes, then pour into the tube a few drops of picro-carmin solution and place it away for twenty-four hours. Shake the tube and pour the contents upon a slip and search for an ovum, with a low power. Mount in Farrant, using a shallow cell.

YEAR-OLD FEMALE RABBIT.

(Read over Notes XIV. 2, 3, before killing the rabbit.)

V. 2.—(I 15) Small Intestines, short length.

„ 3.—(I 15) Bladder.

XI. 1. Colon, part of.

XIII. 3.—(I 9) Omentum.

XIV. 2, 3. Diaphragm.

XIX. 1.—(I 11) Submaxillary Gland.

XXVI. 3. Ovary.

XXIX. 1, 2. Tongue for *Papillæ Foliatæ*.

XXX. 1.—(I 9) Lens.

FASTING RABBIT.

(*Injected with silver-solution.*)

XIII. 5.—(I 1.) Mesentery.

„ 6.—(I 1.) Humeral Artery.

XV. 1.—(I 1.) Lymphatic Gland.

XXIV. 2, 3, 4, 5.—Kidneys.

RABBIT.

VI. 1, 2, 3, 4, 5.—Areolar Tissue.

Notes.—The year-old female rabbit is chosen on account of the ovary (XXVI. 3). Immediately the rabbit is dead proceed to silver the diaphragm (XIV. 2, 3).

V. 2, 3.—A short length of the jejunum and the bladder are dilated with the fluid, then placed in it for forty-eight hours. Columnar epithelium from the jejunum and transitional epithelium from the bladder are brushed away, separately of course, and treated exactly like the olfactory epithelium (XXIX. 4).

XI. 1.—A length of colon is well distended by a $\frac{1}{3}$ th per cent. bichromate of potash, and placed in it for forty-eight hours. Place in several changes of Ranvier's alcohol a piece spread on cork for twenty-four hours, then tear away minute shreds of the muscular coat and tease them on a slip in Ranvier's alcohol so as to isolate the cells, which are then to be treated like XXIX. 4.

XIII. 3.—Cut out a piece of omentum containing blood-vessels; pin on cork; harden in Müller's fluid for a week; wash away the hardening fluid; stain with picro-carmin, and mount in Farrant.

XIV. 2, 3.—Before killing the rabbit see that the following things are in readiness:—

1. A large siphon bottle of distilled water.
2. At least 25 c.c. of 0·5 per cent. silver-solution.
3. Some distilled water in a large saucer.
4. A strong pair of scissors and forceps.
5. A scalpel.
6. A smooth slab of wax.
7. A large soft camel-hair brush.

Kill with chloroform and sever the animal in two immediately above (in front of) the diaphragm. This is done by opening the thorax and inserting the finger around the periphery of the diaphragm and cutting with strong scissors, using the finger as a guide. Sever everything, but avoid touching the centre of the diaphragm.

Direct a stream of distilled water from the siphon bottle upon the pleural surface, and brush *gently* the surface of the central tendon. Pour on it after brushing half the silver-solution, and let this remain five minutes. Again direct a stream of distilled water to wash away the silver-solution.

Now cut out the diaphragm carefully to avoid any rubbing, and silver the central tendon and adjacent parts without brushing off the epithelium. Before pouring on the silver-solution all blood must be washed away with a jet of distilled water. The diaphragm

during this operation, and the silvering, and the washing off of the silver may be laid on the wax slab if desired.

Lastly, place the central tendon in the saucer of distilled water, and expose each side to light in the usual way. Substitute 75 per cent. alcohol, then 95 per cent. ; for the distilled water, then mount pieces showing each (pleural and peritoneal) side of the central tendon in balsam, also some in Farrant.

XXVI. 3.—The ovaries are each to be treated like those of the kitten (XXVI. 2).

XXIX. 1, 2.—The papillæ foliatæ, or taste-buds of the rabbit are two oval bodies situated one on each edge of the tongue well back towards the root. The entire tongue should be got out: then a transverse slice of the tongue including the taste-buds should be taken: this slice is now divided, and one part with its taste-bud is put into Müller's fluid for a week, then into alcohol, and so forth for sections. The other taste-bud is placed in 5 per cent. chromate of ammonium for forty-eight hours, and the epithelia treated like the olfactory epithelium (XXIX. 4).

XXX. 1.—The lens is hardened for fourteen days in Müller's fluid, then in alcohol. The entire front half of the eye is to be taken away, and placed in the hardening fluids, in order that the lens may not be disengaged from its capsule. Sections should be made across both axes of the lens, and stained in logwood before being mounted.

The fasting rabbit should be killed after fasting twenty-four hours. It is to have its blood-vessels

injected with a 0·5 per cent. solution of nitrate of silver ; therefore the vessels are first thoroughly washed out with distilled water from a large siphon bottle. A snip should be made in the right auricle of the heart, so that the water can escape. The water stream is to be kept up for ten minutes; then the silver-solution is injected, and allowed to remain ten minutes in the vessels; then this in turn is washed out by another prolonged stream of distilled water.

XIII. 5, 6.—A piece of mesentery, and a short length of the humeral, or femoral artery, are to be passed through alcohols; the former pinned on cork, the latter slit open with scissors and pinned on cork, taking care that the epithelium lining the artery is not rubbed.

XV. I.—This may be cut freezing, and stained with logwood and eosin.

Any rabbit will do, a young one perhaps being least expensive. It is only required for the study of areolar tissue. The student must choose a time when he can spare an hour or more.

The areolar tissue is got by reflecting a small triangular flap of skin; the tissue, which is without fat, adhering to the skin so reflected.

A fresh flap will probably be required for each preparation. Care should be taken to avoid hairs.

Curved scissors are used to snip off very minute bits of the tissue; a clean dry slide is taken, and the piece spread by means of needles upon it. The tissue is to be breathed upon from time to time during the spreading, to supply the vapour lost by evaporation; in other words, to prevent drying.

VI. 1.—As soon as the piece is well spread, drop 0·25 per cent. solution of silver nitrate upon the centre of it; carefully wash this off, expose to the light, then cover, using Farrant.

VI. 2, 3.—Charge one of Koch's hypodermic syringes with picric acid solution, then insert the nozzle obliquely along the inner surface of a freshly reflected flap, and inject. This raises a large bead. Cut off the flap and place it in a moist chamber for twenty-four hours. Extract the picric solution by floating the flap pinned on cork upon Ranvier's alcohol for twenty-four hours. Now snip off the bead and cut it in two: stain one piece in micro-carmine, the other in magenta solution for twelve hours, then mount each bit *after well spreading* in Farrant.

Unless the picric solution is extracted, crystals of the acid will afterwards form.

DOG.

FASTING DOG.

XIX. 2.—(I 1.) Submaxillary Gland.

„ 4.—(I 1.) Pancreas.

XX. 1.—(I 11.) Œsophagus.

„ 4.—(I 11.) Mucous Membrane of Stomach.

XXII. 5.—(I 13.) Liver.

XXIII. 2.—(I 11.) Spleen.

XXVIII. 1.—(I 17.) Spinal Cord.

„ 5.—(I 17.) Spinal Ganglia (dorsal).

XXXIII. 1, 2, 3, 4.—(I 17.) Brain and Medulla.

FED DOG.

- XV. 3.—(I 11.) Tonsil.
XIX. 5.—(I 1.) Pancreas.
XX. 3.—(I 1.) Mucous Membrane of Stomach.
XXII. 4.—(I 13.) Liver.
XXIII. 1.—(I 11.) Spleen.
XXIX. 3.—(I 15.) Nasal Septum (Olfactory part).
„ 4.—(I 15.) Olfactory Epithelium.
XXX. 1.—(I 11.) Upper Eyelid.

Notes.—Small dogs should be chosen. Bird and animal dealers supply them for about half-a-crown each. On no account accept any dog but a mongrel, otherwise it may have been stolen and therefore somebody's esteemed property. Old dogs should be rejected.

Dogs such as pointers and hounds are fed *once* a day, therefore there is no cruelty in keeping a dog fasting twenty-four hours. A fed dog should be killed during active digestion; that is, about five hours after a full meal. The student should prepare the meal and see the dog eat it. The meal should consist of boiled liver and muscle with lard and bread all mixed and cut up together.

The *instant* the fed dog is dead (from chloroform) the pancreas, liver, mucous membrane of the stomach, and the spleen, are to be got out and bits put in strong alcohol.

The *instant* the fasting dog is dead from chloroform, no time should be lost in getting out the pancreas, liver,

mucous membrane of the stomach, and spleen, and placing bits in strong alcohol.

XIX. 2.—A few deep incisions are to be made across the gland before placing it in 95 per cent. alcohol. Stain first in logwood, then in iodine green.

XIX. 4.—Cut the pancreas into little bits not larger than 0.5 cm. cubes, and place them at once into absolute alcohol.

XX. 1.—The œsophagus should be very slightly distended and tied. Some sections should be stained with logwood, then in iodine green, to show the mucous glands.

XX. 4.—Pieces about 1 cm. square of the mucous membrane are to be cut out of the cardiac and pyloric ends of the stomach and one from the middle : pinned on cork, the free surface of the membrane uppermost of course. Sections are best stained with logwood and eosin, which differentiates the two kinds of cells.

XXVIII.—Sections of the spinal cord are to be made by freezing. Some sections should be made as soon as the cord has been hardened in the Erlicki's fluid before placing the cord in alcohol in order that they may be stained in osmic acid ; some also should be stained in the following way :—Let sections be placed in 0.5 per cent. methyl green for twelve hours ; wash well in distilled water, then place in the borax carmine. This stains the axis cylinder and ganglion cells red, whilst the neuroglia comes out violet, remainder green. Erlicki washes for two hours in distilled water before staining in ammonia carmine.

XXXIII. 1, 2, 3, 4.—Sections of brain and of

medulla, best made by freezing, are stained in an alcoholic solution of aniline blue-black and mounted in xylol balsam.

XIX. 5, XX. 3.—Treat these like the corresponding parts of fasting dog.

XXIX. 3.—The olfactory part of the nasal septum is situated high up in the nose and is *brownish*.

XXIX. 4.—A few scrapings of the olfactory mucous membrane are to be placed in the 5 per cent. in a test-tube for twenty-four hours. The 5 per cent. is then decanted and several lots of distilled water poured on to the scrapings, each being carefully decanted. Lastly a few drops of picro-carmin solution are dropped into the tube, and after twelve hours little bits of the epithelium are broken up on a slip with needles (using a low power, or a dissecting-microscope) and mounted in Farrant.

CAT.

XVII. 1.—(I 6.) Trachea.

„ 2.—(I 6.) Trachea.

XVIII. 1.—(I 19.) Lower Jaw.

„ 5.—(I 11.) Tongue.

XX. 2.—(I 11.) Stomach.

XXVI. 5.—(I 11.) Uterus.

„ 7.—(I 9.) Mammary Gland.

XXVII. 1.—(I 13.) Meso-rectum.

„ 2.—(I 13.) Meso-rectum.

KITTEN.

- X. 1.—(I 6.) Lower Jaw.
 „ 2.—(I 6.) Fore-foot.
 XVII. 3. Lungs (silvered).
 XXVI. 2. Ovaries.

Notes.—A cat with kittens should be got: the latter are not to be more than a week old. Before killing a kitten, read Note XVII. 3 below.

XX. 2.—The stomach should be cut in two across its long axis and the pyloric end portion gently washed in salt-solution before being placed in the hardening fluid, to get rid of food and mucous. Sections are to be made also across what was the long axis. Vertical sections through the pylorus including a little piece of stomach on the one side and duodenum on the other, are also to be made.

XXVI. 5.—The uterus had better not be distended, but one or two deep incisions (half through it) may be made across its long axis before it is placed in the hardening fluid. Some sections should be stained with iodine green.

XXVI. 7.—The mammary gland being in activity, some sections are to be made after hardening in Müller's fluid before placing the gland in alcohol, in order that they may be stained in osmic acid.

XXVII. 1, 2.—The meso-rectum of the cat is required on account of the Pacinian bodies it contains. They are very small roundish bodies, the colour of dirty

gelatine. The meso-rectum is pinned out on cork and floated on the hardening fluid for a week or so.

A little piece containing a Pacinian body is passed through alcohols, stained with logwood and mounted in xylol balsam.

Take another piece, wash away the bichromate with water, and make sections along the long axis of a Pacinian body, and place the sections to stain in osmic acid before mounting in balsam.

XVII. 3.—Before killing the kitten get the silvering apparatus ready; namely, a small clean glass funnel and a finely drawn short pipette connected by a very short piece of india-rubber tubing; a small bottle of 0·25 per cent. silver nitrate solution and two pieces of string. The moment the kitten is dead get out the lungs, trachea, and heart entire, and tie one piece of string tightly round the upper part of the trachea, then make a loop just large enough for two fingers on the string. Pass the third and fourth fingers of the left hand through this loop; make a longitudinal slit in the trachea; insert the pipette, and, whilst the forefinger and thumb of the left hand hold the funnel, pour the silver-solution gently into the funnel until the lungs are distended, not over-distended. Remove the funnel, tie the second piece of string tightly round the trachea below the slit, then place the lungs in 95 per cent. alcohol to harden. In the sections the cement substance of the scaly epithelium of the alveoli will be found silvered. Sections although silvered should be stained with logwood and eosin and mounted in xylol balsam.

XXVI. 2.—Be careful not to rub the exterior of the

ovary. Place it at once in 1 per cent. osmic acid solution for twenty-four hours; wash it well with water and complete the hardening in alcohols. Mount some sections in Farrant.

The remaining ovary should be hardened in Müller's fluid; then alcohols and sections stained with carmine.

RAT.

Choose one half-grown, and read Notes on XXVII. 5 and XXX. 3 before killing.)

- VI. 6.—(I 6.) Head of Femur.
- IX. 5.—(I 1.) Tongue.
- XVII. 4, 5.—(I 1.) Lungs.
- XX. 5.—(I 1.) Stomach.
- XXI. 5.—(I 1.) Duod., Jejunum, Colon.
- XXII. 6.—(I 1.) Liver.
- XXIV. 6.—(I 1.) Kidney.
- XXVII. 5. Cornea (gold).
- XXX. 3. Cornea (silver).
- XXXIV. 2, 3, 4.—(I 6.) Head.

RAT.

(Choose a full-grown young male, and read Note on XXI. 6 before killing; also note that the bile-ducts are to be injected.)

- VI. 6, 7. Areolar Tissue.
- XXI. 6. Small Intestine, piece (gold).
- XXII. 7.—(I 1.) Liver.
- XXV. 5.—(I 9.) Testis and Epididymus.
- „ 6. Epididymus.

Notes.—The half-grown rat is to be injected with carmine gelatine, *but the corneæ are to be treated first.* After injecting, many of the parts are to be hardened in alcohol. The sections are not to be too thin, 30μ is quite thin enough.

XXVII. 5.—Take a very sharp razor, and the moment the rat is dead slice away one cornea and put it in 0·5 per cent. chloride of gold solution for half an hour, and proceed in the way described. If the cornea is not severed by the one stroke of the razor complete the division with scissors. On no account drag the cornea or stretch it.

XXX. 3.—Whilst the rat is profoundly narcotised scrape the surface of a cornea with a knife, then brush it with 1 per cent. silver-solution; keep repeating the brushing. Take away the cornea as described above. After treating in the usual way the cornea is to be cut into quarters and mounted in Farrant, anterior or silvered surface uppermost.

XXXIV. 2, 3, 4.—The entire head minus the lower jaw is to be cut into sections as indicated; therefore it must be decalcified first. Slices are first cut with a sharp table-knife, and then cut by the freezing method and stained with logwood and eosin and mounted in balsam. Others are stained in picro-carmine and mounted in Farrant.

VI. 6, 7.—The areolar tissue is to be examined like that of the rabbit, and some bits in salt-solution. A permanent specimen should be prepared and mounted like VI. 2 of the rabbit.

XXI. 6.—A short length of the small intestine is to be stained with gold chloride by Ranvier's lemon-juice method. Stirling distends the gut with the lemon-juice

and he places 2 per cent. gold chloride in the gut, and suspends it in 1 per cent. to get the advantage of the increased osmotic action induced by the different densities.

With forceps strip off bits of the external muscle, and select those bits which have most Auerbach's plexus upon them and mount in xylol balsam.

XXII.—The bile-ducts of the liver are to be injected with coloured gelatine. I prefer carmine gelatine: Prussian-blue gelatine is so apt to fade. If however the student should prefer the blue injection, he must mount with commercial balsam, thinned by turpentine, and he had better wash off the superfluous balsam from the slip at once and ring it with glycerine jelly, then white zinc cement, to keep as much turpentine from evaporating as possible. *Cui bono?*

XXV. 5.—The testis should have a few deep incisions made in it crosswise, then placed for a long time (twenty to thirty days) in Müller's fluid, and afterwards in spirit. Cut sections by freezing, and stain some with Spiller's purple, others with the ordinary stains.

XXV. 6.—Make a cut into a fresh globus major and squeeze a little of the seminal fluid out and examine without covering. After examining, spread some seminal fluid on a cover and expose it to the vapour of osmic acid in a vulcanite cell for half an hour, then remove it: let it dry, and mount it in xylol balsam.

MOUSE.

(Notice that there are two silver preparations which are to be done first.)

- VII. 2. Tendon of Tail.
 „ 3. Tendon of Tail (silvered).
 XII. 3. Lateral Costal Nerves (silvered).
 XXIV. 1.—(I 15.) Kidney.

FŒTAL MOUSE.

- X. 3.—(I 6.) Parietal Bone.

Notes.—Mice are sold at twopence each by dealers. A mouse-trap is a useful article for the histologist. The pregnant mouse may have to be bought.

VII. 2, 3.—Kill a mouse and instantly cut off its tail close to the body. Skin the tail, then seize the small end joint with forceps and pull it off. In doing so a fine silvery-looking leash of tendons comes away. Place the tail instantly in the moist chamber, and dip the leash into 1 per cent. silver-solution for ten minutes; withdraw and wash off the silver, then suspend the leash in 75 per cent. alcohol and expose to the light in this for twelve hours; then suspend in absolute alcohol for half an hour. Now dip the leash into cedar-wood oil for ten minutes; drain this away

by trailing the *end* of the leash over a clean slip; then cut off lengths and mount in balsam in a shallow cell. The leash throughout is not to be rubbed.

Seize the tail again, and draw out another leash and dip it in 2 per cent. acetic acid "until it loses its lustre, and appears glassy and transparent" (Purser). After this wash off with water and *suspend* in dilute logwood in a short test-tube for twelve hours; then proceed as in the last preparation, and mount in balsam. Care must be taken not to twist the fibres; never lay the leash down; always lift it up and down perpendicularly. Lastly, another leash should be drawn out and examined in salt-solution. The salt-solution, a large drop, should first be placed on the slip, then the leash placed *on* this and allowed to sink of itself, and the excess of fluid drained off with bibulous paper. (See Purser, p. 67.) A shallow cell should be used to prevent the cover from quite resting upon the tendon.

XII. 3.—Reflect the skin of the thorax of a newly killed mouse right and left after making a median incision along the sternum; the lateral cutaneous branches of the intercostal nerves will be seen stretching across to the skin. Drop 1 per cent. silver-solution on some of them for ten minutes; then wash off with water and snip through the nerves close to the flesh, and cut away the skin to which they go, and place nerves and skin in 75 per cent. alcohol, and so forth, proceeding as in the case of the silvered leash of tendons and mount lengths in balsam using a shallow cell. Great care is to be taken to prevent rubbing off the epithelium. These

show the epithelium covering the nerve-bundle, also Ranvier's crosses.

X. 3.—Place the entire head after skinning in picric solution for twenty-four hours; then search for the parietal bones and get them away by using forceps. After removing the acid by 75 per cent. alcohol, stain in picro-carmin and mount in Farrant.

YOUNG GUINEA-PIG.

(*Read over the Note on XXXII. 3 before killing the guinea-pig.*)

- | | |
|-----------------|---------------------|
| IX. 5. | Red Marrow of Rib. |
| XIX. 3.—(I 1.) | Submaxillary Gland. |
| XXV. 2.—(I 11.) | Bladder. |
| XXXII. 3. | Cochlea. |

Notes.—The very young guinea-pig is valuable to the histologist on account of the internal ear. The submaxillary gland too of the guinea-pig, is a mucosalivary gland. One a month old or so should be chosen.

IX. 5.—The rib, as pointed out by Ranvier, is to be broken not sawn. Examine the fresh marrow in salt-solution, but make a permanent slide or two by spreading the marrow on cover-glasses and inverting these over 1 per cent. osmic acid for half an hour to fix the cells before staining and mounting in Farrant. A drop or two of the osmic solution is conveniently

placed in a vulcanite cell fixed on a slip, and the cover inverted effectually exposes the preparation to the vapour of the acid and "fixes" the protoplasm.

XIX. 3.—This being a muco-salivary gland the sections are, some of them at least, to be stained with iodine green. The gland is to be cut into little bits, and placed direct in 95 per cent. alcohol.

XXXII. 3.—Before killing the guinea-pig have ready a hypodermic syringe and some 1 per cent. osmic acid solution. The very instant the animal is dead inject the osmic solution into the cavity of each tympanum by piercing the tympanic membrane. On removing the lower jaw, the large, white, oval, tympanic bullæ are very conspicuous. Get each internal ear away with the fingers, a thing easily done, and shake or jar them as little as possible. Cut a hole through each tympanic bulla and let the osmic, if any, escape; then drop each into Klein's solution for a week. After this wash away the Klein's solution and get out the two cochleæ and place them in picric solution to decalcify. Try with a needle daily to ascertain how the decalcification is proceeding. When ready for cutting bath and embed in paraffin and cut the *entire cochlea along its long axis* into a ribbon of sections and stain the sections on the slip after removing the paraffin, as directed. These make most perfect preparations.

STUDENT.

II. 4.	Blood.
„ 5.	Blood.
„ 6.	Blood.
III. 3.	Blood.
„ 4.	Blood.
IV. 4.	Blood.
„ 5.	Blood.
„ 6.	Blood.
„ 7.	Blood.
V. 1.	Epithelium of Cheek.

HUMAN CADAVER.

XVI. 1.—(I 11.)	Skin (palmar surface of Finger).
„ 2.	Skin (XVI. 1), gold-stained.
„ 3.—(I 11.)	Scalp.
„ 4.—(I 11.)	Scalp.
XVIII. 2.	Canine Teeth.
XXXIV. 1.—(I 17.)	Cerebral Convolution.

MALE CHILD CADAVER.

XV. 4.—(I 11.)	Thymus Gland.
XXIII. 4.—(I 11.)	Thyroid Gland.
XXV. 3.—(I 11.)	Prostate Gland.
„ 4.—(I 11.)	Penis.

Notes.—A drop of blood the student gets from his own finger by tying a handkerchief tightly round it, then pricking the end with a small sharp needle.

II. 4, 5.—These are fresh droplets.

II. 6.—The more expensive warm stages have thermometers attached to them. If a more primitive one be used (such as a piece of sheet copper the size of the slip with a hole in the centre and a piece of stout copper wire or rod soldered to this at right angles) a piece of cacao butter, which melts about 37° C., should be placed on the copper near the slip, then the spirit-lamp is placed at a short distance and placed so as to heat the copper rod. Watch the butter and when it *begins* to melt withdraw the heat.

The blood observed should be in a shallow cell whose surface has been refreshed with olive oil before placing on the cover. This prevents evaporation during the observation.

V. 1.—Scaly epithelium may be scraped from the inner side of the cheek with a clean blunt knife.

XVI. 2.—It is difficult to obtain this. The finger must be fresh; therefore a student would need to not only be attached to a hospital but be ready with his gold stain before an amputation of the coveted member. It is however not of vital importance though desirable. That of an ape or monkey would do.

XVIII. 2.—The canine tooth must be sound and must be treated the same as the sheep's shin-bone (IX. 1) and mounted in glycerine jelly.

XXXIV. 1.—If this cannot be obtained that of a dog will do, though it is not difficult to obtain human cerebrum.

DUCK.

XXVII. 3.—(I 9.) Tongue of Duck.

Note.—A duck bought in the market will do though the student had better bespeak a fresh tongue by asking a poulterer when these wares first arrive. Thin vertical slices should be hardened in Müller's fluid for a fortnight, then sections are placed in 0.2 per cent. osmic acid solution for twenty-four hours. A little difficulty from brittleness and hardness will be experienced in cutting, but the sections show the tactile corpuscles very well.

If the student has the chance of a perfectly fresh tongue he had better treat thin vertical slices by the lemon-juice and gold method of Ranvier.

OYSTER.

V. 5. Gill of Oyster (fresh).

Note.—Study ciliary motion in the gill of a fresh oyster.

“The gill consists of lamellæ placed one over the other like the leaves of a book. Each lamella is marked by deep grooves running radially towards its

free edge. The sides and surface of the projections bounding these grooves are covered by cells whose cilia are so long that they can readily be seen with quite a low power.

“Cut off a portion of one of the lamellæ and gently separate the linear projections with needles, touching them in as few places as possible. Put on the preparation a drop of the fluid which is contained in the shell of the animal and examine with a low power, applying a cover-glass. On the separated threads the motion of the cilia can be distinctly seen. Notice that the motion along the two sides of the same groove is in opposite directions.

“Put a few drops of chloroform in the bottom of a bottle whose cork is perforated by two glass tubes to one of which a piece of india-rubber tubing is attached and the other bent so that its end can be placed near the object. Air blown through the bottle emerges charged with chloroform vapour. Blow gently, then in a few seconds the ciliary movement will become slow and cease, not everywhere at once. When the motion has ceased remove the chloroform bottle and blow air on the slide, when the motion recommences, at first here and there but soon becomes general. Whilst the movement is slowed by the vapour notice its details.

“A similar stoppage can be produced with carbonic acid gas, the movement recommencing when air is applied.”—Purser.

SKATE.

XXXII. 1, 2. Head of Skate.

Note.—The fishmonger will supply the heads of skates during the cold weather of winter. They must be quite fresh.

The semicircular canals are to be laid bare, and a part of one them and an ampulla cut out and hardened in Klein's solution for a week, then passed through alcohols and bathed in paraffin. Sections, cut after embedding, are to be carried through the crista acustica in the case of the ampulla, others across a semicircular canal.

Sections may be stained with logwood on the slide. Another and a better way is to place the parts for a week in borax carmine before passing through the stronger alcohols and bathing.

CUTTLE-FISH.

VIII. 7.—(I 6.) Head, piece of Cartilage from.

Note.—This will have to be got from a fishmonger. Take a piece of cartilage and place it forty-eight hours in the picric acid solution, then in 75 per cent. alcohols until the acid is removed: then place in the stronger alcohols. Stain in Ehrlich's hæmatoxylin well diluted for twelve hours. Sections may be mounted in balsam also in glycerine jelly.

FROG.

- III. 1.—Blood, fresh.
 „ 2.—Blood, „
 IV. 1.—Blood, „
 „ 2.—Blood, „
 „ 3.—Blood, „
 V. 4.—(I 15.) Ciliated Epithelium.
 XI. 2.—Bladder.
 XII. 4.—Sciatic Nerve.
 „ 5.—Sciatic Nerve.
 XIII. 4.—Web of Foot.
 XIV. 1.—Septum Cisterna Lymph. Magna.
 XXI. 4.—Intestine.
 XXII. 1.—Liver, fresh.
 XXVII. 5.—Muscle of Thorax.
 XXVIII. 3.—Sympathetic Ganglia (gold).
 „ 4.—Spinal Ganglia.
 XXIX. 5.—Olfactory Epithelium, fresh.
 XXX. 2.—Cornea (gold).
 XXXI. 2.—Lens.
 „ 3.—Retina, fresh.
 „ 4.—Retina (vertical section).

A MALE NEWT (*Triton cristatus*).

- XI. 3.—(I 15.) Mesentery.
 XXV. 7.—(I 15.) Spermatozoa.

Notes.—There is scarcely an old horse-pond in England that does not contain newts. They are easily caught with a purse net on the end of a stick. Frogs are caught with a purse net when in water. Both frogs and newts should be in the histological laboratory. They are best kept in a cool, dark tank with a little water at the bottom and one or two pieces of cork floating upon it for them to get upon. The winter stock of frogs is to be got before the end of October. Frogs bury themselves in mud and hide in dark damp places in the winter (from November to February). If in the laboratory the tank is to be kept quiet and dark. They will take no food, and seem to require none.

Fresh blood is examined before coagulation; therefore when several lots have to be examined from the same animal, frog or newt, the shed blood must not be caught on glass or metal, but on living serous membrane.

A fresh drop of blood will be required for each of the above examinations.

III. 1.—Prepare a moist chamber, then chloroform and pith a frog: expose the heart and snip off the apex, and let the blood flow into the frog's interior (upon living serous membrane). The frog is kept in the moist chamber.

Use a shallow cell for this and other demonstrations with fresh blood.

III. 2.—Take six clean slips: dip the end edge of one in frog's blood and draw it lightly over the centre of the other five, using a fresh dip for each. Let the

five spread slips dry, then pour on each some 1 per cent. methyl aniline green in distilled water and let it remain fifteen minutes. Now move each slip to and fro in a basin of clean cold water to wash off the stain: roughly drain each by placing it on end, then pour on each a little watery solution of eosin, and in five minutes wash this off in a basin of clean cold water as before. Lastly let each dry thoroughly. Then cover, using xylol balsam. One or two are sure to be worth keeping.

V. 4.—After removing the lower jaw of a freshly killed decapitated frog lay the head on the table, roof of mouth upwards. Place any little bit of substance upon the roof of the mouth and watch it travel: it is carried along by ciliary motion.

Cut a piece of the mucous membrane away and place it forty-eight hours in 5 per cent. chromate of ammonium: then some time (twenty-four hours or longer) in Ranvier's alcohol: scrape away, do not brush away, some epithelium and stain and mount as in the case of olfactory epithelium (XXXIX. 4).

XI. 2.—Thoroughly distend the bladder with Ranvier's alcohol in the following way:—Transfix the margins of the anus with needles run in at right angles to one another and tie filosselle tightly beneath them so as to effectually occlude this opening. Now open the abdomen and tie the nozzle of a syringe filled with Ranvier into an opening made in the large intestine and steadily inject. The bladder, a bilobed organ, will rise out of the pelvis and become distended. Ligature it at the neck and cut it away in its distended form

and place it in more Ranvier's alcohol for twelve hours or more. Lastly cut it in pieces of suitable size for mounting as it floats, and after brushing the epithelium off some of these pieces stain them with logwood and eosin and mount in balsam.

XII. 5.—Take a wooden match with the head off and two pieces of thread: then expose the sciatic nerve of a freshly-killed frog. Drop the match upon it and tie the nerve to the match in two places with as great a length between as possible, taking care that the nerve does not become dry. Cut out and place in 1 per cent. osmic acid solution ten minutes. Wash away the acid carefully, then place the structure still on the match for a fortnight in a test-tube of picro-carmin, then cut into lengths of 2 mm. and let these fall upon a large drop of Farrant on a slip. Carefully with needles tease in the long axis until single fibres are separated. We are indebted to Stirling for the hints to tie to a piece of match and to keep in the picro-carmin for so long a period, which, as he says, softens the connective-tissue of the nerve. If the student gets wrong in this process it will most likely be in cutting the prepared nerve into too long pieces,—they should be only minute bits; or in teasing the fibres break. Use a shallow cell in mounting.

XIII. 4.—Examine the blood-vessels, pigment-cells, and watch the circulation in the web of a living frog.

For this purpose the frog should be placed in a comfortable position, as shown in the annexed figure. The cardboard is 13 × 8 cm. and bent at right angles across its longer axis, the angle being maintained by

two copper rectangular straps riveted to the cardboard. A rectangular piece is cut out of the middle of the horizontal half, and a glass slip put in between the cardboard and the copper straps. Two slits in the upright half 1 cm. apart admit a length (12 cm.) of broad tape.

The frog sits quietly for half an hour at a time upon this contrivance with or without whiffs of chloroform. The web is to be kept moist with cold water.

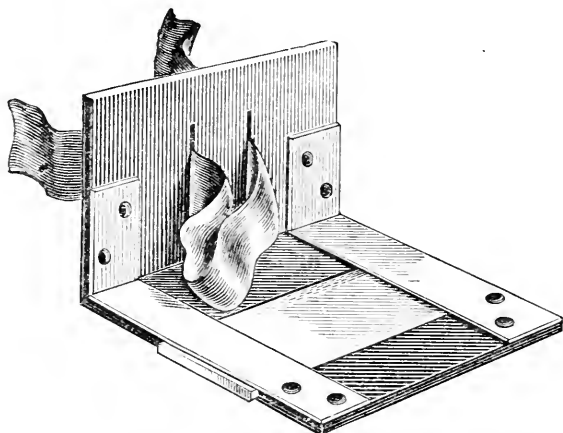

FIG. 43.—Frog-holde

XIV. 1.—Prepare a few c.c. of nitrate of silver solution and draw out a piece of glass tube to capillary size. Then kill a frog: slit open the abdomen and gently with the finger push the bowels, &c., on one side, over to the frog's right side. With the pipette pierce the fine membrane lining the roof of the abdomen and blow gently down the tube, and the thin delicate septum rises up and gets distended. Without removing the pipette pour the silver-solution upon the septum, then in five or ten minutes cut out a piece and place it

in a saucer of Ranvier's alcohol. It must be stained with logwood and pieces mounted in balsam. It is as well to get as much of the silver removed as possible. To do this seize the membrane by its edge as it lies in the Ranvier and trail it to and fro: then place in fresh Ranvier.

XXI. 4.—Feed a frog with fat bacon by placing a little bit in the œsophagus every other day three times: then kill the day after the last feeding. Take away the stomach and small intestines: lay them open and notice the difference in the hue of the mucous membrane of the stomach and that of the small intestine near the stomach, due to the non-absorption of fat by the former.

Place in the moist chamber, then take away a minute piece of the mucous membrane of the small intestine and tease and examine in salt-solution. Notice that the epithelium cells are crowded with fat-globules.

Divide the remaining intestine and pin each piece out on cork. Place one in 75 per cent. alcohol for an hour, then in absolute until hardened. Place the remaining half in 0·5 per cent. osmic acid ten minutes: then transfer to Müller's fluid for three weeks, and pass through alcohols. Both pieces, the spirit piece and the osmic acid one, are to be bathed, embedded, and cut in paraffin into sections vertical to the mucous membrane. Mount by the shell-lac and creosote method, leaving the osmic sections unstained; but staining the others with safranin. The sections should be cut about 5μ in thickness.

XXVII. 5.—Cut through the skin in the mid-ventral

line in a small frog: lift up the flap of skin on one side over the middle of the sternum. A thin band of muscle will be seen running from the skin downwards towards the lower part of the sternum. Cut through the skin above and below the muscle, and tear away the connective-tissue around it. Then keep it stretched and pour 1 per cent. osmic acid solution over it. In a minute or so the muscle will be fixed. With fine forceps tear away carefully from the muscle any connective-tissue that can be seen on its surface and cut it out, being careful to cut the upper end as close as possible to the skin. Place it in osmic solution a few minutes: wash with water: pass through alcohols and mount in balsam. I have taken this and XXI. 4 from Foster and Langley's *Practical Physiology*, pp. 83, 84. (Macmillan).

The preparation is to show the ending of muscle in tendon.

XXVIII. 3.—Take away the sympathetic trunk of a frog and stain it with gold chloride thus:—Prepare some 0·5 per cent. gold chloride solution and place it in a watch-glass. Now kill a frog: pin it out on its back and open the abdomen in the usual manner. The sympathetic trunk lies close to the vertebral column on each side of but behind the abdominal aorta. It is a very slender cord with minute semi-transparent pigmented enlargements (ganglia) on it at short intervals. A further guide to it, as pointed out by Foster and Langley, is the *row* of small nerve-fibres running *transversely* from the spinal nerves (one from each nerve) to the ganglia. It is so easy for a novice to cut it away without seeing it that I give the above authorities'

way of exposing it. They direct the intestine to be picked up and the mesentery cut through above the kidneys: then a kidney to be pulled up: the peritoneum along its edge to be cut through, and the kidney to be turned over to the opposite side of the body.

After gold-staining, place it on a slip and examine with a low power, select the ganglion in which the nerve-cells are seen most clearly and tease this out in glycerine; remove all connective-tissue: then transfer the cells with a needle to Farrant and mount, using a shallow cell.

XXIX. 5.—The posterior nares of the frog are almost close behind the upper lip. Pass a fine probe into a nostril: hold it almost at right angles to the antero-posterior axis of the head, and it will be seen to protrude at the posterior nares.

Kill a frog: cut off its head: remove its lower jaw: slit up each nostril and place the head in 5 per cent. chromate of ammonium for forty-eight hours; after this in Ranvier's alcohol twenty-four hours: then in micro-carmin solution twelve hours. Scrape away some olfactory epithelium with a Beer's knife: break it up with needles in Farrant and mount, using a shallow cell.

XXX. 2.—Cut out with a sharp knife and scissors the two corneæ of a frog: stain in gold, and mount each whole, but cut radiating slits in each so as to make it lie as flat as possible. Mount in balsam.

XXXI. 2.—Place the eyeball of a frog for twenty-four hours in this mixture (nitric acid and glycerine, of each one part, and add three parts of water). Re-

move and place in water another twenty-four hours, then break up little bits of the lens in Farrant, and mount, using a shallow cell.

XXXI. 3.—Remove the eyeball of a freshly-killed frog, and with a sharp razor and scissors divide the eye into an anterior and a posterior half. Place the posterior half in 0·1 per cent. osmic acid solution twelve hours, then in 75 per cent. alcohol twelve hours. Break up bits of retina and mount in Farrant, using a shallow cell.

XXXI. 4.—With a sharp razor, *before removing the eyeball*, divide it as in the last preparation, and drop into the cup formed by the posterior half 1 per cent. osmic acid solution. In five minutes place the head in Müller's fluid for three weeks; then get out the posterior half of the eye and take the requisite proceedings for bathing and cutting in paraffin.

XI. 3.—The mesentery must be pinned out on cork. After passing through alcohols it should be, some portions of it at least, stained in safranin.

XXV. 7.—Place two or three testes, small round bodies seen on removing the abdominal viscera, in 5 per cent. chromate of ammonium forty-eight hours; then place in Ranvier's alcohol twenty-four hours. Lay each on a wax slab and cut it open with a Beer's knife, and squeeze its contents on to a slip. Place some 5 per cent. picro-carmin upon each preparation for twenty-four hours, in a moist chamber; then transfer with a needle to Farrant on fresh slips, or roughly drain away the stain and add Farrant on the original slips. Use shallow cells. Another way is to allow the semen to dry then mount in xylol balsam.

TRADESCANTIA.

I. 8.—Hair of a stamen.

Note.—Cell-division may be studied in the salamander larva, but it is essentially the same and more easily studied in a plant. I copy the following almost verbatim from Bower and Vines' *Practical Botany*, p. 25. (Macmillan).

In order to study the process thoroughly, the hairs on the stamens of *Tradescantia* may be taken. A stamen is to be removed from a bud on a warm day and placed at once in a drop of 1 per cent. sugar-solution on a cover-slip. The cover is then placed over a moist chamber and studied with a power of 500 diameters.

A terminal cell of one of the hairs with a large and conspicuous nucleus is to be watched. The nucleus first gradually elongates in the direction of the longer axis of the cell; it becomes more granular, and its protoplasm aggregates at the poles; then the nucleus becomes striated, the striæ arranging themselves parallel with the longer axis of the nucleus and approach each other at the poles; thus a characteristic nuclear spindle is produced. The striæ are then ruptured in the equatorial plane and gradually collect at each pole, so that two new nuclei are formed. A layer of granular protoplasm is now found in the equatorial

plane, which extends peripherally until it reaches the cell-wall. This layer constitutes the dividing wall between the two cells.

YEAST.

I. 1, 2, 3, 4, 5, 6.—Fresh Brewers' Yeast.

Notes.—Sow a little fresh brewer's yeast on Pasteur's fluid in two beakers, lest one should be spoilt. Put aside in a warm place until it begins to froth up. It will keep good for several days, though the operations had better be carried out in one or two days.

Notice:—1. The varying size of the cells.

2. Their arrangement in clusters or groups.

3. Their shape and mode of union.

4. Their *sac*, that it is transparent and homogeneous and unstained by magenta.

5. Their *protoplasm*, that it is less transparent and stains with magenta.

6. Their *vacuole*: its size, position—sometimes absent.

7. The relative proportion of *sac*, *protoplasm*, and *vacuole*.

To burst the cells so as to see the sacs and their contents, place the slip on a solid level surface, then press smartly on the cover with the end of a scalpel with a fold of blotting-paper intervening.

Place a piece of blotting-paper over one of the beakers of yeast, and examine the cells from day to day to watch their growth and multiplication.

GERMAN YEAST.

I. 7.—German Yeast on potato.

Note.—Shake some dry German yeast in distilled water and let it stand to settle, then decant. With a camel-hair brush spread some of the creamy deposit in a thin layer upon each of three or four fresh slices of a sound potato, and place these in a moist chamber.

Begin in a week to examine the cells *daily* to see cell-division. A minute bit is scraped from the potato and diffused with a needle upon a slip in 1 per cent. solution of sugar, and examined with a $\frac{1}{12}$ or $\frac{1}{15}$ inch objective, preferably an oil-immersion. Use a shallow cell.

AMCÆBÆ.

II. 1, 2, 3.—Amcæbæ.

Notes.—By irrigating, by applying heat on the warm stage, and by applying gases and vapours and by all other means, the student should make a thorough study of amcæbæ.

They may be found in small stagnant pools, mud, and damp earth. Seek for them in the slimy sediment of hot-house tanks. If they cannot be found use the white blood-corpuscle of the frog, or newt.

Irrigation is easily managed. If the effects of drugs

are tried on them, the drugs are to be mixed with normal salt-solution. A cover-glass, if leucocytes be used, is allowed only to just touch a drop of blood on a slip. By this means a droplet is obtained and the cover-glass is inverted over the warm stage, or the gas and vapour cell; then if a drug be tried a drop of the salt-solution containing the drug is placed over the blood. (Brunton.)

Moderate warmth accelerates the movements: a little extra warmth and we have arrest of movements, tetanic contraction or heat tetanus, during which the spherical form is assumed. Movements may be resumed on withdrawing the heat if this has not exceeded 35° C. At 40° C. the motionless sphere is in a state of heat rigour in which the protoplasm is coagulated. Motion cannot be induced now by withdrawing the heat. Slight electric shocks increase the protoplasmic movements; stronger ones cause tetanic contraction; and numerous or powerful ones cause coagulation. One per cent. salt-solution first causes increased protoplasmic movement, then causes sudden tetanic contraction and the expulsion of any food they may contain at the moment, and sometimes even expulsion of their nucleus (Brunton). *Amœbæ* and leucocytes can be fed by gamboge rubbed down in a drop of water. They should be fed before applying the salt-solution. Sometimes they take a long time to feed; in these cases the slip should be placed in a moist chamber and time allowed.

Very dilute acids and alkalies first increase then arrest protoplasmic movement (Brunton). Oxygen appears to be necessary for their life.

The leucocytes of different animals have different resisting powers to the action of drugs; those of the newt being more resistant to the action of drugs than those of the guinea-pig.

It is scarcely necessary to point out that a thorough study, as here indicated, will greatly facilitate the study of the first processes of inflammation.

I have taken most of the preceding remarks from *Pharmacology, Therapeutics, and Materia Medica*, by T. Lauder Brunton (Macmillan), the most fascinating book to the practitioner of medicine who is at the same time a lover of physiology.

Q.—TWO SHORT METHODS OF PREPARING ALL THE SECTIONS USED IN A HISTOLOGICAL COURSE.

I.—BY THE FREEZING METHOD.

1. Prepare by hardening, or softening, *all* the parts of organs and tissues from which sections have to be cut in a complete course of histology.

2. When all are quite ready take a suitable piece of each, taking two or more pieces of each of those requiring sections in various planes. Place all the pieces, after due preparation, when required, in the gum and syrup.

3. In twenty-four hours, or longer, prepare the freezing microtome. Take also as many short wide-necked bottles, like Fig. 38, as there are pieces of tissue. Cut each piece of tissue into suitable sections, and pour through a funnel, as already described, each lot of sections into a separate bottle. Change the water frequently to get rid of all the gum and syrup, then pour on increasing strengths of alcohol up to 95 per cent.

4. Take out a section from each bottle: examine it to see what it is, then label the bottle from which it is taken. Place the bottles in a cool place, changing the 95 per cent. if it at any time becomes muddy.

5. Prepare three times as many slips and covers as there are bottles; appropriately stain and mount three well-selected sections from each bottle and temporarily label each by means of a little piece of gummed paper, and a pencil or ink.

6. With the compound microscope, using an inch or half-inch, or higher power when needed, examine every set of slides, selecting one or two from each. Those selected must now be marked with a writing diamond and the temporary label removed. Should the student not be sufficiently conversant with the subject to distinguish between the better and the worse slides, all the slides should be put away and the selection made under more favourable circumstances later on in the course. The rejected slides can be recovered as clean slips to be used again.

II.—BY THE PARAFFIN METHOD.

1. Collect and prepare all the parts from which sections have to be taken as before.

2. Bath in paraffin at one operation the entire lot and place the pieces in a wide-mouthed bottle.

3. When convenient embed every piece in paraffin, using, if possible, the embedding L's, though paper boxes will do, or boxes made of capsule metal.

4. Cut away all superfluous paraffin from each tissue, and trim it, in the way already described, ready for cutting.

5. Cut a ribbon or two of sections from each block and place them in a clean, dry chip box, but take care to use a separate box for each piece of tissue. The piece of tissue or block should be placed in the same chip box with the ribbons of sections, taking care to avoid rolling the block over the ribbons.

6. Take three prepared slips and covers for each set of sections and mount and otherwise proceed exactly as in the former case.

Important Notice.—Although I have described the above processes separately as if either by itself would meet all the requirements of the case, in practice it is best to use both processes for the following reasons:—The freezing method enables us to obtain *extensive*

sections; the paraffin method enables us to obtain exceedingly thin sections, perhaps eight times thinner than by the freezing process. Again, where sections would fall to pieces when cut by the freezing method, the paraffin method is a perfect remedy: for instance, transverse sections of intestinal villi can be well made and mounted by the paraffin method; but by the freezing method the villi would be scattered in all directions. Of course when the student works with the very perfect but expensive microtome of Thoma the case is different: then if he requires extensive sections he can get them by the paraffin method, or he can very readily get them by using celloidin. My remarks therefore apply to students in general working with ordinary microtomes.

For a Third Method of embedding see APPENDIX.

PART II.

INTRODUCTION.

Important Notice.—A space is left below each preparation for the student to fill up in describing the stain used : the mounting medium : the date of preparation : what the slide shows, and any other information which is evidently desirable. The slide itself should only have the two sets of figures scratched upon it with a writing diamond ; thus the slide holding the section of the coats of the stomach of a cat will have XX. 2 scratched upon it.

Again, a space is left below each term for the student to fill up in defining the term. *He should fill up these spaces before commencing to study the preparations of the lesson, using a good text-book such as the second volume of Quain's "Anatomy," Klein's "Elements," Schäfer's "Essentials," or Purser's excellent little "Manual." He will then have no need to explain the meaning of these terms when filling up the spaces beneath each preparation.*

The student should first write what he is going to put in his book on a piece of waste paper.

I.—THE VEGETABLE CELL.¹

1. **Yeast.**—Mount a minute drop of yeast without much pressure. Observe, draw, and measure the cells and groups.

2. **Yeast.**—Mount a droplet and stain with solution of magenta.

3. **Yeast.**—Burst the stained cells of the last preparation.

¹ Read Huxley and Martin's *Practical Biology* (Macmillan) for this subject.

4. **Yeast.**—Mount a fresh droplet and stain with solution of iodine which stains the protoplasm brown, not blue (showing absence of starch).

5. **Yeast.**—Mount a fresh droplet and stain with solution of potash.

6. **Yeast.**—Mount a fresh droplet and mount in a moist cell.

7. **German Yeast.**—Spread some on fresh slices of potato.

8. **Tradescantia.**—Place a stamen, taken from a bud on a warm day, in 1 per cent. solution of sugar on a cover-glass inverted over a moist cell.

DEFINITIONS OF TERMS.

A Protein Compound.

Ascospores.

Cellulose.

Endogenous Division of Cells.

Gemmation.

Karyokinesis.

Protoplasm.

Sac.

Torulæ.

Vacuole.

II.—THE ANIMAL CELL.

(AMCÆBÆ AND COLOURLESS BLOOD-CORPUSCLES.)

1. **Amcæbæ.**—(a) Mount a drop of water containing amcæbæ, and observe their size, outline, and structure. (b) Feed with pigment granules and watch the process of ingestion. (c) Make them disgorge with 1 per cent. salt-solution.

2. **Amcæbæ.**—Mount another drop. Mechanically crush to show absence of outer *sac*.

3. **Amcæbæ.**—Mount two drops of water as before on same slip, but under separate covers, and stain one with magenta and the other with iodine.

4. **Human White Blood-Corpuscle.**—Mount a droplet of blood drawn from the finger-tip. Observe size, form, and structure of the white corpuscles. Run dilute acetic acid under the cover-glass.

5. **Human White Blood-Corpuscle.**—Mount other droplets of blood on same slip under two separate covers, and stain one with magenta, the other with iodine.

6. **Human White Blood-Corpuscle.**—Observe the movements of the white corpuscles when heated to 37° C., afterwards to 50° C. on a hot stage.

DEFINITIONS OF TERMS.

Amœba.

Amœboid Movement.

Contractile Vesicle or Vacuole.

Diastole.

Ectosarc.

Endosarc.

Proteus Animalcule.

Pseudopodium.

Systole.

III.—AMPHIBIAN AND HUMAN BLOOD-CORPUSCLES.

1. **Frog.**—Mount without pressure a droplet of blood, and observe, sketch and measure the corpuscles.

2. **Frog.**—Make a double-stained permanent preparation of newt's or Frog's blood.

3. **Human Blood.**—Mount a droplet of human blood (drawn from the finger-tip) without pressure. Observe the varieties, form, method of arrangement, colour, &c., of the corpuscles. Sketch and measure some of the corpuscles.

4. **Human Blood.**—Mount a fresh droplet and run 10 per cent. salt-solution under the cover.

DEFINITIONS OF TERMS.

Amphibian.

Coloured Blood-Corpuscles.

Colourless Blood-Corpuscles.

Lymph-Corpuscles.

Plasma.

Rouleaux.

IV.—ACTION OF REAGENTS ON BLOOD-CORPUSCLES.

1. **Frog.**—Run in distilled water under a cover, inverted over a droplet of blood.

2. **Frog.**—Run in 1 per cent. solution of acetic acid under the cover inverted over a fresh drop of blood.

3. **Frog.**—Place a droplet of blood and a droplet of 2 per cent. boric acid solution close together on a slip, then cover and watch the effects.

4. **Human Blood.**—Run in distilled water under a cover inverted over a droplet of blood.

5. **Human Blood.**—Run in 1 per cent. solution of acetic acid to a fresh droplet.

6. **Human Blood.**—Run in 0·2 per cent. potash solution to a fresh droplet.

7. **Human Blood.**—Place a droplet of 2 per cent. tannic acid solution side by side with a droplet of blood that has been mixed with 0·6 per cent. salt-solution.

DEFINITIONS OF TERMS.

Crenated.

Cholesterin.

Fibrin.

Globulin.

Hæmatin.

Hæmoglobin.

Lecithin.

Nucleus.

Nuclear Network.

Stroma.

V.—EPITHELIUM.

[Epithelium *in situ* occurs in almost half the permanent slides or preparations of histology, so that special preparations may be strictly limited.]

1. **Mouth of Operator.**—Inside of cheek scraped with a blunt blade, scrapings treated with (*a*) salt-solution, (*b*) acetic acid, (*c*) silver nitrate.

2. **Rabbit.**—Intestinal (columnar) epithelium from small intestine.

3. **Rabbit.**—Transitional epithelium from bladder.

4. **Frog.**—Ciliated epithelium from roof of mouth.

5. **Oyster.**—Gill of fresh oyster, piece of.

DEFINITIONS OF TERMS.

Cilia.

Columnar Epithelium.

Columnar Ciliated.

Columnar Non-Ciliated.

Compound Epithelium.

Cylindrical Epithelium.

Glandular Epithelium.

Goblet Cells.

Prickle Cells.

Scaly Epithelium.

Simple Epithelium.

Squamous Epithelium.

Stratified Epithelium.

Transitional Epithelium.

VI.—AREOLAR AND ADIPOSE TISSUE.

1. **Rabbit.**—Subcutaneous tissue stained with silver.

2. **Rabbit.**—Subcutaneous tissue stained with picrocarmine.

3. **Rabbit.**—Subcutaneous tissue stained with magenta.

4. **Rabbit.**—Subcutaneous tissue examined in salt-solution.

5. **Rabbit.**—Subcutaneous tissue irrigated with 1 per cent. acetic acid.

6. **Rat.**—Subcutaneous tissue of a young rat examined in salt-solution. It will contain fat.

7. **Rat.**—Subcutaneous tissue prepared with picric acid and stained.

DEFINITIONS OF TERMS.

Areolæ.

Ground Substance.

Plasma Cells.

Stellate Cells.

Wandering Cells.

VII.—WHITE FIBROUS AND YELLOW ELASTIC TISSUES.

1. **Calf.**—Transverse and longitudinal sections through tendo Achilles.

2. **Mouse.**—Tail tendon stained with logwood.

3. **Mouse.**—Tail tendon stained with silver.

4. **Horse.**—Fibres of ligamentum nuchæ teased in salt-solution.

5. **Horse.**—Section across fibres of ligamentum nuchæ.

6. **Horse.**—Section parallel with fibres of ligamentum nuchæ.

DEFINITIONS OF TERMS.

There are no special terms used in connection with these two forms of connective-tissue, but their localities are of special importance.

Where is white fibrous tissue found, and what are its functions?

Where is yellow elastic tissue found, and what are its functions?

VIII.—CARTILAGE.

1. **Horse.**—Vertical section of a tracheal ring.
2. **Horse.**—Transverse section of a costal cartilage.

3. **Horse.**—Section vertical to surface of the epiglottis.

4. **Pig.**—Section vertical to surface of ear-lobe.

5. **Horse.**—Section of intra-articular cartilage of stifle joint.

6. **Rat.**—Section of head of femur including a little of the subjacent bone.

7. **Cuttle-Fish.**—Section of a piece of the head cartilage.

DEFINITIONS OF TERMS.

Articular Cartilage.

Cartilage Capsule.

Cartilage of Incrustation.

Cell Territories.

Costal Cartilage

Elastic Cartilage.

Hyaline.

Intercellular Substance.

Perichondrium.

Reticular.

White Fibro-Cartilage.

Yellow Fibro-Cartilage.

IX.—BONE.

1. **Sheep.**—Section vertical to surface of the shin-bone ground down on a hone, &c.

2. **Sheep.**—Section vertical to surface of the shin-bone decalcified.

3. **Sheep.**—Longitudinal section of a decalcified shin-bone.

4. **Horse.**—Shreds from deepest part of periosteum of a decalcified parietal bone.

5. **Guinea-Pig.**—Red marrow taken from a broken (not sawn) rib of a young guinea-pig.

DEFINITIONS OF TERMS.

Canaliculi.

Cementing Substance.

Circumferential Lamellæ.

Compact Bone.

Endosteum.

Giant Cells.

Haversian Canals.

Haversian Lamellæ.

Haversian Systems.

Interstitial Lamellæ.

Lamellated.

Myeloplaxe.

Perforating Fibres of Sharpey.

Periosteum.

Spongy Bone.

X.—DEVELOPMENT OF BONE.

1. **Kitten.**—Section through the ramus of the jaw of a newly-born kitten.

2. **Kitten.**—Longitudinal section through a metacarpal bone of a newly-born kitten.

3. **Fœtal Mouse.**—Parietal bone.

DEFINITIONS OF TERMS.

Bone-Corpuscles.

Epiphysal Cartilage.

Intermediate Cartilage.

Matrix.

Ossification.

Ossification, Endochondral.

Ossification, Intra-cartilaginous.

Ossification, Intra-membranous.

Osteoblast.

Osteoclast.

Osteogenetic Fibres.

XI.—MUSCLE.

[**Note.**—Sections of the striated muscle are well seen in the tongue and in numerous other preparations.

Except in making the following special preparations I would advise a complete study of living muscle during the physical or graphic course of physiology.]

1. **Rabbit.**—Bits of unstriped muscle-fibre torn from the colon of the rabbit.

2. **Frog.**—Bladder of frog (piece of).

3. **Newt.**—Mesentery of newt.

4. **Mouse.**—Transverse section through the ventricles of the heart.

5. **Rat.**—Vertical transverse sections of the tongue injected with carmine-gelatine.

DEFINITIONS OF TERMS.

Cohnheim's Fields.

Contractile Substance.

Disks.

Endomysium.

Fibres.

Fibrils.

Perimysium.

Plain Muscle-Fibre.

Primitive Muscle-Bundle.

Primitive Muscle-Cylinder.

Sarcolemma

Sarcous Element.

Unstriped Element.

XII.—NERVE-FIBRES.

1. **Horse.**—Transverse and longitudinal sections of the metacarpal nerve.

2. **Horse.**—Teased fragments after treatment by osmic acid.

3. **Mouse.**—Short lengths of one of the lateral cutaneous branches of the intercostal nerve.

4. **Frog.**—Sciatic nerve, fresh, examined in salt-solution.

5. **Frog.**—Sciatic nerve treated with osmic acid.

DEFINITIONS OF TERMS.

Axis Cylinder.

Lanternman's Notches.

Medullated.

Medullary Sheath.

Myeline.

Neurilemma.

Ranvier's Constrictions.

Ranvier's Internodes.

Sheath of Mauther

Sheath of Schwann.

White Substance of Schwann.

XIII.—BLOOD-VESSELS.

1. **Horse.**—Transverse section metacarpal artery and vein.

2. **Horse.**—Transverse section artery and vein of mesentery.

3. **Rabbit.**—Piece of omentum cut out, which contains vessels that can be seen.

4. **Frog.**—Capillaries with artery, vein, pigment-cells, &c., seen on watching circulation in the web.

5. **Rabbit.**—Arteries and capillaries of omentum, silvered.

6. **Rabbit.**—Endothelium of humeral artery, silvered.

DEFINITIONS OF TERMS.

External, Middle, and Internal Coat.

External Elastic Lamina.

Internal Elastic Lamina.

Valves of Veins.

Vasa Vasorum.

XIV.—LYMPH SPACES AND CHANNELS.

1. **Frog.**—Septum cisterna lymphatica magna, silvered.

2. **Rabbit.**—Part of peritoneal surface of diaphragm of rabbit, silvered.

3. **Rabbit.**—Central tendon of diaphragm of rabbit (pleural side), brushed and silvered.

DEFINITIONS OF TERMS.

Endothelium.

Germinating Cells.

Intercellular Cement Substance.

Juice Canals.

Lymph.

Lymph Capillaries.

Lymph Spaces.

Stomata.

XV.—LYMPHATIC GLANDS, TONSILS,
AND THYMUS.

1. **Rabbit.**—Section of a lymphatic gland, silvered.

2. **Horse.**—Section of axillary gland.

3. **Dog.**—Section of tonsil.

4. **Child.**—Section of thymus of child under six months.

DEFINITIONS OF TERMS.

Adenoid Tissue.

Afferent Lymphatic Vessel.

Capsule.

Cortical Follicle.

Efferent Lymphatic Vessel.

Lymph Path.

Lymphoid Cells.

Trabeculæ.

XVI.—SKIN, HAIR, AND NAILS.

1. **Human.**—Section vertical to surface of skin, and subcutaneous tissue of the palmar surface of a finger-tip.

2. **Human.**—Section like the last treated with gold chloride.

3. **Human.**—Section vertical to surface of the skin of the scalp.

4. **Human.**—Section horizontal to surface of the skin of the scalp.

5. **Sheep.**—Section vertical to surface of hoof of sheep.

DEFINITIONS OF TERMS.

Arrectores Pili.

Ceruminous Gland.

Corium.

Cuticle.

Cutis.

Epidermis.

External and Internal Root-Sheath.

Hair-Bulb.

Hair-Follicle.

Henle's Layer.

Horny Layer.

Huxley's Layer.

Medulla of Hair.

Meissner's Tact-Corpuscles.

Mucous Layer.

Pacinian Corpuscles.

Papillæ.

Pith of Hair.

Sebaceous Gland.

Shaft of Hair.

Stratum Corneum.

Stratum Granulosum.

Stratum Lucidum.

Stratum Malpighi.

Stratum Mucosum.

Stratum Spinosum.

Sudoriparous Gland.

Sweat Gland.

True Skin.

XVII.—TRACHEA, BRONCHI, AND LUNGS.

1. **Cat.**—Section vertical to inner surface and through an entire tracheal ring.

2. **Cat.**—Section vertical to inner surface and through the cartilages of two or more rings.

3. **Kitten.**—Section vertical to and including pleura of lung with alveolar epithelium, silvered.

4. **Rat.**—Section across a medium-sized bronchial tube of lung injected with carmine gelatine *via* pulmonary artery.

5. **Rat.**—Section vertical to and including pleura of a lung injected like the last.

DEFINITIONS OF TERMS.

What is the Trachea ?

What are the Bronchial Tubes ?

What are the Lungs?

What is the Pleura?

Alveolar Passages.

Alveoli.

Fibrous Layer of Trachea.

Infundibula.

Lobes of Lung.

Lobules of Lung.

Lobular Bronchi.

Lymphatics (Peribronchial, Perivascular, Sub-pleural).

Pulmonary Acinus.

Trachealis Muscle.

XVIII.—THE TEETH AND TONGUE.

1. **Cat.**—Vertical section through decalcified jaw and tooth.

2. **Human.**—Section of a canine or incisor ground on a hone, &c.

3. **Kitten.**—Vertical section through jaw and tooth of a newly-born kitten. See X. 1, *ante*.

4. **Cat.**—Transverse section entire tongue.

DEFINITIONS OF TERMS.

Cement substance.

Crown, Neck, and Fang.

Crusta Petrosa.

Dental Sac.

Dentine.

Enamel.

Enamel Organ.

Odontoblasts.

Papilla.

Peridontium.

Pulp.

Pulp Cavity.

XIX.—THE SALIVARY GLANDS AND THE PANCREAS.

1. **Rabbit.**—Transverse section of the submaxillary gland. This is a true salivary gland.

2. **Dog.**—Transverse section of the submaxillary gland. This is a true mucous gland.

3. **Guinea-Pig.**—Transverse section of the submaxillary gland. This is a muco-salivary gland.

4. **Dog.**—Section of a piece of the pancreas of a fed dog.

5. **Dog.**—Section of a piece of the pancreas of a fasting dog.

DEFINITIONS OF TERMS.

There are no very special terms in connection with these glands.

XX.—ŒSOPHAGUS, STOMACH, AND
DUODENUM.

1. **Dog.**—Transverse section of œsophagus.

2. **Cat.**—Section through coats of stomach.

3. **Dog.**—Vertical sections through the mucous membrane of the stomach (1. cardiac, 2. middle, 3. pyloric end) of a fed dog.

4. **Dog.**—Vertical sections through the mucous membrane of the stomach (like the last) of a fasting dog.

5. **Rat.**—Section through the coats of the stomach of a rat injected with carmine gelatine (blood-vessels).

6. **Pig.**—Transverse section of duodenum of a pig.

DEFINITIONS OF TERMS.

Adventitious Coat.

Brunner's Glands.

Chief or Central Cells.

Muscularis Mucosa.

Parietal Cells.

Tunica Mucosa.

Tunica Muscularis.

Tunica Serosa.

Tunica Submucosa.

XXI.—SMALL AND LARGE INTESTINES.

1. **Fig.**—Transverse section (vertical to mucous membrane) of jejunum of pig.

2. **Fig.**—Horizontal section of mucous membrane of jejunum of pig.

3. **Fig.**—Transverse section (vertical to mucous membrane) through a Peyer's patch.

4. **Frog.**—Vertical section through mucous membrane of intestine of frog fed with bacon-fat.

5. **Rat.**—Transverse sections through duodenum, jejunum, and colon of a rat with blood-vessels injected with carmine gelatine.

6. **Rat.**—Strips of longitudinal muscular coat with Auerbach's plexus (stained with gold) adherent.

DEFINITIONS OF TERMS.

Absorption by Villi.

Adenoid Tissue.

Agminated Glands.

Auerbach's Plexus.

Chyle-Vessels.

Intestinal Villi.

Lieberkühn's Glands or Follicles.

Meissner's Plexus.

Myenteric Plexus.

Peyer's Patches.

Solitary Glands.

XXII.—THE LIVER.

1. **Frog.**—Fresh section of liver, fed frog. Tease and isolate cells and observe shape, appearance, &c., then irrigate with 1 per cent. acetic acid.

2. **Pig.**—Section of liver vertical to the surface including capsule.

3. **Pig.**—Section parallel to the surface.

4. **Dog.**—Section parallel to surface (fed dog).

5. **Dog.**—Section parallel to surface (fasting dog).

6. **Rat.**—Section of carmine-gelatine injected liver (blood-vessels).

7. **Rat.**—Section of carmine-gelatine injected liver (bile-ducts).

DEFINITIONS OF TERMS.

What is the Liver ?

Bile-Capillaries.

Bile-Ducts.

Capsule of Glisson.

Hepatic Cell.

Hepatic Lobule.

Hepatic Vein.

Interlobular Vein.

Intralobular Vein.

Portal Vein.

Sublobular Vein.

XXIII.—THE DUCTLESS GLANDS.

1. **Dog.**—Transverse section of spleen of a fed dog.

2. **Dog.**—Transverse section of spleen of a fasting dog.

3. **Horse.**—Transverse sections of the supra-renal capsules.

4. **Child.**—Section vertical to surface of the thyroid body.

DEFINITIONS OF TERMS.

I. SPLEEN.

Capsule.

Malpighian Bodies.

Pulp.

Trabeculæ.

II. SUPRA-RENAL BODIES.

Cortex.

Medullary Portion.

Zona Fasciculata.

Zona Glomerulosa.

Zona Reticularis.

III. THYROID BODY.

Acini or Alveoli.

XXIV.—THE URINARY ORGANS.

(*Kidneys.*)

1. **Mouse.**—Horizontal section through entire length of a kidney.

2. **Rabbit.**—Vertical section through entire breadth of a kidney.

3. **Rabbit.**—Vertical section through the cortex.

4. **Rabbit.**—Vertical section through medullary rays.

5. **Rabbit.**—Vertical section through a papilla.

6. **Rat.**—Vertical section through the entire breadth of kidney, injected with carmine gelatine.

DEFINITIONS OF TERMS.

What is a Kidney ?

Capsule of Kidney.

Capsule of Bowman.

Columns of Bertini.

Convolutions of Tubes and their Names.

Ferrein's Pyramids.

Glomerulus.

Henle's Limbs, Loops.

Labyrinth.

Malpighian Bodies.

Malpighian Pyramids.

Medullary Portion.

Medullary Rays.

Papillæ.

Pelvis of Kidney.

Vas Afferens, Vas Efferens, Vas Recta, Venous
Arches.

XXV.—THE URINARY ORGANS
(*continued*).

(*Ureter, Bladder, and Male Generative Organs.*)

1. **Horse.**—Ureter in transverse section.
2. **Guinea-Pig.**—Transverse section of bladder.
3. **Child.**—Section of prostate gland.

4. **Child.**—Transverse section of penis.

5. **Rat.**—Transverse section of testis and epididymis.

6. **Rat.**—An incision into globus major for spermatozoa.

7. **Newt.**—Spermatozoa.

DEFINITIONS OF TERMS.

Coni Vasculosi.

Convolved Tubes.

Corpus Highmori.

Mediastinum Testis.

Rete Testis.

Tunica Albuginea.

Tunica Vaginalis.

Vas Aberrans.

Vas Deferens.

Vasa Efferentia.

XXVI.—THE FEMALE GENERATIVE
ORGANS.

(*Ovary, Fallopian Tubes, Uterus, Vagina, Mammary
Gland.*)

1. **Sheep.**—Ovum of sheep.
2. **Kitten.**—Section of ovary of newly-born kitten.

3. **Rabbit.**—Section of ovary of a year-old rabbit.

4. **Horse.**—Transverse section of a Fallopian tube.

5. **Cat.**—Transverse section through body of uterus.

6. **Cow.**—Horizontal section through one side of cervix uteri.

7. **Cat.**—Sections of mammary gland during lactation.

DEFINITIONS OF TERMS.

Clitoris.

Corpus Luteum.

Cortical Portion.

Discus Proligerus.

Follicle.

Germinal Epithelium.

Germinal Spot.

Germinal Vesicle.

Glands of Bartholinus.

Graafian Follicle.

Liquor Folliculi.

Medullary Portion.

Membrana Granulosa.

Ovum.

Primordial Ova.

Stroma.

Tunica Albuginea.

Vestibule.

Yolk.

Zona Parenchymatosa.

Zona Pellucida.

Zona Vasculosa.

XXVII.—TERMINATIONS OF NERVE-FIBRES.

1. **Cat.**—Pacinian body from meso-rectum of cat.

2. **Cat.**—Longitudinal section of a Pacinian body from meso-rectum of cat.

3. **Duck.**—Section vertical to the surface of the tongue of a duck.

4. **Rat.**—Section like the last.

5. **Frog.**—Entire pectoral muscle of a small frog.

DEFINITIONS OF TERMS.

End-Bulb.

End-Plate.

Pacinian Corpuscle.

Tactile Corpuscle.

XXVIII.—THE SPINAL CORD, NERVE-CELLS, AND GANGLIA.

1. **Dog.**—Transverse sections of the spinal cord in the cervical, dorsal, and lumbar regions.

2. **Horse.**—Nerve-cells of the anterior horn of the cord.

3. **Frog.**—Sympathetic ganglia. (Foster, 113.)

4. **Frog.**—Spinal ganglia.

5. **Dog.**—Transverse and longitudinal section of a dorsal spinal ganglion.

DEFINITIONS OF TERMS.

Anterior and Posterior Median Fissures of the
Cord.

Anterior or White Commissure.

Apolar Cell.

Bipolar Cell.

Central Canal of the Spinal Cord.

Cornua of the Cord.

Ganglion.

Gelatinous Substance of the Cord.

Grey Matter of the Cord.

Lateral Grey Masses.

Multipolar Cells.

Posterior or Grey Commissure.

Posterior Median Fissure of the Cord.

Processus Reticularis.

Tractus Intermedio Lateralis.

Unipolar Cell.

Ventriculus Terminalis.

XXIX.—ORGANS OF TASTE AND SMELL.

1. **Rabbit.**—Vertical section of papilla foliata of the tongue passing *across* the foliæ.

2. **Rabbit.**—Teased preparations of a taste-bud of the rabbit's tongue.

3. **Dog.**—Transverse section of nasal septum.

4. **Dog.**—Teased preparation of olfactory epithelium.

5. **Frog.**—Teased preparation of olfactory epithelium.

DEFINITIONS OF TERMS.

I. TASTE.

Taste-Buds.

The two kinds of Cells.

II. SMELL.

Olfactory Region.

The three kinds of Cells.

Membrana Limitans Olfactoria.

Bowman's Glands.

Organ of Jacobson.

DEFINITIONS OF TERMS.

I. EYELIDS.

Cilia.

Glands of Moll.

Meibomian Glands.

Tarsal Cartilage.

II. CONJUNCTIVA.

Caruncula Lachrymalis.

End-Bulbs of Krause.

III. CORNEA.

Bowman's Membrane.

Fibræ Arcuatæ.

Descemet's Membrane.

Lamellæ

Proper Tissue of the Cornea.

IV. SCLEROTIC.

Canal of Schlemm.

Funiculus Scleræ.

4. **Frog.**—Section of retina.

5. **Fig.**—Section of retina, including fovea centralis.

DEFINITIONS OF TERMS (*continued*).

V. CHOROID AND IRIS.

Circulus Iridis Major and Minor.

Chorio Capillaris.

Lamina Fusca.

Ligamentum Pectinatis Iridis.

Membrana Suprachoidea.

Orbicularis Ciliaris.

Proper Tissue of the Choroid.

Spaces of Fontana.

Stratum Vasculosum.

The two portions of the Iris.

Vasa Vorticosa.

Vitreous Layer.

VI. VITREOUS BODY AND RETINA.

Canal of Petit.

Fovea Centralis.

Layers of the Retina (name them in their order).

Macula Lutea.

Optic Papilla.

Ova Serrata.

Physiological Excavation.

Zone of Zinn.

XXXII.—ORGANS OF HEARING.

1. **Skate.**—Sections across one of the semicircular canals.

2. **Skate.**—Longitudinal section through an ampulla.

3. **Guinea-Pig.**—Vertical section through the middle, parallel with long axis, of the cochlea.

DEFINITIONS OF TERMS.

Ampulla.

Auditory Hairs.

Basilar Membrane.

Canal of Cochlea.

Cells of Deiters.

Columella.

Cristæ.

Endolymph.

Fibre-Cells of Retzius.

Hair-Cells.

Helicotrema.

Inner Hair-Cells.

Limbus.

Maculæ.

Membrane of Reissner.

Membrana Tectoria.

Organ of Corti.

Otoliths.

Outer Hair-Cells.

Perilymph.

Reticular Lamina.

Rods of Corti.

Sacculæ.

Scala Tympani.

Scala Vestibuli.

Semicircular Canals.

Spiral Lamina.

Spiral Ligament.

Tunica Propria.

Utricle.

XXXIII.—THE BRAIN AND MEDULLA OBLONGATA.

1. **Dog.**—Section vertical to the surface of the medulla oblongata at the decussation of the pyramids.

2. **Dog.**—Section vertical to the surface of the medulla oblongata through the middle of the olivary bodies.

3. **Dog.**—Section vertical to the surface of the medulla oblongata just above the olivary bodies.

4. **Dog.**—Section vertical to the surface through the entire cerebellum.

XXXIV.—THE BRAIN AND MEDULLA
OBLONGATA (*continued*).

1. **Man.**—Section vertical to the surface and through a cerebral convolution.

2. **Rat.**—Section through entire head of a rat just behind the eyes.

3. **Rat.**—Section through entire head of a rat at its thickest part.

4. **Rat.**—Section through entire head of a rat carried through the cerebellum.

APPENDIX.

Embedding in Gum and Glycerine.—If the best glycerine be added to the mucilage of gum acacia (B.P.), a transparent, infiltrating embedding mass is formed much superior, for our purposes, to any other. In late spring, during the summer, and in early autumn weather the proportion of glycerine to be added is 10 per cent. To the mixture 1 per cent. of carbolic acid crystals should be added to keep it.

The mixture is used by being exposed, whilst the tissues are in it, to the sun and air just inside the closed window of the laboratory. In four days a tough mass results, when the tissues are to be cut out in blocks, and these blocks are then turned over for further exposure. By the seventh day each block will have become tough enough for cutting, and may therefore be fixed upon a cork, or piece of wood, either by ordinary melted glue or by gum mucilage without any glycerine in it. In the latter case the adhesion obtained will permit of sections being cut next day.

A Third Short Method of collecting and cutting all the Tissues required in this Course (see p. 204).—If the tissues be collected, placed whilst fresh in picric acid solution for seven hours, then in repeated changes of 75 per

cent. alcohol for a week, they may be placed in gum and glycerine mixture contained in watch-glasses, dug out singly as blocks on the fourth day, gummed on corks on the seventh day, and cut on the eighth or on any subsequent day one finds it most convenient as they never become too hard. Whilst in the watch-glasses they must be kept well under the gum and far enough apart to permit of a periphery of embedding mass an eighth of an inch broad being left to each block.

Whilst cutting the knife must be moistened with methylated spirit of full strength but the sections are to be landed with a camel-hair brush into 70 per cent. methylated spirit. The embedding mass can either be retained during staining if a stain containing 70 per cent. alcohol be used, or the gum can first be removed by placing the sections in water.

I have not given this as a method in the body of the book, because in winter and in very wet weather the proportion of glycerine has to be ascertained, but will vary from 6 to 10 per cent. However, the student may still use this method with comparative ease in any weather thus: At the same time as the tissues are put to harden boil until tough a piece of liver or kidney and place pieces a twelfth of an inch thick in five watch-glasses filled with the mixture containing respectively 6, 7, 8, 9, and 10 per cent. of glycerine, and proceed as above directed, and try which cuts best. The gum-solution, some Price's glycerine, and a 10 c.c. measure-glass will be required and great care exercised in the proportions, washing out with tap-water the measure-glass between each set of measurements.

This mass is like paraffin in its infiltrating and cell and fibre supporting properties: it is superior to paraffin in that it may be used without perfect hardening of the tissues and

saves the tissues from cell-shrinking reagents if we prefer that this should be so. Indeed we need go no higher in the scale of strength than 50 per cent. alcohol, and when fat is to be preserved in cells we can avoid all alcohol. The facility of removal of the embedding material is also obvious. With a knife held in a frame and moved obliquely as fine sections can be got and almost as readily as with paraffin infiltration.

For those whose means will not afford a Thoma's microtome a well-microtome can be used if the cork has white wax and olive oil embedding mass poured around it. The corks indeed can be fixed by some simple means in any microtome by a little exercise of ingenuity.

NOTICE.—If the gum and glycerine blocks be secured by freezing on a microtome by ordinary gum mucilage, sections of any degree of thinness and area may be obtained with the plane iron.

INDEX.

A

Adipose tissue, 232
 Alcohol, 93, 95
 Ammonia, bichromate of, 98
 Ammonia, chromate of, 98
 Amœbæ, 202
 Amphibian blood, 220
 Anæsthetising, 60
 Animal cell, 216
 Appendix, 357
 Applying gases and vapours, 64
 Areolar tissue, 232
 Asphalt, 37

B

Balsam, bottle for, 51
 Battery, constant, 32
 Bile-ducts, to inject, 86
 Bladder, 313
 Blood, amphibian, 220
 „ human, 220
 „ corpuscles, action of reagents on,
 223
 „ vessels, 260
 „ „ to inject, 77
 Blue injection-mass, 63
 Bone, 243
 „ development of, 248
 Borax-carmine, 134

C

Calf, material from, 166
 Camera, 31
 Camera-lucida, 24
 Carmine brightening fluid, 135
 Carmine-gelatin mass, 66
 Cartilage, 238
 Cell, animal, 216
 „ making, 59
 „ vegetable, 211

Celloidin, 46
 Chemicals, list of, 43
 Choice out-fits, 19
 Chrisma, 46
 Chromic and nitric fluid, 99
 Clearing, 142
 Collecting material, 162
 Compound microscope stand, 3
 Constant battery, 32
 Cover-glasses, applying, 144
 „ „ cells for, 56
 „ „ cleaning, 57
 „ „ measuring, 36
 Cuttle-fish, 190

D

Dehydrating, 142
 Developing bone, 248
 Diary essential, 2
 Dissection of mammal, 88
 Dissociating fluids, 62
 Drawing materials, 48
 „ microscopic objects, 24
 Dry lenses, 10
 Ductless glands, 303
 Duodenum, 289

E

Ehrlich's hæmatoxylin, 133
 Embedding, 102
 „ in carrot, 104
 „ in celloidin, 114
 „ in gum mucilage, 116
 „ in gum and glycerine, 357
 „ in paraffin, 106, 112
 „ in wax and oil, 105, 112
 Eosin, 136
 Epithelium, 227
 Erlicki's fluid, 93
 Eye-pieces, 7

- F**
- Fallopian tubes, 317
 Farrant's medium, 48
 Fibrous tissue, 235
 Freezing method, 204
 Frog-holder, 57, 195
- G**
- Ganglia, 327
 Gas bottle, 39
 Gas cell, 55
 Gases and vapours, applying, 64
 Gelatine, 46
 Generative organs, female, 317
 " " male, 313
 Glass slips, 36
 " " cleaning, 57
 " syringe, 41
 " tubing, 41
 " working, 53
 Glycerine jelly, 48
 Gold chloride solution, 135
- H**
- Hair, 269
 Hardening, 93
 Hearing, organs of, 346
 High-power lenses, 10
- I**
- Immersion lenses, 11, 14
 Index needful, 2
 Injecting, 65
 Injecting bath, 69
 Irrigating, 63
- K**
- Kidneys, 307
 Klein's fluid, 97
 " " hardening in, 97
- L**
- Laboratory, the, 1
 Lamp for microscope, 7
 Lenses, 10
 List of chemicals, 43
 Liver, to inject, 86
 Lungs, 278
 " to inject, 84
 Lymph glands, 266
 Lymph spaces and channels, 263
- M**
- Magnifying power and angles of lenses, 3
 Magnifying power of the microscope, 21
 Male generative organs, 313
 Mammary gland, 317
 Material, collecting, 162
 Measure-glasses, 42
 Measuring microscopic objects, 23
 Medulla oblongata, 354, 356
 Methods of collecting material, 204, 207
 Microscope, lamp for, 7
 " stands, 3, 34
 Microtome, the, 37
 Microtomes, 125-130
 Mitchell's logwood, 133
 Moist chamber, 57
 Mounting, 144
 " block, 55
 " cell, 56
 " in balsam, 148
 " in Farrant, 146
 " in glycerine jelly, 147
 " in watery media, 147
 Muller's fluid, 96
 " " hardening in, 96
 Muscle, 251
- N**
- Nails, 269
 Nerve-cells, 327
 " fibres, 256
 " terminations, 324
 Normal fluids, 61
- O**
- Oculars, 7
 Oesophagus, 289
 Oil-immersion lenses, 18
 Organs of hearing, 346
 " of taste and smell, 333
 " of vision, 336, 340
 Osmic acid solution, 100, 136
 Ovaries, 317
- P**
- Pancreas, 287
 Paraffin method, 206
 " wax, 46
 Photographic materials, 48
 Photomicrography, 29
 Pieric acid, 93
 Piero-carmin, 135
 Powers, 7
 Practical exercises, 150
- R**
- Ranvier's alcohol, 95
 Reagent bottles, 39
 Ringing slides, 58

- S
- Salivary glands, 287
 Section-cutting, 117
 " " in carrot, 120
 " " in frozen gum, 123
 " " in paraffin, 122
 " " in wax and oil, 121
 Section transferring, 124
 Silver-nitrate solution, 135
 Skin, 269
 Slips, 36
 Smell, organs of, 333
 Spinal cord, 327
 Spleen, 304
 Stand-condenser, 5
 Staining, 132
 " in aniline dyes, 139
 " in borax-carmin, 137
 " in Ehrlich's hæmatoxylin, 136
 " in eosin, 138
 " in gold chloride, 138
 " in Mitchell's logwood, 137
 " in picro-carmin, 137
 " in silver-nitrate, 139
 " sections on slips, 140
 Stains, list of, 44
 Stomach, 289
- T
- Table of amplifications, 22
 Taste, organs of, 333
 Teasing, 61
 Teeth, 283
 Thymus gland, 266
 Thyroid body, 306
- Tongue, 283
 Tonsils, 266
 Trachea, 278
 Tradescantia, 200
- U
- Ureters, 313
 Uterus, 317
- V
- Vagina, 317
 Vapour cell, 55
 Vegetable cell, 211
 Vision, organs of, 336, 340
- W
- Warm stage, 37, 65
 Wash-bottle, 38
 Water-bath, 42
 Working powers, 7
- X
- Xylol balsam, 50
- Y
- Yeast, 201
 Yellow elastic tissue, 235
- Z
- Zinc-cement, 53

THE END.



QM555

F31

Fearnley

A course of elementary practical
histology.

--	--	--

1850

1850

1850