

*

UMASS AMHERST

*



312066 0287 2854 7



UNIVERSITY LIBRARY
UNIVERSITY OF MASSACHUSETTS
LIBRARY
AT
AMHERST

3



CRANBERRIES

THE NATIONAL CRANBERRY MAGAZINE
January 1989
Vol. 53, No. 1

Polish
Researcher
Visits
Wisconsin

My
First
Cooking
Contest

How to Run
A Successful
Family
Business

S



BARK RIVER ATLANTIC TO PACIFIC!

Since we began producing culvert pipe in 1906, we've produced enough to cross the country from Atlantic to Pacific.
IT'S A FACT!

And with our Spiral Mill Plant we have high volume capacity and versatile product capacity. We produce standard (2 2/3" x 1.2") culvert in round from 12 to 72 inches and pipe arch from 12 to 72 inches, and special culvert corrugation allowing production of pipe arches to 144 inches and pipe arch up to 192 inches. Structural plate culvert is available in pipe arch sizes up to a 40' feet span. We've come a long way in 77 years.
CAN WE HELP YOU THIS YEAR?

BARK RIVER



ALABAMA
ALBANY, GA.
ALBANY, N.Y.
ALBANY, N.Y.
ALBANY, N.Y.
ALBANY, N.Y.

ALBANY, N.Y.
ALBANY, N.Y.
ALBANY, N.Y.
ALBANY, N.Y.
ALBANY, N.Y.
ALBANY, N.Y.

Polish Researcher Plans to Introduce Cranberry Production to His Country

Pawel Wasiak is nuts about cranberries.

The tall, soft-spoken researcher is so interested in the tart, bright-red fruit that he left his native Poland for three months last summer to work and study in the cranberry marshes of central Wisconsin.

There really is no such thing as a cranberry industry in Poland. A few native, wild varieties of cranberries exist, but nothing has yet been done to manage them for greater yield. In fact, Wasiak works at the only experimental station studying cranberries in eastern Europe.

"In my town in northern Poland, there is no problem getting cranberries during October and November," Wasiak said, because his experimental station is marketing its crop then. "There is demand for cranberries. People like. But, very few cranberries sold elsewhere. In Warsaw, to the south, people can buy native varieties but they are very expensive."

All fruit in Poland is harvested for fresh use. None is processed for juice because the crop is so small. People do go out and pick the native cranberries, but Wasiak likened this hand harvesting to a scene from a Wisconsin marsh generations ago. The United States, and specifically Wisconsin, has an almost centuries-old tradition of cranberry cultiva-

tion. And that's what Wasiak was looking for last summer: the expertise gained over time by agricultural experts here.

The Warrens, Wisc., marsh that became his temporary home last summer is operated by Northland Cranberries, Inc. of Wisconsin Rapids. Northland is publicly owned and the biggest grower in the state. Its nine marshes have a total of 656 acres in production.

Wasiak and Northland were a good match because of the company's commitment to modern techniques of agronomy. Also, its varied marshes, scattered throughout central and northern Wisconsin, provided a smorgasbord of vine types and growing conditions for Wasiak to observe.

RESEARCHER Pawel also is a dreamer. Get him talking about cranberries and you'll find he's determined to make them part of the Polish diet. He can visualize a booming cranberry business in Poland where now there is none. He thinks beyond the issue of national politics, too, believing it will take a strong economic system for Poland to realize and nurture

what Wasiak sees as tremendous potential for private industry there.

Wasiak has an entrepreneurial spirit and is certain that cranberries—fresh fruit as well as juice—can be big in Poland. He would like to plant his own 1-acre commercial marsh, perhaps next year.

"Cranberries in Poland can some day be very good business because of high price, big population and not much competition," he said.

While Wasiak would like to build his own cranberry business, he is a realistic man. He knows it will take time. Building a strong economic system in his country also will play a role.

"Must be good economic system," he said. "If that is there, everything is good."

"I can wait 10, 20 years to have cranberries. Maybe for my son, Peter. He is very interested for being just 11 years old. He already works on the experimental marsh."

Wasiak, 35, is from Szczecinek, Poland, a town of 40,000. His wife, who specializes in plant disease and insect control, works with him there. His experimental marsh is supported by the nearby Institute

COVER

POLISH researcher Pawel Wasiak holds a big, bright, red Wisconsin cranberry 'twixt his thumb and index finger. Wasiak spent last summer at Northland Cranberries in Warrens and hopes to transfer the fruits of his research to his native land. A story about the Polish visitor starts on this page.

Vigorous — Hearty — Extremely Productive

STEVENS VINES

Spring 1989 Delivery

**Priced at the market, 10% now
will guarantee delivery**

Saddle Mound Cranberry Co. Call:
105 Old Hwy 54
Pittsville, WI 54466

Jay Normington
715/593-2326

Pete Normington
715/593-2350

of Pomology in Skierniewice.

Wasiak's 25 acre research station is home to about 20 varieties of hybrid vines, including some that originally came from Wisconsin. His studies in Poland focus on new vine varieties, plus use of pesticides, fungicides and herbicides. The station is only six years old. Since it takes about five years for cranberry vines to become fully productive, much of his work is in its infancy.

THE CHURCH of the Brethren in Elgin, Ill., played a key role in bringing Wasiak to Wisconsin for the summer. According to W. Lamar Gibble, director of the Brethren Service/Polish Agricultural Exchange Program, the church arranges for 50 to 60 Polish scientists to come to the United States each year. In turn, U.S researchers study in Poland. He added that these exchanges have been made for more than 30 years, even while cold wars were blazing and the two governments had no official relations.

This spring, Northland responded

to an appeal made to Wisconsin cranberry growers by the exchange program. The church was seeking a marsh for Wasiak to work and learn at.

John Swendrowski, Northland Cranberries president, liked Wasiak's strong research background and offered to help.

"We're very committed to taking a scientific approach to growing cranberries and have our own agronomist on staff," Swendrowski said. "Anytime two scientists work together, I believe both can benefit. So we decided to host Pawel."

Swendrowski also had personal reasons for making the exchange.

Law Offices of
James Taylor Pye

James Taylor Pye
David Churchill Barrow
James S. Hartford

24 Bay Road/P.O. Box 2899
Duxbury, Massachusetts 02331
617-934-6575

Bog renovation and Bog development
(Conservation Commission, DEQE, Mass EPA, EPA and Corps of Engineers)

Business, retirement and estate planning
(Incorporations and partnerships, pensions and profit sharing plans, and Wills and Trusts)

Land disposition
(Purchase, sale and financing of existing bogs and potential sites)

Land use management
(Board of Appeals and Planning Board)

CASORON FREE

Vines For Sale

NO DODDER

Ben Lears \$4,500 a ton

*Orders paid in advance
by February
receive a 10% discount.*

60 Tons Available

Jonjak Cranberry Farm Inc.
Hayward, Wisconsin

Call Randy Jonjak
(715) 634-3979

Stevens \$4,000 a ton

*Orders paid in advance
by February
receive a 10% discount.*

30 Tons Available

Cranberry Springs Inc.
Hayward, Wisconsin

Call Stanley Roy Jonjak
(715) 634-3044
(715) 634-3286

TRUE VARIETIES

HONEST WEIGHTS

His grandparents were from Poland and his parents, who live in Racine, both speak Polish.

Wasiak's summer at Northland has grown beyond an exchange of cranberry research. He has been a teacher as well, bringing a Polish cultural experience to those he has worked with.

"Pawel is a very interesting human being," Swendrowski said. "He has vision and is a bit of a philosopher."

"It's been good for our men to talk with him. How often can someone in Warrens, Wisc., hear about day-in and day-out experiences in Poland? There's no doubt Pawel learned technically, while our people learned culturally."

At Northland, Wasiak has observed new plant species, more efficient equipment for harvesting, better pesticides, herbicides and marsh irrigation.

"In United States, there is irrigation and that is best for crop development," Wasiak said. He also praised the varieties of fertilizers available here, as well as the growers' prudent management of pesticides.

In Poland, there is no mechan-

ized equipment for harvesting cranberries. Harvesting still is done with rakes and buckets that aren't much different than those used by Wisconsin growers a hundred years ago. Wasiak said the Institute of Pomology has a machine shop and he plans to build simple harvesting equipment based on photos he has taken this summer.

His job here has been to take plant samples from Northland's marshes, so that a lab can trace nutrient levels and other information. Wasiak has also performed

weed location mapping at several marshes. Based on this, herbicide application plans will be prepared for use next year. All statistics are entered into a data base Northland is building for better long term crop management.

Northland is a member-grower of Ocean Spray, which produces 80 percent of the fruit harvested in the \$800 million cranberry industry... a number that brings a gleam to Wasiak's eyes.

WHEN Wasiak returns to his research station in Poland at the

New Year's Resolution: Begin the new cranberry season without the old aches and pains.

CALL NOW



**CARVER
CHIROPRACTIC
CENTER**

Family Health

**Dr. Arne Winn
Carver Square Market
Rte. 58, Carver, MA**

**866-BONE
866-7600**

CRANBERRIES

THE NATIONAL CRANBERRY MAGAZINE

SEND CORRESPONDENCE TO:

**P.O. BOX 249
COBALT CT 06414
(203) 342-4730**

PUBLISHER & EDITOR: BOB TAYLOR

ASSOCIATE EDITOR: CAROLYN GILMORE
(508) 763-5206

ADVISORS & CORRESPONDENTS

MASSACHUSETTS — Irving E. Demoranville, Director, Cranberry Experiment Station.

NEW JERSEY — Phillip E. Marucci, Cranberry & Blueberry Specialist, Buddtown; Elizabeth G. Carpenter, Chatsworth.

NOVA SCOTIA — Robert A. Murray, Horticulturist, Berry Crops, Research Station, Truro.

OREGON — Arthur Poole, Coos County Extension Agent, Coquille.

WASHINGTON — Azmi Y. Shawa, Horticulturist and Extension Agent in Horticulture, Coastal Washington Research & Extension Unit, Long Beach.

WISCONSIN — Tod D. Planer, Farm Management Agent, Wood County.

CRANBERRIES is published monthly by Diversified Periodicals, Wellwyn Drive, Portland CT 06480. Second class postage is paid at the Portland, Conn. Post Office. Price is \$15 a year, \$28 for two years, \$2 a copy in the U.S.; \$17 a year in Canada; \$20 a year in all other countries. Back copies: \$2.50, including postage. Copyright 1988 by Diversified Periodicals.

ISSN: 0011-0787

Postmaster, send Form 3749 to:

CRANBERRIES

P.O. BOX 249

COBALT CT 06414

BIG WHEEL TRUCK SALES

**42 Quapanoag
E. Freetown, Mass.**

All types of medium and heavy duty trucks on hand from cab & chassis to dump trucks to road tractors.

Largest used truck dealer in New England.

All types of diesel repair.

Largest tow trucks on the East Coast.

Call Bob or Joe

(508) 763-5927

or

(508) 763-8745

end of September, he'd like to try taking native vines into managed production for the first time. He also wants to experiment with improving some of the Russian varieties of cranberries.

Planting his own small, private marsh remains high on Wasiak's priority list.

"I like U.S., but you understand my country is there," says Wasiak, in his slightly abbreviated English. "I would only live in Poland. Many of our young people go to

Italy, West Germany, they want new life. That's not good for Poland. For us to have better economy, we must keep young people and have something for them.

"I would like new time for my country. For that, there must be good economic system in Poland. Maybe with my research and, some day, my cranberry business, I can help to make it better."

CRANLAND SERVICES

Cranberry Property Appraisals

★ ★ ★ ★ ★
Listings and Sales of Cranberry Properties.
License # 68987

Lawrence W. Pink
Old Cordwood Path
Duxbury, MA 02332
(617) 934-6076

Subscribe to

CRANBERRIES

\$15 a year

Send check or money order to:

CRANBERRIES

P.O. Box 249

Cobalt, CT 06414

High Volume Trailer Pumps

- 12 to 16" discharge
- 20' tongue
- PTO shaft with marine bearing

Phil Helmer
1060 3rd St. N.
Wisconsin Rapids WI
54494
(715) 421-0917

22 years experience   construction lifts 

AERIAL LIFTING

◦ *BERRY LIFTING* ◦
nylon berry bags
bulk bins

◦ *MUD LIFTING* ◦
NEW MATS

lightweight
durable

 **BEATON'S**
CRANBERRY
GROWERS SERVICE

 **WARHAM MASS.**

mat rentals & sales



contact
PETER or CHUCK
508-295-2222

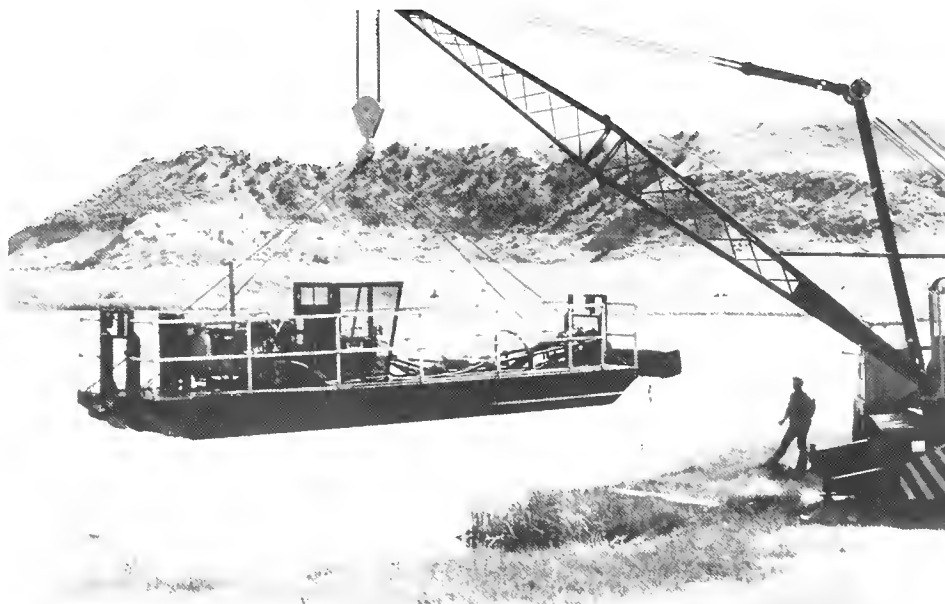

***For Reliable Dredges and Pumps,
Cranberry Growers Look to Crisafulli***

Your Crisafulli pumping equipment will be manufactured just for you, with your choice of power options and discharge size. If you need to dredge sand, call us for quotations and specifications. We will supply you with exactly what you need, not something designed for somebody else! For information, quotations, local representation, call:

1-800-442-7867

or FAX 406-365-8088

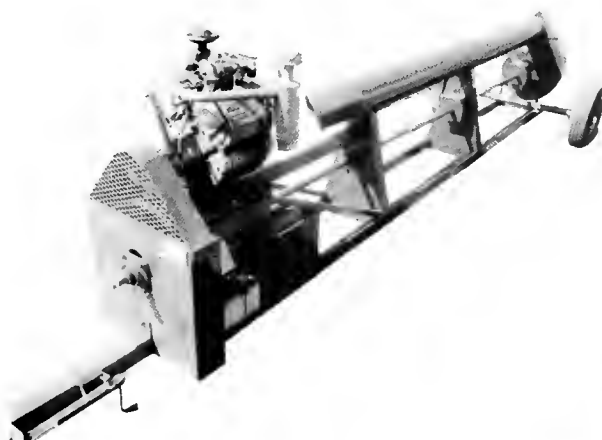
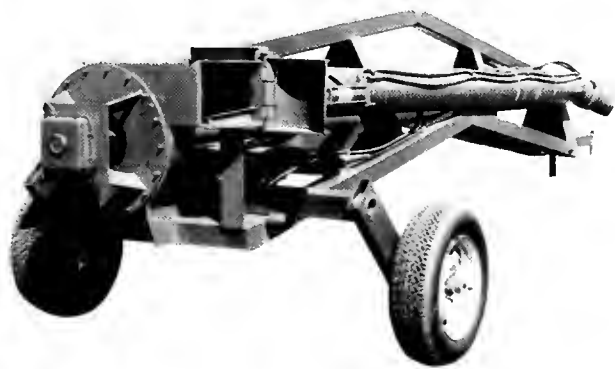

editorial



Intriguing Times Ahead

Both on the national level in general and in cranberrying in particular, the year 1989 promises to be an exciting one, not devoid of threats but holding many promises.

Macrowise, there's always the suspense that precedes the unfolding of a new administration in Washington. Will a Bush government be a Ronald Reagan rerun? Or does George Bush have his own vision?

A glance at the front page as this is being written reveals some rough seas ahead. *Large Banks Raise Prime Loan Rate to 10½% From 10%* reads one headline. *OPEC Signs Accord to Lower Output for Half a Year* says another. *Latins Want Bush to Help on Debts* tops another story.

And, yes, political overtones aside, our federal deficits are a genuine threat. Also, one doesn't have to be a genius to know that when the homeless rate rises so rapidly, the trouble is with the political economy, not individual sloth.

Things on the international scene have improved, what with the thaw in the Cold War. Wish George Shultz was going out in a more astute, less partisan fashion, but there is hope that 1989 may see progress in some of the world's most vexing problems—including those in the Middle East.

Microwise, cranberrying will continue sailing rapidly in the sea of change. Integrated Pest Management has been a key phrase in the industry for some time now. More will be heard of it in the 12 months ahead.

Just at the time more of a squeeze is being put on the use of chemicals, developments in other methods of control—biological and biotechnological—are proceeding apace. Some of the progress being made in genetic engineering is placing agriculture on the cutting edge of science in a way that can only be compared to advances in space exploration.

Chances look good for continued remarkable business growth in cranberrying, which must be attributed in large measure to the undeniable marketing genius of Ocean Spray. Also on the playing field, of course, are several sturdy, lean-and-mean independents.

The opening of Maine to cranberrying is another exciting development in what lies ahead. Sight must not be lost, of course, of the goal of careful management of supply and demand, which has helped keep the cranberry from suffering the feast or famine fate of other crops.

Yes, 1989 should be an exciting year. But growers are used to change and excitement. A hot spell here, unexpected frost there. New plagues. Disease outbreaks. Crops of surprising beauty and bounty. And, occasionally, the sight of a fox or a bluebird. It's all in a year's work.

Bye-Bye, Black Rot

According to USDA researcher Allan Stretch, a solution may have been found to the black rot fungus that attacks stored cranberries.

The remedy, he says, may be naturally occurring microorganisms that attach themselves to any bruises on a berry, thus preventing penetration by black rot.

The disease particularly affects those cranberries that are wet harvested.

The advantage of the microorganism approach, Stretch says, is that there need be no interference with the way berries are normally handled.

FOR SALE

Irrigation Pump

5x4 Gorman Rupp
170 cubic inch
Ford powered by gas
Skid mounted
Very good shape
\$2,500

2 Weston Pickers

\$1,500 for pair

Call Larry Cowan

Days (508) 947-1723
After 6 (508) 946-1720

The CHARLES W. HARRIS Company

451 Old Somerset Avenue
North Dighton, Mass.
Phone 824-5607

AMES
Irrigation Systems
RAIN BIRD
Sprinklers

HALE
Pumps

*Highest Quality Products
With Satisfaction Guaranteed*

REGIONAL NOTES

MASSACHUSETTS

By IRVING E. DEMORANVILLE

Dr. Robert Devlin of the Massachusetts Cranberry Experiment Station attended the Agway Weed Control Round Table in Syracuse, N.Y., on Oct. 24-25.

Bob also attended the New England Chemical Conference in Hampton Beach, N.H., on Oct. 5.

Harvest was winding down by the end of October, but there were some stragglers. Seems to be more picking after Nov. 1 in recent years.

The Massachusetts crop surpassed the August estimate of 1,825,000 barrels, probably by 75,000 barrels and possibly by 125,000 barrels.

A few growers had small Early Blacks, but not like last year. Color was generally excellent, but not where vines were excessive. Quality was good to very good—probably some influence from late water here.

Howes were outstanding this year.

Generally, Cape Cod and adjacent areas, such as Wareham, most of Carver and Rochester, had excellent crops, while inland and areas to the north were not as good as expected.

WASHINGTON

The 1988 crop was down from the pre-season estimate of 40,000 barrels but still exceeded every other crop of the eighties except for 1987's 37,309 barrels.

Paul Bauge, Ocean Spray receiving station manager at Long Beach, gave the final total as 35,711 barrels.

He attributed a later-than-normal set this year to cool weather during the June blooming period.

Quality and coloring were good, although

coloring was down a bit from '87.

WISCONSIN

Despite a horrific summer drought, cranberry growers were predicting a record crop for 1988.

The estimate of 1.336 million barrels would put Wisconsin up 1 percent from 1987's 1.32 million barrels.

Certain varieties, according to John Swendrowski, president of Northland Cranberries of Wisconsin Rapids, responded well to drought conditions.

He noted that the additional irrigation required was expensive.

The Wisconsin Farm Bureau Federation will hold its annual meeting Dec. 4-6 at the Oshkosh Centre, Oshkosh.

Election of officers and awards will be among the business to take place.

The new cranberry room at the South

Wood County Historical Museum in Wisconsin Rapids recently was given a certificate of commendation for achievement in local history by the State Historical Society of Wisconsin.

The award was presented to the project chair, Pamela Walker of the South Wood County Historical Corp., by H. Nicholas Muller III, State Historical Society director.

Wanted

Wisconsin Cranberry Grower wishes to purchase an existing cranberry marsh.

STEVE

(715) 421-0917

(715) 593-2385

WOLLSCHLAGER EXCAVATING

Dragline Work — All Kinds

Also Have Clam & Scalping Buckets

Route 1 Necedah, WI 54646
1-808-585-2436

Financial Strength. . . Personalized Service. Isn't That What You Need In A Bank?

The Jackson County Bank has supported agriculture in the area for more than 110 years.

We recognize the importance of the cranberry industry and are pleased to provide financial services for all your banking needs.

We're large enough to serve you and yet we offer personalized service which your business demands.

The Jackson County Bank. A name to count on throughout the years.

You'll like the difference.



JACKSON COUNTY BANK Member FDIC
(715) 284-5341

Black River Falls, Alma Center, Hixton, Merrillan, Taylor, WI 54615

Gapen Realty & Insurance

Knowledge & ability to unite buyers and sellers for existing marshes or undeveloped land.

2141 8th Street South
Wisconsin Rapids,
Wisconsin 54494
(715) 423-6550



Multiple Listing Service
MLS



Bill Aims to Reduce Chemical Control

Battle lines are being drawn over the Farm Conservation and Water Protection Act, which Congress will take up this session.

Sen. Wyche Fowler (D-Ga.), who introduced the bill, said the aim of the legislation is to wean farmers away from heavy chemical controls, not to shut down the chemical industry.

Citing that groundwater contamination has been found in 41 states, Fowler said that chemical residue on food is believed to be a leading cause of cancer. The Georgian is a member of the Senate Agriculture Committee.

Tom Wadlinger, a spokesman for the Washington, D.C., based Fertilizer Institute, takes issue with

the bill.

He declares that the use of such organic materials as manure and sewer sludge are not safer for the environment.

Sewer sludge contains metal and other harmful ingredients, he says, adding that the nitrates in manure are the same as those found in chemical fertilizers.

The Fertilizer Institute's vice president for public affairs stated that only 200 pounds of commercial fertilizer are needed per acre, whereas 80,000 pounds of organic material are required.

"There seems to be the attitude that we can go back to the way

things used to be," he said, "when people had their self-sufficient farms and used the manure from their animals for their crops. Agriculture is just not like that anymore."

In defense of his bill, Fowler said, "We can pay the costs now by transforming agriculture in a rational and measured fashion or we can pay catastrophic costs down the road in contaminated food and water supplies, increased death and disability."

He claims that the nation's farmers use 22.3 billion pounds of nitrogen fertilizer and 850 million pounds of agricultural pesticides annually.

Cranberry Institute Elects 7 Directors

The Cranberry Institute elected seven directors for 1988-89 at its recent board of directors meeting.

Christopher Makepeace of A.D. Makepeace Co., Wareham, Mass., was elected chairman of the board and will serve on the institute's executive committee. Richard Indermuehle of Alder Lake Cranberry Co., Manitowish, Wisc., and Terry Jonjak of Trego Cranberry Farm, Trego, Wisc., were also elected to serve on the executive committee.

Other board members elected were: John C. Decas of Decas Cranberries, Wareham, Mass.; Tom Darlington of Joseph J. White Inc., Browns Mills, N.J.; Ralph May of C.W. Farms Ltd. Partnership, Delta, British Columbia, Canada, and Malcolm McPhail of Malcolm E. McPhail and Ardell G. McPhail, Ilwaco, Wash.

The institute, managed by the Robert H. Kellen Co. of Atlanta, Ga., and Washington, D.C., elected Robert H. Kellen president. Charles Ehrhart of the Kellen Company's Washington office, was elected executive director.

The Kellen Company is an association management company which has served food and beverage groups for nearly 25 years.

The Cranberry Institute assists cranberry growers in resolving horticultural and environmental issues related to the growing of cranberries.



NODJI VAN WYCHEN proudly promotes fresh cranberries and Van Wychen Cranberry Wine, the latter a product of Van Wychen Cranberries and the Stone Mill Winery. The photo was taken by **CRANBERRIES** correspondent Frederick M. Poss at the Warrens, Wisc., Cranfest held in September.

But Ants Find It Toothsome

Cranberry Loaf Winds Up In Wrong Contest Group

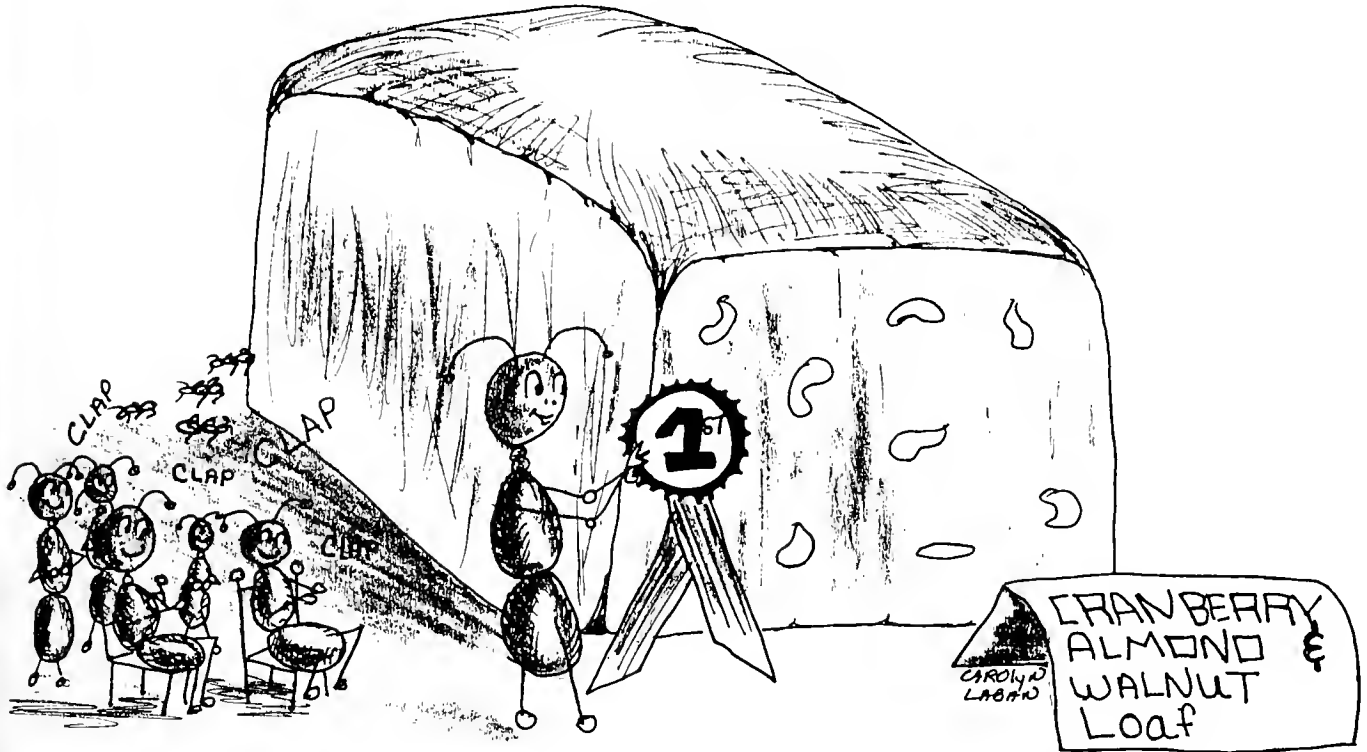

By LILLIAN MURPHY

While baking isn't necessarily the love of my life, when there was an opportunity to enter our local cooking contest, I thought—well, there's always a first time.

I decided to submit my recipe for a Cranberry, Almond and Walnut Loaf, my first mistake. It's really a loaf of bread and doesn't genuinely qualify for a place in the dessert category. Nevertheless, I promptly received notification I was a finalist.

With my usual luck, the day of the contest produced a blazing heat wave. Undaunted and armed with my sturdily wrapped masterpiece, I sallied forth.

The fact that I accidentally dropped the whole thing getting off a crowded bus, and the carefully arranged decoration enhancing my colorful entry instantly relocated itself, did nothing to



ABEL'S APIARIES

*Strong Beehives Available
For Cranberry Pollination
Truckload Lots*

Call or Write:

Abel's Apiaries
P.O. Box 234
Sydney, Florida 33587
Phone (813) 659-0784 or
(301) 592-9712

Office
295-2222

BEATON'S CRANBERRY GROWERS SERVICE

K. Beaton
295-2207

D. Beaton
888-1288



P. Beaton
947-3601

Specializing in

● COMPLETE BOG
MANAGEMENT

● NETTING

● DITCHING

● HARVESTING
(Wet & Dry)

● SANDING

● CUSTOM
HERBICIDE
APPLICATION

Complete line of portable Crisafulli Pumps 2" - 16"
Plastic netting for suction boxes



Decran AG Supplies Inc.

Serving
Massachusetts
Cranberry
Growers



- ★ Complete line of cranberry pesticides, fertilizers, miticides. *In stock when you want them.*
- ★ Quality aerial applications.
- ★ Best application and safety equipment for your needs.
- ★ Proven frost warning equipment. Don't take chances—buy the best.
- ★ Experienced cranberry consulting service offering pheromone traps and baits.
- ★ Sanding by helicopter.
- ★ Culvert Pipe—All sizes—steel and aluminum.
- ★ Ditch Mud Mats—Strong—lightweight—durable.
- ★ Burlap Picking Bags—Best for your money.

John C. Decas
DECAN AG SUPPLIES INC.
219 Main St.
Wareham, MA 02571

Contact

office: 295-0147
evening: 763-8956
(William Chamberlain)

ize me.

However, when I set foot in the preparation kitchens and witnessed all the experienced contestants nervously cultivating their thoughtfully contrived creations, I began to wonder if I shouldn't have taken the occasion a bit more seriously, since I had, up to now, been rather gung ho about the adventure.

The huge work area contained five very well equipped kitchens and—heat wave or not—the ranges and ovens were all going full blast. I considered myself fortunate to have settled in a rather cozy little spot near an open window, but my joy was short lived when I realized why it was available.

No sooner had I deposited my little loaf on a colorful doily than I observed an army of ants had passed the word along and had attempted to reach my entry before the judges had a chance.

The ant battalion was so numerous in such a short time that, if I had decided to take some of them home to introduce to my own ants, they wouldn't have been missed.

THE ENORMOUS working space was a veritable hive of industry, agog with everyone lovingly primping their respective entries to their full potential, like children being dressed in their best for a party. Determined entrants frantically hovered over their fancy hors d'oeuvres, encouragingly moistened their exciting entries and daintily decorated their exotic desserts—a blob of whipped cream here, a glace cherry there.

There were Tuna Spuds reaching heights no tuna could ever have imagined. Also,

Beach Blanket Abalone, comfortably arranged, Baked Running Feathers, Zucchini and Grit Custard, to name just a few.

One contestant was so secretive about her entry, and she kept her contribution so well concealed, that I never did find out what it was or whether she won anything. Another finalist, who won several prizes (and who would have thought to enter three or four recipes?), had also brought along a Macadamia Nut Cake, which somehow or other completely disappeared before it had a chance to be judged. It

Turf **Equipment Inc.**
381 West Grove Street (Rte. 28)
Middleboro, MA 02346

KUBOTA Diesel Equipt.

Tractors 2 & 4 wheel drive — 12-90 hp.
Compact Excavators 1½ to 6 ton
Wheel Leaders ½ to ¾ yd.
Water Cooled Diesel Engines 4 to 104 hp.

All Types of Implements
Polymark Beaver-Mowers 947-6299
Specialty Fabrication Work
Kubota Financing as Low as 8½%

*Sales *Service *Parts *Leasing





Plymouth Copters, Ltd.

Growers fertilizers, herbicides and pesticides applied to growers specifications
Mud Lifting – Cranberry Lifting
Mats Available

Plymouth Airport
Box 3446
Plymouth, MA 02361

David J. Morey
Richard H. Sgarzi
(617) 746-6030

Agricultural Applications • Lift Work • Executive Charters • Aerial Photography

never was located.

In an attempt to keep up with the winners, I discovered that the Stuffed Turkey Roll in Egg Roll Wrappers easily took first prize in the poultry category. The Chocolate Frangelico Cheesecake easily won first place among the desserts and the Tree Trunk Cake brought up the rear.

I can authentically vouch for the judges' fairness, as they continued to cautiously sip sodas and crunch crackers between mouthfuls to revive their taste buds for the next delicacy. It must have been extremely difficult selecting winners from the numerous magnificent entries.

If there had been a booby prize, I might have been eligible. Though I didn't get anywhere with my, by now, withered looking loaf, I certainly didn't regret entering.

It didn't take me long to realize that submitting a loaf of fruited bread as a dessert was a no-no. Also, it certainly should have been accompanied with a sunny pat of sweet, creamy butter to enhance the delicate flavor, as is intended in the recipe.

Having mingled with the experienced contestants and sampled their original creations, I learned that everyone is usually at a disadvantage the first time around. But I have had a golden opportunity to learn first hand what is required in a cooking contest.

For starters, one should never consider entering an item that hasn't been successfully rehearsed several times previously.

At the close of the contest, we were all thanked warmly for our efforts and allowed to rescue any remains. When we were all packed up and the kitchens restored to law and order, the celebrants and losers thinned out onto the lawn and returned to

their everyday activities until next year.

Will I be there? You bet I will. I'm now full fledged cooking contestant and wise in the ways of the judges' requirements.

After all, if nothing else, at least the ants were partial to my Cranberry, Almond and Walnut Loaf. Why else would they have come charging after it the moment I laid it down?

Vines For Sale

Crowley..... \$3,000 a ton

Searles \$2,500 a ton

10% discount with 50% payment by March 15

Remainder due on delivery or pickup

G. BROCKMAN, INC.

4409 Brockman Road

Vesper, WI 54489

(715) 423-0368

(715) 423-7016



CASORON® 4G

Effective control of broadleaves and grasses.

If you're looking for a way to control tough weeds, your choice should be Casoron 4G. It's effective against a broad spectrum of broadleaves and grasses, it's economical, and comes in easy-to-use granular form.

**UNIROYAL
CHEMICAL**

Casoron is a Reg. TM of
Uniroyal Chemical Company, Inc.

Please read and follow all
label instructions carefully.

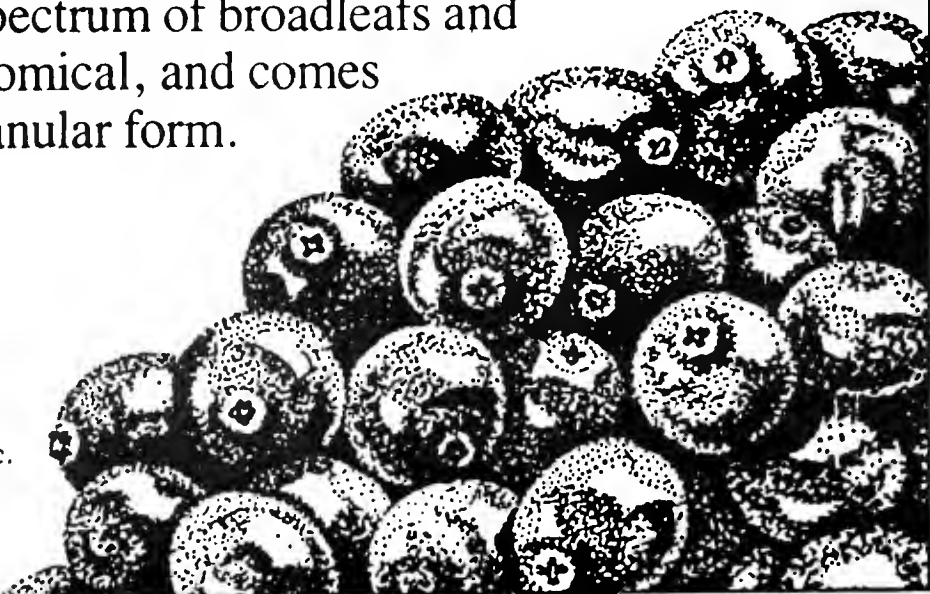

Contending With the Problems In a Family Business

By **JOSEPH ARKIN**

Siblings fight. Best friends disagree. Spats bruise the happiest marriage. So, it should come as no surprise that personal conflicts arise in closely held family businesses.

However, conflicts in family businesses involve more than egos and emotions. Such conflicts can have serious financial consequences.

Simple family disagreements become distractions that absorb valuable management time and energy. More severe conflicts can lead to disruptions that damage sales and reduce a family firm's earnings. In extreme circumstances, family conflicts can create disturbances that threaten a firm's survival. Being right can become more important than being successful.

No panaceas exist for avoiding conflicts in family businesses. And family disagreements often resist common solutions. But recognizing some basic consid-

erations can help reduce the frequency and severity of family conflicts.

To orient our look at those considerations, we first will separate the potential conflicts in family businesses into the following categories:

1. Non-business conflicts that affect the business;
2. Problems arising from dispersed management control;
3. Problems dealing with inactive shareholders;
4. Problems dealing with non-family members in the business;
5. Transition problems, i.e., replacing top management.

The different categories may

overlap. And some of the problems in family businesses really do not arise from personal conflicts. But focusing on the above categories helps orient the discussion.

Problems arising from personal conflicts may be the most difficult to solve. Such conflicts often bear only an indirect relationship to business activities. Yet they often arise from deep seated emotions that resist rational solutions.

A brief scenario provides an example of such problems.

The Mellow Company is a family held concern that operates successfully in several states.

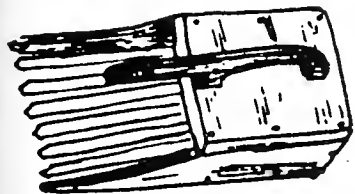

CRANBERRY

COMPUTER, INC.

CRANWARE

- Growers
- Handlers
- Chemical Applications
- Chemical Resale

(508) 291-1192

2 Tobey Road, Wareham, MA 02571

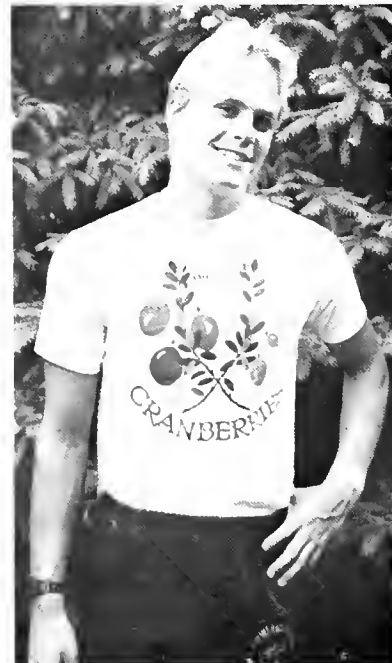

Cranberry Originals

T-Shirt

"CRANBERRIES
North America's Native Fruit"

An Original Botanical Design
of Blossoms and Green & Ripe Cranberries
by

Ann K. Cranberries

Adult T-Shirt (Sizes S, M, X, XL)	\$12
Adult XXL T-Shirt	\$14
Youth Size 14-16 T-Shirt	\$11
Children's Sizes 4, 6-8, 10-12	\$11
Adult Sweatshirt (S, M, X, XL)	\$25
Adult XXL Sweatshirt	\$28
Youth 14-16 Sweatshirt	\$21
Children's Sweatshirt (4, 6-8, 10-12)	\$19

Send Check or Money Order to:

CRANBERRIES
P.O. Box 249
Cobalt, CT 06414

Add \$3.50 Shipping & Handling Charge
For Canadian orders, add \$8

NAME

ADDRESS

CITY STATE ZIP

The founder remains in firm control of the business. He has three sons active in the operation. One functions as sales manager, a second serves as controller, while the third is a plant supervisor.

Although all three sons receive generous compensation, their varying responsibilities still introduce differences in their pay. Those small differences allow one family to enjoy a few more of life's amenities than the other two. And the remaining two also have somewhat varying lifestyles stemming from the differences in income.

However minor they appear, the differences in income and lifestyles provide the seeds for discontent. Irrational jealousy takes precedence over reason. Demands for equal pay for unequal contributions create family discord that threatens to damage the Mellow Company's success. Irrational personal differences become a business problem.

One solution may come from allowing dissident family members to assume responsibilities for specific profit centers. Their income then can be partially related to the profit cen-

ter's performance.

The specific profit center may be oriented towards a new or existing market area. Or perhaps a new business can be established that moves the firm into a new field.

Whatever the approach, such moves shift the question of compensation differences away from emotional issues. Family members can't quibble as much when their measurable performance becomes an important influence in the compensation issue.

Of course, expansion into new markets or new fields may not stand as a feasible alternative. The firm may lack the necessary financing capability. Or the dissident family members may lack the ability to manage a separate profit center.

In other instances, personal differences may preclude a reasonable solution. Minor family disagreements can grow into bitter, irreconcilable disputes.

In such circumstances, business survival should stand as

the most prominent concern. That may require separating the dissident family members from the business.

If the dissidents lack any ownership interest the separation process is straightforward. The dissidents simply gain the opportunity to seek employment elsewhere.

However, in many instances, dissident family members also own an equity interest in the business. To avoid rekindling disputes in the future, the dissidents should sell their interests in the business.

Again, one approach is straightforward. The dissidents can sell their shares directly to those remaining active in the business. That leaves the business entity uninvolved in the financial transaction.

However, in many circumstances, the company must buy out the departing shareholders. The company may pay cash for the shares. Or a long term pay out may be arranged.

In any event, the buy out should

Niemi Electric Company



Robert
Niemi
Electrical
Contractors

Heat, Light & Power Wiring

- RESIDENTIAL
- COMMERCIAL
- INDUSTRIAL

Pinehurst Drive
Wareham, Mass.
TEL. 295-1880

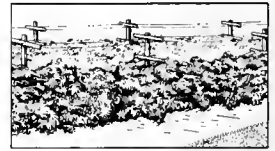

Norosac Herbicide is unparalleled in controlling weeds and grasses in young fruit trees, nursery stock, blackberries, cranberries, raspberries and blueberries.

CAN YOUR PRESENT PRE-EMERGENT HERBICIDE DO ALL OF THESE?

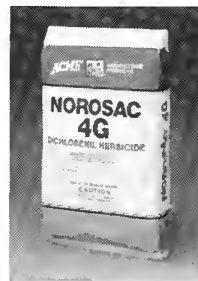

★ Be applied over and through existing weed growth?

★ Kill existing vegetation?

★ Control annual weeds and grasses?

★ Control perennial weeds and grasses including quackgrass and horsetail (Equisetum)?

★ And can it last through the growing season with one application?

NOROSAC® 4G CAN..AND DOES!

G pbi / GORDON
CORPORATION

1217 WEST 12TH STREET
P.O. BOX 4090
KANSAS CITY, MISSOURI 64110
816 / 421-4070

NOROSAC®



Norosac® is a registered trademark of PBI/Gordon Corporation.

©1988, PBI/Gordon Corporation

713-1088

not severely upset the firm's financial circumstances. Burdensome obligations left from buy outs can threaten a firm's survival.

Indeed, if a burdensome buy out represents the only feasible settlement, selling the whole business to a third party may become more desirable. The business survives. And the family can enjoy the financial settlement, if not the continuing benefits from ownership.

The second category of problems in family owned business doesn't necessarily involve any direct personal conflicts. Instead, the problems center on efforts to find an effective approach to managing the business.

In this instance, we assume that several family members are actively involved in day-to-day management activities. Yet no single family member, nor any family group, enjoys majority control of the business.

The absence of extreme family disputes doesn't preclude prob-

lems in such circumstances. The family still must develop an approach to managing the business successfully, while avoid-

ing discord. Some sensible guidelines can help orient that effort.

First, even though no one has

Irrigation Supplies

- 2" to 12" PVC Pipe with Fittings
- Quick Couple Risers
- Felker Aluminum Flumes & Culverts

Replace old aluminum mains with government approved 4", 6" and 8" polyethylene pipe buried just below bog surface. No insert fittings. Rent our butt fusion welder for a continuous main line. Beat the high cost of custom installation by renting our small 4-wheel drive tractor with mole hole plow for buried laterals.

STEARNS IRRIGATION, INC.

790 Federal Furnace Rd.

Plymouth MA 02360

Tel. (508) 746-6048



**MIDDLEBOROUGH
TRUST COMPANY**

The Business Bank.

MTC offers you business banking built to your needs.

Personal attention to your special

financial requirements now and as you grow. Cooperation.

Flexibility. Complete business and personal banking.

Member FDIC



Main Office

10 John Glass, Jr. Square, Middleborough

Branch Offices

Middleboro Square, Rt. 28, Middleborough • Middleboro Plaza, Middleborough
Cranberry Plaza, East Wareham • Carver Square, Carver • Trucchi's Plaza, Taunton

Telephone all offices **947-1313**

majority control, one or more family members must assume leadership positions. Effective leadership then replaces the authority and influence typically exhibited by a controlling manager.

Effective leadership involves all the active family members in the significant business planning and decision processes. That involvement can develop through various management committees. Or it may rely on less formal arrangements. Whatever the form, active involvement encourages the teamwork necessary to work for the best interests of the business enterprise, which also serves the family's interests.

Effective leadership involves all the active family members in the significant business planning and decision processes. That involvement can develop through various management committees. Or it may rely on less formal arrangements. Whatever the form, active involvement encourages the teamwork necessary to work for the best interests of the business enterprise, which also serves the family's interests.

Effective leadership also ensures that open lines of communication prevail among all the family members involved in management. Apparent secrecy of any kind plants the seeds of discontent. Not every family

member can have his way. But every active member must feel involved.

Lastly, whenever possible, management tasks and responsibilities should be spread among family members in a manner that reduces the potential for disputes arising from overlapping concerns. Clear lines of authority and established responsibilities contribute towards that objective. Leaving responsibilities unclear increases the potential for unnecessary disputes.

The third category of problems that commonly arise in family owned business involves inactive members. Although inactive, these family members typically

feel that their ownership interests entitle them to share in the firm's earnings through periodic dividend payments. Knowing that active family members enjoy generous compensation from the business only intensifies those feelings.

The demand for dividends may be complicated by the firm's own financing needs. The business may have a bona fide need to retain its earnings to fuel continuing growth.

In such instances, the firm's best interests should prevail. Active members should try to prove the firm's need to retain earnings. Certainly, the longer term prosperity of the business

WISCONSIN CRANBERRY HEADQUARTERS FOR SEVIN XLR

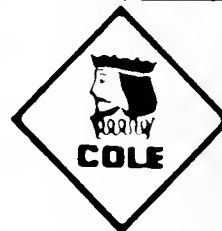

DEVIRINOL 10G * EVITAL * GUTHION
DIAZINON 14G * PARATHION * ETHREL

Cole/Grower Service

537 Atlas Ave., P.O. Box 7211, Madison, WI 53707
(608) 221-6204 or 1-800-362-8049

CRANBERRY GROWERS REALTY

*Listings of buyers and
sellers welcomed on
cranberry acreage
and upland.
Appraisals*

DOUGLAS R. BEATON
E. Sandwich, Mass
02537
(617) 888-1288



Vines For Sale

**PITT MEADOWS FARMS
LIMITED PARTNERSHIP**
2851 No. 8 ROAD
RICHMOND, B.C. V6V 1S2

STEVENS..... \$3,750 a ton
CROWLEY..... \$3,750 a ton

*Prices are F.O.B.
CANADIAN FUNDS*

\$300 a ton less with 25% payment
before cutting

Call for large order pricing
(604) 278-6271

erves everyone's best interests.

Alternatively, the business may periodically pay stock dividends to the firm's shareholders. Those shareholders needing cash may find other family members willing to buy their dividend shares. The inactive shareholders achieve their aims without draining cash from the business.

As another alternative, a business may spin off one or more profit centers into new corporations. The earnings from those corporations then can be dedicated to dividend payments to shareholders. Even modest dividends may placate the inactive shareholders.

Involving non-family members in management creates another category of problems for family businesses. That involvement is unavoidable. Few businesses can fill every important management slot with talented family members.

At the same time, retaining talented executives in a family business often becomes a problem. Non-family executives remain outsiders. They may be involved in the family business, but they can't become part of the family. The potential for moving into the chief executive's role—a natural ambition for a talented manager—may be stymied by the presence of a family member with the same objective and similar talents.

Moreover, talented managers typically want to gain an equity interest in the business that enjoys fruits of their talents. That also can become a problem if the family members are reluctant to dilute their ownership positions.

Despite the obstacles, a conscientious effort can help a family business retain valuable executives brought in from outside.

First, use the manager's talents. Make him part of the team. Give him responsibilities and authority appropriate for his position and ability. Then, allow him to exercise those responsibilities without undue interference.

Second, insure that the execu-



**CEECO
CORPORATION**
OF NEW ENGLAND

Industrial Suppliers To The Cranberry Industry



Chain, Cable and Accessories

Used for Making Mats

All Types of Fasteners (Bulk & Packaged)

Hand Tools

Power Tools

Chemicals

Lubricants

Pumps

Motors

Abrasives

Cutting Tools

Safety Equipment

Richards Rd.
Plymouth Industrial Park

747-0086
Plymouth, MA 02360

We Still Make House Calls

Like your old family doctor, your Farm Credit representative still makes house calls... and he's been treating farm families like yours for a good 70 years.

Farm families count on him to provide the financial support they need—short-term and long-term credit—that helps them plan for a productive future.

But there's more to Farm Credit than money. What makes your Farm Credit representative unique is that he knows your business so well. Which means that he's more than a dependable source of credit. He can provide farm business consulting, tax services, credit life insurance, appraisal service and computerized record-keeping.

Give him a call. He could be just what the doctor ordered for you.

**Southern New England
Farm Credit Service**

**Federal Land Bank Association
Production Credit Association**
P.O. Box 7
Taunton, MA 02780
508 / 824-7578

tive enjoys compensation appropriate for his position. That should include the salary and other benefits that have become the norm in successful businesses.

However, the compensation also should include visible benefits that provide compensation for the executive's ego. A company car, a large, comfortable office, and other niceties can make up for many of the limitations the executive finds in the family business.

If the desire for an equity position remains an issue, forming a separate corporation may provide a solution. The business may spin off a profit center as a separate corporation. The non-family executive than may be rewarded with a share of the separate entity.

Alternatively, a separate corporation may be established to move into new markets or to move into entirely new fields. With the support of the existing business, such concerns have a larger probability for success than typical new ventures. Moreover, they can provide an equity interest for valuable non-family executives.

If no potential for equity interests exists, then the business should attempt to develop some deferred compensation plans that provide important non-family

executives with long term financial security. That security can provide the executive with the confidence to pursue his own ventures as sidelines, while still devoting the bulk of his talents to the business.

The last category of problems in families arises from the need to make transitions at the top management level from one

generation to the next. The severity of the problems naturally will vary with the circumstances.

In fortunate circumstances, the senior executive recognizes the need to turn the reins over to a younger family member. Ideally, one member—perhaps an only son—stands out among his peers. All recognize his succession as most beneficial for the business.

Vines For Sale

Ben Lear	\$5,000 a ton
Stevens	\$4,000 a ton
Crowley	\$4,000 a ton
Bergman	\$4,000 a ton

Prices are F.O.B.

\$500 a ton less with 50% payment before cutting

Richberry Farms Ltd.

11280 Mellis Drive
Richmond, B.C.
V6X 1L7 Canada

Res. (604) 273-4505
Bus. (604) 273-0777

Pump Repairs & Sales

All Types

- Field Service
- Chemigation Equipment Sold
- Demonstration by Appointment

AAA Industrial
Pump Service Inc.

Bruce Sunnerberg
66 Lake Street
Plympton, MA 02367
(617) 585-2394

R.D. GRASSI Cranberry SERVICES

Herbicides
Applied

Custom Pruning
Custom Ditching

Sanding
Wiping
Wet Harvesting
Mowing

(Mowing includes
Hydraulic Arm
Flail Mower.)

West Wareham,
Massachusetts

Ask for Rick at
295-5158

Providing time for a training period adds the final touch to these ideal circumstances. The senior manager turns the reins over gradually. He allows his successor to make his own mistakes. Yet he gently provides guidance when it becomes necessary. The successor grows into the job. He gains the confidence of his peers and himself. And the senior executive backs out of the business in an orderly way to happily pursue avocations previously set aside in favor of the family business.

Unfortunately, these ideal circumstances are uncommon. Several complications make orderly succession more difficult to achieve.

One complication develops when more than one potential successor exits. Two or more sons commonly are active in family businesses. When the father elects to retire, the succession decision easily can create a family furor.

However, the top executive still should select his successor. Leaving the decision to the next

generation inevitably creates dissension that may be painful to those concerned and damaging to the business.

In some instances, the selection process may be easy for the retiring executive. He can make his choice known early, and then proceed through the transition outlined above.

However, when the choice among peers isn't obvious, the top manager should consult with objective observers familiar with the firm's circumstances. Bankers, accountants, attorneys, suppliers, and even customers may provide insight that isn't obvious to the one responsible for the decision.

In any event, upon selecting his successor, the retiring executive should take steps to prevent conflicts among family members. The expedient use of titles can help appearances and sooth some damaged egos.

For example, the business may have, or form, subsidiaries that each have a President's title. Ultimate responsibility may rest



Equipment, Inc.

381 West Grove St. (Rte. 28)
Middleboro, MA 02346

(508) 947-6299



Tractors, Excavators and Diesel Generators



Wheel Loaders
3/4 Yd - 6 1/2 Yd



Screening Equipment

Irrigation Equipment Designed Especially for the Cranberry Industry

- Gorman-Rupp Self Priming Electric Sprinkler Pumps
- Proven Quick Couple Riser
- Polyethylene Main Lines, 3" - 12"
- Butt Fusion Equipment Available
- Paco/Wemco Water Harvest Pump
- Berkeley Self-Priming and Centrifugal Pumps

A Most Complete Inventory of Irrigation Accessories

LARCHMONT

IRRIGATION / SNOWMAKING

P.O. Box 66, 11 Larchmont Lane
Lexington, Massachusetts 02173 (508) 862-2550

Contact

Larchmont Engineering
Phil Tropeano, President
(508) 862-2550
(Call Collect)

Stearns Irrigation, Inc.
790 Federal Furnace Rd.
Plymouth, MA 02360
(508) 746-6048

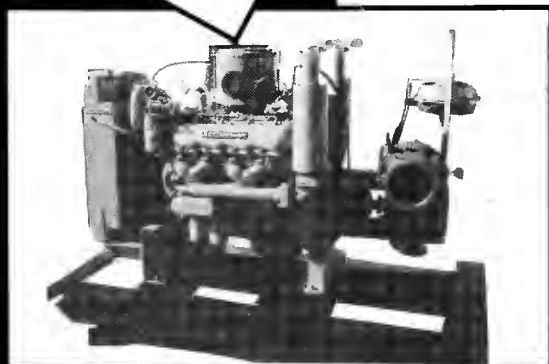
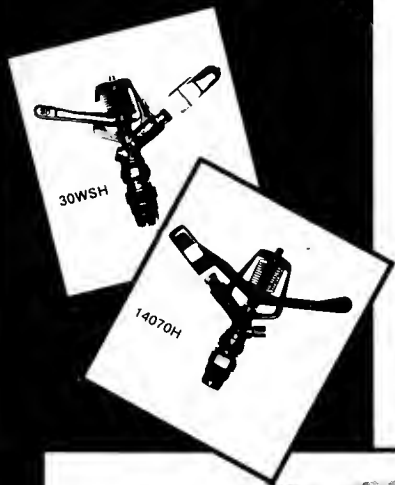

YANKEE PLANNERS, INC.

59 North Main Street
Middleboro, MA 02346
(508) 947-0527

Sound and Objective
Advice
Suited to
Your Needs

- Tax and Estate Planning
- Investment & Insurance Review
- Business Continuity
- Asset Protection
- Key Employee Retention
- Business Tax Analysis

Mr. William H. Bestgen, Jr.
Chartered Financial Consultant

Mr. Peter W. Hutchings
Attorney at Law practicing as
a Tax Attorney

Mr. Roger H. Parent, Jr.
Accountant, Enrolled to Practice
before the Internal Revenue
Service

Call For Your Free Brochure
(508) 947-0527

in the hands of the President of the parent firm. But the titles can help discourage family dissent during a transition period.

The most difficult transition problem arises when the managing founder fails to see the need to turn the firm's reins over to the next generation.

That need may be apparent to those inside and outside the firm. The founder may be an obstacle to further expansion or critical changes necessary to keep the business competitive. Or the founder simply may rely on archaic management methods that are cumbersome in the



Lampert, Lee
& Associates

CONSULTING ENGINEERS
SURVEYORS

Extensive experience in all aspects of cranberry land development: evaluation, purchase, survey, design, permit acquisition, phased construction and planting both in wetlands and uplands.

Have references. Will travel.

Contact: Will Lee
10948 Highway 54 East
Wisconsin Rapids, WI 54494
(715) 424-3131

Vines For Sale

Early Blacks _____	\$2,500 a ton
Stevens _____	\$4,000 a ton
Howes _____	\$2,500 a ton
Crowley _____	\$3,500 a ton

Prices F.O.B.

R.M. Lawton Cranberries, Inc.
221 Thomas St.
Middleboro, MA 02346

(508) 947-7465

modern era marked by electronic communication. Or the founder simply may be out of touch with the rapidly changing business environment.

Obviously, encouraging retirement in such instances is a delicate task. After all, the executive undoubtedly played an important role in the firm's past successes. He typically expects credit and respect for that role. Raising questions about a successor is more likely to raise his ire than encourage his retirement. What is the solution to this delicate problem?

Try reasoning with the executive. Attempt persuasion. Entice with the pleasures expected from retirement years unburdened by business pressures.

Proceed cautiously. Proceed carefully. And hope that one approach or another eventually will prevail.

What alternatives exist if all efforts fail and the founder persists in office?

Probably none. Forcing the issue will make the executive even more steadfast in his com-

mitment to stay. The only solution may come from backing off and letting time prevail.

That alternative may not serve the firm's immediate best interests. But it represents another illustration of the key element in the solutions to many of the problems that arise in family

businesses.

Indeed, a workable compromise often takes precedence over the best solution to a problem. Although it may not maximize the firm's earnings, the ability to compromise may be the key to a family firm's long term survival.

ARKIN MAGAZINE SYNDICATE

J.A. JENKINS & SON CO.

Grower Service

MOWING (ALL TYPES)
SANDING

DITCHING
WEED WIPING

Serving Cape Cod

227 Pine St., W. Barnstable, Ma. 02668

Phone 362-6018



Spring 1989



Vines For Sale

Ben Lear

\$3,500.00 per ton

Crowley

\$3,500.00 per ton

Stevens

\$3,500.00 per ton

Pilgrims

\$4,000.00 per ton

Prices F.O.B.

Contact:

Buy 10 tons, get one ton free.

20% down payment with order.

Call for large order pricing.

LeRoy Miles

Northland Cranberries, Inc.

(715) 424-4444

251 Oak Street

Wisconsin Rapids, WI 54494

Take Good Care of Yourself Have an Ocean Spray!



The farmer's cooperative that brings you
a wide range of natural fruit juices, drinks and sauces
Ocean Spray Cranberries, Inc., Plymouth, Massachusetts 02360
An Equal Opportunity Employer

3
23
7
re



New Ocean Spray Home Co-op and Feds Settle Recipes & More

d
JO
pht
set of
ighting

masking
rooms bear
stry, such as
es, Howes and

0003
RST
DEPT
LIBRARY
that caps off the
eral miles away.
—the new head-

Decran AG Supplies Inc

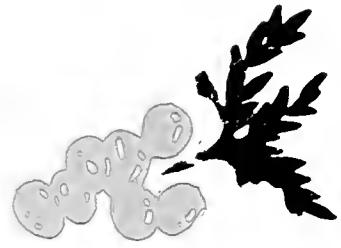
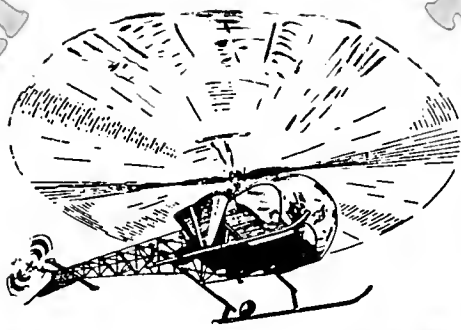

**Serving
Massachusetts
Cranberry
Growers**

- ★ *Complete line of cranberry pesticides, fertilizers, miticides. In stock when you want them.*
- ★ *Quality aerial applications.*
- ★ *Best application and safety equipment for your needs.*
- ★ *Proven frost warning equipment. Don't take chances—buy the best.*
- ★ *Experienced cranberry consulting service offering pheromone traps and baits.*
- ★ *Sanding by helicopter.*
- ★ *Culvert Pipe—All sizes—steel and aluminum.*
- ★ *Ditch Mud Mats—Strong—lightweight—durable.*
- ★ *Burlap Picking Bags—Best for your money.*

**John C. Decas
DEC Cran AG SUPPLIES INC.
219 Main St.
Wareham, MA 02571**

Contact

**office: 295-0147
evening: 763-8956
(William Chamberlain)**

Devrinol. The Gentle Herbicide for Cranberries.

With gentle protection, DEVRINOL® 10-G herbicide provides broad-spectrum weed control of over 40 broadleaf weeds and grasses, including nutsedge. DEVRINOL gives you long-lasting control throughout the season. And it's easy to apply—on the ground or in the air.

For more information, see your dealer or call the ICI Information Line: 1-800-759-2500.

Always read and follow label directions carefully.

DEVTRINOL



(Use only See label for specific recommendations)

ES February 1989

Ocean Spray's 'Camelot'



ANOTHER VIEW of the sprawling headquarters, which is situated on 310 acres in the heart of Massachusetts cranberry country.

(Photo by Jeff Rundell, Ocean Spray)

By **CAROLYN GILMORE**

Ocean Spray's new headquarters—truly a Camelot in appearance and design—was unveiled recently at two open houses for residents and officials of surrounding towns and the cooperative's member growers.

John S. Llewellyn, the cooperative's president and CEO, called the headquarters "a greenhouse, not a warehouse, for new ideas, methods and actions."

COVER PHOTO

AN AERIAL VIEW of Ocean Spray's new, crescent shaped headquarters in Middleboro-Lakeville, Mass. The building combines a colonial appearance with modern corporate needs. A story about the cooperative's sparkling new edifice begins on this page.

(Photo by Jeff Rundell, Ocean Spray)

The three-level, crescent-shaped building, of Federal Colonial design, is situated on a 310 acre site at the Middleboro-Lakeville, Mass., line. Located "in the heart of cranberry country," it is only 17 miles from the facility it outgrew in Plymouth.

The showcase headquarters curves around Poquoy Pond and a knoll. Its more than 300 arched and rectangular windows and a depth of only 80 feet in its 165,000 square feet of office space insure plenty of natural lighting and views for all offices.

The main building has a sound masking system and numerous conference rooms bear names well known to the industry, such as Makepeace, Ben Lear, Searles, Howes and McFarlin.

A copper roofed cupola that caps off the edifice can be seen from several miles away.

One Ocean Spray Drive—the new head-

quarters address—includes a working bog with a surrounding pond. The Agriculture Research Center incorporates an early 1800's Cape designed building with two 28 foot greenhouses for the growth and study of cranberry plants.

In addition to the natural surroundings, there are 16 acres of landscaping, which include dogwood, sycamore, birch, maple and oak trees. Native cranberry bushes, several species of rhododendron and perennial flowers promise a full season of blooms.

CRANBERRY GROWERS REALTY

*Listings of buyers and
sellers welcomed on
cranberry acreage
and upland.*

Appraisals

DOUGLAS R. BEATON
E. Sandwich, Mass
02537
(617) 888-1288

Massachusetts Growers

Financial assistance is available for SCHOLARSHIPS and MEDICAL ASSISTANCE for Cranberry Growers, their Employees and the families of both when financial need can be shown. For information contact:

URANN FOUNDATION

P.O. Box 1788

Brockton MA 02403

Telephone 588-7744



CASORON[®] 4G

Effective control of broadleaves and grasses.

If you're looking for a way to control tough weeds, your choice should be Casoron 4G. It's effective against a broad spectrum of broadleaves and grasses, it's economical, and comes in easy-to-use granular form.

**UNIROYAL
CHEMICAL**

Casoron is a Reg. TM of
Uniroyal Chemical Company, Inc.

Please read and follow all
label instructions carefully.

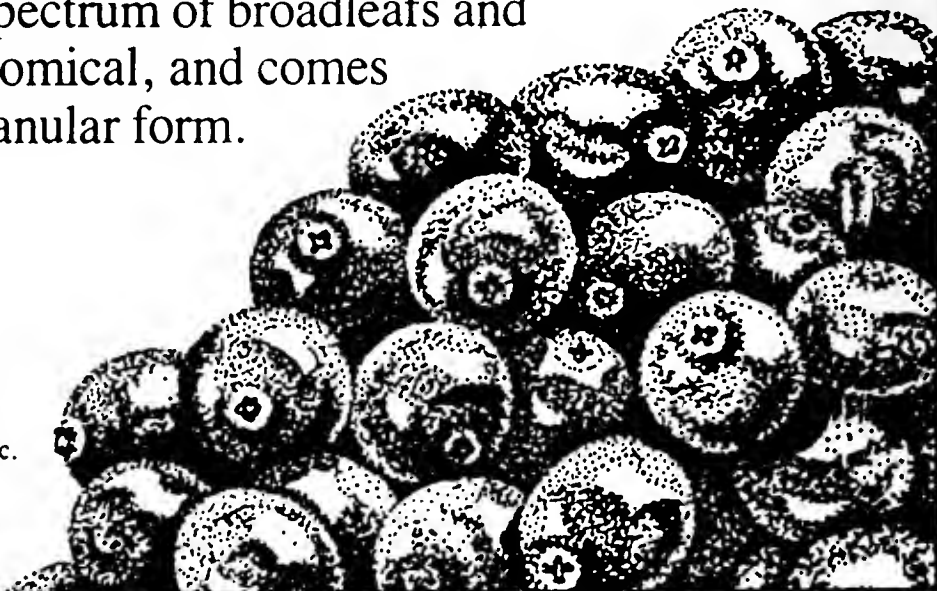

Ocean Spray Pays \$400,000 Fine

Waste Disposal Controversy Settled

By **CAROLYN GILMORE**

"Tough and costly but fair."

That's how John S. Llewellyn Jr., president of Ocean Spray, described the federal court action Dec. 20 in which the cooperative paid fines of \$400,000 after pleading guilty to charges of releasing cranberry peelings and processing wastewater into the Middleborough, Mass., sewer system and the Nemasket River.

Llewellyn called the settlement "a warning to all conscientious corporations of the need to comply fully with environmental regulations."

The Ocean Spray president said he regrets the incidents that led to the court case and accepts personal responsibility for them. He added that "at no time was there any danger to public health, in the period in question."

The period in question was 1983 to 1987. The cooperative was indicted in January 1988 on 78 counts—

including six felony charges—of violating the federal Clean Water Act. Ocean Spray pleaded innocent to the charges, which could have brought fines as high as \$2.1 million.

The Clean Water Act was amended in 1987 to make it a felony to discharge raw waste material into sewers. Ocean Spray became the first company charged with a felony under the amended act.

Under a plea agreement accepted by U.S. District Court Judge David S. Nelson, 57 of the charges, including the six felony counts, were dropped. In addition to the fines, Ocean Spray has agreed to buy a sludge press worth more than \$100,000 for the Middleborough sewer plant.

Middleborough had claimed that the acidic quality of the processing discharges was inhibiting bacterial action in the sewer plant.

"I'm thrilled to death," John Healey, Middleborough's town manager, told the *Boston Globe* after the settlement. He said he's convinced that the company was not aware of the impact of the discharges on the town's sewer system.

Ocean Spray says that since 1986

it has spent or is committed to spend more than \$5 million on equipment "to meet and exceed environmental requirements." An Ocean Spray spokeswoman said the treatment equipment at the new Kenosha, Wisc., receiving station, for example, "is state of the art."

Since 1987, the cooperative has been under orders by Massachusetts to develop a pretreatment system to process waste at its Middleborough plant. Plans are expected to be approved by the state soon and the pretreatment facilities are expected to be operational by the next harvest.

In a press statement following the court decision, Michael R. Deland, regional administrator for the Environmental Protection Agency, said Ocean Spray has been "working cooperatively" with his agency, the state Department of Environmental Quality Engineering and the town of Middleborough.

Robert D. Keefe, Ocean Spray attorney, said the cooperative "cares deeply about the environment because cranberries rely on land and water."

CRANBERRIES

THE NATIONAL CRANBERRY MAGAZINE

SEND CORRESPONDENCE TO:

**P.O. BOX 249
COBALT CT 06414
(203) 342-4730**

PUBLISHER & EDITOR: BOB TAYLOR

**ASSOCIATE EDITOR: CAROLYN GILMORE
(508) 763-5206**

ADVISORS & CORRESPONDENTS

MASSACHUSETTS — Irving E. Demoranville, Director, Cranberry Experiment Station.

NEW JERSEY — Phillip E. Marucci, Cranberry & Blueberry Specialist, Buddtown; Elizabeth G. Carpenter, Chatsworth.

NOVA SCOTIA — Robert A. Murray, Horticulturist, Berry Crops, Research Station, Truro.

OREGON — Arthur Poole, Coos County Extension Agent, Tillamook.

WASHINGTON — Azmi Y. Shawa, Horticulturist and Extension Agent in Horticulture, Coastal Washington Research & Extension Unit, Long Beach.

WISCONSIN — Tod D. Planer, Farm Management Agent, Fond du Lac County.

CRANBERRIES is published monthly by Diversified Periodicals, Wellwyn Drive, Portland CT 06480. Second class postage paid at the Portland, Conn. Post Office. Price is \$15 a year, \$28 for two years, \$2 a copy in the U.S.; \$17 a year in Canada; \$20 a year in all other countries. Back copies: \$2.50, including postage. Copyright 1988 by Diversified Periodicals.

ISSN: 0011-0787

Postmaster, send Form 3749 to:

CRANBERRIES

P.O. BOX 249

COBALT CT 06414



Vines For Sale

**PITT MEADOWS FARMS
LIMITED PARTNERSHIP
2851 No. 8 ROAD
RICHMOND, B.C. V6V 1S2**

STEVENS..... \$3,750 a ton
CROWLEY..... \$3,750 a ton

Prices are F.O.B.
CANADIAN FUNDS

\$300 a ton less with 25% payment
before cutting

Call for large order pricing
(604) 278-6271

editorial



All's Well That Ends Well

Corporate astuteness might properly describe the way John S. Llewellyn Jr. reacted to the paddling Ocean Spray took in federal court Dec. 20.

Mealy-mouthedness, petty carping so often follow adverse findings. The cooperative president would have none of that.

"Tough" but "fair" he said of the settlement.

Putting the whole matter into a wider perspective, he said the case serves as "a warning to all conscientious corporations of the need to comply fully with environmental regulations."

Ocean Spray has spent—or is about to spend—a total of \$5 million to treat processing wastes. When everything is in place, the cooperative might well serve as a model of corporate responsibility.

Without in any way justifying the smallest act of environmental carelessness, we can't help but note the irony that this first case brought under the amended Clean Water Act did not involve toxic wastes. In our meanderings up and down some of the waterways in the Northeast—the Connecticut River, for example—we have seen untreated discharges that look considerably more threatening than cranberry peelings.

The answer to why Ocean Spray became a target might be implicit in a remark by U.S. Attorney Frank McNamara, who said the cooperative's prosecution "was necessary to force a powerful Fortune 500 company to cease its history of pollution."

When you're big—and well known—you sometimes have to pay a price.

Be that as it may, everything has ended well.

The town of Middleborough has valuable new waste treatment equipment. Ocean Spray took a paddling but penalties might have been considerably stiffer. And EPA has a precedent in its books with which it can go after some really dangerous offenders.

Ocean Spray is well rid of the case. Its energies and resources can now be concentrated on maintaining an uncompromised environmentally sound image. And such an image is crucial to the welfare of the industry.

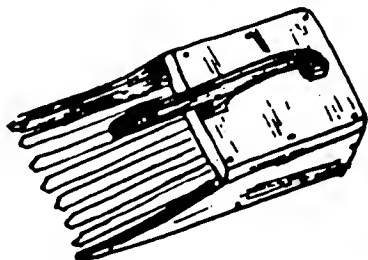

YANKEE PLANNERS, INC.

59 North Main Street
Middleboro, MA 02346
(508) 947-0527

Sound and Objective
Advice
Suited to
Your Needs

- *Tax and Estate Planning*
- *Investment & Insurance Review*
- *Business Continuity*
- *Asset Protection*
- *Key Employee Retention*
- *Business Tax Analysis*

Mr. William H. Bestgen, Jr.
Chartered Financial Consultant

Mr. Peter W. Hutchings
Attorney at Law practicing as
a Tax Attorney

Mr. Roger H. Parent, Jr.
Accountant, Enrolled to Practice
before the Internal Revenue
Service

Call For Your Free Brochure
(508) 947-0527

Juice Companies Call For 'Full Disclosure' Labeling

By CAROLYN GILMORE

Fruit juice companies representing more than 30 percent of the industry have joined Ocean Spray in calling for "full disclosure" labeling on all fruit and vegetable juices.

This effort could help resolve a 15-year controversy over what consumers should be told about fruit juice content.

The National Food Processors Association announced in December it will petition the federal Food & Drug Administration (FDA) to drop a proposal requiring percentage juice labeling in favor of another rule to include declaration of nutritional labeling along with total juice content.

The proposal is sought by Ocean Spray Cranberries as an alternative to the percentage labeling rule which has been pending before the FDA in one form or another for 15 years.

A task force of eight juice makers, including Ocean Spray, met in San Francisco in December to try to resolve the controversy. This marks the first time juice companies have endorsed the full disclosure concept.

The other companies are: Del Monte, National Fruit Product Co. Inc., General Foods (owners of Kool-Aid), Tree Top Inc., Clement Pappas & Co., Dole Package Foods and Campbell Soup Co. Together they represent more than 30 per-

cent of juice sales nationally, according to Ellen Morton of the 600-member National Food Producers Association.

The association's labeling plan would feature:

- a petition to the FDA to require makers of both diluted and 100 percent juice beverages to list juice content on the container;

- legislation in Congress to change the federal Food, Drug & Cosmetic Act to require full nutritional labeling on all juice products.

Currently manufacturers must list nutritional data only if they make a specific nutritional claim or if nutrients are added.

K Ag Laboratories International, Inc.

2323 Jackson Street
Oshkosh, WI 54901

Serving Cranberry
Growers in U.S.A.
& Canada since 1984

Over 20 years
of Experience on
Acid Soil Interaction

K Ag Laboratory has
run over 30,000
cranberry soil and over
17,500 cranberry vines
tests since 1984, and
gave fertilizer
recommendations with
great success.

- ★ **Cranberry Soil Analysis**
- ★ **Cranberry Vine Analysis**
- ★ **Cranberry Water Analysis, Usage & Interpretation**
- ★ **Liquid & Dry Fertilizer Recommendation**
- ★ **Soil Problems & Consultation**
- ★ **Seminars**
- ★ **Cranberry Crop Monitoring Program, testing and monitoring nutrient status with 30 day intervals during during the growing season.**

Highly computerized cranberry soil, tissue and water testing program in U.S.A. and Canada.

For more information contact: **Dr. Akhtar Khwaja, Ph.D.**
Certified Professional Soil Scientist
Certified Professional Agronomist

Phone Number 414-426-2220; Out of WI 1-800-356-6045; FAX 414-426-2222

REGIONAL NOTES

MASSACHUSETTS

By IRVING E. DEMORANVILLE

Unofficially, the Massachusetts crop appears to be about 1,900,000 barrels, which is 4 percent above the August estimate and somewhat over 30 percent larger than the 1987 crop.



The Christmas Light Festival at Edaville Railroad in South Carver this year featured 30 holiday scenes and 200,000 lights. The attraction provides a 5½ mile railroad ride through an 1,800 acre cranberry plantation.

WASHINGTON

Millie DeFord's Cranberry House in Long Beach, Wash., features homemade cranberry fudge. Millie mails the fudge—with or without nuts—all over the country.

Weather

MASSACHUSETTS

November was warm and wet. Temperatures averaged 1.6 degrees a day above

normal. Maximum temperature was 66 degrees on the 5th and the minimum was 21 degrees on the 23rd.

Rainfall totaled 8.55 inches or about 4 inches above normal. This was the third largest in our records, the most since 1945 and 1944. There was measurable precipita-

tion on 11 days, with 2.88 inches on the 27th-28th as the greatest storm. We are about an inch above normal for the year and the same amount ahead of 1987.

There was no measurable snowfall—not unusual.

I.E.D.

Irrigation Supplies

- 2" to 12" PVC Pipe with Fittings
- Quick Couple Risers
- Felker Aluminum Flumes & Culverts

Replace old aluminum mains with government approved 4", 6" and 8" polyethylene pipe buried just below bog surface. No insert fittings. Rent our butt fusion welder for a continuous main line. Beat the high cost of custom installation by renting our small 4-wheel drive tractor with mole hole plow for buried laterals.

STEARNS IRRIGATION, INC.
790 Federal Furnace Rd.
Plymouth MA 02360
Tel. (508) 746-6048

Turf

Equipment, Inc.

381 West Grove St. (Rte. 28)
 Middleboro, MA 02346
 (508) 947-6299

KUBOTA
 Tractors, Excavators and Diesel Generators

COYOTE
 Wheel Loaders
 3/4 Yd - 6 1/2 Yd

malcom
 Screening Equipment

Vines For Sale

Early Blacks _____	\$2,500 a ton
Stevens _____	\$4,000 a ton
Howes _____	\$2,500 a ton
Crowley _____	\$3,500 a ton

Prices F.O.B.

R.M. Lawton Cranberries, Inc.
221 Thomas St.
Middleboro, MA 02346
(508) 947-7465

Ex-Bog Owner Wins Lion's Share of Prizes



LORRAINE CARR displays the numerous ribbons, the rosette and the silver tray she won in the 1988 Make It Better With Cranberries cooking contest. (CRANBERRIES photo by Carolyn Gilmore)

By CAROLYN GILMORE

Lorraine Carr of Rochester, Mass., who formerly owned a bog with her husband, proved not only once but many times that she can "make it better with cranberries."

Mrs. Carr won best of show for her Cranberry Almond Creme Pie in the 12th annual "Make It Better With Cranberries" cooking contest held Oct. 1.

She also won first prizes for pies, cookies, muffins and bars and squares. And she landed seconds in dessert cakes, breads, coffee cakes

G Gapen

Realty & Insurance

Knowledge & ability to unite buyers and sellers for existing marshes or undeveloped land.

2141 8th Street South
Wisconsin Rapids,
Wisconsin 54494
(715) 423-6550



Multiple Listing Service
MLS



**WISCONSIN CRANBERRY
HEADQUARTERS FOR
SEVIN XLR**

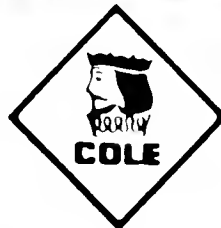

DEVIRINOL 10G • EVITAL • GUTHION
DIAZINON 14G • PARATHION • ETHREL

Cole/Grower Service

537 Atlas Ave., P.O. Box 7211, Madison, WI 53707
(608) 221-6204 or 1-800-362-8049

VINES FOR SALE

*Howes and
Early Blacks*

CALL

(617) 428-6101

Or

(617) 428-0907

After 6 p.m.

and other creative ways of using cranberries in everyday cooking

The contest was sponsored by the Cape Cod Cranberry Growers Association, the Massachusetts Department of Food and Agriculture and the Cranberry World Visitors Center. Grower Dorothy Angley, assisted by Charlene Lawson, organized and produced the event this year.

Mrs. Carr also was a heavy winner in the 1986 contest, in which her Cranberry Pineapple Pie captured first prize.

"I love cranberries," Mrs. Carr said. "I find them easy to adapt to a variety of uses."

Besides cranberry cooking contests, the Rochester woman has a long record of successes in other cooking contests, including a catfish cooking contest in 1986 that won her a trip down South. She also won *The* (New Bedford, Mass.) *Standard Times* Cooking Contest in 1988. She will join the judging team for the 1989 cranberry cooking contest.

"I'm a better cook on paper," she said. "In the kitchen, I'm average. Everything I cook is easy."

For Mrs. Carr, "taste is the most important" recipe ingredient, closely followed by appearance. An artist by training, she runs a thriving crafts business, for which she hand-crafts such items as dolls, pillows and stenciled rugs.

Another first prize winner was Irene Varecchia of Riverside, Rhode

Island, who took the awards in the cranberry dessert cakes and any other way categories. Her recipes were Cranberry Glazed Tart and Cranberried Beans. She also placed in the pies and cookies categories.

Judging the event were Joan Garretson, cranberry grower; Liz O'Donoghue, home economist,

Vines For Sale

Ben Lear	\$3,500 a ton
Stevens	\$3,500 a ton
Crowley	\$3,500 a ton
Le Munyon	\$3,500 a ton
Searles	\$3,500 a ton

\$500 a ton less with 50% payment before cutting

*Lake Nokomis
Cranberries, Inc.*

David Zawistowski, Owner

6031 County Highway D (715) 479-4658
Eagle River, WI 54521 (715) 479-6546



Plymouth Copters, Ltd.

Growers fertilizers, herbicides and pesticides applied to growers specifications
Mud Lifting - Cranberry Lifting
Mats Available

Plymouth Airport
Box 3446
Plymouth, MA 02361

David J. Morey
Richard H. Sgarzi
(508) 746-6030

Agricultural Applications • Lift Work • Executive Charters • Aerial Photography

Plymouth County Extension Service, and Sonia Young, pastry chef, Chmuras Bakery, Springfield, Mass. Young also gave a demonstration of how to make Cranberry Baklava.

To obtain a copy of all the winning recipes, send a large (#10) self-addressed, stamped envelope to "MIBwC," c/o Dorothy Angley, P.O. Box 270, Carver, MA 02330. Send a separate envelope for each set of recipes desired.

Prospective entrants for the 1989 contest can obtain information and entry blanks from the same address. Entry blanks will be mailed in early September.

Below are the prizewinning recipes.

CRANBERRY PIES

FIRST PRIZE: Cranberry Almond Creme Pie

Lorraine Carr, Rochester, Mass.
 9" pie shell
 1 cup fresh cranberries
 1/2 cup light corn syrup
 1/2 cup orange, seeded but not peeled, ground in food processor
 1/4 cup butter or margarine, softened
 1/2 cups confectioners' sugar
 1 egg
 1 teaspoon almond extract

GARNISH (optional): 1 tablespoon almonds, toasted
 1 tablespoon candied orange peel

Prepare and bake pie shell. Cut out and bake decorative shapes from leftover crust to use as garnish. Combine cranberries, corn syrup and orange in a medium saucepan. Cook on medium heat until berries pop and mixture thickens. Set aside to cool. Using a mixer, cream butter and sugar until fluffy. Beat in egg and extract. Spread filling into cooled pie shell. Top with cranberry orange mixture. Garnish with baked decorations, toasted almonds and candied orange peel. Yield one pie.

SECOND PRIZE: Cranberry-Rhubarb Pie

Bernard Lacouture, Cataumet, Mass.
 Pastry for 9" two-crust pie
 2 eggs, slightly beaten
 1/2 cup milk or cream (optional)
 1/2 cup sugar
 1/2 cup flour
 1/2 teaspoon cinnamon
 1/2 teaspoon nutmeg
 1/2 teaspoon ash salt
 1/2 cups fresh cranberries, finely chopped
 1/2 cups rhubarb, finely chopped
 1/2 cup butter or margarine
 1/2 cup milk
 1/2 cup powdered sugar

Preheat 9 inch pie pan with 1/2 of the pastry; use the other half of the pastry for lattice top. In a medium mixing bowl, combine eggs, 1/4 cup milk or cream, sugar, flour, spices and salt. Mix in cranberries and rhubarb. Pour into

pie shell. Dot with butter. Make lattice top. Combine 1 tablespoon milk with juice remaining in bowl and brush over crust. Bake 50-60 minutes or until golden brown. Cool pie completely. Sprinkle with powdered sugar. Chill. Serve with whipped cream or ice cream. Yield one pie.

THIRD PRIZE: Cranberries Blueberries Pie

Irene Varrecchia, Riverside, R.I.

Pastry for a 9" double crust pie
 1 cup sugar
 1 cup water
 1 package fresh cranberries
 1 can blueberry pie filling

Preheat oven to 450 degrees. Line pie pan with pastry; roll out top crust. In a medium saucepan, combine sugar and water; bring to a boil, stirring to dissolve sugar. Add cranberries, return to boil. Reduce heat and boil gently until berries pop, stirring occasionally. Cool completely. Stir in blueberry pie filling. Pour into pastry lined pie pan; cover with top crust, seal and vent. Brush top with milk and bake for one hour or until golden brown. Yield one pie.

CRANBERRY COOKIES

FIRST PRIZE: Cranberry Crunchies

Lorraine Carr

COOKIES
 1/2 cup butter
 3/4 cup sugar
 1 cup oats
 1 teaspoon baking powder
 3 tablespoons flour
 1/2 teaspoon salt
 1 egg
 FILLING
 3 heaping tablespoons marshmallow creme
 1/2 cup butter or margarine, softened
 1 cup powdered sugar

1/2 teaspoon vanilla
 Milk to thin, if needed
 1 cup fresh cranberries, chopped

Filling: Beat marshmallow and butter until fluffy. Beat in sugar and vanilla; add milk to thin if needed. Stir in cranberries. Set aside.

Cookie: Preheat oven to 375 degrees. Grease and flour cookie sheets. Melt butter in a saucepan. Remove from heat; stir in sugar, baking powder, flour, salt and egg. Cool 10 Drop by teaspoonfuls onto cookie sheets, 3 apart. Bake for 8 minutes. Quickly remove from cookie sheet to a rack. If cookie sticks to sheet, return to oven 1-2 minutes. When cool, spread filling on half of the cookies and top with the other half.
 Yield 2 dozen cookies.

SECOND PRIZE: Cranberry Party Cookies

Irene Varrecchia

COOKIE: 2/3 cup butter or margarine, softened
 1/3 cup sugar
 2 egg yolks
 1 teaspoon vanilla
 1 1/2 cup flour
 1/4 teaspoon salt
 2 egg whites
 3/4 cup finely chopped walnuts
 FILLING
 1 1/2 cups fresh cranberries
 1/4 cup orange juice
 3/4 cup sugar
 1 1/2 teaspoons cornstarch
 1 tablespoon water

Filling: In a covered saucepan on medium heat, cook cranberries, orange juice and sugar until the berries pop. Combine cornstarch and water; add to cranberry mixture. Cook until mixture thickens, approximately 2 minutes. Chill.

Cookie: Preheat oven to 350 degrees. In a medium mixing bowl, cream butter and sugar. Beat in egg yolks and vanilla. In a separate bowl, combine dry ingredients;



ABEL'S APIARIES

*Strong Beehives Available
 For Cranberry Pollination
 Truckload Lots*

Call or Write:

Abel's Apiaries
P.O. Box 234
Sydney, Florida 33587
Phone (813) 659-0784 or
(301) 592-9712

add to egg mixture, mixing thoroughly. Cover and chill one hour. Shape dough into 1 inch balls. Roll each ball in egg whites, then in nuts. Place 1 inch apart on ungreased cookie sheets. Bake 15-17 minutes or until golden brown. Cool on racks. Yield 2 dozen cookies.

THIRD PRIZE: Halloween Harvest Cookies

Paula Parentisis, West Wareham, Mass.

½ cup margarine
6 tablespoons light brown sugar
6 tablespoons granulated sugar
1 egg
1¼ cups flour, sifted
½ teaspoon baking soda
½ teaspoon salt
½ teaspoon vanilla extract
¼ teaspoon orange extract
½ cup chocolate covered raisins
½ cup chocolate covered peanuts
1 cup fresh cranberries, finely chopped

Preheat oven to 375 degrees. Lightly grease cookie sheets with salad oil. Cream margarine and both sugars; beat in egg. Sift dry ingredients together and add to creamed mixture. Combine vanilla and orange extracts and cranberries; stir into batter. Fold in nuts and raisins. Drop batter by small teaspoonfuls onto cookie sheets (about 20 to a sheet). Bake for 12-15 minutes or until golden brown and firm to the touch. Yield approximately 4 dozen 2" cookies.

"These cookies were the result of an over-supply of chocolate covered raisins and peanuts one recent Halloween. I thought it

might be interesting to see what could be done with them."

CRANBERRY BARS AND SQUARES

FIRST PRIZE: Cranberry Pineapple Squares

Lorraine Carr

CRUST
1 cup butter, softened

½ cup powdered sugar
2 cups flour
TOPPING
½ cup brown sugar, packed
¼ cup flour
¼ cup butter, softened
¾ cup nuts, chopped
FILLING
1 20-ounce crushed pineapple in syrup, drained, reserving 1 cup syrup
3 cups fresh cranberries
1½ cups sugar

Turf **Equipment Inc.**
381 West Grove Street (Rte. 28)
Middleboro, MA 02346

KUBOTA Diesel Equipt.

Tractors 2 & 4 wheel drive — 12-90 hp.
Compact Excavators 1½ to 6 ton
Wheel Leaders ½ to ¾ yd.
Water Cooled Diesel Engines 4 to 104 hp.

All Types of Implements
Polymark Beaver-Mowers 947-6299
Specialty Fabrication Work
Kubota Financing as Low as 8½%

*Sales *Service *Parts *Leasing



Office
295-2222

K. Beaton
295-2207

**BEATON'S
CRANBERRY
GROWERS SERVICE**



WAREHAM, MASS.

D. Beaton
888-1288

P. Beaton
947-3601

Specializing in

○ COMPLETE BOG
MANAGEMENT

○ NETTING

○ DITCHING

○ HARVESTING
(Wet & Dry)

○ SANDING

○ CUSTOM
HERBICIDE
APPLICATION

Complete line of portable Crisafulli Pumps 2" - 16"
Plastic netting for suction boxes





THE BEST — IN EVERY RESPECT

CRANBERRY Model 400 GT

Precision Chemigation System

SPECIAL DISCOUNTS
AVAILABLE FEBRUARY



- Developed *Exclusively* for the Cranberry Industry
- Exceeds or Meets ALL Current EPA Requirements
- Simple to Operate and Easy to Calibrate
 - Self-Timer Application (1 minute increments)
 - Easy Access Handle & Simple Reference Scale
 - Precise Visual Flow Calibration
- Outstanding Field Performance
 - Down-Line Venturi Injection System
 - High Capacity 0-7 GPM Injection Rate
 - Large Volume 175 Gallon Mix Tank
 - 12 Volt Gear Reduction Mixer
- Designed for Trouble-Free Operation
 - Reliable 11 HP Honda Electric Start Engine
 - Critical Components Are Stainless Steel & Polypropylene
- Completely Self-Contained and DOT Approved Transportable
- Personalized, Experienced Support Service as Close as Your Phone

CHEMIGATION SYSTEMS INTERNATIONAL, INC.

Corporate Offices: P.O. Box 247
(608) 297-2041

Montello, WI 53949
FAX: (608) 297-7248

Call us today for the dealer nearest you, or contact:

Skip Tenpas
Central Sands Irr. & Bldg., Inc.
Hwy 51 & 73 Interchange
Plainfield, WI 54966
(715) 335-6372

Bruce Sunnerberg
AAA Industrial Pump & Ser., Inc.
66 Lake Street
Plympton, MA 02367
(617) 585-2394

NOTICE

Selected exclusive
dealer territories
still available —

Inquiries invited

Crust: Preheat oven to 350 degrees. Combine butter, powdered sugar and flour. Pat into an 8 x 12 pan. Bake 20 minutes or until lightly browned.

Filling: In a medium saucepan, combine cranberries and syrup; cook on medium heat until berries pop. Combine cornstarch and sugar; add to cranberry mixture, stirring until thickened. Remove from heat and stir in pineapple. Pour over baked crust. Combine topping ingredients and sprinkle over cranberry layer. Bake 20 minutes or until tests done. Cut into squares and serve with cream.

Yield 24 bars.

SECOND PRIZE: Cranberry-Pecan Bars

Suzanne Gigliotti, Duxbury, Mass.

CRUST

- 2 cups flour, sifted
- 1 teaspoon salt
- 1½ cups sugar
- 1¼ cups margarine, softened
- 3 cups oats

FILLING

- ¾ cup sugar
- ½ cup water
- 2 cups fresh cranberries
- 1 tablespoon lemon peel, grated
- ¼ cup lemon juice
- 1 tablespoon butter
- ½ teaspoon cinnamon
- ¼ teaspoon salt
- 1 cup pecans, chopped

Filling: In a heavy saucepan, combine sugar and water, bring to a boil. Add cranberries and cook on medium heat until they pop. Add ingredients except pecans; cook over medium heat until thickened, about 5 minutes. Remove from heat; cool to room temperature. Stir in pecans.

Crust: Preheat oven to 350 degrees. Sift together flour, salt and sugar. Cut in margarine until mixture resembles coarse crumbs. Add oatmeal and mix thoroughly. Firmly pat 3½ cups of this mixture into an ungreased 9 x 13 pan. Spread cooled filling over dough and cover evenly with the remainder of crumbs. Bake 30-40 minutes or until lightly browned. Cool and cut into bars.

Yield 24 bars.

THIRD PRIZE: Cranberry Squares

Barbara Cabral, Middleboro, Mass.

- 1½ cups flour
- 1½ cups sugar
- 2 eggs, well beaten
- 1 cup butter or margarine, melted
- 1 cup nuts, chopped
- 2 cups fresh cranberries

Preheat oven to 325 degrees
Grease and flour a 9 x 13 pan. Thoroughly mix the first four ingredients; add nuts and cranberries. Bake for 40-50 minutes or until lightly browned. Cool and cut into squares.
Yield 24 bars.

CRANBERRY DESSERT CAKES

FIRST PRIZE: Cranberry Glazed Tort

Irene Varrecchia

CAKE

- 1 cup butter, softened
- 2 cups sugar

- 2 cups flour
- 3 teaspoons baking powder
- ½ teaspoon salt
- 4 eggs
- 1 cup milk

- 1 teaspoon vanilla
 - ½ teaspoon almond extract
- FILLING**
- 1½ cup fresh cranberries
 - ¼ cup orange juice

Law Offices of
James Taylor Pye

James Taylor Pye
David Churchill Barrow
James S. Hartford

24 Bay Road/P.O. Box 2899
Duxbury, Massachusetts 02331
617-934-6575

Bog renovation and Bog development
(Conservation Commission, DEQE, Mass EPA, EPA and Corps of Engineers)

Business, retirement and estate planning
(Incorporations and partnerships, pensions and profit sharing plans, and Wills and Trusts)

Land disposition
(Purchase, sale and financing of existing bogs and potential sites)

Land use management
(Board of Appeals and Planning Board)

Cranberry Originals

T-Shirt
"CRANBERRIES
North America's Native Fruit"

An Original Botanical Design
of Blossoms and Green & Ripe Cranberries
by
Ann Kox: CRANBERRIES

Adult T-Shirt (Sizes S, M, X, XL)	\$12
Adult XXL T-Shirt	\$14
Youth Size 14-16 T-Shirt	\$11
Children's Sizes 4, 6-8, 10-12	\$11
Adult Sweatshirt (S, M, X, XL)	\$25
Adult XXL Sweatshirt	\$28
Youth 14-16 Sweatshirt	\$21
Children's Sweatshirt (4, 6-8, 10-12)	\$19

Send Check or Money Order to:
CRANBERRIES
P.O. Box 249
Cobalt, CT 06414
Add \$3.50 Shipping & Handling Charge
For Canadian orders, add \$8

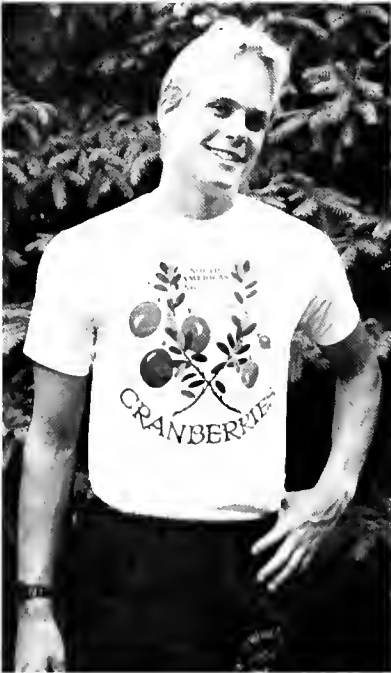

NAME

ADDRESS

CITY STATE ZIP

1/4 cup sugar
 1/2 teaspoons cornstarch
 1 tablespoon water
 1/2 teaspoon lemon peel
ICING
 1 pound powdered sugar
 1 stick butter, softened
 Dash salt
 1 teaspoon vanilla
 3 tablespoons milk

Preheat oven to 350 degrees. Grease a 9 inch cake pan. In a medium mixing bowl, using a mixer, cream butter; add sugar, beating until light and fluffy. In a separate bowl, sift flour, baking powder and salt. Set aside. Add eggs, one at a time, to the creamed mixture. Add flour alternately with milk and vanilla; beat until smooth. Pour batter into pan. Make cupcakes with the remaining batter. Bake 25-30 minutes or until it tests done. Cool completely. In a medium mixing bowl, using a mixer, combine all of the icing ingredients. Cut cake in half to form 2 layers. Spread a generous layer of icing on the top of bottom layer. Place top layer on top of icing. Spread glaze on top of cake. Spread icing on sides of cake. Use remaining icing for cupcakes. Yield one 9" layer cake.

SECOND PRIZE: I Love Cranberries Cake

Lorraine Carr

CAKE
 1 cup butter
 1/2 cups sugar
 1 teaspoon vanilla
 1 1/2 cups flour
 1 1/2 teaspoons baking powder
 1 cup milk
 4 egg whites, stiffly beaten
 1/4 cup fresh cranberries, chopped
 1/2 cup nuts

FILLING
 1 cup fresh cranberries
 1/4 cups sugar
 1/2 teaspoon cinnamon

FROSTING
 1/4 cup butter, softened
 1/8 teaspoon salt
 1 cup shortening
 1 cup powdered sugar
 1/2 teaspoon almond extract
 1 cup coconut

Preheat oven to 350 degrees. Grease two 8" round cake pans. Using a mixer, cream butter until fluffy. Gradually add sugar and beat on medium speed for about 10 minutes. Beat in vanilla. Combine flour and baking powder; add to creamed mixture alternately with milk. Fold in egg whites, cranberries and nuts. Pour into pans and bake for 30-35 minutes or until cake tests done. Turn out on racks to cool. While cake is baking, prepare the filling. In

a medium saucepan, combine the filling ingredients and bring to a boil. Lower heat and simmer 5 minutes, stirring occasionally until the berries have popped and mixture has thickened. Drain mixture and let cool. While cake is cooling, prepare the frosting. In a medium mixing bowl, cream butter, salt and shortening with 1 cup of powdered sugar. Gradually add remaining sugar and extract; mix well.

To assemble, spread 1/2 of the cranberry filling on the top of one cake. Top with remaining cake. Spread frosting on top and sides of cake. Place some frosting in a pastry bag with star tip. Pipe stars around top edge. With toothpick, mark heart shape in center of cake. Pipe stars around heart. Fill in heart with remaining cranberry filling. Press coconut onto sides of cake. Yield one 8" two layer cake.

WOLLSCHLAGER EXCAVATING
Dragline Work — All Kinds
Also Have Clam & Scalping Buckets
Route 1 Necedah, WI 54648
1-808-585-2436

Vines For Sale
 Crowley..... \$3,000 a ton
 Searles \$2,500 a ton
 10% discount with 50% payment by March 15
Remainder due on delivery or pickup
G. BROCKMAN, INC.
 4409 Brockman Road
 Vesper, WI 54489
 (715) 423-0368 (715) 423-7016

Lambert, Lee & Associates
CONSULTING ENGINEERS
SURVEYORS

Extensive experience in all aspects of cranberry land development: evaluation, purchase, survey, design, permit acquisition, phased construction and planting both in wetlands and uplands.
 Have references. Will travel.
 Contact: Will Lee
 10948 Highway 54 East
 Wisconsin Rapids, WI 54494
 (715) 424-3131

Subscribe to
CRANBERRIES
\$15 a year
 Send check or money order to:
CRANBERRIES
 P.O. Box 249
 Cobalt, CT 06414

THIRD PRIZE: Cranberry "Surprise" Cake

Gerry Griffith, South Carver, Mass.

CAKE

- 1 cup butter
- 1½ cups sugar
- 2 eggs
- 1 cup sour cream
- 1 teaspoon almond extract
- 2 cups flour
- ½ teaspoon baking soda
- 1¼ teaspoon baking powder

FILLING

- ¾ cup nuts
- 1 teaspoon cinnamon
- 2 tablespoons sugar
- ¾ cup fresh cranberries, chopped

GLAZE (optional)

- 3 tablespoons cranberry juice cocktail
- 2 cups powdered sugar

Preheat oven to 350 degrees. Grease a 9" Bundt pan. In a medium mixing bowl, combine all of the cake ingredients in the order given. Spread half of the batter into the pan. Spread the filling on top. Cover filling with remaining batter. Bake for 1 hour or until tests done. Cool completely. Combine glaze ingredients and drizzle over cake. Yield one 9" Bundt cake.

CRANBERRY BREADS

FIRST PRIZE: Cranberry Banana Bread

Linda Shea, Whitman, Mass.

- 1¾ cup unsifted flour
- 1 tablespoon baking powder
- ¾ cup sugar
- ½ cup shortening
- 2 eggs
- 1 cup bananas, mashed
- 1¼ cups fresh cranberries, coarsely chopped

Preheat oven to 350 degrees. Grease and flour a 9 x 5 loaf pan. Mix flour and baking powder, set aside. In a medium mixing bowl, beat sugar, shortening and eggs together until light and fluffy. Mix in bananas and cranberries. Add dry ingredients to batter, stirring just until smooth. Pour into pan and bake 50-60 minutes or until firmly set and golden brown. Cool in pan 15 minutes before turning out onto a rack. Yield one bread.

SECOND PRIZE: Cranberry Apricot Quick Cake

Lorraine Carr

- 2 cups flour
- ¾ cup sugar
- 3 teaspoons baking powder
- ½ teaspoon cinnamon
- 1 teaspoon salt
- ½ teaspoon baking soda
- 1 cup walnuts, chopped

- 1 egg
- ½ cup applesauce
- ½ cup sour cream
- 1½ cup fresh cranberries, chopped
- ¾ cup canned apricots, drained and chopped
- 2 tablespoons shortening, melted
- GLAZE (optional)
- 1 cup powdered sugar
- 1-2 tablespoons apricot juice

J.A. JENKINS & SON CO.
Grower Service

MOWING (ALL TYPES) DITCHING
SANDING WEED WIPING

Serving Cape Cod

227 Pine St., W. Barnstable, Ma. 02668
Phone 362-6018



N.J. Vines For Sale

CLEAN — PURE
*From Producing Bog With
Excellent Production
Records*

Crowley ... \$3,750 a ton

Lee Bros. Inc.
Chatsworth, NJ 08019
(609) 726-9292 Nite: 726-1214

CRANBERRY



COMPUTER, INC.

CRANWARE

- Growers
- Handlers
- Chemical Applications
- Chemical Resale

(508) 291-1192

2 Tobey Road, Wareham, MA 02571

Preheat oven to 350 degrees. Grease a 9 x 5 loaf pan. Sift dry ingredients together; add nuts. In a medium mixing bowl, beat egg, applesauce and sour cream. Stir in cranberries, apricots and shortening. Blend in dry ingredients into batter, stirring just until moistened. Pour into pan and bake one hour or until tests done. Cool in pan 10 minutes before turning out onto a rack. Cool over-

night. Combine glaze ingredients to desired consistency and drizzle on cake. Arrange walnut halves and frosted cranberries on top as garnish, if desired. Yield one bread.

THIRD PRIZE: Cranberry Rye Bread

Victoria Steponaitis, Middlebury, Conn.

BREAD

3½-4 cups all purpose flour
3 packages dry yeast
2 teaspoons caraway seeds

1/3 cup dry milk powder
2 cups cranberry juice cocktail
½ cup brown sugar
2 tablespoons molasses
2 tablespoons shortening
2 teaspoons salt
2 tablespoons orange rind
2½ cups rye flour
CANDIED CRANBERRIES
2 cups fresh cranberries
1 cup sugar

**Niemi
Electric
Company**



Robert
Niemi
**Electrical
Contractors**

Heat, Light & Power Wiring

- RESIDENTIAL
- COMMERCIAL
- INDUSTRIAL

**Pinehurst Drive
Wareham, Mass.
TEL. 295-1880**



**CEECO
CORPORATION**
OF NEW ENGLAND

Industrial Suppliers To The Cranberry Industry



Chain, Cable and Accessories
Used for Making Mats
All Types of Fasteners (Bulk & Packaged)

Hand Tools	Pumps
Power Tools	Motors
Chemicals	Abrasives
Lubricants	Cutting Tools

Safety Equipment

Richards Rd.
Plymouth Industrial Park

747-0086
Plymouth, MA 02360

Spring 1989



Vines For Sale

**Ben Lear
Crowley
Stevens
Pilgrims**

**\$3,500.00 per ton
\$3,500.00 per ton
\$3,500.00 per ton
\$4,000.00 per ton**

Prices F.O.B.

Contact:

Buy 10 tons, get one ton free.

20% down payment with order.

Call for large order pricing.

**LeRoy Milles
Northland Cranberries, Inc.
(715) 424-4444
251 Oak Street
Wisconsin Rapids, WI 54494**

BREAD

In a large mixing bowl, combine 2½ cups all purpose flour, yeast, caraway seeds and dry milk. Set aside. In a medium saucepan, heat cranberry juice, brown sugar, molasses, shortening and salt to 115-120 degrees, stirring occasionally. Add the heated liquid to the dry ingredients, mixing thoroughly. Stir in orange peel. Using a mixer, beat the dough on low speed for about 1 minute. Increase to high speed and continue beating for about 3 minutes. By hand, stir in rye flour and enough remaining all purpose flour to make a stiff dough. Knead dough on a lightly floured surface for about 8-10 minutes. Shape into a ball and place in a greased bowl; turn dough over to grease other side. Cover and let rise until doubled in size. Punch dough down. Let dough rest 10 minutes.

CANDIED CRANBERRIES

Preheat oven to 250 degrees. Spread cranberries in a jelly roll pan or shallow baking pan. Sprinkle with sugar. Cover with foil and bake for about one hour, stirring several times during baking. Cool berries. Store in a tightly covered container. Use in breads, muffins, cakes, etc.

ON A LIGHTLY floured surface, work candied cranberries into dough. Roll lightly jelly roll style and place in angel food cake pan or into 2 9 x 5 loaf pans. Cover and let rise until doubled in size. Bake at 375 degrees for about 30-40 minutes or until golden brown. Place bread on rack and rub with butter if desired. Cool. Yield 1 ring or 2 loaves.

CRANBERRY MUFFINS

FIRST PRIZE: Cranberry Peach

Streusel Muffins

Lorraine Carr

½ cup fresh cranberries

¼ cup light corn syrup

½ cup butter

1 cup sugar

2 eggs

2 cups flour

2 teaspoons baking powder

½ teaspoon salt

½ cup sour cream

1 teaspoon vanilla

1 medium peach, peeled & cubed or

¾ cup canned or frozen streusel

TOPPING

¼ cup brown sugar, packed

2 tablespoons flour

2 tablespoons butter

1/3 cup pecans, chopped

Preheat oven to 375 degrees. Grease muffin pans. In a medium saucepan on medium heat, combine cranberries and syrup and cook until berries pop. Drain and set aside. With a mixer on low speed, cream butter and sugar until fluffy; beat in eggs. Sift together dry ingredients and add alternately with sour cream and vanilla to the creamed mixture. Stir peach and cranberries into batter. Spoon into muffin cups. Combine topping ingredients and sprinkle over muffins. Bake for 30 minutes or until tests done. Cool in pan for 30 minutes. Yield approximately 15 muffins.



VOLM BAG COMPANY, INC.

1804 EDISON ST. BOX B, ANTIGO, WIS. 54409-0116
PHONE 715/627-4826

SUPPLYING AGRICULTURAL CHEMICALS

BRAVO - SEVIN - FUNGINEX - ORTHENE
CASORON - GUTHION - DEVRINOL - PARATHION

AND

**DELIVERING A COMPLETE LINE OF FERTILIZER
WITH FAST FRIENDLY SERVICE!!!**

CASORON FREE

Vines For Sale

NO DODDER

Ben Lears \$4,500 a ton

*Orders paid in advance
by February
receive a 10% discount.*

60 Tons Available

**Jonjak Cranberry Farm Inc.
Hayward, Wisconsin**

**Call Randy Jonjak
(715) 634-3979**

TRUE VARIETIES

Stevens \$4,000 a ton

*Orders paid in advance
by February
receive a 10% discount.*

30 Tons Available

**Cranberry Springs Inc.
Hayward, Wisconsin**

**Call Stanley Roy Jonjak
(715) 634-3044
(715) 634-3286**

HONEST WEIGHTS

SECOND PRIZE: Lazy Morning Muffins

Paula Parentisis

- 1 19-ounce package Duncan Hines "Bakery Style" Bran & Honey Nut Muffin Mix
- 1 egg
- 3/4 cup water
- 1 12-ounce tub Ocean Spray Cran•Fruit Cranberry Orange Sauce

Preheat oven to 375 degrees. Grease muffin pans. Follow mixing directions on muffin package; let sit for 2-4 minutes until batter is slightly thickened. Fill each muffin cup 3/4 cup full of batter. Place scant teaspoonful* of Cran•Fruit Sauce in center of each muffin cup, taking care to keep away from edges of cups. Cover with remaining batter; sprinkle with topping. Bake for 16-18 minutes or until muffins test done. Yield 12-14 2 1/2" muffins.

*teaspoon refers to tableware, not measuring spoons.

THIRD PRIZE: Cran-Walnut Muffins

Jerry Griffith

- 1/2 cup butter
- 1/2 cups sugar
- 2 eggs
- 1/4 cups flour
- 2 teaspoons baking powder
- 1/2 teaspoon salt
- 1/2 cup milk
- 1/2 cup nuts, chopped
- 1/2 cups fresh cranberries, chopped

Preheat oven to 350 degrees. Grease muffin pans. Cream butter and sugar until fluffy. Blend in eggs, flour, baking powder and salt. Add milk, mix thoroughly. Stir in nuts and cranberries. Bake for 25-30 minutes or until golden brown. Yield 18 muffins.

COFFEE CAKES

FIRST PRIZE: Kelly's Cranberry Bun

Race Andruk, Bridgewater, Mass.

- 1 package dry yeast
- 1 cup warm water
- 2/3 cup shortening
- 1/2 teaspoon salt

The CHARLES W. HARRIS Company
 451 Old Somerset Avenue
 North Dighton, Mass.
 Phone 824-5607

AMES
 Irrigation Systems

RAIN BIRD
 Sprinklers

HALE
 Pumps

*Highest Quality Products
 With Satisfaction Guaranteed*

Cranberry Cleaning Equipment

- 2,000 lb. feed bin •
- Chain conveyors •
- Wire mesh conveyors •
- 6,000 lb/hr flow dryer •
- Belt degrasser •
- Hayden separators •
- Wire bog conveyor & loader •

Lee Bros. Inc.
 Chatsworth, NJ 08019
 (609) 726-9292



Vines For Sale

Ben Lear	\$5,000 a ton
Stevens	\$4,000 a ton
Crowley	\$4,000 a ton
Bergman	\$4,000 a ton

Prices are F.O.B.
 \$500 a ton less with 50% payment before cutting

Richberry Farms Ltd.

11280 Mellis Drive	Res. (604) 273-4505
Richmond, B.C.	Bus. (604) 273-0777
V6X 1L7 Canada	

¼ cup sugar
 1 cup milk, scalded
 1 egg, beaten
 3½ cups flour
GLAZE

1 cup confectioners sugar
 1 tablespoon milk
CRANBERRY RAISIN FILLING

¼ cup sugar
 2 tablespoons flour
 Dash salt
 1½ cup fresh cranberries, halved
 ½ cup raisins
 ½ cup water
 1/8 teaspoon almond extract
 Melted butter

In a medium saucepan, mix dry ingredients; add fruits and water. Bring to a boil over medium heat; boil for 5 minutes. Remove from heat and stir in almond extract. Punch down dough. On a lightly floured surface, roll out dough to a 10 x 15 rectangle. Brush with melted butter. Spread filling over dough to within 1 inch of ends. Roll up jelly roll style. Place on cookie sheet; form a circle and pinch ends together to seal. With a sharp knife, cut to within 1 inch of center of circle; slightly twist each section. Let rise

until double in size. Preheat oven to 350 degrees. Bake 30 minutes or until golden brown. Cool. Combine glaze ingredients and drizzle over cake. Yield 1 coffee ring.

SECOND PRIZE: Cranberry Orange Coffee Cake

Lorraine Carr

DOUGH
 3¾-4¼ cups flour
 ½ cup sugar
 1 package dry yeast
 ½ teaspoon salt
 1 5-ounce can evaporated milk
 1/3 cup orange juice or water
 ¼ cup butter or margarine
 2 eggs

FILLING

1 cup orange marmalade
 2 cups fresh cranberries
 ½ cup sugar
ORANGE GLAZE
 1 cup powdered sugar
 1-2 tablespoons orange juice
 2 tablespoons almond slices, toasted

In a medium mixing bowl, mix 2 cups flour, sugar, yeast and salt. Heat milk, water or juice and butter up to 120-130 degrees. Using a mixer on low speed, add liquid to dry mixture; beat 2 minutes. Stir in enough remaining flour to make a soft dough. Knead dough on a lightly floured surface for 4 minutes. Place dough in a greased bowl; turn dough over to grease other side. Cover and let rise

Pump Repairs & Sales

All Types

- Field Service
- Chemigation Equipment Sold
- Demonstration by Appointment

**AAA Industrial
Pump Service Inc.**

Bruce Sunnerberg
 66 Lake Street
 Plympton, MA 02367
 (617) 585-2394

Bogs For Lease

22 Acres — Taunton

- Dormant Bogs
- Chapter 61A
- Ready to Rebuild
- Complete Plans
- Long Term Lease

Stephen Horbach
 25 Mariner Ct.
 Brewster, MA 02631

WANTED

Gravel & Sand

in the southeastern Massachusetts area

Quantities of 10,000 yards and up

Complete site work, bog construction and finished contouring of surrounding area plus the best price for your material.

Michael Coan
Carver, Mass.
(508) 866-5285

Earl White
Medfield, Mass.
(508) 359-7291

R.D. GRASSI Cranberry SERVICES

**Herbicides
Applied**

*Custom Pruning
Custom Ditching*

**West Wareham,
Massachusetts**

*Sanding
Wiping
Wet Harvesting
Mowing*

*(Mowing includes
Hydraulic Arm
Flail Mower.)*

**Ask for Rick at
295-5158**

until double in size. Meanwhile, prepare filling. In a medium saucepan, combine marmalade, cranberries and sugar; cook on medium heat until berries pop and mixture thickens. Set aside. Punch down dough and divide in half. Roll one half to an 18 x 12 rectangle. Spread with half of the filling. Roll up jelly roll style. Place seam side up in a greased 12 cup bundt pan. Seal ends. Repeat with remaining dough and filling, placing second roll on top of the first, seam side down. Cover and let rise until double in size.

Bake at 350 degrees for 35-45 minutes or until golden brown. To prevent overbrowning, cover with foil after 20 minutes of baking. Remove from pan and cool on wire rack. Combine glaze ingredients to desired consistency and drizzle on cake. Sprinkle with almonds. Garnish as desired. Yield 1 coffee cake.

FIRST PRIZE: Christmas Cranberry Swirl Coffee Cake

Corraine Graffam, Plymouth, Mass.

1/2 cup stick butter or margarine
 1/2 cup sugar
 2 eggs
 1 1/2 cups flour
 1/2 teaspoon baking soda
 1/2 teaspoon salt
 1/2 cup sour cream
 1/2 teaspoon vanilla
 1 16-ounce can cranberry sauce
 1/2 cup nuts, chopped
 1/2 cup LAZE (optional)
 1/2 cup powdered sugar
 1 tablespoon cranberry cordial

Preheat oven to 350 degrees. Grease an angel food cake pan. In medium mixing bowl, cream butter and sugar until fluffy. Add eggs, beat well. Combine dry ingredients; add to creamed mixture. Blend in sour cream and vanilla; mix thoroughly. Pour 1/3 of the batter into the pan, sprinkle with 1/2 of the nuts and half of the cranberry sauce. Make another layer in the same manner. Top with remaining 1/3 of batter. Bake for approximately 55 minutes or until a toothpick comes out clean. Cool 5 minutes and remove from pan. Combine glaze ingredients and drizzle over cake. Garnish with holly and fresh

cranberries for the holidays. Yield 12 servings.

ANY OTHER WAY

FIRST PRIZE: Cranberried Beans

Irene Varecchia

1 16-ounce can whole berry cranberry sauce
 2 16-ounce cans baked beans

1 small onion, grated
 2 teaspoons mustard
 4 brockwurst or frankfurts

Preheat oven to 350 degrees. In a 1 1/2 quart casserole dish, arrange a layer of beans, a layer of whole berry cranberry sauce and a sprinkling of onion and mustard. Repeat layering in this manner, ending with a layer of beans. Bake for 20 minutes. Stir in brockwurst or frankfurts. Bake an additional 30 minutes. Yield 4 servings.



Norosac Herbicide is unparalleled in controlling weeds and grasses in young fruit trees, nursery stock, blackberries, cranberries, raspberries and blueberries.

CAN YOUR PRESENT PRE-EMERGENT HERBICIDE DO ALL OF THESE?

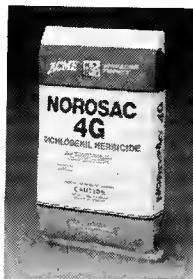

- ★ Be applied over and through existing weed growth?
- ★ Kill existing vegetation?
- ★ Control perennial weeds and grasses including quackgrass and horsetail (Equisetum)?
- ★ Control annual weeds and grasses?
- ★ And can it last through the growing season with one application?

NOROSAC® 4G CAN..AND DOES!

G pbi/gordon corporation / 1217 WEST 12TH STREET
 P.O. BOX 4090
 KANSAS CITY, MISSOURI 64101
 816/421-4070

NOROSAC®



Norosac® is a registered trademark of PBI/Gordon Corporation.

©1988, PBI/Gordon Corporation

713-1088

PORTABLE MICROSCOPES

Professional, inexpensive microscopes for examination of plants in the field for:

SOUTHERN RED MITE * PARASITIZED FRUITWORM EGGS
 NEMATODES * TIPWORM LARVAE IN UPRIGHTS

Two models, 25x fixed or 18-36x variable magnification. Sold with a 20-day trial guarantee. Call for our complete catalog, references, prices.

PEST MANAGEMENT SUPPLY INC.

P.O. BOX 938

AMHERST, MA 01004

800 272-7672

413 253-3747 (in Mass.)

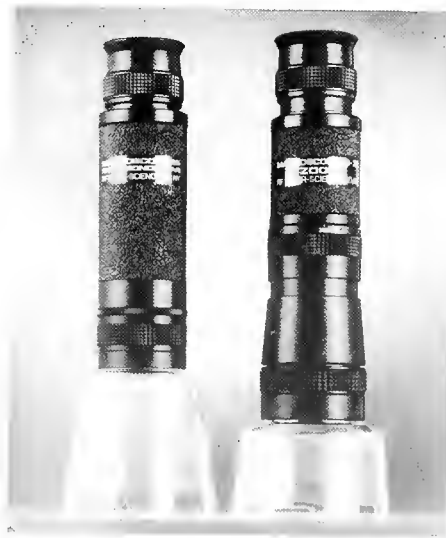

SECOND PRIZE: Cape Cod Cracker Dip

Lorraine Carr

- 1 8-ounce package cream cheese, softened
- 2 cups fresh cranberries, ground
- ¾ cup sugar
- ½ cup crushed pineapple, drained
- Chopped nuts

In a medium mixing bowl, combine cranberries, sugar and pineapple. Set aside. Whip cream cheese; blend into cranberry mixture. Sprinkle with nuts. Excellent on bagels or English muffins. Yield 1½ cups.

- 4 cups fresh cranberries
- 2½ cups sugar
- 1 cup water
- 6 whole cloves
- 2 cinnamon sticks
- ½ teaspoon salt
- 1 cup golden raisins
- 2 tart apples, peeled and diced
- 2 firm pears, peeled and diced
- 1 small onion, chopped

- ½ cup celery, chopped
- 1 teaspoon lemon peel, grated

In a large saucepan, combine the first six ingredients; bring to a boil, stirring frequently, until the berries pop. Add raisins, apples, onion and celery. Continue cooking stirring constantly until thick, about 1½ minutes. Remove from heat, add lemon peel. Ladle into sterilized jars.

THIRD PRIZE: Cranberry Chutney

Mary Reid, Plymouth, Mass.

Wanted

Wisconsin Cranberry Grower wishes to purchase an existing cranberry marsh.

STEVE

(715) 421-0917

(715) 593-2385

BIG WHEEL TRUCK SALES

**42 Quanapoag
E. Freetown, Mass.**

All types of medium and heavy duty trucks on hand from cab & chassis to dump trucks to road tractors.

Largest used truck dealer in New England.

All types of diesel repair.

Largest tow trucks on the East Coast.

Call Bob or Eric

(508) 763-5927

or

(508) 763-8745

22 years experience   construction lifts 

AERIAL LIFTING

◦ **BERRY LIFTING** ◦

nylon berry bags
bulk bins

◦ **MUD LIFTING** ◦

NEW MATS

lightweight
durable

contact

PETER or CHUCK

508-295-2222

**BEATON'S
CRANBERRY
GROWERS SERVICE**

WARHAM MASS.

mat rentals & sales



**MIDDLEBOROUGH
TRUST COMPANY**

The *Business* Bank.

MTC offers you business banking built to your needs.
Personal attention to your special
financial requirements now and as you grow. Cooperation.
Flexibility. Complete business and personal banking.
Member FDIC



Main Office

10 John Glass, Jr. Square, Middleborough

Branch Offices

Middleboro Square, Rt. 28, Middleborough • Middleboro Plaza, Middleborough
Cranberry Plaza, East Wareham • Carver Square, Carver • Trucchi's Plaza, Taunton

Telephone all offices **947-1313**

Irrigation Equipment Designed Especially for the Cranberry Industry

- Gorman-Rupp Self Priming Electric Sprinkler Pumps
- Proven Quick Couple Riser
- Polyethylene Main Lines, 3" - 12"
- Butt Fusion Equipment Available
- Paco/Wemco Water Harvest Pump
- Berkeley Self-Priming and Centrifugal Pumps

A Most Complete Inventory of Irrigation Accessories

LARCHMONT
IRRIGATION / SNOWMAKING

P.O. Box 66, 11 Larchmont Lane
Lexington, Massachusetts 02173 (508) 862-2550

Contact

Larchmont Engineering
Phil Tropeano, President
(508) 862-2550
(Call Collect)

Stearns Irrigation, Inc.
790 Federal Furnace Rd.
Plymouth, MA 02360
(508) 746-6048

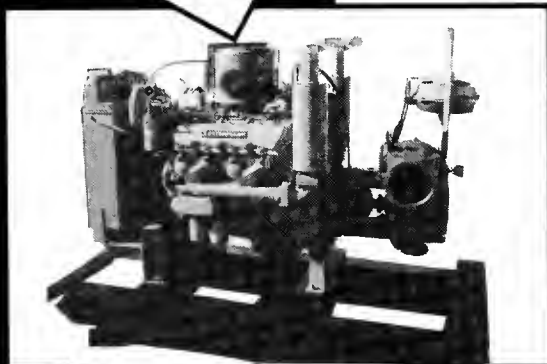
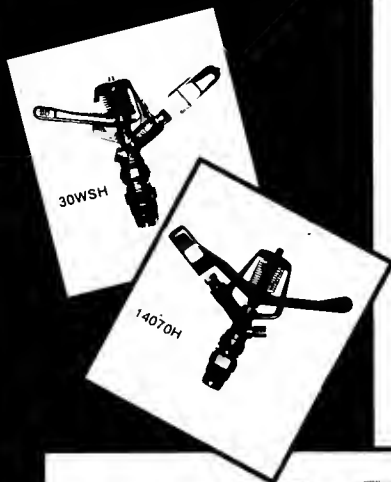

Take Good Care of Yourself Have an Ocean Spray!



The farmer's cooperative that brings you
a wide range of natural fruit juices, drinks and sauces
Ocean Spray Cranberries, Inc., Plymouth, Massachusetts 02360
An Equal Opportunity Employer

3
7
r

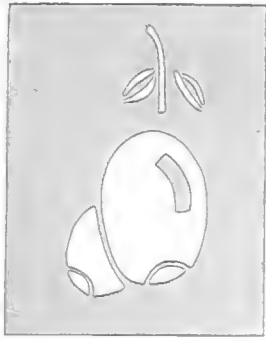

CRANBERRIES

THE NATIONAL CRANBERRY MAGAZINE
March 1989 Vol. 53, No. 3

LABELS, LABELS, LABELS

What Information Should They Contain?



Cranberry Juice Cocktail



of OCEAN SPRAY®
Cranberry Juice Cocktail
Slightly with the
on in the natural
of cranberries. No
colorings are used.

EATE AFTER OPENING
SERVE NATURAL
TASTE AND FLAVOR
serve well chilled.

S

**100%
VITAMIN C**
U.S. RDA PER SERVING
**VERY LOW
SODIUM**

**A JUICE
DRINK**

**NO ARTIFICIAL
PRESERVATIVES,
FLAVORS OR**

CONTAINS: Filtered Water, Cranberry Juice, High Fructose Corn Syrup, Cranberry Juice Concentrate, Vitamin C

NUTRITION INFORMATION Per Serving

Serving Size: 6 fl. oz.
Servings per Container—21.3
Calories—110; Protein—0
Carbohydrate—26 g; Fat—0
Sodium—10 mg

Percentage of U.S. Recommended Daily Allowance (U.S. RDA)

Vitamin C 100
Contains less than 2% of U.S. RDA of protein, vitamin A, thiamine, riboflavin, iron.



200 20010

01005 MA
AMHERST
SERIALS DEPT.
UNIV OF MASS LIBRARY
Send to
ct booklet is
ig you with
me your
ase include

3.78 L

IES, INC
225 Water Street, Plymouth, MA 02360
Product of U.S A K



DRESSER

+

BARK RIVER

*Quality products and
trained, dedicated people
standing behind them.*

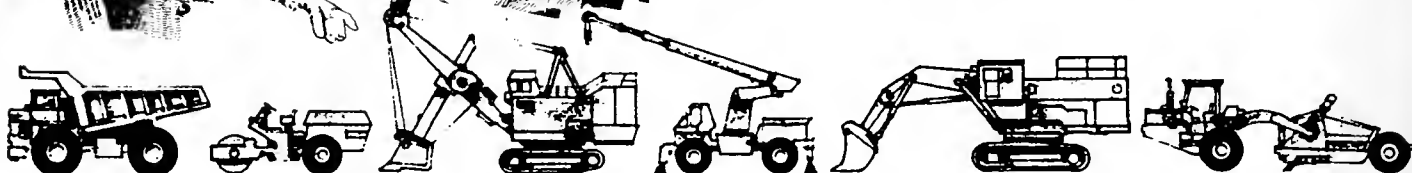

It's a combination that adds up to top production for you!

Then add BARK RIVER's full line of other quality tools and equipment and you have a complete source for all your equipment needs, all backed with dependable product support.

Crawler Loaders
Crawler Tractors

Draglines
Drills
Graders

Hydraulic Excavators
Hydraulic Shovels
Planers

Rollers
Scrapers
Shovels

Trucks (off-highway)
Wheel Loaders

- FRINK SNOW-PLOWS
- FMC WAYNE STREET SWEEPERS
- CLARK-BOBCAT SKID STEER LOADERS
- WISCONSIN TRAILERS
- VAC-ALL BY LEACH
- GAFNER IRON MULE
- TIGER HIGHWAY MOWERS

- HITACHI EXCAVATORS AND CRANES
- PAPER, CALMENSEN BLADES AND CUTTING EDGES
- FOX SPREADERS
- WALDON LOADERS
- GRADALL INC. EXCAVATORS
- MURPHY DIESEL ENGINES

- KOLMAN CONVEYORS
- MORBARK EGER BEEVER CHIPPER
- FAIR SNOWBLOWERS
- AMZ ASPHALT PATCHING EQUIPMENT
- SICARD SNOWBLAST SNOWBLOWERS

Manufacturers of corrugated steel & aluminum culvert pipe and drainage products.



BARK RIVER Culvert & Equipment Co.

Backing you with 82 years of experience.

EAU CLAIRE
1700 Western Avenue
Phone (715) 835-5157

MADISON
Highway 51 & Buckeye Rd.
Phone (608) 222-4151

ESCANABA
430 N. Lincoln Street
Phone (906) 786-6920

GREEN BAY
600 Liberty Street
Phone (414) 435-6676

SUPERIOR
1213 Winter Street
Phone (715) 392-2243

MILWAUKEE
11715 W. Silver Spring Rd.
Phone (414) 461-5440

Ocean Spray Urges Industry, Consumer Groups to Get Behind Nutritional Labeling

By CAROLYN GILMORE

"Industry and consumer groups need to persuade Congress that nutritional labeling is appropriate."

So said Ocean Spray public affairs spokeswoman Christine Masclee in a recent interview about the fruit juice labeling controversy.

Regulations now before the Food and Drug Administration would require the percentage of juice content to be printed "in fairly large letters" on the front of all fruit juice labels, Masclee pointed out.

In the eyes of the cranberry cooperative, the regulation would provide a marketing advantage for some competitors.

"A company (could) replace water and sugar with apple juice with little flavor, no vitamin C and advertise their product as '100 percent juice,'" the Ocean Spray spokeswoman said.

"Our point of view is that cran-

berries come naturally very concentrated and tart. We don't think juice content is the real measure of nutritional or economic value."

Ocean Spray, which started printing nutritional labels on its products 15 years ago, is calling for a "level playing field" with respect to regulations. It proposes requiring labels that would state both juice content and nutritional value for all juice products, both diluted and nondiluted.

Surgeon General Everett C. Koop favors full disclosure labeling for all processed food products. Currently, however, only producers of fortified products are required to list nutritional information on their

COVER ILLUSTRATION
OCEAN SPRAY began putting labels with nutritional facts on its products some 15 years ago. Current controversy exists over a Food and Drug Administration regulation that would require placing the percentage of juice content on a label.

POLLINATION

Are you getting the most for your pollination dollar? Be sure the hives you rent give you maximum return. We can help. (We are not pollinators: we do not rent hives.) Brochure available. Apicultural Associates, RR 1 Box 225, Charlemont, MA 01339, (413) 639-5320, (413) 625-9630.



Norosac Herbicide is unparalleled in controlling weeds and grasses in young fruit trees, nursery stock, blackberries, cranberries, raspberries and blueberries

CAN YOUR PRESENT PRE-EMERGENT HERBICIDE DO ALL OF THESE?



- ★ Be applied over and through existing weed growth?
- ★ Kill existing vegetation?
- ★ Control annual weeds and grasses?

- ★ Control perennial weeds and grasses including quackgrass and horsetail (Equisetum)?
- ★ And can it last through the growing season with one application?

NOROSAC® 4G CAN..AND DOES!

G pbi / Gordon Corporation

1217 WEST 12TH STREET
 P.O. BOX 4090
 KANSAS CITY, MISSOURI 64101
 816/421-4070

NOROSAC®

VAPOR BARRIER HERBICIDE

Norosac® is a registered trademark of PBI/Gordon Corporation.

© 1988, PBI/Gordon Corporation

713-1088

Bogs For Lease

22 Acres — Taunton

- Dormant Bogs
- Chapter 61A
- Ready to Rebuild
- Complete Plans
- Long Term Lease

Stephen Horbach
 25 Mariner Ct.
 Brewster, MA 02631

labels. Congress would have to act to require full disclosure.

The regulation requiring juice content labeling was adopted by the FDA in 1980 but it has not been enforced.

Ocean Spray is part of a task force within the National Food Processors Association charged with

Consumer Group Spokesman Labels Ocean Spray Proposal a 'Red Herring'

One consumer group that Ocean Spray apparently won't be able to count on in its battle for so-called full disclosure labeling is the Center for Science in the Public Interest.

Bruce Silverglade, a staff attorney for the consumer interest organization, called Ocean Spray's stance in behalf of juice content labeling for all juices—both diluted and nondiluted—a "red herring" and "misleading."

"The issue is not the amount of water present in a juice, but the amount that comes out of the tap," he declared.

examining labeling in general. The NFPA is composed of both large and small companies, from the well known Heinz to the specialized Maui Pineapple.

Together, the trade association companies represent more than 30 percent of juice sales nationally.

Reached by phone at his Washington, D.C., office, Silverglade said his organization is in favor of the FDA enforcing the juice content label requirement this year.

"Groups like mine have been trying to get nutritional labeling for 12 years," he said.

But, he charged, Ocean Spray's current position "has less to do with public awareness, more with keeping the public in the dark."

Juice content labeling, he said, could be enforced this year. Nutritional labeling he added, would require an act of Congress.

REGIONAL NOTES

WISCONSIN

Should the state of Wisconsin regulate dams in cranberry bogs the way it does other dams?

That's the heart of an issue now before the Wisconsin Supreme Court. Jeffrey and Barbara Tenpas, who own a cranberry marsh in Preston, are challenging a 1982 law that requires them to show financial responsibility for maintaining a dam.

Their lawyer, Byron C. Crowns of Wisconsin Rapids, argued in court that a financial responsibility provision is unnecessary. He added that such fees would be prohibitive for some owners.

He and Jeffrey and Barbara Tenpas cite a 1867 law authorizing owners of cranberry marshes to build and maintain cranberry marshes as necessary.

Assistant Attorney General Maryann Sum said the growers should be treated the same way as owners of other dams and should adhere to the same health and safety regulations.

Crowns is also representing the Wisconsin Cranberry Growers Association in the case.

22 years experience  construction lifts 

AERIAL LIFTING

◦ BERRY LIFTING ◦

nylon berry bags
bulk bins

 BEATON'S
CRANBERRY
GROWERS SERVICE

WARBHAM MASS.

◦ MUD LIFTING ◦
NEW MATS

lightweight
durable

contact
PETER or CHUCK
508-295-2222

 JOE
BRIGHAM
INC
mat rentals & sales

editorial



Level the Playing Field

The one obvious purpose of product labels should be to inform the public.

They should not be printed and glued to bottles and cans for the purpose of market advantage.

And that's what Ocean Spray is concerned about regarding the FDA regulation on juice content labeling.

Ocean Spray would have to display, let's say, that it uses 15% of its relatively moisture-free, highly acidic cranberry juice in its cranberry juice cocktail.

On the other hand, the processor of a heavily water-laden juice, which might contain up to 85% water, could say his bottles hold 100% juice, thereby giving him a competitive advantage in the eye of the consumer.

In addition, Ocean Spray says, a six-ounce serving of its cranberry juice cocktail contains 100% of the United States Recommended Dietary Allowance of vitamin C. On the other hand, an equivalent amount of the watery juice put out by our aforementioned processor might contain less than 2 percent of the RDA and he wouldn't even have to mention that.

So, says Ocean Spray, let's level the playing field. Let's have full disclosure labeling. Let's give the facts on nutrition. And let's state how much juice is in all juice drinks, both those that are diluted and those that are not diluted.

Sounds fair.

Our sense, however, is that more than one consumer group will say, "We don't care about how much water already is in the juice. We only want to know how much water has been added."

All right, then. Why not have *full* full disclosure? Why not disclose everything that's been added? And then why not also reveal the individual components in the end result—for both diluted and nondiluted drinks? Does this not level the playing field?

WOLLSCHLAGER EXCAVATING

Dragline Work — All Kinds

Also Have Clam & Scalping Buckets

Route 1 Necedah, WI 54646
1-808-565-2436

LETTERS

WANTS ADDRESS

In your January 1989 issue, page 10, your article refers to the election of directors of the Cranberry Institute, but does not include an address. I am interested in contacting this group for information and would appreciate an address.

Thank you for your attention.

Barbara Kemp
Haga Cranberries
Langlois, Ore.

Editor's Note: The address is:

The Cranberry Institute
1101 Fifteenth St., N.W. Suite 202
Washington, D.C. 20005
The Cranberry Institute's telephone
number is (202) 785-3232.

Wanted

Wisconsin Cranberry
Grower wishes to purchase
an existing cranberry marsh.

STEVE

(715) 421-0917

(715) 593-2385

CRANBERRIES

THE NATIONAL CRANBERRY MAGAZINE

SEND CORRESPONDENCE TO:

P.O. BOX 249
COBALT CT 06414
(203) 342-4730

PUBLISHER & EDITOR: BOB TAYLOR

ASSOCIATE EDITOR: CAROLYN GILMORE
(508) 763-5206

ADVISORS & CORRESPONDENTS

MASSACHUSETTS — Irving E. Demoranville, Director, Cranberry Experiment Station.

NEW JERSEY — Phillip E. Marucci, Cranberry & Blueberry Specialist, Buddtown; Elizabeth G. Carpenter, Chatsworth.

NOVA SCOTIA — Robert A. Murray, Horticulturist, Berry Crops, Research Station, Truro

OREGON — Arthur Poole, Coos County Extension Agent, Coquille.

WASHINGTON — Azmi Y. Shawa, Horticulturist and Extension Agent in Horticulture, Coastal Washington Research & Extension Unit, Long Beach.

WISCONSIN — Tod D. Planer, Farm Management Agent, Wood County.

CRANBERRIES is published monthly by Diversified Periodicals, Wellwyn Drive, Portland CT 06480. Second class postage is paid at the Portland, Conn. Post Office. Price is \$15 a year, \$28 for two years, \$2 a copy in the U.S.; \$17 a year in Canada; \$20 a year in all other countries. Back copies: \$2.50, including postage. Copyright 1988 by Diversified Periodicals.

ISSN: 0011-0787

Postmaster, send Form 3749 to:

CRANBERRIES
P.O. BOX 249
COBALT CT 06414

Some Needs for Cranberry and Blueberry Research in New Jersey

By **PHILIP E. MARUCCI**
Professor Emeritus, Rutgers University

Recently the New Jersey Cranberry & Blueberry Research Council requested that I suggest areas of research which I deem important for the future progress of the two fruit crops.

The list of items below I consider to be a sort of "wish list" of work growers would like to have done. The obvious need for more research in breeding, nutrition and pesticides are not included since the council is already giving adequate attention to these subjects. This listing is not in the order of the importance or need of each item.

1. Pruning of Cranberries.

As I pointed out in a recent article in CRANBERRIES magazine, little is known about this important

practice. The entire concept of nutrition of cranberries could change drastically if new, efficient methods of pruning could be developed. The potential for increasing yields is great.

2. Biological control of cranberry insects.

Harry Moulter and I got some promising results on Bog #1 on the Rutgers Bogs, but the test had to be terminated when false blossom disease flared up. Some knowledge was obtained on the parasites of Sparganothis. This insect has so many host plants that it could easily be reared in the lab. It might be possible to rear parasites in large numbers for release in the field.

Some interesting work in genetic engineering of *Bacillus thuringiensis* gives promise that

strains of this bacteria could be developed to be more toxic to specific insects. Much of this work is being done by private biopesticide companies.

3. Manipulation of nests of solitary bees to supplement honey bee hives in blueberry and cranberry pollination.

Easy methods have been developed to colonize large numbers of individual nests of solitary bees in small wooden boxes. These bees are much more efficient pollinators than are honey bees and even bumble bees. They work close to their nests. A team of Utah University and USDF/Apiculturists have been able to rear a solitary bee (*Osmia ribifloris*) solely on blueberry pollen and nectar. These bees may b

CASORON FREE

Vines For Sale

NO DODDER

Ben Lears \$4,500 a ton

*Orders paid in advance
by February
receive a 10% discount.*

40 Tons Available

**Jonjak Cranberry Farm Inc.
Hayward, Wisconsin**

**Call Randy Jonjak
(715) 634-3979**

Stevens \$4,000 a ton

*Orders paid in advance
by February
receive a 10% discount.*

30 Tons Available

**Cranberry Springs Inc.
Hayward, Wisconsin**

**Call Stanley Roy Jonjak
(715) 634-3044
(715) 634-3286**

TRUE VARIETIES

HONEST WEIGHTS

available commercially in a few years. (I am fascinated with the possibilities here and will be playing around with these little creatures).

4. Virus free blueberries.

Growers are lamenting the decline of the Jersey variety. They remember the enormous potential productivity of this cultivar when it was first introduced. It is still a good producer but does not bear the full clusters of large berries "in strings." They say that after an unspecified number of years, a variety "runs out." They believe this so strongly that they would like to see the original Jersey cross done again to start anew with the old-time Jersey. Jersey truly has lost its ability to produce. I feel the variety may now be generally infected with some hidden virus, probably a strain of blueberry stunt disease, which does not exhibit striking symptoms and yet weakens the plant, especially the floral structures. Similar ailments have existed in brambles and strawberries and remarkable improvements have been made with virus free techniques. Methods of eliminating viruses without destroying tissues is now standard in brambles and other crops. An attempt should be made to generate a stock of virus free Jerseys.

5. The Early Black cranberry.

It is apparent that the Early Black is a complex of closely related plants,

very similar in vine characteristics but varying in berry shape and size. On the same property with similar soils and cultural methods, one Early Black type will be consistently more productive than others. Isozyme studies may give some interesting offshoots.

There is also the possibility that false blossom disease still exists in a mutated form in Early Blacks.

This may account for the wide variation in size and seed counts of Early Black berries. Virological studies are needed.

6. The bee kill problem of cranberries. Beekeepers have been complaining for several years that they are suffering high mortalities of bee hives placed out on cranberry bogs for pollination. This

Apply Now For The 1989 Season

**DeCran
Integrated Pest Management**

Serving Massachusetts Cranberry Growers

- ★ Experienced Consultants
- ★ Scout Training
- ★ Right to Know Training
- ★ Insect and Weed Identification
- ★ Botanical and Insect Reference Mounts
- ★ Pheromone Trap Kits:
Cranberry Girdler
Sparganothis Fruitworm
Blackheaded Fireworm
- ★ Updated Information on Latest Research and Developments in Cranberry Science

Contact:
Monika Schuler
DeCran AG Supplies
461 St. Mary's Pond Road

Office: (508) 295-2731
Evening: (508) 996-6120

Our Acreage Is Limited So Sign Up Now!

**Pump Repairs
& Sales**

All Types

- Field Service
- Chemigation Equipment Sold
- Demonstration by Appointment

**AAA Industrial
Pump Service Inc.**

Bruce Sunnerberg
66 Lake Street
Plympton, MA 02367
(617) 585-2394

Vines For Sale

Ben Lear	\$5,000 a ton
Stevens	\$4,000 a ton
Crowley	\$4,000 a ton
Bergman	\$4,000 a ton

Prices are F.O.B.

\$500 a ton less with 50% payment before cutting

Richberry Farms Ltd.

11280 Mellis Drive Res. (604) 273-4505
 Richmond, B.C. Bus. (604) 273-0777
 V6X 1L7 Canada

problem needs closer investigation. The present finding that chlordane and aldrin have been found in honey of hives set out on cranberries is imponderable. These chemicals have not been used on either cranberries or blueberries for more than 20 years.

7. Rotation of beehives on cranberries and blueberries. The recent switch to earlier withdrawal of the winter flood has generally brought about larger crops, but has also occasioned pollination failures. The placement of honey bee hives on the bogs in two separate complements instead of all at once has improved the percentage set of berries. More precision in the timing of bee placements is necessary. The practicability of increasing the number of placements to three should also be considered.

8. Inducing greater bee activity on cranberry bogs by use of sprinklers. Many observers have noted a heightened foraging of bees immediately after a rain. It might be possible to improve bee visitations to cranberry and/or blueberry flowers by sprinkling. Limited observations in 1986 showed that bee foraging could be shifted from one bog to another by running sprinklers on bogs already well pollinated, while keeping bogs more in need of bees unsprinkled.

9. Establishment of new bogs. Fumigation procedures and new planting and fertilization techniques give promise of quicker establishment and production of new plantings. Lee Brothers' experiences in fumigation and Ernie Bowker's and Tom Budd's successful trials with

We Still Make House Calls

Like your old family doctor, your Farm Credit representative still makes house calls . . . and he's been treating farm families like yours for a good 70 years.

Farm families count on him to provide the financial support they need—short-term and long-term credit—that helps them plan for a productive future.

But there's more to Farm Credit than money. What makes your Farm Credit representative unique is that he knows your business so well. Which means that he's more than a dependable source of credit. He can provide farm business consulting, tax services, credit life insurance, appraisal service and computerized record-keeping.

Give him a call. He could be just what the doctor ordered for you.



Southern New England Farm Credit Service

Federal Land Bank Association
Production Credit Association
P.O. Box 7
Taunton, MA 02780
508 / 824-7578

R.D. GRASSI *Cranberry* SERVICES

**Herbicides
Applied**

*Custom Pruning
Custom Ditching*

**Sanding
Wiping
Wet Harvesting
Mowing**

*(Mowing includes
Hydraulic Arm
Flail Mower.)*

**West Wareham,
Massachusetts**

**Ask for Rick at
295-5158**

WANTED

*10 to 15 acres of cranberry
bogs in Plymouth County.*

**Call John
(617) 585-9577**

setting out rooted cuttings and "sticks" (unrooted cuttings) with tomato planters encourage further testing. The economy of greenhouse propagation of rooted cuttings versus outside propagating beds versus purchase of expensive vines should be accounted.

10. Sheep Pen Hill Disease of Blueberry. The fundamental research to find the pathogen or pathogens is the right approach and is progressing. However, once the pathogen is found, another long range study to determine the vector will further extend the time for the eventual control of the disease. This is demoralizing to growers who are in dire need of a quicker solution.

Since a virus, fungus, bacterium or nematode, singly or in combination, is probably the cause of SPHD, it is not illogical to start "shotgun treatments" with pesticides known to be effective against these organisms. More work is also needed on varietal resistance to SPHD. Patriot,

which is known to be resistant to some root rots, might be a good candidate.

11. The "Red Bluecrop" problem. This has already been designated by the council as a serious problem. I am repeating it as a matter of emphasis. This almost fatal flaw in the most important commercial variety is becoming

more general every year. Last year a small grower in Pemberton was not able to make a single picking of his Bluecrop which actually bore a good crop of berries, which were still not blue in October. Some large growers had to leave many blueberries unpicked after second or third picking. The largest growers (Galletta), when asked if they had the problem, replied, "We invented it."



VOLM BAG COMPANY, INC.

1804 EDISON ST. BOX B, ANTIGO, WIS. 54409-0116
PHONE 715/627-4826

SUPPLYING AGRICULTURAL CHEMICALS

BRAVO - SEVIN - FUNGINEX - ORTHENE
CASORON - GUTHION - DEVRINOL - PARATHION

AND

**DELIVERING A COMPLETE LINE OF FERTILIZER
WITH FAST FRIENDLY SERVICE!!!**

HONEY BEES AVAILABLE FOR

Pollination

- ★ 25,000 Strong Colonies Available
- ★ State and Federal Inspected
- ★ Cranberries, Blueberries, Etc.
- ★ 72 Hour Delivery East of the Mississippi River
- ★ Radio Dispatched Trucks

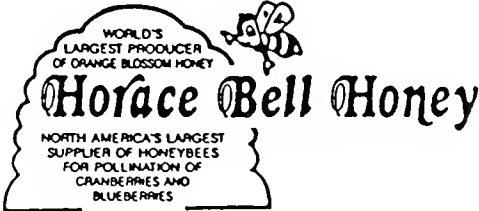

WORLD'S LARGEST PRODUCER OF ORANGE BLOSSOM HONEY

Horace Bell Honey

NORTH AMERICA'S LARGEST SUPPLIER OF HONEYBEES FOR POLLINATION OF CRANBERRIES AND BLUEBERRIES

Lamar Hester
General Manager 734-3276 Evenings

1058 S. Ridgewood Ave.
DeLand, Florida 32720
Office: (904) 734-7798
736-3841
734-5043

Best of Show in Photo Contest Goes to Kiernan

By CAROLYN GILMORE

Ricky Kiernan won best of show in the Cape Cod Cranberry Growers' Association's recent color photography contest for his fall cranberry land scene titled "Tihonet."

He also won a first place in the wildflowers/scenes category with the same photo.

Georgia D. Chamberlain placed first in the harvest category for a photograph of activity on a wet picked bog.

Helen Nolan placed first in wildlife, capturing on film geese on a wet picked bog.

In the harvest category, Lisa Kinebon placed second and Helen Nolan placed third. In wildlife, Skip Sellon placed second and Steve Beaulieu was third. Kirby Gilmore placed second and Laurene Gerrior third in the wildflowers category.

The contest, the theme of which was "Cranberry Culture Is Good for the Environment," drew more than 150

entries depicting the environmentally enhancing qualities of this field of agriculture. The photos are to be used

for various promotional and educational activities sponsored by the Cape Cod Cranberry Growers Association.

Vines For Sale

<i>Ben Lear</i>	\$3,500 a ton
<i>Stevens</i>	\$3,500 a ton
<i>Crowley</i>	\$3,500 a ton
<i>Le Munyon</i>	\$3,500 a ton
<i>Searles</i>	\$3,500 a ton

\$500 a ton less with 50% payment before cutting

*Lake Nokomis
Cranberries, Inc.*

David Zawistowski, Owner

6031 County Highway D (715) 479-4658
Eagle River, WI 54521 (715) 479-6546

K Ag Laboratories International, Inc.

2323 Jackson Street
Oshkosh, WI 54901

Serving Cranberry
Growers in U.S.A.
& Canada since 1984

Over 20 years
of Experience on
Acid Soil Interaction

K Ag Laboratory has run over 30,000 cranberry soil and over 17,500 cranberry vines tests since 1984, and gave fertilizer recommendations with great success.

- ★ *Cranberry Soil Analysis*
- ★ *Cranberry Vine Analysis*
- ★ *Cranberry Water Analysis, Usage & Interpretation*
- ★ *Liquid & Dry Fertilizer Recommendation*
- ★ *Soil Problems & Consultation*
- ★ *Seminars*
- ★ *Cranberry Crop Monitoring Program, testing and monitoring nutrient status with 30 day intervals during during the growing season.*

Highly computerized cranberry soil, tissue and water testing program in U.S.A. and Canada.

For more information contact: Dr. Akhtar Khwaja, Ph.D.
Certified Professional Soil Scientist
Certified Professional Agronomist

Phone Number 414-426-2220; Out of WI 1-800-356-6045; FAX 414-426-2222

Weather

MASSACHUSETTS

December was just slightly cooler than normal. Maximum temperature was 58° degrees on the 7th and the minimum was -1° degree on the 12th. Generally, the second and third weeks were cold, the balance of the month normal or above.

Precipitation totaled 1.37 inches, nearly 3 inches below normal. This is the third lowest in our records, with only 1985 and 1955 lower. There was measurable precipitation on seven days, with no large storms. Snowfall was only 4 inches.

For the year 1988, temperatures averaged just a snitch below normal. Months substantially warmer than normal were February, March, August (warmest in nearly 50 years) and November. Months substantially cooler were January, April, September and October. Maximum temperature was 91° in August. The minimum was -8° in January.

Precipitation totaled 44.84 inches or about 14 inches below normal. The only months with substantially above normal precipitation were February, July (a record) and November (most in over 40 years). January, April, May, August, September and December were all much below normal. Snowfall was 1/3 below normal. Sunshine was above normal.

I.E.D.

Obituary

Ralph E. Quillen

Ralph E. Quillen of Dartmouth, Mass., a former employee of the A.D. Makepeace Co., died Jan. 2 at the age of 66.

A native of Clarksville, Del., he was the

husband of the late Natalie (Bumpus) Quillen.

Quillen was a World War II Army veteran. Survivors include three brothers, two sisters and several nieces and nephews.

Memorial donations may be made to the First Congregational Church in New Bedford.

Financial Strength. . .

Personalized Service.

Isn't That What You Need In A Bank?

The Jackson County Bank has supported agriculture in the area for more than 110 years.

We recognize the importance of the cranberry industry and are pleased to provide financial services for all your banking needs.

We're large enough to serve you and yet we offer personalized service which your business demands.

The Jackson County Bank. A name to count on throughout the years.

You'll like the difference.



**JACKSON
COUNTY
BANK**

Member FDIC
(715) 284-5341

Black River Falls, Alma Center, Hixton, Merrillan, Taylor, WI 54615



**MIDDLEBOROUGH
TRUST COMPANY**

The *Business* Bank.

MTC offers you business banking built to your needs.

Personal attention to your special

financial requirements now and as you grow. Cooperation.

Flexibility. Complete business and personal banking.

Member FDIC



Main Office

10 John Glass, Jr. Square, Middleborough

Branch Offices

Middleboro Square, Rt. 28, Middleborough • Middleboro Plaza, Middleborough
Cranberry Plaza, East Wareham • Carver Square, Carver • Trucchi's Plaza, Taunton

Telephone all offices **947-1313**

Decran Ag Supplies Inc.

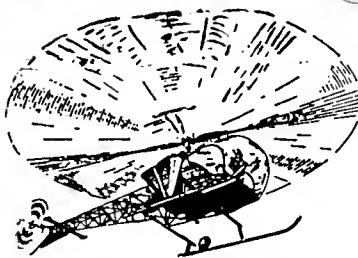

- ★ Complete line of cranberry herbicides, fertilizers, pesticides, fungicides, miticides. In stock when you want them.
- ★ Best application and safety equipment for your needs.
- ★ Quality aerial applications.
- ★ Proven frost warning equipment. Don't take chances — buy the best.
- ★ Experienced cranberry consulting service offering pheromone traps and baits.
- ★ Right to know training.
- ★ Culvert Pipe — All sizes — steel, aluminum, and poly.
- ★ Ditch Mud Mats — Strong — lightweight — durable.
- ★ Burlap Picking Bags — Best for your money.
- ★ Sanding by helicopter.

John C. Decas

William D. Chamberlain

461 Mary's Pond Rd.
Rochester, MA 02770

Office: 295-2731
Evening: 763-8956
Fax: (508) 291-1417

Serving Massachusetts Cranberry Growers

Office
295-2222

K. Beaton
295-2207

BEATON'S CRANBERRY GROWERS SERVICE

WAREHAM, MASS.

Specializing in

D. Beaton
888-1288

P. Beaton
947-3601

○ COMPLETE BOG
MANAGEMENT

○ NETTING

○ DITCHING

○ HARVESTING
(Wet & Dry)

○ SANDING

○ CUSTOM
HERBICIDE
APPLICATION

Complete line of portable Crisafulli Pumps 2" - 16"
Plastic netting for suction boxes



Devrinol. The Gentle Herbicide for Cranberries.

With gentle protection, DEVRINOL® 10-G herbicide provides broad-spectrum weed control of over 40 broadleaf weeds and grasses, including nutsedge. DEVRINOL gives you long-lasting control throughout the season. And it's easy to apply—on the ground or in the air.

For more information, see your dealer or call the ICI Information Line:
1-800-759-2500.

Always read and follow label directions carefully.

DEVRINOL



Labeled nutsedge control in Massachusetts and New Jersey only. See label for specific recommendations.



Plymouth Copters, Ltd.

*Growers fertilizers, herbicides and pesticides applied to growers specifications
Mud Lifting – Cranberry Lifting
Mats Available*

Plymouth Airport
Box 3446
Plymouth, MA 02361

David J. Morey
Richard H. Sgarzi
(508) 746-6030

Agricultural Applications • Lift Work • Executive Charters • Aerial Photography

K Ag Labs Slates Cranberry Seminar

K Ag Laboratories International of Oshkosh, Wisc., has slated an East Coast Cranberry Seminar for April 8 from 9 a.m. to 3 p.m. at the Sheraton Plymouth in Plymouth, Mass.

Included in the seminar will be a 200-slide presentation on various aspects of cranberry production.

The seminar will be free for growers who participated in the K Ag fertilizer program during the 1988 season. The fee will be \$28.50 for those not using K Ag who register by March 15. On site registration will cost \$38.50.

K Ag will provide lunch.

Registration will be held from 9 through 9:30 a.m. Coffee and doughnuts will be served.

Below is the program:

9:30-9:45 — Soil fertility and plant nutrition status of cranberry bogs in Massachusetts; Dr. A. Khwaja.

9:45-10 — Role of nitrogen, phosphorus, potassium, calcium, boron fertilizer in cranberry production; Khwaja.

10-10:30 — Role of metal such as copper, iron, manganese, zinc, aluminum in cranberry production; Khwaja.

10:30-10:45 — Coffee break.

10:45-11:30 — Various plant growth factors and how they affect cranberry production under Massachusetts cranberry soil conditions; Khwaja.

11:30-12 — Herbicides and other chemicals, their effects on cranberry production

and chemical cleanup using bio-technology; Khwaja.

12-1 — Lunch.

1-1:45 — Small fruit physiology and how to increase the size of berries; Dr. Harry Rajamannon.

2-2:30 — Cranberry water and the effect of various water nutrients on soil, plant tissue and the overall production of cranberries; Khwaja.

2:30-3 — Grower questions and answers.

DOW CHEMICAL APPROVES NEW RESEARCH CENTER

A \$35.5 agricultural research center to be located in Midland, Mich., was approved recently by the Dow Chemical Company board of directors.

Construction is slated to begin in July and completion is set for August 1991.

J.A. JENKINS & SON CO.

Grower Service

MOWING (ALL TYPES)	DITCHING
SANDING	WEED WIPING

Serving Cape Cod

227 Pine St., W. Barnstable, Ma. 02668

Phone 362-6018



Irrigation Equipment Designed Especially for the Cranberry Industry

- Gorman-Rupp Self Priming Electric Sprinkler Pumps
- Butt Fusion Equipment Available
- Proven Quick Couple Riser
- Paco/Wemco Water Harvest Pump
- Polyethylene Main Lines, 3" - 12"
- Berkeley Self-Priming and Centrifugal Pumps

A Most Complete Inventory of Irrigation Accessories

LARCHMONT

IRRIGATION / SNOWMAKING

P.O. Box 66, 11 Larchmont Lane
Lexington, Massachusetts 02173 (508) 862-2550

Contact

Larchmont Engineering Phil Tropeano, President (508) 862-2550 (Call Collect)	Stearns Irrigation, Inc. 790 Federal Furnace Rd. Plymouth, MA 02360 (508) 746-6048
--	--

Harry C. Burgess Remembered

By LARRY COLE

Harry C. Burgess, 1899-1989

On Monday, Jan. 9, one of our most dedicated cranberry growers passed away.

Harry was the proverbial farmer, working hard from daylight to dark six and seven days a week. He never pushed his workers but led them; a man that was inclined to be indifferent toward work soon found himself in the way and would go looking for an easier job.

Each of his bogs was among the best kept in Massachusetts and absolutely weed free. In the the early 1930s he bought an abandoned bog in Duxbury of 15 to 18 acres. It was a mess, growing in abundance every imaginable weed. Then the only weed killer was iron sulphate and salt for ferns along the litches. But within a very few years the bog was weed free and stayed that way.

Both Harry's father and grandfather were growers. His father was a business merchant shipping out cranberries under an old Plymouth Rock label when Larry was a youngster. Later on, his trademark was the Red Star brand. Father and son made an excellent team. Harry was very particular about the quality of his fruit and his Howes were exactly what his father needed for his customers in Chicago and on the West Coast.

At a time when 50 to 60 bbls. to the acre was considered a fair crop, he was raising a bbl. to the rod. He never talked about the size of his crops, but anyone that worked for him was well aware of them. He picked only by the pour, for picking by the bushel encour-

aged the workers to be too hard on his vines and berries.

Harry was quiet and a bit shy. He never offered advice but was always available to go over any grower's problems. Living nearby, he was my unofficial state bog agent in my own early years as a cranberry grower. His advice was sure to be correct or he wouldn't give it.

In 1928, he married Gladys Eames, who survives him. They didn't have children but many nieces and nephews. She also shared her love with the many students she taught in the Carver Public School for nearly 40 years.

Harry represented the best of the old-time growers. He was a good neighbor, minded his own business, worked hard and possessed unquestioned integrity.

Niemi Electric Company



Robert Niemi
Electrical Contractors

Heat, Light & Power Wiring

- RESIDENTIAL
- COMMERCIAL
- INDUSTRIAL

Pinehurst Drive
Wareham, Mass.
TEL. 295-1880

High Volume Trailer Pumps

- 12 to 16" discharge
- 20' tongue
- PTO shaft with marine bearing

Phil Helmer
1060 3rd St. N.
Wisconsin Rapids WI
54494
(715) 421-0917

CRANLAND SERVICES

Cranberry Property Appraisals

★ ★ ★ ★ ★
Listings and Sales of Cranberry Properties.
License # 68987

Lawrence W. Pink
Old Cordwood Path
Duxbury, MA 02332
(617) 934-6076

Lampert, Lee & Associates

CONSULTING ENGINEERS
SURVEYORS

Extensive experience in all aspects of cranberry land development: evaluation, purchase, survey, design, permit acquisition, phased construction and planting both in wetlands and uplands.

Have references. Will travel.

Contact: Will Lee
10948 Highway 54 East
Wisconsin Rapids, WI 54494
(715) 424-3131



Two Fabulous Party Dishes That Will Make You Famous!

Any woman knows it's easy to build a reputation as a fabulous cook. All it takes is one or two foolproof recipes that result in delicious food that looks absolutely scrumptious.

Here are two reputation-building recipes for you to treasure as you would your family silver. The first, an utterly elegant Cranberry Glazed Liver Pate, to be served with thin toast fingers. Consider this ambrosial combination: delicately smooth pate, decorated with a ruby glaze of zesty cranberry juice cocktail and cranberry-orange relish, tempered with just a touch of dry white wine.

Umm, could anything be more delectable? Perhaps. You might regard Triple-Layer Cranberry Molded Salad as a triple-threat contender. There's a

cranberry layer with the added zest of cabbage and carrots, a ham layer featuring the surprise of water chestnuts and chilies, and a chicken layer that includes mandarin oranges. All in all, a delightful melange of flavors and textures.

Happily, both dishes can be ready and waiting long before the party begins. The party will make your reputation!

Cranberry Glazed Liver Pate

(serves 12)

1 envelope unflavored gelatin
 1 cup cranberry juice cocktail
 1/2 cup dry white wine
 1/3 cup cranberry-orange relish from a 14 ounce jar
 1 can (2 pounds, 2 ounces) liver pate, chilled
 Toast fingers

Sprinkle gelatin over cranberry juice and let soften. Stir in white wine. Chill until mixture thickens slightly and has consistency of unbeaten egg whites. Fold in relish. Remove pate from can. With a knife, scrape off the fat from the outside of the pate. Place pate on a rack placed over a shallow pan. Spoon cranberry mixture over pate, allowing it to run over pate to coat completely. Chill until gelatin coating is firm. Repeat coating until all cranberry mixture is used. Chill until firm. Cut into slices and serve with toast fingers.

Cranberry Supper Salad

(makes one 4 quart mold)

Cranberry Layer:
 2 envelopes unflavored gelatin
 3 cups cranberry juice cocktail

1/2 cup cranberry-orange relish from 14 ounce jar
 1 cup shredded green cabbage
 1 cup shredded carrots

Ham Layer:

2 envelopes unflavored gelatin
 3 cups pineapple juice
 2 cups diced, cooked ham
 1 can (5 ounces) water chestnuts, sliced
 1 can (4 ounces) sweet green chilies, drained and diced

Chicken Layer:

2 envelopes unflavored gelatin
 3 cups condensed chicken broth
 1/4 cup lemon juice
 1/2 cup chopped celery
 1 can (11 ounces) mandarin oranges, drained
 2 cups diced, cooked chicken
 Chicory
 Mayonnaise

To prepare cranberry layer: sprinkle

The CHARLES W. HARRIS Company

451 Old Somerset Avenue
 North Dighton, Mass.
 Phone 824-5607

AMES
 Irrigation Systems
RAIN BIRD
 Sprinklers
HALE
 Pumps

*Highest Quality Products
 With Satisfaction Guaranteed*

PORTABLE MICROSCOPES

Professional, inexpensive microscopes for examination of plants in the field for:

SOUTHERN RED MITE * PARASITIZED FRUITWORM EGGS
 NEMATODES * TIPWORM LARVAE IN UPRIGHTS

Two models, 25x fixed or 18-36x variable magnification. Sold with a 20-day trial guarantee. Call for our complete catalog, references, prices.

PEST MANAGEMENT SUPPLY INC.
 P.O. BOX 938
 AMHERST, MA 01004
 800 272-7672
 413 253-3747 (in Mass.)





EMPTYING PARTY FOODS include elegant Cranberry Glazed Liver Pate and Triple-Layer Cranberry Molded Salad. These brightly hued and wonderfully flavorful treats can be made well in advance of the festivities.

gelatin into 1/2 cup of the cranberry juice and let soften. Place over low heat and stir until gelatin is dissolved. Add to remaining cranberry juice. Chill until slightly thickened. Fold in relish, cabbage and carrots. Pour into 4 quart mold and chill until firm.

to prepare ham layer: sprinkle gelatin with 1/2 cup of the pineapple juice and let soften. Place over low heat and stir until gelatin is dissolved. Stir into remaining pineapple juice. Chill until slightly thickened. Fold in ham, water chestnuts and chives. Slowly pour over cranberry layer and chill until firm.

to prepare chicken layer: sprinkle gelatin with 1/2 cup of the chicken broth. Place over low heat and stir until gelatin is dissolved. Add to remaining chicken broth. Stir in onion juice. Chill until slightly thickened. Fold in celery, oranges and chicken. Carefully pour over ham layer and chill until firm. Unmold by dipping into lukewarm water for a few seconds. Tap to loosen and

invert on a platter. Garnish with bite-size pieces of chicory or other salad greens.

Place a bowl of mayonnaise in center of mold and serve at once.

Massachusetts Growers

Financial assistance is available for SCHOLARSHIPS and MEDICAL ASSISTANCE for Cranberry Growers, their Employees and the families of both when financial need can be shown. For information contact:

URANN FOUNDATION
P.O. Box 1788
Brockton MA 02403
Telephone 588-7744

FACTS ABOUT FAX

By **JOSEPH ARKIN**

Efficient long distance communication systems have become essential for the modern business enterprise.

Long distance telephone calls meet the need for direct voice communications. TWX and Telex telegraphic systems electronically transmit and receive written messages.

But these systems remain inadequate for those firms with the need to transmit accurate copies of messages, data or graphics. Managers confronting that need should become familiar with facsimile—or fax—systems.

Resembling an office copier, a fax unit sends and receives document copies over ordinary telephone lines. The receiver gains a copy of the sender's document in its original, unchanged form. So, fax meets the need to transmit "time critical" documents that have to be moved quickly.

Facsimile transmission systems have been available for many years. Indeed, the technology underlying facsimile systems date back over 140 years. But several considerations have restricted the widespread use of fax machines in the past.

First, fax machines used to be prohibitively expensive for many businesses. The price of a fax unit ranged between \$15,000 and \$20,000.

That restricted their use to larger businesses with bigger budgets.

Second, facsimile systems were slow. Transmitting a single page of information took as long as six minutes.

Moreover, the transmission process remained a noisy, cumbersome operation that easily discouraged the user. And the reproduction process left the recipient with a poor quality facsimile of the original.



Equipment Inc.

381 West Grove Street (Rte. 28)
Middleboro, MA 02346

KUBOTA Diesel Equipt.

Tractors 2 & 4 wheel drive — 12-90 hp.
Compact Excavators 1½ to 6 ton
Wheel Leaders ½ to ¾ yd.
Water Cooled Diesel Engines 4 to 104 hp.

All Types of Implements

Polymark Beaver-Mowers

947-6299

Specialty Fabrication Work

Kubota Financing as Low as 8½%

***Sales *Service *Parts *Leasing**



Vines For Sale

Early Blacks _____ \$2,500 a ton
Stevens _____ \$4,000 a ton
Howes _____ \$2,500 a ton
Crowley _____ \$3,500 a ton

Prices F.O.B.

R.M. Lawton Cranberries, Inc.
221 Thomas St.
Middleboro, MA 02346

(508) 947-7465

CRANBERRY



COMPUTER, INC.

CRANWARE

- Growers
- Handlers
- Chemical Applications
- Chemical Resale

(508) 291-1192

2 Tobey Road, Wareham, MA 02571

Together, the disadvantages offset the bulk of the benefits expected from the fax system.

INNOVATIONS in recent years have overcome these disadvantages. Today's fax systems are more efficient than previous models. Transmissions over ordinary telephone lines typically take less than one minute. Some take only a few seconds.

Moreover, modern systems have improved reproduction quality dramatically. The better systems can produce high resolution copies instead of blurred facsimiles. Recipients gain an accurate, reliable copy of the original.

The price for modern facsimile systems also has fallen to a level even small businesses can afford.* Technological advances have dropped the price for efficient fax systems to an average of \$2,500. Even top of the line machines run no more than \$4,500.

The lower prices make the systems more attractive for small businesses with the persistent need to transmit accurate copies efficiently. As prices

*Fax machines can be rented, too.

continue to drop, manufacturers expect that many people will buy fax units for personal use in the home. Some expect fax units to become as common in the home as personal computers.

Operating simplicity now adds to the other attractions inherent in modern fax systems. Other than the terminal itself, the user needs only an electrical outlet and a telephone. Nor does any special training become necessary to operate a fax unit. The sender follows three simple steps:

- 1) place the original into the fax unit's document feed;
- 2) dial the telephone number for the receiving unit;
- 3) after making the connection, press the fax button to transmit the copy.

In a few seconds, the receiving unit prints out an exact replica of the sender's original.

The process is even easier for the recipient. All fax units operate as transceivers. A single unit can both send and receive transmissions. And no one needs to be present when a unit receives a transmission.

The recent innovations have raised the number of fax units in operation to over 500,000. The industry projects a 100 percent increase in that total by 1990. The comparative advantage fax offers over other communication systems may make the increase even larger.

MANY managers continue to rely on the

CRANBERRY GROWERS REALTY

*Listings of buyers and
sellers welcomed on
cranberry acreage
and upland.*

Appraisals

DOUGLAS R. BEATON
E. Sandwich, Mass
02537
(617) 888-1288

CASORON® 4G

Effective control of broadleaves and grasses.

If you're looking for a way to control tough weeds, your choice should be Casoron 4G. It's effective against a broad spectrum of broadleaves and grasses, it's economical, and comes in easy-to-use granular form.

**UNIROYAL
CHEMICAL**

Casoron is a Reg. TM of
Uniroyal Chemical Company, Inc.

Please read and follow all
label instructions carefully.

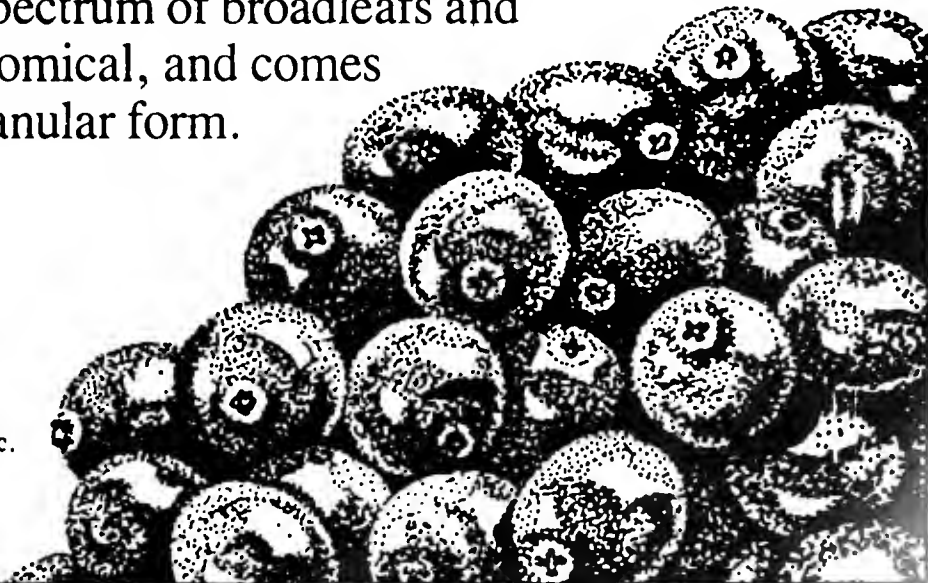

mail to deliver important business documents. Yet, the post office requires several days to deliver the same information fax can deliver in only a few seconds. And fax travels directly to its destination. The mail must pass through collection boxes, substations, airports and carriers.

Using fax may cost more than a postage stamp. But the difference in cost easily may become immaterial. When using fax, you pay only for the price of the phone call each time you send a document. And that provides a link with fax transceivers worldwide, 24 hours every day.

Fax enjoys the same advantages over messenger and courier services. You need

not wait for overnight delivery. Fax can accomplish the same task in a few seconds. Anywhere you can reach by telephone can become a fax transceiver station for the efficient, accurate exchange of information.

Facsimile transmission systems also enjoy some clear advantages over Telex/TWX systems. In any comparison, fax enjoys an advantage when considering cost-per-message unit. But the real benefit from fax comes from the savings in the preparation of materials prior to transmission.

The Telex/TWX user must manually type each page before the actual transmission. For a multi-page document, input time can take hours. The input also remains subject to likely keyboard errors. The fax user simply transmits a copy of the original document.

Moreover, sending drawings or other graphic material over Telex/TWX systems remains impossible. Fax systems send an exact copy of any information you can put on a sheet of paper. That includes copies of typed letters, handwritten notes, contracts, graphs, charts, sales orders, blueprints and photographs. That potential makes fax more

flexible, yet less expensive in terms of the staff time necessary to complete transmissions.

Of course, a fax unit must contribute to a firm's profits before its acquisition makes sense. That contribution develops any time the transmission of an accurate facsimile helps close a sale, reduce expenses or enable the business to operate more efficiently.

Different companies produce competing facsimile systems. And different systems have different features. So, you should sort out what options can benefit your business when comparing the alternatives.

Technicians use Bits Per Second (BPS) as the criterion for measuring fax speed. Higher BPS means faster fax speed. Use BPX in a manner analogous to MPG for car shoppers.

Next, determine the communications capability a particular fax unit has compared to other units. Standards set by the Consultative Committee for International Telephone and Telegraphy (CCITT) determine that capability.

The CCITT created three groups, which describe compatibility between fax units.

VINES FOR SALE

**Howes and
Early Blacks**

CALL

(617) 428-6101

Or

(617) 428-0907

After 6 p.m.

WISCONSIN CRANBERRY HEADQUARTERS FOR SEVIN XLR



DEVRIKOL 10G * EVITAL * GUTHION
DIAZINON 14G * PARATHION * ETHREL

Cole/Grower Service

537 Atlas Ave., P.O. Box 7211, Madison, WI 53707
(608) 221-6204 or 1-800-362-8049



Equipment, Inc.

381 West Grove St. (Rte. 28)
Middleboro, MA 02346

(508) 947-6299

KUBOTA

Tractors, Excavators and
Diesel Generators



Wheel Loaders
3/4 Yd - 6 1/2 Yd

matcon

Screening Equipment

Irrigation Supplies

- 2" to 12" PVC Pipe with Fittings
- Quick Couple Risers
- Felker Aluminum Flumes & Culverts

Replace old aluminum mains with government approved 4", 6" and 8" polyethylene pipe buried just below bog surface. No insert fittings. Rent our butt fusion welder for a continuous main line. Beat the high cost of custom installation by renting our small 4-wheel drive tractor with mole hole plow for buried laterals.

STEARNS IRRIGATION, INC.
790 Federal Furnace Rd.
Plymouth MA 02360
Tel. (508) 746-6048

Fax units in Group 1 had to be mutually compatible. And those included within Groups 2 and 3 also had to be compatible with each other. Group 1 remains the slowest, Group 3 includes the fastest.

Of course, manufacturers now produce fax units that are universally compatible with Groups 3, 2 or 1. These units can communicate with most of the existing fax units in the world.

When reviewing fax specifications, you also should note the resolution, which is rated in lines per inch (LPI). That number provides a measure of the quality of the transmission you can expect. The higher the LPI, the better you can read the fine

print. In any event, review copies of actual transmission before you buy any fax unit.

Manufacturers also have developed many additional features, which enable all users to adapt fax to the unique requirements of their firms. Not every business needs every feature. But you should recognize the options available.

Some fax models allow **automatic dialing**. The system remembers numbers the

user dials frequently. Pressing a single button redials one of those numbers. That becomes useful when a business regularly sends important messages to the same destinations.

An **automatic answer** feature allows unattended reception of documents. This feature makes facsimile a 24-hour a day communication device.

—Arkin Magazine Syndicate

Gapen

Realty & Insurance

Knowledge & ability to unite buyers and sellers for existing marshes or undeveloped land.

2141 8th Street South
Wisconsin Rapids,
Wisconsin 54494
(715) 423-6550



Multiple Listing Service
MLS



WANTED

Gravel & Sand

in the southeastern Massachusetts area

Quantities of 10,000 yards and up

Complete site work, bog construction and finished contouring of surrounding area plus the best price for your material.

Michael Coan
Carver, Mass.
(508) 866-5285

Earl White
Medfield, Mass.
(508) 359-7291

Spring 1989



Vines For Sale

Ben Lear	\$ 3,500.00 per ton
Crowley	\$ 3,500.00 per ton
Stevens	\$ 3,500.00 per ton
Pilgrims	\$ 4,000.00 per ton

Prices F.O.B.

Contact:

LeRoy Miles
Northland Cranberries, Inc.
(715) 424-4444
251 Oak Street
Wisconsin Rapids, WI 54494

Buy 10 tons, get one ton free.

20% down payment with order.

Call for large order pricing.

Vines For Sale

Crowley..... \$3,000 a ton

Searles \$2,500 a ton

10% discount with 50% payment by March 15

Remainder due on delivery or pickup

G. BROCKMAN, INC.
4409 Brockman Road
Vesper, WI 54489

(715) 423-0368

(715) 423-7016

Law Offices of

James Taylor Pye

*James Taylor Pye
David Churchill Barrow
James S. Hartford*

24 Bay Road/P.O. Box 2899
Duxbury, Massachusetts 02331
617-934-6575

Bog renovation and Bog development

(Conservation Commission, DEQE, Mass EPA, EPA and Corps of Engineers)

Business, retirement and estate planning

(Incorporations and partnerships, pensions and profit sharing plans, and Wills and Trusts)

Land disposition

(Purchase, sale and financing of existing bogs and potential sites)

Land use management

(Board of Appeals and Planning Board)



ABEL'S APIARIES

*Strong Beehives Available
For Cranberry Pollination
Truckload Lots*

Call or Write:

Abel's Aplarles
P.O. Box 234
Sydney, Florida 33587
Phone (813) 659-0784 or
(301) 592-9712

YANKEE PLANNERS, INC.

59 North Main Street
Middleboro, MA 02346
(508) 947-0527

**Sound and Objective
Advice
Suited to
Your Needs**

- *Tax and Estate Planning*
- *Investment & Insurance Review*
- *Business Continuity*
- *Asset Protection*
- *Key Employee Retention*
- *Business Tax Analysis*

Mr. William H. Bestgen, Jr.
Chartered Financial Consultant

Mr. Peter W. Hutchings
Attorney at Law practicing as
a Tax Attorney

Mr. Roger H. Parent, Jr.
Accountant, Enrolled to Practice
before the Internal Revenue
Service

Call For Your Free Brochure
(508) 947-0527

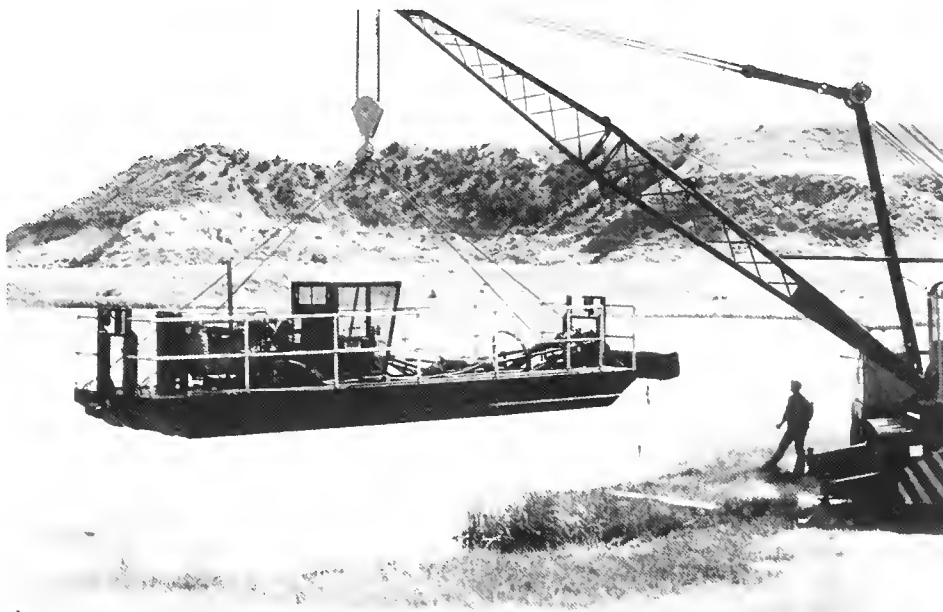

***For Reliable Dredges and Pumps,
Cranberry Growers Look to Crisafulli***

Your Crisafulli pumping equipment will be manufactured just for you, with your choice of power options and discharge size. If you need to dredge sand, call us for quotations and specifications. We will supply you with exactly what you need, not something designed for somebody else! For information, quotations, local representation, call:

1-800-442-7867

or FAX 406-365-8088

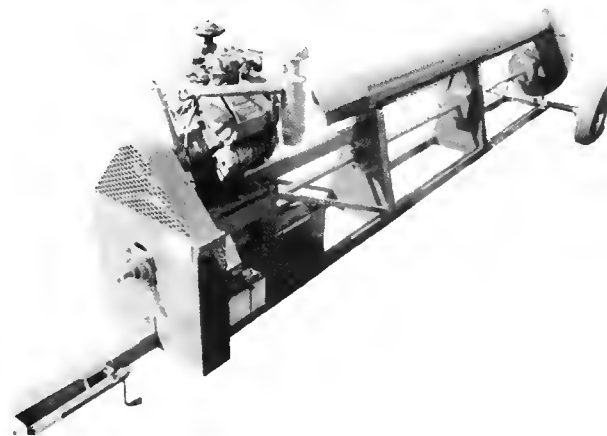
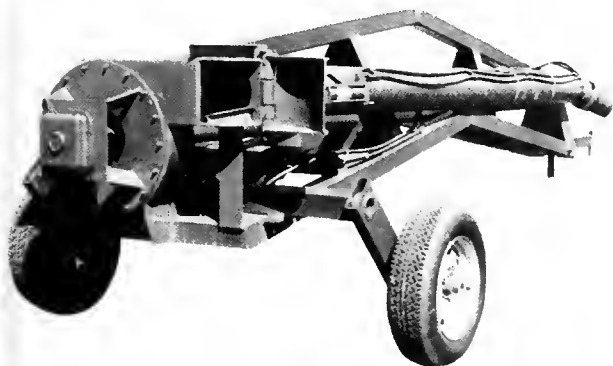

Take Good Care of Yourself Have an Ocean Spray!



The farmer's cooperative that brings you
a wide range of natural fruit juices, drinks and sauces
Ocean Spray Cranberries, Inc., Plymouth, Massachusetts 02360
An Equal Opportunity Employer

13
7
r



4 Million Barrel Crop S Blocking Cold With Fabric The Craisins ,

UNIV OF MASS LIBRARY
SERIALS DEPT
AMHERST MA
01003

First 4 Million Barrel Crop

GONG!

By **IRVING E. DEMORANVILLE**
Director, Massachusetts Cranberry
Experiment Station

The latest crop report from the New England Agricultural Statistics Service indicates a 1988 national cranberry crop of 4,019,00 barrels.

Of course, that's not the final count. But if the data hold up, this would be the first 4 million barrel crop in the history of the industry.

The 4,019,000 barrel figure represents a whopping 21 percent increase over 1987.

The Massachusetts cranberry crop is estimated at 1,910,000 barrels, 32 percent above '87 and a record.

In fact, all of the leading cranberry growing states except Washington posted a record crop and even that state showed an increase over '87. The increase: 3 percent.

Wisconsin was second to Massachusetts in production with 1,450,000 barrels. Its crop was 9 percent larger than 1987's.

New Jersey showed an increase of 24 percent with a total of 370,000 barrels.

Oregon, with 154,000 barrels, was 8 percent over 1987.

Office
295-2222

BEATON'S CRANBERRY GROWERS SERVICE

K. Beaton
295-2207

D. Beaton
888-1288

WAREHAM, MASS.

P. Beaton
947-3601

Specializing in

○ COMPLETE BOG
MANAGEMENT

○ NETTING

○ DITCHING

○ HARVESTING
(Wet & Dry)

○ SANDING

○ CUSTOM
HERBICIDE
APPLICATION

Complete line of portable Crisafulli Pumps 2" - 16"
Plastic netting for suction boxes



Spunbonded Fabric Covers: A Solution to Wintry Woes?

By **ELDEN J. STANG**

Professor of Horticulture

University of Wisconsin/Madison

Increasingly, growing competition and concern for water resources suggest cranberry growers are likely to face long term regulation and, in a worst case scenario, restrictions on water use.

The drought of 1988 served to highlight again the critical need for water in cranberry production.

A major water use is flooding for winter protection, absolutely critical in today's production scheme for cranberries in Wisconsin. Equally important is adequate water for frost protection by sprinkler irrigation.

Decades ago, researchers in Wisconsin and elsewhere showed that cranberries can be effectively and

safely protected from frost or overwintered with organic mulches, i.e., straw, marsh hay, leaves, etc. Overlaid with clear plastic to keep the mulch dry, cranberries are readily overwintered, largely through retention of soil heat and prevention of desiccation.

Conventional solid bed production practices for cranberries, however, do not lend themselves to the use of organic mulches for winter or frost protection—nor would sufficient mulch be available. Mulch application and removal also would create a nearly insurmountable deterrent to their use under existing production practices.

IS THERE an alternative? The development of lightweight spunbonded polypropylene and polystyrene covering sheets in the past decade has quickly changed plant nursery practices.

Cold tender ornamentals and conifers are now commonly protected from cold with spunbonded fabric covers. Spunbonded row covers are also rapidly being

adapted for vegetable and small fruit (strawberry, raspberry) production.

Spunbonded fabrics are not knitted or woven plastics but rather are extruded as tiny, continuous filaments. After cooling, these filaments are laid down on a moving belt and bonded into a cloth-like sheet, using a combination of heat, pressure and chemicals. Wherever the fibers cross, they are bonded together, limiting the unraveling and stretching found with woven fabrics.

Like other fabrics, spunbonded sheets permit the passage of light, water and air. For plant growers, this permits plants to breathe and allows irrigation without removal of the cloth.

Early on, research with lightweight, spunbonded row covers on tobacco, turf and vegetables showed that the covers provided 4° to 7°+ frost protection, that humidity was increased, moisture was conserved and earlier plant growth and maturity resulted.

A primary benefit noted is a

COVER PHOTO

ELDEN J. STANG, professor of horticulture, University of Wisconsin/Madison, took this photo of Typar spunbonded fabric covers applied over Searles cranberries at R.S. Brazeau Cranberries, Inc., Wisconsin Rapids, Wisc. A story on the covers starts on this page.

CRANBERRY GROWERS REALTY

Listings of buyers and sellers welcomed on cranberry acreage and upland.

Appraisals

DOUGLAS R. BEATON
E. Sandwich, Mass
02537
(617) 888-1288

Apply Now For The 1989 Season

DeCran Integrated Pest Management

Serving Massachusetts Cranberry Growers

- ★ Experienced Consultants
- ★ Scout Training
- ★ Right to Know Training
- ★ Insect and Weed Identification
- ★ Botanical and Insect Reference Mounts
- ★ Pheromone Trap Kits:
 - Cranberry Girdler
 - Sparganothis Fruitworm
 - Blackheaded Fireworm

★ Updated Information on Latest Research and Developments in Cranberry Science

Contact:

Monika Schuler
DeCran AG Supplies
461 Mary's Pond Road
Rochester, MA 02770

Office: (508) 295-2731
Evening: (508) 996-6120

Our Acreage Is Limited So Sign Up Now!

reduction in plant dehydration under the covers. In strawberries, spunbonded row covers have shown promise for providing overwintering protection in place of the organic mulches normally used.

INTRIGUED by these results, we set out a test plot in cranberries

Niemi Electric Company



Robert
Niemi
Electrical
Contractors

Heat, Light & Power Wiring

- RESIDENTIAL
- COMMERCIAL
- INDUSTRIAL

Pinehurst Drive
Wareham, Mass.
TEL. 295-1880

CRANBERRIES

THE NATIONAL CRANBERRY MAGAZINE

SEND CORRESPONDENCE TO:

**P.O. BOX 249
COBALT CT 06414
(203) 342-4730**

PUBLISHER & EDITOR: BOB TAYLOR

**ASSOCIATE EDITOR: CAROLYN GILMORE
(508) 783-5206**

ADVISORS & CORRESPONDENTS

MASSACHUSETTS — Irving E. Demoranville, Director, Cranberry Experiment Station.

NEW JERSEY — Phillip E. Marucci, Cranberry & Blueberry Specialist, Buddtown; Elizabeth G. Carpenter, Chatsworth.

NOVA SCOTIA — Robert A. Murray, Horticulturist, Berry Crops, Research Station, Truro.

OREGON — Arthur Poole, Coos County Extension Agent, Coquille.

WASHINGTON — Azmi Y. Shawa, Horticulturist and Extension Agent in Horticulture, Coastal Washington Research & Extension Unit, Long Beach.

WISCONSIN — Tod, D. Planer, Farm Management Agent, Wood County.

CRANBERRIES is published monthly by Diversified Periodicals, Wellwyn Drive, Portland CT 06480. Second class postage is paid at the Portland, Conn. Post Office. Price is \$15 a year, \$28 for two years, \$2 a copy in the U.S.; \$17 a year in Canada; \$20 a year in all other countries. Back copies: \$2.50, including postage. Copyright 1988 by Diversified Periodicals.

ISSN: 0011-0787

Postmaster, send Form 3749 to:

CRANBERRIES
P.O. BOX 249
COBALT CT 06414

this season, using Typar spunbonded polypropylene.

Typar is a heavy duty form of the fabric which resists punctures and tearing, with ultraviolet stabilizers added for resistance to degradation by sunlight. Weight of the sheet is 1.9 oz/sq. yard. Sunlight resistance, hopefully, would allow for reuse of the fabric for two or more seasons.

Both Reemay, a lighter duty spunbonded polyester, and Typar are manufactured by the Reemay Co., P.O. Box 511, Old Hickory, TN 37138.

A **SINGLE** plot totaling 22,800 sq. feet was covered, using four sheets of Typar, at R.S. Brazeau Cranberries Inc., west of Wisconsin Rapids, Wisc., on Dec. 5, 1988.

At intervals throughout this

spring, we plan to measure plant canopy temperatures and humidity under the mulch. Following ice-out in spring, individual covers will be removed at intervals to determine effects on early growth. Blossom and fruit counts will be made in the summer to determine if plastic row covers can indeed provide adequate frost protection.

ARE spunbonded fabrics also a possibility for winter protection of cranberries?

Unfortunately, an unflooded cranberry bed was not available to test for winter protection with Typar. It is our plan to test these materials on an unflooded bed in 1989 if our preliminary frost protection tests with the material do show promising results.

WOLLSCHLAGER EXCAVATING

Dragline Work — All Kinds

Also Have Clam & Scalping Buckets

Route 1 Necedah, WI 54646
1-808-585-2436

WANTED

Gravel & Sand

in the southeastern Massachusetts area

Quantities of 10,000 yards and up

Complete site work, bog construction and finished contouring of surrounding area plus the best price for your material.

**Michael Coan
Carver, Mass.
(508) 866-5285**

**Earl White
Medfield, Mass.
(508) 359-7291**



Another growing season is underway as the winter flood waters come off. With the growing season, there are growing season problems: frost, pollination and insects . . .

Know the Insects

The major cranberry insects: cranberry girdler, the fireworms, tipworm, blossom worm, cranberry fruitworm and Sparganothis fruitworm.

Know the Insects

The periodic cranberry insects: cranberry scale, fire beetle, blossom weevil, armyworm and bluntnose leafhopper.

Know the Insects

Color photographs of all these insects and more are now arranged with text in a portfolio that is available.

The portfolio endeavors to bring together the words of research complementing the photographs and making a summary of cranberry insect information that will be of use to the cranberry grower for a lifetime.

The portfolio is available for \$100 and, if you wish to examine a copy, telephone (609) 894-8556 evenings around 6 p.m. or write to:

**Walter Z. Fort
P.O. Box 183
Pemberton, NJ 08068**

Regional Notes

MASSACHUSETTS

By IRVING E. DEMORANVILLE

Dr. Robert Devlin of the Massachusetts Cranberry Experiment Station attended the Northeastern Weed Science Society meeting in Baltimore Jan. 3-8. He presented two papers and was involved in committee activities.

Dr. Irena Zblec also attended the weed science meeting.

Carolyn DeMoranville presented a paper on cranberry plant nutrition at the American Society for Horticultural Science, Northeastern Regional Section, meeting held in Martinsburg, W. Va., Jan. 5-7.

John C. Decas, major Massachusetts independent grower and owner of DeCran Ag Supplies, attended the recent annual meeting of the National AgriChemical Retailers Association in Las Vegas. Formed in early 1988, NARA is an independent trade association made up of 1,600 retail agricultural chemical dealers from across the U.S.

OREGON

This year's Bandon Cranberry Festival will be held on Sept. 29 and 30. Susan Coates has agreed to serve again as the Cranberry Festi-

val Association president.

5.5 acre cranberry bog.

"The Ocean Spray Success Story" was the title of a recent talk before the Bandon Chamber of Commerce given by Mary Schamehorn.

WASHINGTON

A retirement party was held Feb. 17 for Azmi Y. Shawa, director, Coastal Washington Research & Extension Unit, Long Beach. Horticulturist and County Extension Agent Shawa began his career with Washington State University in 1955. The genial Shawa will occupy much of his time with management of his own

WISCONSIN

Northland Cranberries Inc. of Wisconsin Rapids announces that its fourth quarter earnings for 1988 showed a 50 percent increase over those of 1987.

For the quarter which ended Dec. 31, 1988, Northland reported net income of \$1,372,302, or 57 cents a share, on sales of \$5,326,695. That compared with a net income of \$931,538, or 38 cents a share, on sales of \$3,888,416 for the same period in 1987.

Northland has nine marshes with a total acreage of 660 acres in central and northern Wisconsin.

ORTHENE

BUILDS PROTECTION

YOUR FOUNDATION INSECTICIDE FOR SPARGANTHIS, FIREWORM AND SPANWORM CONTROL

Distributed by:



VOLM BAG COMPANY, INC.

1804 EDISON ST. BOX B, ANTIGO, WIS. 54409-0116
PHONE 715/627-4828

Irrigation Equipment Designed Especially for the Cranberry Industry

- Gorman-Rupp Self Priming Electric Sprinkler Pumps
- Proven Quick Couple Riser
- Polyethylene Main Lines, 3" - 12"
- Butt Fusion Equipment Available
- Paco/Wemco Water Harvest Pump
- Berkeley Self-Priming and Centrifugal Pumps

A Most Complete Inventory of Irrigation Accessories

LARCHMONT

IRRIGATION / SNOWMAKING

P.O. Box 66, 11 Larchmont Lane
Lexington, Massachusetts 02173 (508) 862-2550

Contact

Larchmont Engineering
Phil Tropeano, President
(508) 862-2550
(Call Collect)

Stearns Irrigation, Inc.
790 Federal Furnace Rd.
Plymouth, MA 02360
(508) 746-6048

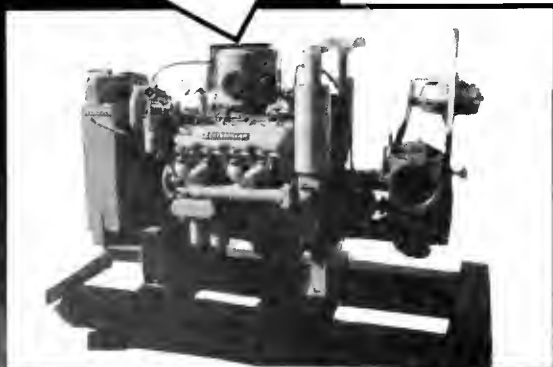
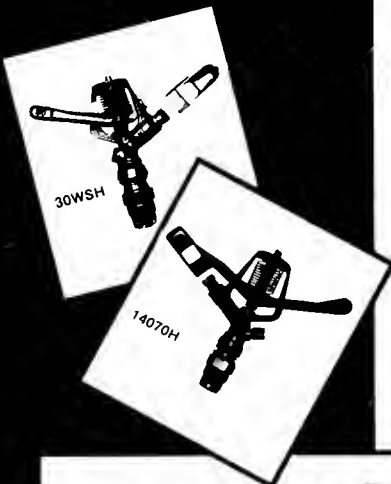



THE BEST — IN EVERY RESPECT

CRANBERRY Model 400 GT

Precision Chemigation System



- Developed *Exclusively* for the Cranberry Industry
- Exceeds or Meets ALL Current EPA Requirements
- Simple to Operate and Easy to Calibrate
 - Self-Timer Application (1 minute Increments)
 - Easy Access Handle & Simple Reference Scale
 - Precise Visual Flow Calibration
- Outstanding Field Performance
 - Down-Line Venturi Injection System
 - High Capacity 0-7 GPM Injection Rate
 - Large Volume 175 Gallon Mix Tank
 - 12 Volt Gear Reduction Mixer
- Designed for Trouble-Free Operation
 - Reliable 11 HP Honda Electric Start Engine
 - Critical Components Are Stainless Steel & Polypropylene
- Completely Self-Contained and DOT Approved Transportable
- Personalized, Experienced Support Service as Close as Your Phone

CHEMIGATION SYSTEMS INTERNATIONAL, INC.

Corporate Offices: P.O. Box 247
(608) 297-2041

Montello, WI 53949
FAX: (608) 297-7248

Call us today for the dealer nearest you, or contact:

Skip Tenpas
Central Sands Irr. & Bldg., Inc.
Hwy 51 & 73 Interchange
Plainfield, WI 54966
(715) 335-6372

Bruce Sunnerberg
AAA Industrial Pump & Ser., Inc.
66 Lake Street
Plympton, MA 02367
(617) 585-2394

NOTICE
Selected exclusive
dealer territories
still available —

Inquiries Invited

EPA Bars Use of Captan

Stating that the fungicide captan posed a significant risk of cancer, the U.S. Environmental Protection Agency recently barred use of the chemical on 42 fruits and vegetables, including cranberries.

The agency decided to permit its continued use on 24 other fruits and vegetables, however, including blueberries.

Captan is one the country's most heavily used agricultural chemicals. According to the EPA, about 10 million pounds of captan are applied to crops each year. The fungicide is processed by some 80 companies.

The EPA's stand was based on findings that captan use caused cancer in laboratory animals.

Dr. John A. Moore, acting deputy administrator of the EPA, said the risk of humans getting cancer over a 70-year lifetime from eating any one of the 42 fruits and vegetables on which captan use is forbidden is less than one in a million. He added, however, that the aggregate risk from eating all of them was one in

100,000.

Besides cranberries, the list of 42 includes avocados, beans, beets, broccoli, Brussels sprouts, bulb onions, cabbage, carrots, cantaloupes, cauliflower, celery planted in fields, collards, cotton, crabapples, cucumbers, eggplants, grapefruits, honey-dews, kale, leeks, lemons, limes, muskmelons, mustard greens, oranges, preharvest pears, peas, pineapples, potatoes, pumpkins, quince, rhubarb, rutabagas, shallots, soybeans, squash, sweet corn, tangelos and tangerines, tomatoes

in fields, turnips and watermelons.

EPA allowed the continued use of captan on blueberries and 23 other fruits and vegetables because the residues of the chemical on those foods were low enough to keep the risk negligible.

In other action in February, the EPA said that daminozide, used on apples to make the fruit ripen uniformly and to enhance its appearance and shelf life, poses a significant risk of cancer. However, the agency will permit its use for at least 18 months.



Irrigation Supplies

- 2" to 12" PVC Pipe with Fittings
- Quick Couple Risers
- Felker Aluminum Flumes & Culverts

Replace old aluminum mains with government approved 4", 6" and 8" polyethylene pipe buried just below bog surface. No insert fittings. Rent our butt fusion welder for a continuous main line. Beat the high cost of custom installation by renting our small 4-wheel drive tractor with mole hole plow for buried laterals.

STEARNS IRRIGATION, INC.
790 Federal Furnace Rd.
Plymouth MA 02360
Tel. (508) 746-6048

PORTABLE MICROSCOPES

Professional, inexpensive microscopes for examination of plants in the field for:

SOUTHERN RED MITE * PARASITIZED FRUITWORM EGGS
NEMATODES * TIPWORM LARVAE IN UPRIGHTS

Two models, 25x fixed or 18-36x variable magnification. Sold with a 20-day trial guarantee. Call for our complete catalog, references, prices.

PEST MANAGEMENT SUPPLY INC.
P.O. BOX 938
AMHERST, MA 01004
800 272-7672
413 253-3747 (in Mass.)



Ocean Spray Figures The Public'll Go Crazy Over Craisins

The latest in a long line of Ocean Spray products—Craisins—is expected to be available on supermarket shelves nationwide within a year.

The sugar-infused, dried fruit will be test-marketed in a still to be determined area in the late summer, according to John Moreton, division manager, new products.

Lloyd Wolfe, owner of Wolfe Cranberry Co., Nekoosa, Wisc., is among those who believe the new product is going to be met with an enthusiastic public reception.

Wolfe was quoted by *The Daily*

Tribune of Wisconsin Rapids as saying, "I think they're super."

Mostly Wisconsin berries will be used once production gets underway for the general public, according to Jerry Bach, receiving station manager at Ocean Spray's Babcock, Wisc., plant. Most of the drying of the fruit probably will take place in Michigan, adds Bach.

In addition to being a tasty fruit snack that can be popped into the mouth, craisins also are intended for a wide variety of products, including baked goods, cereals and dairy foods.

Rich O'Brian, national sales manager, ingredients, says the cooperative is producing "a quality fruit ingredient at a reasonable cost for major food companies."

"Other fruit will not hold up as well to infusion and air drying," said O'Brian. "The cranberry has a strong cell structure needed for the process.

"The bright, red berry color makes Craisins an ideal ingredient for (cereals, baked goods and dairy products).

"Major companies in these categories want a way to communicate

CASORON FREE

Vines For Sale

NO DODDER

Ben Lears \$4,500 a ton

*Orders paid in advance
by February
receive a 10% discount.*

40 Tons Available

**Jonjak Cranberry Farm Inc.
Hayward, Wisconsin**

**Call Randy Jonjak
(715) 634-3979**

Stevens \$4,000 a ton

*Orders paid in advance
by February
receive a 10% discount.*

30 Tons Available

**Cranberry Springs Inc.
Hayward, Wisconsin**

**Call Stanley Roy Jonjak
(715) 634-3044
(715) 634-3286**

TRUE VARIETIES

HONEST WEIGHTS

clearly to consumers that they have real fruit in the product. Now we can offer a contrast to the browns and beiges which most fruit and nuts provide."

Ocean Spray's ingredient division has been aggressive in promoting this product even while the development work was continuing.

"We wanted to get feedback from customers as to exactly what characteristics they wanted," said Dr. Tom Aurand, technical project leader, ingredients.

"It's important to adjust the manufacturing technique for an ingredient to meet the specific requirements of your target customers."

Initial response from customers has been "tremendous," reports Ocean Spray.

Craisins have already been presented in a major retail product—a Tyson gourmet dinner that uses the dried cranberries in a stuffing for one of their new chicken entrees.

Future ideas for dried cranber-

ries include natural fruits flavors, such as raspberry or strawberry, modifying sweetness and moisture

content of the fruit and adjusting the size of individual pieces to meet the needs of various industries.

R. D. GRASSI *Cranberry* SERVICES

**Herbicides
Applied**

*Custom Pruning
Custom Ditching*

*Sanding
Wiping
Wet Harvesting
Mowing*

*(Mowing includes
Hydraulic Arm
Flail Mower.)*

**West Wareham,
Massachusetts**

**Ask for Rick at
295-5158**

HONEY BEES AVAILABLE FOR

Pollination

- ★ 25,000 Strong Colonies Available
- ★ State and Federal Inspected
- ★ Cranberries, Blueberries, Etc.
- ★ 72 Hour Delivery East of the Mississippi River
- ★ Radio Dispatched Trucks

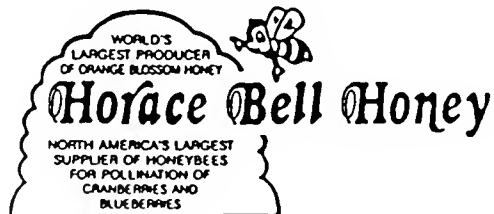

Lamar Hester
General Manager 734-3276 Evenings

1058 S. Ridgewood Ave.
DeLand, Florida 32720

Office: (904) 734-7798
736-3841
734-5043

Ocean Spray Sponsors Great Strides 10K Walk

Community involvement is a habit with Ocean Spray Cranberries Inc., which these days is sponsoring everything from a high school wrestling tournament in Bandon, Ore., to a nationwide 10K walk for the benefit of cystic fibrosis research.

The wrestling tournament, the First Annual Cranberry Classic, took place in February and involved seven Oregon teams and one from Anchorage, Alaska. Bandon bills itself as the Cranberry Capital of Oregon.

The walk—the Great Strides 10K Walk—will take place on May 21 and involve more than 40 cities in 25 states and Washington, D.C.

Besides guaranteeing the Cystic Fibrosis Foundation a cash donation of \$200,000, Ocean Spray has launched a \$1 million promotional campaign in behalf of the event.

Identification of the cystic fibrosis gene and gene therapy are the main thrusts of research in cystic fibrosis, the leading genetic killer of children and young adults in the U.S.

Some 30,000 children and young adults have cystic fibrosis, which affects the lungs and pancreas,



DANNY BESSETTE, 4, is one of the children cystic fibrosis researchers hope to be able to help.

interfering with breathing and digestion.

As part of the promotional cam-

paign, free standing inserts (Sunday coupon supplements) and Ocean Spray product labels are being used

The CHARLES W. HARRIS Company

451 Old Somerset Avenue
North Dighton, Mass.
Phone (508) 824-5607

AMES
Antisyphon Devices

RAINBIRD
Sprinklers

HALE
Pumps

*Highest Quality Products
With Satisfaction Guaranteed*

Vines For Sale

<i>Ben Lear</i>	\$3,500 a ton
<i>Stevens</i>	\$3,500 a ton
<i>Crowley</i>	\$3,500 a ton
<i>Le Munyon</i>	\$3,500 a ton
<i>Searles</i>	\$3,500 a ton

\$500 a ton less with 50% payment before cutting

*Lake Nokomis
Cranberries, Inc.*

David Zawistowski

6031 County Highway D (715) 479-4658
Eagle River, WI 54521 (715) 479-6546

to encourage people to participate in Great Strides. Ocean Spray will provide the cooperative's products at pre-event rallies and parties and along the walk route.

"Ocean Spray is very excited at the prospect of working with the Cystic Fibrosis Foundation on Great Strides," said Kevin Murray, director of business operations, Ocean Spray. "Great Strides will provide us with an opportunity to increase our visibility as well as our sales.

"But more than being a good business proposition, Great Strides makes everyone who works at Ocean Spray, from the President and CEO to the cranberry farmer who supplies us with our product, feel like they are doing something to help another person.

"We are a family business, providing a family product, and now we are doing something to help families in need. By sponsoring Great Strides, we give something back to the families who have supported Ocean Spray by buying our products."



OCEAN SPRAY announced its sponsorship of the Great Strides 10K Walk at a recent meeting of the National Food Brokers Association in San Francisco. L. to r.: Barry Gump, trustee-at-large, Cystic Fibrosis Foundation (CFF); Janice Collins, CFF director of corporate marketing; Barbara Balik, executive vice chairman, CFF national board of trustees; Tom Bullock, vice president of business operations, Ocean Spray.

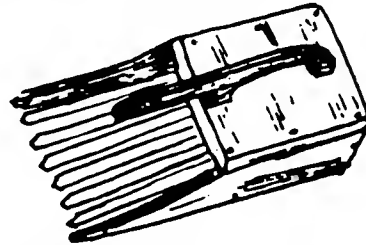

Decan Ag Supplies

Inc.

- ★ Complete line of cranberry herbicides, fertilizers, insecticides, fungicides, miticides. In stock when you want them.
- ★ Best application and safety equipment for your needs.
- ★ Quality aerial applications.
- ★ Proven frost warning equipment. Don't take chances — buy the best.
- ★ Experienced cranberry consulting service offering pheromone traps and baits.
- ★ Right to know training.
- ★ Culvert Pipe — All sizes — steel, aluminum, and poly.
- ★ Ditch Mud Mats — Strong — lightweight — durable.
- ★ Burlap Picking Bags — Best for your money.
- ★ Sanding by helicopter.

John C. Decas

William D. Chamberlain

461 Mary's Pond Rd.
Rochester, MA 02770

Office: 295-2731
Evening: 763-8956
Fax: (508) 291-1417

Serving Massachusetts Cranberry Growers

fall. We have the normal on and there dry or nearly , no winterkill y.

I.E.D.



Fruit rot. No threat.

 It's hard enough to bring in a good cranberry crop without the threat of fruit rot diseases.

That's why cranberry growers are turning to a better way to control fruit rot. Bravo 720.

Bravo delivers consistent, first-rate control of all the major fruit rot diseases that threaten cranberries. Plus leaf and twig blight (Lophodermium), too.

And that's backed by results of eight years of testing which show that Bravo 720 is more effective on fruit rot diseases than all other fungicides.

What's more, Bravo won't adversely affect fruit color. Or leave any lingering odor after application.

And remember, you can apply Bravo with conventional spray equipment or through sprinkler irrigation. The advanced flowable formulation of Bravo 720 is easy to handle, easy to mix.

So, this season, use Bravo 720 to protect your cranberry crop from fruit rot diseases. Just make your first spray at early bloom and stick to a regular 10- to 14-day schedule.

End the threat of these fruit rot diseases and bring in a bigger yield come harvest.

Bravo. Because you give it all you've got.

Fermenta Plant Protection Company,
5966 Heisley Road, P.O. Box 8000,
Mentor, OH 44061-8000.

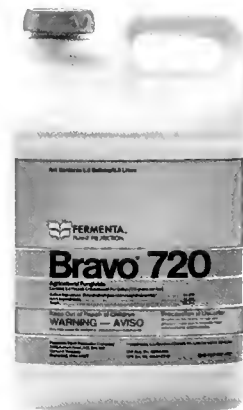

Always follow label directions carefully when using agricultural chemicals

Bravo[®] 720.

®
C-
ol
IS



to encourage people to participate
 in Great
 provide t
 at pre-ev
 along the

"Ocean
 the pros
 Cystic Fi
 Strides,"
 tor of bu
 Spray. "I
 us with e
 our visib

"But r
 business
 makes ev
 Spray, fr
 to the cr
 lies us v
 they are
 another

"We an
 viding a
 we are
 families
 Great St
 back to t
 ported O
 products



- ★ Con
 miti
- ★ Best
- ★ Qua
- ★ Prot
- ★ Exp
 bait
- ★ Righ
- ★ Cul
- ★ Dite
- ★ Burl
- ★ Sane

Weather

MASSACHUSETTS

January was considerably warmer than normal, averaging 3.8 degrees a day above average. Maximum temperature was 53 degrees on the 24th and the minimum was 5 degrees on the 4th. Generally the first week of the month was cold and the rest was very

warm. It was the warmest January since 1975 but only the ninth warmest in our records.

Precipitation totaled 1.78 inches, or about 2½ inches below normal. This was the sixth lowest January total in our records. There was measurable precipitation on seven days, with 0.55 on the 15th as the greatest 24-hour amount. There was no snow recorded for only the fourth time since we have been keep-

ing records. 1969, 1951 and 1934 were the other Januaries without snowfall. We have received only 37 percent of the normal December-January precipitation and there are many unflooded bogs and dry or nearly dry reservoirs and ponds. So far, no winterkill conditions—we have been lucky.

I.E.D.

CRANBERRY



COMPUTER, INC.

CRANWARE

- Growers
- Handlers
- Chemical Applications
- Chemical Resale

(508) 291-1192

2 Tabey Road, Wareham, MA 02571

Turf

Equipment Inc.

381 West Grove Street (Rte. 28)
Middleboro, MA 02346

KUBOTA Diesel Equipt.

Tractors 2 & 4 wheel drive — 12-90 hp.

Compact Excavators 1½ to 6 ton

Wheel Leaders ½ to ¾ yd.

Water Cooled Diesel Engines 4 to 104 hp.

All Types of Implements

Polymark Beaver-Mowers

947-6299

Specialty Fabrication Work

Kubota Financing as Low as 8½%

*Sales *Service *Parts *Leasing



Devrinol. The Gentle Herbicide for Cranberries.

With gentle protection, DEVRINOL® 10-G herbicide provides broad-spectrum weed control of over 40 broadleaf weeds and grasses, including nutsedge. DEVRINOL gives you long-lasting control throughout the season. And it's easy to apply—on the ground or in the air.

For more information, see your dealer or call the ICI Information Line: 1-800-759-2500.

Always read and follow label directions carefully.

DEVRINOL



Controlled nutsedge control in Massachusetts and New Jersey only. See label for specific recommendations.

editorial



Over the 4 Million Hurdle

Wow! A 4 million barrel cranberry crop. Hats should go off to everybody in the field, from grower to agricultural scientist to marketer. This is an astounding achievement regarding a berry that's small in size but prominent on the shopping lists of the American consumer.

Keep the Ideas Coming

Heavily responsible for the 4 million barrel crop, of course, are the people in the white coats who develop and test new product ideas in the lab. Their latest wonder is the craisin, which, if early predictions come true, will make a big hit on supermarket shelves.

A Good Citizen

Civic involvement can make good cents. It also bespeaks a sense of civic responsibility that goes beyond the bottom line. Ocean Spray is demonstrating such civic responsibility with its heavy involvement in the fight to find a cure for cystic fibrosis. Scientists are on the threshold of identifying the gene that causes the dreaded disease. Ocean Spray's effort could prove to be the push that gets them over the top.

Capstan Issue a Sign

The EPA's banning of Capstan is a likely signal of things to come. That doesn't mean a blanket restriction on chemicals. But it does mean judicious use, greater attention to alternatives, and increased education. Not only will there be a greater demand for knowledge on the part of the grower. But the general public will have much to learn about the appropriate use of chemicals.

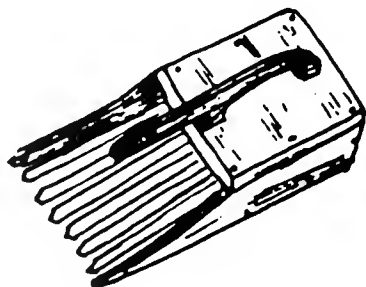

FERMENTA PROVIDES FOUR INTERNSHIPS

Four university students completed internships with the Fermenta Plant Protection Company of Mentor, Ohio, last summer.

The students, John Nygaard of Scandinavia, Wisc., Steven Kammerer of Xenia, Ohio, Christopher Davis of Attica, Ind., and Taron Thorpe of Newville, Ala., spent three to four months learning about diseases that damage food crops and the protective benefits of fungicides.

Pump Repairs & Sales

All Types

- Field Service
- Chemigation Equipment Sold
- Demonstration by Appointment

AAA Industrial Pump Service Inc.

Bruce Sunnerberg
66 Lake Street
Plympton, MA 02367
(617) 585-2394



Equipment, Inc.

381 West Grove St. (Rte. 28)
Middleboro, MA 02346

(508) 947-6299



Tractors, Excavators and
Diesel Generators



Wheel Loaders
3/4 Yd - 6 1/2 Yd



Screening Equipment

LAB MADE FUNGUS KILLS WEEDS

Another sign of the rapid development of agricultural biotechnology was the announcement recently of a new fungus with natural weed-killing properties.

The fungus, known to scientists as *Alternaria cassiae*, does not harm crop plants. It will be marketed in 1990, under the trade name Vasst bioherbicide, by Mycogen Corp., San Diego, said James S. Bannon, director of Mycogen's research station in Ruston, La.

Bannon made the announcement at a biological pest control conference in Washington, D.C.

Casst will be used against coffee senna and sicklepod weeds in peanut and soybean crops.

POLLINATION

Are you getting the most for your pollination dollar? Be sure the hives you rent give you maximum return. We can help. (We are not pollinators: we do not rent hives.) Brochure available. Apicultural Associates, RR 1 Box 225, Charlemont, MA 01339, (413) 339-5320, (413) 625-9630.

**What's New For '89?
THE "REEL THING"!**

The Cranberry Connection will once again be accepting pre-paid orders for our newest sweatshirt until April 30, 1989.

All shirts are printed in fine quality 50/50 polyester/cotton sweatshirts. This year there are two color combinations available—white lettering on "Howe-berry" red (adults) and "Holly-berry" red (children); or "Howe-berry" red lettering on a gray background (all sizes). Our design asks "WHAT'S THE REEL THING?" on the front; answers "CRANBERRIES" on the sleeve!

Make checks/money orders payable to THE CRANBERRY CONNECTION & mail to Ann L. Dunham, P.O. Box 661, So. Carver, MA 02366. Orders will be accepted only if postmarked no later than April 30, 1989. Allow 4-6 weeks after that date for delivery of your order.

Please type or print clearly

Gray Sweatshirt	"Howe-Berry" Red Sweatshirt
Name _____	Name _____
Address _____	Address _____
Town _____	Town _____
Number of shirts desired:	
Adult: @ \$16.00	Adult: @ \$16.00
S(34-36) _____ M(38-40) _____	S(34-36) _____ M(38-40) _____
L(42-44) _____ XL(46) _____	L(42-44) _____ XL(46) _____
Children: @ \$14.00	Children: @ \$14.00
S(6-8) _____ M(10-12) _____	S(6-8) _____ M(10-12) _____
L(14-16) _____	L(14-16) _____

Cranberry Harvesting Equipment

Warrens Equipment & Manufacturing Co., Inc.

Growing cranberries is something you as a grower do best. Manufacturing of harvesting equipment, air flow, radar controlled fertilizer spreading equipment, and flow gates or flumes is something we do that can be of service to you.



NEWS FLASHES

New All Aluminum Bog-Tractor & Beater for 1989 with Features such as:

- All hydrostatic 4-wheel drive
- Safety parking brake
- Fenders
- Ground speed and reel speed indicator
- On-the-go reel speed change
- Lighter weight
- Engine horsepower available from 18 h.p. to 48 h.p.

Be sure to check this new model harvester before you make a purchase for 1989.

WEM Factory serving Wisconsin, West Coast, British Columbia
111 Grant St.
Warrens, WI 54666
Tel. (608) 378-4794
(608) 378-4137

WEM East Coast
Steams Irrigation, Inc.
790 Federal Furnace Rd.
Plymouth, MA 02360
Tel. (508) 746-6048



For pure elegance in the most perfect taste, nothing is more appropriate than planning a menu which is based on classic recipes. A knowledgeable hostess who wishes to present her guests with a superb dining experience will give much thought to her menu. And when her expectations of success are fulfilled, she will use the same menu again for many another occasion. The basic entree—around which she can vary complementary courses—is of the utmost importance.

Cranberry Beef Wellington is such a magnificent entree. A recipe with grand tradition, it has been sensitively revised

and changed here to make its preparation easier and quicker, without losing its rare quality.

A subtle mix of sauteed onions, liver pate (or liverwurst) and cranberry-orange relish is layered over the beef, which is then encased in a blanket of pie crust. The pate-berry mixture can be made ahead of time and the use of a prepared pie crust mix is also a great time saver. A last touch is to create your own designs from the pastry dough to decoratively enhance the top of the beef. Use your imagination and, either by hand or with decorative cutouts, make a design of flowers, leaves and stems.

It is quite traditional to serve Beef Wellington either warm from the oven or at room temperature. For a buffet or even lunch the next day, it would be a rare treat.

For an enchanting dessert, pretty and light Cold Cranberry Souffle is a perfect choice for this dinner. It has a fluffy texture and uniquely piquant flavor combining concentrated lemonade, whole berry cranberry sauce, egg whites and spiced apples. To tastefully anoint each souffle serving, Cranberry Wine Sauce tangily mixes whole berry

cranberry sauce, port wine and grated orange and lemon. Both the dessert and sauce can be made well in advance of the event.

To your menu, you might add a platter centered with cauliflower surrounded by tiny carrots and peas, as well as a salad of crisp greens tossed with a light dressing. And don't forget a wine; either a full-bodied red, sparkling burgundy

Gapen Realty & Insurance

Knowledge & ability to unite buyers and sellers for existing marshes or undeveloped land.

2141 8th Street South
Wisconsin Rapids,
Wisconsin 54494
(715) 423-6550



Multiple Listing Service
MLS



K Ag Laboratories International, Inc.

**2323 Jackson Street
Oshkosh, WI 54901**

**Serving Cranberry
Growers in U.S.A.
& Canada since 1984**

**Over 20 years
of Experience on
Acid Soil Interaction**

K Ag Laboratory has run over 30,000 cranberry soil and over 17,500 cranberry vines tests since 1984, and gave fertilizer recommendations with great success.

- ★ *Cranberry Soil Analysis*
- ★ *Cranberry Vine Analysis*
- ★ *Cranberry Water Analysis, Usage & Interpretation*
- ★ *Liquid & Dry Fertilizer Recommendation*
- ★ *Soil Problems & Consultation*
- ★ *Seminars*
- ★ *Cranberry Crop Monitoring Program, testing and monitoring nutrient status with 30 day intervals during during the growing season.*

Highly computerized cranberry soil, tissue and water testing program in U.S.A. and Canada.

For more information contact: **Dr. Akhtar Khwaja, Ph.D.**
Certified Professional Soil Scientist
Certified Professional Agronomist

Phone Number 414-426-2220; Out of WI 1-800-356-6045; FAX 414-426-2222

ed.
ert
nce
at-
led
s a
ght
ber
ady



ELEGANTLY CLASSIC is this feast of Cranberry Beef Wellington and Cold Cranberry Souffle to be topped with Cranberry Wine Sauce. A charming table centerpiece is composed of floating fresh (or frozen-fresh) cranberries, flowers and leaves.

or champagne would be correct.

For your table centerpiece, consider this charming idea: In a bowl, filled with water, float fresh or frozen-fresh cranberries and a few flowers of the season, then surround the sides with green leaves (lemon, galax or some from your very own tree). This simple arrangement will be as exciting as any conceived by a professional florist.

Now to the recipes for your classic feast.

Cranberry Beef Wellington

(Serves 8)

- 1 fillet of beef, 3 to 4 pounds,
all fat removed
- 1 clove garlic, crushed
- Salt and pepper
- 2 tablespoons butter or margarine
- 1 onion, minced
- ½ cup cranberry-orange relish
- 1 can (4 ounces) liver pate or
liverwurst spread
- 2 packages (11 ounces each) pie
crust mix
- 1 egg, well beaten

Spread fillet of beef with garlic and sprinkle with salt and pepper. Fold thin end under to make fillet roast more evenly. Place in a shallow roasting pan. Roast in preheated hot oven (400°F) for 20 minutes. Remove from oven and cool thoroughly. In a skillet, heat butter and saute onion and cranberry-orange relish for 5 minutes, stirring constantly. Stir in pate until well blended. Remove from heat and chill. Prepare pie crust mix according to package directions. Roll out ¾ of the pie crust on a floured surface into an oblong large enough to enclose the entire fillet. Spread the center of the pie crust evenly with the pate mixture. Place the fillet, top side down, onto the pate mixture. Fold crust over fillet, brushing edges of crust with water to seal. Turn in ends and seal. Place fillet, seam side down, onto a large, greased cookie sheet. Roll out remaining pie crust and cut into flowers, leaves and stems. Brush fillet with beaten egg. Arrange decorations on top of fillet. Brush decorations with beaten egg. Bake in a preheated hot oven (400°F) for 20 to 25 minutes or until crust is richly browned. Cut into thick slices and serve at once.

Cold Cranberry Souffle

(Serves 8)

- 3 envelopes unflavored gelatin
- 1 can (8 ounces) frozen, concentrated
lemonade, thawed and undiluted
- 1 cup water
- 2 cans (1 pound each) whole berry

- cranberry sauce
- 1 jar (14 ounces) apiced apple rings
- 4 egg whites, at room temperature,
stiffly beaten

In a large saucepan, mix gelatin, lemonade and water. Stir over low heat until gelatin is dissolved. Stir in cranberry sauce and juice drained from apple rings. Chop apple rings and stir into cranberry mixture. Chill until slightly thickened. Gently and completely fold in egg whites. Make a foil collar 3 inches high, fasten securely with tape or string around the outer edge of a quart souffle dish. Slowly pour in cranberry mixture. Chill until firm. Remove foil and serve with Cranberry Wine Sauce.

Cranberry Wine Sauce

(Serves 8)

- 1 can (1 pound) whole berry cranberry
sauce
- 2 cups port wine
- 2 tablespoons cornstarch
- ¼ cup water
- 1 teaspoon each grated orange and
lemon rind

In a large saucepan, combine sauce and port wine. Bring mixture to a boil. Reduce heat to low. Mix cornstarch with water until smooth and stir into simmering sauce. Stir over low

heat constantly until sauce bubbles and thickens. Stir in rinds. Cool and then chill until ready to serve. Makes about 2 cups sauce.

KUBOTA NAMES HILL

Robert J. Hill recently was named director of marketing for the Kubota Tractor Corporation of Compton, Calif.

Bogs For Lease

TAUNTON

4 BOGS — 22 Acres

- DORMANT BOGS
- CHAPTER 61A
- READY TO REBUILD
- COMPLETE PLANS
- LONG TERM LEASE

Stephen Horbach
25 Mariner Ct.
Brewster, MA 02631

Vines For Sale

Early Blacks _____	\$2,500 a ton
Stevens _____	\$4,000 a ton
Howes _____	\$2,500 a ton
Crowley _____	\$3,500 a ton

Prices F.O.B.

R.M. Lawton Cranberries, Inc.
221 Thomas St.
Middleboro, MA 02346

(508) 947-7465

**BAKER TRACTOR HOLDS
GALA GRAND OPENING**

The Baker Tractor Corporation held grand opening celebrations on March 17 and 18 in connection with its move to its new showroom and headquarters on GAR Highway (Route 6) in Swansea, Mass.

More than 3,000 invitations were mailed out for the event, which took place at the Seekonk Ramada Inn.

**CRANLAND
SERVICES**

*Cranberry Property
Appraisals*

★ ★ ★ ★ ★

Listings and Sales of
Cranberry Properties.

License # 68987

Lawrence W. Pink
Old Cordwood Path
Duxbury, MA 02332
(617) 934-6076



**BLUE HERON
FARMS**

GROWER SERVICE

MOWING (all types) * DITCHING
WATER HARVESTING * SANDING

“Specializing in the Needs of Small Growers”

Call Wayne or Karen Barnes

1-617-585-9830



Spring 1989



Vines For Sale

Ben Lear

\$ 3,500.00 per ton

Crowley

\$ 3,500.00 per ton

Stevens

\$ 3,500.00 per ton

Pilgrims

\$ 4,000.00 per ton

Prices F.O.B.

Contact:

LeRoy Miles
Northland Cranberries, Inc.
(715) 424-4444
251 Oak Street
Wisconsin Rapids, WI 54494

Buy 10 tons, get one ton free.

20% down payment with order.

Call for large order pricing.



VOLM BAG COMPANY, INC.

1804 EDISON ST. BOX B, ANTIGO, WIS. 54409-0116
PHONE 715/627-4826

SUPPLYING AGRICULTURAL CHEMICALS

BRAVO - SEVIN - FUNGINEX - ORTHENE
CASORON - GUTHION - DEVRINOL - PARATHION

AND

**DELIVERING A COMPLETE LINE OF FERTILIZER
WITH FAST FRIENDLY SERVICE!!!**

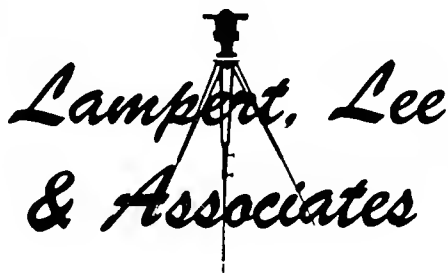

**CONSULTING ENGINEERS
SURVEYORS**

Extensive experience in all aspects of cranberry land development: evaluation, purchase, survey, design, permit acquisition, phased construction and planting both in wetlands and uplands.

Have references. Will travel.

Contact: Will Lee
10948 Highway 54 East
Wisconsin Rapids, WI 54494
(715) 424-3131

Financial Strength. . .

Personalized Service.

Isn't That What You Need In A Bank?

The Jackson County Bank has supported agriculture in the area for more than 110 years.

We recognize the importance of the cranberry industry and are pleased to provide financial services for all your banking needs.

We're large enough to serve you and yet we offer personalized service which your business demands. Call us at 715-284-5341

The Jackson County Bank. A name to count on throughout the years.

You'll like the difference.



**JACKSON
COUNTY
BANK** Member FDIC
(715) 284-5341

Black River Falls, Alma Center, Hixton, Merrilan, Taylor, WI 54615

YANKEE PLANNERS, INC.

*59 North Main Street
Middleboro, MA 02346
(508) 947-0527*

**Sound and Objective
Advice
Suited to
Your Needs**

- *Tax and Estate Planning*
- *Investment & Insurance Review*
- *Business Continuity*
- *Asset Protection*
- *Key Employee Retention*
- *Business Tax Analysis*

Mr. William H. Bestgen, Jr.
Chartered Financial Consultant

Mr. Peter W. Hutchings
Attorney at Law practicing as
a Tax Attorney

Mr. Roger H. Parent, Jr.
Accountant, Enrolled to Practice
before the Internal Revenue
Service

**Call For Your Free Brochure
(508) 947-0527**

HOECHST CONSOLIDATES

Hoechst Celanese Corporation and Hoechst Canada Inc. recently announced consolidation of their crop protection and animal health products.

VINES FOR SALE

**Howes and
Early Blacks**

CALL

(508) 428-6101

Or

(508) 428-0907

After 6 p.m.

No matter how small your business, you can afford to place an ad in the magazine that serves the industry: CRANBERRIES!

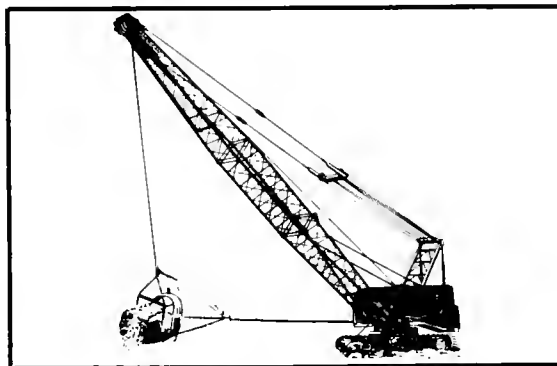

Krause Excavating, Inc.

Canal Work

Ditching

Pond Construction

Land Clearing

1-1/4—3 yd. draglines with 80' boom and matts, 2 yd. backhoe, swamp dozer and other related equipment.

Contact:

Roger Krause 1-414-398-3322
Route 3 Markesan, Wis. 53946

MTC

MIDDLEBOROUGH TRUST COMPANY

The *Business Bank.*

MTC offers you business banking built to your needs.

Personal attention to your special

financial requirements now and as you grow. Cooperation.

Flexibility. Complete business and personal banking.

Member FDIC



Main Office

10 John Glass, Jr. Square, Middleborough

Branch Offices

Middleboro Square, Rt. 28, Middleborough • Middleboro Plaza, Middleborough
Cranberry Plaza, East Wareham • Carver Square, Carver • Trucchi's Plaza, Taunton
Telephone all offices **947-1313**

They Help to Spell Success

Effective Business Letters

By JOSEPH ARKIN

Business letters play so important a role in projecting your firm's image.

Consultants in the field of business letter writing claim that clichés are the culprits responsible for so many of today's poorly written letters. There can be no better illustration than the secretary of a funeral parlor who closed letters to the families of the bereaved with, "We hope to serve you again in the future—and often." In other words, "Many happy funerals to you!"

The trouble here was that a new and eager office worker resorted to standard terminology so often used in business letter writing. But doing so can be pretty silly at times, even downright insulting.

ONE of the greatest dangers of old-fashioned, hackneyed phrases is that we use them carelessly, without thinking. Unfortunately, not one person in ten who writes business letters—including college graduates—has had adequate training in the technique and psychology of writing them. It's more than a matter of ability to express ideas. The clearest, most lucid letter ever written may leave a reader indifferent, sometimes furious.

Most business correspondents simply mimic the style of the person who preceded them. And their predecessors mimicked those before them.

Is it any wonder that so many business letters sound like something dug out of an attic trunk? Some are so stuffy, formal and frigid that they might have been written by a robot.

A positive step in producing more efficient business letters is to go through your correspondence files and review carbon copies (or xeroopies, as is more often the case today) of letters recently mailed. Imperfections and downright silly expressions will stand out. You'll see ways to improve your future letters and avoid glaring mistakes.

Here are some tips on how to make

your business letters more effective:

Make Your Letters Simple

- Give extra care to wording the opening sentence. Your subject should start on the right track; use it as your guide.
- Pretend you're facing the recipient and don't use any long words or fancy phrases you wouldn't employ in face-to-face conversation. Can you imagine your saying to him

or her, "I wish to call your attention . . ." or "Please be advised that . . . ?" If you wouldn't talk that way, don't write that way. Avoid the stereotyped phrases. Listed below are some of the more common ones. In brackets are some of the thoughts they might evoke in the recipient.

Hereafter and henceforth . . . (How repetitious can you get?)

WISCONSIN CRANBERRY HEADQUARTERS FOR SEVIN XLR



DEVRIKOL 10G * EVITAL * GUTHION
DIAZINON 14G * PARATHION * ETHREL

Cole/Grower Service

537 Atlas Ave., P.O. Box 7211, Madison, WI 53707
(608) 221-6204 or 1-800-362-8049

J.A. JENKINS & SON CO. *Grower Service*

**MOWING (ALL TYPES)
SANDING**

**DITCHING
WEED WIPING**

Serving Cape Cod

227 Pine St., W. Barnstable, Ma. 02668

Phone 362-6018



Kindly command me... (Are you kidding?)

In due course of time... (After the usual buck passing.)

I wish to state... (Why wish? Just say it!)

Permit me to say... (Go away you stuffed shirt.)

As you know... (If not, I'm stupid, eh?)

We note your request for... (Condescending of you.)

Due to the fact that... (You mean because?)

• Know your subject so well that you can discuss it naturally and confidently throughout your letter.

• Use short sentences. short paragraphs. Be compact. And don't separate closely related parts of sentence.

• Tie your thoughts together so your reader can follow you from one to another without

getting lost. This is especially important when you are explaining a recent price increase.

Make Your Letters Short

• Don't repeat phrases from the letter you

are answering. The sender knows what was said.

• Avoid needless words and information. Don't volunteer information not relative to the subject at hand.

Wanted

Wisconsin Cranberry Grower wishes to purchase an existing cranberry marsh.

STEVE

(715) 421-0917
(715) 593-2385

Vines For Sale

Ben Lear	\$5,000 a ton
Stevens	\$4,000 a ton
Crowley	\$4,000 a ton
Bergman	\$4,000 a ton

Prices are F.O.B.

\$500 a ton less with 50% payment before cutting

Richberry Farms Ltd.

11280 Mellis Drive
Richmond, B.C.
V6X 1L7 Canada

Res. (604) 273-4505
Bus. (604) 273-0777

22 years experience   construction lifts  



AERIAL LIFTING

◦ **BERRY LIFTING** ◦
nylon berry bags
bulk bins

◦ **MUD LIFTING** ◦
NEW MATS

lightweight
durable

contact
PETER or CHUCK
508-295-2222

 **BEATON'S**
CRANBERRY
GROWERS SERVICE
 **WARHAM MASS.**



mat rentals & sales

Take Good Care of Yourself Have an Ocean Spray!



The farmer's cooperative that brings you
a wide range of natural fruit juices, drinks and sauces
Ocean Spray Cranberries, Inc., Plymouth, Massachusetts 02360
An Equal Opportunity Employer

B
83
7
er



UNIVERSITY OF MASSACHUSETTS
LIBRARY

Washington Director Retires

U. Research Unit Expands

Calcium and S

UNIV OF MASS LIBRARY
SERIALS DEPT
AMHERST MA
01003



DRESSER + BARK RIVER

*Quality products and
trained, dedicated people
standing behind them.*

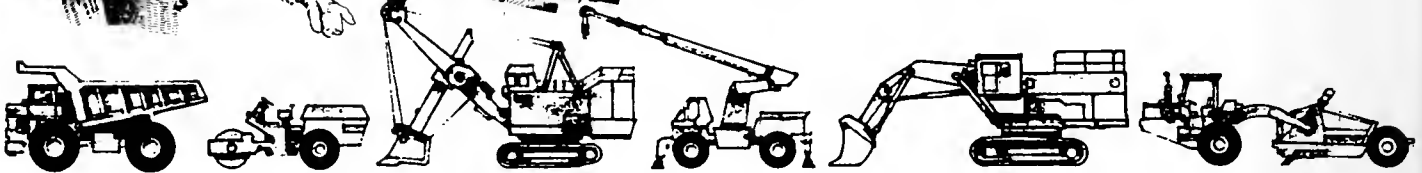

It's a combination that adds up to top production for you!

Then add BARK RIVER's full line of other quality tools and equipment and you have a complete source for all your equipment needs, all backed with dependable product support.



Crawler Loaders
Crawler Tractors

Draglines
Drills
Graders

Hydraulic Excavators
Hydraulic Shovels
Planers

Rollers
Scrapers
Shovels

Trucks (off-highway)
Wheel Loaders

• FRINK SNOW-PLOWS

• FMC WAYNE STREET
SWEEPERS

• CLARK-BOBCAT SKID
STEER LOADERS

• WISCONSIN TRAILERS

• VAC-ALL BY LEACH

• GAFNER IRON MULE

• TIGER HIGHWAY MOWERS

• HITACHI EXCAVATORS
AND CRANES

• PAPER, CALMENSON
BLADES AND CUTTING
EDGES

• FOX SPREADERS

• WALDON LOADERS

• GRADALL INC.
EXCAVATORS

• MURPHY DIESEL ENGINES

• KOLMAN CONVEYORS

• MORBARK EGER
BEEVER CHIPPERS

• FAIR SNOWBLOWERS

• AMZ ASPHALT PATCHING
EQUIPMENT

• SICARD SNOWBLAST
SNOWBLOWERS

Manufacturers of corrugated steel & aluminum culvert pipe and drainage products.



BARK RIVER Culvert & Equipment Co.

Backing you with 82 years of experience.

EAU CLAIRE
1700 Western Avenue
Phone (715) 835-5157

MADISON
Highway 51 & Buckeye Rd.
Phone (608) 222-4151

ESCANABA
430 N. Lincoln Street
Phone (906) 786-6920

GREEN BAY
600 Liberty Street
Phone (414) 435-6676

SUPERIOR
1213 Winter Street
Phone (715) 392-2243

MILWAUKEE
11715 W. Silver Spring Rd.
Phone (414) 461-5440

Horticulturist Shawa Becomes Grower Shawa

Like Voltaire's *Candide*, Azmi Y. Shawa has traveled many roads, tasted many climes, and now would like to settle down and tend his garden, or, more precisely, his bog.

Director of the Coastal Washington Research & Extension Unit in Long Beach for 24 years, the likeable Shawa retired from the post recently.

During his involvement with horticulture over some four decades, Shawa traveled between continents and across the country many times. Further travel, the goal of many retirees, will be put on the back burner for awhile. He and Mrs. Shawa are looking forward to some relaxation around their Long Beach home and Mr. Shawa is eager to cultivate the 5½ acre bog he bought 2 years ago.

And, besides, he wants to be available for consulting work and he'd like to keep his fingers in research.

Shawa first came to Long Beach as a senior horticultural assistant in 1960. Five years later he was chosen to head the station.

A native of Palestine, Shawa grew up in Gaza, where his parents owned orange groves. His interest in agriculture developed early.

COVER PHOTO

AZMI Y. SHAWA has retired as the director of the Coastal Washington Research Extension Unit but he hasn't retired from canberrying, what with his own 5½ acre bog, research, consulting and a friendly chat now and then with fellow growers.

(CRANBERRIES photo by Carol Schurter)



SHOW SHAWA a bog and he can't resist inspecting the vines.
(CRANBERRIES photo by Carol Schurter)

He attended agricultural school in Gaza, first studying irrigation, then switching to horticulture.

Utah State University was his next stop. He came there in 1949 and received a bachelor's degree in horticulture two years later. He specialized in pomology.

Next he studied at Colorado State University, where he received his master's in horticulture in 1953. Then it was on to Washington State University for his Ph.D. He interrupted his studies to accept a post as senior experimental aide at the Prosser, Wash., research and extension center. Family responsibilities were a factor in his decision.

Two years later, the Libyan government invited him to do horticultural research in that country. While there he introduced new varieties of fruit trees.

In 1960 he returned to Long Beach and has been there since. And he doesn't intend to leave.

"I love the country and the quality of life here," he said.

The highlight of his career, he believes, was his introduction of lots of new herbicides.

"When I took over, the only two herbicides were Casoron and a little 214," he noted. "Now there's an arm's long list of herbicides that can be used safely."

Shawa also is proud of the research he has done to improve the color and the keeping quality of cranberries.

The highly respected researcher said he hopes his successor—who is expected to be named in the next few months—will concentrate on fertility and crop hardiness.

About the latter, he said: "We've got to find the ways and means of protecting cranberries from injury, especially winter kill. We don't know the factors yet, nutritional and otherwise. This is a science in itself. Someone has got to tackle it."

The horticultural expert calls "unfortunate" the growing anxiety over pesticide residues.

"If pesticides are used rationally, carefully, after thorough scientific studies, I don't see the danger to human life," he said. "All that's being achieved now is a kind of nagging of agriculture. Critics talk about organic gardening and think we can survive without pesticides. Organic gardening is fine but how do you get the production?"

Shawa owned that some growers use pesticides unwisely but said that's an education and policing problem, not a basis for eradicating pesticides.

The retired director carried on a tradition of longevity at Long Beach, the only research facility besides the Massachusetts Cranberry Experiment Station devoted exclusively to cranberries. There have been only three directors at Long Beach.

D.J. Crowley, the first director, who served from 1923 through 1954, virtually revolutionized cranberrying with his development of the overhead sprinkler system. Charles Doughty headed the station from 1954 through 1965. And then came Shawa.

Among his other accomplishments, Shawa was the principal author of the booklet, "Cranberry Production in the Pacific Northwest."

Growers, as well as others in the cranberry field, also appreciated Shawa's authorship of the concise, informative monthly newsletter, *Cranberry Vine*. The newsletter will be put on hold until a new director

is chosen.

For Shawa now, much of his day will be spent tending his McFarlins and a few Stevens. And there will be time to indulge his three grandchildren—another is on the way. Mr. and Mrs. Shawa have one son and two daughters.

Will Shawa be missed?

Well, a retirement reception was held at the Long Beach station and

150 people showed up.

Or take the words of David Thissell of Seaview, chairman of the local cranberry growers advisory board.

Thissell told the *Chinook Observer's* Mark Kester, "He has been a help to the old and new grower alike. He will be a hard man to replace."

TAUNTON 4 Prime Bogs

- 22 Acres
- Good Water & Soil
- Dormant - Ready to Rebuild
- Chapter 61 A - Plans

LEASE OR SALE
(508) 896-6262

Pump Repairs & Sales

All Types

- Field Service
- Chemigation Equipment Sold
- Demonstration by Appointment

AAA Industrial Pump Service Inc.

Bruce Sunnerberg
66 Lake Street
Plympton, MA 02367
(617) 585-2394

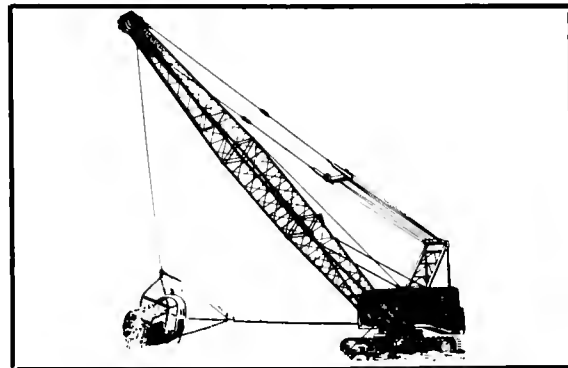

Krause Excavating, Inc.

Canal Work

Pond Construction

Ditching

Land Clearing

1-1/4—3 yd. draglines with 80' boom and mats, 2 yd. backhoe, swamp dozer and other related equipment.

Contact:

Roger Krause 1-414-398-3322
Route 3 Markesan, Wis. 53946

NFPA Predicts Juice Content Controversy Will Soon Be Resolved

The National Food Processors Association (NFPA) is optimistic that juice labeling requirements that satisfy all segments of the industry will become a reality.

Ellen R. Morton, NFPA manager, media relations, said the NFPA special task force assigned to the study of juice labeling has taken a two pronged approach. One is to ask the Food & Drug Administration to require juice content labeling of all juice and dilute juice products. The second is to seek development of legislation to require full nutrition labeling on both types of products.

The proposals represent a compromise among those processors who want juice content labeling and other processors, such as Ocean Spray Cranberries, who produce high acid drinks and who argue that juice content labeling alone, without considering nutritional value, is unfair.

NFPA says the task force agreement

represents "an unprecedented consensus among members of NFPA that pack fruit and vegetable juices, dilute juice beverages and high acid juice products." NFPA represents over 600 food processing companies and suppliers to the industry.

Companies represented on the task force, besides Ocean Spray, include National Fruit Product Co., Tree Top, Clement Pappas & Co., Dole Packaged Foods, Campbell Soup, General Foods, Del Monte USA and George A. Hormel & Co.

For Sale by Owner

West Wareham, Massachusetts Cranberry Bogs and Uplands

This property consists of approximately 6 acres of working bogs and reservoirs and approximately 16 acres of uplands. Cranberry area may be easily expanded. Opportunities negotiable on remaining 11 acres and a seven room Cape home. This serene country setting offers considerable growth potential.

Call (508) 748-0637

CRANBERRIES

THE NATIONAL CRANBERRY MAGAZINE

SEND CORRESPONDENCE TO:

**P.O. BOX 249
COBALT CT 06414
(203) 342-4730**

Fax #: (203) 342-1977

PUBLISHER & EDITOR: BOB TAYLOR

ASSOCIATE EDITOR: CAROLYN GILMORE
(508) 783-5206

ADVISORS & CORRESPONDENTS

MASSACHUSETTS — Irving E. Demoranville, Director, Cranberry Experiment Station.

NEW JERSEY — Phillip E. Marucci, Cranberry & Blueberry Specialist, Buddtown; Elizabeth G. Carpenter, Chetsworth.

NOVA SCOTIA — Robert A. Murray, Horticulturist, Berry Crops, Research Station, Truro.

OREGON — Arthur Poole, Coos County Extension Agent, Quillite.

WASHINGTON — Azmi Y. Shawa, Horticulturist and Field Director, Coastal Washington Research & Extension Unit, Long Beach.

WISCONSIN — Tod. D. Piener, Farm Management Agent, Wood County.

CRANBERRIES is published monthly by Diversified Periodicals, Wellwyn Drive, Portland CT 06480. Second class postage is paid at the Portland, Conn. Post Office. Price is \$15 a year, \$28 for two years, \$2 a copy in the U.S.; \$17 a year in Canada; \$20 a year in all other countries. Back copies: \$2.50, including postage. Copyright 1988 by Diversified Periodicals.

ISSN: 0011-0787

Postmaster, send Form 3748 to:

CRANBERRIES
P.O. BOX 249
COBALT CT 06414

We Still Make House Calls

Like your old family doctor, your Farm Credit representative still makes house calls . . . and he's been treating farm families like yours for a good 70 years.

Farm families count on him to provide the financial support they need—short-term and long-term credit—that helps them plan for a productive future.

But there's more to Farm Credit than money. What makes your Farm Credit representative unique is that he knows your business so well. Which means that he's more than a dependable source of credit. He can provide farm business consulting, tax services, credit life insurance, appraisal service and computerized record-keeping.

Give him a call. He could be just what the doctor ordered for you.



Southern New England Farm Credit Service

Federal Land Bank Association
Production Credit Association

P.O. Box 7
Taunton, MA 02780
508 / 824-7578



N.J. Station Becomes National Base For Cranberry, Blueberry Research

By **ELIZABETH CARPENTER**

National research in cranberries and blueberries will be transferred from a Beltsville, Md., USDA facility to the blueberry/cranberry research center in Washington Township, N.J.

The move was explained by Dr. Roger Wyse, senior associate director of the New Jersey Agricultural Experiment Station, at the recent 1989 winter meeting of the American Cranberry Growers Association (ACGA).

At Washington Township, a joint federal, state and local effort will address cranberry and blueberry breeding, cultural, local disease and insect problems and viral diseases.

The search for biological controls

that can effectively replace chemical pesticides and fungicides will top the list of priority concerns, while continued efforts will be devoted to problems related to weed control, phytophthora root rot, bee pollination, water management, crop nutrition, pruning techniques and upland bog development, Wyse said.

Despite the threat of the season's first major snowstorm, approximately 80 people attended the ACGA meeting. President Joe Darlington presided over a fact-filled session—one that proved New Jersey's cranberry industry is alive, well and expanding. The state's growers produced a record high 370,000 barrels in 1988, with a record high

average yield of 112 barrels per acre.

HOW did a tropical fungus like phytophthora root rot get to Massachusetts? Dr. Frank Caruso, extension plant pathologist with the Massachusetts Cranberry Experiment Station, suspects it came with the introduction of moisture loving rhododendrons and high bush blueberries to this northern climate.

Caruso's research has identified phytophthora as the fungus causing root rot, a disease that appears to be enhanced by winter flood and extremely wet conditions.

Measures that are taken to decrease and eliminate this insidious fungus in Massachusetts bogs will control problems in New Jersey and Wisconsin bogs that suffer from a related species of the fungus, according to Caruso.



**MIDDLEBOROUGH
TRUST COMPANY**

The Business Bank.

MTC offers you business banking built to your needs.

Personal attention to your special financial requirements now and as you grow. Cooperation.

Flexibility. Complete business and personal banking.

Member FDIC



Main Office

10 John Glass, Jr. Square, Middleborough

Branch Offices

Middleboro Square, Rt. 28, Middleborough • Middleboro Plaza, Middleborough
Cranberry Plaza, East Wareham • Carver Square, Carver • Trucchi's Plaza, Taunton
Telephone all offices **947-1313**

These include:

- improving cranberry bog drainage by cleaning existing ditches and digging new ones;
- sanding affected areas;
- applying Ridomil via a sprinkler system or spot treatment at an opportune time in the plant's life cycle (spring and fall recommended). An application should cover an area at least 20 feet beyond the diseased vines and be continued for two or three seasons;
- using Ferbam or Zineb—both show promise;
- selecting disease resistant cranberry varieties when replanting (Howes, Franklin and Stevens are three varieties that seem able to withstand the disease);
- sterilizing footwear after treating an "infected" bog in order to prevent disease transmission to healthy bogs.

Looking ahead, Caruso suggests the gene pool of susceptible varieties may be improved by breeding them with native cranberries that are resistant to phytophthora.

How can you tell if phytophthora has infected your bogs? Early symptoms include:

- small areas of dead vines;
- reddening of cranberry foliage in midsummer;
- foliage of affected plants turns red

in early fall;

- takeover by narrow-leaved golden-rod in affected areas;
- underground runners turn dull olive in color;
- lesion areas become apparent.

RAY SAMULIS, Burlington County agricultural agent, updated growers on his 1988 fungicide and rot control studies. Two objectives of his work were to (1) obtain Benlate tolerance data and (2) compile rot control data. Fungicides tested for their ability to control cranberry rot included Bravo, Benlate #4, Foilicur, Benlate #2 and Ferbam. Criteria studied in measuring each product's impact on a crop included

weight per berry, overall weight of berries per plot and total number of berries per plot.

Samulis also cautioned growers that employee training and responsible application procedures are extremely important, given that possible pesticide and fungicide misuse are very much in the forefront of public thinking. To help prevent product abuse and insure farm worker safety, he recapped OSHA and the Superfund Amendments and Reauthorization Act (SARA) regulations.

He pointed out an excellent employee training kit, "Hazard Communication Compliance Kit," that contains perti-

SKIPPAR

POLE  SERVICE

• Private Poles • Line Construction

• Sonotube Drilling • New & Used Poles

(508) 690-2238

208 Franklin St., East Bridgewater, MA 02333

22 years experience  *construction lifts* 



AERIAL LIFTING

◦ **BERRY LIFTING** ◦

nylon berry bags

bulk bins

◦ **MUD LIFTING** ◦

NEW MATS

lightweight

durable

BEATON'S

CRANBERRY

GROWERS SERVICE

WARHAM MASS.

JOE

BRIGHAM

INC

contact

PETER or CHUCK

508-295-2222

mat rentals & sales

YANKEE PLANNERS, INC.

59 North Main Street
Middleboro, MA 02346
(508) 947-0527

Sound and Objective
Advice
Suited to
Your Needs

- Tax and Estate Planning
- Investment & Insurance Review
- Business Continuity
- Asset Protection
- Key Employee Retention
- Business Tax Analysis

Mr. William H. Bestgen, Jr.
Chartered Financial Consultant

Mr. Peter W. Hutchings
Attorney at Law practicing as
a Tax Attorney

Mr. Roger H. Parent, Jr.
Accountant, Enrolled to Practice
before the Internal Revenue
Service

Call For Your Free Brochure
(508) 947-0527

ment slides, charts and forms and may be purchased for \$12 from:

Superintendent of Documents
U.S. Government Printing Office
Washington, D.C. 20402-9325

Phone: (202) 783-3238

Ask for "Hazard Communication Compliance Kit"—OSHA 3104 and GPO order number 929-022-00000-9

Additional copies of SARA fact sheets, including Section 311 - Manufacturer Safety Data Sheets, may be obtained by making contact with Ray Samulis at his Mount Holly, N.J., office, (609) 265-5050.

DR. ERWIN "Duke" Elsner, specialist in entomology at the Rutgers blueberry/cranberry research center, looks forward to the day when he will be able to provide growers with weekly updates that explain when and how to counteract infestations of insect pests. Last year's fledgling integrated pest management (IPM) program was an important first step in refining techniques that will ultimately provide growers with this information.

Elsner reports that 1989 efforts will benefit from the use of commercial bogs where his team can conduct "side by side" comparisons. This format is necessary if meaningful data is to be compiled, he said.

Upcoming IPM research will focus on multiple sampling methods, temperature data collection, standard IPM comparisons and economic injury level research, i.e., "how many dollars' worth of impact will different insects make at different times of the year?"

Ultimately, the success of IPM will

be gauged by the number of barrels of healthy cranberries harvested per bog, Elsner said.

DR. ALLAN Stretch, USDA plant pathologist at the Rutgers blueberry/cranberry research center, updated growers on his efforts to identify an antagonistic organism that could serve as a biological control for black rot in water harvested cranberries.

During the past year, Stretch has sampled thousands of berries from locations in New Jersey and Massachusetts. Three different fungi have been identified as the cause of black rot. Spores from these fungi, if released during harvest, enter the wounds of water harvested fruit and cause rot.

Although not a panacea, Strasseria has been identified as an antagonistic organism that shows promise as a biological control for this problem. If the rot producing fungi can be reduced prior to harvest, then the incidence of black rot found in stored fruit will decline.

DR. NICHOLI Vorsa, associate director of the Rutgers blueberry/cranberry research center, introduced John Sarracino, the center's newly hired "hands on" plant breeder. Sarracino explained that "breeding (cranberry varieties) is a long term investment," one that requires at least five years of careful monitoring to determine if a new variety demonstrates potential for commercial use. Once a variety is made available to growers, he said, it must be able to produce for a minimum of 10 years.

Qualities he wants new varieties to possess include:

- increased resistance to field fruit rots;
- increased insect resistance;
- increased yield per berry size;
- more reliable yield;
- increased anthocyanin content;

J.A. JENKINS & SON CO.

Grower Service

MOWING (ALL TYPES)
SANDING

DITCHING
WEED WIPING

Serving Cape Cod

227 Pine St., W. Barnstable, Ma. 02668

Phone 362-6018



earlier and more uniform ripening.

Since mid-1988, Sarracino has monitored the pollination of 81 cranberry variety crosses to determine which are most successful. Self pollination as well as cross pollination has occurred in these samples. Seeds found in berries resulting from these crosses vary in number, depending on variety. In 1990, these test varieties will be transplanted from a greenhouse to a bog setting, where the roguing process of least promising varieties will begin.

Sarracino's future plans include housing an extensive germplasm collection at one location to allow comparisons under similar conditions; giving researchers access to genetically identical material, and providing breeders with a positive system of identifying their material. Data garnered from his germplasm collection will be entered and stored in research center computers. This systematic monitoring should lead to the identification of varieties that are genetically resistant to diseases, including phytophthora.

JACK MATTHENIUS, apiarist with the N.J. Department of Agriculture, asked for better communication between beekeepers and growers while investigation continues into the possible cause(s) of the loss of several hundred colonies of bees in 1988.

He observed cranberry bogs and blueberry fields are often adjacent to one another, making it necessary for colonies to be kept in an area for great lengths of time. To date, Matthenius said, there is no conclusive data to indicate that pesticides used on these crops are the culprits. However, traces of pesticides have been found in pollen.

While the level of pesticide ingestion these insects can safely tolerate is being determined, Matthenius suggests remedial measures that may be taken to help avoid future losses include:

- whenever possible, remove hives before bogs are sprayed;
- allow adequate ventilation within hives—don't stack colonies.

Matthenius also recommended that Rutgers University's vacant position of bee

specialist be filled. Such a researcher is needed to address the problem of tracheal mite in bees and to develop a breeding program that will produce domesticated bees willing to gather 90% of their pollen from cranberry blossoms, he said. He emphasized that the Africanized bee can't be tolerated in New Jersey.

ONGOING evaluation of tundra swan damage in New Jersey's cranberry bogs by the N.J. Division of Fish, Game and Wildlife shows destruction is decreasing, it was revealed at the meeting. Data compiled from growers responding to division questi-

onnaires indicates crop losses decreased from 9,350 barrels worth \$503,184 in 1986 to 7,202 barrels worth \$396,137.50 in 1987.

A variety of techniques, ranging from spotlights, shellcrackers and propane cannons to scarecrows and flagging were held as responsible for the decline. However, equipment and manpower costs needed to implement deterrents have increased from \$33,547 during 1985-86 to \$42,554 during 1986-87.

Despite decline in crop damage, the tundra swan population is on the increase and their search for red root tubers found in



CEECO CORPORATION

OF NEW ENGLAND

Industrial Suppliers To The Cranberry Industry



Chain, Cable and Accessories
Used for Making Mats
All Types of Fasteners (Bulk & Packaged)

Hand Tools	Pumps
Power Tools	Motors
Chemicals	Abrasives
Lubricants	Cutting Tools
Safety Equipment	

Richards Rd.
Plymouth Industrial Park

747-0086
Plymouth, MA 02360

**The
CHARLES W. HARRIS
Company**

451 Old Somerset Avenue
North Dighton, Mass.
Phone (508) 824-5607

AMES
Antisiphon Devices
RAINBIRD
Sprinklers
HALE
Pumps

*Highest Quality Products
With Satisfaction Guaranteed*

Vines For Sale

Ben Lear	\$5,000 a ton
Stevens	\$4,000 a ton
Crowley	\$4,000 a ton
Bergman	\$4,000 a ton

Prices are F.O.B.
\$500 a ton less with 50% payment before cutting

Richberry Farms Ltd.

11280 Mellis Drive Richmond, B.C. V6X 1L7 Canada	Res. (604) 273-4505 Bus. (604) 273-0777
--	--

cranberry bogs continues. Bog damage and vine uprooting are directly related to the swans' nocturnal search for this weed.

Although growers' frustration with the problem remains high, Bill Haines Jr. spoke for the majority of ACGA members when he opposed a hunting season on the birds.

"This would be a public relations disaster," Haines said.

Maintenance of "cleaner" bogs, coupled with the previously mentioned passive techniques, remain the only legitimate means for discouraging the birds. Permits for shell crackers and propane cannons may be obtained by calling Ed Butler at the USDA animal damage control section: (201) 647-4109.

ANTHONY PAPASSO, senior special agent, U.S. Immigration and Naturalization Service (INS), explained that the Immigration Reform and Control Act of 1986 stipulates that an employer should hire only American citizens and aliens who are authorized to work in the United States.

He said that the act's Form I-9 is "great for a factory, but poor for a farm," but that a grower must comply with the law by filling out this form for each employee hired after Nov. 6, 1986 or be liable for a \$1,000 fine per person. A *Handbook for Employers* distributed by Papasso to growers clearly explains the procedure for completing this form and includes the toll free number—1-800-777-7700—that may be called if an employer wants additional information.

FRAN BROOKS, N.J. Farm Bureau, then explained an identification card system used in Florida that may be legally implemented in New Jersey. Once an employee completes an I-9 form, it is incorporated into a badge that is worn while the employee is on the job. It allows him/her to move from farm to farm without duplicating paperwork and prevents a farm employer from being repeatedly audited.

Brooks stressed that whatever system is used in New Jersey, compliance with the law is mandatory. She reminded growers that crew leaders and employers are jointly culpable if they fail to implement the law.

PRESIDENT DARLINGTON told growers that their testimonies are invited at the August 1989 Cranberry Marketing Committee hearing to be held in New Jersey. Of particular interest will be the non-transferable "rolling" base concept and the method proposed for handling allocation during times of surplus production.

Named as ACGA officers for 1989-90 were: Ernest Bowker, president; Katie Darlington, vice president and secretary; Dr. Paul Eck, treasurer; Edward V. Lipman, ACGA delegate to the N.J. Agricultural Convention, and Thomas Darlington, ACGA alternate delegate to the N.J. Agricultural Convention.

LIFT PUMPS

Trailer or Permanent
Electric, Tractor or
Engine Driven

PHIL HELMER
(715) 421-0917

VINES FOR SALE

**Howes and
Early Blacks**

CALL

(508) 428-6101

Or

(508) 428-0907

After 6 p.m.

K Ag Laboratories International, Inc.

2323 Jackson Street
Oshkosh, WI 54901

Serving Cranberry
Growers in U.S.A.
& Canada since 1984

Over 20 years
of Experience on
Acid Soil Interaction

K Ag Laboratory has
run over 30,000
cranberry soil and over
17,500 cranberry vines
tests since 1984, and
gave fertilizer
recommendations with
great success.

- ★ *Cranberry Soil Analysis*
- ★ *Cranberry Vine Analysis*
- ★ *Cranberry Water Analysis,
Usage & Interpretation*
- ★ *Liquid & Dry Fertilizer
Recommendation*
- ★ *Soil Problems & Consultation*
- ★ *Seminars*
- ★ *Cranberry Crop Monitoring
Program, testing and
monitoring nutrient status
with 30 day intervals during
during the growing season.*

*Highly computerized cranberry soil, tissue and water testing program in
U.S.A. and Canada.*

For more information contact: **Dr. Akhtar Khwaja, Ph.D.**
Certified Professional Soil Scientist
Certified Professional Agronomist

Phone Number 414-426-2220; Out of WI 1-800-356-6045; FAX 414-426-2222

Regional Notes

MASSACHUSETTS

By IRVING E. DEMORANVILLE

Dr. Robert Devlin of the Massachusetts Cranberry Experiment Station attended the annual meeting of the Weed Science Society of America Feb. 6-10 in Dallas. Bob presented a paper on his weed research and also is serving as a member of the research committee. Dr. Devlin also attended a board of directors meeting of CAST in Washington, D.C., from Feb. 21-23.

Dr. Frank Caruso of the station spoke to New Jersey growers at their annual winter meeting Feb. 22 and 23 in Medford, N.J. Dr. Caruso also attended a meeting held by the Rhone-Poulenc Co. in Baltimore on Feb. 27 and 28. The purpose of the meeting was to discuss uses of the fungicide Alette for control of root rot.

WISCONSIN

The Wisconsin Supreme Court ruled March 1 that the state Department of Natural Resources does not have regulatory control over the dams of cranberry growers. The ruling overturned an appeals court decision in behalf of the DNR. Growers Jeffrey and Barbara Tenpas of Preston had challenged the DNR, citing an 1867 law that gave growers control over their dams.

Weather

MASSACHUSETTS

February was just slightly below normal in

CRANLAND SERVICES

Cranberry Property Appraisals

★ ★ ★ ★ ★

Listings and Sales of Cranberry Properties.

License # 68987

Lawrence W. Pink
Old Cordwood Path
Duxbury, MA 02332
(617) 934-6076

temperature, averaging 0.2 degrees a day below normal. Maximum temperature was 53 degrees on the 1st and 21st and the minimum was 7 degrees on the 26th.

Precipitation totaled 3.18 inches, about 1/3 inch below normal. There were 213 days with measurable precipitation, with 1.02 inches on the 25th as the greatest storm. We are nearly 4 inches below normal for January and February and about the same amount behind 1988. For the period December through February, we are only at 48% of normal precipitation. There was a total of 13½ inches of snow for the month. Sunshine was a record low total. I.E.D.

Wanted

Wisconsin Cranberry Grower wishes to purchase an existing cranberry marsh.

STEVE

(715) 421-0917

(715) 593-2385

Lampert, Lee & Associates

CONSULTING ENGINEERS
SURVEYORS

Extensive experience in all aspects of cranberry land development: evaluation, purchase, survey, design, permit acquisition, phased construction and planting both in wetlands and uplands.

Have references. Will travel.

Contact: Will Lee
10948 Highway 54 East
Wisconsin Rapids, WI 54494
(715) 424-3131



BLUE HERON FARMS

GROWER SERVICE

MOWING (all types) * DITCHING
WATER HARVESTING * SANDING

"Specializing in the Needs of Small Growers"

Call Wayne or Karen Barnes
1-617-585-9830



Decran Ag Supplies Inc.

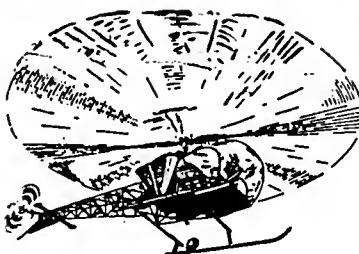

- ★ Complete line of cranberry herbicides, fertilizers, insecticides, fungicides, miticides. In stock when you want them.
- ★ Best application and safety equipment for your needs.
- ★ Quality aerial applications.
- ★ Proven frost warning equipment. Don't take chances — buy the best.
- ★ Experienced cranberry consulting service offering pheromone traps and baits.
- ★ Right to know training.
- ★ Culvert Pipe — All sizes — steel, aluminum, and poly.
- ★ Ditch Mud Mats — Strong — lightweight — durable.
- ★ Burlap Picking Bags — Best for your money.
- ★ Sanding by helicopter.

John C. Decas

William D. Chamberlain

461 Mary's Pond Rd.
Rochester, MA 02770

Office: 295-2731
Evening: 763-8956
Fax: (508) 291-1417

Serving Massachusetts Cranberry Growers

Office
295-2222

K. Beaton
295-2207

BEATON'S CRANBERRY GROWERS SERVICE



WAREHAM, MASS.

D. Beaton
888-1288

P. Beaton
947-3601

Specializing in

○ COMPLETE BOG
MANAGEMENT

○ NETTING

○ DITCHING

○ HARVESTING
(Wet & Dry)

○ SANDING

○ CUSTOM
HERBICIDE
APPLICATION

Complete line of portable Crisafulli Pumps 2" - 16"
Plastic netting for suction boxes



AKER
KETER
Manufacturer
establish-
Atlanta,
market its
ners.
unbonded
national



Fruit rot. No threat.

It's hard enough to bring in a good cranberry crop without the threat of fruit rot diseases.

That's why cranberry growers are turning to a better way to control fruit rot. Bravo 720.

Bravo delivers consistent, first-rate control of all the major fruit rot diseases that threaten cranberries. Plus leaf and twig blight (Lophodermium), too.

And that's backed by results of eight years of testing which show that Bravo 720 is more effective on fruit rot diseases than all other fungicides.

What's more, Bravo won't adversely affect fruit color. Or leave any lingering odor after application.

And remember, you can apply Bravo with conventional spray equipment or through sprinkler irrigation. The advanced flowable formulation of Bravo 720 is easy to handle, easy to mix.

So, this season, use Bravo 720 to protect your cranberry crop from fruit rot diseases. Just make your first spray at early bloom and stick to a regular 10- to 14-day schedule.

End the threat of these fruit rot diseases and bring in a bigger yield come harvest.

Bravo. Because you give it all you've got.

Fermenta Plant Protection Company,
5966 Heisley Road, P.O. Box 8000,
Mentor, OH 44061-8000.

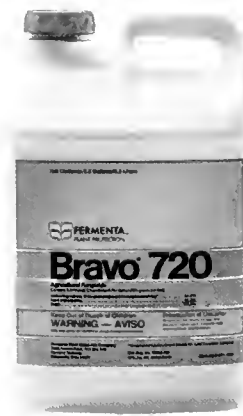

Always follow label directions carefully when using agricultural chemicals.

Bravo® 720.





- ★ *Com
miti*
- ★ *Best*
- ★ *Qua*
- ★ *Prot*
- ★ *Exp
bait*
- ★ *Rig*
- ★ *Cul*
- ★ *Dit*
- ★ *Bur*
- ★ *San*

Computer Company Updates Software

Mark Bennie, president of Cranberry Computer Inc., Wareham, Mass., announced recently that his company has developed a new version of Cranberry Growers System (CGS), a production and chemical information software package designed specifically for cranberry growers.

The new release of CGS features incentive payment calculations and expanded chemical, fertilizer and sand application management capabilities.

"Extensive use of menus and help screens make CGS easy to use, even for those with no computer experience," Bennie says.

Thirteen growers in Massachusetts, Washington and Wisconsin currently use CGS.

Cranberry Computer has subdivided CGS. For example, a grower can buy a chemical and fertilizer system or just the chemical portion, all of which can be integrated into the overall CGS.

For growers with fewer than 15 acres, Bennie has designed a smaller, less expensive version called the Limited Edition CGS.

Cranberry Computer also is introducing the Checkbook System, a fully functional accounting system which can be used alone or be integrated with CGS.

The Wareham company also offers specialized software for handlers and chemical applicator and sales businesses.

Bennie developed his software after years of consulting growers and individuals in grower related businesses.

Inquiries can be directed to Debbie Noble or Mark Bennie at Cranberry Computer.

HOLDING'S ACQUIRES DEMMA

Demma Fruit Co., Lincoln, Neb., headquartered fresh fruit and produce wholesaler, has been acquired by John Galt Holding's Ltd., Omaha. Demma was represented in the transaction by Geneva Business Ser-

vices, Irvine, Calif.

FRENCH CROP COVER MAKER SETS UP AMERICAN MARKETER

Sodoca, leading European manufacturer of row crop covers, announces establishment of American Agrifabrics, an Atlanta, Ga., based subsidiary that will market its Agryl brand of covers to U.S. farmers.

Formerly, Sodoca distributed its spunbonded polypropylene covers through International Paper Co.

Turf Equipment Inc.

381 West Grove Street (Rte. 28)
Middleboro, MA 02346

KUBOTA Diesel Equipt.

Tractors 2 & 4 wheel drive — 12-90 hp.

Compact Excavators 1 1/2 to 6 ton

Wheel Leaders 1/2 to 3/4 yd.

Water Cooled Diesel Engines 4 to 104 hp.

All Types of Implements

Polymark Beaver-Mowers **947-6299**

Specialty Fabrication Work

Kubota Financing as Low as 8 1/2%

*Sales *Service *Parts *Leasing



R. A. S. P. INC.

Carrying a Complete Line of:

- Cranberry Chemicals and Fertilizers
- Frost Alarms
- Thermometers
- Chemical Application Equipment
- Kubota K-35 Rental

Contact:

Bob or Mike
3 Plymouth St.
Carver, MA 02330

Phone:

(508) 866-4429

Authorized Agway Representative



Calcium Concentration In Cranberry Shoots

MALCOLM N. DANA and SUE STEINMANN
Department of Horticulture
University of Wisconsin/Madison

Abstract: Cranberry cuttings 'McFarlin' were grown in solution cultures in a glasshouse to produce tissues for determination of critical concentration of Ca necessary for maximum shoot growth. All shoot growth was harvested on 3 dates following growth intervals of 77 days, 40 days and 52 days. Tissue Ca concentration varied from 0.04% to 0.27% in the many samples. Shoot growth reached a maximum with approximately 0.10% tissue Ca.

The critical concentration for essential elements in plant tissue is a useful parameter in the interpretation of leaf analyses. For the cranberry, *Vaccinium macrocarpon* Ait. critical concentrations were estimated for P(3) and K(2) and

"normal" concentrations were proposed for several mineral elements (1,4,5). The "normal" concentration for Ca in cranberry shoot growth was set at the 0.30 to 0.60% range because that was the concentration found in healthy, pro-

ductive vines harvested in the field (1).

Cranberry cuttings 'McFarlin' were rooted in aerated distilled water. Upon initiation of shoot growth 8 cuttings were placed in each 2 liter plastic container with nutrient solution. Five replicates and 7 treatment solutions were provided for the experiment—a total of 35 containers and 280 cuttings. All shoot material (leaves and stems) from the 8 cuttings per container was harvested for dry weight and Ca concentration determinations.

The solutions provided concentrations of nutrients as follows: 100 ppm NH₄-N, 15 ppm P, 48 ppm Mg, 176 ppm S, .27 ppm each of B and

HONEY BEES AVAILABLE FOR

Pollination

- ★ 25,000 Strong Colonies Available
- ★ State and Federal Inspected
- ★ Cranberries, Blueberries, Etc.
- ★ 72 Hour Delivery East of the Mississippi River
- ★ Radio Dispatched Trucks

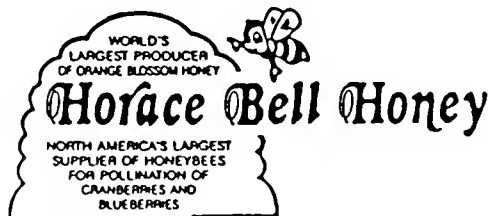

Lamar Hester
General Manager 734-3276 Evenings

1058 S. Ridgewood Ave.
DeLand, Florida 32720

Office: (904) 734-7798
736-3841
734-5043

Mn, .13 ppm Zn, .03 ppm Cu, .01 ppm Mo, 4.0 ppm Fe in equal concentrations from Fe So₄ and Fe EDTA. Treatment concentrations were set for the several treatments at 1, 2, 4, 8, 16 and 32 ppm Ca and a no Ca control. Nitrate nitrogen supply ranged from 0.7 to 22.4 ppm as the Ca concentration ranged from 2 to 32 ppm. Solutions were maintained at pH 4.5 ± 0.3. The plants depleted the solutions of nutrients for the assigned growth period. Solution strength was renewed at the start of each growth period.

Plants were maintained in the greenhouse under a 16 hour day length by supplementing natural daylight with fluorescent and incandescent lamps. In the first and second growth periods from 24 November to 11 February and 11 February to 21 March, the greenhouse temperatures fluctuated between 16C and 24C, the third period from 21 March to 12 May was maintained in the range from 17C to 38C daytime temperatures; all new shoot growth for the 8 cuttings in each container was harvested and the dry weight determined.

Tissue Ca concentration was determined by emission spectroscopy and is presented as percent of dry weight.

In the first growth period the dry weight accumulation was restricted in the treatment receiving no supplemental Ca in the solution. Shoots in these containers had 0.4% Ca which was less than the concentration in other treatments. Supplemental Ca in the solution sustained shoot growth for the period of test when the tissue concentration was at the .08% or higher level.

During the second growth period there were no differences in dry weight among treatments although the tissue concentration of Ca ranged from .05% for no Ca added to .27% with 8 mg of Ca in the solution. The plants had not depleted the Ca supply in any treatment such that the availability of this element limited vegetative growth.

Analysis of plants after the third growth period showed a restriction of dry matter accumulation in the no Ca plots with a Ca concentration of .07% and near maximum growth (4.7g) with a tissue Ca concentration of .11%.

In 2 of 3 cases growth was limited with tissue Ca concentrations of .04% and .07% and in all 3 growth periods growth reached a maximum with tissue Ca concentration at .11% or more. The critical concentration of Ca for 'McFarlin' cranberries grown in solution culture at pH 4.5 is approximately .10%.

Literature Cited

1. Dana, M.N. 1981. Foliar nutrient concentration studies. IV, Proposed standards. *Cranberries* 45(10):10-11.
2. Dana, M.N. and Sue Steinmann. 1986. Critical concentration of potassium in 'Stevens' cranberry. *Cranberries*: In press.
3. Greidanus, T. and M.N. Dana. 1972. Cranberry growth related to tissue concentration and soil test phosphorous. *J. Am. Soc. Hort. Sci.* 97:326-328.
4. Medappa, K.C. and M.N. Dana. 1970. The influence of pH, Ca, P and Fe on the growth and composition of the cranberry plant. *Soil Science* 109 (4):250-253.
5. Shawa, A.Y., C.H. Shanks Jr., P.R. Bristow, M.N. Shearer and A.P. Poole. 1984. Cranberry production in the Pacific Northwest. *Pacific Northwest Cooperative Extension Bull.* 247.

Table 1. Relationship between dry matter accumulation and tissue Ca concentration in solution culture grown 'McFarlin' cranberry shoots.

Milligrams Ca in solution	Growth Period								
	A (77 Days)			B (40 Days)			C (52 Days)		
	D. W. Grams	Tissue Ca %	Ca Recovery mg	D. W. Grams	Tissue Ca %	Ca Recovery mg	D. W. Grams	Tissue Ca %	Ca Recovery mg
0	1.8	.04	0.7	1.4	.05	0.7	2.9	.07	2.0
2	2.5	.08	2.0	1.6	.17	2.7	3.9	.07	2.7
4	2.8	.11	3.1	1.4	.24	3.4	4.2	.08	3.4
8	2.9	.16	4.6	1.5	.27	4.0	4.7	.11	5.2
16	2.6	.16	4.2	1.4	.26	3.6	4.7	.16	7.5
32	2.7	.16	4.3	1.3	.26	3.4	4.1	.20	8.2
64	2.3	.17	3.9	1.5	.23	3.5	4.9	.18	8.8
S.D.	.41	.04	-	N.S.	.03	-	.61	.05	-

editorial



Confusion Reigns

Remember when science was assumed to be exact and unequivocal? Nobody today makes that assumption. Poor Descartes must be rolling over in his grave.

Nowhere is there more confusion than in the field of agricultural chemicals. Take the recent controversy over Alar. On the same day, one could watch several TV panels or read a dozen or so newspaper and magazine accounts in which scientists were split over whether the chemical posed a threat. No wonder the poor public is confused.

Yesterday it was Alar. Today it is aldicarb, a bug killer used on potatoes and bananas. Tomorrow and the next day, other chemicals will be under attack, responsible or otherwise.

Part of the problem is lack of data and a monitoring system that many critics say is not up to the challenge of providing sure, prompt information about old and new chemicals.

Says Environmental Protection Agency official Rick Tinsworth: "Everything we do is taking too long. It's unacceptable in 1989 to spend five years, or even 10 years, going back and forth, back and forth, about the safety of one chemical."

More research is needed. And more research should be funded.

FRUIT AND VEGETABLE SHOW SET FOR JULY IN SOVIET UNION

Fruits and Vegetables '89 is the title of an agricultural trade show to be held in Kishinev, the USSR, from July 19 thru 26.

Featured at the international exhibition will be cooling, transportation, bottling, sorting and packaging equipment and laboratory and control instruments.

American companies interested in participating are asked to make contact with Orbis International of Atherton, Calif., the U.S. based organizer of international trade shows in the USSR.

"Due to recent changes in enterprise law, businesses in the Soviet Union have greater control over the use of profits for investment," said Roman Shukman, president of Orbis International. "This translates into larger funds allocated for new western products and services."

G^{RI} Gapen

Realty & Insurance

Knowledge & ability to unite buyers and sellers for existing marshes or undeveloped land.

2141 8th Street South
Wisconsin Rapids,
Wisconsin 54494
(715) 423-6550



REALTOR

Multiple Listing Service
MLS



EQUAL HOUSING OPPORTUNITY

R.D. GRASSI *Cranberry* SERVICES

**Herbicides
Applied**

*Custom Pruning
Custom Ditching*

**West Wareham,
Massachusetts**

**Sanding
Wiping
Wet Harvesting
Mowing**

*(Mowing includes
Hydraulic Arm
Flail Mower.)*

**Ask for Rick at
295-5158**

Niemi Electric Company



Robert
Niemi
Electrical
Contractors

Heat, Light & Power Wiring

- RESIDENTIAL
- COMMERCIAL
- INDUSTRIAL

**Pinehurst Drive
Wareham, Mass.
TEL. 295-1880**

How to Use a Data Base In Your Business

By **CHESTER PETERSON JR.**

You may not have thought of it exactly that way, but when you first penciled a note on a 3 x 5 inch card or wrote a name and address on a sheet of paper and stuck it in a file folder, you were creating a data base!

I've done plenty of both. In fact, I'll have to admit it. I'm one of those people who store information like a squirrel caching nuts. I have a file cabinet drawer after file cabinet drawer chock full of semi-organized material. I also keep a separate Rolodex-style card file, and use yet another stored in a desk drawer.

Oh my, just ask me and I can come up with just about anything I want—although it may take me a

little while, like a couple of hours. And, too, often I can't read my scrawled handwriting once I do find that all-important contact's name and phone number.

A friend of mine is just the opposite. He, well, let's call him Rex, just can't be bothered to take the time to properly file information. He's always losing vital address and phone info in the scattered piles on and around his desk.

Both of us were prime candidates for a computer data base system, although for different reasons.

I can't speak for my friend, but I do know that the data base software I bought is just about the best money I've spent. And I'm still learning new ways to sort and use the information it provides for my business almost every day, too.

It's amazing how much time it saves me . . . how many jobs it can do . . . how little time it takes to

maintain once set up . . . what it enables me to do that I couldn't do before.

Basically, what a computer data base lets you do is better and more effectively organize and present your information.

A computer data base gives you these advantages over a B.C. (Before Computer) filing system:

- You can drop information into your file in any order at any time.
- You can also retrieve information from your file in any order at any time.
- You can compile your information automatically.
- You can summarize and report your files in any of several formats, whichever is your preference at the time.

There are some disadvantages, too:

- Although keying in new data goes as fast as you can type, it isn't



Equipment, Inc.

381 West Grove St. (Rte. 28)
Middleboro, MA 02346

(508) 947-6299



Tractors, Excavators and
Diesel Generators



Wheel Loaders
3/4 Yd - 6 1/2 Yd



Screening Equipment

Vines For Sale

<i>Ben Lear</i>	\$3,500 a ton
<i>Stevens</i>	\$3,500 a ton
<i>Crowley</i>	\$3,500 a ton
<i>Le Munyon</i>	\$3,500 a ton
<i>Searles</i>	\$3,500 a ton

\$500 a ton less with 50% payment before cutting

*Lake Nokomis
Cranberries, Inc.*

David Zawistowski

6031 County Highway D (715) 479-4658
Eagle River, WI 54521 (715) 479-6546

as rapid a storing method as dropping a sheet of paper into a file folder.

• How you set up your data base—its form—to store your information is a top priority. You need to give this a good bit of thought. Before you start, think about what results you're going to want, then work from there.

Generally, however, it's possible with most data bases to add new columns of material and to change your data file arrangements later on. I wouldn't use a data base lacking this flexibility. Still, it's best to do your planning before beginning initial work.

The first time you open the manual that comes with your data base software, you're going to be intimidated. I still am, in fact.

However, I tried to make it easy by thinking of the data base as a simple filing cabinet containing file folders that, in turn, contain sheets of paper.

Such a sheet of paper—and it can be reaaaaalllllyyy long—is the guts of any data base. Here's where you record your specific information in "fields." A "field" is a name or address or zip code or other individual info you type in.

Your biggest job is in setting up the "form" of the data base so all your "fields" are entered in the proper order and they're all included.

Depending on the data base, in addition to text entries you may also be able to have number fields

automatically totaled or averaged or whatever.

For example, if you have a large company, you can set up your data base so you can later sort and pull out each salesman who sold more than X dollars the last six months or"

Enough of theory. Let's set up a data base and see how one can be utilized in your business.

Note the examples. I set up an entirely fictitious data base of a dozen people. In real life, this data base could be 120 or 1,200 or 12,000 people or

When setting up your data base, create it with ease of data entry foremost in your mind. Certainly include all the information you want, but—more important—have it appear in a logical format. Aren't

you used to first typing titles, then names, then addresses, etc.?

Well, that's the way to initially organize your information to speed later entering of your data. And don't worry overly much that this may or may not be the way you want to see your information printed out later.

You see, the great thing about most computer data bases is that you can usually enter your information in any order you wish. Then you can arrange it later with virtually no effort to have it end up looking precisely the way you want it.

I know, that takes some getting used to. But it's true. It's just one of the things you're going to come to appreciate about a computer data base.

Caution: Be especially alert to



VOLM BAG COMPANY, INC.

1804 EDISON ST. BOX B, ANTIGO, WIS. 54409-0116
PHONE 715/627-4826

SUPPLYING AGRICULTURAL CHEMICALS

BRAVO - SEVIN - FUNGINEX - ORTHENE
CASORON - GUTHION - DEVRINOL - PARATHION

AND

**DELIVERING A COMPLETE LINE OF FERTILIZER
WITH FAST FRIENDLY SERVICE!!!**

Irrigation Supplies

- 2" to 12" PVC Pipe with Fittings
- Quick Couple Risers
- Felker Aluminum Flumes & Culverts

Replace old aluminum mains with government approved 4", 6" and 8" polyethylene pipe buried just below bog surface. No insert fittings. Rent our butt fusion welder for a continuous main line. Beat the high cost of custom installation by renting our small 4-wheel drive tractor with mole hole plow for buried laterals.

STEARNS IRRIGATION, INC.

790 Federal Furnace Rd.

Plymouth MA 02360

Tel. (508) 746-6048

CRANBERRY



COMPUTER, INC.

CRANWARE

- Growers
- Handlers
- Chemical Applications
- Chemical Resale

(508) 747-3033

P.O. Box 1037, Plymouth, MA 02360

	Title	First name	Middle name	Last name	Suffix	Position	Company	Address	City	State	Zip	Phone	Category	Misc.	Remarks
1	Mr.	Brian	T.	Wash		President	Blue Star, Inc.	P. O. Box 7666	Los Angeles	California	92055	213-334-7879	EB5	A	Remarks
2	Mr.	Young	D.	Young	Jr.			1121 South Chicago	Newport Beach	California	92560	714-777-3322	EB5	D	Call in Spring
3	Mr.	Evilyn		Kinderknecht				725 Marshall Lane	Los Angeles	California	91111	213-756-9987	EB5	C	Stater msg sponsor tour
4	Mr.	Harvin	Francis	Woodstock	III	Vice President	Ford Construction Co.	1018 Sigurnum Avenue	Long Beach	California	90012	213-444-6537	EB5	A	Check with Sam Ballou
5	Mr.	Ken		Sweeney				Royal Flush Saloon	Los Angeles	California	91123	213-432-8756	EB5	B	Consider '88 Trent
6	Miss	Barbara		Thompson		President	Royal Flush Saloon	Las Vegas	Nevada	California	85668	702-112-6145	EB5	A	Consider '88 Trent
7	Mr.	Roman	L.	Prinick				515 South Ohio	Irvine	California	92678	714-655-4356	EB5	B	Call before Jan. 1
8	Mr.	Elizabth	E.	Gates				2077 Norton Street	Corona del Mar	California	92678	714-766-8324	EB5	A	Call before Jan. 1
9	Mr.	Jenna	E.	Elwood		General Manager	Solo Products Co.	1145 North 10th	Dana Point	California	90012	213-444-6537	EB5	A	
10	Mr.	Richard	E.	Elwood		General Manager	Solo Products Co.	1145 North 10th	Dana Point	California	90012	213-444-6537	EB5	A	
11	Mr.	Hollan	D.	Compton		Group V.P.	Taylor Trucking Co.	2121 Fern Blvd.	Los Angeles	California	92213	213-545-8097	EB5	A	
12	Dr.	Delbert	D.	Ziegler				831 Scott Avenue	Los Angeles	California	96547	213-832-7658	EB5	C	

	Title	First name	Middle name	Last name	Suffix	Position	Company	Address	City	State	Zip	Phone	Category	Misc.	Remarks
1	Mr.	Hollan	D.	Compton		Group V.P.	Taylor Trucking Co.	2121 Fern Blvd.	Los Angeles	California	92213	213-545-8097	EB5	A	
2	Mr.	Richard	E.	Elwood		General Manager	Solo Products Co.	1145 North 10th	Corona del Mar	California	92675	714-766-8324	EB5	B	Call before Jan. 1
3	Mr.	Jenna	E.	Fates				515 South Ohio	Irvine	California	92678	714-655-4356	EB5	B	
4	Mr.	Elizabth		Kinderknecht				1121 South Chicago	Los Angeles	California	91111	213-756-9987	EB5	C	Stater msg sponsor tour
5	Mr.	Evilyn		Young		President	Blue Star, Inc.	P. O. Box 7666	Los Angeles	California	92055	213-334-7879	EB5	A	
6	Mr.	Roman	L.	Prinick		President	Royal Flush Saloon	Las Vegas	Nevada	California	85668	702-112-6145	EB5	A	Consider '88 Trent
7	Mr.	Ken		Sweeney		President	Royal Flush Saloon	Las Vegas	Nevada	California	85668	702-112-6145	EB5	A	Consider '88 Trent
8	Mr.	Elizabth	E.	Gates				1018 Sigurnum Avenue	Long Beach	California	91123	213-432-8756	EB5	B	Check with Sam Ballou
9	Mr.	Harvin	Francis	Woodstock	III	Vice President	Ford Construction Co.	725 Marshall Lane	Los Angeles	California	90012	213-444-6537	EB5	A	
10	Mr.	Jenna	E.	Elwood				1145 North 10th	Dana Point	California	92213	213-444-6537	EB5	A	
11	Mr.	Hollan	D.	Compton		Group V.P.	Taylor Trucking Co.	2121 Fern Blvd.	Los Angeles	California	92213	213-545-8097	EB5	A	
12	Dr.	Delbert	D.	Ziegler				831 Scott Avenue	Los Angeles	California	96547	213-832-7658	EB5	C	Call in Spring

	Title	First name	Middle name	Last name	Suffix	Position	Company	Address	City	State	Zip	Phone	Category	Misc.	Remarks
1	Mr.	Hollan	D.	Compton		Group V.P.	Taylor Trucking Co.	2121 Fern Blvd.	Los Angeles	California	92213	213-545-8097	EB5	A	
2	Mr.	Evilyn		Kinderknecht				1121 South Chicago	Los Angeles	California	91111	213-756-9987	EB5	C	Stater msg sponsor tour
3	Mr.	Brian	T.	Wash		President	Blue Star, Inc.	P. O. Box 7666	Los Angeles	California	92055	213-334-7879	EB5	A	
4	Miss	Barbara		Thompson				1018 Sigurnum Avenue	Long Beach	California	91123	213-432-8756	EB5	B	
5	Dr.	Delbert	D.	Ziegler				831 Scott Avenue	Los Angeles	California	96547	213-832-7658	EB5	C	

	Title	First name	Middle name	Last name	Suffix	Position	Company	Address	City	State	Zip	Phone	Category	Misc.	Remarks
1	Mr.	Richard	E.	Elwood		General Manager	Solo Products Co.	1145 North 10th	Dana Point	California	90012	213-444-6537	EB5	A	
2	Mr.	Evilyn		Gates				515 South Ohio	Irvine	California	92678	714-655-4356	EB5	B	
3	Mr.	Harvin	Francis	Woodstock	III	Vice President	Ford Construction Co.	725 Marshall Lane	Torrance	California	90012	213-444-6537	EB5	A	
4	Mr.	Jenna	D.	Young	Jr.			1125 Lennox	Newport Beach	California	92660	714-777-3332	EB5	D	Call in Spring

	Title	First name	Middle name	Last name	Suffix	Position	Company	Address	City	State	Zip	Phone	Category	Misc.	Remarks
1	Mr.	Richard	E.	Elwood		General Manager	Solo Products Co.	1145 North 10th	Dana Point	California	90012	213-444-6537	EB5	A	
2	Mr.	Harvin	Francis	Woodstock	III	Vice President	Ford Construction Co.	725 Marshall Lane	Torrance	California	90012	213-444-6537	EB5	A	

EXAMPLES of Peterson's data base, sorted in various ways.

typographical errors in your entries. Your computer can't distinguish between "Jones" and "Joness."

Okay, in the illustrated examples, I've made it easy to move from title through the names to position, company, address, city, state and zip code.

Now's where you start becoming creative. What special information do you want to record—and later be able to pull out?

I've stuck in two columns for sorting plus one for "Remarks." You could have a dozen. I used some arbitrary symbols in the "Category" column that could mean the person concerned expressed an interest in European business in 1985 or 1986, for instance, or in the Orient or in South America.

The letters "A," "B," "C" or "D" could have any meaning put to them you wish. Let's say "A" means a top priority business prospect or past customer.

Remember, after you enter all the information the easiest way you

know how, you can later sort and arrange it any way you desire.

You can then print out portions of the entire data base. Example: All the names arranged alphabetically and the accompanying phone numbers and zip codes. The possibilities are endless.

However, I usually prefer to print out all my columns, using a 50 percent type size reduction feature in

my software.

The top example—example 1—shows exactly how I entered the information. Example 2 is the same except that it's been sorted alphabetically by last name. We could have instead sorted in reverse alphabetical order, too.

Or we could have done like I do with my personal data base: Sort by company alphabetically as first

WISCONSIN CRANBERRY HEADQUARTERS FOR SEVIN XLR

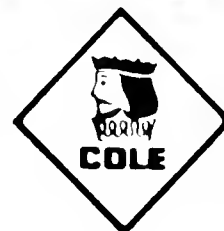

DEVRIKOL 10G * EVITAL * GUTHION
DIAZINON 14G * PARATHION * ETHREL

Cole/Grower Service

537 Atlas Ave., P.O. Box 7211, Madison, WI 53707
(608) 221-6204 or 1-800-362-8049

Cranberry Harvesting Equipment

Warrens Equipment & Manufacturing Co., Inc.

Growing cranberries is something you as a grower do best. Manufacturing of harvesting equipment, air flow, radar controlled fertilizer spreading equipment, and flow gates or flumes is something we do that can be of service to you.



NEWS FLASHES

New All Aluminum Bog-Tractor & Beater for 1989 with Features such as:

- All hydrostatic 4-wheel drive
- Fenders
- On-the-go reel speed change
- Safety parking brake
- Ground speed and reel speed indicator
- Lighter weight
- Engine horsepower available from 18 h.p. to 48 h.p.

Be sure to check this new model harvester before you make a purchase for 1989.

WEM Factory serving Wisconsin, West Coast, British Columbia
111 Grant St.
Warrens, WI 54666
Tel. (608) 378-4794
(608) 378-4137

WEM East Coast
Stearns Irrigation, Inc.
790 Federal Furnace Rd.
Plymouth, MA 02360
Tel. (508) 746-6048

priority and sort by last name alphabetically as second priority.

Example 3 is the same list sorted by last name alphabetically only or those with Los Angeles addresses.

Example 4 is sorted by last name alphabetically for those listed as 185 under the "Category" column.

Example 5 is the same, but also sorted for the "A" under the "Misc." column.

That's sorting. Now what if you want to find a name in your database of 3,000 entries and all you can remember is that this fellow lives in Seattle?

Use the "Find" function in the "City" column and have your computer kick out on your screen all listings in Seattle. He'll be among them and should be easy to sift out.

The computer data base is normally used two ways: 1) called up on the screen for quick checks of information; 2) called up for printing out various listings.

I'd like to give you two more ideas for things you can do with it.

First, if possible, buy a data base that works with your word process-

ing software to produce mail merge, computer generated personalized letters. There are virtually infinite ways you can combine the two to drum up business.

Second, you might consider what I do. I've printed out three copies of various portions of my data base. I keep one set of copies in my desk for quick references, one in my attache case and one in my travel kit.

Since starting this system, I've seldom been at a loss for a name, address or phone number for more than a couple of seconds.

Today, my powerful, yet relatively inexpensive computer with data base software shoved in the diskette slot does the job that 20 years ago would have required a mainframe and 10 years ago a \$40,000 minicomputer.

Combined, my microcomputer hardware and data base software is the best "tool" I own.

(Chester Peterson Jr., former departmental editor of a million-plus circulation national magazine, has written many articles in some 78 different publications.)

—Arkin Magazine Syndicate

45 Years Ago

Lt. Col. Cecil G. Dunn, Army Quartermaster Corps, says the military will require 150,000 barrels of cranberries for fiscal year 1945 to fulfill the eating needs of service people. "It is the patriotic duty of all growers to consider military requirements, for this is their country and the berries are going to their own countrymen and actually their own sons and relatives," said Dunn.

* * * * *

Growers at the annual meetings of the Southeastern Cranberry Club, Rochester, Mass., and the South Shore Club, Kingston, Mass., were told that farm labor will be scarce for the coming growing and harvesting seasons. Roy E. Moser, state secretary, Emergency Farm Labor, said the government is expected to

Irrigation Equipment Designed Especially for the Cranberry Industry

- Gorman-Rupp Self Priming Electric Sprinkler Pumps
- Proven Quick Couple Riser
- Polyethylene Main Lines, 3" - 12"
- Butt Fusion Equipment Available
- Paco/Wemco Water Harvest Pump
- Berkeley Self-Priming and Centrifugal Pumps

A Most Complete Inventory of Irrigation Accessories

LARCHMONT IRRIGATION / SNOWMAKING

P.O. Box 66, 11 Larchmont Lane
Lexington, Massachusetts 02173 (508) 862-2550

Contact

Larchmont Engineering
Phil Tropeano, President
(508) 862-2550
(Call Collect)

Stearns Irrigation, Inc.
790 Federal Furnace Rd.
Plymouth, MA 02360
(508) 746-6048

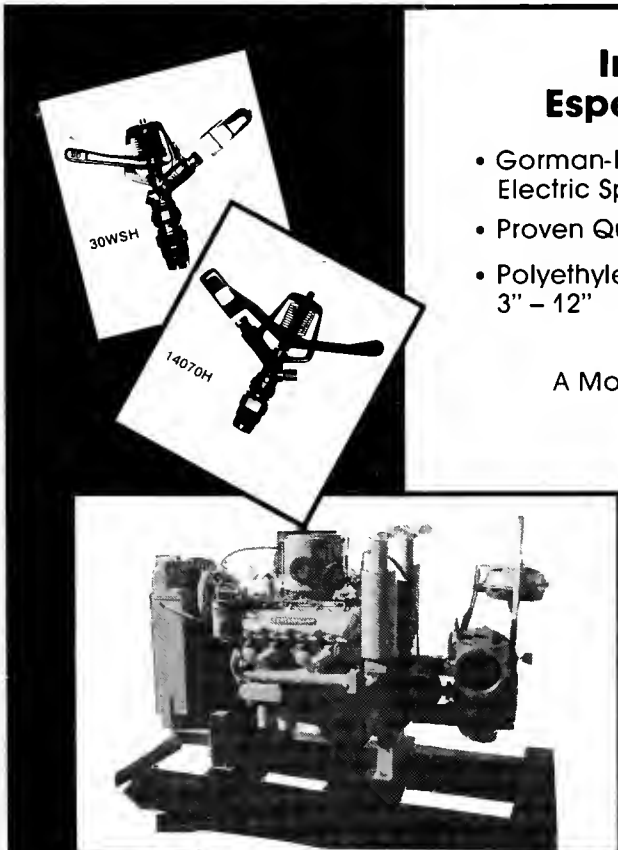

make more Jamaicans and Bahamians available. The status of Italian prisoners of war is expected to be changed shortly, he added, but few, if any, he thought, would be available for farm labor.

* * * * *

"Underproduction was one of our chief worries in 1943 and, as I see it, one of our chief worries in 1944 may also be underproduction," C.M. Chaney, general manager, American Cranberry Exchange, told members of the New England Cranberry Sales Co. at its annual meeting in the Carver, Mass., Town Hall. He said the berries sold through the Exchange totaled 269,835 barrels and brought an average FOB price of \$18.72, the highest average at which cranberries had ever been sold.

* * * * *

Winter floods were coming off Wisconsin marshes about April 15 and, in general, it was thought the vines should have come through the winter well. Grower/correspondent Vernon Goldsworthy said he thought Wisconsin would have a crop of 115,000 to 125,000 barrels in 1944.

* * * * *

Oregon had a very dry winter and a spring characterized by many light, early morning frosts. Some marshes reported damage in the first 10 days of April, shortly after the winter flood had been let out.

* * * * *

Dr. Henry J. Franklin, director, Massachusetts Cranberry Experiment Station, warned growers that only one quarter of the normal

amount of pyrethrum and no rotenone were being allocated for cranberry use. He told them to save pyrethrum for the most imperative uses, such as control of the bluntnosed leafhopper, the blackheaded fireworm

and possibly the cranberry girdler.

* * * * *

The Plymouth County, Mass., Electric Company called for conservation of electricity, saying "speeding victory is what counts now."

WANTED

Gravel & Sand

in the southeastern Massachusetts area

Quantities of 10,000 yards and up

Complete site work, bog construction and finished contouring of surrounding area plus the best price for your material.

<p>Michael Coan Carver, Mass. (508) 866-5285</p>	<p>Earl White Medfield, Mass. (508) 359-7291</p>
---	---

WOLLSCHLAGER EXCAVATING

Dragline Work — All Kinds

Also Have Clam & Scalping Buckets

Route 1 Necedah, WI 54646
1-808-585-2436

**CRANBERRY
 GROWERS
 REALTY**

*Listings of buyers and
 sellers welcomed on
 cranberry acreage
 and upland.*

Appraisals

DOUGLAS R. BEATON
 E. Sandwich, Mass
 02537
 (617) 888-1288

O  **RTHENE**

BUILDS PROTECTION

YOUR FOUNDATION INSECTICIDE FOR SPARGANOTHIS, FIREWORM AND SPANWORM CONTROL

Distributed by:  **VOLM BAG COMPANY, INC.**

1804 EDISON ST. BOX B, ANTIGO, WIS. 54409 0118
 PHONE 715/627-4826



The primordial growth of the flowers and the upright in terminal fruit bud . . . as illustrated . . . is now growing on the bog. Growth that needs constant attention to protect it from insects.

Know the Insects

Color photographs of all these insects and more are now arranged with text in a portfolio that is available.

The portfolio endeavors to bring together the words of research complementing the photographs and making a summary of cranberry insect information that will be of use to the cranberry grower for a lifetime.

The portfolio is available for \$100 and, if you wish to examine a copy, telephone (609) 894-8556 evenings around 6 p.m. or write to:

**Walter Z. Fort
P.O. Box 183
Pemberton, NJ 08068**

Take Good Care of Yourself Have an Ocean Spray!



The farmer's cooperative that brings you
a wide range of natural fruit juices, drinks and sauces
Ocean Spray Cranberries, Inc., Plymouth, Massachusetts 02360
An Equal Opportunity Employer



Migratory
Beekeeper's
Work Is
Never Done

Pollen
Source
And
Fruit Set

Ocean
Spray,
Decas
Settle

S

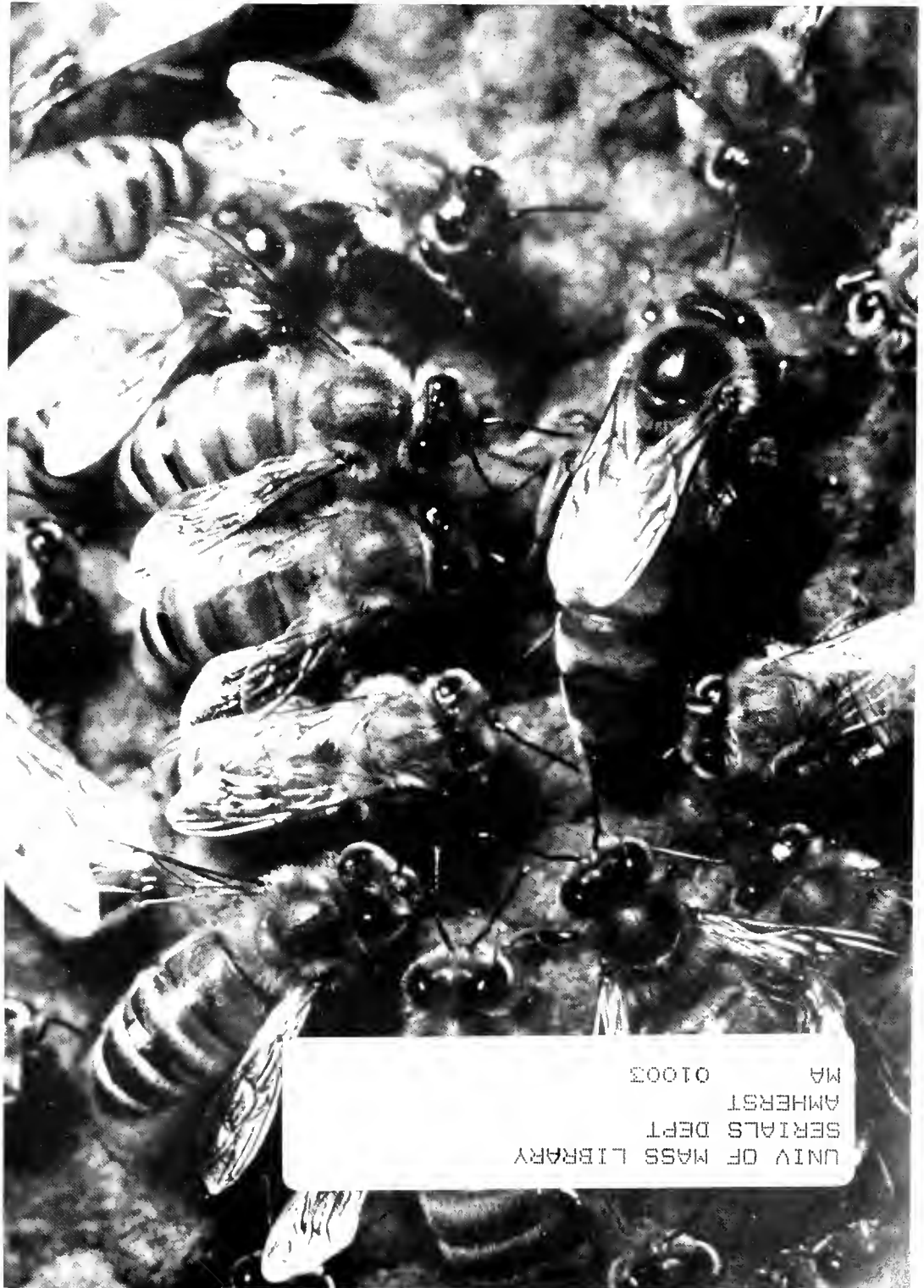

UNIV OF MASS LIBRARY
SERIALS DEPT
AMHERST
MA 01003

The Pilgrim stands behind
every commercial loan
Roy Cyr
makes.

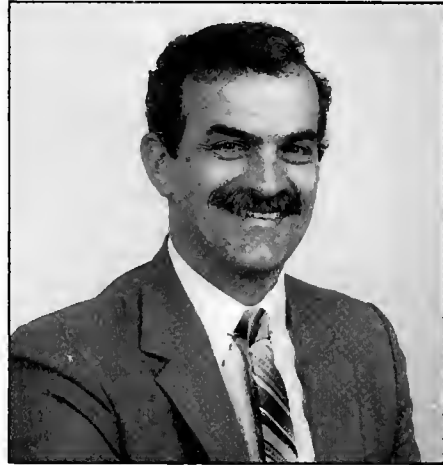

And that's a
promise.

Call him on it at 746-3300.

The Pilgrim is a symbol of strength, integrity and experience; and it best personifies the resources Roy Cyr offers every business that turns to him for help.

A vice president of our commercial banking operation, Roy has over 20 years of banking know-how. His expertise has helped to earn us a reputation as The Answer Bank.

Backed by the superior lending capabilities of Plymouth Savings Bank, Roy can design a commercial lending package with the attractive rates and fast turnaround time that you need.

This is the power and the promise of the Pilgrim.
Call Roy Cyr at 746-3300.

Main Office: Wareham, (508) 295-3800; Cotuit, (508) 428-1300;
Duxbury, (617) 934-0101; Falmouth, (508) 548-3000;
Marion, (508) 748-2919; Mattapoisett, (508) 758-4936;
Middleboro, (508) 946-1777; North Plymouth, (508) 747-1600;
Plymouth, (508) 746-3300; Sandwich, (508) 888-4444;
Teaticket, (508) 540-5002

Plymouth
 **Savings**
Bank®

Member FDIC/DIFM

Bloom Time Is Busy as Bee Time For Beekeeper

You might call Horace Bell an air traffic controller and you wouldn't be far wrong.

Actually, he's a migratory beekeeper and he directs the flight of his winged minions from his control tower in Deland, Fla. Right now he's as busy as a bee himself.

The Horace Bell Honey Company, you see, has about 30,000 hives. In each of those hives about 10,000 bees are buzzing. A goodly number of them will be gathering nectar on cranberry bogs in Massachusetts and Wisconsin this month.

So Horace, who'd rather will be an outdoor man, will be indoors, dispatching tractor trailers loaded with hives for cranberry country. The bees will perform their role as pollinators for about a month and then be moved out.

"Everybody wants the bees all at once," says Horace. "Then, as fast as they wanted them in, they want them out. Ten growers will call up at once, saying they want the bees out tomorrow—or yesterday."

Most growers take two hives per acre. The cost: \$35 per hive.

Do the bees get results? In fruit set and yield? Over the years, Robert S. Filmer, Philip E. Marucci, William E. Tomlinson Jr., Malcolm N. Dana, D.W. Anderson, G.W. Eaton and other cranberry experts have attested that they do.

Bell has another barometer of success.

"The best testimonial," he says with a chuckle, "is when they make those checks out."

The 43-year-old Bell got started in beekeeping at the age of 4.

"My grandfather gave me and my brother hives," he said. "And I've been at it ever since."

Beekeeping today, however, is big business, Bell declares.

"Most of the smaller ones are going out of business," he says. "Either you get to be more efficient or you don't last."

(Please turn the page)



HORACE and Luella Bell don't get much of a chance to get dressed up in their Sunday best at this time of year.



CHECKING on the condition of his hives is a never ending task for Horace Bell. He's got 30,000 of them.

COVER PHOTO

WHILE these migratory honeybees are inside their hive working, other bees are out collecting nectar and pollinating cranberries. The result? Increased fruit set and better yield. A story about one of the largest migratory beekeepers starts on this page.

(Photo by Norman S. Gray)

Bell's \$2 million business employs 22 full-time workers as well as day labor and part-time help during the busy season. The company's property includes a dozen trucks and a dozen fork lifts and Horace Bell Honey leases the tractor trailers that carry huge loads of hives.

Being situated in sunny Florida means that the honey company is busy all year long.

The honeybees are used in Florida for citrus. Then they go to Maine and New Jersey for blueberries. Cranberries follow. Bell's honeybees also are used to pollinate fruits and vegetables in 14 other states.

For example, the bees assist pollination in North Dakota's alfalfa fields and upwards of 3 million acres of sunflowers.

Bell claims to be the largest supplier of bees for cranberries and blueberries in North America.

All this migration requires the logistical skills of a military commander. Most of the movement takes place at night, with as many

as half a million bees borne onto a truck by pallets. For long trips, screenlike nets are flung over the load.

The reason for moving at night is because 10 to 20 percent of the bees are buzzing about during the day looking for nectar. At night, they're all in the hive.

In between moving honeybees, there are other chores to perform. New colonies have to be started. Hives must be repaired and replaced. The insects must be checked for diseases and parasites.

To accomplish the latter, Horace Bell Honey has its own laboratory, headed up by Luella Bell. She and Horace got married right after high school graduation. They have three daughters. All work in the company, as do the husbands of the two who are married.

Mr. and Mrs. Bell also have three grandchildren, 5, 4 and 3 in age, and they're getting an early start in beekeeping.

Bell, tongue in cheek, says he's thinking of hiring private tutors

for the kids so that they're not too exposed to the outside world. Otherwise, he explains, they won't want to put up with the long hours—"and at certain times of the year, it's day and night."

In some cases, Bell deals with middlemen. In Massachusetts, for example, he works through Merrimack Valley Apiaries and Mendes Apiaries. In other cases, he deals directly with cranberry growers and other farmers.

Actually, farming bees out for pollination is only part of the Horace Bell Honey operation. Another—and larger—part of the business is honey production.

Horace Bell Honey is the nation's largest producer of orange blossom honey. Most of the honey is shipped to Europe in 55 gallon drums. Spain is a particularly larger importer.

All told, the company produces 3 million pounds of honey each year.

You can detect in Horace Bell's voice a deep appreciation of the bee, which has fascinated human beings throughout the centuries

K Ag Laboratories International, Inc.

**2323 Jackson Street
Oshkosh, WI 54901**

**Serving Cranberry
Growers in U.S.A.
& Canada since 1984**

**Over 20 years
of Experience on
Acid Soil Interaction**

K Ag Laboratory has run over 30,000 cranberry soil and over 17,500 cranberry vines tests since 1984, and gave fertilizer recommendations with great success.

- ★ *Cranberry Soil Analysis*
- ★ *Cranberry Vine Analysis*
- ★ *Cranberry Water Analysis, Usage & Interpretation*
- ★ *Liquid & Dry Fertilizer Recommendation*
- ★ *Soil Problems & Consultation*
- ★ *Seminars*
- ★ *Cranberry Crop Monitoring Program, testing and monitoring nutrient status with 30 day intervals during the growing season.*

Highly computerized cranberry soil, tissue and water testing program in U.S.A. and Canada.

For more information contact: **Dr. Akhtar Khwaja, Ph.D.**
Certified Professional Soil Scientist
Certified Professional Agronomist

Phone Number 414-426-2220; Out of WI 1-800-356-6045; FAX 414-426-2222

Coast Cranberries Ltd.

Member of Ocean Spray Co-operative

Offers

a Rare Opportunity to Invest in
Cranberry Farming in British Columbia
CANADA

HISTORY:

Coast Cranberries Ltd. was established in Fort Langley in 1981 on 320 acres of high quality peat land. In 1982 the land was cleared and planted; later, a further 70 acres were purchased bringing the gross acreage to 390. By 1989 the farm has been developed into 271 planted acres divided into 52 separate fields. The fields are beautifully laid out with vines which are at different stages of growth. Should Ocean Spray Co-operative decide to allocate new acreage for planting, it is fortunate that adjacent land is available for purchase.

The farm is equipped with state of the art computerized sprinkler and frost control system, reservoir for water storage, and a pumping system that keeps fields well drained and pumps water from the Fraser River when required.

The buildings on the property consist of a manager's house, a machine shop, machinery and equipment sheds, and 12 pump stations.

Coast Cranberries Ltd. has excellent management and work teams. It has the potential of being one of the most successful and up to date cranberry farms in North America.

TERMS:

\$17,606,000 CASH

OR

\$7,040,000 for 40% of the farm with options to purchase further shares at market value.

For further information about this investment opportunity, please contact:

KEN HOPKINS AT (604) 276-8069

252 - 7671 Minoru Blvd., B.C., Canada V6Y 1Z3

Writer Mary Louise Coleman, author of *Bees in the Garden & Honey in the Larder*, tells, for example, of depictions of migratory beekeeping on walls and sarcophagi from ancient Egypt.

Horace will elaborate on the many specialized tasks performed by a colony of bees and will tell you how the creatures navigate by the sun and how unerring their homing instinct is.

When you move bees, he says, you have to move them beyond a radius of three miles or they'll go right back to their old foraging site.

And he'll tell you the bee has no equal as a worker.

"The bee doesn't age chronologically," explains Bell. "It ages physiologically. They literally fly themselves to death. Their wings wear out. They usually collapse in the field and die."

Not native to America, the honeybee is a European import.

"The Indian called it the white man's fly," notes Bell.

The honey company president says the migratory honeybee is becoming more and more impor-

tant for pollination. That's because pesticide spraying has taken such a heavy toll on natural pollinators, he adds.

"Pesticides are not as bad as they used to be," Bell says. "Ten or 15 years ago, they were terrible. The growers are usually cautious and will spray when the bees aren't around. Usually the damage is from the spraying of other crops."

Needless to say, Horace and Luella are champions of integrated

pest management and the increasing reliance on biological controls.

Aside from manmade threats, the Bell bee stock is beset by many natural enemies. Horace and Luella must be on a constant lookout for everything from brood disease to trachea and varroa mites to nosema spores. And they must take rapid action, which means burning a hive in the case of brood disease and introducing menthol to the hive for

(please turn to page 8)



**BLUE HERON
FARMS**

GROWER SERVICE

MOWING (all types) * DITCHING
WATER HARVESTING * SANDING

"Specializing in the Needs of Small Growers"

Call Wayne or Karen Barnes

72 Brook St.
Plympton, MA 02367
1-617-585-9830

CRANBERRIES

THE NATIONAL CRANBERRY MAGAZINE

SEND CORRESPONDENCE TO:

**P.O. BOX 249
COBALT CT 06414
(203) 342-4730**

Fax #: (203) 342-1977

PUBLISHER & EDITOR: BOB TAYLOR

ASSOCIATE EDITOR: CAROLYN GILMORE
(508) 783-5206

ADVISORS & CORRESPONDENTS

MASSACHUSETTS — Irving E. Demoranville, Director, Cranberry Experiment Station.

NEW JERSEY — Phillip E. Marucci, Cranberry & Blueberry Specialist, Buddtown; Elizabeth G. Carpenter, Chatsworth.

NOVA SCOTIA — Robert A. Murray, Horticulturist, Berry Crops, Research Station, Truro

OREGON — Arthur Poole, Coos County Extension Agent, Coquille.

WASHINGTON — Azmi Y. Shawa, Horticulturist and retired Director, Coastal Washington Research & Extension Unit, Long Beach.

WISCONSIN — Tod. D. Plener, Farm Management Agent, Wood County

CRANBERRIES is published monthly by Diversified Periodicals, Wallwyn Drive, Portland CT 06480. Second class postage is paid at the Portland, Conn. Post Office. Price is \$15 a year, \$28 for two years, \$2 a copy in the U.S.; \$17 a year in Canada; \$20 a year in all other countries. Back copies: \$2.50, including postage. Copyright 1988 by Diversified Periodicals.

ISSN: 0011-0787

Postmaster, send Form 3749 to:

CRANBERRIES
P.O. BOX 249
COBALT CT 06414

Irrigation Supplies

- 2" to 12" PVC Pipe with Fittings
- Quick Couple Risers
- Felker Aluminum Flumes & Culverts

Replace old aluminum mains with government approved 4", 6" and 8" polyethylene pipe buried just below bog surface. No insert fittings. Rent our butt fusion welder for a continuous main line. Beat the high cost of custom installation by renting our small 4-wheel drive tractor with mole hole plow for buried laterals.

STEARNS IRRIGATION, INC.

790 Federal Furnace Rd.

Plymouth MA 02360

Tel. (508) 746-6048

Office
295-2222

BEATON'S CRANBERRY GROWERS SERVICE

K. Beaton
295-2207

D. Beaton
888-1288



Specializing in

P. Beaton
947-3601

● COMPLETE BOG
MANAGEMENT

● NETTING

● DITCHING

● HARVESTING
(Wet & Dry)

● SANDING

● CUSTOM
HERBICIDE
APPLICATION

Complete line of portable Crisafulli Pumps 2" - 16"
Plastic netting for suction boxes



R. A. S. P. INC.

Carrying a Complete Line of:

- Cranberry Chemicals and Fertilizers
- Frost Alarms
- Thermometers
- Chemical Application Equipment
- Kubota K-35 Rental

Contact:

Bob or Mike
3 Plymouth St.
Carver, MA 02330

Phone:

(508) 866-4429

Authorized Agway Representative

AGWAY

trachea mites.

Any discussion of bee disease brings up the question of government inspection.

Horace recently attended the Varroa Negotiated Rulemaking Session in Washington, D.C. On the one hand, he was happy to see that the government was consulting people who have direct experience with bees. On the other hand,

he was displeased that the feds decided to relinquish control to the states.

"Some bees in the course of a year might go to six states," explains Bell. "It would be nice if the federal government would issue one certificate. Instead, we've got to deal with all of the states. We've become experts at filling out per-

mits. Of course, we don't like it."

So, like the honeybee, the Horace Bell Honey Company must become proficient at many tasks. But, to Horace, it's all worth it for a business with every prospect of good growth.

"If you eat a cranberry," he says, "there's a good chance it's been kissed by one of our bees."

Local Beekeepers Fight Mites

By CAROLYN GILMORE

Last year a tracheal mite outbreak was blamed for killing about 90 percent of the bees in hives in southeastern Massachusetts. This year hives in the state's cranberry growing region "look pretty good," according to Wayne Andrews, state bee inspector.

Some beekeepers have found success in treating their hives with cough drop variety menthol, a method not yet approved by the state. The "contraband" can be obtained by mail order from out of state candy suppliers. The recently formed Agricultural Bee Alliance is working with the Cape Cod Cranberry Growers' Association to get emergency labeling for menthol.

Another dreaded, but expected pest has also entered the area: varroa mite. The present infestation is low but "is expected to build up" this year, Andrews said.

"We've treated just about all the hives we know of in southeastern Massachusetts," he added.

Varroa mite, first detected in the U.S. in a Wisconsin apiary in September 1987, was confirmed in an additional 12 states by April 1988. Like tracheal mite, it is a parasite of honeybees that weakens the insect's ability to pollinate plants and produce honey. Because varroa multiply quickly, a beekeeper may fail to notice their presence until serious damage is done.

"The prognosis is we will never get rid of it," said Gus Skamarycz, president of the Agricultural Bee Alliance. "Under the present regulations of the pesticide board, the only people allowed to use fluvali-

nate to combat varroa are bee inspectors."

Presently, there are only two bee inspectors in the state to service 10,000 resident bee colonies and oversee the 15,000 or more hives from migratory operations. Warren Shepard, chief of the bureau of pest control, has requested five more inspectors for this season.

The Agricultural Bee Alliance was organized this year to open communication between pollinators and local beekeepers. There are between 1,000 and 2,000 resident colonies in the cranberry growing region. More cranberry growers are expressing interest in the option of

maintaining their own bee colonies rather than renting them from transient operations, Skamarycz said.

Florida bees expected to service the cranberry blossoms are reported to be in good shape, following an early poor honey flow from the citrus crop.

Shepard and Al Carr, chief apiary inspector, told the Cape Cod Cranberry Growers' Association that migratory bees were inspected and treated before leaving Florida.

About 70 percent of Massachusetts cranberries are pollinated by migratory bees originating in Florida.

R. D. GRASSI
Cranberry
SERVICES

Herbicides Applied	<i>Sanding Wiping Wet Harvesting Mowing</i>
<i>Custom Pruning Custom Ditching</i>	<i>(Mowing includes Hydraulic Arm Flail Mower.)</i>
West Wareham, Massachusetts	Ask for Rick at 295-5158

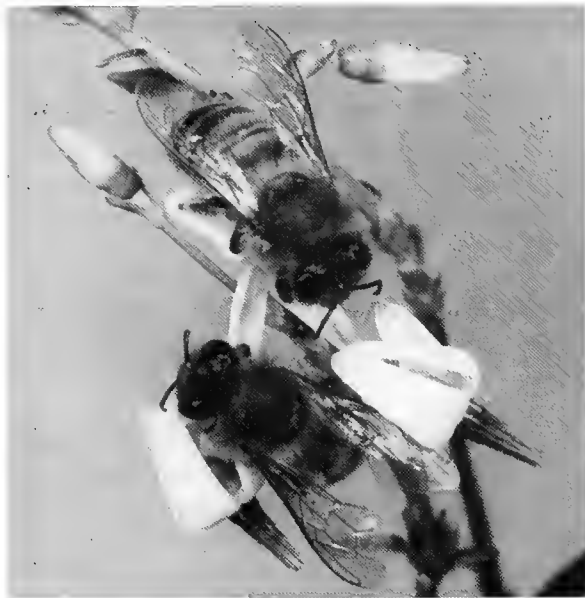

The cranberry growers' seasonal dilemma: too many destructive insects—tipworm, fireworm and fruitworm—then too few beneficial insects—the pollinating honeybees.

Know the Insects

The major cranberry insects: cranberry girdler, the fireworms, tipworm, blossom worm, cranberry fruitworm and Sparganothis fruitworm.

Know the Insects

The periodic cranberry insects: cranberry scale, fire beetle, blossom weevil, armyworm and bluntnose leafhopper.

Know the Insects

Color photographs of all these insects and more are now arranged with text in a portfolio that is available.

The portfolio endeavors to bring together the words of research complementing the photographs and making a summary of cranberry insect information that will be of use to the cranberry grower for a lifetime.

The portfolio is available for \$100 and, if you wish to examine a copy, telephone (609) 894-8556 evenings around 6 p.m. or write to:

**Walter Z. Fort
P.O. Box 183
Pemberton, NJ 08068**

Pollen Source and Fruit Set of Cranberry

Malcolm N. Dana, Sue Steinmann and Lynda Goben¹
Department of Horticulture, University of Wisconsin/Madison

Abstract. Flowers of 'Stevens' cranberry hand-pollinated with other cultivars produced seed numbers equal to self-pollinated flowers. Controlled pollination of 7 cultivars in all possible combinations in the greenhouse produced equivalent fruit set percentages for self- and cross-pollination. Field samples of open-pollinated flowers produced fruit set percentages that were independent of proximity to cross pollen sources.

The large cranberry of commerce, *Vaccinium macrocarpon* Ait., is grown with single clonal cultivars covering many hectares. No provision for cross-pollination among cultivars is provided. Large crops may be harvested from this planting system when weather conditions favor pollinator insect activity at blossom time. Fruit set percentages may exceed 50% or more under favorable conditions. The potential for enhancing fruit size and fruit set percentage through cross-pollination was explored in these studies.

Fruit size in cranberry has been positively correlated with seed number by several workers (2,3,6). These studies did not relate pollen source to seed number in the mature fruit. Following a number of controlled self-pollinations and cross-pollinations in a hybridization program, Bain (1) suggested that self-pollinated fruit often had fewer seeds than cross-pollinated fruit. Marucci (4) and Marucci and Filmer (5) reported a higher fruit set percentage when a cultivar was located for easy cross-pollination access by insects.

Dormant, hardwood cuttings with flower buds were collected from the field in April. Cuttings 10 cm long were placed immediately in 2 liter plastic containers with the basal 4 cm in aerated nutrient solution in a

CRANBERRY GROWERS REALTY

*Listings of buyers and
sellers welcomed on
cranberry acreage
and upland.*

Appraisals

DOUGLAS R. BEATON
E. Sandwich, Mass
02537
(617) 888-1288

Cranberry Harvesting Equipment

Warrens Equipment & Manufacturing Co., Inc.

Growing cranberries is something you as a grower do best. Manufacturing of harvesting equipment, air flow, radar controlled fertilizer spreading equipment, and flow gates or flumes is something we do that can be of service to you.



NEWS FLASHES

Standard WEM Bog-Trac Tractors & Beaters Available For Immediate Shipment

- *Beater reels available, your choice of designs*
- *You as a grower tell us what is best for your bog*
- *Change your reel rpm from bog to bog or variety to variety*
- *Engle horsepower available from 18 h.p. to 48 h.p.*
- *Safety parking brake*
- *Ground speed and reel speed indicator*
- *Lighter weight*

Be sure to check this new model harvester before you make a purchase for 1989.

WEM Factory *serving Wisconsin, West Coast, British Columbia*
111 Grant St.
Warrens, WI 54666
Tel. (608) 378-4794
(608) 378-4137

WEM East Coast
Stearns Irrigation, inc.
790 Federal Furnace Rd.
Plymouth, MA 02360
Tel. (508) 746-6048

glasshouse with temperatures fluctuating diurnally above a minimum 18 C and reaching 45 C on sunny days later in the development period. Natural daylight was supplemented with incandescent and fluorescent lamps to maintain a 16 hour day length. Each container carried mineral elements sufficient to maintain 10 cuttings in a healthy status for the duration of the flowering and fruiting period. Distilled water was added as needed to maintain solution levels. Cranberry cuttings in aerated solution develop roots in 10-14 days. Terminal flower shoots develop with leaves, flowers, and fruits comparable to those found on undisturbed plants in the field.

In the first trial designed to measure the effect of a pollen source on seed number per fruit, cuttings of 'Stevens' were grown to the hook stage (individual flower buds separated from the main stem axis) when all but the most advanced bud on a cutting was removed, leaving one "hook" per cutting. One day before petal separation (anthesis) this flower was emasculated to prevent any possible self-pollination of the flower. Two days after emasculation the receptive stigma was dusted with fresh pollen from 1 of 4 alien cultivars or with 'Stevens' pollen. Thus 'Stevens' was the seed cultivar and 'Ben Lear,' 'Searles,' 'Crowley,' 'McFarlin' and 'Stevens' were the pollen sources.

Pollinated flowers set fruit in all cases, and the fruit grew normally. At maturity the number of seeds per fruit was determined and the percentage of fruit in various seed number classes was calculated (Table 1). Seed number per fruit ranged from 1 to 39 with no consistent differences in seed number per fruit assignable to pollen source.

In 2 separate trials, cuttings of 7 cultivars were grown in solutions as previously described. All flowers were allowed to develop normally and no emasculation was done. At the time of, and 2 days after anthesis, each pistil was treated with candidate pollen from a particular cultivar. Each pistil received the foreign pollen and may have received some self pollen from the same flower, since the anthers, when agitated, shed pollen in the immediate vicinity of the receptive stigma. All flowers on the cuttings were pollinated. Fruit set percentages were determined 60 days after the last flower was pollinated in each of the trials.

There were no differences in fruit set that could be related to pollen source in either trial; therefore, the data were combined (Table 2). The average fruit set percentage for all self-pollinations was 79% and for all cross pollinations was 81%. The data offer no evidence that cross pollination among these 7 cultivars is beneficial to fruit set. When pollinated under greenhouse conditions, the flower will set and mature a fruit independent of pollen source.

Fruit set determinations were made on samples of fruiting uprights taken from a field in which 6 cultivars are planted in a strip arrangement within 1 flooding section. The field is 16 m x 247 m with 'Berlin,' 'Mammoth,' 'Howes,' 'McFarlin' and 'Vose's Pride' in 16 m x 33 m blocks and 'Searles' on a 16 m x 82 m block. Cultivar blocks are separated by a .05 m wide vegetation free path. Five samples of about 50 fruiting uprights each were harvested from randomly nominated points on transect lines situ-

Table 1. Numbers of seeds per fruit from several pollen sources on 'Stevens' cranberry pistils.

Pollen donor cultivar	No. of fruit	Percentage of fruit with seed number in class				Range of seed no.	Mean seed no.
		1-10	11-20	21-30	31-40		
Ben Lear	61	34	39	23	3	3-39	14
Searles	62	48	35	11	5	2-32	11
Crowley	39	44	38	18	0	2-29	12
McFarlin	65	34	40	20	6	1-36	15
Stevens (self)	70	41	50	8	0	1-27	12
Average	59	40	40	16	3		13

CRANBERRY



COMPUTER, INC.

CRANWARE

- Growers
- Handlers
- Chemical Applications
- Chemical Resale

(508) 747-3033

P.O. Box 1037, Plymouth, MA 02360

SKIPPAR



POLE

SERVICE

- Private Poles • Line Construction
- Sonotube Drilling • New & Used Poles

(508) 690-2238

208 Franklin St., East Bridgewater, MA 02333



THE BEST — IN EVERY RESPECT

CRANBERRY Model 400 GT

Precision Chemigation System



- Developed *Exclusively* for the Cranberry Industry
- Exceeds or Meets ALL Current EPA Requirements
- Simple to Operate and Easy to Calibrate
 - Self-Timer Application (1 minute Increments)
 - Easy Access Handle & Simple Reference Scale
 - Precise Visual Flow Calibration
- Outstanding Field Performance
 - Down-Line Venturi Injection System
 - High Capacity 0-7 GPM Injection Rate
 - Large Volume 175 Gallon Mix Tank
 - 12 Volt Gear Reduction Mixer
- Designed for Trouble-Free Operation
 - Reliable 11 HP Honda Electric Start Engine
 - Critical Components Are Stainless Steel & Polypropylene
- Completely Self-Contained and DOT Approved Transportable
- Personalized, Experienced Support Service as Close as Your Phone

CHEMIGATION SYSTEMS INTERNATIONAL, INC.

Corporate Offices: P.O. Box 247
(608) 297-2041

Montello, WI 53949
FAX: (608) 297-7248

Call us today for the dealer nearest you, or contact:

Skip Tenpas
Central Sands Irr. & Bldg., Inc.
Hwy 51 & 73 Interchange
Plainfield, WI 54966
(715) 335-6372

Bruce Sunnerberg
AAA Industrial Pump & Ser., Inc.
66 Lake Street
Plympton, MA 02367
(617) 585-2394

NOTICE

Selected exclusive
dealer territories
still available —

Inquiries Invited



Fruit rot. No threat.

 It's hard enough to bring in a good
cranberry crop without the threat of fruit
rot diseases.

That's why cranberry growers are turning to
a better way to control fruit rot. Bravo 720.

Bravo delivers consistent, first-rate control
of all the major fruit rot diseases that threaten
cranberries. Plus leaf and twig blight
(Lophodermium), too.

And that's backed by results of eight years
of testing which show that Bravo 720 is more
effective on fruit rot diseases than all other
fungicides.

What's more, Bravo won't adversely affect
fruit color. Or leave any lingering odor after
application.

And remember, you can apply Bravo with con-
ventional spray equipment or through sprinkler
irrigation. The advanced flowable formulation
of Bravo 720 is easy to handle, easy to mix.

So, this season, use Bravo 720 to protect your
cranberry crop from fruit rot diseases. Just make
your first spray at early bloom and stick to a
regular 10- to 14-day schedule.

End the threat of these fruit rot diseases and
bring in a bigger yield come harvest.

Bravo. Because you give it all you've got.

Fermenta Plant Protection Company,
5966 Heisley Road, P.O. Box 8000,
Mentor, OH 44061-8000.

Bravo® 720.



Always follow label directions
carefully when using agricultural
chemicals.

self

85
68

50
68

43
70

28
71

54
93

83
78

78
85





ated 1.5 m and 12 m from the junctures between 2 cultivars. All pedicels and fruits were counted for

each sample and the fruit set percentage calculated. In the cranberry a flower that does not form a fruit

remains on the plant as an aborted flower and thus flower production can be readily determined many

Table 2. Effect of pollsource on fruit set percentage for several cranberry cultivars. Data from two trials were combined.

Seed Cultivar		Pollen cultivar						Mean of crosses	Self	
		Ben Lear	Bennett	Searles	Gebhardt	Crowley	Stevens			McFarlin
Ben Leaf	Flow. no.		63	63	65	59	42	75	61	85
	% set		58	70	86	71	59	80	73	68
Bennett	Flow. no.	33		36	17	45	34	42	35	50
	% set	88		81	76	58	94	64	75	68
Searles	Flow. no.	9	19		8	48	39	50	29	43
	% set	78	63		38	81	87	80	78	70
Gebhardt	Flow. no.	42	55	66		49	63	22	50	28
	% set	81	80	83		80	89	91	84	71
Crowley	Flow. no.	61	62	55	50		43	47	53	54
	% set	82	85	85	88		84	91	86	93
Stevens	Flow. no.	78	60	67	41	74		79	67	83
	% set	83	77	83	73	76		67	77	78
McFarlin	Flow. no.	89	63	66	93	87	71		78	78
	% set	92	94	94	95	92	94		93	85

Average set of all self pollination - 79%.
Average of all cross pollination - 81%.

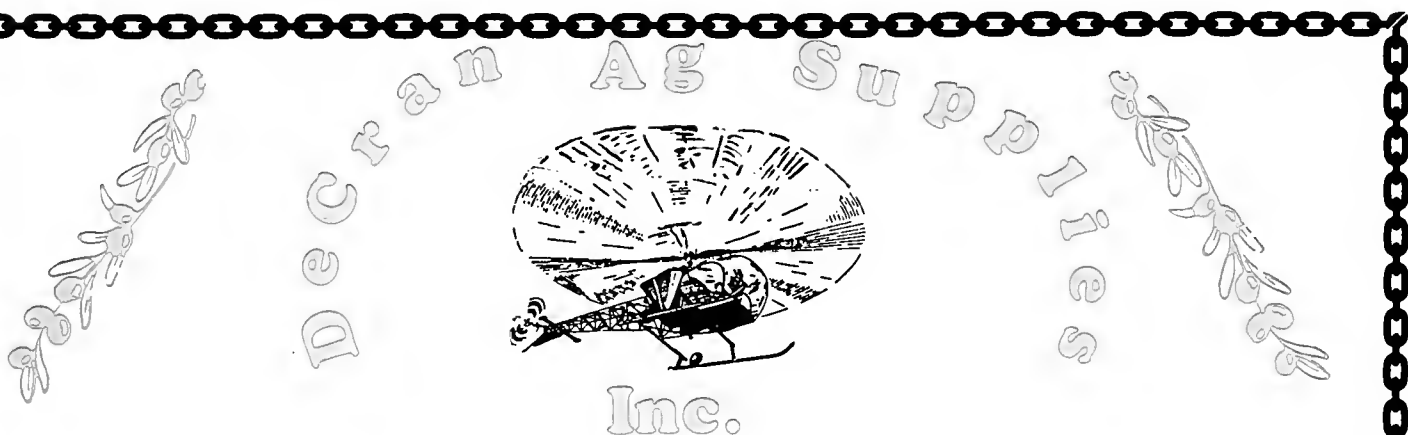

- ★ Complete line of cranberry herbicides, fertilizers, insecticides, fungicides, miticides. In stock when you want them.
- ★ Best application and safety equipment for your needs.
- ★ Quality aerial applications.
- ★ Proven frost warning equipment. Don't take chances — buy the best.
- ★ Experienced cranberry consulting service offering pheromone traps and baits.
- ★ Right to know training.
- ★ Culvert Pipe — All sizes — steel, aluminum, and poly.
- ★ Ditch Mud Mats — Strong — lightweight — durable.
- ★ Burlap Picking Bags — Best for your money.
- ★ Sanding by helicopter.

John C. Decas
William D. Chamberlain
461 Mary's Pond Rd.
Rochester, MA 02770
Office: 295-2731
Evening: 763-8956
Fax: (508) 291-1417

Serving Massachusetts Cranberry Growers

Table 3. Percentage fruit set on samples taken from 6 cultivars in one flooding section. Flowers were all free to self-pollinate with different potentials for cross-pollination.

Receptor cultivar	Nearest cross pollen source	Distance to cross pollen (meters)	Fruit set percentage sample no.					
			1	2	3	4	5	ave.
Berlin	Mammoth	12	64	65	84	58	65	66
Berlin	Mammoth	1.5	80	72	62	74	64	69
Mammoth	Berlin	1.5	55	51	50	53	48	51
Mammoth	Berlin	12	51	55	58	57	52	55
Mammoth	Howes	12	58	81	66	48	53	60
Mammoth	Howes	1.5	51	55	57	50	53	53
Howes	Mammoth	1.5	59	58	64	54	48	56
Howes	Mammoth	12	60	76	61	65	60	65
Howes	McFarlin	12	51	48	52	59	52	52
Howes	McFarlin	1.5	59	65	62	63	60	61
McFarlin	Howes	1.5	57	52	59	59	63	58
McFarlin	Howes	12	55	53	61	64	45	55
McFarlin	Searles	12	52	57	64	50	46	53
McFarlin	Searles	1.5	62	60	61	53	57	58
Searles	McFarlin	1.5	60	61	71	56	60	62
Searles	McFarlin	12	56	59	63	58	55	58
Searles	Vose's Pride	12	63	63	59	64	60	61
Searles	Vose's Pride	1.5	72	71	75	67	64	70
Vose's Pride	Searles	1.5	53	61	52	61	55	56
Vose's Pride	Searles	12	53	60	66	56	48	56

months after the petals have fallen.

The fruit set percentages from 100 field samples are shown in Table 3. There is no evidence that proximity of a cultivar to a source of cross pollen influenced fruit set percentage.

Greenhouse and field data show no benefit to fruit set percentage from several cross pollen sources. Benefits to yield will come from improved pollination, not from more cross pollination.

Literature Cited

1. Bain, H.F. 1933. Cross pollinating cranberry. *Ann. Rpt. Wis. State Cranb. Grow. Assn.* 47:7-11.
2. Filmer, R.S., P. Marucci, and H. Moulter. 1958. Seed counts and size of cranberries. *Proc. Amer. Cranb. Grow. Assoc.* 88:22,26-30.
3. Hall, I.V. and L. E. Aalders. 1965. The relation between seed number and berry weight in the cranberry.

Can. J. Plant Sci. 45:292.

4. Marucci, P.E. 1966. Cranberry pollination. *Cranberries* 30(9):11-13.
5. Marucci, P.E. and R.S. Filmer. 1964. Preliminary cross pollination tests on cranberries. *Proc. Amer. Cranb. Grow. Assoc.* 91-94:48-51.

6. Rigby, Bruce and M.N. Dana. 1971. Seed number and berry volume in cranberry. *HortScience* 6:495-496.

¹Professor and graduate assistants. Present addresses: Ms. Steinmenn, Box 185, Bareveld, WI 53507.

**WISCONSIN CRANBERRY
HEADQUARTERS FOR
SEVIN XLR**

DEVIRINOL 10G * EVITAL * GUTHION
DIAZINON 14G * PARATHION * ETHREL



Cole/Grower Service
537 Atlas Ave., P.O. Box 7211, Madison, WI 53707
(608) 221-6204 or 1-800-362-8049

Ocean Spray, Decas Firm Reach a Settlement

A bloody, protracted, expensive court battle was averted recently when Ocean Spray and the Decas Cranberry Co. of Wareham, Mass., reached a settlement in the antitrust suit brought by Decas more than a year ago.

Specific terms of the settlement were not released but it was disclosed that Ocean Spray will supply Decas with unspecified quantities of berries for juice and other products for up to 12 years.

Both sides agreed not to comment on any details beyond what was included in a general press release.

Robert St. Jacques, chairman of the board of directors of Ocean Spray, said, "We are pleased with the settlement."

The suit was filed in federal court in Boston.

Besides the supply of cranberries, Ocean Spray agreed to provide Decas with new technology for processing the fruit. The exact nature of the technology was not disclosed.

Regarding the supply of berries over 12 years, one medium sized Ocean Spray grower, who declined to speak for the record, quipped, "Does this mean in 12 years' time Ocean Spray will have to subsidize Decas again?"

Ocean Spray's Name Brought Into Wright Investigation

Ocean Spray became one of many companies and individuals whose names have been dragged into the House ethics committee's inquiry into the conduct of House Speaker

Jim Wright, CRANBERRIES has learned.

According to documents compiled by the committee, formally known as the House Committee on Standards of Official Conduct, Ocean Spray was among the companies which purchased copies of Wright's book, "Reflections of a Public Man," in lieu of honoraria payments for speeches delivered by the Texas congressman.

Wright has been accused of seeking royalty fees for the books

instead of the usual honoraria payments in order to evade House rules on income disclosure.

Wrote Bob Mitchell of *The (Wisconsin Rapids, Wisc.) Daily Tribune* Washington Bureau in an April 18 report: "Neither Ocean Spray nor Edward Cassidy, the Washington lobbyist who acted as Ocean Spray's intermediary in dealings with Wright, were aware of any impropriety in the book purchase, Cassidy spokesman Roy Meyers said...."



Equipment Inc.

381 West Grove Street (Rte. 28)
Middleboro, MA 02346

KUBOTA

Diesel Equipt.

Tractors 2 & 4 wheel drive — 12-90 hp.

Compact Excavators 1½ to 6 ton

Wheel Leaders ½ to ¾ yd.

Water Cooled Diesel Engines 4 to 104 hp.

All Types of Implements

Polymark Beaver-Mowers **947-6299**

Specialty Fabrication Work

Kubota Financing as Low as 8½%

*Sales *Service *Parts *Leasing

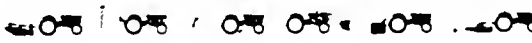

WANTED

Gravel & Sand

in the southeastern Massachusetts area

Quantities of 10,000 yards and up

Complete site work, bog construction and finished contouring of surrounding area plus the best price for your material.

Michael Coan
Carver, Mass.
(508) 866-5285

Earl White
Medfield, Mass.
(508) 359-7291

LIFT PUMPS

Trailer or Permanent
Electric, Tractor or
Engine Driven

PHIL HELMER
(715) 421-0917

OCEAN SPRAY FILM RECEIVES AN AWARD

Ocean Spray recently received the More Than Two Million film and video award from Modern Talking Picture Service for its educational film, "Where the Cranberries Grow."

The award is in recognition of the film having been seen by more than 2 million students in schools throughout the country.

Herbert "Skip" Colcord, manager of consumer affairs for Ocean Spray, was the executive director of the original film project. He accepted a special plaque from Ken Fry, account executive of Modern, at a presentation at Ocean Spray headquarters in Plymouth.



*Lambert, Lee
& Associates*

CONSULTING ENGINEERS
SURVEYORS

Extensive experience in all aspects of cranberry land development: evaluation, purchase, survey, design, permit acquisition, phased construction and planting both in wetlands and uplands.

Have references. Will travel.

Contact: Will Lee
10948 Highway 54 East
Wisconsin Rapids, WI 54494
(715) 424-3131

Niemi Electric Company



Robert
Niemi
Electrical
Contractors

Heat, Light & Power Wiring

- RESIDENTIAL
- COMMERCIAL
- INDUSTRIAL

Pinehurst Drive
Wareham, Mass.
TEL. 295-1880

22 years experience   construction lifts 



AERIAL LIFTING

◦ BERRY LIFTING ◦
nylon berry bags
bulk bins

◦ MUD LIFTING ◦
NEW MATS

lightweight
durable

contact
PETER or CHUCK
508-295-2222

BEATON'S
CRANBERRY
GROWERS SERVICE



mat rentals & sales

REGIONAL NOTES

MASSACHUSETTS

By IRVING E. DEMORANVILLE

As of April 1, there were 2 points of a possible 10 that favored keeping quality in the 1989 Massachusetts crop.

The forecast was for poor keeping quality. This was a good year to consider holding late water on some acreage for quality control. Early water bogs should have had fungicide treatment applied at the proper time.

Our present cultural practices tend toward a more concentrated growth of vines, which favors fungi buildup and infection. Fungicide treatments are always a good investment.

WASHINGTON

By EDITH A. SHIRE

Dr. Carl H. Shanks Jr., superintendent and entomologist at the Washington State University/Vancouver Research & Extension Unit, has assumed the duties of interim manager of the Long Beach Research & Extension Unit until a replacement is found for the retired Azmi Y. Shawa.

March 28 marked the start of Washington State University's centennial celebration.

In observance of the event, the Long Beach Research & Extension Unit held an open house. On display was an antique courting buggy built in the late 1800's, which was shipped aboard the British registered steamer, "Bawnmore," out of Canada and bound for Peru. The ship foundered in heavy seas and fog approximately 13 miles south of Bandon, Ore., on Aug. 13, 1895.

Only three items, the buggy, built by the Lewis and Stover Co. of Portland, Ore., a grand piano and a well bred red bull, which swam to shore, were ever recovered from the ship's wreckage. The grand piano is now on display in an Oregon museum and the red bull's descendants graze the hillside pastures of the south coast.

The Beach Bandits 4-H Club of the Peninsula featured a display of horse and harness items from the early 1900's. The WSU cooperative extension's Master Gardeners also took part in the open house.

WISCONSIN

Ron Arendt, a part-time beekeeper from Nekoosa, spoke to Sacred Heart pupils about his hobby. Among the facts he cited was an estimate that bee pollination contributes \$20 billion annually to the agricultural economy.



Equipment, Inc.

**381 West Grove St. (Rte. 28)
Middleboro, MA 02346**

(508) 947-8299

KUBOTA

**Tractors, Excavators and
Diesel Generators**



**Wheel Loaders
3/4 Yd - 6 1/2 Yd**

malcon

Screening Equipment

HONEY BEES AVAILABLE FOR

Pollination

- ★ 25,000 Strong Colonies Available
- ★ State and Federal Inspected
- ★ Cranberries, Blueberries, Etc.
- ★ 72 Hour Delivery East of the Mississippi River
- ★ Radio Dispatched Trucks

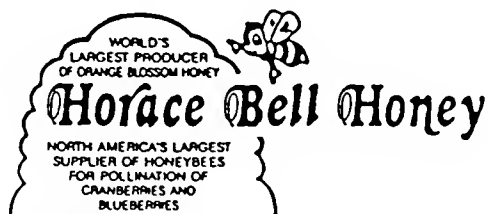

Lamar Hester
General Manager 734-3276 Evenings

1058 S. Ridgewood Ave.
DeLand, Florida 32720

Office: (904) 734-7798
736-3841
734-5043

Cranberry Display Wins Prize At Horticulture Society Show

The Cape Cod Cranberry Growers' Association produced an award winning exhibit at the recent New England Flower Show put on by the Massachusetts Horticulture Society.

The exhibit, "Cranberry Growing: Creating and Protecting Wetlands," captured two blue ribbons and two medals, along with the rapt attention of 180,000 people thankful for signs of spring.

The many details of cranberry culture on display included a bog in partial bloom, with its reservoir, a beehive and wetlands. Native species forced into full bloom added to an environmentally positive image.

The display earned a silver medal for its high quality plant material, including northern pitcher plants in full bloom, checker berries, willow, bayberry, lady slippers, blueberries and lichen.

The exhibit was designed by Jack and Dot Angley, Dawn Swanberg and Linda Everett. Ray Mello provided equipment and manpower, Chris Geldmacher engineered the water containment sections. Plant material was developed by Linda Kunhart, with Peter and Douglas

Beaton.

Teams of CCCGA members manned the exhibit and answered questions during the 10 days of the flower show. Two of the most often asked questions were, "Why do you flood the cranberry bogs?" and, "Do cranberries grow in fresh or salt water?"

In another recent promotional event, the Cranberry Connection donated 50 copies of the Crimson Harvest video to Plymouth County schools. The cranberry growing documentary was produced by the CCCGA as part of its 100th anniversary celebration.

—Carolyn Gilmore

Financial Strength. . .

Personalized Service.

Isn't That What You Need In A Bank?

The Jackson County Bank has supported agriculture in the area for more than 110 years.

We recognize the importance of the cranberry industry and are pleased to provide financial services for all your banking needs.

We're large enough to serve you and yet we offer personalized service which your business demands. Call us at 715-284-5341

The Jackson County Bank. A name to count on throughout the years.

You'll like the difference.



**JACKSON
COUNTY
BANK** Member FDIC
(715) 284-5341

Black River Falls, Alma Center, Hixton, Merrilan, Taylor, WI 54615

PORTABLE MICROSCOPES

Professional, inexpensive microscopes for examination of plants in the field for:

SOUTHERN RED MITE * PARASITIZED FRUITWORM EGGS
NEMATODES * TIPWORM LARVAE IN UPRIGHTS

Two models, 25x fixed or 18-36x variable magnification. Sold with a 20-day trial guarantee. Call for our complete catalog, references, prices.

PEST MANAGEMENT SUPPLY INC.

P.O. BOX 938

AMHERST, MA 01004

800 272-7672

413 253-3747 (in Mass.)



Weather

MASSACHUSETTS

March was on the cool side, averaging 0.8 degrees a day below normal—the coolest since 1984. Maximum temperature was 59 degrees on the 26th and minimum 11 degrees on the 7th. The month was very cold for the first two weeks and warmer than normal for two short periods during the middle and near the end.

Precipitation totaled 4.17 inches, or about 2/3 inch below normal. There was measurable precipitation on nine days, with 1.60 inch on the 24th and 25th as the greatest storm. We are 3½ inches below normal for the first three months of 1989 and about 4¼ inches behind 1988.

I.E.D.



CREATORS of the prizewinning exhibit were, l. to r., Dot and Jack Angley, Dawn Swanberg and Linda Everett.



JACK ANGLELY raises the plank which activated the water pump that transferred water from the miniature swamp to the miniature logs. Looking on is Peter Beaton, who helped with the plant material for the project.

(CRANBERRIES photo by Linda Everett)

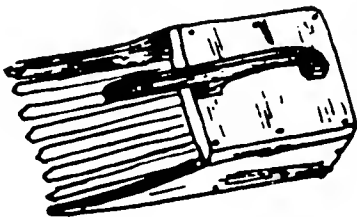

CRANLAND SERVICES

Cranberry Property Appraisals

★ ★ ★ ★ ★

Listings and Sales of Cranberry Properties.

License # 68987

Lawrence W. Pink
Old Cordwood Path
Duxbury, MA 02332
(617) 934-6076

Pump Repairs & Sales

All Types

- Field Service
- Chemigation Equipment Sold
- Demonstration by Appointment

AAA Industrial Pump Service Inc.

Bruce Sunnerberg
66 Lake Street
Plympton, MA 02367
(617) 585-2394



Gapen Realty

Cranberry Marsh **FOR SALE**

•6 acres planted, •17 acres ready
to be planted •3 homes
\$175,000

Washburn County, WI
2141 8th Street South
Wisconsin Rapids, Wisconsin 54494
(715)423-6550

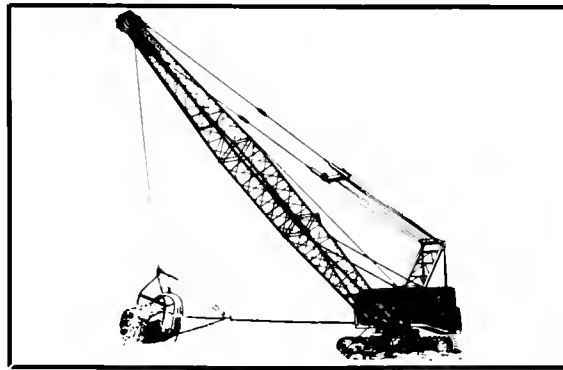

Krause Excavating, Inc.

Canal Work

Ditching

Pond Construction

Land Clearing

1-1/4-3 yd. draglines with 80' boom and matts, 2 yd.
backhoe, swamp dozer and other related equipment.

Contact:

Roger Krause 1-414-398-3322
Route 3 Markesan, Wis. 53946

Wanted

Wisconsin Cranberry
Grower wishes to purchase
an existing cranberry marsh.

STEVE

(715) 421-0917
(715) 593-2385

Irrigation Equipment Designed Especially for the Cranberry Industry

- Gorman-Rupp Self Priming Electric Sprinkler Pumps
- Proven Quick Couple Riser
- Polyethylene Main Lines, 3" - 12"
- Butt Fusion Equipment Available
- Paco/Wemco Water Harvest Pump
- Berkeley Self-Priming and Centrifugal Pumps

A Most Complete Inventory of Irrigation Accessories

LARCHMONT IRRIGATION / SNOWMAKING

P.O. Box 66, 11 Larchmont Lane
Lexington, Massachusetts 02173 (508) 862-2550

Contact

Larchmont Engineering
Phil Tropeano, President
(508) 862-2550
(Call Collect)

Stearns Irrigation, Inc.
790 Federal Furnace Rd.
Plymouth, MA 02360
(508) 746-6048

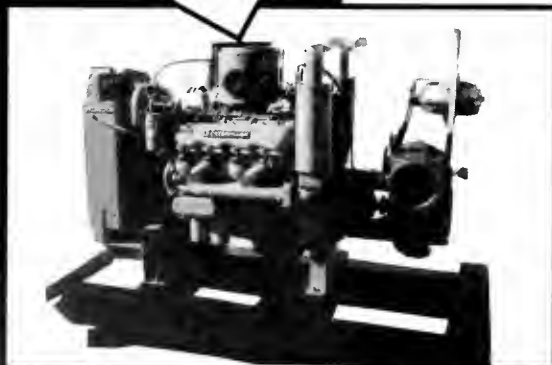
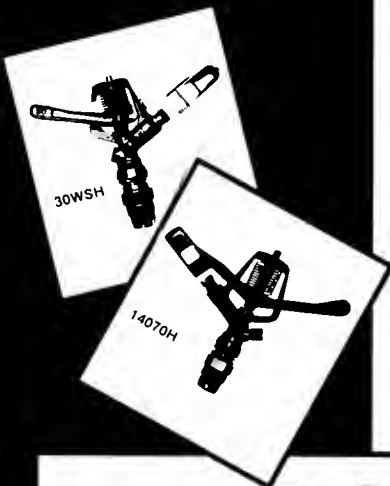

WOLLSCHLAGER EXCAVATING

Dragline Work — All Kinds

Also Have Clam & Scalping Buckets

Route 1 Necedah, WI 54646
1-808-565-2436



CEECO CORPORATION OF NEW ENGLAND

Industrial Suppliers To The Cranberry Industry



Chain, Cable and Accessories
Used for Making Mats

All Types of Fasteners (Bulk & Packaged)

Hand Tools	Pumps
Power Tools	Motors
Chemicals	Abrasives
Lubricants	Cutting Tools
Safety Equipment	

Richards Rd. 747-0086
Plymouth Industrial Park Plymouth, MA 02360

J.A. JENKINS & SON CO.

Grower Service

MOWING (ALL TYPES)
SANDING

DITCHING
WEED WIPING

Serving Cape Cod

227 Pine St., W. Barnstable, Ma. 02668

Phone 362-6018



YANKEE PLANNERS, INC.

59 North Main Street
Middleboro, MA 02346
(508) 947-0527

Sound and Objective
Advice
Suited to
Your Needs

- Tax and Estate Planning
- Investment & Insurance Review
- Business Continuity
- Asset Protection
- Key Employee Retention
- Business Tax Analysis

Mr. William H. Bestgen, Jr.
Chartered Financial Consultant

Mr. Peter W. Hutchings
Attorney at Law practicing as
a Tax Attorney

Mr. Roger H. Parent, Jr.
Accountant, Enrolled to Practice
before the Internal Revenue
Service

Call For Your Free Brochure
(508) 947-0527

Census Shows Farm Number Has Increased In Bay State

Contrary to the steady decline in the number of farms nationwide in this century, the recent U.S. Census

Bureau's 1987 agricultural survey showed that farms in Massachusetts—the leading cranberry producer in the country—have actually increased since the last census in 1982.

The 6,216 farms in Massachusetts were 15 percent more than in 1982, according to the census figures released recently.

When farm size and value of products sold is considered, however, it is clear that many of the farms are marginal and part-time. Fifty two percent of the farms contain 1 to 49 acres. The value

of products was under \$10,000 for almost 60 percent of the farms.

Some 42 percent of the farms had 1987 sales of \$10,000 or more and 12 percent had sales of \$100,000 or more.

EUGENE LOPES DIES AT 51

Eugene P. Lopes, 51, of Boston, Mass., who worked in southeastern Massachusetts cranberry bogs, died March 4 at Boston City Hospital after a long illness. He was born in Hanson, Mass., son of the late Manuel and Dominga (Spinola) Lopes.



VOLM BAG COMPANY, INC.

1804 EDISON ST. BOX B, ANTIGO, WIS. 54409-0116
PHONE 715/627-4826

SUPPLYING AGRICULTURAL CHEMICALS

BRAVO - SEVIN - FUNGINEX - ORTHENE
CASORON - GUTHION - DEVRINOL - PARATHION

AND

**DELIVERING A COMPLETE LINE OF FERTILIZER
WITH FAST FRIENDLY SERVICE!!!**

**The
CHARLES W. HARRIS
Company**

451 Old Somerset Avenue
North Dighton, Mass.
Phone (508) 824-5607

AMES
Antisiphon Devices
RAINBIRD
Sprinklers
HALE
Pumps

*Highest Quality Products
With Satisfaction Guaranteed*



**MIDDLEBOROUGH
TRUST COMPANY**

The Business Bank.

MTC offers you business banking built to your needs.
Personal attention to your special
financial requirements now and as you grow. Cooperation.
Flexibility. Complete business and personal banking.
Member FDIC



Main Office

10 John Glass, Jr. Square, Middleborough

Branch Offices

Middleboro Square, Rt. 28, Middleborough • Middleboro Plaza, Middleborough
Cranberry Plaza, East Wareham • Carver Square, Carver • Trucchi's Plaza, Taunton
Telephone all offices **947-1313**

BOG BOOM

To harvest your cranberries with less labor and more efficiency, Containment Systems offers our new BOG BOOM.

BOG BOOM

CRANBERRY HARVESTING FLOATING BOOM

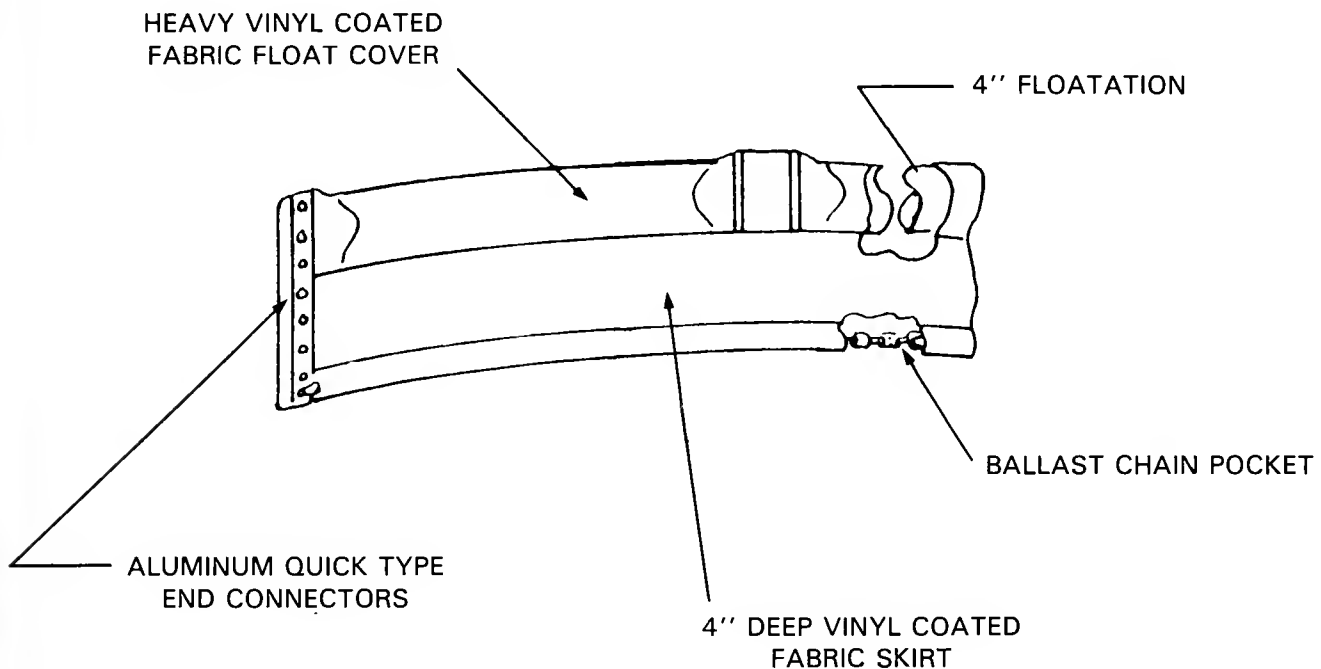

Bog boom is tough, with a shorter skirt designed for the shallower bogs. The solid PVC skirt improves the strength and durability of our boom.

Bog Boom is manufactured in 50 foot and 100 foot lengths. Multiple lengths can be connected together without tools.

Accessories available - Tow Bridle assemblies and fabric repair kits.

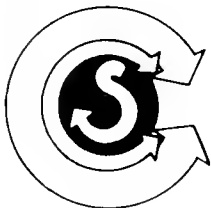

CONTAINMENT SYSTEMS

P.O. Box 1390 COCOA, FLORIDA 32923

(407) 632-5640

Take Good Care of Yourself Have an Ocean Spray!



The farmer's cooperative that brings you
a wide range of natural fruit juices, drinks and sauces
Ocean Spray Cranberries, Inc., Plymouth, Massachusetts 02360
An Equal Opportunity Employer

13
7
2r

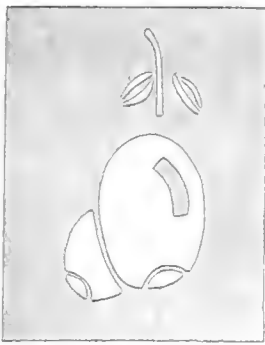

CRANBERRIES
THE NATIONAL CRANBERRY MAGAZINE
July 1989 Vol. 53, No. 7



Best Grower Awards

Potassium Analysis

^s Blueberry

UNIT OF MASS LIBRARY
SERIALS DEPT
AMHERST MA 01003
MISS
LIBRARY



**SPARGANOTHIS
FRUITWORM**—A most
destructive insect, for there
are two generations. The
first generation feeds on
foliage and blossoms and
the second generation has
an enormous capacity for
eating and mining the
berries.

Know the Insects

The major cranberry insects: cranberry girdler, the fireworms, tipworm, blossom worm, cranberry fruitworm and Sparganothis fruitworm.

Know the Insects

The periodic cranberry insects: cranberry scale, fire beetle, blossom weevil, armyworm and bluntnose leafhopper.

Know the Insects

Color photographs of all these insects and more are now arranged with text in a portfolio that is available.

The portfolio endeavors to bring together the words of research complementing the photographs and making a summary of cranberry insect information that will be of use to the cranberry grower for a lifetime.

The portfolio is available for \$100 and, if you wish to examine a copy, telephone (609) 894-8556 evenings around 6 p.m. or write to:

**Walter Z. Fort
P.O. Box 183
Pemberton, NJ 08068**

Ocean Spray Honors Bay State Growers

By CAROLYN GILMORE

At a recent Massachusetts growers' dinner, Ocean Spray presented two awards for excellence in 1988 crops.

David Melville received the processed fruit grower award for his high quality, wet harvested crop. Lawrence and Paul Harju received the 1988 fresh fruit award. The three recipients have their bogs in Middleboro.

The selections were based on a number of criteria developed by a committee of growers in cooperation with Ocean Spray management. The committee was chaired by Jim Jenkins.

For each category, participating growers received points that were tallied by computer. The awards went to growers with the highest total score.

The processed fruit award earned by Melville was determined by the following characteristics: lowest average trash, highest anthocynin, best quality and highest usable fruit, number of barrels per acre and overall bog management practices.

The major determinant for the fresh fruit award earned by the Harju brothers was quality in storage after three weeks. Crops also were graded on quality at delivery, consistent quality of past crops,



LARRY HARJU, right, of Middleboro, Mass., listens as Jim Jenkins, chairman of the Massachusetts Ocean Spray Cranberry Advisory Committee, reads a certificate naming Larry, and his brother, Paul, Massachusetts Growers of the Year for Fresh Fruit.

number of years of continuous fresh fruit growing, and overall growing practices.

The Harju bog has been dry harvested since 1910. The Harjus use a modified Furford dry picker that is gentle on berries.

Jenkins noted that the awards will be given annually and that

winners will be eligible to compete again.

Larry Harju recently was voted a director on the board of Ocean Spray Cranberries.

Melville's daughter, Lynn, accepted the award for her father.

Close to 500 growers attended

(please turn the page)

COVER PHOTO

WINNERS: David Melville, named Massachusetts Processed Fruit Grower of 1988 by Ocean Spray, and Mrs. Melville pose at their prizewinning bog. Lawrence and Paul Harju received the 1988 Fresh Fruit Award. A story about the contest appears on this page.

(CRANBERRIES photo by Carolyn Gilmore)



VOLM BAG COMPANY, INC.

1804 EDISON ST. BOX B, ANTIGO, WIS. 54409-0116
PHONE 715/627-4826

SUPPLYING AGRICULTURAL CHEMICALS

BRAVO - SEVIN - FUNGINEX - ORTHENE
CASORON - GUTHION - DEVRINOL - PARATHION

AND

**DELIVERING A COMPLETE LINE OF FERTILIZER
WITH FAST FRIENDLY SERVICE!!!**

the ceremony.

Winners were selected from six growing areas: Cape Cod, Middleboro, Carver, Plymouth, Wareham and Duxbury. A grower from each area served on the awards committee.

"This is the first time we've given

a Massachusetts Grower of the Year Award," said Jenkins. "We wanted to start a program this year to recognize those growers who bring in the best quality fruit each season and to encourage each other to grow better fruit."

The winners received a certificate and a "Massachusetts Grower of the Year" sign to put in their bogs. Their names will be placed on a plaque that will hang in the lobby of Ocean Spray's headquarters in Lakeville-Middleboro.



NEW FACE at the Massachusetts Cranberry Experiment Station belongs to Dr. Anne Averill.

(CRANBERRIES photo by Carolyn Gilmore)

Entomologist Joins Experiment Station

By **CAROLYN GILMORE**

Dr. Anne Averill, assistant professor at the University of Massachusetts Department of Entomology, has been assigned to small fruit extension at the Cranberry Experiment Station in East Wareham.

She and Dr. Frank Caruso of the station will lead the university's integrated pest management (IPM) program in cranberries.

Some of the projects Dr. Averill will be involved with include pesticide effectiveness, timing and alternatives for tipworm control; four different strains of nematodes to control white grub; pheromone disruption experiment for sparganothis fruitworm.

An opening for IPM coordinator is expected to be filled in early 1990.

"IPM is an important program but I believe what is most important is baseline data on insects," Dr. Averill said.

Growers are particularly interested in tipworm research at this time, she noted.

Dr. Averill is a 1976 graduate of Smith College with a degree in biology. She received her Ph.D. in insect behavior and ecology from the University of Massachusetts in 1982.

She also earned a post doctoral degree in chemical ecology of insects and influences on insect management from Cornell University.

The University of Massachusetts

assistant professor has published extensively.

CRANBERRY



COMPUTER, INC.

CRANWARE

- Growers
- Handlers
- Chemical Applications
- Chemical Resale

(508) 747-3033

P.O. Box 1037, Plymouth, MA 02360

CRANBERRIES

THE NATIONAL CRANBERRY MAGAZINE

SEND CORRESPONDENCE TO:

**P.O. BOX 249
COBALT CT 06414
(203) 342-4730**

Fax #: (203) 342-1977

PUBLISHER & EDITOR: BOB TAYLOR

**ASSOCIATE EDITOR: CAROLYN GILMORE
(508) 763-5206**

ADVISORS & CORRESPONDENTS

MASSACHUSETTS — Irving E. Demoranville, Director, Cranberry Experiment Station

NEW JERSEY — Phillip E. Marucci, Cranberry & Blueberry Specialist, Buddtown; Elizabeth G. Carpenter, Chetsworth

NOVA SCOTIA — Robert A. Murray, Horticulturist, Berry Crops, Research Station, Truro

OREGON — Arthur Poole, Coos County Extension Agent, Coquille

WASHINGTON — Azmi Y. Shawa, Horticulturist, former retired Director, Coastal Washington Research & Extension Unit, Long Beach

WISCONSIN — Tod D. Planer, Farm Management Agent, Wood County

CRANBERRIES is published monthly by Diversified Periodicals, Wallwyn Drive, Portland CT 06480. Second class postage is paid at the Portland, Conn. Post Office. Price is \$15 year, \$28 for two years, \$2 a copy in the U.S.; \$17 a year Canada; \$20 a year in all other countries. Back copies: \$2.5 including postage. Copyright 1988 by Diversified Periodicals

ISSN: 0011-0787

Postmaster, send Form 3749 to:

**CRANBERRIES
P.O. BOX 249
COBALT CT 06414**

The Pilgrim stands behind
every commercial loan
Ronald Croacher
makes.

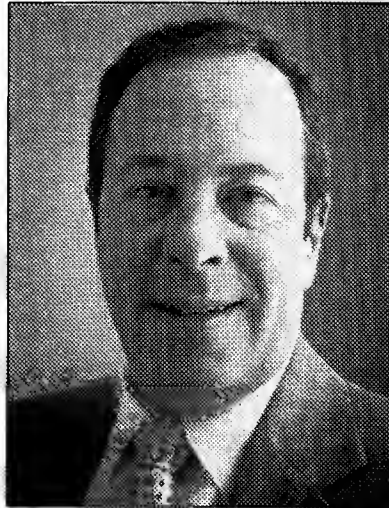

And that's a
promise.

Call him on it at 946-1778.

The Pilgrim is a symbol of strength, integrity and experience; and it best personifies the resources Ronald Croacher offers every business that turns to him for help.

An Assistant Vice President and Commercial Loan Officer, Ronald has over 25 years of banking know-how. His expertise has helped to earn us a reputation as The Answer Bank.

Backed by the superior lending capabilities of Plymouth Savings Bank, Ronald can design a commercial lending package with the attractive rates and fast turnaround time that you need.

This is the power and the promise of the Pilgrim.

Call Ronald Croacher at 946-1778.

Main Office: Wareham, (508) 295-3800;
Cotuit, (508) 428-1300; Duxbury, (617) 934-0101;
Falmouth, (508) 548-3000; Marion, (508) 748-2919;
Mattapoissett, (508) 758-4936; Middleboro, (508) 946-1777;
North Plymouth, (508) 747-1600; Plymouth, (508) 746-3300;
Sandwich, (508) 888-4444; Teaticket, (508) 540-5002

Plymouth
 **Savings**
 **Bank®**

Member FDIC/DIFM



JEFFREY CARLSON is the new executive director of the Cape Cod Cranberry Growers' Association.
(CRANBERRIES photo by Carolyn Gilmore)

New CCCGA Director Puts Stress on Action

By **CAROLYN GILMORE**

Jeffrey Carlson, the recently appointed executive director of the Cape Cod Cranberry Growers' Association, would like to see growers develop a "proactive strategy" that will insure a healthy agricultural economy.

"We have a real opportunity to take more control of the future and to be part of the process rather than waiting for regulations to be drafted

and reacting to them," he said.

Carlson replaces Dr. Dwight Peavey, who served for a year. Peavey's contract was not renewed.

The CCCGA is seeking an executive secretary and office space independent of the Massachusetts Cranberry Experiment Station.

Carlson previously served as chief of the Massachusetts Department of Food and Agriculture's Pesticide Bureau for five years. He repre-

sent the department on the state's Water Resources Commission and also served on the federal advisory committee to the Environmental Protection Agency on issues dealing with pesticide disposal and groundwater.

The new CCCGA executive director earned a degree in environmental engineering from the University of Massachusetts in 1976.

He will be retained as a consultant to Ocean Spray Cranberries from time to time.

Pump Repairs & Sales

All Types

- **Field Service**
- **Chemigation Equipment Sold**
- **Demonstration by Appointment**

AAA Industrial Pump Service Inc.

Bruce Sunnerberg
66 Lake Street
Plympton, MA 02367
(617) 585-2394

Niemi Electric Company



Robert Niemi
Electrical Contractors

Heat, Light & Power Wiring

- **RESIDENTIAL**
- **COMMERCIAL**
- **INDUSTRIAL**

**Pinehurst Drive
Wareham, Mass.
TEL. 295-1880**



THE BEST — IN EVERY RESPECT

CRANBERRY Model 400 GT

Precision Chemigation System



- Developed *Exclusively* for the Cranberry Industry
- Exceeds or Meets ALL Current EPA Requirements
- Simple to Operate and Easy to Calibrate
 - Self-Timer Application (1 minute Increments)
 - Easy Access Handle & Simple Reference Scale
 - Precise Visual Flow Calibration
- Outstanding Field Performance
 - Down-Line Venturi Injection System
 - High Capacity 0-7 GPM Injection Rate
 - Large Volume 175 Gallon Mix Tank
 - 12 Volt Gear Reduction Mixer
- Designed for Trouble-Free Operation
 - Reliable 11 HP Honda Electric Start Engine
 - Critical Components Are Stainless Steel & Polypropylene
- Completely Self-Contained and DOT Approved Transportable
- Personalized, Experienced Support Service as Close as Your Phone

CHEMIGATION SYSTEMS INTERNATIONAL, INC.

Corporate Offices: P.O. Box 247
(608) 297-2041

Montello, WI 53949
FAX: (608) 297-7248

Call us today for the dealer nearest you, or contact:

Skip Tenpas
Central Sands Irr. & Bldg., Inc.
Hwy 51 & 73 Interchange
Plainfield, WI 54966
(715) 335-6372

Bruce Sunnerberg
AAA Industrial Pump & Ser., Inc.
66 Lake Street
Plympton, MA 02367
(617) 585-2394

NOTICE

Selected exclusive
dealer territories
still available —

Inquiries Invited

Critical Concentration of Potassium in 'Stevens' Cranberry

MALCOLM N. DANA and SUE STEINMANN¹

Department of Horticulture, University of Wisconsin/Madison

Abstract. Cranberry, *Vaccinium macrocarpon* Ait., cuttings were grown in solutions with graduated levels of potassium and adequacy levels of other mineral elements. Vegetative growth (dry weight) was not restricted in shoots with foliar K level above 0.26% dry weight. Levels of K in the tissue ranged from 0.21% to 0.85%. Cuttings without added K in the solution died after 16 weeks of continuous growth.

Foliar analysis offers a potentially convenient method for measuring the nutrient status of cranberry plants. Interpretation of foliar analysis data requires the use for comparison purposes of previously established standards or critical levels for each element. Foliar levels of K found in the field have been reported by several workers as follows: 0.19-0.83% in British Columbia (4) on a young planting; 0.50-0.54% in Nova Scotia (7); 0.38-0.73% in Nova Scotia (8); 0.23-0.37% in British Columbia (5) on a mature planting; 0.4-0.6% in Oregon (1); and 0.6-1.25% in Wisconsin (3). Symptoms of deficiency were not reported for any of the sample areas for which shoots were taken for analyses. One report (6)

suggested that the critical concentration is below 0.34% while another (2) suggests optimum levels at 0.50-0.90%. Both reports were based on analyses of field grown cranberry plants. No visual evidence of deficiency symptoms were evident.

Dormant cuttings of 'Stevens' cranberries were taken from the field in early spring and rooted in aerated distilled water. Two liter black plastic pots fitted with 2 cm. thick styrofoam covers with 8 holes for holding 1 cranberry cutting each were used. Cuttings 10 cm. long were set with 4 cm. in the solution. Upon initiation of rooting and emergence of the first shoots on the cuttings the distilled water was replaced with solutions of mineral

nutrients.

The nutrient solution at the start of each cycle contained 100 ppm NH₄-N and 49-61 ppm NO₃-N, 30 ppm P, 48 ppm Mg, 70 ppm Ca, 76 ppm S, .27 ppm each of B and Mn, .13 ppm Zn, .03 ppm Cu, .01 ppm Mo, 4.0 ppm Fe in equal concentrations from Fe So₄ and Fe EDTA. Potassium concentrations were adjusted by additions of K NO₃, to

Bog For Sale

- 10 acres working bog
- 5 acres upland
- excellent water supply

(617) 293-5353

Irrigation Equipment Designed Especially for the Cranberry Industry

- Gorman-Rupp Self Priming Electric Sprinkler Pumps
- Proven Quick Couple Riser
- Polyethylene Main Lines, 3" - 12"
- Butt Fusion Equipment Available
- Paco/Wemco Water Harvest Pump
- Berkeley Self-Priming and Centrifugal Pumps

A Most Complete Inventory of Irrigation Accessories

LARCHMONT
IRRIGATION / SNOWMAKING

P.O. Box 66, 11 Larchmont Lane
Lexington, Massachusetts 02173 (508) 862-2550

Contact

Larchmont Engineering
Phil Tropeano, President
(508) 862-2550
(Call Collect)

Stearns Irrigation, Inc.
790 Federal Furnoce Rd.
Plymouth, MA 02360
(508) 746-6048

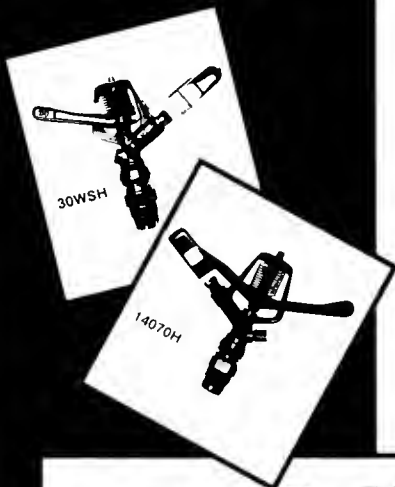

Table 1. Potassium concentration and dry matter production for 'Stevens' cranberry plants grown in solution culture.

K supply (mg)	First cycle		Second cycle		Third cycle	
	Tissue K (%)	Dry matter (g)	Tissue K (%)	Dry matter (g)	Tissue K (%)	Dry matter (g)
0	.26a	1.9a	.15a	0.9a	-	-
4	.32a	2.1a	.20ab	2.6b	.18a	2.4a
8	.45b	2.3a	.26b	3.3c	.24bc	3.5b
12	.60c	2.0a	.36cd	3.6cd	.27bcd	4.6c
16	.57c	2.7a	.34c	4.1de	.27bcd	5.6d
20	.78d	2.2a	.41d	4.3e	.30de	5.6d
24	.85d	2.2a	.48e	4.2e	.34e	6.2d

^z Mean separation in columns by Duncan's multiple range test, 5% level.

give solutions with 0, 2, 4, 8, 10, and 12 ppm. The 2 liter containers, therefore, contained 0, 4, 8, 12, 16, 20, and 24 mg K, respectively. Water levels were maintained during the experiment by additions of distilled water. Solution reaction was maintained at pH 4.5 +/- 0.3. All treatments were replicated 5 times and pots were set on the bench in a randomized block design.

Plants were grown in a glasshouse with natural daylight extended to an 18 hour photoperiod with a combination of fluorescent and incandescent lamps. The cuttings were allowed to grow as many shoots as would break from buds. All cuttings produced at least 1 shoot and some produced as many as 4. At 58 days after "sticking" all shoot growth (leaves and stems) was harvested, dried, weighed, and analyzed for K concentration. The original cutting with the root system was left in place, the nutrient solutions were all brought back to original mineral concentrations and the procedure was repeated. At 49 days all new shoot growth was harvested, dried, weighed and analyzed for K concentration. The entire cycle was completed a third time with the final harvest 67 days after the second harvest.

Analysis for K concentration was conducted by emission spectroscopy. Values were converted to percent dry matter for ease of presentation.

The relationship between K concentration and total shoot growth accumulation (dry weight) for each of the 3 cycles of the experiment are shown in Table 1. In the first cycle shoot growth per pot varied from 1.9 g to 2.3 g and K concentration from 0.26% to 0.85%. Shoot growth in the 0 mg K supply was from

redistributed mineral from the leafy hardwood cutting. Harvest of the shoots at the onset of visual deficiency symptoms in the control plants prevented the separation of treatments by growth differences (dry weight accumulation).

The second growth flush from the cuttings showed visual symptoms of deficiency in the 0 and 4 mg K supply treatments before harvest. There was a sharp increase in
(please turn the page)



*Lambert, Lee
& Associates*

**CONSULTING ENGINEERS
SURVEYORS**

Extensive experience in all aspects of cranberry land development: evaluation, purchase, survey, design, permit acquisition, phased construction and planting both in wetlands and uplands.

Have references. Will travel.

Contact: Will Lee
10948 Highway 54 East
Wisconsin Rapids, WI 54494
(715) 424-3131

growth with increasing K concentration to a level above 0.26% and below .34%. Higher K concentrations in the tissue were not associated with increased dry matter accumulation.

All cuttings with the 0 supply of K failed to renew growth after the second cycle. There was a direct relation between K concentration and growth in the third cycle with a restraint of growth in those plants with tissue K concentration below the 0.27% level with equal growth for higher tissue concentrations (Table 1). No association between growth and changes in concentration was found above the 0.27% tissue level. Allowing the best treatments to accumulate up to 6 grams of tissue depleted the supply of K in the rooting solution and inhibited development of higher concentration levels in the tissue. The shoot growth contained an amount of K equivalent to 80% or more of the available supply for each treatment in each cycle.

Shoot growth attained a maximum with a K concentration of 0.26%, 0.34% and 0.27% of dry weight in the 3 growth cycles. Deficiency was shown by visual symptoms at tissue K levels of 0.15%, 0.20%, 0.18% and 0.24% in this study. The tissues sampled in the present study were rapidly growing shoots in a greenhouse with high daytime temperatures and light intensity below that outside the greenhouse environment. These rapidly growing shoots would be roughly parallel in growth status to field shoots in late June and early July. Several workers (1, 4, 5, 8) have shown that the concentration of K found (not required) in leaf samples declines seasonally from a high in June to a lower quantity in September and October. The critical level of 0.26% proposed in this report for rapidly growing cranberries may be a slightly higher concentration than would be necessary for vines that have slowed or ceased vegetative growth in late summer or fall.

Literature Cited

1. Chaplin, M.H. and L.W. Martin. 1979. Seasonal changes in leaf element content of cranberry,

Vaccinium macrocarpon Ait. Comm. Soil Sci. 10:895-902.

2. Dana, M.N. 1981. Foliar nutrient concentration studies IV. Proposed standards. Cranberries 45(10):10-11.
3. Dana, M.N. 1981. Foliar nutrient concentration studies. I. Measured concentrations in 80 samples from 17 marshes. Cranberries 45(7):9-10.
4. Eaton, G.W. 1971. Effects of NPK fertilizers on the growth and composition of vines in a young cranberry bog. J. Amer. Soc. Hort. Sci. 96:426-429.
5. Eaton, G.W. 1971. Effect of N, P and K fertilizer applications on cranberry leaf nutrient composition, fruit color and yield in a mature bog. J. Amer. Soc. Hort. Sci. 96:430-433.

6. Eaton, G.W. and C.N. Meehan. 1973. Effects of nitrogen, phosphorous and potassium fertilizer on leaf composition, yield, and fruit quality of bearing 'Ben Lear' cranberries. J. Amer. Soc. Hort. Sci. 98:89-93.
7. Townsend, L.R. 1969. Leaf composition. In: Growing Cranberries, Canada Dept. of Ag. Publ. 1282, p. 16.
8. Townsend, L.R. and I.V. Hall. 1971. Nutrient levels in leaf and soil samples from three cranberry bogs in the Annapolis Valley of Nova Scotia. Cranberries 36(3):11-12.

¹Professor and research assistant, respectively. Current address of Ms. Steinmann, Box 185, Barneveld, WI 53507.



Gapen

Realty

112 Acres FOR SALE

Corp. permit to develop 30 acres of
beds. Some ditching completed.
Lots of water. House needs work.
Good potential.
Ladysmith, WI

\$69,900

2141 8th Street South
Wisconsin Rapids, Wisconsin 54494
(715)423-6550

CRANLAND SERVICES

Cranberry Property
Appraisals

★ ★ ★ ★ ★
Listings and Sales of
Cranberry Properties.
License # 68987

Lawrence W. Pink
Old Cordwood Path
Duxbury, MA 02332
(617) 934-6076

J.A. JENKINS & SON CO.

Grower Service

MOWING (ALL TYPES)
SANDING
DITCHING
WEED WIPING

Serving Cape Cod

227 Pine St., W. Barnstable, Ma. 02668

Phone 362-6018



Coast Cranberries Ltd.

Member of Ocean Spray Co-operative

Offers

a Rare Opportunity to Invest in
Cranberry Farming in British Columbia
CANADA

HISTORY:

Coast Cranberries Ltd. was established in Fort Langley in 1981 on 320 acres of high quality peat land. In 1982 the land was cleared and planted; later, a further 70 acres were purchased bringing the gross acreage to 390. By 1989 the farm has been developed into 271 planted acres divided into 52 separate fields. The fields are beautifully laid out with vines which are at different stages of growth. Should Ocean Spray Co-operative decide to allocate new acreage for planting, it is fortunate that adjacent land is available for purchase.

The farm is equipped with state of the art computerized sprinkler and frost control system, reservoir for water storage, and a pumping system that keeps fields well drained and pumps water from the Fraser River when required.

The buildings on the property consist of a manager's house, a machine shop, machinery and equipment sheds, and 12 pump stations.

Coast Cranberries Ltd. has excellent management and work teams. It has the potential of being one of the most successful and up to date cranberry farms in North America.

TERMS:

\$17,606,000 CASH

OR

\$7,040,000 for 40% of the farm with options to purchase further shares at market value.

For further information about this investment opportunity, please contact:

KEN HOPKINS AT (604) 276-8069

252 - 7671 Minoru Blvd., Richmond, B.C., Canada V6Y 1Z3

REGIONAL NOTES

MASSACHUSETTS

By IRVING E. DEMORANVILLE

Dr. Robert Devlin of the Cranberry Experiment Station was invited as external examiner for thesis and final examination of a Ph.D. candidate at the University of Alberta in Edmonton, Canada, from April 8-11. Bob also presented a seminar on herbicides and growth regulators while on campus.

.....

Marshall Severance of A.D. Makepeace told a group of environmentalists in Wareham recently that the cranberry company takes good care of Agawam and Wankinquoah river property that it owns. The subject came up when some of those present said they would like to see local groups taking responsibility for Wareham's rivers.

"We're already taking care of them," Severance said. "We maintain fish ladders and keep them clean. I think we do a good job."

WISCONSIN

Wisconsin farmers can expect heavy damages this year from deer, Sen. Alan Lasee, De Pere Republican, told a recent legislative

hearing. Some herds, he said, number as high as 200.

"In five years we're going to be up to our armpits in deer," Lasee said.

The state senator added that a partial solution may be to hike the deer hunting quotas.

FARMLAND PRICES UP

Farmland prices rose 6 percent in the year ending Feb. 1 compared to those for the prior year, according to the U.S. Depart-

ment of Agriculture.

The average farmland price was \$597 an acre.

Prices rose for the second straight year.

The new figure was, however, far below the peak of \$823 per acre in 1982.

Roger Hexem of the USDA's Economic Research Service said predictions are that farmland will increase 2 to 4 percent by Feb. 1, 1990 but that it is still too early to tell with any certainty.



Equipment Inc.
381 West Grove Street (Rte. 28)
Middleboro, MA 02346

KUBOTA Diesel Equipit.

Tractors 2 & 4 wheel drive — 12-90 hp.
Compact Excavators 1½ to 6 ton
Wheel Leaders ½ to ¾ yd.
Water Cooled Diesel Engines 4 to 104 hp.

All Types of Implements
Polymark Beaver-Mowers **947-6299**
Specialty Fabrication Work
Kubota Financing as Low as 8½%

*Sales *Service *Parts *Leasing

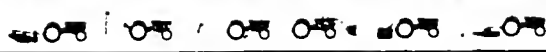



DECAN AG SUPPLIES

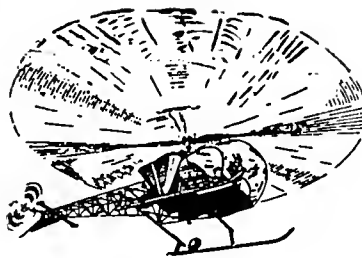

Inc.



- ★ Complete line of cranberry herbicides, fertilizers, insecticides, fungicides, miticides. In stock when you want them.
- ★ Best application and safety equipment for your needs.
- ★ Quality aerial applications.
- ★ Proven frost warning equipment. Don't take chances — buy the best.
- ★ Experienced cranberry consulting service offering pheromone traps and baits.
- ★ Right to know training.
- ★ Culvert Pipe — All sizes — steel, aluminum, and poly.
- ★ Ditch Mud Mats — Strong — lightweight — durable.
- ★ Burlap Picking Bags — Best for your money.
- ★ Sanding by helicopter.

John C. Decas

William D. Chamberlain

461 Mary's Pond Rd.
Rochester, MA 02770

Office: 295-2731
Evening: 763-8956
Fax: (508) 291-1417

Serving Massachusetts Cranberry Growers

R. A. S. P. INC.

Carrying a Complete Line of:

- Cranberry Chemicals and Fertilizers
- Frost Alarms
- Thermometers
- Chemical Application Equipment
- Kubota K-35 Rental

Contact:

Bob or Mike
3 Plymouth St.
Carver, MA 02330

Phone:
(508) 866-4429

Authorized Agway Representative

AGWAY

Office
295-2222

K. Beaton
295-2207

BEATON'S
CRANBERRY
GROWERS SERVICE

WAREHAM, MASS.

D. Beaton
888-1288

P. Beaton
947-3601

Specializing in

○ COMPLETE BOG
MANAGEMENT

○ NETTING

○ DITCHING

○ HARVESTING
(Wet & Dry)

○ SANDING

○ CUSTOM
HERBICIDE
APPLICATION

Complete line of portable Crisafulli Pumps 2" - 16"
Plastic netting for suction boxes



Blueberries Worldwide

Editor's Note: Because a substantial number of growers produce blueberries as well as cranberries—particularly in New Jersey—CRANBERRIES will carry an article on blueberries from time to time. This piece first appeared in *New England American Agriculturist* and is reprinted with the kind permission of that magazine.

By **MARVIN PRITTS**

Last August I had the privilege of attending the International Symposium on Vaccinium Culture held in Madison, Wisconsin. This conference was attended by blueberry and cranberry researchers from throughout the world, and many of the discussions and field visits had implications for blueberry growers in the Northeast.

Blueberry acreage is expanding rapidly throughout the United States and the rest of the world. Acreage has nearly doubled in Michigan since 1966, making it the largest producer of blueberries in the country with 15,000 acres. More than 2,500 acres have been planted in the foothills of the Ozark Mountains where none existed 20 years ago. Florida and Texas growers are

also planting significant acreages of blueberries, and the Pacific Northwest and North Carolina each boast 4,000 acres.

Closer to home, the Northeast contains 3,000 acres of highbush blueberries, with New York reported to have 55% of the total. In addition to the substantial highbush acreage in the Northeast, Maine growers manage 46,000 acres of lowbush blueberries. The total acreage of highbush, rabbiteye and lowbush blueberries in North America is over 150,000.

The blueberry plant is native to North America, so few people living outside the continent are familiar with the plant. This situation is changing, however—with Germany,

Poland, Finland, The Netherlands, Italy, Bulgaria, Australia, Chile, Japan, and Russia beginning fledgling industries.

What are the implications for the northeastern grower in the blueberry business? Fortunately, the blueberry fruit is not as perishable as other small-fruit crops, so supermarkets (where people purchase 80% of their fruit) are more willing to buy directly from independent growers, rather than from large California-type brokers. Blueberries will hold for a longer time in storage, allowing the grower to pick under dry conditions and hold the fruit for a week or more before delivery at a specified date.

Innovative growers should be able

DECAS OBJECTS TO REMARK BY GROWER

John C. Decas of the Decas Cranberry Co. took strong exception to a query posed by an Ocean Spray grower that was published in the June 1989 CRANBERRIES.

Following news of the settlement of a suit brought by Decas against Ocean Spray, in which the cooperative agreed to supply independent Decas with berries for 12 years, the grower, who spoke off the record, asked, "Does this mean in 12 years' time Ocean Spray will have to subsidize Decas again?"

Decas said he was outraged by the remark. "We've always stood on our own two feet and we don't need Ocean Spray or anybody else to give us a hand," Decas asserted. "It is our opinion that the settlement was a fair and equitable one."

Ocean Spray spokespersons also said they were pleased with the settlement of the anti-trust suit.

Decas also was critical of CRANBERRIES for not having sought his reaction to the grower's remark before the story was published.

We Still Make House Calls

Like your old family doctor, your Farm Credit representative still makes house calls . . . and he's been treating farm families like yours for a good 70 years.

Farm families count on him to provide the financial support they need—short-term and long-term credit—that helps them plan for a productive future.

But there's more to Farm Credit than money. What makes your Farm Credit representative unique is that he knows your business so well. Which means that he's more than a dependable source of credit. He can provide farm business consulting, tax services, credit life insurance, appraisal service and computerized record-keeping.

Give him a call. He could be just what the doctor ordered for you.



**Southern New England
Farm Credit Service**

**Federal Land Bank Association
Production Credit Association**
P.O. Box 7
Taunton, MA 02780
508 / 824-7578

to use wholesale markets for their blueberries, especially as demand in other countries increases. For example, per capita consumption of blueberries in East Germany is one ounce, but would be higher if fruit was available. The Japanese are selling their blueberries in very small containers at high prices because of the demand. Australians pay nearly \$3.00 per pound for their blueberries.

The lowbush blueberry acreage in the United States is nearly all destined for processing. Much of the Michigan and New Jersey production is also processed, with this year's price for processed fruit equivalent to the fresh market price because of the drought. The creation of many new products containing blueberries attests to their popularity, and should sustain demand for processed fruit over the next several years.

Demand for pick-your-own blueberries is also rather strong in the

United States. Although some regions are seeing the effect of competition, others are not. Near Ottawa, Canada, the pick-your-own price for highbush blueberries was reported to be \$2.25 per pound.

In the Northeast, prices are generally 80 cents per pound, and the overall marketing situation is favorable. Much of the blueberry acreage in New York and other states consists of young plantings, and is almost exclusively sold for the fresh market. Future marketing of fresh blueberries may become more difficult as these young plantings mature.

Blueberries will soon be available to consumers year around. In Holland, growers are planting blueberries in old greenhouses once used for flower production, and providing bees for flower pollination. Harvest is advanced four weeks, allowing them to take advantage of the early market.

Australia and Chile are also

conducting extensive research on producing blueberries for sale to the United States during winter. Florida can already produce for the May market. These trends may have a positive influence on domestic sales if consumers become accustomed to using blueberries

TAUNTON 4 Prime Bogs

- 22 Acres
- Good Water & Soil
- Dormant - Ready to Rebuild
- Chapter 61 A - Plans

LEASE OR SALE
(508) 896-6262

Cranberry Harvesting Equipment

Warrens Equipment & Manufacturing Co., Inc.

Growing cranberries is something you as a grower do best. Manufacturing of harvesting equipment, air flow, radar controlled fertilizer spreading equipment, and flow gates or flumes is something we do that can be of service to you.



NEWS FLASHES

Standard WEM Bog-Trac Tractors & Beaters Available For Immediate Shipment

- Beater reels available, your choice of designs
- You as a grower tell us what is best for your bog
- Change your reel rpm from bog to bog or variety to variety
- Engine horsepower available from 18 h.p. to 48 h.p.
- Safety parking brake
- Ground speed and reel speed Indicator
- Lighter weight

Be sure to check this new model harvester before you make a purchase for 1989.

WEM Factory serving Wisconsin, West Coast, British Columbia
111 Grant St.
Warrens, WI 54666
Tel. (608) 378-4794
(608) 378-4137

WEM East Coast
Stearns Irrigation, Inc.
790 Federal Furnace Rd.
Plymouth, MA 02360
Tel. (508) 746-6048

throughout the year, rather than on a seasonal basis.

I predict that the blueberry market will remain strong since this crop is rather difficult and costly to establish. Dr. Mark Castaldi, Cornell University economist, estimated the net establishment costs for blueberries (cumulative costs minus revenues through the first nine years) at \$13,612 per acre. This price tag will prevent many growers from entering the blueberry business on a large scale.

Breeding Objectives

The biggest problem facing blueberry growers in other parts of the world is lack of adapted cultivars. Bluecrop is probably the most widely grown cultivar, but it was developed for the New Jersey climate. Breeders are currently focusing on developing improved cultivars for their regions, and are examining hybrids made with other species.

Examples of hybrid blueberries are Northland, Patriot, Bluetta,

Northblue, Northsky and Northcountry. Each has the ancestors *Vaccinium corymbosum* (highbush) and *V. angustifolium* (lowbush), and enable growers to plant these cultivars in very cold climates. Species from locations other than North America are being used in breeding programs throughout Europe and Russia to improve adaptability.

Tropical islands, like New Guinea, contain more than 100 species

of *Vaccinium*. The potential exists to develop blueberry-type fruit for just about every country in the world.

In New Jersey, breeders are trying to incorporate drought tolerance and pest resistance into highbush blueberries through crosses with the rabbiteye blueberry from the southern United States. Florida and North Carolina continue to develop highbush blueberries which require little winter chilling, and

WOLLSCHLAGER EXCAVATING

Dragline Work — All Kinds

Also Have Clam & Scalping Buckets

**Route 1 Necedah, WI 54646
1-800-585-2436**



**MIDDLEBOROUGH
TRUST COMPANY**

The Business Bank.

MTC offers you business banking built to your needs.

Personal attention to your special

financial requirements now and as you grow. Cooperation.

Flexibility. Complete business and personal banking.

Member FDIC



Main Office

10 John Glass, Jr. Square, Middleborough

Branch Offices

Middleboro Square, Rt. 28, Middleborough • Middleboro Plaza, Middleborough
Cranberry Plaza, East Wareham • Carver Square, Carver • Trucchi's Plaza, Taunton

Telephone all offices **947-1313**

produce for the early market. The Minnesota program is experimenting with summer-flowering, fall-fruiting blueberries which may enable growers to avoid most winter-injury problems. Michigan is looking for late flowering, yet early fruiting types and is examining wild selections for desirable traits.

Breeders at the United States Department of Agriculture in Beltsville, Maryland, also have some interesting selections out for test. One particular selection has flavor equal to Bluecrop, but a much more upright growth habit and slightly later production period. It is possible this selection could be released in the next several years. These are but a few examples of the exciting developments in breeding programs throughout the country.

During one of the tours, we were able to examine many blueberry cultivars and selections at test plantings located in Grand Junction, Michigan, home of the Michigan Blueberry Growers Association.

Also on the agenda was Tower View Nursery, the only nursery in the world to virus-test its plant material. Many growers starting a blueberry operation are interested in obtaining virus-free plants to avoid roguing diseased plants in the future.

The group visited DeGrandchamp's Blueberry Farm which employs over 45 workers during the summer. They have a 6,000 cubic foot cooler to precool berries before shipping, and a new type of irrigation system which uses the same lines to irrigate in summer, and drain the fields in spring.

We also had the opportunity to visit Jones' Blueberry Ranch in Indiana, with 72 acres of immaculate plantings. The manager, John Nelson, discussed what he felt were the secrets of his success.

Customers are first greeted in the parking lot and asked what type of berry they want to pick (pies, freezing, fresh eating, etc.). Several signs in the area list the vitamin, mineral and fiber content of blueber-

ries. Customers are given a two gallon bucket and a ride to the appropriate field. (Mr. Nelson found that sales increased significantly when customers were given a large bucket, rather than smaller ones.) Little red wagons are also provided if a customer plans to harvest a large amount of fruit.

Plantings are in small blocks

**The
CHARLES W. HARRIS
Company**

451 Old Somerset Avenue
North Dighton, Mass.
Phone (508) 824-5607

AMES
Antisyphon Devices
RAINBIRD
Sprinklers
HALE
Pumps

*Highest Quality Products
With Satisfaction Guaranteed*

K Ag Laboratories International, Inc.

**2323 Jackson Street
Oshkosh, WI 54901**

**Serving Cranberry
Growers in U.S.A.
& Canada since 1984**

**Over 20 years
of Experience on
Acid Soil Interaction**

K Ag Laboratory has run over 30,000 cranberry soil and over 17,500 cranberry vines tests since 1984, and gave fertilizer recommendations with great success.

- ★ *Cranberry Soil Analysis*
- ★ *Cranberry Vine Analysis*
- ★ *Cranberry Water Analysis, Usage & Interpretation*
- ★ *Liquid & Dry Fertilizer Recommendation*
- ★ *Soil Problems & Consultation*
- ★ *Seminars*
- ★ *Cranberry Crop Monitoring Program, testing and monitoring nutrient status with 30 day intervals during during the growing season.*

Highly computerized cranberry soil, tissue and water testing program in U.S.A. and Canada.

For more information contact: **Dr. Akhtar Khwaja, Ph.D.**
Certified Professional Soil Scientist
Certified Professional Agronomist

Phone Number 414-426-2220; Out of WI 1-800-356-6045; FAX 414-426-2222

with short rows for both ease of walking and improved pollination. Bee hives are set between rows of different cultivars to ensure cross-pollination. Weeds are practically nonexistent since a perennial sod is planted in the row middle, and young plants are set through plastic or weed mats. Gramoxone is the only herbicide used in young plantings so phytotoxicity from preemergent herbicides is avoided.

Plants are irrigated through September, and the fertilizer program consists of split applications

of urea and magnesium. Each block is given foliar nutrient sprays in accordance with a leaf analysis.

The most important cultural practice, according to Mr. Nelson, is pruning. He finds that annual pruning is a must, and believes this separates his operation from many other growers who experience low yields, late-maturing small berries, and diseases. Interestingly, Gary Pavlis, blueberry specialist from New Jersey, also identifies lack of pruning as the most important cause of low yields in that state.

YANKEE PLANNERS, INC.

*59 North Main Street
Middleboro, MA 02346
(508) 947-0527*

**Sound and Objective
Advice
Suited to
Your Needs**

- *Tax and Estate Planning*
- *Investment & Insurance Review*
- *Business Continuity*
- *Asset Protection*
- *Key Employee Retention*
- *Business Tax Analysis*

Mr. William H. Bestgen, Jr.
Chartered Financial Consultant

Mr. Peter W. Hutchings
Attorney at Law practicing as
a Tax Attorney

Mr. Roger H. Parent, Jr.
Accountant, Enrolled to Practice
before the Internal Revenue
Service

*Call For Your Free Brochure
(508) 947-0527*

Irrigation Supplies

- **2" to 12" PVC Pipe with Fittings**
- **Quick Couple Risers**
- **Felker Aluminum Flumes & Culverts**

Replace old aluminum mains with government approved 4", 6" and 8" polyethylene pipe buried just below bog surface. No insert fittings. Rent our butt fusion welder for a continuous main line. Beat the high cost of custom installation by renting our small 4-wheel drive tractor with mole hole plow for buried laterals.

STEARNS IRRIGATION, INC.
790 Federal Furnace Rd.
Plymouth MA 02360
Tel. (508) 746-6048



**CEECO
CORPORATION**
OF NEW ENGLAND

Industrial Suppliers To The Cranberry Industry



Chain, Cable and Accessories

Used for Making Mats

All Types of Fasteners (Bulk & Packaged)

Hand Tools

Power Tools

Chemicals

Lubricants

Safety Equipment

Pumps

Motors

Abrasives

Cutting Tools

Richards Rd.
Plymouth Industrial Park

747-0086
Plymouth, MA 02360

Mr. Nelson has his cash register programmed to record variety and the check-out time. This allows him to plan more effectively. He also does all his spraying and running of the mechanical harvester at night so he can maintain a quiet, tranquil atmosphere at the farm during the day. He feels that sounding devices for bird control keep away many customers as well as birds.

Research Findings

The Australians are planting their blueberries on ridges to avoid Phytophthora root rot. The sides of the ridges are covered with landscape mats to help with weed control and maintain the integrity of the ridge. The top of the ridge is mulched with wood chips, but contains no landscape mat so new canes can grow through. Plants are set two feet apart in the row to obtain early production. Microjet irrigation is the preferred means of applying water.

The Australians have found that windbreaks are very important for successful blueberry production. Often entire plantings are enclosed in Japanese fishing nets to exclude birds—at a cost of \$5,000 per acre.

Florida researchers have discovered

a new bee which is an incredibly efficient pollinator of blueberries. It has a long tongue and feeds almost exclusively on blueberry pollen and nectar during flowering. Researchers hope to eventually place nests of these pollinators in commercial blueberry fields, but have not yet been able to follow these bees to their nesting sites in the woods. In contrast, 65-100% of honeybees enter blueberry flowers through the holes at the base of the flower made by carpenter bees, and do not pollinate the flower.

Canadian researchers found that optimal blueberry production was obtained when 10 gallons of peat was incorporated in the planting hole, and plants were mulched with sawdust and irrigated with a trickle system. Several other researchers reported on the importance of a low soil pH, and the problem of planting blueberries on high-lime soils.

In an interesting study from Michigan, foliar levels of phosphorus, calcium, boron and magnesium have been declining since 1964, indicating future problems if not corrected. Germany is already experiencing problems when blueberries are planted in soils previously used for agriculture. The cause of this replant problem is unknown.

Several new virus diseases have been

identified in Washington, Oregon, Michigan and New Jersey. These may spread to the Northeast.

The blueberry is one of the few fruit crops with a bright future.

For this future to be realized, however, support must be maintained for small fruit research programs.



CRANBERRY GROWERS REALTY

Listings of buyers and sellers welcomed on cranberry acreage and upland.

Appraisals

DOUGLAS R. BEATON
E. Sandwich, Mass
02537
(617) 888-1288

22 years experience  construction lifts 

AERIAL LIFTING

◦ BERRY LIFTING ◦

nylon berry bags
bulk bins

◦ MUD LIFTING ◦

NEW MATS

lightweight
durable

contact
PETER or CHUCK
508-295-2222

BEATON'S
CRANBERRY
GROWERS SERVICE

WARHAM MASS.

mat rentals & sales



Weather

MASSACHUSETTS

April was cool, averaging 1.4 degrees a day below normal. Maximum temperature was 64 degrees on both the 18th and 27th and the minimum was 24 degrees on the 12th. Generally, the first half of the month was very cold and the last half a little above normal.

Rainfall totaled 5.88 inches or 1.6 inches above normal, our first above normal rainfall since November. There was measurable precipitation on 15 days, with 2 inches on the 15th and 16th as the greatest storm. We are about 2 inches below normal for the year and just even with 1988.

There were frost warnings from April 22-25. Temperatures were mostly 15-16 degrees on the 22nd but some were in single numbers. Dew points were very low and there were many reports of sprinkler heads freezing during the night. No reports of injury at this time. I.E.D.

Obituary

Antone J. Jesus

Antone J. "Manche" Jesus, 98, of Onset, Mass., died April 10 after a brief illness. He was the widower of Lucy (Hillman) Jesus and son of the late Joseph and Anna (Gomes) Jesus.

Jesus died at the New England Baptist Hospital, Boston.

He was born in Brava, Cape Verde Islands, and immigrated to this country in 1903. He lived in Wareham most of his life.

He worked as a whaler and in the New Bedford cotton mills before his many years in the cranberry business. Employed by the Fuller & Hammond Cranberry Company for 60 years, he was a long time foreman there.

Jesus retired at the age of 89 and his remembrances were captured in the book, *Spinner: People and Culture in Southeastern Massachusetts, Volume III*, New Bedford, 1984.

He is survived by three daughters, Dorothy Britto of New Bedford and Beatrice Becker and Elizabeth Jesus, both of California; a stepdaughter, Mary Barrows of Wareham; two sons, Napoleon "Nappy" of Wareham and Avelino "Lino" of Onset; a sister, Kena Jesus of Wareham; 22 grandchildren; 36 great-grandchildren; 19 great-great-grandchildren; and a great-great-great-grandson.

FERMENTA CHANGES ITS COMPANY TITLE

Fermenta Plant Protection Co. of Mentor, Ohio, has changed its name to Fermenta ASC Corporation, announces company president Richard L. Urbanowski.

50 Years Ago

Cape Cod grower William R. Wheeler related how his "Harvest Queen" label was named after a shipwreck his grandfather, Capt. James R. Wheeler, had survived.

According to an account in the *Boston Advertiser* on March 20, 1861,

Gapen Realty

Cranberry Marsh FOR SALE

*6 acres planted, *17 acres ready to be planted *3 homes

\$175,000

Washburn County, WI

2141 8th Street South
Wisconsin Rapids, Wisconsin 54494
(715)423-6550

Clogged Suction Screen?

This Screen Stays Clean



SURE-FLO
Self-Cleaning
Strainers

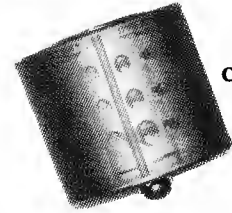

capacities to
3850 gpm

patent no.
4822486

Save Time – eliminates the headache of manual screen scrubbing

Save Money – maintains maximum pump efficiency

For more information:

Perfection Sprinkler Co.

2077 S. State St.

P.O. Box 1363

Ann Arbor, MI 48106

313 761-5110 FAX 313 761-8659

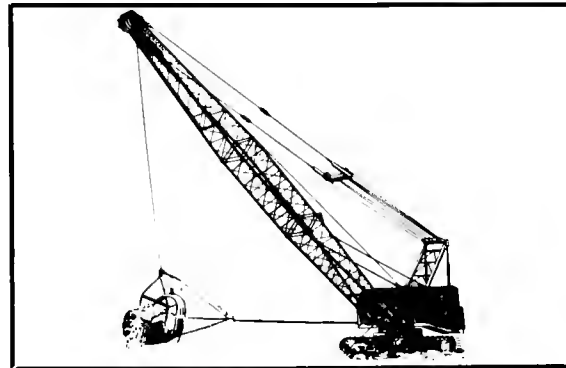

Krause Excavating, Inc.

Canal Work

Pond Construction

Ditching

Land Clearing

1-1/4—3 yd. draglines with 80' boom and matts, 2 yd. backhoe, swamp dozer and other related equipment.

Contact:

Roger Krause 1-414-398-3322

Route 3 Markesan, Wis. 53946

the Baroque Harvest Queen, piloted by Captain Wheeler, was wrecked on the Scituate cliffs during a heavy northeaster. The ship was headed for Boston from Buenos Aires via New York with a cargo of wool when "a terrific gale with a thick snowstorm" developed.

Captain Wheeler reported heading the ship toward what he thought was the Boston light when the ship hit "hard bottom."

According to the *Advertiser*, the crew then "lost sight of light, took in all sail and let go both anchors in four fathoms. Found it impossible to keep from going ashore and prepared to leave with the boats."

The light that Captain Wheeler steered by turned out to be— not the Boston light—but a large fire built by watchmen on the Scituate shore.

Six of the crew drowned when their

boat capsized on the way to land. The captain, mate, second mate and a passenger were saved by people on shore.

William R. Wheeler called his cranberries "Harvest Queen of the C's." In the 1930's he campaigned to educate the public on the difference between Early Blacks and Howes. He packaged Early Blacks with the label, "Piccaninnies," which apparently caused a less eyebrow raising reaction than it would today.

—Carolyn Gilmore

Wanted

Wisconsin Cranberry Grower wishes to purchase an existing cranberry marsh.

STEVE

(715) 421-0917

(715) 593-2385

WANTED Gravel & Sand

in the southeastern Massachusetts area

Quantities of 10,000 yards and up

Complete site work, bog construction and finished contouring of surrounding area plus the best price for your material.

Michael Coan
Carver, Mass.
(508) 866-5285

Earl White
Medfield, Mass.
(508) 359-7291

LIFT PUMPS

Trailer or Permanent
Electric, Tractor or
Engine Driven

PHIL HELMER
(715) 421-0917



Equipment, Inc.

381 West Grove St. (Rte. 28)

Middleboro, MA 02346

(508) 947-6299

 **KUBOTA**

Tractors, Excavators and
Diesel Generators

 **COYOTE**

Wheel Loaders
3/4 Yd - 6 1/2 Yd



Screening Equipment

R.D. GRASSI Cranberry SERVICES

**Herbicides
Applied**

*Custom Pruning
Custom Ditching*

*Sanding
Wiping
Wet Harvesting
Mowing*

*(Mowing includes
Hydraulic Arm
Flail Mower.)*

**West Wareham,
Massachusetts**

**Ask for Rick at
295-5158**

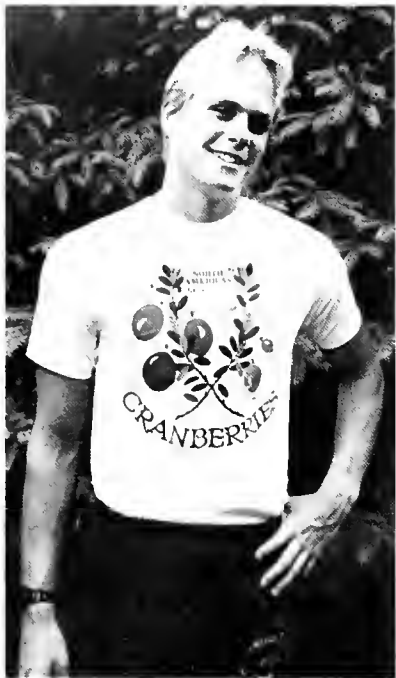

Cranberry Originals

T-Shirt
"CRANBERRIES
North America's Native Fruit"

An Original Botanical Design
of Blossoms and Green & Ripe Cranberries
by

Adult T-Shirt (Sizes S, M, L, XL)	\$12
Adult XXL T-Shirt	\$14
Youth Size 14-16 T-Shirt	\$11
Children's Sizes 4, 6-8, 10-12	\$11
Adult Sweatshirt (S, M, L, XL)	\$25
Adult XXL Sweatshirt	\$28
Youth 14-16 Sweatshirt	\$21
Children's Sweatshirt (4, 6-8, 10-12)	\$19

Send Check or Money Order to:
CRANBERRIES
P.O. Box 249
Cobalt, CT 06414

Add \$3.50 Shipping & Handling Charge
For Canadian orders, add \$8

Name

Address

City State Zip

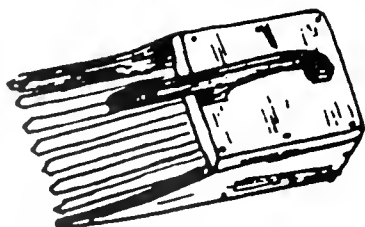

SKIPPAR

POLE



SERVICE

- Private Poles • Line Construction
- Sonotube Drilling • New & Used Poles

(508) 690-2238

208 Franklin St., East Bridgewater, MA 02333

WISCONSIN CRANBERRY
HEADQUARTERS FOR
SEVIN XLR

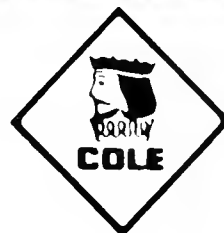

DEVRINOL 10G • EVITAL • GUTHION
DIAZINON 14G • PARATHION • ETHREL

Cole/Grower Service

537 Atlas Ave., P.O. Box 7211, Madison, WI 53707
(608) 221-6204 or 1-800-362-8049

BLUE HERON FARMS

GROWER SERVICE

MOWING (all types) * DITCHING
WATER HARVESTING * SANDING

"Specializing in the Needs of Small Growers"

Call Wayne or Karen Barnes

72 Brook St.
Plympton, MA 02367
1-617-585-9830



DRESSER + BARK RIVER

*Quality products and
trained, dedicated people
standing behind them.*

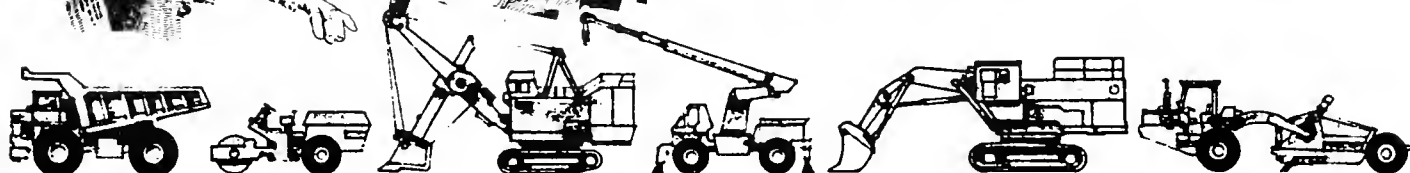

It's a combination that adds up to top production for you!

Then add BARK RIVER's full line of other quality tools and equipment and you have a complete source for all your equipment needs, all backed with dependable product support.



Crawler Loaders
Crawler Tractors

Draglines
Drills
Graders

Hydraulic Excavators
Hydraulic Shovels
Planers

Rollers
Scrapers
Shovels

Trucks (off-highway)
Wheel Loaders

- FRINK SNOW-PLOWS
- FMC WAYNE STREET SWEEPERS
- CLARK-BOBCAT SKID STEER LOADERS
- WISCONSIN TRAILERS
- VAC-ALL BY LEACH
- GAFNER IRON MULE
- TIGER HIGHWAY MOWERS
- HITACHI EXCAVATORS AND CRANES
- PAPER, CALMENSEN BLADES AND CUTTING EDGES
- FOX SPREADERS
- WALDON LOADERS
- GRADALL INC. EXCAVATORS
- MURPHY DIESEL ENGINES
- KOLMAN CONVEYORS
- MORBARK EGER BEEVER CHIPPERS
- FAIR SNOWBLOWERS
- AMZ ASPHALT PATCHING EQUIPMENT
- SICARD SNOWBLAST SNOWBLOWERS

Manufacturers of corrugated steel & aluminum culvert pipe and drainage products.



BARK RIVER Culvert & Equipment Co.

Backing you with 82 years of experience.

EAU CLAIRE
1700 Western Avenue
Phone (715) 835-5157

MADISON
Highway 51 & Buckeye Rd.
Phone (608) 222-4151

ESCANABA
430 N. Lincoln Street
Phone (906) 786-6920

GREEN BAY
600 Liberty Street
Phone (414) 435-6676

SUPERIOR
1213 Winter Street
Phone (715) 392-2243

MILWAUKEE
11715 W. Silver Spring Rd.
Phone (414) 461-5440

Take Good Care of Yourself Have an Ocean Spray!



The farmer's cooperative that brings you
a wide range of natural fruit juices, drinks and sauces

Ocean Spray Cranberries, Inc., Lakeville-Middleboro, MA 02349

An Equal Opportunity Employer

3
23
7
2u

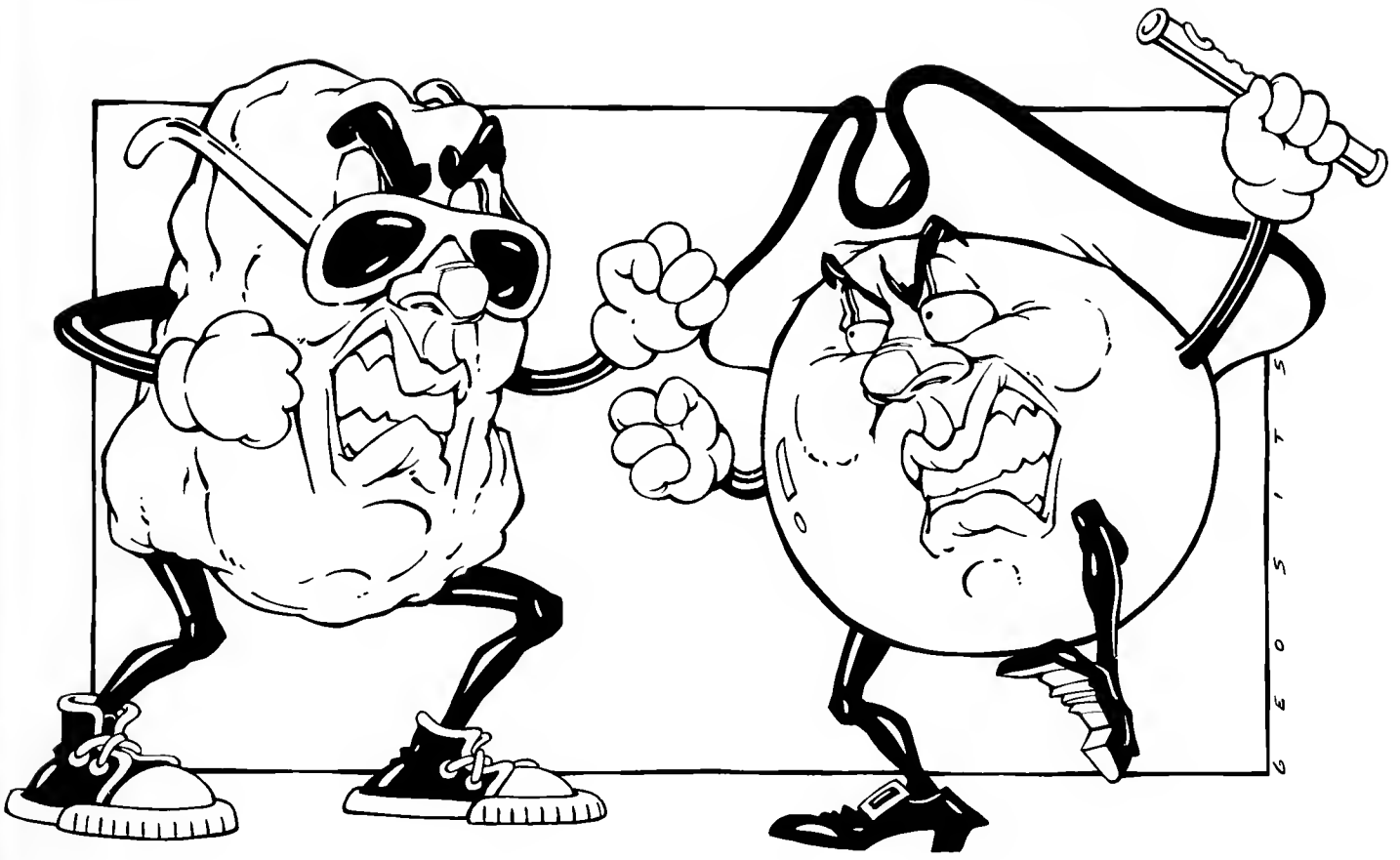

Craisins & Raisins Square Off

Memories of Charley Doehlert

S

Growers to Raise

UNIV OF MASS LIBRARY
SERIALS DEPT
AMHERST MA
01003

The Pilgrim stands behind
every commercial loan
Bob Tracy
makes.

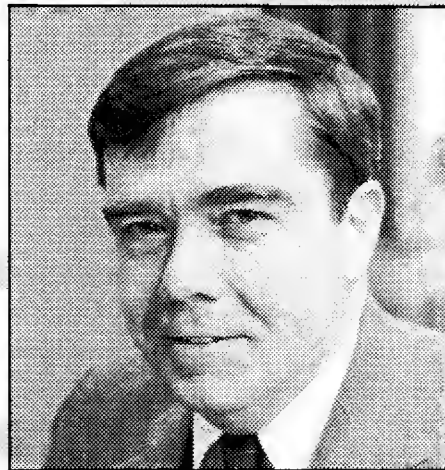

And that's a
promise.

Call him on it at 746-3300.

The Pilgrim is a symbol of strength, integrity and experience; and it best personifies the resources Bob Tracy offers every business that turns to him for help.

An assistant vice president of our commercial banking operation, Bob has over 15 years of banking know-how. His expertise has helped to earn us a reputation as The Answer Bank.

Backed by the superior lending capabilities of Plymouth Savings Bank, Bob can design a commercial lending package with the attractive rates and fast turnaround time that you need.

This is the power and the promise of the Pilgrim.
Call Bob Tracy at 746-3300.

Main Office: Wareham, (508) 295-3800;
Cotuit, (508) 428-1300; Duxbury, (617) 934-0101;
Falmouth, (508) 548-3000; Marion, (508) 748-2919;
Mattapoisett, (508) 758-4936; Middleboro, (508) 946-1777;
North Plymouth, (508) 747-1600; Plymouth, (508) 746-3300;
Sandwich, (508) 888-4444; Teaticket, (508) 540-5002

Plymouth
 **Savings**
Bank®

Member FDIC/DIFM

Raisin Makers Aren't Craisy Over Craisins

"Sour Grapes" Say Supporters Of Ocean Spray

Will the Craisin and the raisin coexist amicably in the universe of snack foods and cereal and pastry ingredients? Or will the current dispute over the word *Craisin* wind up in court? Will Ocean Spray be forced to use another word for its dried cranberry? Or will the raisin people have to stop stewing and simply accept their little red competitor—and its name?

All those questions and others are up in the air pending the outcome of action initiated by the California Raisin Advisory Board based in Fresno.

The advisory board has asked the California attorney general to look into whether Ocean Spray can legally use the word Craisin. The

raisin growers claim that by using the word, Ocean Spray is exploiting the popularity of the raisin.

The raisin people have spent millions over the last several years to elevate their product. Much of that money has gone into parading before TV audiences its sunglasses-wearing, sneakered California raisin, strutting to a Motown beat.

Ocean Spray spokespersons dispute the raisin growers' stand.

"I don't think there's any confusion here," said the cooperative's John Lawlor. "It's very clear when you say Craisins are dried cranberries you're not getting a raisin. We don't feel it's unfair."

Ocean Spray registered the word Craisin as a trademark last October. To avoid confusion, says the cooperative, labels will read CRAISIN DRIED CRANBERRIES.

A meeting between cranberry and raisin representatives took place in California June 29. The session was described as "frank" but apparently there was no resolution to the controversy. Among those present was Ocean Spray lawyer Ken Beeby.

The reason California Attorney General John Van de Kamp is in the act, according to Clyde Nef, manager of the California Raisin Advisory Board, is that the raisin industry operates under a state

marketing order. The board wants to find out if the use of Craisin in any way violates any name protection provisions of the marketing order.

If the state can't act, a private suit will be considered, says Nef.

"We're not very happy about what's going on," he said.

Asked whether he thought the attention drawn to Craisins might indirectly aid the raisin industry, Nef replied that he thought the opposite would happen.

"A shiny, sticky, rather tart product might be looked upon as a very poor quality raisin," Nef said. "If people react negatively, it might reflect on raisins."

The controversy has drawn widespread interest. Among the calls received by CRANBERRIES was one from a London newspaper. Journals from coast to coast have carried the story and so have such national periodicals at *Time*.

Expectedly, the story has given

CRANBERRY GROWERS REALTY

*Listings of buyers and
sellers welcomed on
cranberry acreage
and upland.*

Appraisals

DOUGLAS R. BEATON
E. Sandwich, Mass
02537
(617) 888-1288

The CHARLES W. HARRIS Company

451 Old Somerset Avenue
North Dighton, Mass.
Phone (508) 824-5607

AMES
Antisiphon Devices
RAINBIRD
Sprinklers
HALE
Pumps

*Highest Quality Products
With Satisfaction Guaranteed*

COVER ILLUSTRATION
KATHLEEN M. GEOSITS,
artist for *The Boston Herald*,
created this cartoon depicting
the battle between the raisin
and the Craisin.

Kathleen M. Geosits/Boston Herald



OCEAN SPRAY envisages Craisins being used in a wide variety of products, including cereals, baked goods and dairy items. They'll also be marketed as a convenient, mouth poppin' snack.

birth to much satire and spoofs.

Editorialists have jumped into the fray. A New Bedford (Mass.) *Standard Times* writer concluded:

"And maybe it's just a case of rooting for the home team, but Ocean Spray sounds like it has a winner here. Any grouching from the West Coast ought to be filed under 'sour grapes.'"

What if a suit is filed? Would Ocean Spray consider a name change?

An Ocean Spray spokesperson said any response would depend on an analysis of the suit itself. Right now, the cranberry cooperative is sticking fast to Craisins, which grew out of a "name generating session" at Ocean Spray.

Craisins, which resemble red raisins, are sliced cranberries that are sweetened in a cranberry juice concentrate and then dried in a series of hot-air chambers.

Tyson Foods uses Craisins in the stuffing for one of its frozen chicken dinners. Well-Bred Loaf Co. puts Craisins into its cake slices. Soon Craisins will show up with raisins

in Ralston Purina Company's Muesli cereal.

Craisins as a snack food, packaged in 1-ounce pouches, with six pouches to a box, will be available sometime next year. An Ocean Spray spokesperson said testing on the product still is taking place.

Not everyone in the raisin industry is upset by the prospect of a Craisins craze.

"I think the whole thing is a tempest in a teapot," Terry Whitney, president of the West Coast Growers and Packers of Selma, Calif., was quoted as saying to the

Irrigation Supplies

- **2" to 12" PVC Pipe with Fittings**
- **Quick Couple Risers**
- **Felker Aluminum Flumes & Culverts**

Replace old aluminum mains with government approved 4", 6" and 8" polyethylene pipe buried just below bog surface. No insert fittings. Rent our butt fusion welder for a continuous main line. Beat the high cost of custom installation by renting our small 4-wheel drive tractor with mole hole plow for buried laterals.

STEARNS IRRIGATION, INC.

790 Federal Furnace Rd.

Plymouth MA 02360

Tel. (508) 746-6048

Boston Globe.

But other voices voice rage. Ernest Bedrosian, president of the National Raisin Co., Fowler, Calif., declared:

"We've spent millions of dollars building the raisin image up as a healthy, natural fruit of the sun. Now they put a c in front of it and call it a Craisin. We made it so popular, they just want to shirrtail on our success."

"If it's a cranberry, why don't they call it a cranberry?" asked the California Raisin Advisory Board's Don Martens.

The board's manager, Clyde Nef, said that in the past Ocean Spray has used the name of another product only when that product was tied in with the cranberry. He cited cranapple as an example. In the case of raisins, he said, there is no such tie-in.

The raisin spokesman drew a parallel between the raisin-Craisin controversy and the recent Gallo brothers case in California. In that

case, the Gallo brothers of wine fame, Ernest and Julio, sued their younger brother, Joseph, because he used the Gallo name on a cheese he marketed. The winery brothers won.

"If the court decided Gallo couldn't even use his name, how can Ocean Spray get away with the use of raisin in Craisin?" asked Nef.

The industry with which Ocean Spray is locked in battle comprises about 4,500 growers. Some, such as Sun Maid, a cooperative which comprises about one-third of the industry, and Delmonte and Dole, are giants. Most are family operations, many of which produce other crops, such as cotton, tree fruits and nuts.

All exist within about 100 miles

WISCONSIN CRANBERRY HEADQUARTERS FOR SEVIN XLR

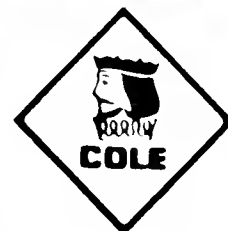

DEVIRINOL 10G • EVITAL • GUTHION
DIAZINON 14G • PARATHION • ETHREL

Cole/Grower Service

537 Atlas Ave., P.O. Box 7211, Madison, WI 53707
(608) 221-6204 or 1-800-362-8049

Cranberry Harvesting Equipment

Warrens Equipment & Manufacturing Co., Inc.

Growing cranberries is something you as a grower do best. Manufacturing of harvesting equipment, air flow, radar controlled fertilizer spreading equipment, and flow gates or flumes is something we do that can be of service to you.



NEWS FLASHES

Standard WEM Bog-Trac Tractors & Beaters Available For Immediate Shipment

- Beater reels available, your choice of designs
- You as a grower tell us what is best for your bog
- Change your reel rpm from bog to bog or variety to variety
- Engine horsepower available from 18 h.p. to 48 h.p.
- Safety parking brake
- Ground speed and reel speed indicator
- Lighter weight

Be sure to check this new model harvester before you make a purchase for 1989.

WEM Factory serving Wisconsin, West Coast, British Columbia
111 Grant St.
Warrens, WI 54666
Tel. (608) 378-4794
(608) 378-4137

WEM East Coast
Stearns Irrigation, Inc.
790 Federal Furnace Rd.
Plymouth, MA 02360
Tel. (508) 746-6048

in central California, except for a handful in Arizona. They produce about 40 percent of the world's supply. Their crop value last year was worth about \$550 million.

Bedrosian owns that the Craisin could result in serious competition.

"If this Craisin is priced anywhere near our product, then naturally it's going to cut in," he told the *Boston Herald*.

Ocean Spray had more than \$780 million in sales last year, built largely on a knack for inventing a use for cranberries in a myriad of products. Among some 40 products it has launched, there has been only one setback: cranprune juice.

TAUNTON 4 Prime Bogs

- 22 Acres
- Good Water & Soil
- Dormant - Ready to Rebuild
- Chapter 61 A - Plans

LEASE OR SALE
(508) 896-6262

Niemi Electric Company



Robert
Niemi
Electrical
Contractors

Heat, Light & Power Wiring

- RESIDENTIAL
- COMMERCIAL
- INDUSTRIAL

Pinehurst Drive
Wareham, Mass.
TEL. 295-1880

Cranberry Memo From C.I.A.

Editor's Note: The following memo was delivered to the CRANBERRIES office by a mysterious individual wearing an oversized raincoat, a crumpled fedora and smoked glasses. "Dis is from . . .," he said, in a muffled voice, and we didn't quite get the name. But it sounded like David Pheromone.

From: C.I.A. (Cranberry Information Agency)

Date: 15 June 1989

RE: "Sour Grapes"

It has been widely reported that thousands of Raisins were staging sit-down strikes in Fresno, Calif., to protest the introduction of Craisins. Raisin spokesperson D. Ried Grapes stated that millions of raisins are worried that their job security is threatened because of Craisins. "Where does an unemployed raisin go?" read one of the posters.

Cranberry industry spokesperson Ms. Ima Cranberry said she hoped that the Raisins would not get bogged down in dealing with the Craisin phenomenon that is sweeping the Nation.

DEADLINE HOLLYWOOD:

Unconfirmed reports stated that the rock group, "California Raisins," may cancel further tours of the East Coast because of the Craisin controversy. Rumor also has it that one of the backup singers for the group may actually be an undersized prune named P. Danish.

An anonymous caller from a group calling themselves C.A.R. (Craisins Ain't Raisins) said that the American people will ultimately determine whether Craisins and Raisins can exist together in a free society.

WALL STREET:

Raisin stocks drop 50 points on rumors that some cereal makers may cut the number of scoops of raisins in their product in half to make room for craisins.

DISCLAIMER:

This report from the C.I.A. contains no real or factual information and all names have been changed to protect any craisins or raisins, living or dead. It was generated to inject some humor and as a result of the craisined mind of the writer.

Decran Ag Supplies
Inc.

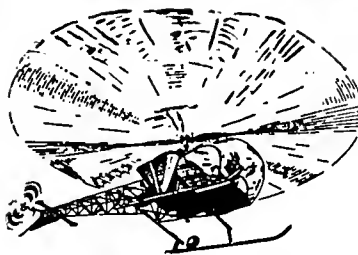

- ★ Complete line of cranberry herbicides, fertilizers, insecticides, fungicides, miticides. In stock when you want them.
- ★ Best application and safety equipment for your needs.
- ★ Quality aerial applications.
- ★ Proven frost warning equipment. Don't take chances — buy the best.
- ★ Experienced cranberry consulting service offering pheromone traps and baits.
- ★ Right to know training.
- ★ Culvert Pipe — All sizes — steel, aluminum, and poly.
- ★ Ditch Mud Mats — Strong — lightweight — durable.
- ★ Burlap Picking Bags — Best for your money.
- ★ Sanding by helicopter.

John C. Decas

William D. Chamberlain

461 Mary's Pond Rd.
Rochester, MA 02770

Office: 295-2731
Evening: 768-8956
Fax: (508) 291-1417

Serving Massachusetts Cranberry Growers

R. A. S. P. INC.

Carrying a Complete Line of:

- Cranberry Chemicals and Fertilizers
- Frost Alarms
- Thermometers
- Chemical Application Equipment
- Kubota K-35 Rental

Contact:

Bob or Mike
3 Plymouth St.
Carver, MA 02330

Phone:

(508) 866-4429

Authorized Agway Representative



editorial



What's in a Name?

Will Ocean Spray and the raisin growers be able to come to an agreement over use of the word *Craisin* or will the dispute wind up in court?

If the latter occurs, it's safe to say the outcome couldn't be predicted with certainty.

This writer knows a couple of young fellows who opened a video store and called it Video Shack. More than a year later, they received a letter from a lawyer representing Radio Shack. The word *shack*, the letter read, can't be used.

The lawyer for Video Shack told the young entrepreneurs they might win the case but spend years in court and thousands of dollars. Their counselor also told them Radio Shack already had *won* a suit against a chain called Chicken Shack. The two changed the name of their store from Video Shack to West Main Video.

Not to say there's a parallel here. But in this field of litigation, many things can happen, including those that defy layman's logic.

Let's Hear It For IPM

There's a disturbing statistic in a piece in *The New York Times* by Philip Shabecoff.

In it he cites a Department of Agriculture finding that crop losses from insects have nearly doubled in the postwar era, to 13 percent from 7 percent.

This despite an explosion in the use of chemical controls.

Nobody in agriculture would be in favor of a wholesale chucking of pesticides.

But the figures do underscore the efficacy of employing an array of weapons for control.

Integrated pest management definitely is here to stay.

WOLLSCHLAGER EXCAVATING

Dragline Work — All Kinds

Also Have Clam & Scalping Buckets

Route 1 Necedah, WI 54646
1-808-565-2436

Weather

MASSACHUSETTS

May was warm, averaging 1.8 degrees above normal, our warmest since 1979 and eighth warmest in our records. Maximum temperature was 77 degrees on the 23rd and 27th. The first half of the month was average or below and the last half was well above average.

Rainfall totaled 4.59 inches, a little over an inch above normal. Rain occurred on 11 days, with 2.61 inches on the 11th and 12th as the greatest storm. We are about $\frac{3}{4}$ inch below normal for the year to date, but nearly $2\frac{1}{2}$ above 1988.

I.E.D.

Gapen
Realty

112 Acres
FOR SALE

Corp. permit to develop 30 acres of beds. Some ditching completed. Lots of water. House needs work. Good potential.

Ladysmith, WI
\$69,900

2141 8th Street South
Wisconsin Rapids, Wisconsin 54494
(715)423-6550

CRANBERRIES

THE NATIONAL CRANBERRY MAGAZINE

SEND CORRESPONDENCE TO:

**P.O. BOX 249
COBALT CT 06414
(203) 342-4730**

Fax #: (203) 342-1977

PUBLISHER & EDITOR: BOB TAYLOR

**ASSOCIATE EDITOR: CAROLYN GILMORE
(508) 763-5206**

ADVISORS & CORRESPONDENTS

MASSACHUSETTS — Irving E. Demoranville, Director, Cranberry Experiment Station.

NEW JERSEY — Phillip E. Marucci, Cranberry & Blueberry Specialist, Buddtown; Elizabeth G. Carpenter, Chetsworth.

NOVA SCOTIA — Robert A. Murray, Horticulturist, Berry Crops, Research Station, Truro

OREGON — Arthur Poole, Coos County Extension Agent, Coquille

WASHINGTON — Azmi Y. Shawa, Horticulturist and retired Director, Coastal Washington Research & Extension Unit, Long Beach.

WISCONSIN — Tod D. Planer, Farm Management Agent, Wood County

CRANBERRIES is published monthly by Diversified Periodicals, Wellwyn Drive, Portland CT 06480. Second class postage is paid at the Portland, Conn. Post Office. Price is \$15 a year, \$28 for two years, \$2 a copy in the U.S.; \$17 a year in Canada; \$20 a year in all other countries. Back copies: \$2.50, including postage. Copyright 1988 by Diversified Periodicals.

ISSN: 0011-0787
Postmaster, send Form 3749 to:
CRANBERRIES
P.O. BOX 249
COBALT CT 06414

REGIONAL NOTES

MASSACHUSETTS

By IRVING E. DEMORANVILLE

Dr. Robert Devlin of the Cranberry Experiment Station was invited to visit and lecture in Poland May 14-23. Bob was invited by the Academy of Agriculture at Szczecin to lecture on herbicide physiology. He lectured at the Warsaw University Academies of Agriculture at Warsaw, Szczecin and Cracow and at the Pomology Institute at Akierniewice.

* * * * *

Weather data through June 1 show a total of 4 points of a possible 16 that favor keeping quality for the 1989 Massachusetts cranberry crop. The prospect is for *fair to poor* keeping quality. The spring has been wetter than normal and May was the warmest since 1979; this does not favor keeping quality. We strongly recommend fungicide treatments both for protection of the fruit and the vines.

By CAROLYN GILMORE

During a recent visit to the Massachusetts Cranberry Experiment Station in East Wareham, Joseph Walsh, the Republic of Ireland's food minister, promised to help open the

Common Market to more imports of American cranberries. Walsh was treated to a luncheon (cranberry tarts and juice were on the menu) and a bog tour by the Cape Code Cranberry Growers' Association. The Irish official said he was "delighted" with the attitude of growers toward pesticides and chemical food additives, subjects of great concern to Europeans. Growers, he said, "put the consumer first and are very serious about the quality of food."

* * * * *

Hal Thorkilsen, retired president and CEO of Ocean Spray, was recently presented the Farm Credit Banks of Springfield (Mass.) Agricultural Leader Award. In presenting the award, Norman P. Harvey, chairman of the Springfield Bank for Cooperatives, cited Thorkilsen's work in transforming Ocean Spray from a commodity business to a consumer oriented marketing cooperative. During his tenure, Harvey noted, Ocean Spray's sales climbed 750 percent from \$87 million to \$736 million. Net proceeds to farmer members, he said, increased by 800 percent, from \$23 million to \$207 million. Thorkilsen joins an illustrious group of Agricultural Leader Award recipients, including Patrick Leahy and George Aiken, U.S. Senators from Vermont, and George C.P. Olsson, honorary chairman of the board of Ocean Spray.

NEW JERSEY

Guided tours of nearby cranberry bogs and

blueberry farms were one of the features of the sixth annual Whitesbog Blueberry Festival last month. Also featured were tours of Whitesbog Village, where the cultivated blueberry was first developed by Elizabeth White between 1910 and 1916. Other highlights were crafts by Pinelands craftsmen, folk and bluegrass music and acts by the John Herald Band, the Geoff Caldwell Blues and Jug Band, Mike Agranoff, Claire Reynolds and Rhythm Is Our Business, and Steve Key, and a two mile run. The festival is sponsored with the assistance of the New Jersey Division of Travel and Tourism, Tru Blue Cooperative, Pemberton Township and the Lebanon State Forest office. Money raised by the festival goes toward restoration of historic buildings at Whitesbog.

WASHINGTON

Washington State University is seeking a horticulturist to replace the retired Azmi Y. Shawa as director of the Long Beach Research and Extension Unit, which conducts cranberry extension and research services for the state's cranberry industry. The post is a tenure track position in the university's department of horticulture and landscape architecture. Applicants should request information and applications from Dr. Fenton E. Larsen, Search Committee Chair, Department of Landscape /Architecture, Washington State University, Pullman, WA 99164-6414.



New England Bog Equipment



Custom Welding and Fabricating

Now Taking Orders for your Harvest time needs

WATER REEL PICKERS, Priced to start at \$8,500.00

Ride-on, Three wheeled design, A1 Hydraulic driven, Different widths, side reel attachments, and engine options available.

Other Harvest Equipment Also Available

For further information on this or our other Bog related products, contact us at (508) 866-4330, Rte 58, Tremont St., Riverside Mall (rear), South Carver, Mass. Or write:



**New England Bog Equipment
P.O. Box 102
North Carver, MA 02330**

Learning About Bees Is A Never Ending Process

Lloyd Bissonnette Figures Bog Owners Will Raise Own Bees Sometime in Future

By CAROLYN GILMORE

Lloyd Bissonnette's bees stay put.

A Lakeville, Mass., beekeeper with upwards of 450 pollinating hives, he limits the excursions of his bees to Bay State cranberry bogs, blueberry patches and some apple orchards.

Overwintering hives in his less than benign winter climate is no problem—"if you take care of them."

"Just like raising cranberries, you have to follow certain rules," declares Bissonnette.

In the fall, all his colonies get fed two gallons of syrup with medication for extra food and nosma disease prevention. He also takes steps to protect his hives against mite infestation.

As a member of the statewide Agricultural Bee Alliance, Bissonnette joined forces with other beekeepers and growers to successfully petition Massachusetts to approve menthol crystal for controlling tracheal mites. They also sought the adoption of emergency regulations to make sure that imported bees are either mite free or undergoing treatment.

"All we were asking for was the weapons to fight this with," said Bissonnette.

The Alliance was formed earlier this year as a forum through which beekeepers and growers could address issues affecting pollination.

"SOONER or later, the bog men will be raising their own bees,"



AT DUSK, when all his bees are safely home, Lloyd Bissonnette poses in front of one of his 450 hives.

(CRANBERRIES photo by Carolyn Gilmore)

Bissonnette said.

With the federal government abandoning regulatory efforts and uncertainty about state actions, Massachusetts growers will be safer relying on permanently located hives for their pollination needs, he explained.

Growers, he said, can start their colonies either from packaged bees or established hives. A good resource for buying established hives is *The American Bee Journal*, he noted.

"Just make sure the hives have been treated for disease," he added.

Bissonnette said the health of a hive and its pollinating strength cannot be judged from observing bees in slight.

"You have to look in the box," he explained.

A good pollinating unit should have six to eight frames of brood.

In his day-to-day operation, Bissonnette drives around to different bogs to examine his hives.

"I check the hives to see if the queen is laying," he said. "If a hive is no good to my bee customer, it is no good to me. Anytime a customer wants to look in the hive, I will open the box."

BISSONNETTE learned about bees from his father.

"When I was about 10 years old, I used to go bee hunting with my father," he said. "When we found a hive, we would have to get permission to cut the tree. My father was my teacher. He rented bees in the 30's and 40's."

Bissonnette's own three sons have also grown up with bees and they help move bees today when needed. Rod Rodriques, Bissonnette's son-in-law, also has an apiary and bee supply business and is available as a bee consultant.

Bissonnette is generous with his lifetime of bee knowledge. He has trained so many bee inspectors over the years that he has lost count.

Wayne Andrews, a state bee inspector who examines thousands

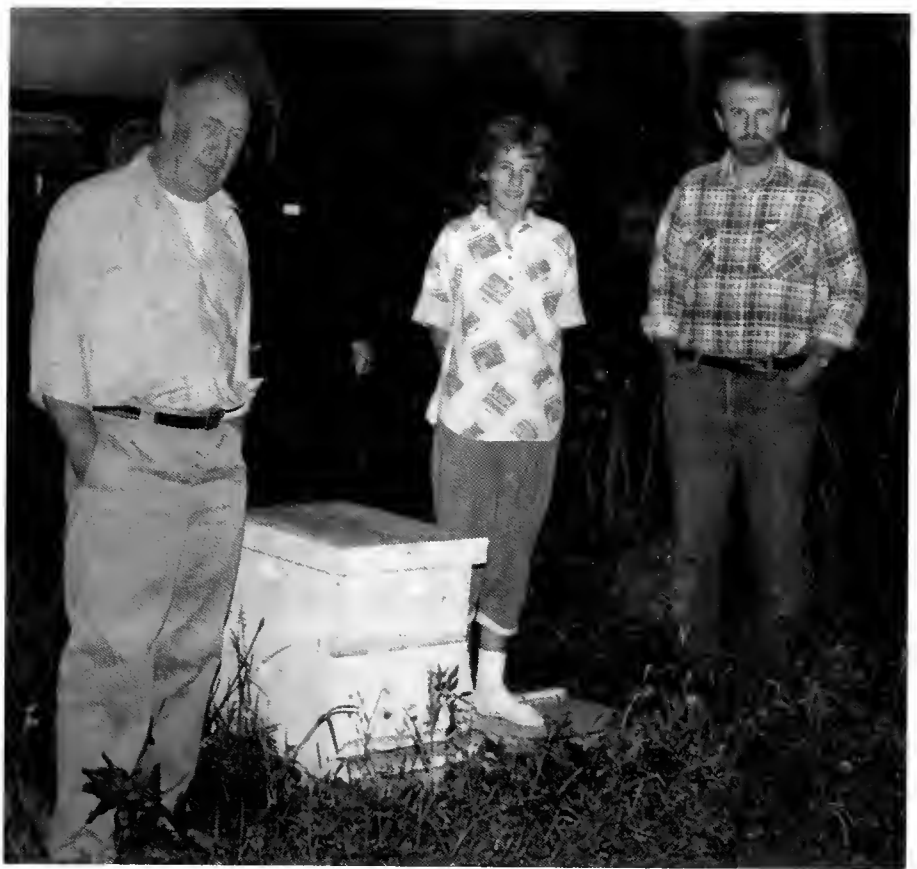

BISSONNETTE and his son-in-law, Rod Rodriques, and granddaughter, Jennifer Rodriques.
(CRANBERRIES photo by Carolyn Gilmore)

of hives in the cranberry growing area each year, rates Bissonnette's operation as one of the best.

Raising bees is a continuous education for Bissonnette. In this

way, he is like the noted bee researcher, E.R. Root, who, on his dying day, said he would like to know *half* of what there is to know about the bee.

Pump Repairs & Sales

All Types

- **Field Service**
- **Chemigation Equipment Sold**
- **Demonstration by Appointment**

**AAA Industrial
Pump Service Inc.**

Bruce Sunnerberg
66 Lake Street
Plympton, MA 02367
(617) 585-2394

Beekeepers Given Okay on Menthol

In a move designed to help beekeepers protect their hives from tracheal mite, Massachusetts has approved the use of menthol to combat the highly destructive predator. The state claims to be the first to formally approve use of the chemical.

The state Pesticide Board subcommittee approved two formulations of menthol crystals to be used against the widespread tracheal mite, which experts say could destroy 90 percent of the state's 10,000

resident hives if left unchecked.

The menthol treatments had been approved for use by the federal Environmental Protection Agency but individual states must register the product before it can be used.

"This gives our beekeepers a tool to control tracheal mites," said Warren Shepard, chief of the state Bureau of Plant Pest Control. "This should give our beekeepers an edge over their counterparts in other states in the battle against a pest that is very damaging to honey-

bees."

The tracheal mite is so named because it plugs the windpipe of honeybees, with death ensuing. In Great Britain, the tracheal mite wiped out the bee population. Officials say the potential for such destruction exists here, as well. The menthol treatment, however, is very effective at eradicating significant numbers of tracheal mites without harming the bees in any way.

In addition to the 10,000 resident hives, Massachusetts is also a temporary home to 15,000 to 20,000 migratory hives which are brought to the state each year to pollinate the apple and cranberry crops.

The ruling by the Pesticide Board means Massachusetts beekeepers are free to purchase and use as much menthol as they require. Only two dealers, Dadant & Son in Hamilton, Ill., and Mann Lake Supply in Hackensack, Minn., are authorized to sell the product, however.

Detailed directions cover use of menthol as well as the chemical's storage and disposal.

China is the world's major sup-

plier of menthol. Prices for the product have been going up, attributable in part perhaps to the recent troubles in China. The greatest demand for menthol is by candy manufacturers.

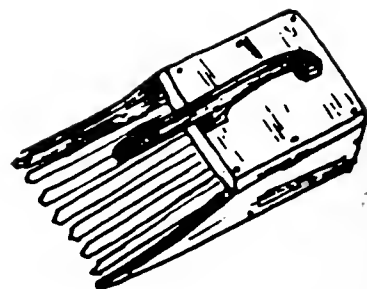

Turf **Equipment Inc.**
 381 West Grove Street (Rte. 28)
 Middleboro, MA 02346

KUBOTA Diesel Equipt.

Tractors 2 & 4 wheel drive — 12-90 hp.
Compact Excavators 1½ to 6 ton
Wheel Leaders ½ to ¾ yd.
Water Cooled Diesel Engines 4 to 104 hp.

All Types of Implements
Polymark Beaver-Mowers **947-6299**
Specialty Fabrication Work
Kubota Financing as Low as 8½%

*Sales *Service *Parts *Leasing

Office
295-2222

K. Beaton
295-2207

BEATON'S
CRANBERRY
GROWERS SERVICE

D. Beaton
888-1288



P. Beaton
947-3601

Specializing in

○ COMPLETE BOG
MANAGEMENT

○ NETTING

○ DITCHING

○ HARVESTING
(Wet & Dry)

○ SANDING

○ CUSTOM
HERBICIDE
APPLICATION

Complete line of portable Crisafulli Pumps 2" - 16"
Plastic netting for suction boxes





THE BEST — IN EVERY RESPECT

CRANBERRY Model 400 GT

Precision Chemigation System



- Developed *Exclusively* for the Cranberry Industry
- Exceeds or Meets ALL Current EPA Requirements
 - Simple to Operate and Easy to Calibrate
 - Self-Timer Application (1 minute Increments)
 - Easy Access Handle & Simple Reference Scale
 - Precise Visual Flow Calibration
 - Outstanding Field Performance
 - Down-Line Venturi Injection System
 - High Capacity 0-7 GPM Injection Rate
 - Large Volume 175 Gallon Mix Tank
 - 12 Volt Gear Reduction Mixer
 - Designed for Trouble-Free Operation
 - Reliable 11 HP Honda Electric Start Engine
 - Critical Components Are Stainless Steel & Polypropylene
- Completely Self-Contained and DOT Approved Transportable
- Personalized, Experienced Support Service as Close as Your Phone

CHEMIGATION SYSTEMS INTERNATIONAL, INC.

**Corporate Offices: P.O. Box 247
(608) 297-2041**

**Montello, WI 53949
FAX: (608) 297-7248**

Call us today for the dealer nearest you, or contact:

**Skip Tenpas
Central Sands Irr. & Bldg., Inc.
Hwy 51 & 73 Interchange
Plainfield, WI 54966
(715) 335-6372**

**Bruce Sunnerberg
AAA Industrial Pump & Ser., Inc.
66 Lake Street
Plympton, MA 02367
(617) 585-2394**

NOTICE

**Selected exclusive
dealer territories
still available —**

Inquiries Invited

Memories of Charley Doehlert

By PHIL MARUCCI

Charles A. Doehlert, former director of the Rutgers Cranberry and Blueberry Research Laboratory and secretary of the American Cranberry Growers Association for 20 years, died at Christmas time in 1987. He was a pioneer in the science of cranberry and blueberry culture. The work done at the substation of the New Jersey Agricultural Experiment Station by Doehlert and his associates (R.B. Wilcox, C.S. Beckwith, W.E. Tomlinson) contributed much to the progress of these new crops when they were in their early stages of development and during periods of crisis.

CHARLIE was a man of admirable character and of great versatility. In these days of high specialization, it is hard to believe that during his career at the experiment station he served as editor, horticulturist, entomologist and even as an agricultural engineer.

It was as an extension agent that Charlie made the most effective and significant impacts on individual growers and the entire cranberry and blueberry industries. He fostered a very close relationship with growers. His frequent visits to farms and field demonstrations were at the heart of his *modus operandi*. He also encouraged growers to become involved in the direction and planning of the work of the experiment station.

I remember an incident which demonstrated growers' cooperativeness and anxiety to help during Doehlert's tenure. It occurred very shortly after I arrived at the Pemberton laboratory in 1948. Charlie was concerned about not being able to provide a needed facility to conduct my insect vector research.

As was his custom when problems arose, he contacted the Growers Advisory Committee. He wrote a short note on a postal card, addressed to eight growers and requesting their presence at a meeting a few days hence to discuss a problem. All of the growers attended and the problem was solved in a few minutes.

Growers provided all of the labor and



CHARLES A. DOEHLERT was a pioneer in cranberry and blueberry culture.

(Photo by Adam Stein)

equipment and some of the materials to build a greenhouse which would assure that no insects would feed on blueberry test plants. Incidentally, the cost of this communication with growers was 8 cents; postal cards still cost only a single penny.

ANOTHER memorable feature of Doehlert's extension work was his ritual of making regular visits with county agents to blueberry fields and cran-

berry bogs. It was already understood that growers with urgent problems could get immediate attention by telephoning the station; the reaction to such a call was as a fireman's to a fire. For a general review of farm practices and general inspection of farm conditions, a farmer could call his county agent to schedule a date for a visit.

Once a month, Charlie would visit Burlington County fields with Dan

Kensler, Atlantic County fields with John Brockett and Ocean County fields with Dick Hartman. (All of these county agents had national reputations and are now legendary in New Jersey.) In this way, the opportunity to receive expert opinions and authoritative recommendations for individual farm situations was open to every blueberry and cranberry grower in the state.

Inexperienced newcomers were particularly interested in using the service, but even experienced and successful growers felt they needed it to sharpen their alertness and efficiency.

CHARLES Doehlert's name should

live on not only for the influence he had in his extension work but also for his meaningful and important research work.

He was one of the first to work on cranberry and blueberry nutrition. Some of the fundamental fertilizer practices still regularly carried out in these crops are the results of his research. His "Facts About Blueberry Fertilization" (N.J. Ag. Exp. Sta. Circular 550, 1953) is still one of the most sought pieces of blueberry literature.

Charlie was also one of the first in the country to study airplane applications of fertilizers and pesticides. His

YANKEE PLANNERS, INC.

59 North Main Street
Middleboro, MA 02346
(508) 947-0527

Sound and Objective
Advice
Suited to
Your Needs

- Tax and Estate Planning
- Investment & Insurance Review
- Business Continuity
- Asset Protection
- Key Employee Retention
- Business Tax Analysis

Mr. William H. Bestgen, Jr.
Chartered Financial Consultant

Mr. Peter W. Hutchings
Attorney at Law practicing as
a Tax Attorney

Mr. Roger H. Parent, Jr.
Accountant, Enrolled to Practice
before the Internal Revenue
Service

Call For Your Free Brochure
(508) 947-0527

SKIPPAR POLE SERVICE

- Private Poles • Line Construction
- Sonotube Drilling • New & Used Poles

(508) 690-2238

208 Franklin St., East Bridgewater, MA 02333

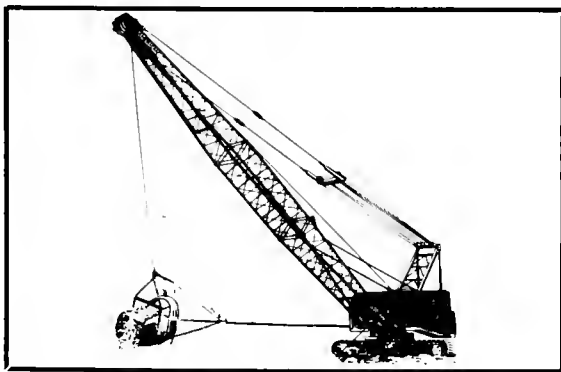

Krause Excavating, Inc.

Canal Work
Pond Construction

Ditching
Land Clearing

1-1/4-3 yd. draglines with 80' boom and matts, 2 yd. backhoe, swamp dozer and other related equipment.

Contact:

Roger Krause 1-414-398-3322
Route 3 Markesan, Wis. 53946

early studies in blueberry pruning set the guidelines for this most important blueberry operation. Those guidelines still are being used.

Blueberry propagation as now practiced commercially varies very little from his original findings and recommendations. With Ray Wilcox and Charles Beckwith, he helped to battle the cranberry false blossom disease plague which swept through New Jersey bogs from 1918 to the early 1950's, demoralizing growers and almost

completely eliminating the cranberry industry in the state.

He was the developer of the Doehlert Discs, which enabled growers to properly cultivate blueberry plantings without inflicting the serious root damage caused by conventional cultivators. With Bill Tomlinson and this writer he helped to discover the vector of blueberry stunt disease which posed a serious threat to the blueberry industry of New Jersey in the 1940's and 1950's. With Charles Beckwith he helped in research to develop practical sanding procedures and water management techniques for cranberries.

It is not generally known that Charles Doehlert was the discoverer of stem canker disease. This is the most destructive natural enemy of blueberries in North Carolina and has recently begun to make inroads in New Jersey in a few areas on a few cultivars. This fungus disease is endemic in North Carolina and was not even known by plant pathologists until it was noticed by Charlie and brought to the attention of scientists on one of his infrequent trips to the southern blueberry area.

This is an example of Charlie's keen powers of observation. In the field his senses were strongly attuned to the normal condition of a blueberry plant or a cranberry vine; any semblance of

variation from the norm would be immediately recognized in an almost automatic reaction. He also had the rare skill of evaluating the abnormal symptoms in terms of cause and effect.

Charlie was a dedicated and industrious worker who planned his experiments in scrupulous detail and carried them out with diligence and precision. While he had many attributes of a workaholic, he could not be described as one for that implies a singlemindedness

CRANBERRY



COMPUTER, INC.

CRANWARE

- Growers
- Handlers
- Chemical Applications
- Chemical Resale

(508) 747-3033

P.O. Box 1037, Plymouth, MA 02360

CRANLAND SERVICES

Cranberry Property Appraisals

★ ★ ★ ★ ★

Listings and Sales of Cranberry Properties.
License # 68987

Lawrence W. Pink
Old Cordwood Path
Duxbury, MA 02332
(617) 934-6076

22 years experience  *construction lifts* 



AERIAL LIFTING

◦ **BERRY LIFTING** ◦

nylon berry bags
bulk bins

◦ **MUD LIFTING** ◦

NEW MATS

lightweight
durable

JOE BRIGHAM INC

BEATON'S CRANBERRY GROWERS SERVICE

WARHAM MASS.

mat rentals & sales

contact
PETER or CHUCK
508-295-2222

that excludes interests not directly related with work. He was especially devoted to his family and contributed much of his time to community activities and to his church (Quaker).

As a person, he was friendly, gentle and highly sensitive to the sensitivities and needs of others. He recognized and appreciated human dignity in all classes of agricultural workers. He was intelligent and scholarly (a Phi Beta Kappa graduate of Rutgers in 1921) but he had the facility to explain scientific concepts to farmers in simple, clearly understandable terms.

CHARLIE'S many worthy and significant accomplishments justify great pride. By his own evaluation, the achievement of which he was most proud is the rearing of a wonderful family. With his faithful and inspiring wife, Irene, three children were brought up in a home environment where caring for each other and abiding by Quaker ideals prevailed.

Charles, the eldest, has had a distinguished career as a physician and served on the staff of the world famous Mayo Clinic. David, the second born, has been an educator and a successful businessman. Margaret, the youngest,

is a mathematician and sociologist.

Margaret writes to tell that her father's influence is still strong and has been passed on to the next genera-

tion. Just how strong can be seen by the fact that three of Charlie Doehlert's grandchildren—yes, *three*—have become horticulturists.



CEECO CORPORATION

OF NEW ENGLAND

Industrial Suppliers To The Cranberry Industry



Chain, Cable and Accessories
Used for Making Mats

All Types of Fasteners (Bulk & Packaged)

Hand Tools	Pumps
Power Tools	Motors
Chemicals	Abrasives
Lubricants	Cutting Tools
Safety Equipment	

Richards Rd.
Plymouth Industrial Park

747-0086
Plymouth, MA 02360



**MIDDLEBOROUGH
TRUST COMPANY**

The Business Bank.

MTC offers you business banking built to your needs.
Personal attention to your special
financial requirements now and as you grow. Cooperation.
Flexibility. Complete business and personal banking.
Member FDIC



Main Office

10 John Glass, Jr. Square, Middleborough

Branch Offices

Middleboro Square, Rt. 28, Middleborough • Middleboro Plaza, Middleborough
Cranberry Plaza, East Wareham • Carver Square, Carver • Trucchi's Plaza, Taunton
Telephone all offices **947-1313**

Marketing Committee Invites Cranberry Growers to Meeting



DAVID FARRIMOND, Cranberry Marketing Committee general manager, is busy these days with details concerning the committee's summer meeting.

(CRANBERRIES photo by Carolyn Gilmore)

By CAROLYN GILMORE

Growers should attend the summer meeting of the Cranberry Marketing Committee and familiarize themselves with the amendment process, says David Farrimond, CMC general manager.

At this writing, the session was slated for Aug. 24 in Madison, Wisc.

"The committee continues to work toward holding hearings on proposed amendments of the marketing order, including conversion to a rolling base concept," said Farrimond.

The amendment process was initiated five years ago to change the way base quantity is assigned.

The Cranberry Marketing Committee, which represents the growing states, administers the

provisions of the marketing order.

"We are seeking to open up the order a little," Farrimond said.

Under new changes proposed for the order, restrictive details concerning assignment of base quantity would be removed from the order and become part of the rule making process. This would give the committee more latitude in choosing how a rolling base quantity would be assigned.

The committee could then opt to assign base quantity according to each grower's best average four out of the past six years. Or it could change the formula to another average, such as the best three out of the past five years or the highest six of the past seven years, Farrimond explained.

Also on the agenda for the August meeting is confirmation of the estimates for the 1989 crop. At the March meeting, held in Philadelphia, the committee predicted a 4,015,000 barrel crop.

"The committee has been amazingly accurate in these long range predictions in the past," Farrimond said.

Also to be examined is the handler inventory report summary, supply and demand estimates, the annual budget and the per barrel assessment rate.

The committee will be welcoming a new alternate public member, Mary L. Petrie, program analyst for USDA-APHIS Biotechnology Permit Unit, Hyattsville, Md.

Cranberry Marketing Committee members are: Marshall Severance, chairman; Robert Christiansen,

Clogged Suction Screen?

This Screen Stays Clean



SURE-FLO
Self-Cleaning
Strainers

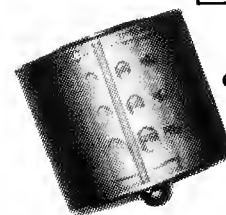

capacities to
3850 gpm

patent no.
4822486

Save Time — eliminates the headache of manual screen scrubbing

Save Money — maintains maximum pump efficiency

For more information:

Perfection Sprinkler Co.

2077 S. State St.
P.O. Box 1363
Ann Arbor, MI 48106

313 761-5110 FAX 313 761-8659



vice chairman; Richard Indermuehle, secretary; John C. Decas; Joseph Darlington; Charles Thompson; Martin Potter, and Rita Wood, public member.

Alternates are Robert Hiller, Stephen V. Lee III, Alvan Brick, Mary Brazeau Brown, Ray Habelman Jr., Frank Glenn III. USDA field representatives assigned to the order are Patty Petrella and Jackie Schlatter.

Phone numbers for the Cranberry Marketing Committee's Wareham office are (508) 291-1510 or 1-800-253-0862.

CCCGA Sets Up Annual Meeting

The annual meeting of the Cape Cod Cranberry Growers' Association will be held

this year on Tuesday, Aug. 22 at the Massachusetts Cranberry Experiment Station in East Wareham.

There will be equipment displays, a chicken barbecue and a short business meeting, according to Jeff Carlson, CCCGA executive director.



Gapen
Realty

Cranberry Marsh
FOR SALE

*6 acres planted, *17 acres ready to be planted *3 homes
\$175,000

Washburn County, WI
2141 8th Street South
Wisconsin Rapids, Wisconsin 54494
(715)423-6550



Lampert, Lee & Associates

CONSULTING ENGINEERS
SURVEYORS

Extensive experience in all aspects of cranberry land development: evaluation, purchase, survey, design, permit acquisition, phased construction and planting both in wetlands and uplands.

Have references. Will travel.

Contact: Will Lee
10948 Highway 54 East
Wisconsin Rapids, WI 54494
(715) 424-3131



Turf

Equipment, Inc.

381 West Grove St. (Rte. 28)
Middleboro, MA 02346

(508) 947-6299

 **KUBOTA**

Tractors, Excavators and Diesel Generators

 **COYOTE**

Wheel Loaders
3/4 Yd - 6 1/2 Yd

 **malco**

Screening Equipment



BLUE HERON
FARMS
GROWER SERVICE

MOWING (all types) * DITCHING
WATER HARVESTING * SANDING

"Specializing in the Needs of Small Growers"

Call Wayne or Karen Barnes

72 Brook St.
Plympton, MA 02367
1-617-585-9830



Protect Your Records Against Disaster

By **JOSEPH ARKIN**

Carelessness and lack of foresight by owners and managers are all too common in the handling of business records.

Could your firm survive if all of your financial, legal and operating records were lost forever?

Your answer has to be a resounding NO! Yet important and irreplaceable documents are destroyed each day through fire, storm, flood, tornado and other disasters. This is because most regular records are vulnerable to loss and destruction.

Managers of disaster-struck firms usually seek to reconstruct once thriving businesses by asking banks, the Red Cross, the Small Business Administration or other governmental lending agencies for financial help. This sought after aid is often lost because figures are not available to substantiate the loss nor can any figures be submitted to accurately determine what help was needed and could be prudently furnished.

There are several important aspects to consider with respect to the loss of operating records. The loss claim filed as a result of physical damages to your business premises must be prepared. Insurance investigators and claims agents are sticklers for detail and accuracy. If all current records are destroyed, there is extreme difficulty in ascertaining the true extent of the loss, and, more often than not, compromise settlements cause great financial loss to the insured.

Next are records that involve various taxing authorities. Business firms are required by law to retain (for specified periods of time) copies of social security, state unemployment, sales and excise tax records, substantiation of business expenses, depreciation schedules, and related income and expense records.

In addition, employees may require your testimony or other proof of their earnings or absence from work.

Federal and state examiners will want to exercise their right to check your payroll records to see if you have complied with minimum wage requirements and payment for overtime pay.

Revenue agents have the right to

strike out your claim for depreciation unless you can show records substantiating original purchase—all of which may have been five, ten or more years in the accumulation.

If your tax returns are questioned and the treasury agent finds upon inspection that you haven't appropriate records to justify what you claim, you are told both orally and by letter to keep permanent books of account plus the following original records: invoices, bills, vouchers, cash register tapes and receipts. These items, therefore, should be added to your list of records which should be protected against disaster.

In fact, if a followup investigation shows that a businessman has consistently failed to maintain proper records, the Internal Revenue Service may hail him into court on the charge of willful negligence. The penalty for this misdemeanor is a fine of \$10,000 or one year's imprisonment, or both, plus the court costs.

If you want to take the full deduction for unusual expenses, such as entertainment and travel which are incurred on behalf of your firm, they should be

fully documented to show that they are both accurate and allowable. These records, therefore, have lasting value.

Business records are also important for the restoration of any business. Copies of contracts, bids, proposals, correspondence, etc., are all essential to stabilize future dealings with customers and suppliers.

Of prime concern, too, are records of your receivables and payables. The Mosler Safe Co., in its advertisements for fire retardant safes and storage cabinets, claims that the majority of firms losing their business records never reopen their doors.

This is the problem. How can small business firms with moderate financial resources protect themselves against the loss of all or a substantial part of their records?

The starting place is to take stock of the situation. Valuable papers which are used infrequently can be placed in a safe deposit vault (in a bank or other institution offering storage facilities where they will be adequately protected from fire, wind and flood damage. Such vaults are available for rent in most cities; the cost is low when compared to

R.D. GRASSI *Cranberry* SERVICES

**Herbicides
Applied**

*Custom Pruning
Custom Ditching*

**West Wareham,
Massachusetts**

**Sanding
Wiping
Wet Harvesting
Mowing**

*(Mowing includes
Hydraulic Arm
Flail Mower.)*

**Ask for Rick at
295-5158**

the potential loss.

These items can be kept on the premises if you provide suitable storage facilities offering protection against fire and water damage to the nth degree.

Current records of accounts payable and receivables should be reproduced regularly and preserved in a safe place. Similar precautions should be taken for sets of tracings, blueprints, drawings, important specifications, documents and patents, as well as for sets of models and prototype mechanisms. Special care should be taken of items for which it is not feasible to make and store a duplicate. Insurance policies and related data also deserve special care.

THE SETTLING of claims can be greatly accelerated when adequate information is available. Then, too, if a dispute arises between the businessman and the insurance company, proof of loss through accurate documentary evidence may save thousands of dollars for the insured.

Remember, however, that such safety measures are worth very little if the material you safeguard is out of date. Unless all documents are maintained on a reasonably current basis or have a long-term value, you are missing the point of the whole procedure.

After assembling the material (old and current) that you desire to be protected, contact a warehouse, bank or other safe-keeping institution and describe your space needs. They'll quote prices for the bulk storage of records.

When you have satisfied yourself, in concurrence with your chief assistants, that what has to be protected has been adequately provided for, set up a system to keep them current. You must have a plan to keep copying records and sending them away for safe storage.

What about microfilm? You can use microfilming in one of three ways: (1) have it done on contract; (2) do it yourself with rented equipment; (3) do it internally with purchased equipment. The main deciding factors are cost, volume of work and control requirements.

The great advantage of microfilm is space saving. This can be very important if the protected storage space you plan to use is relatively expensive. Obviously, when reduced to microfilm, a great many documents can be fitted into the size of an ordinary desk drawer. If, however, you can get well-protected storage space at relatively low cost, be very careful to compare the cost of storing duplicate, full-sized documents with the cost of microfilming. The National Records Management Council claims that you can store full-sized records for several years at less expense than the initial cost of microfilming.

Don't overlook the role of your accountant in helping you to prove claims for loss and to help you in the reconstruction of any records that are destroyed by a catastrophe.

In this respect, you will do yourself a valuable service if you have an accountant on a

regular monthly basis. Insist upon record keeping involving a general ledger and supporting journals. Accept nothing less. In this fashion, the monthly trial balance taken at each visit serves as a cutoff point to reconstruct what has happened during the period of the records' destruction.

Here is how a system of utilizing your accountant's monthly visit might work:

(1) Your accountant calls, say, on the 18th of a particular month and completes his write-up or audit of your books to the last day of the previous month. He takes a trial balance (which provides cumulative sales, purchases and other pertinent figures), list of accounts payable and accounts receiva-

ble and other schedules.

(2) Each day's billing is prepared so that there is one extra copy of each sales invoice for mailing or other transmittal) to another location—your home, your accountant's office, etc.

(3) A list of receipts is maintained and kept off your premises.

Now suppose your office records were destroyed on the 20th of the month. It would take but little time for your accountant to start from the records he obtained on the 18th for the last day of the previous month, and add on billing from the 1st to the 20th, subtract remittances, and come up with current accounts receivable balances. The same

Financial Strength. . . Personalized Service. Isn't That What You Need In A Bank?

The Jackson County Bank has supported agriculture in the area for more than 110 years.

We recognize the importance of the cranberry industry and are pleased to provide financial services for all your banking needs.

We're large enough to serve you and yet we offer personalized service which your business demands. Call us at 715-284-5341

The Jackson County Bank. A name to count on throughout the years.

You'll like the difference.



**JACKSON
COUNTY
BANK** Member FDIC
(715) 284-5341

Black River Falls, Alma Center, Hixton, Merrilan, Taylor, WI 54615

WANTED Gravel & Sand

in the southeastern Massachusetts area

Quantities of 10,000 yards and up

Complete site work, bog construction and finished contouring of surrounding area plus the best price for your material.

**Michael Coan
Carver, Mass.
(508) 866-5285**

**Earl White
Medfield, Mass.
(508) 359-7291**

system can be used for accounts payable.

Your accountant's work sheets and his office files will contain pertinent information about your operations. Also, his tax files will contain valuable supporting schedules to substantiate purchases of fixed assets subject to depreciation and similar information.

YOU can also purchase a type of policy which has been tailored to protect you in case of record loss or damage. Your insurance agent can check with casualty insurance companies to locate low cost coverage for a policy called "valuable paper insurance." Its cost is at a rate slightly in excess of the regular fire insurance rate, but you need only insure the valuable papers for that amount which you believe would compensate you adequately for their loss.

Valuable papers (exclusive of cash or securities) can be insured against "all risks" on: (a) a blanket basis with the amount of insurance purchased available to meet the expenses of reconstructing the missing, damaged or destroyed records; (b) a scheduled basis with specific dollar amount(s) assigned to the items insured (this will be the amount paid in case of loss); and (c) a combination of the two foregoing methods.

Exactly what does a valuable paper insurance policy cover? The insurance company will pay you for the costs (investigation, redevelopment, research, labor, etc.) of reproducing records which have been destroyed, damaged or lost. Where reproduction is not possible, payment will be made for the agreed value as specifically listed in the schedule. It should also be noted that while an insurance company could replace scheduled items at its option, this is rarely done. The insurance company could, however, exercise its privilege if a scheduled amount of insurance turned out to be excessive and if the item(s) could somehow be reproduced.

The questions and ramifications of this area of coverage should be discussed with the insurance company's representative in advance.

Some points to be taken into consideration concerning a valuable papers policy are:

If any of your records are of such a nature that they cannot be replaced or reproduced, be sure to include them under the "specified schedule" of items rather than under the blanket policy. Don't assume a false sense of security from the fact that many of your records cannot be converted into cash. The destruction of valuable papers can cause a long period of delay in getting back into business, if ever.

There are some who claim that the destruction of records is sometimes covered by "business interruption" clauses in your fire policies. Because opinions differ on this subject, it is suggested that you have your insurance agent verify the protection provided under the terms of your present fire insurance policy and business interruption rider.

THE threat and risk of disaster exist whether you forget them or not. You seldom, if ever, get all your affairs in perfect shape.

Furthermore, your business needs to have its important records protected more when the risks are not evident, and when affairs are not in "apple pie" order, than when they are. Procrastination increases the risks of loss and waste—and competitive disadvantages.

"Putting off the start of a constructive program is a major reason for being caught short when misfortune occurs," says Edward

J. Stewart of the Small Business Administration. "Intelligent plans and positive action are essential if you are to give your business a reasonable chance of survival and recovery. Just as you insure a home and personal property against loss, so also should you protect your business against disaster by safeguarding and insuring its vital records. The time to begin is now."



'I HAVEN'T PLANTED ANYTHING. THOSE ARE MOLES!'

J.A. JENKINS & SON CO.
Grower Service

**MOWING (ALL TYPES)
SANDING** **DITCHING
WEED WIPING**

Serving Cape Cod
227 Pine St., W. Barnstable, Ma. 02668
Phone 362-6018

Irrigation Equipment Designed Especially for the Cranberry Industry

- Gorman-Rupp Self Priming Electric Sprinkler Pumps
- Proven Quick Couple Riser
- Polyethylene Main Lines, 3" - 12"
- Butt Fusion Equipment Available
- Paco/Wemco Water Harvest Pump
- Berkeley Self-Priming and Centrifugal Pumps

A Most Complete Inventory of Irrigation Accessories

LARCHMONT

IRRIGATION / SNOWMAKING

P.O. Box 66, 11 Larchmont Lane
Lexington, Massachusetts 02173 (508) 862-2550

Contact

Larchmont Engineering
Phil Tropeano, President
(508) 862-2550
(Call Collect)

Stearns Irrigation, Inc.
790 Federal Furnace Rd.
Plymouth, MA 02360
(508) 746-6048

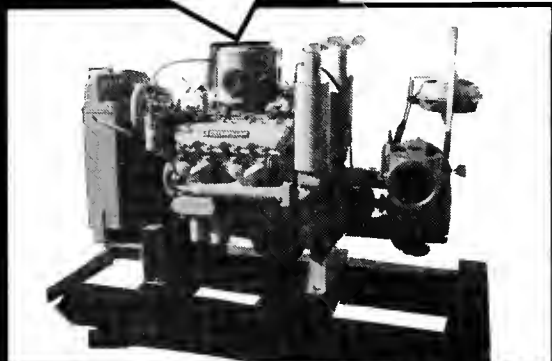
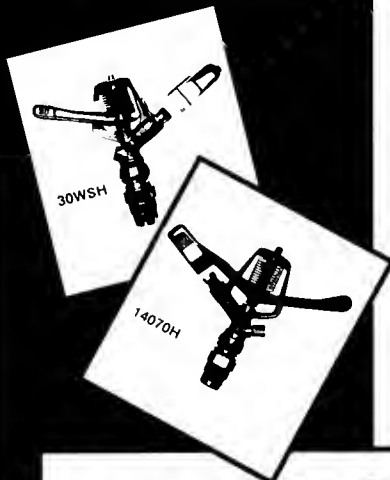

K Ag Laboratories International, Inc.

2323 Jackson Street
Oshkosh, WI 54901

Serving Cranberry
Growers in U.S.A.
& Canada since 1984

Over 20 years
of Experience on
Acid Soil Interaction

K Ag Laboratory has
run over 30,000
cranberry soil and over
17,500 cranberry vines
tests since 1984, and
gave fertilizer
recommendations with
great success.

- ★ *Cranberry Soil Analysis*
- ★ *Cranberry Vine Analysis*
- ★ *Cranberry Water Analysis, Usage & Interpretation*
- ★ *Liquid & Dry Fertilizer Recommendation*
- ★ *Soil Problems & Consultation*
- ★ *Seminars*
- ★ *Cranberry Crop Monitoring Program, testing and monitoring nutrient status with 30 day intervals during the growing season.*

Highly computerized cranberry soil, tissue and water testing program in U.S.A. and Canada.

For more information contact: Dr. Akhtar Khwaja, Ph.D.
Certified Professional Soil Scientist
Certified Professional Agronomist

Phone Number 414-426-2220; Out of WI 1-800-356-6045; FAX 414-426-2664

Take Good Care of Yourself Have an Ocean Spray!



The farmer's cooperative that brings you
a wide range of natural fruit juices, drinks and sauces

Ocean Spray Cranberries, Inc., Lakeville-Middleboro, MA 02349
An Equal Opportunity Employer

3
3
7
5

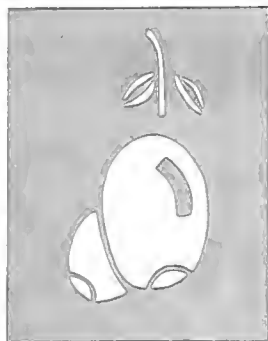

CRANBERRIES
THE NATIONAL CRANBERRY MAGAZINE
September 1989 Vol. 53, No. 9



Cranberries & Conservation

Biological Pest Controls

Cranberrying

UNIV OF MASS LIBRARY
SERIALS DEPT
AMHERST MA
01003

lr

S

DRESSER + BARK RIVER

*Quality products and
trained, dedicated people
standing behind them.*

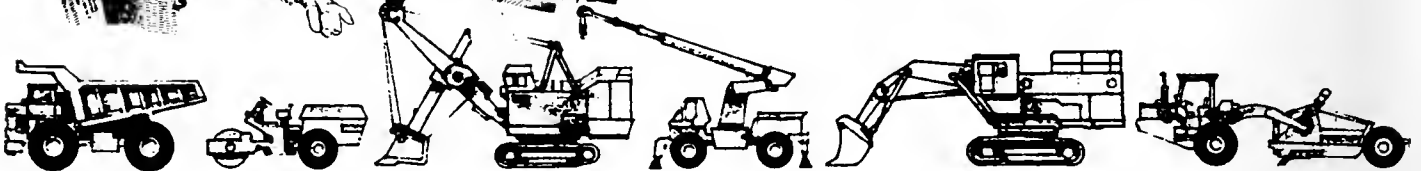

It's a combination that adds up to top production for you!

Then add BARK RIVER's full line of other quality tools and equipment and you have a complete source for all your equipment needs, all backed with dependable product support.



Crawler Loaders
Crawler Tractors

Draglines
Drills
Graders

Hydraulic Excavators
Hydraulic Shovels
Planers

Rollers
Scrapers
Shovels

Trucks (off-highway)
Wheel Loaders

- FRINK SNOW-PLOWS
- FMC WAYNE STREET SWEEPERS
- CLARK-BOBCAT SKID STEER LOADERS
- WISCONSIN TRAILERS
- VAC-ALL BY LEACH
- GAFNER IRON MULE
- TIGER HIGHWAY MOWERS
- HITACHI EXCAVATORS AND CRANES
- PAPER, CALMENSEN BLADES AND CUTTING EDGES
- FOX SPREADERS
- WALDON LOADERS
- GRADALL INC. EXCAVATORS
- MURPHY DIESEL ENGINES
- KOLMAN CONVEYORS
- MORBARK EGER BEEVER CHIPPERS
- FAIR SNOWBLOWERS
- AMZ ASPHALT PATCHING EQUIPMENT
- SICARD SNOWBLAST SNOWBLOWERS

Manufacturers of corrugated steel & aluminum culvert pipe and drainage products.



BARK RIVER Culvert & Equipment Co.

Backing you with 83 years of experience.

EAU CLAIRE
1700 Western Avenue
Phone (715) 835-5157

MADISON
Highway 51 & Buckeye Rd.
Phone (608) 222-4151

ESCANABA
430 N. Lincoln Street
Phone (906) 786-6920

GREEN BAY
600 Liberty Street
Phone (414) 435-6676

SUPERIOR
1213 Winter Street
Phone (715) 392-2243

MILWAUKEE
11715 W. Silver Spring Rd.
Phone (414) 461-5440

CCCGA Study Concludes

Cranberry Agriculture Enhances Environment

By CAROLYN GILMORE

Cranberry growers play a major role in keeping Massachusetts green and inhabited by wildlife.

That's the main conclusion of a study undertaken by the environmental committee of the Cape Cod Cranberry Growers' Association.

"Land owned by cranberry growers is important not only for agriculture but for other needs in our area," says Wayne Barnes, environmental committee chairman. "We have a green belt of thousands of acres that buffers development, filters storm water runoff, serves as a wildlife refuge, helps control growth, cleans the air

and is beautiful to see—all at no cost to the public."

The committee's findings are the result of a year long project aimed at quantifying the amount of open space associated with the cranberry industry.

Detailed surveys—backed up by

aerial mapping, measurements and tax assessor records—profile the contribution growers make to preservation of land and wildlife habitats.

The object of the study was to document for those who tax, regulate and question the industry that there is more to growing cranberries than what appears between the ditches.

The findings will soon be published in booklet form and distributed to government officials, environmentalists and others who affect the industry.

The research showed that Massachusetts cranberry growers own

COVER PHOTO

HELEN NOLAN of Carver, Mass., won third prize in the harvest category for this dramatic photo she entered in the Cape Cod Cranberry Growers' Association color photography contest.



**MIDDLEBOROUGH
TRUST COMPANY**

The Business Bank.

MTC offers you business banking built to your needs.

Personal attention to your special financial requirements now and as you grow. Cooperation.

Flexibility. Complete business and personal banking.

Member FDIC



Main Office

10 John Glass, Jr. Square, Middleborough

Branch Offices

Middleboro Square, Rt. 28, Middleborough • Middleboro Plaza, Middleborough
Cranberry Plaza, East Wareham • Carver Square, Carver • Trucchi's Plaza, Taunton

Telephone all offices **947-1313**

more than 61,000 acres of land, 12,244 acres of which is producing cranberry bog.

The average ratio of upland to bog is 4:1, or four acres of surrounding land for every acre of cranberry vines. Much of this upland directly supports the cranberry bog system with reservoirs, watersheds and sand supplies.

One byproduct of cranberry cultivation, according to the study, is the abundant supply of high quality water in the region. In Plymouth County alone, more than 22 percent of the 20,943 acres of surface water is created and maintained by cranberry growers.

Impoundments range in size from one-tenth of an acre water holes to large reservoirs. In some areas, colonial grist mill ponds that otherwise would have been lost to history are serving as part of the cranberry bog system. A total of 45 historic mill sites now operated as bog reservoirs have been located in Plymouth County.

The committee compiled statis-

tics for the surface area of water in bog reservoirs over 3 feet deep by town in Plymouth County.

An informal growers' survey yielded a variety of wildlife observations on cranberry lands.

Among birds listed were osprey, bluebirds, turkey plus an assortment of songbirds and waterfowl species. Coyote, mink, white-tailed deer and red and gray fox were among mammals sighted. The rare Plymouth red-bellied turtle was spotted, along with the more common reptile and amphibian species native to the area.

Rare wildflowers and plants, such as the pink lady's slipper, the white fringed orchid, holly, and even the endangered state flower, the mayflower, were located on cranberry bog uplands.

Open space consultant Linda Rinta endorsed the central conclusion of the CCCGA study with these words:

"The destiny of land preservation in Massachusetts is in the

hands of the private landowners. The public owns very little open space and although communities make elaborate open space plans, they can little afford to buy more. Cranberry growers are indeed conservers and preservers of land and water."

An unrelated land use study made in Buzzard's Bay echoes a similar sentiment about open space and cranberry growing.

Said Randy Bluffstone, a spokesperson for the Buzzard's Bay Economic Analysis and Environmental Issue study:

"On the basis of our research findings, we consider it very positive for cranberry growing to remain an important part of the economic landscape for southeastern Massachusetts. Public policy should be brought to bear to provide incentives for growers to maintain unused space."



K Ag Laboratories International, Inc.

**2323 Jackson Street
Oshkosh, WI 54901**

**Serving Cranberry
Growers in U.S.A.
& Canada since 1984**

**Over 20 years
of Experience on
Acid Soil Interaction**

K Ag Laboratory has run over 30,000 cranberry soil and over 17,500 cranberry vines tests since 1984, and gave fertilizer recommendations with great success.

- ★ *Cranberry Soil Analysis*
- ★ *Cranberry Vine Analysis*
- ★ *Cranberry Water Analysis, Usage & Interpretation*
- ★ *Liquid & Dry Fertilizer Recommendation*
- ★ *Soil Problems & Consultation*
- ★ *Seminars*
- ★ *Cranberry Crop Monitoring Program, testing and monitoring nutrient status with 30 day intervals during the growing season.*

Highly computerized cranberry soil, tissue and water testing program in U.S.A. and Canada.

For more information contact: **Dr. Akhtar Khwaja, Ph.D.**
Certified Professional Soil Scientist
Certified Professional Agronomist

Phone Number 414-426-2220; Out of WI 1-800-356-6045; FAX 414-426-2664

Review of Experiments In Biological Control

By **DAVE SIMSER**

Cranberry pest control, as informed growers know, has been refined by the development of a program known as cranberry integrated pest management (IPM).

Each season, growers who participate in this program are provided with field information collected by trained personnel. Such information permits pest control decisions based upon careful observations, intensive sampling and pest threshold levels. The net result is often a reduction in the frequency and amount of pesticide application, which saves a grower valua-

ble time and money.

In addition to selective chemical applications, however, a sound IPM strategy also utilizes nonchemical techniques to reduce pest numbers, whenever practically possible.

Thus, pest control alternatives are investigated in an effort to decrease the amount of pesticides needed to protect the valuable harvest. If such experimental procedures merit further attention, they are subsequently field-tested and evaluated as a component of an actual cranberry operation.

DURING 1987 and 1988, a grant from the Massachusetts Depart-

ment of Food and Agriculture permitted private researchers the opportunity to evaluate biological control against several cranberry insect pests.

The concept of biological control includes the periodic release of beneficial, naturally occurring organisms (e.g., predatory nematodes, parasitic wasps or flies and bacterial and fungal parasites of insects) against specific pests. When successful, this type of control can be integrated into an overall pest management strategy. Results from these field trials are now being evaluated and are summarized below.

In 1988, a species of parasitic wasp (known as *Trichogramma pretiosum*) was released against the major pest, the cranberry fruitworm. Years ago, the eminent entomologist, Dr. Henry J. Franklin, had documented parasitism of fruitworm eggs by an unidentified species of this wasp. In the present trial, a commercial insectary was contacted, and several cooperating growers generously permitted use of their bogs.

Two rates of parasite release were compared. Data were also collected at bogs managed by the IPM program and at "not managed" sites (bogs not currently under management). Releases were initiated when test bogs were calculated as being at fifty percent "out of bloom" and were continued at three or four day intervals through August.

Berries were collected at regular intervals from all sites and examined for fruitworm eggs, which were then categorized as hatched, unhatched or parasitized (evident by a blackened appearance). Thus, the number of parasitized or unparasitized fruitworm eggs present in bogs could be calculated throughout the season.

Results were encouraging but did
CRANBERRIES September 1989 Page 5

CAPEWAY BEARING & MACHINE, INC.

BEARING & DRIVELINE SPECIALISTS

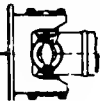

— MACHINE SHOP SERVICE —
508 - 747-2800

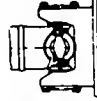

BEARINGS

BOAT & TRAILER
BOWER - BCA
C/R DISTRIBUTOR
FAG
FLANGE UNITS
INDUSTRIAL
KOYO DISTRIBUTOR
MARINE CUTLAS
PILLOW BLOCKS
SKF
TIMKEN
TORRINGTON

BELTS

DAYCO

DRIVELINE COMPONENTS

BORG-WARNER
C/V SHAFTS
DETROIT
FRONT WHEEL DRIVE AXLES
HANGER BEARINGS
MOTOR MASTER UNIVERSAL JOINTS
NEAPCO DISTRIBUTOR
PTO'S
PTO COMPONENTS
ROCKWELL
SPIDER CLUTCHES
SPICER-DANA
UNIVERSAL JOINTS FOR ALL CARS
TRUCKS AND HEAVY EQUIPMENT

FILTERS

BALDWIN DISTRIBUTOR

HYDRAULICS

COMMERCIAL PUMPS & COMPONENTS
GRESEN
HYDRAULIC HOSE

LUBRICATION

ALEMITE SUPPLIES
KENDALL
FEL-PRO

SEALS

C/R DISTRIBUTOR
NATIONAL
NATIONAL O-RINGS
STEMCO

TRANSMISSION & REAR END

EATON
FULLER
ROCKWELL
SPICER
TRANSMISSION & REAR AXLE
REBUILDING KITS

POWER TRANSMISSION COMPONENTS

DAYCO COMPONENTS
CHAIN
MECHANICAL CLUTCHES
PULLEYS
RIGHT ANGLE DRIVES
SPROCKETS

AP

HEAVY DUTY TRUCK EXHAUST

SUPPLEMENTARY PRODUCTS

BRONZE BUSHINGS • GASKET PAPER • HARDWARE • HELICOIL
LOCKING HUBS • LOCITE • MORSE CABLES • POLLACK ALARMS

— MAJOR SUPPLIER AND MEMBER —

CAPE COD CRANBERRY GROWERS ASSOCIATION • CAPE COD TURF MANAGERS ASSOCIATION
MASSACHUSETTS LOBSTERMEN ASSOCIATION

100 CAMELOT DR., PLYMOUTH, MASS. 02360

not demonstrate practical fruitworm control. Parasitism of eggs was estimated at 25-30%, which would not reduce a fruitworm population to an acceptable level by today's standards.

However, samples obtained from "not managed" bogs generally displayed a higher level of parasitism, perhaps due to the presence of native *Trichogramma* wasps. Curiously, the wasps collected from these sites were identified as the same species as provided by the commercial insectary.

Although this release trial did not generate satisfactory pest control results, it did demonstrate that a segment of the fruitworm population could be removed by parasitism. Perhaps wasps could be released following the first cover spray after bloom, further reducing the pest population level without application of further insecticide. Continuation of this search is dependent upon additional funding.

Another approach involved spraying organisms known as nematodes. This new and exciting product has been developed by sev-

eral research firms in North America and Australia and has recently been marketed for use in cranberry pest management. Unlike pestiferous nematodes which attack plants, beneficial nematodes attack a wide range of *insect* species.

In the 1987 and 1988 trials, nematodes were applied via ground spray equipment to a bog infested by larvae of the strawberry root weevil, a major below-ground pest. Weevil larvae were sampled and counted immediately before and at five days following nematode application. Results were favorable: the number of weevil larvae were reduced by nematodes, compared to counts of larvae made in untreated sites.

Further trials are being conducted against other serious below-ground pest species, such as cranberry root grub and white grub.

A third approach included release of predatory mites against the secondary, but important, pest, the southern red mite. Predaceous mites are currently being used to control a wide range of pestiferous mites in several cropping systems, including strawberries. In cranberries, field trials were hindered by lack of adequate test sites, but laboratory trials provided dramatic results.

Southern red mites were placed in petri dishes. Species of predatory mites were added to the dishes at a ratio of one predator to four pests. Examination of the dishes 24 hours later demonstrated that southern red mite was attacked by four species of predatory mites.

Live pest mites were only found in control group dishes—those without predatory mites. The next phase will be directed against southern red mite infestations on bogs.

THE RECENT surge in public concern about pesticide residues present on fresh fruit has served us notice that use of pesticides is being scrutinized by the consumer as well as by regulatory agencies.

Indeed, cultivation of cranberries has been targeted as a potential source of environmental contamination by numerous groups and individuals. Growers have been questioned by concerned citizens who fear permanent pollution of fresh water supplies or accidental exposure to toxic chemicals. More consumers are becoming cautious about the quality of their food and

CRANBERRIES

THE NATIONAL CRANBERRY MAGAZINE

SEND CORRESPONDENCE TO:

**P.O. BOX 249
COBALT CT 06414
(203) 342-4730**

Fax #: (203) 342-1977

PUBLISHER & EDITOR: BOB TAYLOR

ASSOCIATE EDITOR: CAROLYN GILMORE
(508) 783-5206

ADVISORS & CORRESPONDENTS

MASSACHUSETTS — Irving E. Demoranville, Director, Cranberry Experiment Station.

NEW JERSEY — Phillip E. Merucci, Cranberry & Blueberry Specialist, Buddtown; Elizabeth G. Carpenter, Chatsworth

NOVA SCOTIA — Robert A. Murray, Horticulturist, Berry Crops, Research Station, Truro.

OREGON — Arthur Poole, Coos County Extension Agent, Coquille

WASHINGTON — Azmi Y. Shawa, Horticulturist and retired Director, Coastal Washington Research & Extension Unit, Long Beach.

WISCONSIN — Tod D. Planer, Farm Management Agent, Wood County

CRANBERRIES is published monthly by Diversified Periodicals, Wellwyn Drive, Portland CT 06480. Second class postage is paid at the Portland, Conn. Post Office. Price is \$15 a year, \$28 for two years, \$2 a copy in the U.S.; \$17 a year in Canada; \$20 a year in all other countries. Back copies: \$2.50, including postage. Copyright 1988 by Diversified Periodicals.

ISSN: 0011-0787

Postmaster, send Form 3749 to:

CRANBERRIES

P.O. BOX 249

COBALT CT 06414

FOR SALE

FURFORD DRY PICKER

ready to go

\$3,000 fob Easton, MA

Call: Morse Brothers, Inc.

(508) 699-2588



General Excavating

Pond Construction & Maintenance
Land Clearing, Ditching, Canal Work

Dragline (63' reach) & Clamshell

Gradall 6' Bucket

D-8 Dozer

Road Grader

**Bill Conway
228 W. Britannia St.
Taunton, MA 02780
(508) 822-1085**

R. A. S. P. INC.

Carrying a Complete Line of:

- Cranberry Chemicals and Fertilizers
- Frost Alarms
- Thermometers
- Chemical Application Equipment
- Kubota K-35 Rental

Contact:

Bob or Mike
3 Plymouth St.
Carver, MA 02330

Phone:
(508) 866-4429

Authorized Agway Representative

AGWAY

Office
295-2222

K. Beaton
295-2207

BEATON'S
CRANBERRY
GROWERS SERVICE

WAREHAM, MASS.

D. Beaton
888-1288

P. Beaton
947-3601

Specializing in

● COMPLETE BOG
MANAGEMENT

● NETTING

● DITCHING

● HARVESTING
(Wet & Dry)

● SANDING

● CUSTOM
HERBICIDE
APPLICATION

Complete line of portable Crisafulli Pumps 2" - 16"
Plastic netting for suction boxes



NOTECARDS

FROM BARBARA McFARLAND'S PAINTINGS
"THE GREAT NORTHERN CRANBERRY"
&
"RAKE 'EM"

Are Available In Full Color, Size 4.25" x 5.5"



6 Notes, 3 of Each Design with Envelopes
Are Priced At \$6.50 a Package.

To Order CRANBERRY SERIES #1 - Send Check or Money
Order To:

WOODSHOLM GALLERY
Rt.2 McFarland Drive
Manitowish Waters, WI 54545
715-543-2975

Shipping/handling - Add \$2.00 plus \$.25 each after 5 packages.



Irrigation Equipment Designed Especially for the Cranberry Industry

- Gorman-Rupp Self Priming Electric Sprinkler Pumps
- Proven Quick Couple Riser
- Polyethylene Main Lines, 3" - 12"
- Buft Fusion Equipment Available
- Paco/Wemco Water Harvest Pump
- Berkeley Self-Priming and Centrifugal Pumps

A Most Complete Inventory of Irrigation Accessories

LARCHMONT
IRRIGATION / SNOWMAKING

P.O. Box 66, 11 Larchmont Lane
Lexington, Massachusetts 02173 (508) 862-2550

Contact

Larchmont Engineering
Phil Tropeano, President
(508) 862-2550
(Call Collect)

Stearns Irrigation, Inc.
790 Federal Furnace Rd.
Plymouth, MA 02360
(508) 746-6048

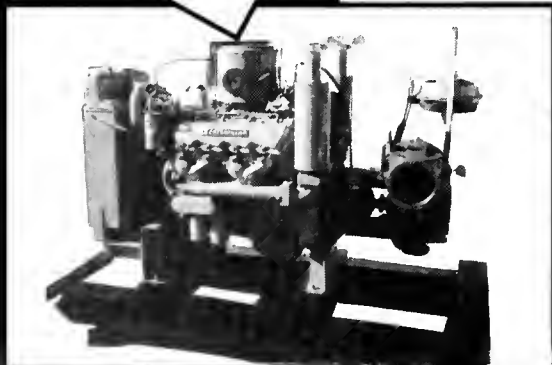
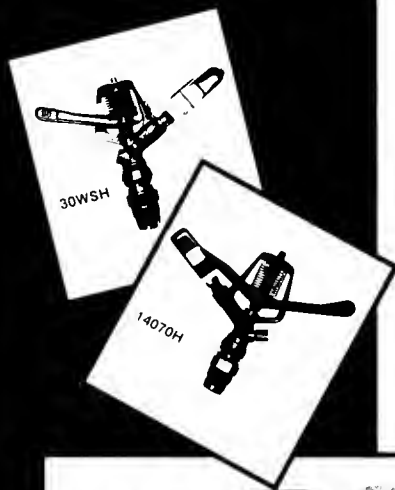

are seeking assurance that produce is clean and pesticide-free.

Development of practical alternatives to pesticides is thus beneficial not only to the environment, but also to the long-term health of the industry.

However, the various pests *themselves* may actually be the chief reason to consider pesticide alternatives.

The phenomenon of pesticide resistance is well documented and particularly troubling. Research has demonstrated quite conclusively that insect pests can evolve resistance to a range of pesticides, thus creating an urgent need for alternative solutions.

Use of biological control agents could provide such an alternative.

(Dave Simser is a researcher for New Alchemy Institute of Falmouth, Mass., a nonprofit research and educational institute.)

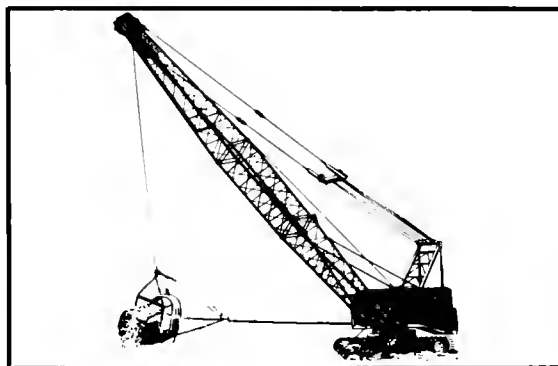

Krause Excavating, Inc.

Canal Work

Ditching

Pond Construction

Land Clearing

1-1/4—3 yd. draglines with 80' boom and matts, 2 yd. backhoe, swamp dozer and other related equipment.

Contact:

Roger Krause 1-414-398-3322
Route 3 Markesan, Wis. 53946



22 years experience  construction lifts 



AERIAL LIFTING

◦ **BERRY LIFTING** ◦

nylon berry bags
bulk bins

◦ **MUD LIFTING** ◦

NEW MATS

lightweight
durable

contact

PETER or CHUCK

508-295-2222

 **BEATON'S**
CRANBERRY
GROWERS SERVICE

 **WARHAM MASS.**

mat rentals & sales



Cranberrying Over 100 Years Ago

Editor's Note: Associate Editor Carolyn Gilmore came across the section below while perusing "Facts for Farmers: A Variety of Rich Materials for All Landowners About Domestic Animals and Domestic Economy, Farm Buildings, Gardens, Orchards and Vineyards and All Farms Crops, Tools, Fences, Fertilization, Draining and Irrigation." This book with the longwinded subtitle was edited by Solon Robinson and published in 1871.

700. Cranberries as a Field Crop.—We have already said that cranberries may be grown in the garden, and we now say they may and should be grown as a farm crop upon hundreds of farms that have tracts particularly well adapted to their growth. Upon this subject, Noble Hill, of Caton, Steuben County, N.Y., writes as follows:

"That the cranberry is a favorite luxury, is abundantly proved by the high price which a good, and not unfrequently an inferior, article will command in the markets. That it is easy of cultivation, and that there is an abundance of land now lying waste which is just adapted to its growth, is perhaps not so generally known. If the thousands of acres of swamps, of a peat soil, within the bounds of the single State of New York, were to be converted, as they certainly might be, into cranberry meadows, the fruit would never be quoted at \$14 or \$15 per barrel in New York City.

"The following is submitted as the result of several years of observation and experience in the cultivation of the cranberry. The subject of my experience is a swamp of several acres, and of a peat soil. Formerly it was covered with small brush, moss, grass, and weeds; no large timber being found on it, owing to the fact that it was submerged during a great portion of the year. On the borders of this swamp a few cranberry vines, indigenous to the soil, were to be found. By a series of open ditches leading across it and through a bank at its margin, I was enabled to remove the superabundant surface water. This done, cranberry vines began to make their appearance in different portions of the swamp, but more plentifully in the central portion, from which they began to spread over the land at a rapid rate. In their progress, however, they encountered an enemy in the shape of the brush, which not only retarded their growth and prevented the full development of their prolific qualities, but in some places entirely excluded them. Hence it occurred to me that an advantage would be gained by thoroughly subduing the soil previous to its occupancy by the cranberry. To this work I then addressed myself, accomplishing it with the plow on the borders, where the land had become sufficiently dry to render that mode practicable, and with a spade in other portions on which a team could not be driven. As done by a spade, the work consists in paring off the surface and throwing the result into heaps, which, when rotted, answer a good purpose as manure for fruit trees. The clean surface thus exposed should be spaded to the depth of two or three inches, when the process of transplanting may be performed. If, however, the transplanting be deferred until the following spring, and the soil be occasionally stirred during summer with a hand harrow, the plants will

thrive the more rapidly. They should be set closely as they will the sooner cover the ground to the exclusion of weeds, from which, if kept free for two or three years, they will thenceforth need but little, if any, attention. In soil thus prepared, I have transplanted the last of May, and have picked fine clusters of berries the ensuing fall. In two or three years a fine crop may be expected, and thenceforth, so far as my experience goes, will be annually realized. To insure large crops, the soil during summer should be well saturated with water, and if flowed in the spring, all the better. This I accomplish, as far as possible, by a proper adjustment of my drains, opening and closing them according to the variations of the

weather from wet to dry. As to transplanting, there is no difficulty whatever. If an equal number of cabbage and of cranberry plants be set, more failures would be found among the former than among the latter. A cranberry plant a yard long, set in a mellow peat soil in a wet season, will take root at every point of full contact with the soil."

It is a pity that we can not convince all the owners of such swamps as Mr. Hill describes that they can grow just as good berries as he does. There are many such places within a few miles of this city that are now pests to the owners, that would be profitable ever after if once set in cranberry vines.

The cranberry has been very much improved—as much so as any other fruit. I

Vines For Sale

E. W. Bowker Co.

Box 581, Magnolia Road

Pemberton, NJ 08068

(609) 894-9231

(609) 894-9508

New Hybrids

35 and Croppers

Also, Le Munyon

Call for Price

Spring '90 Delivery

do not know of any fruit that offers greater inducements to experiment with than the cranberry in seedlings, since it has already shown such good results. If cranberry seed, or any other hard seed, is difficult to vegetate, it may be scalded with boiling water.

There is no doubt that cranberries can be grown upon any soil that has water a few inches below the surface. Upon tolerably dry upland cranberries have been grown to advantage, and they will grow in very bare sand if either naturally or artificially watered.

Considering the high price which cranberries always bring in market, and the cheap cost at which they can be produced, it is strange that more shrewd farmers have not gone into the speculation. A good deal of attention has been given to the cultivation of cranberries in Burlington County, New Jersey, about 150 acres having been planted in one season. Of this, one farmer named Chetwood has set out 25 acres; another, named G. Gowdy, 17 acres; and Mr. Allen, 10 acres.

Upon Cape Cod, where cranberry culture has been carried to the greatest extent, swampy land that was a few years ago considered utterly worthless, has now a salable value of \$800 to \$1,200 an acre; and some of the owners of such land have found it a good investment of time and money to expend from \$200 to \$1,000 upon an acre to bring it into a condition fit to be planted with cranberries.

All over this country there are numerous bogs which might easily be converted into

fruitful cranberry gardens.

In view of these facts we make this pertinent inquiry to every farmer in all the Northern States, where cranberries are found growing wild: "Are there no swamps, or wet valleys, or brook borders upon your farm, now, perhaps, unsightly spots—wet swamps in winter, and dry and pestiferous in summer? If you have such, plant them with cranberry-vines, and tend them one or two years till the vines get well set, and then they will tend themselves, and produce you on the average more bushels of fruit per acre than you get of potatoes; and it is not much more work to gather it than it is the tubers, and generally speaking, you can sell a bushel of cranberries for the price of five

bushels of potatoes."

Truth, it is said, lies at the bottom of a well. The well that holds the truth in relation to cranberry culture and its profitability upon many of the worthless bogs that render farms unsalable, and detract it from the value of the upland, must be a remarkably deep one, or it would have been dug out before now, and made to shine in all the rich crimson luster of a field of this ripe fruit.

701. **Varieties of Cranberries and How to Grow Them.**—The American cranberry (*Oxycoccus macrocarpus*) is divided by growers and dealers into three varieties—the Bell, the Bugle, and the Cherry. It will grow on almost any soil where the water is not more than a foot from the surface, yet

SKIPPAR

POLE  SERVICE

• Private Poles • Line Construction

• Sonotube Drilling • New & Used Poles

(508) 690-2238

208 Franklin St., East Bridgewater, MA 02333

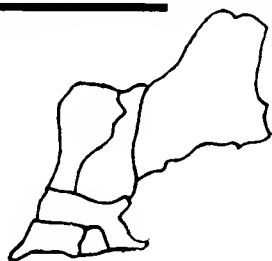

New England Bog Equipment



Custom Welding and Fabricating

Now Taking Orders for your Harvest time needs

WATER REEL PICKERS, Priced to start at \$8,500.00

Ride-on, Three wheeled design, All Hydraulic driven, Different widths, side reel attachments, and engine options available.

Other Harvest Equipment Also Available

*For further information on this or our other
Bog related products, contact us at
(508) 866-4330, Rte 58, Tremont St.,
Riverside Mall (rear), South Carver, Mass. Or write:*



**New England Bog Equipment
P.O. Box 102
North Carver, MA 02330**

THE BEST — IN EVERY RESPECT



CRANBERRY Model 400 GT

Precision Chemigation System



- Developed *Exclusively* for the Cranberry Industry
- Exceeds or Meets ALL Current EPA Requirements
- Simple to Operate and Easy to Calibrate
 - Self-Timer Application (1 minute Increments)
 - Easy Access Handle & Simple Reference Scale
 - Precise Visual Flow Calibration
- Outstanding Field Performance
 - Down-Line Venturi Injection System
 - High Capacity 0-7 GPM Injection Rate
 - Large Volume 175 Gallon Mix Tank
 - 12 Volt Gear Reduction Mixer
- Designed for Trouble-Free Operation
 - Reliable 11 HP Honda Electric Start Engine
 - Critical Components Are Stainless Steel & Polypropylene
- Completely Self-Contained and DOT Approved Transportable
- Personalized, Experienced Support Service as Close as Your Phone

CHEMIGATION SYSTEMS INTERNATIONAL, INC.

**Corporate Offices: P.O. Box 247
(608) 297-2041**

**Montello, WI 53949
FAX: (608) 297-7248**

Call us today for the dealer nearest you, or contact:

**Skip Tenpas
Central Sands Irr. & Bldg., Inc.
Hwy 51 & 73 Interchange
Plainfield, WI 54966
(715) 335-6372**

**Bruce Sunnerberg
AAA Industrial Pump & Ser., Inc.
66 Lake Street
Plympton, MA 02367
(617) 585-2394**

NOTICE

**Selected exclusive
dealer territories
still available —**

Inquiries invited

experience has proved that the soil best adapted to them is nothing more nor less than the plain beach sand, entirely free from any matter, either animal or vegetable; in fact, this berry may be said to live entirely on sand and water.

Peat is found to be well adapted to this berry, but requires some care in preparing, owing to its liability to bake and crack in hot weather; this may be obviated, however, by taking off the turf and grass, leaving the surface exposed to the action of the weather for a year, after which it becomes light and porous, and fit for the reception of the vines.

Cutting-planting has been adopted by some as the most economical plan, and as the plant sends out long runners, sometimes to the length of five or six feet, it is self-evident that the first cost of cuttings must be small. The cutting should be about six or eight inches long, and should be planted by thrusting the middle into the earth with a dibble, permitting a few inches of each end to project, so that when it takes root you have two plants instead of one.

Another plan of propagating by cuttings is to cut the vines into pieces about two inches in length, for which purpose a common hay-cutter may be used, and sowing them broadcast on ground prepared for them, and then harrowing them in as you would wheat or rye. It is preferable to plant them in drills at such distances as will permit cultivation with the plow for the first two years. These small cuttings will soon take root from the point where branches join the stem, and will send out runners the

second year after planting.

Planting separate vines has been found to be the most effectual plan, and although it consumes more time, and is perhaps attended with rather more expense, yet from the absence of weeds and the fine chance for the vines to spread, the cultivator finds himself amply repaid for the increased outlay.

The distances of planting must be regulated by the nature of the soil; if liable to weeds, you must give yourself room to work

among the vines; but if you are planting on plain beach sand, the closer your plants are the better, for the great object in forming a cranberry-yard is to have the entire surface covered by a thick mat of vines as soon as possible.

The time of planting generally preferred is in the spring, as in this case the roots are not so liable to be thrown out by the winter frosts—say from the 15th of April to the 1st of June.

Turf **Equipment Inc.**
381 West Grove Street (Rte. 28)
Middleboro, MA 02346

KUBOTA Diesel Equipt.

Tractors 2 & 4 wheel drive — 12-90 hp.
Compact Excavators 1½ to 6 ton
Wheel Leaders ½ to ¾ yd.
Water Cooled Diesel Engines 4 to 104 hp.

All Types of Implements
Polymark Beaver-Mowers 947-6299
Specialty Fabrication Work
Kubota Financing as Low as 8½%

*Sales *Service *Parts *Leasing





Decran Ag Supplies



Inc.



- ★ Complete line of cranberry herbicides, fertilizers, insecticides, fungicides, miticides. In stock when you want them.
- ★ Best application and safety equipment for your needs.
- ★ Quality aerial applications.
- ★ Proven frost warning equipment. Don't take chances — buy the best.
- ★ Experienced cranberry consulting service offering pheromone traps and baits.
- ★ Right to know training.
- ★ Culvert Pipe — All sizes — steel, aluminum, and poly.
- ★ Ditch Mud Mats — Strong — lightweight — durable.
- ★ Burlap Picking Bags — Best for your money.
- ★ Sanding by helicopter.

John C. Decas
William D. Chamberlain
461 Mary's Pond Rd.
Rochester, MA 02770
Office: 295-2731
Evening: 763-8956
Fax: (508) 291-1417

Serving Massachusetts Cranberry Growers

As a general rule among farmers, they will be able to select some spot of meadow land which is low and moist, free from stagnant water, and somewhat sheltered from storms, as this may be considered the best location.

A position where the yard can be flooded in winter is very desirable, as the vines, when exposed to very severe weather, are liable to be winter-killed down as low as the roots, which throws them back in bearing for a year; besides which, it is sometimes desirable to flood them during the fruiting season to prevent the attack of the worm, which in some localities is quite destructive.

An acre of vines, properly cultivated and well matted, will produce at least two hundred and fifty bushels of berries; in some instances a yield of four hundred bushels per acre has been obtained, but this is above the average, and may not be relied upon.

Two hundred and fifty bushels of berries, at the low price of three dollars per bushel, gives us seven hundred and fifty dollars as the product of one acre. Vines for a new plantation should be procured from meadows which have borne well, and of good fruit, as the best way of knowing good bearers.

If the yard can be flowed, though not absolutely necessary, the water may remain on all winter, and be let off in March. It should be let on about the 20th to the 25th of May, and again the 1st of June, not exceeding thirty-six hours. After this, it is not needful. Blossoms are injured by the water remaining on too long; the object of flooding is to destroy the insects. After this second flowing, there is little to fear from them.

A Cape Cod cranberry grower gives some useful advice to persons disposed to embark in cranberry culture. He says:

"Suppose that those who are favored with some of the natural facilities desire to do something with cranberries, it would be folly to expend much money in clearing up a swamp. The best thing to be done is to study the nature of the soil in which the vine is flourishing, and then to prepare a small patch—say two or three rods—and plant the vines there, and bestowing some trifling

WANTED Gravel & Sand

in the southeastern Massachusetts area

Quantities of 10,000 yards and up

Complete site work, bog construction and finished contouring of surrounding area plus the best price for your material.

Michael Coan
Carver, Mass.
(508) 866-5285

Earl White
Medfield, Mass.
(508) 359-7291

We Still Make House Calls

Like your old family doctor, your Farm Credit representative still makes house calls . . . and he's been treating farm families like yours for a good 70 years.

Farm families count on him to provide the financial support they need—short-term and long-term credit—that helps them plan for a productive future.

But there's more to Farm Credit than money. What makes your Farm Credit representative unique is that he knows your business so well. Which means that he's more than a dependable source of credit. He can provide farm business consulting, tax services, credit life insurance, appraisal service and computerized record-keeping.

Give him a call. He could be just what the doctor ordered for you.



**Southern New England
Farm Credit Service**

Federal Land Bank Association
Production Credit Association
P.O. Box 7
Taunton, MA 02780
508 / 824-7578



Pump Repairs & Sales

All Types

- Field Service
- Chemigation Equipment Sold
- Demonstration by Appointment

**AAA Industrial
Pump Service Inc.**

Bruce Sunnerberg
66 Lake Street
Plympton, MA 02367
(617) 585-2394

degree of care upon them, by way of weeding occasionally, you will see by this experiment whether it will do for you to proceed much farther in their cultivation. If you fail, that failure will most likely suggest to you the remedy. Great mistakes are made in anticipating from planting wastelands with cranberry vines, that they are about to realize two hundred per cent. It will do very well for an experienced man to make large yards, and with certainty of success, but it will not do for a man who knows nothing about the cranberry and its culture to go rashly to work. You will prevent future expense and galling disappointment by making your first trial on rather a small scale.

"The cranberry vine can be naturalized to those regions of country in which it is not indigenous. The Bugle cranberry is generally found to throw its runners from the swamp toward the upland. The runner receives its moisture from the roots of the vine which rest in the damp soil. Now, if you will take these runners and plant them where there is some moisture, in an upland soil, and stir it frequently during the hot months of summer, they will live through the apparent drouth. Two years hence take the young vines and carefully plant them, and you will find that you have done much toward naturalizing the vine even to a situation where there can not be any overflowing. Many persons have planted on the upland with vines from the swamp, and the transition from abundant moisture to a comparatively dry situation has been too sudden, and the vines have subsequently died. Those who try the upland should get the vines which have been naturalized to a dry soil, or it will require immense trouble and some years to do anything to advantage. It will be well for those who intend to try the cranberry vine on a comparatively high and dry situation, to remember that

the fruit produced is not so large, nor yet are the quantities equal to those which are yielded in more favorable locations, where there is either peat, beach-sand, or fine gravelly loam, and the ability to flow in winter. I believe that the time will come when the commercial value of the cranberry will be better understood, and when farmers in all parts of the country will feel it to be their interest to cultivate a patch of this fruit, and when its requirements will be better understood than at present, and when it will be a source of profit to those who think it worth their while to raise the berry.

"A short time since I saw a swamp which was formerly so covered over with brakes, huckleberry-bushes and briers, that it was of no use to the owner until he paid some attention to the subject of cranberry cultivation, and cleared the swamp, which he found to have a peaty bottom. The ground then planted over with vines, and the property, including clearing, vines, and planting, cost him \$300, but I was informed by the proprietor that he had muck from the swamp which he valued at \$150. The first year he had off this one acre and a half one or two bushels; the second, twelve bushels; and the next year, seventy-three bushels, which were sold at \$4 per bushel. If the yard cost him \$300, he nearly realized in the third year subsequently to its being made, the sum of money he first expended upon it."

Our final advice, to all who desire to plant cranberries to any extent, is to hire some experienced person to do the work, and give instructions for the future care of the yard, according to the circumstances of its location.

High bush, or tree-cranberry, is the common name of a berry sometimes sold under the recommendation of being equal to the fruit we have been describing. It belongs to a very different order of plants from the cranberry—the real *oxycoccus*.

YANKEE PLANNERS, INC.

59 North Main Street
Middleboro, MA 02346
(508) 947-0527

Sound and Objective
Advice
Suited to
Your Needs

- Tax and Estate Planning
- Investment & Insurance Review
- Business Continuity
- Asset Protection
- Key Employee Retention
- Business Tax Analysis

Mr. William H. Bestgen, Jr.
Chartered Financial Consultant

Mr. Peter W. Hutchings
Attorney at Law practicing as
a Tax Attorney

Mr. Roger H. Parent, Jr.
Accountant, Enrolled to Practice
before the Internal Revenue
Service

Call For Your Free Brochure
(508) 947-0527

Vines For Sale

Ben Lear	\$5,000 a ton
Stevens	\$4,000 a ton
Crowley	\$4,000 a ton
Bergman	\$4,000 a ton

Prices are F.O.B.

\$500 a ton less with 50% payment before cutting

Richberry Farms Ltd.

11280 Mellis Drive
Richmond, B.C.
V6X 1L7 Canada

Res. (604) 273-4505
Bus. (604) 273-0777

The only use of it is as an ornamental shrub. No housewife will try to use it but once in the place of the true cranberry. The fruit is almost wholly a hard, long seed, scarcely covered with pulp, and when cooked with much sugar, though resembling the true cranberry, sadly mocks the taste.

702. **How to Cook Cranberries** is an important question. They are sour, acrid, unpalatable, and unwholesome in a raw state, and but little better as they are usually cooked. We have often seen them hastily scalded, sweetened, and brought to the table floating in their juice, not one half of them cooked enough to burst the skin. Bah! what food! But how different when cooked! Put them, with only water enough to prevent burning, in a tinned sauce-pan, and stew until by stirring the whole becomes a homogenous mass, with no semblance of whole berries, and then add clarified sirup, previously prepared, and stir a few minutes while boiling. When cold, you have delicious cranberry jelly.



**BLUE HERON
FARMS**
GROWER SERVICE

MOWING (all types) * DITCHING
WATER HARVESTING * SANDING

"Specializing in the Needs of Small Growers"

Call Wayne or Karen Barnes

72 Brook St.
Plympton, MA 02367
1-617-585-9830

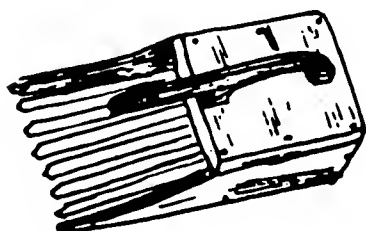

Cranberry Harvesting Equipment

Warrens Equipment & Manufacturing Co., Inc.

Growing cranberries is something you as a grower do best. Manufacturing of harvesting equipment, air flow, radar controlled fertilizer spreading equipment, and flow gates or flumes is something we do that can be of service to you.



NEWS FLASHES

Standard WEM Bog-Trac Tractors & Beaters Available For Immediate Shipment

- Beater reels available, your choice of designs
- You as a grower tell us what is best for your bog
- Change your reel rpm from bog to bog or variety to variety
- Engine horsepower available from 18 h.p. to 48 h.p.
- Safety parking brake
- Ground speed and reel speed indicator
- Lighter weight

Be sure to check this new model harvester before you make a purchase for 1989.

WEM Factory serving Wisconsin, West Coast, British Columbia
111 Grant St.
Warrens, WI 54666
Tel. (608) 378-4794
(608) 378-4137

WEM East Coast
Stearns Irrigation, Inc.
790 Federal Furnace Rd.
Plymouth, MA 02360
Tel. (508) 746-6048

REGIONAL NOTES

MASSACHUSETTS

By IRVING E. DEMORANVILLE

Reports and observations indicate that our bogs overwintered well.

No reports of winterkill—we were lucky as many bogs did not have water for winter flood—and some reports of leaf drop—not from oxygen deficiency but various types of stress.

Root rot is still with us, but generally under control.

Insect population was generally light, except for tip worm. Also, there were more reports of grubs showing up.

A heavy bloom appeared to be setting well.

Bees were not the problem that was expected, thanks to the efforts of CCCGA, the Massachusetts Department of Agriculture and the Beekeepers Association.

Quality could be weak but timely fungicide applications were very helpful.

Considerable Fairy Ring showed up. We have not pinpointed a reason yet.

Prospects appear very good to excellent at this time.

Weather

MASSACHUSETTS

June was warm, averaging 2.0 degrees a day above normal. This was the eighth warmest in our records. The second week was cool and the last one-third warm. Night temperatures were much above normal. Maximum temperature was 88 degrees on the 23rd and minimum 52 degrees on the 30th.

Rainfall totaled 3.25 inches or just normal. There were 15 days with measurable rain with 1.16 inches on the 9th-10th as the greatest storm. There was nothing the last two weeks of the month. We are about 3/4 inch below normal for 1989 and are 2-2/3 inches ahead of 1988.

There was a total of seven days with frost warnings during the spring 1989 frost season: five in April, two in May and none in June.

A very easy season. In fact, the only bad night was April 22 when sprinkler heads freezing was a common occurrence.

Temperatures were from 9 to 16 degrees.
I.E.D.

WASTE MANAGEMENT IS SUBJECT OF SYMPOSIUM

Solid/liquid separation processes in waste management and productivity enhancement is the theme of an international symposium to be held at Battelle in Columbus, Ohio Dec. 5-7.

Obituary

Charles Broderick

Cranberry grower, art gallery owner, museum director and orchid fancier, Charles Broderick of Jamaica Plain, Mass., died recently at age 87.

He was a member of the Cape Cod Cranberry Growers' Association.

Broderick and his late wife, Doris (Toye), operated Orchid Hill Farm from the mid-1940s until the 1960s. Ten years ago he started Meadow Pond Farm in Carver, where he grew cranberries, Christmas trees, hollies and beech seedlings.

The Brodericks also established the Broderick Gallery in Jamaica Plain, where they specialized in restoration and conservation of oil paintings and frames.

Broderick was born in Dorchester and graduated from Suffolk Law School in 1927.

He was director and curator of the Antique Auto Museum at Larz Anderson Park in Brookline from 1963 to 1970. He also was an adviser to the Transportation Museum in Owl's Head, Maine, which was close to his summer home.

Director and former president of the Jamaica Hills Association, he also was president of the Brookline Rotary Club in 1971-72 and a member of the Boston Flower Exchange.

He leaves a daughter, Julia B. O'Brien of Roslindale; a son, Brian T. of Jamaica Plain, and two granddaughters.

WOLLSCHLAGER EXCAVATING

Dragline Work — All Kinds

Also Have Clam & Scalping Buckets

Route 1 Necedah, WI 54646
1-608-565-2436

R.D. GRASSI Cranberry SERVICES

Herbicides
Applied

Custom Pruning
Custom Ditching

Sanding
Wiping
Wet Harvesting
Mowing

(Mowing includes
Hydraulic Arm
Flail Mower.)

West Wareham,
Massachusetts

Ask for Rick at
295-5158

Co-op's VP Writes Marketing Chapter For USDA Yearbook

By **CAROLYN GILMORE**

New product development!

Ocean Spray has had universally acknowledged success at it. So when it came to having someone write a chapter on the subject for the USDA's 1988 Yearbook of Agriculture, it seemed quite natural that Tom Bullock, the cooperative's vice president of business operations, would be asked to perform the task.

Bullock's article outlines the five steps Ocean Spray follows to introduce new products to the market. As he describes it, the process takes 18 months or more from conception to implementation.

The five steps are: 1. exploratory; 2. early development; 3. criteria measurement; 4. advanced development, and 5. test marketing. Throughout, strong advertising is emphasized.

The cooperative believes in tak-

ing the product story directly to the customer early in the introduction of the product and often in the followup programs, writes Bullock.

Ocean Spray claims that the marketing formula was successful with the nine juice products it introduced to the market from 1981-87.

"It takes a lot of time, energy and money to consistently introduce quality products in a competitive marketplace, but Ocean Spray has been doing it—and doing it well," Bullock concludes. "With sales of \$735 million in fiscal 1987, Ocean Spray's success in the food and beverage industry cannot be ignored."

The theme of the 1988 Yearbook of Agriculture is quality marketing.

"This volume of the Yearbook of

Agriculture should prove of help to the individuals and firms whose job it is to meet the changing demands of our buyers, innovating and modifying our high-quality raw materials to give people the types of products they want," writes Agriculture Secretary Richard E. Lyng in the foreword.

A copy of the Yearbook of Agriculture can be obtained from the Superintendent of Documents, U.S. Government Printing Office, Washington, D.C. 20402 or by writing your congressman.

REMCO BECOMES ACCOR

Remco Research & Development Inc. has changed its name to Accor Technology Inc. The address of the company—251 Independence Way, Cashmere, WA 98815—remains the same.

CRANLAND SERVICES

*Cranberry Property
Appraisals*

★ ★ ★ ★ ★

Listings and Sales of
Cranberry Properties.

License # 68987

Lawrence W. Pink
Old Cordwood Path
Duxbury, MA 02332
(617) 934-6076

J.A. JENKINS & SON CO.

Grower Service

MOWING (ALL TYPES)
SANDING

DITCHING
WEED WIPING

Serving Cape Cod

227 Pine St., W. Barnstable, Ma. 02668

Phone 362-6018



ABBOTT NAMES SCANLON

Abbott Laboratories, which claims to be the world's largest producer of biological pesticides and plant growth regulators, has named Phil Scanlon as regional sales representative. Abbott is based in North Chicago, Ill.

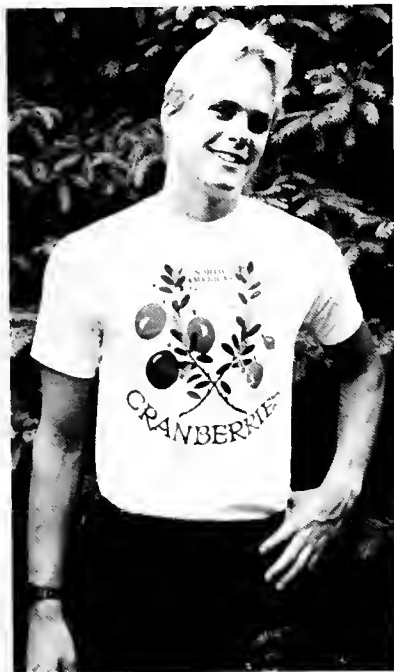

Cranberry Originals

T-Shirt

**"CRANBERRIES
North America's Native Fruit"**

An Original Botanical Design
of Blossoms and Green & Ripe Cranberries
by

Ann Kay Chambers

Adult T-Shirt (Sizes S, M, L, XL)	\$12
Adult XXL T-Shirt	\$14
Youth Size 14-16 T-Shirt	\$11
Children's Sizes 4, 6-8, 10-12	\$11
Adult Sweatshirt (S, M, L, XL)	\$25
Adult XXL Sweatshirt	\$28
Youth 14-16 Sweatshirt	\$21
Children's Sweatshirt (4, 6-8, 10-12)	\$19

Send Check or Money Order to:

**CRANBERRIES
P.O. Box 249
Cobalt, CT 06414**

Add \$3.50 Shipping & Handling Charge
For Canadian orders, add \$8

Name

Address

City State Zip

Red, White & Blue

The viburnum bush:

A cranberry sea

under a crimson sky.

As the fire crackles high

'neath the hunter's moon,

an eerie aura surrounds me.

Listening to the peepers

I see the shadow of a loon.

I'm lulled to a false tranquility.

For the season has come.

There's much work to be done.

This little berry is in big demand.

Jellied and juiced, ornamented or canned;

it takes more than passion to work this land.

Though my back's been strained a hundred times

in the crunch of the holiday season,

and everyone thinks I'm mad . . .

I've a happy life, full of sage reason.

With a wink and a nod, I look to the bog

and marvel at the wondrous witherod.

B. A. Coleman

**WISCONSIN CRANBERRY
HEADQUARTERS FOR
SEVIN XLR**

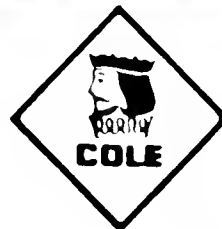

DEVIRINOL 10G • EVITAL • GUTHION
DIAZINON 14G • PARATHION • ETHREL

Cole/Grower Service

537 Atlas Ave., P.O. Box 7211, Madison, WI 53707

(608) 221-6204 or 1-800-362-8049



NO REHEARSAL needed for this easy-to-prepare buffet for a bride and groom-to-be. A gay menu of **Berry Saucy Miniature Meatballs**, to be served on bread croustades, **Cranberry Charlotte Russe** for dessert, and to toast, **Cranberry Champagne Punch**.



Surely the wedding rehearsal party is one of the most delightful events of the many which take place before the bells chime on that happy day. Traditionally, the groom's parents host this joyful occasion for the bridal couple and their attendants.

Whether the rehearsal takes place before lunch or dinner, this light and easy medley of cranberry recipes is a perfect choice because it can be prepared ahead of time, and will be ready to serve as soon as everyone arrives.

Berry Saucy Miniature Meatballs

(Serves 6 to 8)

- 2 pounds ground beef
- 1 pound ground pork
- 1 tablespoon salt
- ¼ teaspoon pepper
- 3 eggs
- 1 clove garlic, mashed
- 1 small onion, chopped
- 1 can (1 pound) jellied whole berry cranberry sauce

- 1 cup chili sauce (1 12-ounce jar)
- 2 tablespoons prepared mustard
- 1 jar (5 ounces) cocktail onions, drained



Gapen

Realty

112 Acres

FOR SALE

Corp. permit to develop 30 acres of beds. Some ditching completed. Lots of water. House needs work. Good potential.

Ladysmith, WI

\$69,900

2141 8th Street South
Wisconsin Rapids, Wisconsin 54494
(715)423-6550

**Croustades (below) or puff
pastry shells**

In a large bowl, combine beef, pork, salt, pepper, eggs, garlic and chopped onion; mix until well blended. Shape mixture into 1½ inch balls, place side-by-side in a single layer in a shallow baking pan. Bake in a

preheated moderate oven (350°F) for 30 to 35 minutes or until meatballs are brown and cooked. In a large skillet, heat cranberry sauce, chili sauce, mustard and cocktail onions until bubbly. With slotted spoon, add meatballs to sauce. Simmer until bubbly. Spoon into a chafing dish and keep warm over a warmer. Serve meatballs in bread croustades or in baked puff pastry shells. To make 8 croustades, trim all the crusts from two 1-pound loaves of unsliced white bread. Cut each loaf into 4 thick, crosswise slices. With a sharp knife, scoop out the center of each slice, leaving a shell ½-inch thick. Brush shells with melted butter or margarine and place on a cookie sheet. Bake in a preheated hot oven (400°F) for 15 to 20 min-

utes or until brown.

**Cranberry
Charlotte
Russe**

(Serves 6)

- 24 double lady fingers
- 2 cans (1 pound each) peach slices, drained
- 1 cup (½ pint) heavy cream, whipped
- 1 teaspoon rum flavoring
- 1 can (1 pound) jellied cranberry sauce, cut into ½-inch cubes

**Niemi
Electric
Company**



Robert
Niemi
Electrical
Contractors

Heat, Light & Power Wiring

- RESIDENTIAL
- COMMERCIAL
- INDUSTRIAL

**Pinehurst Drive
Wareham, Mass.
TEL. 295-1880**

Irrigation Supplies

- 2" to 12" PVC Pipe with Fittings
- Quick Couple Risers
- Felker Aluminum Flumes & Culverts

Replace old aluminum mains with government approved 4", 6" and 8" polyethylene pipe buried just below bog surface. No insert fittings. Rent our butt fusion welder for a continuous main line. Beat the high cost of custom installation by renting our small 4-wheel drive tractor with mole hole plow for buried laterals.

STEARNS IRRIGATION, INC.
790 Federal Furnace Rd.
Plymouth MA 02360
Tel. (508) 746-6048

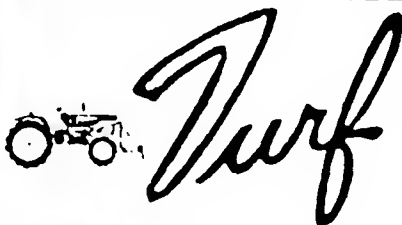

Equipment, Inc.

381 West Grove St. (Rte. 28)
Middleboro, MA 02346

(508) 947-8299



Tractors, Excavators and
Diesel Generators



Wheel Loaders
3/4 Yd - 6.1/2 Yd



Screening Equipment



**CEEKO
CORPORATION
OF NEW ENGLAND**

Industrial Suppliers To The Cranberry Industry



Chain, Cable and Accessories
Used for Making Mats

All Types of Fasteners (Bulk & Packaged)

- | | |
|------------------|---------------|
| Hand Tools | Pumps |
| Power Tools | Motors |
| Chemicals | Abrasives |
| Lubricants | Cutting Tools |
| Safety Equipment | |

Richards Rd.
Plymouth Industrial Park

747-0086
Plymouth, MA 02360

Stand four lady fingers into each of 6 sherbet dishes. Spoon peaches into the bottom of the dishes. In a bowl mix cream, rum flavoring and cranberry sauce cubes gently until well blended. Spoon mixture on peaches in center of each sherbet dish. Chill until ready to serve.

Cranberry Champagne Punch

(Serves 10 to 12 - about 18 cups)

1 quart cranberry juice cocktail
 1 can (6 ounces) frozen concentrated orange juice, thawed and undiluted
 1 quart ginger ale, chilled
 1 pint brandy or cognac
 2 bottles (4/5 quart each) champagne, chilled
 Ice cubes, strawberries and orange slices

In a large punch bowl, mix cranberry juice cocktail, orange juice, ginger ale and brandy. Slowly stir in champagne. Add ice cubes, strawberries and orange slices. Stir until very cold. Serve in punch cups.

Letters

LIKES NEW FORMAT

We enjoy reading your magazine. It is very good, larger in size and glossy paper. Congratulations!

Stephen Horbach
 Brewster, Mass.

CRANBERRY



COMPUTER, INC.

CRANWARE

- Growers
- Handlers
- Chemical Applications
- Chemical Resale

(508) 747-3033

P.O. Box 1037, Plymouth, MA 02360

CRANBERRY GROWERS REALTY

Listings of buyers and sellers welcomed on cranberry acreage and upland.

Appraisals

DOUGLAS R. BEATON
 E. Sandwich, Mass
 02537
 (617) 888-1288

TAUNTON 4 Prime Bogs

- 22 Acres
- Good Water & Soil
- Dormant - Ready to Rebuild
- Chapter 61 A - Plans

LEASE OR SALE
(508) 896-6262

The CHARLES W. HARRIS Company

451 Old Somerset Avenue
 North Dighton, Mass.
 Phone (508) 824-5607

AMES
 Antisyphon Devices
RAINBIRD
 Sprinklers
HALE
 Pumps

*Highest Quality Products
 With Satisfaction Guaranteed*

Clogged Suction Screen? This Screen Stays Clean



SURE-FLO
 Self-Cleaning
 Strainers

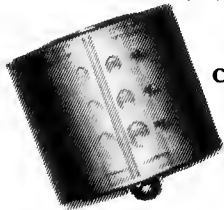

capacities to
 3850 gpm

patent no.
 4822486

Save Time – eliminates the headache of manual screen scrubbing

Save Money – maintains maximum pump efficiency

For more information:

Perfection Sprinkler Co.

2077 S. State St.
 P.O. Box 1363
 Ann Arbor, MI 48106

313 761-5110 FAX 313 761-8659



Lambert, Lee & Associates

CONSULTING ENGINEERS
 SURVEYORS

Extensive experience in all aspects of cranberry land development: evaluation, purchase, survey, design, permit acquisition, phased construction and planting both in wetlands and uplands.

Have references. Will travel.

Contact: Will Lee
 10948 Highway 54 East
 Wisconsin Rapids, WI 54494
 (715) 424-3131

The Pilgrim stands behind
every commercial loan
John Bermingham
makes.



And that's a
promise.

Call him on it at 888-2092.

The Pilgrim is a symbol of strength, integrity and experience; and it best personifies the resources John Bermingham offers every business that turns to him for help.

A vice president of our commercial banking operation, John has over 20 years of banking know-how. His expertise has helped to earn us a reputation as The Answer Bank.

Backed by the superior lending capabilities of Plymouth Savings Bank, John can design a commercial lending package with the attractive rates and fast turnaround time that you need.

This is the power and the promise of the Pilgrim.

Call John Bermingham at 888-2092.

Main Office: Wareham, (508) 295-3800;
Cotuit, (508) 428-1300; Duxbury, (617) 934-0101;
Falmouth, (508) 548-3000; Marion, (508) 748-2919;
Mashpee, (508) 477-7984; Mattapoisett, (508) 758-4936;
Middleboro, (508) 946-1777; North Plymouth, (508) 747-1600;
Plymouth, (508) 746-3300; Sandwich, (508) 888-4444;
Teaticket, (508) 540-5002

Plymouth
 **Savings**
Bank[®]

Member FDIC/DIFM

Take Good Care of Yourself Have an Ocean Spray!



The farmer's cooperative that brings you
a wide range of natural fruit juices, drinks and sauces

Ocean Spray Cranberries, Inc., Lakeville-Middleboro, MA 02349

An Equal Opportunity Employer

83
83
7
er

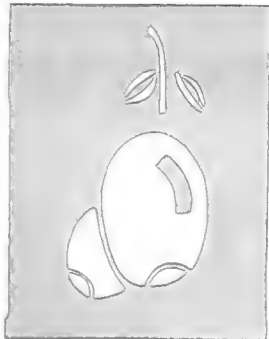

CRANBERRIES

THE NATIONAL CRANBERRY MAGAZINE

October 1989

Vol. 53, No. 10



**Growers 1st
To Use
Nematodes**

**New Book
On Wisconsin
Cran History**

**Changing
Of Guard
For CCCGA**

**Another
Record Crop
Is Forecast**

S

UNIV OF MASS LIBRARY
SERIALS DEPT
AMHERST
MA
01003

Cranberry Harvesting Equipment

Warrens Equipment & Manufacturing Co., Inc.

Growing cranberries is something you as a grower do best. Manufacturing of harvesting equipment, air flow, radar controlled fertilizer spreading equipment, and flow gates or flumes is something we do that can be of service to you.



NEWS FLASHES

Standard WEM Bog-Trac Tractors & Beaters Available For Immediate Shipment

- *Beater reels available, your choice of designs*
- *You as a grower tell us what is best for your bog*
- *Change your reel rpm from bog to bog or variety to variety*
- *Engine horsepower available from 18 h.p. to 48 h.p.*
- *Safety parking brake*
- *Ground speed and reel speed indicator*
- *Lighter weight*

Be sure to check this new model harvester before you make a purchase for 1989.

WEM Factory *servicing Wisconsin, West Coast, British Columbia*
111 Grant St.
Warrens, WI 54666
Tel. (608) 378-4794
(608) 378-4137

WEM East Coast
Stearns Irrigation, Inc.
790 Federal Furnace Rd.
Plymouth, MA 02360
Tel. (508) 746-6048

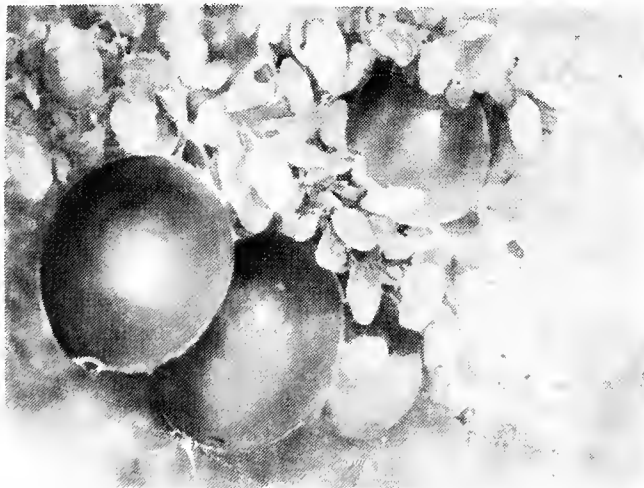

6 Notes, 3 of Each Design with Envelopes
 Are Priced At \$6.50 a Package.

To Order CRANBERRY SERIES #1 - Send Check or Money
 Order To:

WOODSHOLM GALLERY
 Rt. 2 McFarland Drive
 Manitowish Waters, WI 54545
 715-543-2975

Shipping/handling - Add \$2.00 plus \$.25 each after 5 packages.

NOTECARDS

FROM BARBARA McFARLAND'S PAINTINGS
"THE GREAT NORTHERN CRANBERRY"
 &
"RAKE 'EM"

Are Available In Full Color, Size 4.25" x 5.5"



First to Use Parasitic Nematodes

Cranberry Growers Pioneer in Biological Controls

Grower members of Ocean Spray marched to the front ranks of agricultural science this past growing season when they became the first farmers in North America to enlist parasitic nematodes instead of chemicals to destroy crop devouring insects.

Nematodes were used previously in small-scale research projects. And they have been utilized commercially in other parts of the world, e.g., Italy. But their use by cranberry growers in the spring and summer of 1989 marked their first use on a commercial scale on this continent.

"We're seeing tremendously positive results," Larry Dapsis, Ocean Spray entomologist and integrated pest management coordinator, told CRANBERRIES.

In Washington state, the spraying of nematodes gave participating growers as much as a 96 percent reduction in black vine weevil. Oregon growers achieved 90 percent control.

THE DEVELOPMENT of such biological controls as nematode use comes at a welcome time, given the growth of pesticide resistant insects, consumer and environmental criticism of agricultural chemicals, the high cost of developing and licensing chemicals and other factors.

Dapsis cautions, however, that much more research needs to be done before biological controls become widespread.

In a spring 1989 nematode project, which involved 66 growers in Oregon, Washington, Massachusetts and British Columbia, some

growers had 100 percent reduction of black vine weevil, others had no reduction.

"Does this have something to do with different soils?" asked Dapsis. "We know soils vary greatly in cranberrying. For these and other reasons, we must have an active research program."

Cost is another significant factor. At this stage, nematodes cost six to 10 times as much as equivalent

chemicals, Dapsis said. The goal of BIOSYS, the company that supplied the nematodes, is ultimately to be competitive in pricing with chemicals, he added.

The field of nematode use is so new that 3½ years ago, to use Dapsis' words, it was an "academic curiosity." University researchers in Washington and Oregon did much of the initial study.

"We came in on the second stage,"

COVER PHOTO

MAGNIFIED 380 times, this is one of the nematodes that may become a significant weapon in the war against cranberry devouring insects. A story on nematode research and development starts on this page. Photo courtesy of Ocean Spray)

Great Bog Sand!

Right from the Heart of Cranberry Country

Reserve your supply now for winter delivery (depending on ice) or we will stockpile at your bog anytime.

Very Competitive Price

Call Today

1-800-696-SAND

Casoli Sand & Gravel Inc.

P.O. Box 750

Hanson, MA 02341

Dapsis said.

That second stage involved a collaborative effort by Ocean Spray, growers, university scientists, including those from the University of Massachusetts, and BIOSYS, a private biological pest control company in Palo Alto, Calif.

Dapsis also credited Dave Simser, researcher for New Alchemy Institute in Falmouth, Mass., for his work in the field.

NEMATODES are unsegmented roundworms embracing some 500,000 species, ranging from the microscopic variety this article is about to 30 foot long tapeworms. Some nematodes are harmful to plants and animals, others, as scientists now know, can be beneficial.

According to Jeff Rundell, Ocean Spray senior public relations representative, it isn't the nematode itself which kills the black vine or root weevil. Rather, the worm carries a species of *Xenorhabdus* bacteria which destroys the larvae of the insect.

The nematode also reproduces in the carcasses of the larvae, thus releasing more nematodes into the soil.

So much for biological study and theory. How are they produced in massive quantities and applied to the bog? That's where BIOSYS came in. The biotechnology company is headed by Dr. Venkat Sohoni, a Ph.D. from Bombay, India, with 17 years experience with Sandoz, where he was vice president of the crop protection division.

First of all, BIOSYS developed a liquid culture, a mix of nutrients and bacteria in which the prolific, microscopic worms thrive. In eight to ten days, a batch of the mix will contain 1½ trillion nematodes.

BIOSYS also formulated a plastic bead to hold or contain the worms. A number of beads are then placed in an 8 x 10 x 2 inch mesh bag. Each bag holds one billion nematodes.

The grower then places the mesh bag in five gallons of water, much like you would put a tea bag in a teapot. Only, instead of absorbing tea the grower's water absorbs nematodes, which hate dry, love



NEMATODES have been used successfully on a commercial scale to control black vine weevil and cranberry girdler.
(Photo courtesy of Ocean Spray)

**WISCONSIN CRANBERRY
HEADQUARTERS FOR
SEVIN XLR**

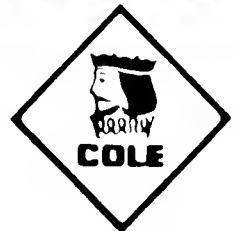

DEVIRINOL 10G • EVITAL • GUTHION
DIAZINON 14G • PARATHION • ETHREL

Cole/Grower Service

537 Atlas Ave., P.O. Box 7211, Madison, WI 53707
(608) 221-6204 or 1-800-362-8049

wet.

Dapsis says the favored method of application is by spraying via the irrigation system. Spraying by helicopter is less favored because the actual quantity of material is so small and the nematodes have a distaste for dry air and ultraviolet light.

Three billion nematodes are sprayed per acre.

IN LATE JULY 300 acres in British Columbia were sprayed with nematodes to combat cranberry girdler. The results had not yet been assessed at the time of this writing.

The outcome is particularly crucial for British Columbia because that cranberry growing province does not have a registered chemical agent against the girdler.

CRANBERRIES spoke to Dapsis just before he was going out to the field to study application of nematodes to the white grub problem, which is particularly besetting Wisconsin.

White grub is coming back as a result of the dissipation of DDT residues, Dapsis said, and so far

there hasn't been a successful trial using nematodes.

The trick, he said, will be to inject the nematodes deeply enough into the soil to reach the white grub without applying so much pressure that the nematodes are injured.

"These natural, biological controls are exciting and will be expanding as we target other insects," Dapsis said.

A focal point of Ocean Spray's future progress in insect control will be the cooperative's new agricultural research center at its Lakeville-Middleboro, Mass., headquarters.

The company plans to build on its first successful commercial application with nematodes through its established partnerships with BIOSY and the aforementioned universities.

GOOD control has been achieved with insecticides used in the past, Dapsis said. One drawback of their use, he added, is microbial degradation. This occurs after a long period of use during which certain microbes are "selected out," leading to soil degradation.

As for the present higher cost of nematode treatment, Dapsis said he expects that the cost will come down as production techniques are enhanced, economies of scale are realized as demand increases, and

inevitable competition arises.

Right now, the Ocean Spray scientist said, nematodes are being introduced into so-called niche markets. Florida citrus and turf are two such markets, he explained. On the other hand, corn growers can't afford the cost at this time.

Pests, said Dapsis, are less likely to build resistance to nematodes the way they do to chemicals.

"That's not to say there won't be any resistance," he noted. "Some insects have an immune system that'll fight off the bacteria. But nematodes won't put on the selection pressure that pesticides do."

Dapsis evidently can talk biological controls all day and he is particularly high on the subject right now, having recently returned from the first international symposium in the field.

"It lasted three days and was held in Pacific Groves, Calif.," he remarked. "There were 107 scientists there from 16 different countries, entomologists as well as people from a variety of other disciplines.

"What they're seeing," he said, "is tremendously positive results."

CRANBERRIES

THE NATIONAL CRANBERRY MAGAZINE

SEND CORRESPONDENCE TO:

P.O. BOX 249

COBALT CT 06414

(203) 342-4730

Fax #: (203) 342-1977

PUBLISHER & EDITOR: BOB TAYLOR

ASSOCIATE EDITOR: CAROLYN GILMORE
(508) 763-5206

ADVISORS & CORRESPONDENTS

MASSACHUSETTS — Irving E. Demoranville, Director, Cranberry Experiment Station.

NEW JERSEY — Phillip E. Merucci, Cranberry & Blueberry Specialist, Buddtown; Elizabeth G. Carpenter, Chetsworth.

NOVA SCOTIA — Robert A. Murray, Horticulturist, Berry Crops, Research Station, Truro.

OREGON — Arthur Poole, Coos County Extension Agent, Coquille.

WASHINGTON — Azmi Y. Shewa, Horticulturist and retired Director, Coastal Washington Research & Extension Unit, Long Beach.

WISCONSIN — Tod D. Planer, Farm Management Agent, Wood County.

CRANBERRIES is published monthly by Taylor Publishing, 2 Weststone Ave., Portland, CT 06480. Second class postage is paid at the Portland, CT Post Office. Price is \$15 a year, \$28 for two years, \$2 a copy in the U.S.; \$17 a year in Canada; \$20 a year in all other countries. Back copies: \$2.50, including postage. Copyright 1989 by Taylor Publishing.

ISSN: 0011-0787

Postmaster, send Form 3749 to:

CRANBERRIES

P.O. BOX 249

COBALT, CT 06414



WANTED

Gravel & Sand

in the southeastern Massachusetts area

Quantities of 10,000 yards and up

Complete site work, bog construction and finished contouring of surrounding area plus the best price for your material.

Michael Coan
(508) 866-5285

Earl White
(508) 359-7291

Distributors of:

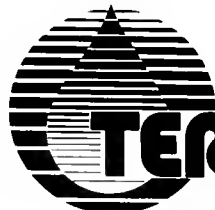

TERRA-SORB™

**"Cut Your Watering
In Half"**

editorial



Wonders of Science

Like all of you, this writer was enthralled over the past month by the photos of a blue Neptune and a pink-blue Triton wondrously captured by that computerized peeping tom of the universe, Voyager 2.

But I also was awed by the wonders inherent in science's research much closer to home, among creatures much too small to be seen by the human eye. Those creatures: nematodes and the bacteria they carry that destroy crop devouring insects.

Both scientific endeavors deal with figures that stagger the imagination. Voyager transmits photos and data over 2.8 billion miles to the Jet Propulsion Lab in Pasadena, Calif. Three billion nematodes are sprayed over a single acre of cranberry bog.

Both fields require highly intelligent, creative and dedicated scientists to bring brilliantly conceived hypotheses to fruition.

All who play a role in the two endeavors—from the astronomers and engineers in Pasadena to the cranberry researchers and growers from Massachusetts to Washington—have a right to feel mighty proud and deserve our hearty applause.

What's in a Name?

The name of the company that publishes CRANBERRIES used to be Taylor Publishing.

Then we changed it to Diversified Periodicals. We're going back to Taylor Publishing.

Diversified Periodicals means something to us. We publish magazines in diverse fields. But it hasn't always meant something to the outside world. We're repeatedly asked to repeat the name of the company. Too many ad agency secretaries ask us two, three or more times to spell both words.

We haven't had to summon much imagination to come up with Taylor Publishing. We publish. Taylor is the last name of the company owner. It's pretty easy to spell. And the name is more suitable, if and when we get involved in occasional book publishing.

So that's that. It's Taylor Publishing.

Letters

WORD FROM FINLAND

Thanks to you for your nice magazine.

Marjo Valtanen

Siilinjarvi, Finland

P.S. A cranberry lover!

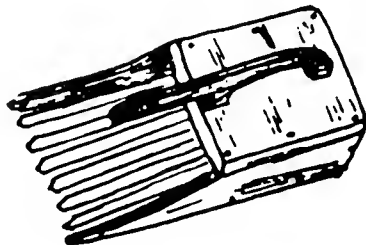

YANKEE PLANNERS, INC.

59 North Main Street
Middleboro, MA 02346
(508) 947-0527

Sound and Objective
Advice
Suited to
Your Needs

Do You Know . . .
How the Government
will value the assets in
your estate? Do you
know what transfer
taxes will be due? Do
you know how they
will be paid? Do you
know that with
effective planning
these taxes can be
significantly reduced?

Mr. William H. Bestgen, Jr.
Chartered Financial Consultant

Mr. Peter W. Hutchings
Attorney at Law practicing as
a Tax Attorney

Mr. Roger H. Parent, Jr.
Accountant, Enrolled to Practice
before the Internal Revenue
Service

Call For Your Free Brochure
(508) 947-0527

Another Record Crop

By **CAROLYN GILMORE**

A record 1989 U.S. cranberry crop of 4,113,000 barrels was forecast by the Cranberry Marketing Committee at its Aug. 15 meeting in Milwaukee.

The committee's numbers are higher than the USDA projection of 3,925,000 barrels.

The 1988 U.S. crop totaled 4,065,859 barrels, according to David Farrimond, general manager of the Cranberry Marketing Committee.

The committee's crop forecast by region is:

Massachusetts, 1,904,000
New Jersey, 360,000
Wisconsin, 1,540,000
Oregon, 162,000
Washington, 147,000

Foreign (Canada), 336,000

Total North America: 4,448,000

Subtracting a 4 percent "shrinkage" or amount of berries delivered to the processor but not handled and adding a handler "carry in" or frozen fruit inventory at harvest amounting to 750,000 barrels, brings the total expected cranberry supply in North America to 5,020,000.

Demand for the fruit, calculated by the committee to be 5,636,500 barrels, would still be higher than supply.

As a result, the committee's policy for the 1989 crop year "does not include any volume regulation recommendation," Farrimond said. Any such recommendation would affect cranberries produced in the

states of Massachusetts, New Jersey, Wisconsin, Oregon and Washington, all of which come under the federal marketing order.

AT the half day Milwaukee meeting, committee members proposed a \$172,602 operating budget, down more than \$25,000 from last year's expenses. The per barrel handler assessment will drop from 5.5¢ per barrel to 3.6¢ per barrel.

"It was a positive meeting," Farrimond said. "The committee formally approved the proposed revisions to the marketing order. The committee also approved sending a formal letter to USDA requesting hearings on the proposed amendments. Tentatively, the committee is expected to conduct hearings in all growing areas during the middle of January through the first part of February."

A week prior to the committee meeting, Chairman Marshall Severance and Farrimond met with USDA marketing order offi-



**Decran Ag Supplies
Inc.**

- ★ Complete line of cranberry herbicides, fertilizers, insecticides, fungicides, miticides. In stock when you want them.
- ★ Best application and safety equipment for your needs.
- ★ Quality aerial applications.
- ★ Proven frost warning equipment. Don't take chances — buy the best.
- ★ Experienced cranberry consulting service offering pheromone traps and baits.
- ★ Right to know training.
- ★ Culvert Pipe — All sizes — steel, aluminum, and poly.
- ★ Ditch Mud Mats — Strong — lightweight — durable.
- ★ Burlap Picking Bags — Best for your money.
- ★ Sanding by helicopter.

John C. Decas

William D. Chamberlain

461 Mary's Pond Rd.
Rochester, MA 02770

Office: 295-2731
Evening: 763-8956
Fax: (508) 291-1417

Serving Massachusetts Cranberry Growers

cial and legal counsel in Washington, D.C.

"They were satisfied the proposed amendments met legalities," Farrimond reported.

It is still a lengthy process until growers can vote on the amendments, he said. The hearings are followed by transcriptions of the meetings, a comment period, USDA review, evaluation and recommendations, a second comment period and final decision by USDA to hold the referendum.

"It will be at a minimum a year to 18 months before growers can vote on (the amendments)," Farrimond said. "The committee is hopeful the growers will vote to accept the proposed amendments. It has taken five years of work to this point."

Among other matters, the amendments involve base quantity assignments.

The next full committee meeting will follow the March 1990 hearings in Washington, D.C.

CRANBERRY



COMPUTER, INC.

CRANWARE

- Growers
- Handlers
- Chemical Applications
- Chemical Resale

(508) 747-3033

P.O. Box 1037, Plymouth, MA 02360

**Niemi
Electric
Company**



Robert
Niemi
**Electrical
Contractors**

Heat, Light & Power Wiring

- RESIDENTIAL
- COMMERCIAL
- INDUSTRIAL

**Pinehurst Drive
Wareham, Mass.
TEL. 295-1880**

WOLLSCHLAGER EXCAVATING

Dragline Work — All Kinds

Also Have Clam & Scalping Buckets

**Route 1 Necedah, WI 54646
1-800-565-2436**

Vines For Sale

E. W. Bowker Co.

Box 581, Magnolia Road Pemberton, NJ 08068

(609) 894-9231

(609) 894-9508

New Hybrids

35 and Croppers

Also, Le Munyon

Call for Price

Spring '90 Delivery

Financial Strength. . .

Personalized Service.

Isn't That What You Need In A Bank?

The Jackson County Bank has supported agriculture in the area for more than 110 years.

We recognize the importance of the cranberry industry and are pleased to provide financial services for all your banking needs.

We're large enough to serve you and yet we offer personalized service which your business demands. Call us at 715-284-5341

The Jackson County Bank. A name to count on throughout the years.

You'll like the difference.



**JACKSON
COUNTY
BANK** Member FDIC
(715) 284-5341

Black River Falls, Alma Center, Hixton, Merrillan, Taylor, WI 54615

The Pilgrim stands behind
every commercial loan
Larry Venezia
makes.



And that's a
promise.

Call him on it at 888-2092.

The Pilgrim is a symbol of strength, integrity and experience; and it best personifies the resources Larry Venezia offers every business that turns to him for help.

A vice president of our commercial banking operation, Larry has 11 years of banking know-how. His expertise has helped to earn us a reputation as The Answer Bank.

Backed by the superior lending capabilities of Plymouth Savings Bank, Larry can design a commercial lending package with the attractive rates and fast turnaround time that you need.

This is the power and the promise of the Pilgrim.

Call Larry Venezia at 888-2092.

Main Office: Wareham, (508) 295-3800;
Cotuit, (508) 428-1300; **Duxbury,** (617) 934-0101;
Falmouth, (508) 548-3000; **Marion,** (508) 748-2919;
Mashpee, (508) 477-7984; **Mattapoisett,** (508) 758-4936;
Middleboro, (508) 946-1777; **North Plymouth,** (508) 747-1600;
Plymouth, (508) 746-3300; **Sandwich,** (508) 888-4444;
Teaticket, (508) 540-5002

Plymouth
 **Savings**
Bank[®]

Member FDIC/DIFM

100 Years of History in Wisconsin Cranberry Book

By FRED POSS

Everyone's "good book," the Bible, has a favorite passage that reminds us, "For everything there is a season." And to commemorate one hundred harvest seasons of the Wisconsin Cranberry Growers Association, some of the members have put their heads together to publish the *Wisconsin Cranberry Growers Centennial Heritage Book*.

The timing of the publication couldn't be better if you listen to some of its promoters. According to information released by Carolyn Habelman, co-chair of the project, the book emerged in final form just in time for the summer field day held at the Ocean Spray Warrens Receiving Station this August 8.

And not only is the book's arrival timely—so are its contents.

Nordji Van Wychen, past president of the growers association, explained that the book "is probably our growers' best reference guide for our association right now."

With more than a little pride in her voice, she related the background of the book's creation.

"It was completely done by volunteers from the cranberry association," she said. "And they spent many, many hours working on this. We are very proud of the outcome . . . and we feel this will be a keepsake for years in the future."

JUDIE Harkner, the other co-chair of the book project, shared some insights into the nuts and bolts of financing such a publication.

"A small margin of profit will be realized as a result of the sale of the book," she said, as she staffed the sales table for the work. "And after all the books are sold, the committee will probably meet in May to do something in the form of charity with the money left over."

What charitable avenues will the committee consider?

Harkner explained, "Well, we want to promote the Wisconsin cranberry industry, so we're not sure if it will be in the form of donations to charitable organizations who, in turn, support the industry, or if we'll do it in the form of an educational scholarship or educational book or pamphlet to distrib-

ute throughout the area to visitors.

"With the growers' centennial coming up, we felt it (the book) would be extremely timely to write and Carolyn Habelman had experience writing a historical book," Harkner concluded. She said about 20 individuals contributed their time and the the project took about

SKIPPAR POLE SERVICE



- Private Poles • Line Construction
- Sonotube Drilling • New & Used Poles

(508) 690-2238

208 Franklin St., East Bridgewater, MA 02333



Irrigation Supplies

- 2" to 12" PVC Pipe with Fittings
- Quick Couple Risers
- Felker Aluminum Flumes & Culverts

Replace old aluminum mains with government approved 4", 6" and 8" polyethylene pipe buried just below bog surface. No insert fittings. Rent our butt fusion welder for a continuous main line. Beat the high cost of custom installation by renting our small 4-wheel drive tractor with mole hole plow for buried laterals.

STEARNS IRRIGATION, INC.

790 Federal Furnace Rd.

Plymouth MA 02360

Tel. (508) 746-6048

a year to finish.

Carolyn Habelman, appearing as a relief pitcher for those at the busy sales table, generously took time away from that work to provide more information about the contents of the book.

"We started out with a chronological history of the industry, then we branched into the history of the growers association in the state of Wisconsin," she told me. "And then we put in 'The Beginnings' . . . things prior to when Wisconsin was even a state, and then brought it up . . ."

BUT besides historical fact, Habelman, Harkner and crew were able to weld together some highly unusual and fascinating elements in the heritage book.

Habelman explained: "And then we interviewed seniors (senior citizens) and had them type up their memories of the industry and what they were told of the early 1870's and 80's. And then the next (book section) was 'The Centennial.' Then we went into biographies—anyone associated with the industry today—grower, worker on the

marsh or workers in the plant.

"Then we had a section on memorials," she said, "memorials to people who were important to the industry."

Other sections Habelman mentioned were poetry and song as they related to cranberries and recipes using cranberries, beginning with a hundred years ago and coming up to the present day.

And the research is well documented. Mrs. Habelman spoke with real authority about the heritage publication as she listed such sources as the Wisconsin State Historical Society, agricultural records, industry newsletters, books, pamphlets, growers association minutes and information gleaned from CRANBERRIES magazine.

And to help pay for such a publication, what did the committee come up with?

"The business ads," she revealed. "We asked them not to put in a (regular) business ad. We wanted a history of their business and what they did for the industry, whether it be a lawyer or a business that sold irrigation pipes—with pictures telling like what their business looked like 40 years ago, as well as what they sell today."

Ocean Spray, she explained, donated the price for the color pictures inside and back that capture the beauty of harvest time.

Those interested in obtaining a copy should know the 315 page heritage book comes with a cranberry red leatherette 9 x 12 cover embossed in gold, with a gold medallion depicting a cranberry grower using the old Wisconsin hand rake in a cranberry bed.

The book sells for \$38.50 plus \$3.50 shipping. Wisconsin residents should add 5% sales tax. Orders may be addressed to: Wisconsin Cranberry Growers Centennial Book, Judie Harkner, Route 3, Box 263B, Black River Falls, WI 54615.

One glimpse of the rich exterior and fascinating saga of the Wisconsin cranberry industry captured between the pages of the heritage book induces one to paraphrase an old and revered saying: One good turn of the page deserves another.

That's what readers will be doing with the pages of this good book, this unique record of the Wisconsin cranberry story.

K Ag Laboratories International, Inc.

**2323 Jackson Street
Oshkosh, WI 54901**

**Serving Cranberry
Growers in U.S.A.
& Canada since 1984**

**Over 20 years
of Experience on
Acid Soil Interaction**

K Ag Laboratory has run over 30,000 cranberry soil and over 17,500 cranberry vines tests since 1984, and gave fertilizer recommendations with great success.

- ★ *Cranberry Soil Analysis*
- ★ *Cranberry Vine Analysis*
- ★ *Cranberry Water Analysis, Usage & Interpretation*
- ★ *Liquid & Dry Fertilizer Recommendation*
- ★ *Soil Problems & Consultation*
- ★ *Seminars*
- ★ *Cranberry Crop Monitoring Program, testing and monitoring nutrient status with 30 day intervals during the growing season.*

Highly computerized cranberry soil, tissue and water testing program in U.S.A. and Canada.

For more information contact: **Dr. Akhtar Khwaja, Ph.D.**
Certified Professional Soil Scientist
Certified Professional Agronomist

Phone Number 414-426-2220; Out of WI 1-800-356-6045; FAX 414-426-2664

REGIONAL NOTES

MASSACHUSETTS

By IRVING E. DEMORANVILLE

Carolyn DeMoranville attended the annual meeting of the American Society for Horticultural Science held in Tulsa, Okla., July 29-Aug. 4. She presented a paper on nutrition studies on cranberry vines.

WISCONSIN

A combined museum and gift shop, Cranberry Expo Ltd., has opened at the Potter Cranberry Marsh in Warrens. Operator of the museum is Peggy Anderson as a tribute to grandfather, father and uncles, who have been involved with cranberrying in central Wisconsin for 140 years.

Weather

MASSACHUSETTS

July was cool, averaging 1.3 degrees a day below normal. Maximum temperature was 87 degrees on both the 7th and 28th and minimum was 53 degrees on the 1st. It was cool the early part of the month and again just after

the middle of the month. Otherwise, it was just average.

Rainfall totaled 5.47 inches or nearly double the normal. This is the fourth largest in our records, surpassed only in 1988, 1928 and 1956. It also makes five of the past six years that July rainfall has been substantially above normal. There was measurable rainfall on 10 days, with 2.86 inches on the 16th and 17th as the greatest storm. Several bogs suffered substantial hail damage on the 30th. The hail wasn't widespread, however.

We are nearly 2 inches above normal for 1989 and about 1 inch above 1988.

I.E.D.

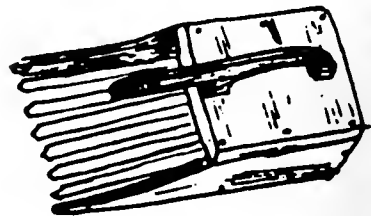

Turf **Equipment Inc.**

381 West Grove Street (Rte. 28)
Middleboro, MA 02346

KUBOTA Diesel Equipt.

Tractors 2 & 4 wheel drive — 12-90 hp.

Compact Excavators 1½ to 6 ton

Wheel Loaders ½ to ¾ yd.

Water Cooled Diesel Engines 4 to 104 hp.

All Types of Implemants

Polymark Beaver-Mowers 947-6299

Specialty Fabrication Work

Kubota Financing as Low as 8½%

*Sales *Service *Parts *Leasing

Office
295-2222

BEATON'S CRANBERRY GROWERS SERVICE

K. Beaton
295-2207

D. Beaton
888-1288



WAREHAM, MASS.

Specializing in

P. Beaton
947-3601

● COMPLETE BOG
MANAGEMENT

● NETTING

● DITCHING

● HARVESTING
(Wet & Dry)

● SANDING

● CUSTOM
HERBICIDE
APPLICATION

Complete line of portable Crisafulli Pumps 2" - 16"
Plastic netting for suction boxes





THE BEST — IN EVERY RESPECT

CRANBERRY Model 400 GT

Precision Chemigation System



- Developed *Exclusively* for the Cranberry Industry
- Exceeds or Meets ALL Current EPA Requirements
- Simple to Operate and Easy to Calibrate
 - Self-Timer Application (1 minute Increments)
 - Easy Access Handle & Simple Reference Scale
 - Precise Visual Flow Calibration
- Outstanding Field Performance
 - Down-Line Venturi Injection System
 - High Capacity 0-7 GPM Injection Rate
 - Large Volume 175 Gallon Mix Tank
 - 12 Volt Gear Reduction Mixer
- Designed for Trouble-Free Operation
 - Reliable 11 HP Honda Electric Start Engine
 - Critical Components Are Stainless Steel & Polypropylene
- Completely Self-Contained and DOT Approved Transportable
- Personalized, Experienced Support Service as Close as Your Phone

CHEMIGATION SYSTEMS INTERNATIONAL, INC.

Corporate Offices: P.O. Box 247
 (608) 297-2041

Montello, WI 53949
 FAX: (608) 297-7248

Call us today for the dealer nearest you, or contact:

Skip Tenpas
 Central Sands Irr. & Bldg., Inc.
 Hwy 51 & 73 Interchange
 Plainfield, WI 54966
 (715) 335-6372

Bruce Sunnerberg
 AAA Industrial Pump & Ser., Inc.
 66 Lake Street
 Plympton, MA 02367
 (617) 585-2394

NOTICE
 Selected exclusive
 dealer territories
 still available —
 Inquiries invited

CCCGA Annual Meeting

New Prexy Calls for Grower Action

By CAROLYN GILMORE

Jeffrey Kapell, the Cape Cod Cranberry Growers Association's president-elect, told growers at August's annual meeting that his goal for his two year term of office is to step up efforts to educate the public about the role of the Massachusetts cranberry industry.

He said cranberry growers must have an active voice in local and

state regulations affecting agriculture.

"Some growers are beginning to think this is getting to be a lot less fun," Kapell said. "Unfortunately, the world has changed and you're not going to be left alone anymore."

Stepping off the board of directors were David Mann and Benjamin Gilmore II. They were replaced by Wayne Barnes and

Kirby Gilmore.

The association's annual meeting was attended by about 750 growers, guests and families. Displays of tractors, trucks, IPM services, cranberry paraphernalia and investment services were set up by the Massachusetts Cranberry Experiment Station.

A barbeque was sponsored by the CCCGA.

Past Prexy Reflects on Term

Douglas R. Beaton, immediate past president of the Cape Cod Cranberry Growers Association, reflected on his term of office in the July/August 1989 issue of the CCCGA newsletter.

Below are his words:

"As you know, I will be stepping down as president of the association later on this month. The last two years have been quite a challenge for the CCCGA, but all in all I would say that we have accomplished a great deal.

"First of all, I want to thank the employees and committee members of the Cape Cod Cranberry Growers Association for their hard work; the board of directors, for being patient and productive; but most of all, the membership, for their unyielding support, because, after all, without an active membership, our association would be ineffective.

"I first became 'active' in the CCCGA in 1975, when I was elected to our board of directors. I can remember the frustration that the influx in government regulations had caused our growers during that time of 'environmental awakening.' Back then, we used to wait for new laws and regulations to come out, and then we would react. More often than not, it was a case of too little action too late.

"The wetland laws are a great example of how important it is for cranberry growers, as an entity, to be involved before, during and after the development of local, state and federal legislation. That one piece of legislation, as I am sure you all know too well, has vir-

tually denied our local industry growth. Maybe if we had been more involved in the legislative process, and presented all the ways in which cranberry bogs benefit wetland environments, those laws wouldn't have been passed.

During my two year term in office, the CCCGA has attempted to create a situation where we are working *with* the regulators and legislators, rather than against them. For the first time in our 102 year history, we hired a full-time executive director (Jeffrey Carlson) and a governmental affairs director (Henry Gillett).

With these new additions to the CCCGA, we will now always be aware of and participate in regulatory issues. Since we have been working with, rather than against the regulators and legislators, the association has accomplished much.

We are now viewed as a 'model' industry by achieving 95 percent compliance with the 'Right to Know' law! Just recently, we worked with the EPA to amend the chemigation requirements to accommodate the cranberry industry. We have also fought very hard to achieve a fair and equitable tax rate in the town of Carver and have been successful in preventing a number of expensive and damaging laws and regulations from being enacted.

As my term draws to a close, I would like to emphasize the importance of your involvement, not only at our monthly meetings, but also at the local board of health, zoning and conservation commission meetings. We need to

invest time into these local agencies, so that we don't, once again, find ourselves reacting after the fact.

Once again, thank you for all of your support over the past two years, and good luck with your harvest.



Equipment, Inc.

381 West Grove St. (Rte. 28)
Middleboro, MA 02346

(508) 947-6299

 **KUBOTA**
Tractors, Excavators and
Diesel Generators

 **DOYOTE**

Wheel Loaders
3/4 Yd - 6 1/2 Yd

Screening Equipment



AMONG the demonstrations at the Cape Cod Cranberry Growers Association annual meeting was this one of a “sure-flo,” self-cleaning suction screen.
(CRANBERRIES photos by Carolyn Gilmore)



SKID Whipple of the Forges Cranberry Co. won first prize in the grower constructed equipment award for this sanding barge he built.



THIS IPM exhibit at the Cape Cod Cranberry Growers Association annual meeting was staffed by personnel from the Cranberry Experiment Station, Ocean Spray and DeCran Ag Supplies. (CRANBERRIES photos by Carolyn Gilmore)



JOE THOMAS, editor and publisher of Spinner Publications, addressed the group on the book he is preparing on the history of the cranberry industry in Massachusetts.

'The Big Chill' Awaits Berries Sent to New Storage Facility

By FRED POSS

The Wisconsin Cranberry Growers Association and the staff of Ocean Spray's Warrens Receiving Station provided a warm, congenial welcome to visitors and guests attending the Summer Field Day held in Warrens Aug. 8. And there was nothing chilly about the friendly assistance the growers association provided with packets of information for everyone or the thorough tours of its state-of-the-art receiving station Ocean Spray had ready and waiting.

"We expect over a thousand people today," explained Marianne Strozewski, as she and Sue Dempsey of the WCGA busily distributed materials from the welcome table just inside the front door.

But all the glad-to-meet-you warmth aside, the growers and the receiving station seriously intend to put the "big chill" on business beginning this year!

"Ocean Spray is arranging to lease some of the 80,000 square feet of freezer space and 20,000 square feet of processing space in a new Americold facility being constructed adjoining our Warrens Receiving Station," explained Sheryl Rucker, tour guide for Ocean Spray. "Americold is a nationwide freezing company and when the cranberries are harvested, received, cleaned and weighed, they can be sent to the Americold freezers to be stored for up to one year—perhaps even longer."

THERE was nothing cold or stingy, however, about the effort Ocean Spray put forth to demonstrate the wonders of its automated receiving station.

Beginning with a look at three huge, open concrete pools for receiving the fruit, Ms. Rucker cheerfully escorted our group around the station, precisely explaining each step of the operation.

The three pools will each be 10 to 12 feet deep with cranberries, she revealed.

The berries are washed there after a random sampling of fruit, using a vacuum probe, has been taken from a truck. Air cleaners separate out the

vines and leaves. Brushwashers then remove any fruit that does not meet the high standard of quality that Ocean

(Please turn page)



Lambert, Lee & Associates
CONSULTING ENGINEERS
SURVEYORS

Extensive experience in all aspects of cranberry land development: evaluation, purchase, survey, design, permit acquisition, phased construction and planting both in wetlands and uplands.

Have references. Will travel.

Contact: Will Lee
10948 Highway 54 East
Wisconsin Rapids, WI 54494
(715) 424-3131

Vines For Sale

Ben Lear	\$5,000 a ton
Stevens	\$4,000 a ton
Crowley	\$4,000 a ton
Bergman	\$4,000 a ton

Prices are F.O.B.
\$500 a ton less with 50% payment before cutting

Richberry Farms Ltd.
11280 Mellis Drive
Richmond, B.C.
V6X 1L7 Canada

Res. (604) 273-4505
Bus. (604) 273-0777

Spray sets.

After grading into different sizes which qualifies the berries for either dark, medium or light cranberry lines, the fruit is shuttled into 1,200 lb. tote bins or into bulk trucks to be shipped to the freezer and later processed into various cranberry and fruit drinks, sauces and snack items.

FINISHING the tour atop the control panel located in the center of the building, our guide concluded by showing how the buttons on the panel matched up with the various conveyor lines.

"The plant can be run by one person," she said—an amazing comment on the investment in technology that Ocean Spray has made at the Warrens station.

And though our tour "chilled out" and Ms. Rucker turned to warm up another, the growers meeting, displays, demonstrations and equipment dealers

that beckoned for attention at Summer Field Day could be characterized as "really cool" too!

The growers association had a carefully laid out agenda for the field day: 8:30 a.m. registration, 9 to noon exhibits, then lunch, a welcome by Charles "Chuck" Strozewski, new president, and a business meeting in the afternoon.

Casually walking about, one couldn't avoid the coldest treat of the day—cranberry ice cream being served up free for the asking as a means of promoting one more inventive use for the little red berry that provides a livelihood for so many families.

And artists such as Ann Kurz Chambers from Port Edwards, Wisc., who specialize in cranberry originals—paintings, ceramics, intaglios and even clothing—were on hand to demonstrate and sell their work. Ms. Chambers explains in her brochure that "my

greatest reward is the interest and encouragement of all who appreciate

TAUNTON 4 Prime Bogs

- 22 Acres
- Good Water & Soil
- Dormant - Ready to Rebuild
- Chapter 61 A - Plans

LEASE OR SALE
(508) 896-6262



Cranberry Originals®



T-Shirt
Size 18 Months
\$8.00



T-Shirt
Size 2
\$9.00

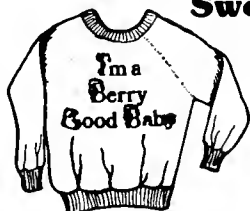

Sweatshirt
Size 18 Months & Size 2
\$15.00



Sweatpants
Matching White (no design)
12, 18, & 24 months.
\$12.00

All Shirts have red and green print on white, 50/50 poly/cotton.

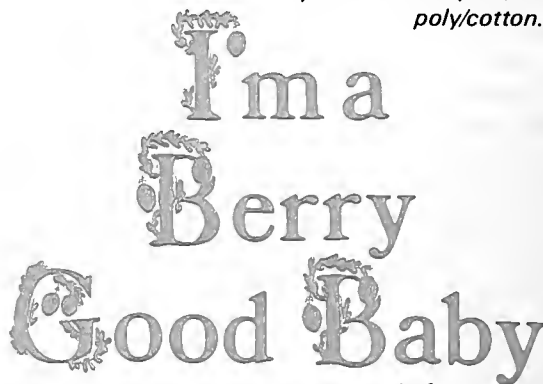

© Ann Kurz Chambers 1989

"I'm a Berry Good Baby"

Red and green screenprint on white, 50% cotton/50% polyester.

T-shirt (lap shoulder)	18 months	\$ 8.00
(crew neck)	2 years	\$ 9.00
Sweatshirt (snap shoulder)	18 months	\$15.00
(crew neck)	2 years	\$15.00
Matching Sweatpants, white	12 mos., 18 mos., 2 years	\$12.00

Send Check or Money Order to:

CRANBERRIES
P.O. Box 249
Cobalt, CT 06414

Add \$3.50 Shipping & Handling Charge
For Canadian orders, add \$8

Please specify item and quantity

NAME

ADDRESS

CITY STATE ZIP

my work.”

Another business that really does put the “big chill” into its work is Cran-trol, an insect scouting service out of Warrens that has newly been established by Laurel Riedel.

Ms. Riedel generously took time to explain how her college work and natural interest in biology led her to create a professional service to rid cranberry growers of pests. Her business literature points out how advantageous it is to use a scouting service.

Early identification of insects, regular examination done by a professional and avoidance of misdiagnosed deer damage are all features that her new business offers to potential customers.

OF COURSE, cranberry royalty was on hand, too, to thaw even the coldest stranger with generous smiles and a few good words about cranberries. Cranberry queen Missy Nelson and princesses Ami Matson and Sue Walheim were there to remind visitors of the soon to come Warrens Cranberry Festival.

All in all, most everyone interviewed seemed to agree that the 1989 Summer Field Day was a red hot success. Due to the tireless efforts of the staff of Ocean Spray, the volunteers and officers of the growers association, artists,

business men and women and over a thousand visitors and guests, the only big chill of this harvest season is a big, brand new freezer for the fruit crop that was turning red on the vine. And, given the size of the freezer, maybe even grandma can rent some locker space in it for her cranberry preserve.

OVER 2 MILLION FARMS

The Census Bureau reports that the United States had 2,087,759 farms in 1987.

Only slightly over one-half of those farms—1,059,573—had annual product sales of \$10,000 or more, however.

R.D. GRASSI *Cranberry* SERVICES

**Herbicides
Applied**

*Custom Pruning
Custom Ditching*

*Sanding
Wiping
Wet Harvesting
Mowing*

*(Mowing includes
Hydraulic Arm
Flail Mower.)*

**West Wareham,
Massachusetts**

**Ask for Rick at
295-5158**

Irrigation Equipment Designed Especially for the Cranberry Industry

- Gorman-Rupp Self Priming Electric Sprinkler Pumps
- Proven Quick Couple Riser
- Polyethylene Main Lines, 3" - 12"
- Butt Fusion Equipment Available
- Paco/Wemco Water Harvest Pump
- Berkeley Self-Priming and Centrifugal Pumps

A Most Complete Inventory of Irrigation Accessories

LARCHMONT

IRRIGATION / SNOWMAKING

P.O. Box 66, 11 Larchmont Lane
Lexington, Massachusetts 02173 (508) 862-2550

Contact

Larchmont Engineering
Phil Tropeano, President
(508) 862-2550
(Call Collect)

Stearns Irrigation, Inc.
790 Federal Furnace Rd.
Plymouth, MA 02360
(508) 746-6048

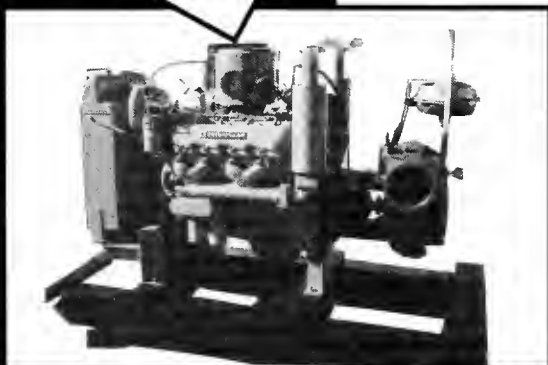



'OH, I LOVE FARMING. IT'S JUST THAT WE HAVE TO BE CAREFUL OF OVERPRODUCTION.'

**CRANBERRY
GROWERS
REALTY**

*Listings of buyers and
sellers welcomed on
cranberry acreage
and upland.*

Appraisals

DOUGLAS R. BEATON
E. Sandwich, Mass
02537
(617) 888-1288

J.A. JENKINS & SON CO.

Grower Service

**MOWING (ALL TYPES)
SANDING**

**DITCHING
WEED WIPING**

Serving Cape Cod

227 Pine St., W. Barnstable, Ma. 02668

Phone 362-6018



Specify item and quantity

Consensus Reached on Definition of Organic

Representatives of the organic food producers and mainstream agriculture reached consensus on a definition of *organic* at a

recent meeting in Dallas.

The meeting was called by representatives of the United Fresh Fruit and Vegetable Association in order to achieve standard language which can be understood by consumers, retailers and growers. This lack of uniformity, the proliferation of state laws and regulations, and the recent efforts at the Congressional level and in the federal

agencies has produced an evergrowing hodgepodge of regulatory activity, according to an association spokesperson.

"We have really begun to sort it out," said James C. Wiers, president of Wiers Farms/Dutchmaid Produce, Willard, Ohio, and chairman of the meeting. "There was a tremendous spirit of cooperation among the participants at the meeting and a real desire to reach agreement."

The 45 attendees represented a cross section of conventional agriculture, organic grower/shippers, trade associations, and state departments of agriculture and federal agencies. The final definition was achieved after discussion of the various existing definitions.

Both United and the Organic Foods Production Association of America (OFPANA) had distributed a survey to their members and other key agriculture representatives to pinpoint areas of concern and misunderstanding. Presentations were made by Robert DeSpain of Organically Grown Co-op, and Lynn Coody of Oregon Tilth, both Oregon-based and co-authors of the new



General Excavating

Pond Construction & Maintenance
Land Clearing, Ditching, Canal Work

Dragline (63' reach) & Clamshell
Gradall 6' Bucket
D-8 Dozer
Road Grader

Bill Conway
228 W. Brittonia St.
Taunton, MA 02780
(508) 822-1085

CAPEWAY BEARING & MACHINE, INC.

BEARING & DRIVELINE SPECIALISTS



— MACHINE SHOP SERVICE —
508 - 747-2800

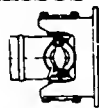

BEARINGS

BOAT & TRAILER
BOWER - BCA
C/R DISTRIBUTOR
FAG
FLANGE UNITS
INDUSTRIAL
KOYO DISTRIBUTOR
MARINE CUTLAS
PILLOW BLOCKS
SKF
TIMKEN
TORRINGTON

BELTS

DAYCO

DRIVELINE COMPONENTS

BORG-WARNER
C/V SHAFTS
DETROIT
FRONT WHEEL DRIVE AXLES
HANGER BEARINGS
MOTOR MASTER UNIVERSAL JOINTS
NEAPCO DISTRIBUTOR
PTO'S
PTO COMPONENTS
ROCKWELL
SPIODER CLUTCHES
SPICER-DANA
UNIVERSAL JOINTS FOR ALL CARS
TRUCKS AND HEAVY EQUIPMENT

FILTERS

BALDWIN DISTRIBUTOR

HYDRAULICS

COMMERCIAL PUMPS & COMPONENTS
GRESEN
HYDRAULIC HOSE

LUBRICATION

ALEMITE SUPPLIES
KENDALL
FEL-PRO

SEALS

C/R DISTRIBUTOR
NATIONAL
NATIONAL O-RINGS
STEMCO

TRANSMISSION & REAR END

EATON
FULLER
ROCKWELL
SPICER
TRANSMISSION & REAR AXLE
REBUILDING KITS

POWER TRANSMISSION COMPONENTS

DAYCO COMPONENTS
CHAIN
MECHANICAL CLUTCHES
PULLEYS
RIGHT ANGLE DRIVES
SPROCKETS

AP

HEAVY DUTY TRUCK EXHAUST

SUPPLEMENTARY PRODUCTS

BRONZE BUSHINGS • GASKET PAPER • HARDWARE • HELICOIL
LOCKING HUBS • LOCITE • MORSE CABLES • POLLACK ALARMS

— MAJOR SUPPLIER AND MEMBER —

CAPE COD CRANBERRY GROWERS ASSOCIATION • CAPE COD TURF MANAGERS ASSOCIATION
MASSACHUSETTS LOBSTERMEN ASSOCIATION

100 CAMELOT DR., PLYMOUTH, MASS. 02360

CRANLAND SERVICES

Cranberry Property
Appraisals

★ ★ ★ ★ ★

Listings and Sales of
Cranberry Properties.

License # 68987

Lawrence W. Pink
Old Cordwood Path
Duxbury, MA 02332
(617) 934-6076

Pump Repairs & Sales

All Types

- Field Service
- Chemigation Equipment Sold
- Demonstration by Appointment

AAA Industrial
Pump Service Inc.

Bruce Sunnerberg
66 Lake Street
Plympton, MA 02367
(617) 585-2394

Senate bill just introduced in that state.

Also presenting were Mark Lipson of California Certified Organic Farms, Larry D. Woodson of California Certified Organic Farms, Larry D. Woodson of the Kansas Board of Agriculture and Keith Jones of the Texas Department of Agriculture.

The definition as finally approved is:

I. Organic food production systems are based on farm management practices that replenish and maintain soil fertility by providing optimal conditions for soil biological activity.

II. Organic food is food which has been determined by an independent third party certification program to be produced in accordance with a nationally approved list of materials and practices.

III. Organic food is documented and verifiable by an accurate and comprehensive record of the production and handling system.

IV. Only nationally approved materials have been used on the land and crops for at least three years prior to harvest.

V. Organic food has been grown, harvested, preserved, processed, stored, transported and marketed in accordance with a nationally approved list of materials and practices.

VI. Organic food meets all local, state and federal regulations governing the safety and quality of the food supply.

At the next meeting of the group, guidelines for certification organizations, the contents of the list of "nationally approved materials and practices," labeling and the structure of a national review board will be discussed.

The United Fresh Fruit and Vegetable Association is the leading trade organization serving the fresh produce industry. United's 2,500 member companies represent grower/shippers, brokers, wholesalers, food service operators, retailers and allied industry suppliers in the United States and 24 countries around the world.

BOOK BEING PREPARED ON CRANBERRY INDUSTRY

The Plymouth Savings Bank and the Cape Cod Cranberry Growers' Association are sponsoring a book on the Massachusetts cranberry industry to be published early next year by Spinner Publications.

Author of the book is Joe Thomas. Spinner is currently looking for old photos for the work. Anyone interested should contact Thomas at Spinner Publications, P.O. Box C-801, New Bedford, MA 02741. Or call (508) 994-4564.



CEECO CORPORATION

OF NEW ENGLAND

Industrial Suppliers To The Cranberry Industry



Chain, Cable and Accessories
Used for Making Mats

All Types of Fasteners (Bulk & Packaged)

Hand Tools	Pumps
Power Tools	Motors
Chemicals	Abrasives
Lubricants	Cutting Tools

Safety Equipment

Richards Rd.
Plymouth Industrial Park

747-0086
Plymouth, MA 02360

The CHARLES W. HARRIS Company

451 Old Somerset Avenue
North Dighton, Mass.
Phone (508) 824-5607

AMES
Antisiphon Devices

RAINBIRD
Sprinklers

HALE
Pumps

*Highest Quality Products
With Satisfaction Guaranteed*

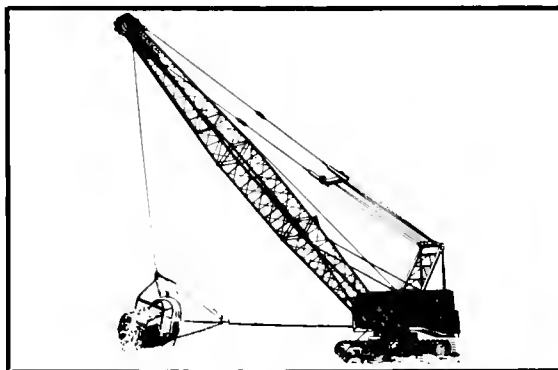

Krause Excavating, Inc.

Canal Work

Pond Construction

Ditching

Land Clearing

1-1/4-3 yd. draglines with 80' boom and matts, 2 yd. backhoe, swamp dozer and other related equipment.

Contact:

Roger Krause 1-414-398-3322
Route 3 Markesan, Wis. 53946

22 years experience  construction lifts 



AERIAL LIFTING

◦ *BERRY LIFTING* ◦

*nylon berry bags
bulk bins*

◦ *MUD LIFTING* ◦

NEW MATS

*lightweight
durable*

**JOE
BRIGHAM
INC**

contact
PETER or CHUCK
508-295-2222

 **BEATON'S
CRANBERRY
GROWERS SERVICE**

WARHAM MASS.

mat rentals & sales



**MIDDLEBOROUGH
TRUST COMPANY**

The *Business Bank.*

MTC offers you business banking built to your needs.
Personal attention to your special
financial requirements now and as you grow. Cooperation.
Flexibility. Complete business and personal banking.
Member FDIC



Main Office

10 John Glass, Jr. Square, Middleborough

Branch Offices

Middleboro Square, Rt. 28, Middleborough • Middleboro Plaza, Middleborough
Cranberry Plaza, East Wareham • Carver Square, Carver • Trucchi's Plaza, Taunton

Telephone all offices **947-1313**

Take Good Care of Yourself Have an Ocean Spray!



The farmer's cooperative that brings you
a wide range of natural fruit juices, drinks and sauces

Ocean Spray Cranberries, Inc., Lakeville-Middleboro, MA 02349

An Equal Opportunity Employer

B
3
7
r

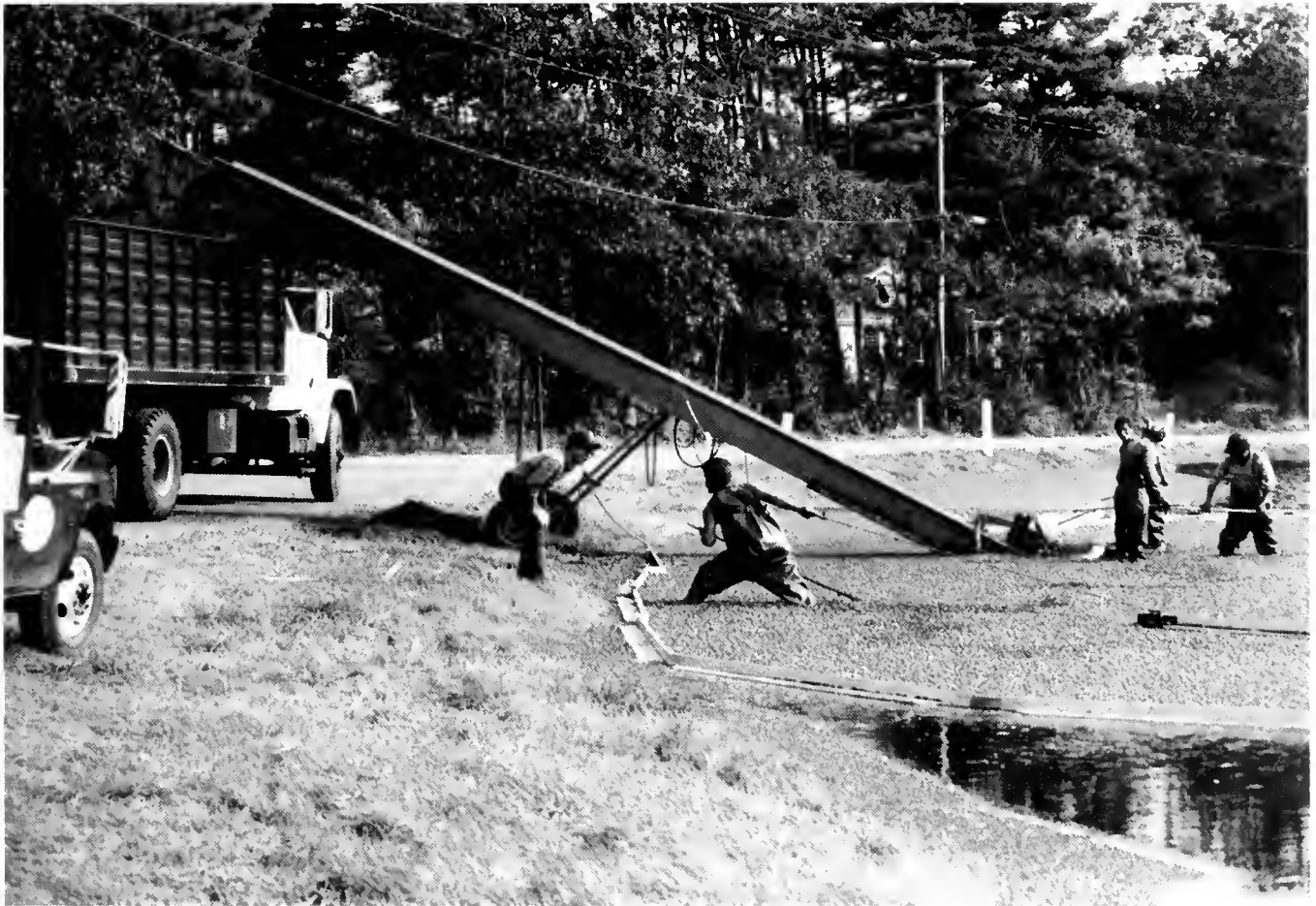
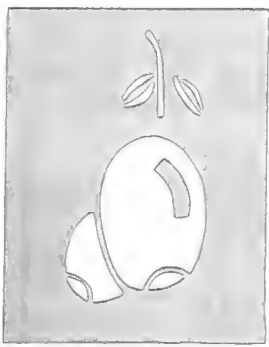

Aminotriazole Scare: A Look Back

WCGA Gets Its 1st

S

Attic Yields Rich Cranberry History

UNIV OF MASS LIBRARY
SERIALS DEPT
AMHERST MA
01003

**WANT YOUR CROP DELIVERY RESULTS FAST?
NOW YOU CAN HAVE **DIRECT** ACCESS TO THE
RECEIVING STATION IN YOUR OWN AREA!**

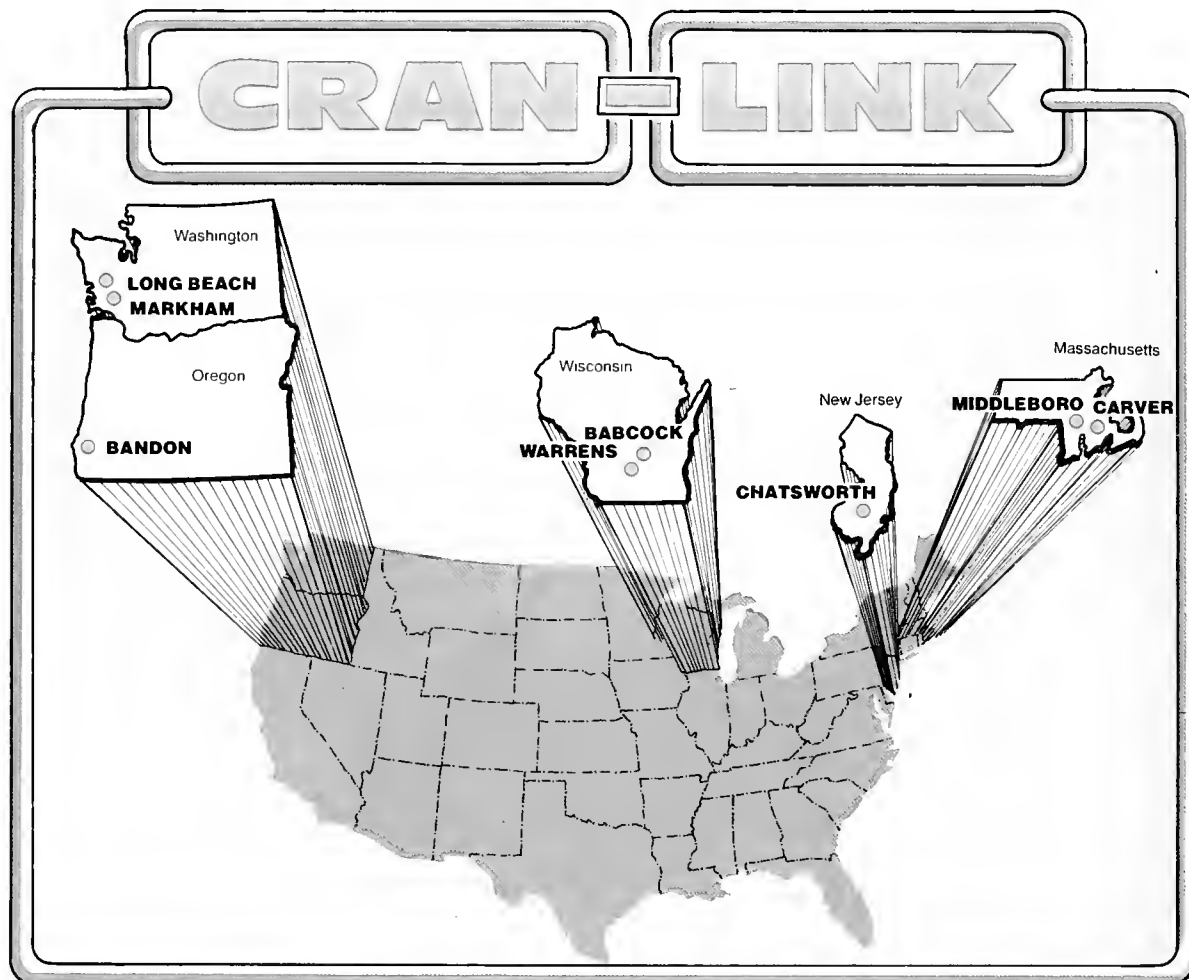

CRAN-LINK

Automatically feeds your delivery information into the Cranberry Growers System, a complete production, chemical and fertilizer tracking system designed exclusively for cranberry growers.

REQUIREMENTS: IBM Micro Computer or 100% compatible • DOS 3.3 • 640 K • Hard Disk
Cranberry Growers System (or CGS Limited Edition)



Call or write:

CRANBERRY COMPUTER, INC.

P.O. Box 1037 • Plymouth, MA 02360 • Telephone (508) 747-3033 • Fax (508) 747-6918

First Executive Director, New Prexy Discuss Cranberrying in Wisconsin

By FRED POSS

The cranberry business is a growth industry in more ways than one. At least, that's the impression you get when you talk to two "new kids on the block"—Tom Lochner, executive president, and Chuck Strozewski, president—at the Wisconsin Cranberry Growers Association (WCGA).

"I think," says Lochner, the WCGA's first full-time director, "that the growers recognize that . . . there is a growing number of issues and that they need to bring somebody on to help coordinate efforts that they were doing through volunteer work."

Lochner, a tall, serious, but very approachable individual, feels his background as former director of governmental relations for the Wisconsin Farm Bureau has helped prepare him for the issues confronting him in his new job.

COVER PHOTO

GEORGIA D. CHAMBERLAIN of Rochester, Mass., took first place in the harvest category for this photo. The contest was sponsored recently by the Cape Cod Cranberry Growers Association.

CRANLAND SERVICES

Cranberry Property Appraisals

★ ★ ★ ★ ★

Listings and Sales of Cranberry Properties.

License # 68987

Lawrence W. Pink
Old Cordwood Path
Duxbury, MA 02332
(617) 934-6076

"A lot of them (issues) have to do with regulation by the state—from regulation of the use of pesticides to attempts to regulate the use of water," he says.

Any recent "hot" topics, Tom?

"There is also the issue of food safety, food quality," he replies. "With the Alar thing, a lot of agricultural people are very concerned about what that can do to you from the financial standpoint."

Besides his awareness of the need for appropriate reaction and adequate preparedness on these issues, Lochner already has very definite ideas about how a new director can take the proactive lead for cranberry growers in the state.

"I think the growers have indicated that through education programs and best management practices and those types of things, that they don't have to create a situation where they are going to be facing a contamination," Lochner remarked.

And the sources for the educational programming he wants to design and implement are already identified, according to Lochner.

"We will be working with the

university on our cranberry school, some things that Ocean Spray has been working on as far as research, and the Cranberry Institute as far as nematodes . . . all those types of things."

Anything else in Lochner's new job description besides responding to issues and creating educational programming probably falls under public relations.

"I think we are going to be doing some work with the legislature," he says. "Basically, what the (WCGA) board did at their last meeting was appoint three committees: an administrative committee to look at the organization, an education and public relations committee which will conduct a lot of those educational activities, and also a governmental relations committee which will work with the legislature on things from property taxes to environmental issues."

AND, as Lochner tackles public relations, issues and educational programming, one important face looking over his shoulder will probably be smiling, broadly.

Chuck Strozewski, new WCGA president, is a happy man now that

*Lampert, Lee
& Associates*

CONSULTING ENGINEERS
SURVEYORS

Extensive experience in all aspects of cranberry land development: evaluation, purchase, survey, design, permit acquisition, phased construction and planting both in wetlands and uplands.

Have references. Will travel.

Contact: Will Lee
10948 Highway 54 East
Wisconsin Rapids, WI 54494
(715) 424-3131

his organization has seen fit to establish the new director's position.

"I've spent so much time traveling to meetings for the association," Strozewski explains, "that just for me alone—my car—my marsh—we certainly can use an executive director."

And Strozewski believes there are some important advantages to all of the state's cranberry growers with the Lochner appointment.

"Issues are better presented as a united front to the DNR or the legislature," he said. "This way we have a contact person rather than an answering machine."

And the new director's background in PCA and the Farm Bureau are only part of the reason Chuck believes Lochner is a good choice. Strozewski puts it succinctly: "He wants more people involved—wives, kids!"

And, apparently, involvement in what you believe in is a big prerequisite for membership in the Strozewski family.

"I'm not the newest guy on the block in the cranberry association," Chuck admits. "I was the vice president for the last two years."

"And I've been elected state president of middle schools," interjects Mrs. Strozewski.

Two ships passing in the night at times around the Strozewski house?

"It takes a lot of understanding," was the reply.

So while schedules, appointments, meetings and more interviews with

writers like this one continue to blossom on the cranberry calendars of the Lochner and Strozewski families, one end point in the Wisconsin story clearly has been reached. The WCGA isn't the mostly social organization it was in its earliest days nor is it a semi-professional one any more with a small group of dedicated volunteers putting in long hours.

The WCGA under the leadership of President Chuck Strozewski and new Executive Director Tom Lochner has taken a quantum leap forward in 1989. And, as members of a totally professional organization now, the new kids on the block should be perfectly positioned to respond both reactively as well as proactively to the business dynamics of the 1990's.



General Excavating

Pond Construction & Maintenance
Land Clearing, Ditching, Canal Work

Dragline (63' reach) & Clamshell
Gradall 6' Bucket *D-8 Dozer*
Road Grader

Bill Conway
228 W. Britannia St.
Taunton, MA 02780
(508) 822-1085

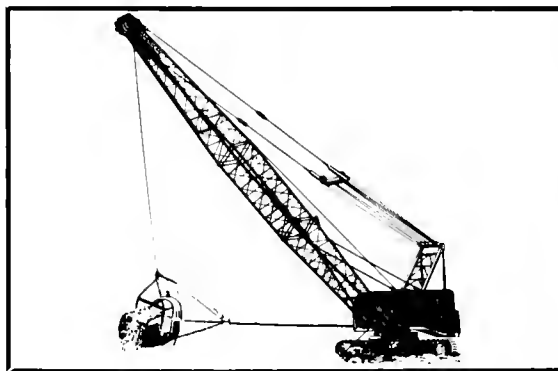

Krause Excavating, Inc.

Canal Work Ditching
Pond Construction Land Clearing

1-1/4—3 yd. draglines with 80' boom and matts, 2 yd. backhoe, swamp dozer and other related equipment.

Contact:

Roger Krause 1-414-398-3322
Route 3 Markesan, Wis. 53946

Pump Repairs & Sales

All Types

- Field Service
- Chemigation Equipment Sold
- Demonstration by Appointment

**AAA Industrial
Pump Service Inc.**

Bruce Sunnerberg
66 Lake Street
Plympton, MA 02367
(617) 585-2394



***For Reliable Dredges and Pumps,
Cranberry Growers Look to Crisafulli***

Your Crisafulli pumping equipment will be manufactured just for you, with your choice of power options and discharge size. If you need to dredge sand, call us for quotations and specifications. We will supply you with exactly what you need, not something designed for somebody else! For information, quotations, local representation, call:

1-800-442-7867

or FAX 406-365-8088

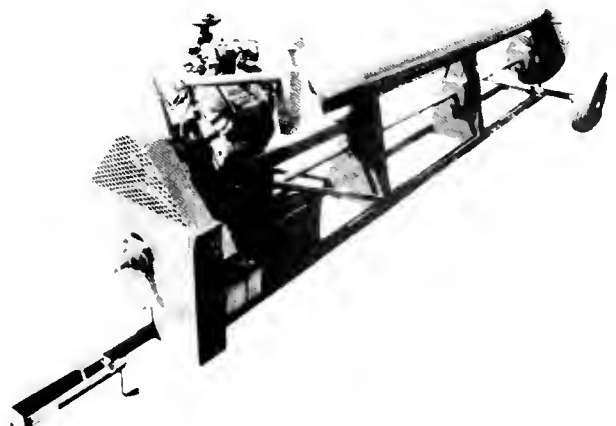
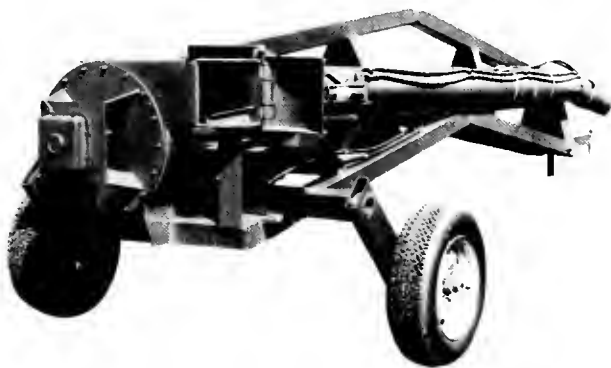

They Also Called It Black & Blue Monday

George C. P. Olsson Reminisces About The Aminotriazole Controversy of 1959

By CAROLYN GILMORE

It was a watershed date; a point in time which marks the course of events by a sharply distinct "before" and an equally dramatic "after." Thirty years ago, on Nov. 9, 1959, with little warning, a press announcement carried on national news virtually destroyed the cranberry market at its peak. For the next few years, consumer confidence in cranberries was at an all-time low.

ON THAT memorable day in '59, U.S. Secretary of Health, Education and Welfare Arthur S. Flemming announced that aminotriazole, used as a herbicide on cranberries in Oregon and Washington, had been found to cause cancer in mice. Since a batch of treated cranberries from the two states had already been distributed in the market and could not be identified for isolation, the entire cranberry market from coast to coast was suspect during the biggest sales week.

George C. P. Olsson, then Ocean

Spray president, vividly recalled the day from his Plymouth home this harvest.

"I was just getting up when I got a telephone call from a manager who was attending a convention in New York," Olsson remembered. "He said he had learned that the Secretary of Health, Education and Welfare, Arthur Flemming, was about to make an announcement that was going to hurt the cranberry business or be very detrimental. He asked if I could get in touch with someone from Washington and see what I could do about it."

Olsson was able to get through to Congressman Hastings Keith and Senator Leverett Saltonstall, both from Massachusetts. He had hoped for a "48 or 24 hour" reprieve to allow the cranberry industry time to present its side of the issue, but Keith and

Saltonstall only managed to hold up the announcement for "an hour or two."

"Arthur Flemming had a full-blown press conference," Olsson recalled. "It got on television and in all the newspapers that we had used a pesticide which was limited for use and we had abused the use. It practically stopped sales all over the country."

THE NEWS meant a sudden career change for Olsson, a lawyer with 32 years experience as administrative officer for Plymouth County, Mass., courts. He resigned his job, and, with Orrin G. Colley, Cranberry Institute president, led growers in convincing President Eisenhower to grant an executive order to pay restitution for the lost crop. Olsson, who owned a 60-acre cranberry bog in Middleboro, was serving his second year as president of Ocean Spray at the time.

"We had meetings of growers in Washington (D.C.) and it was finally agreed that the Cranberry Institute would be reactivated," Olsson said. "Orrin Colley, Marcus M. Urann (Institute secretary and treasurer and nephew of Ocean Spray founder Marcus L. Urann) and I went to Washington from then on . . . that was November and sales had come to a standstill. People were offering cranberries for sale at 10 cans a dol-

CRANBERRIES

THE NATIONAL CRANBERRY MAGAZINE

SEND CORRESPONDENCE TO:

P.O. BOX 249
COBALT CT 06414
(203) 342-4730

Fax #: (203) 342-1977

PUBLISHER & EDITOR: BOB TAYLOR

ASSOCIATE EDITOR: CAROLYN GILMORE
(508) 783-5206

ADVISORS & CORRESPONDENTS

MASSACHUSETTS — Irving E. Demoreenville, Director, Cranberry Experiment Station.

NEW JERSEY — Phillip E. Marucci, Cranberry & Blueberry Specialist, Buddtown; Elizabeth G. Carpenter, Chatsworth.

NOVA SCOTIA — Robert A. Murrey, Horticulturist, Berry Crops, Research Station, Truro.

OREGON — Arthur Poole, Coos County Extension Agent, Coquille.

WASHINGTON — Azmi Y. Shewe, Horticulturist and retired Director, Coastal Washington Research & Extension Unit, Long Beach.

WISCONSIN — Tod. D. Plener, Farm Management Agent, Wood County.

CRANBERRIES is published monthly by Taylor Publishing, 2 Freestone Ave., Portland, CT 06480. Second class postage is paid at the Portland, CT Post Office. Price is \$15 a year, \$28 for two years, \$2 a copy in the U.S., \$17 a year in Canada, \$20 a year in all other countries. Back copies: \$2.50, including postage. Copyright 1989 by Taylor Publishing.

ISSN 0011-0787

Postmaster, send Form 3749 to

CRANBERRIES
P O BOX 249
COBALT, CT 06414

2 Parcels in the Heart of Wisconsin Cranberry Country

- 1,000 acres in Big Flats
- 280 acres in Colburn

Both in Adams County

20 miles south of Wisconsin Rapids, Cranberry Capital of Wisconsin

Details: Big Flats parcel is served by two streams, Dry Creek and Carter Creek. Colburn is served by Dry Creek. The area is comprised mainly of Wisconsin sand land. The land is level, with a high water level. Both properties are serviced by public highways and utilities. About 200 acres of the Big Flat property are former cleared field. There are some drainage ditches on the property. About 50 acres of the Colburn property are open field. Will Lee of Lampert, Lee & Associates, cranberry marsh engineers, is favorably impressed with the potential of the properties for cranberry development.

I will consider cash, a long-term contract or a lease.

Donald L. Hollman
Hollman & Pollex, Attorneys at Law
313 Main Street
Friendship, WI 53934-0098
(608) 339-3341



IN THIS 1960 PHOTO, George C. P. Olsson, center, then Ocean Spray president, presents the late U.S. Senator Leverett Saltonstall (R-Mass.) with a cranberry scoop in appreciation for his efforts to help the cranberry industry after the Great Cranberry Scare in 1959. Next to Senator Saltonstall is Marcus M. Urann, secretary and treasurer of the Cranberry Institute. At the left is Orrin G. Colley, Institute president. Next to him is Massachusetts Congressman Hastings Keith.

lar. There was a glut on the market and we wanted to get them (cranberries) cleared of any suggestion that there was anything wrong with them."

Ocean Spray hired the testing laboratory, Arthur D. Little of Cambridge, Mass., to review and coordinate testing done on cranberries by their own chemists, the National Canners Association and the Food and Drug Administration. In the February 1960 issue of CRANBERIES, it was reported that the Cranberry Institute issued a release that less than 0.3% of berries tested showed any traces of aminotriazole residue.

"I had been chosen spokesman for the group," Olsson said. "I set it up so that it was a political thing. I sent letters and telegrams to all the congressmen in the five cranberry growing states. We would fly down to Washington once or twice a week, set up meetings with congressmen, go from office to office and plead for some help."

Attorney Joseph Parker, who was familiar with obtaining a federal

government indemnity from working with the poultry industry in a similar situation, was hired to represent the cranberry group.

EZRA Taft Benson, Secretary of Agriculture, offered to help.

"What we wanted was not help, but money," Olsson said. "For many growers, their only means of support was from cranberries. At that time, it was \$12 to \$13 a barrel. They could get by on that, but, of course, it looked as if they wouldn't get anything."

Finally, on May 1, 1960, "we got to Eisenhower," Olsson said. "He issued an executive order for indemnity to cranberry growers which averaged \$10 a barrel. At least, it was enough to keep them in business."

For the next few years, sales were poor because consumer confidence was low. Cranberry leaders did, however, manage to get their crop included in

(Please turn the page)

Wanted to Buy

40 Tons of Stevens
Vines for
1990 Planting.

Would Like to See
Vines Now.

Contact: Timothy Finch
Rt. 3
Box 320
Black River Falls
Wisconsin 54615

the school lunch program.

"That was partially successful," Olsson related. "The government said it was not going to pay for sugar in cans of cranberry sauce, so the schools had to take raw cranberries. A lot of schools didn't have facilities and the know-how to cook cranberries."

However, the school lunch program was enough to keep growers in business, as it absorbed a million or more dollars a year of the crop, Olsson said.

"IT was a very interesting experience, frustrating at times," the former Ocean Spray president said. "But to get a million dollars a year was a good result. The sales started to come back . . . We were shocked by the thing. We were hit so hard on our backs. We came back with a lot of new things—labels, new products, juice. Growers were aware juice was a possibility but I don't think the management did."

During Olsson's tenure, the common stock was reorganized so that each member held stock in proportion to berries delivered. At that time, a name change was made from National Cranberry Association to Ocean Spray.

"When I came on, I found the common stocks were owned by growers, independents, brokers," Olsson said. "Under the law, I found it was not right. Coop shares were supposed to be owned by grower members. So we had to contract with growers to have a marketing agreement to sell cranberries. It cost three to four million dollars to buy back shares at \$25 a share, which was the par value. It was a big job. Stocks were all over the country. We had many takeover offers but growers wouldn't agree."

Olsson was also involved in the referendum to establish a Cranberry Marketing Order under the 1937 Agricultural Marketing Agreement Act. The order was approved by an 85 percent favorable grower vote in 1962. Olsson was a charter member and the first chairman, serving 12 years on the committee.

The Cranberry Marketing Order originally served the industry as a tool to administrate surplus fruit.

"That was a tough job," Olsson said, "because the independents were very much opposed. Anything we did was wrong."

Olsson sold his bog in 1979 when he retired from Ocean Spray. His two grown sons had chosen careers in locations away from cranberry country.

ASKED what history has taught the cranberry industry, he is reminded of a statue of a horse and rider in Washington, D.C., with the inscription, "The past is prologue," or, as a

taxi driver is said to have translated the inscription for a questioning tourist, "You've not seen anything yet."

"Those who don't learn from history live to regret it," Olsson added.

WISCONSIN CRANBERRY HEADQUARTERS FOR SEVIN XLR



DEVIRINOL 10G * EVITAL * GUTHION
DIAZINON 14G * PARATHION * ETHREL

Cole/Grower Service

537 Atlas Ave., P.O. Box 7211, Madison, WI 53707
(608) 221-6204 or 1-800-362-8049



We Still Make House Calls

Like your old family doctor, your Farm Credit representative still makes house calls . . . and he's been treating farm families like yours for a good 70 years.

Farm families count on him to provide the financial support they need—short-term and long-term credit—that helps them plan for a productive future.

But there's more to Farm Credit than money. What makes your Farm Credit representative unique is that he knows your business so well. Which means that he's more than a dependable source of credit. He can provide farm business consulting, tax services, credit life insurance, appraisal service and computerized record-keeping.

Give him a call. He could be just what the doctor ordered for you.



Southern New England Farm Credit Service

Federal Land Bank Association
Production Credit Association
P.O. Box 7
Taunton, MA 02780
508 / 824-7578

editorial



“The Great Injustice”

(Reprinted from the January 1960 issue
of CRANBERRIES.)

The cranberry industry is desperately in need of the help of everyone interested. We have been done a great injustice through the statement of Welfare Secretary Flemming and the subsequent adverse flood of publicity, which all but destroyed the market for cranberries. Legislation is being introduced in Congress for Federal aid.

Among the reasons why cranberry people deserve the reimbursement are:

1. Secretary Flemming's pronouncement of November 9 came without notice to the industry or even a hearing, just as the major part of the crop was about to go on to the market.

2. This government action actually destroyed the cranberry market, probably for some years to come.

3. Such governmental conduct is completely without precedent in America.

4. This conduct resulted in economic disaster to thousands of innocent people.

5. There was no sudden threat to public health. The compound, aminotriazole, was found in minute quantities in a few cranberries. It is found naturally without spraying in many of our common foods. Some of these foods are radishes, rutabagas, broccoli, turnips, mustard, cabbage, etc. We understand that a person would have to eat 2,200 lbs. of heavily sprayed cranberries to consume as much aminotriazole as is found in one turnip.

6. A good authority is quoted as saying that what was called “cancer” in the now famous test rats was in fact not cancer tissue . . .

* * * * *

(Reprinted from the February 1960 issue
of CRANBERRIES.)

It is perhaps not in good taste to mention only a few names, as many are working hard for the industry in its time of need. But certain ones are carrying the brunt of the burden.

To name only three: (Cranberry) Institute President Orrin G. Colley, secretary-treasurer Marcus M. Urann and George C. P. Olsson, president of Ocean Spray Cranberries, Inc. and designated spokesman for the industry, are spending unlimited time in Washington, quietly at work on the problem of redress. They are usually there from Monday to Friday of each week.

Westvaco Announces Customer Seminars

Westvaco Corp., a Fortune 200 company that manufactures paper, packaging and chemicals, is offering customers and key prospects three-day corrugated packaging seminars at its Container Division Technical Center in Richmond, Va.

For information, write to Ross Zachary, Marketing and Sales Manager, Westvaco, Container Division, P.O. Box 2941105, N. Charleston, SC 29411-2905, or call 1-800-526-8778.

BALLY NAMES REP

Bally Engineered Structures Inc. of Bally, Pa., manufacturer of walk-in coolers, freezers and refrigerated warehouses, has named Forbes, Hever & Wallace of Houston as its manufacturer's rep in Texas and Oklahoma.

FOR SALE

**Cranberry bog, 10 acres
HANSON, MASS.**

Good producer, good
water, no neighbor
problem—ever.

Ocean Spray member
With upland, total 15
acres approximately.

Moved out of state, priced
to sell

\$24,000 per acre, total
\$240,000

(207) 255-8769

Ask for Brooks

CRANBERRY GROWERS REALTY

*Listings of buyers and
sellers welcomed on
cranberry acreage
and upland.*

Appraisals

DOUGLAS R. BEATON
E. Sandwich, Mass
02537
(617) 888-1288

Spring 1990



Vines For Sale

Ben Lear	\$3,700.00 per ton
Crowley	\$3,500.00 per ton
Stevens	\$3,500.00 per ton
Pilgrims	\$5,000.00 per ton
LeMunyon	\$5,000.00 per ton

Buy 10 tons, get one ton free.

Prices F.O.B.

Contact:

20% down payment with order.

LeRoy Miles
Northland Cranberries, Inc.
(715) 424-4444
251 Oak Street
Wisconsin Rapids, WI 54494

Call for large order pricing.



Irrigation Equipment Designed Especially for the Cranberry Industry

- Gorman-Rupp Self Priming Electric Sprinkler Pumps
- Proven Quick Couple Riser
- Polyethylene Main Lines, 3" - 12"
- Butt Fusion Equipment Available
- Paco/Wemco Water Harvest Pump
- Berkeley Self-Priming and Centrifugal Pumps

A Most Complete Inventory of Irrigation Accessories

LARCHMONT
IRRIGATION / SNOWMAKING

P.O. Box 66, 11 Larchmont Lane
Lexington, Massachusetts 02173 (508) 862-2550

Contact

Larchmont Engineering
Phil Tropeano, President
(508) 862-2550
(Call Collect)

Stearns Irrigation, Inc.
790 Federal Furnace Rd.
Plymouth, MA 02360
(508) 746-6048

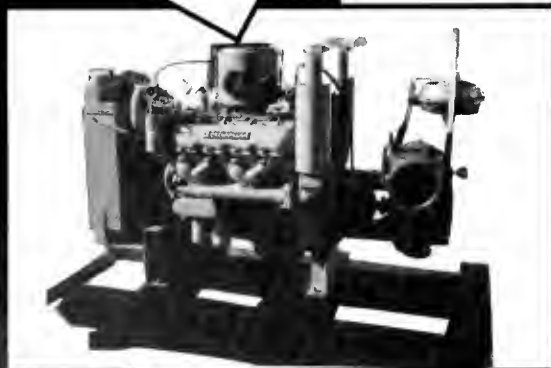



UPRIGHTS like the one to the left make the bumper cranberry crops and there could be more of them at harvest time but for the insects . . .

Know the Insects

The major cranberry insects: cranberry girdler, the fireworms, tipworm, blossom worm, cranberry fruitworm and Sparganothis fruitworm.

The periodic cranberry insects: cranberry scale, fire beetle, blossom weevil, armyworm and bluntnose leafhopper.

Color photographs of all these insects and more are now arranged with text in a portfolio that is available.

The portfolio endeavors to bring together the words of research complementing the photographs and making a summary of cranberry insect information that will be of use to the cranberry grower for a lifetime.

The portfolio is available for \$100 and, if you wish to examine a copy, telephone (609) 894-8556 evenings around 6 p.m. or write to:

**Walter Z. Fort
P.O. Box 183
Pemberton, NJ 08068**



THE BEST — IN EVERY RESPECT

CRANBERRY Model 400 GT

Precision Chemigation System



- Developed *Exclusively* for the Cranberry Industry
- Exceeds or Meets ALL Current EPA Requirements
- Simple to Operate and Easy to Calibrate
 - Self-Timer Application (1 minute increments)
 - Easy Access Handle & Simple Reference Scale
 - Precise Visual Flow Calibration
- Outstanding Field Performance
 - Down-Line Venturi Injection System
 - High Capacity 0-7 GPM Injection Rate
 - Large Volume 175 Gallon Mix Tank
 - 12 Volt Gear Reduction Mixer
- Designed for Trouble-Free Operation
 - Reliable 11 HP Honda Electric Start Engine
 - Critical Components Are Stainless Steel & Polypropylene
- Completely Self-Contained and DOT Approved Transportable
- Personalized, Experienced Support Service as Close as Your Phone

CHEMIGATION SYSTEMS INTERNATIONAL, INC.

Corporate Offices: P.O. Box 247
 (608) 297-2041

Montello, WI 53949
 FAX: (608) 297-7248

Call us today for the dealer nearest you, or contact:

Skip Tenpas
 Central Sands Irr. & Bldg., Inc.
 Hwy 51 & 73 Interchange
 Plainfield, WI 54966
 (715) 335-6372

Bruce Sunnerberg
 AAA Industrial Pump & Ser., Inc.
 66 Lake Street
 Plympton, MA 02367
 (617) 585-2394

NOTICE

Selected exclusive
 dealer territories
 still available —
 inquiries invited

Decran Ag Supplies Inc.

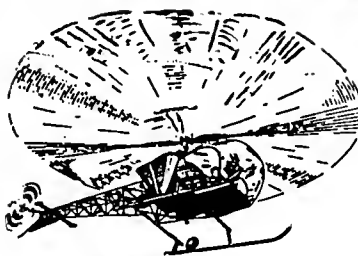

- ★ Complete line of cranberry herbicides, fertilizers, insecticides, fungicides, miticides. In stock when you want them.
- ★ Best application and safety equipment for your needs.
- ★ Quality aerial applications.
- ★ Proven frost warning equipment. Don't take chances — buy the best.
- ★ Experienced cranberry consulting service offering pheromone traps and baits.
- ★ Right to know training.
- ★ Culvert Pipe — All sizes — steel, aluminum, and poly.
- ★ Ditch Mud Mats — Strong — lightweight — durable.
- ★ Burlap Picking Bags — Best for your money.
- ★ Sanding by helicopter.

John C. Decas

William D. Chamberlain

461 Mary's Pond Rd.
Rochester, MA 02770

Office: 295-2731
Evening: 763-8956
Fax: (508) 291-1417

Serving Massachusetts Cranberry Growers

Office
295-2222

BEATON'S CRANBERRY GROWERS SERVICE

K. Beaton
295-2207

D. Beaton
888-1288



Specializing in

P. Beaton
947-3601

● COMPLETE BOG
MANAGEMENT

● NETTING

● DITCHING

● HARVESTING
(Wet & Dry)

● SANDING

● CUSTOM
HERBICIDE
APPLICATION

Complete line of portable Crisafulli Pumps 2" - 16"
Plastic netting for suction boxes



Research Center Attic Yields Historic Treasures

By ELIZABETH CARPENTER

Last year Dr. Erwin "Duke" Elsner had no idea what he would discover as he climbed the ladder to the storage area above Rutgers' blueberry/cranberry research center garage. Soon renovations were to begin that would transform this cinderblock cavern into a laboratory and conference room. A major housecleaning could no longer be avoided. However, what began as a chore turned into an entomologist's delight and a librarian's windfall.

THE dusty corners of the attic crawl space yielded old American Cranberry Growers' Association (ACGA) ledgers filled with entries dating back to the turn of the century, an insect collection containing some amazingly well preserved specimens, notices of annual growers' meetings, and an ode, "To the Cranberry," which is printed below. In an Aug. 12, 1925 notice to New Jersey growers, Charles S. Beckwith wrote:

The fifty-sixth annual convention of the American Cranberry Growers' Association will be held at the bog of Mr. Theodore Budd, near Pemberton, N.J., at 10 A.M. (DST) August 26, 1925. The program at the bog will consist of a demonstration of airplane dusting of cranberry bogs and a demonstration of the cranberry picking machine. At one o'clock, luncheon will be served at Parish Hall, Pemberton, at \$1.50 per plate. Later the formal meeting will take place. The annual crop estimate, a talk on airplane dusting and one on the cranberry picker will be given.

Mr. W.B. Mathewson of Quincy Adams, Mass., was scheduled to demonstrate the picking machine while Curtiss Flying Service Inc. planned to furnish the crop dusting plane. The meeting notice was sent from Browns' Mills, N.J., then the home of the cranberry research facility.

Records show that 19 years earlier, A.J. Rider, founder of Rider College in Lawrenceville, N.J., and former ACGA secretary, noted at the conclusion of his Oct. 29, 1906 secretary's report: "The country is in a prosperous condition and all kinds of produce are bringing good prices. Cranberries are not likely to be an exception."

Duke Elsner, now unofficial historian for the research center, knew these

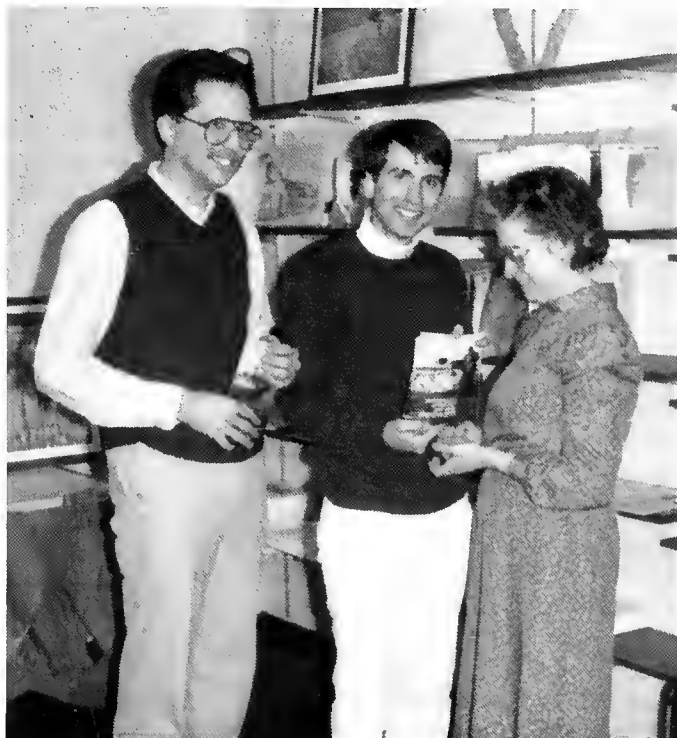

JUDITH Olsen, Burlington County College librarian, looks at a cranberry growing brochure given her by Kenneth Samoil, program associate working with Dr. Erwin "Duke" Elsner, research center entomologist, and Dr. Elsner. The college welcomes additions to its special Pinelands collection.

(CRANBERRIES photo by Elizabeth G. Carpenter)

J.A. JENKINS & SON CO.

Grower Service

MOWING (ALL TYPES)
SANDING

DITCHING
WEED WIPING

Serving Cape Cod

227 Pine St., W. Barnstable, Ma. 02668

Phone 362-6018



records, as well as multiple back issues of cranberry journals, were valuable components of Pinelands cranberry history. They should be shared with the public and deserved a haven, he thought.

After receiving permission from ACGA leadership, the research center donated a selection of this historical material to the special Pinelands Collection of Burlington County College located in Pemberton Township, the home of four "cultivators of cranberries" in 1860.¹ Here Judith Olsen, special services librarian, historian and lifelong Pinelands resident, will oversee cataloguing and care of these treasures.

On behalf of the college, Olsen welcomes donations of Pinelands-related artifacts, audio-visual aids and printed materials. Since its dedication on Nov. 7, 1987, many students and researchers have visited the collection in their effort to learn more about our country's first national preserve, the New Jersey Pinelands. Cranberry and blueberry agriculture is an important part of the preserve.

¹Olsen, Judith Lamb and Malsburt, Glenn. *Pemberton—An Historic Look at a Village on the Rencoces*. New Orleans: Polyanthos, 1976.

Marketing Order Hearings Slated

David Farrimond, general manager of the Cranberry Marketing Committee, announces that hearings on the proposed amendments to the Cranberry Marketing Order are scheduled for January and February.

A USDA administrative law judge has been assigned as hearing officer.

Hearings will be held in four growing areas on the following dates:

Plymouth, Mass., Jan 17 and 18; Medford, N.J., Feb. 6; Wisconsin Rapids, Wisc., Feb. 13; Portland, Ore., Feb. 15.

The Cranberry Marketing Committee newsletter, which will contain proposed changes in the marketing order, will be sent to the 945 active cranberry growers in the U.S., Farrimond said.

C.G.

CONSULTAMERICA MARKETS EUROPEAN FOOD & DRINK DATA

ConsultAmerica, an international business consulting firm with offices in Maynard, Mass., has produced a three volume, database report on food and drink products for all 12 European Community countries.

To The Cranberry

Let others praise in fervent lays
The plump Thanksgiving bird,
And let them sing of leg and wing,
With old Pegasus spurred
Until his speed is great indeed
And all is blithe and merry,
But let me sing that splendid thing,
The succulent cranberry.

O humble fruit, we've long been mute
Upon thy many charms!
With nipping zest you do your best
To ward dyspepsia's harms.
Both sour and sweet you sauce the meat
Your flavor does not vary.
Retiring, coy, yet full of joy —
O marvelous cranberry!

About you hangs a taste that tangs
The food that would be harsh,
Your plump skin's filled with dew, distilled
Above the sun kissed marsh.
No grape, I'll say, of old Tokay
Or from Oporto airy
Drips with a wine as rich as thine.
O excellent cranberry!

Of ruby hue, a jewel, too,
To grace the festal board.
With lavish heart you give your part —
Give all your spicy hoard.
When eager lipped we've sat and sipped
The juice, that vies with sherry.
Ah, of the feast you're not the least.
Mellifluous cranberry!

So let them praise in lilting lays
The turkey and the pie,
But let me sing that splendid thing
That makes the heart beat high.
I would not waste one shade of taste.
I'd drain the dictionary
To find more ways to sing the praise
Of thee, O rare cranberry!

The clipping of this poem was found in an American Cranberry Growers' Association ledger dating back to 1909. It was with other clippings, one of which was dated "Phila 4/7/10 Record."

REGIONAL NOTES

MASSACHUSETTS

By IRVING E. DEMORANVILLE

The official crop estimate released by the New England Agricultural Statistics indicates that the Massachusetts crop will be 1,820,000 bbls., 2 percent less than the 1988 record. Other figures: New Jersey, 340,000 bbls., 8 percent less than the 1988 record; Oregon, 155,000 bbls., 1 percent more than the 1988 record; Washington, 140,000 bbls., 4 percent more than 1988, and Wisconsin, 1,470,000 bbls., down 6 percent from 1988.

Nationally, the crop is estimated at 3,930,000 bbls., down 4 percent from 1988. Interestingly, the Cranberry Marketing Committee indicated that they are estimating the Massachusetts crop at 1,904,000 bbls., which would be a record. I lean toward the larger figure at this time.

.....

Dr. Robert Devlin of the Massachusetts Cranberry Experiment Station attended the Plant Growth Regulator Society of America annual meeting in Arlington, Va., from Aug. 5-10. Bob presented a paper at the meeting.

Dr. Frank Caruso attended the

American Phytopathological Society annual meeting in Richmond, Va., Aug. 19-24. Frank presented a paper and was chairman of a paper session.

* * * * *

The 102nd annual meeting of the Cape Cod Cranberry Growers Association was held at the Cranberry Experiment Station on Aug. 22. The morning was filled with a multitude of exhibits, the usual bog tour of research plots and the barbeque lunch. The afternoon was devoted to the business meeting, guest speaker and official USDA

crop estimate.

Officers and directors elected for the coming year were: Jeff Kapell, president; Dave McCarthy, first vice president; Bob Zaniboni, second vice president, and this writer, secretary/treasurer. Wayne Barnes and Kirby Gilmore are two new members of the board. They'll replace Dave Mann and Ben Gilmore, who were given a plaque for their service, as was outgoing president Doug Beaton. We will miss the directors' advice and expertise in many areas, especially water problems and real estate taxes. We hope to see them often.

HYDRAULICS

- ★ Industrial Hydraulic Hose Assemblies & Fittings
- ★ Large Inventory of Hydraulic Filters
- ★ Engineering service for your special problems

- ★ O-Rings
- ★ Cylinder Repair & Rebuilding
- ★ Pumps, Motors, Valves

FREE ESTIMATES

WARD

HYDRAULICS, INC.



103 Middleboro Rd., E. Freetown, MA 02717

(508) 763-5567

SALES • SERVICE • ENGINEERING



MIDDLEBOROUGH TRUST COMPANY

The Business Bank.

MTC offers you business banking built to your needs.

Personal attention to your special

financial requirements now and as you grow. Cooperation.

Flexibility. Complete business and personal banking.

Member FDIC



Main Office

10 John Glass, Jr. Square, Middleborough

Branch Offices

Middleboro Square, Rt. 28, Middleborough • Middleboro Plaza, Middleborough
Cranberry Plaza, East Wareham • Carver Square, Carver • Trucchi's Plaza, Taunton

Telephone all offices 947-1313

WISCONSIN

Kay A. Finch, Black River Falls, John R. Rezn, Warrens, and Guy A. Gottschalk, Wisconsin Rapids, recently were elected to three year terms on the Wisconsin Cranberry Marketing Board.

"I think that is alarming."

Those were the words of Dr. Dean Stueland of the National Farm Medicine Center in Marshfield, which conducted a two year study of farm injuries in central Wisconsin. The study found that nearly 20 percent of victims were younger than 16.

Weather MASSACHUSETTS

August was warm and wet. We averaged 1.5 degrees a day above normal. Maximum temperature was 85 degrees on the 22nd and the minimum was 46 degrees on the 27th. There were no exceptionally warm or cool days, but nights averaged considerably warmer than normal.

Rainfall was 5.99 inches or about 1 3/4 inches above normal. There was measurable rain on 10 days with 2.19 inches on the 11th and 12th as the greatest storm. This was the 11th wettest in our records. We are 3 1/2 inches above normal for 1989 and about 5 1/2 inches ahead of 1988.

The summer (June-August) was about 4 1/4 inches wetter than normal.

I.E.D.

American Cyanamid Dedicates New Aggle Research Facility

American Cyanamid dedicated its new, 123,000 square foot, "state-of-the-art" agricultural research and development labora-

tory Sept. 15 in Princeton, N.J.

The two story facility houses 177 people, mostly scientists.

American Cyanamid employs over 35,000 people in 135 countries.

R.D. GRASSI Cranberry SERVICES

Herbicides
Applied

Custom Pruning
Custom Ditching

Sanding
Wiping
Wet Harvesting
Mowing

(Mowing includes
Hydraulic Arm
Flail Mower.)

West Wareham,
Massachusetts

Ask for Rick at
295-5158

22 years experience construction lifts

AERIAL LIFTING

◦ BERRY LIFTING ◦

nylon berry bags
bulk bins

◦ MUD LIFTING ◦

NEW MATS

lightweight
durable

contact

PETER or CHUCK
508-295-2222

BEATON'S
CRANBERRY
GROWERS SERVICE

WARHAM MASS.

mat rentals & sales

Cranberrying to Get Underway in Maine Next Year

The commercial cultivation of cranberries on a big scale—a dream of some of those who attended a state sponsored forum on cranberrying in Augusta, Me., in the summer of 1988—decidedly isn't right around the corner.

However, a small start on cranberry growing will begin in the spring of 1990.

Slated for planting are a 4 acre bed in Trenton and another 5 acre site in Jonesboro.

Both bogs will be located in nonwetland, upland areas, adjacent to water. Maine is highly protective of its wetlands and won't approve bogs located in them.

The source of information about these latest developments was Brooks Holmes, who is a consultant for the Trenton project.

HOLMES, who is selling his bog in Hanson, Mass., has moved to Machias, Me.,

where he owns a pub/restaurant and conducts an irrigation and consulting business for growers.

Holmes owns that progress in introducing cranberrying to Maine "was slower than we thought." But he believes there will

be a steady, albeit slow development, of small sites.

"Large sites would put you into bone gravel and get into the wetlands," Holmes says.

Holmes, an Ocean Spray grower, says

Irrigation Supplies

- 2" to 12" PVC Pipe with Fittings
- Quik Couple Risers
- Felker Aluminum Flumes & Culverts

Replace old aluminum mains with government approved 4", 6" and 8" polyethylene pipe buried just below bog surface. No insert fittings. Rent our butt fusion welder for a continuous main line. Beat the high cost of custom installation by renting our small 4-wheel drive tractor with mole hole plow for buried laterals.

STEARNS IRRIGATION, INC.
790 Federal Furnace Rd.
Plymouth MA 02360
Tel. (508) 746-6048

Cranberry Harvesting Equipment

Warrens Equipment & Manufacturing Co., Inc.

Growing cranberries is something you as a grower do best. Manufacturing of harvesting equipment, air flow, radar controlled fertilizer spreading equipment, and flow gates or flumes is something we do that can be of service to you.



NEWS FLASHES

Standard WEM Bog-Trac Tractors & Beaters Available For Immediate Shipment

- Beater reels available, your choice of designs
- You as a grower tell us what is best for your bog
- Change your reel rpm from bog to bog or variety to variety
- Engine horsepower available from 18 h.p. to 48 h.p.
- Safety parking brake
- Ground speed and reel speed indicator
- Lighter weight

Be sure to check this new model harvester before you make a purchase for 1989.

WEM Factory serving Wisconsin, West Coast, British Columbia
111 Grant St.
Warrens, WI 54666
Tel. (608) 378-4794
(608) 378-4137

WEM East Coast
Stearns Irrigation, Inc.
790 Federal Furnace Rd.
Plymouth, MA 02360
Tel. (508) 746-6048

slow, steady development in Maine is inevitable, what with a growth in the need for cranberries and the comparative lack of room for expansion in Massachusetts.

He believes development is more likely in coastal than in central Maine because of warmer winters along the coast and because blueberry processors are located there. The state of Maine had been thinking of inland development as a means of relieving unemployment in the region.

Holmes says the state Department of Agriculture, the Eastern Maine Development Corporation, the universities of Maine and Massachusetts and the Blueberry Experiment Station in Jonesport, Me., all have been helpful in getting development underway.

Pest Control Front National Study Foreshadows a Shift Away From Chemicals

A recent report by the National Academy of Sciences saying that crop yields on farms using natural methods and little or no chemical application are as great or greater than on farms relying heavily on chemicals is expected to have an impact on agricultural practices and federal farm policy, according to experts.

The report is based on a study paid for in part by the U.S. Department of Agriculture.

"Well-managed alternative farms use less synthetic chemical fertilizers, pesticides and antibiotics without necessarily decreasing, and, in some cases, increasing per-acre crop yields and the productivity of livestock systems," said the report, titled "Alternative Agriculture."

"Wider adoption of proven alternative systems would result in ever greater economic benefits to farmers and environmental gains for the nation," the report added.

The report's authors suggested changing federal subsidy programs that encourage the use of chemicals. They also said the USDA should hike spending for research on natural farm methods from \$4.45 million to \$40 million in 1990.

Not everyone greeted the report warmly.

Thomas E. Wadlinger, a spokesman for the Fertilizer Institute, said: "The farms that the academy selected to study were already determined to be successful in deploying alternative

Vines For Sale

Ben Lear \$5,000 a ton
Stevens \$4,000 a ton
Crowley \$4,000 a ton
Bergman \$4,000 a ton

Prices are F.O.B.

\$500 a ton less with 50% payment before cutting

Richberry Farms Ltd.

11280 Mellis Drive
 Richmond, B.C.
 V6X 1L7 Canada

Res. (604) 273-4505
 Bus. (604) 273-0777

CAPEWAY BEARING & MACHINE, INC.

BEARING & DRIVELINE SPECIALISTS

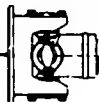

— MACHINE SHOP SERVICE —
 508 - 747-2800

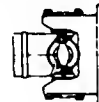

BEARINGS

BOAT & TRAILER
 BOWER - BCA
 C/R DISTRIBUTOR
 FAG
 FLANGE UNITS
 INDUSTRIAL
 KOYO DISTRIBUTOR
 MARINE CUTLAS
 PILLOW BLOCKS
 SKF
 TIMKEN
 TORRINGTON

BELTS

DAYCO

DRIVELINE COMPONENTS

BORG-WARNER
 C/V SHAFTS
 DETROIT
 FRONT WHEEL DRIVE AXLES
 HANGER BEARINGS
 MOTOR MASTER UNIVERSAL JOINTS
 NEAPCO DISTRIBUTOR
 PTO'S
 PTO COMPONENTS
 ROCKWELL
 SPIGIER CLUTCHES
 SPICER-DANA
 UNIVERSAL JOINTS FOR ALL CARS
 TRUCKS AND HEAVY EQUIPMENT

FILTERS

BALDWIN DISTRIBUTOR

HYDRAULICS

COMMERCIAL PUMPS & COMPONENTS
 GRESEN
 HYDRAULIC HOSE

LUBRICATION

ALEMITE SUPPLIES
 KENDALL
 FEL-PRO

SEALS

C/R DISTRIBUTOR
 NATIONAL
 NATIONAL O-RINGS
 STEMCO

TRANSMISSION & REAR END

EATON
 FULLER
 ROCKWELL
 SPICER
 TRANSMISSION & REAR AXLE
 REBUILDING KITS

POWER TRANSMISSION COMPONENTS

DAYCO COMPONENTS
 CHAIN
 MECHANICAL CLUTCHES
 PULLEYS
 RIGHT ANGLE DRIVES
 SPROCKETS

AP

HEAVY DUTY TRUCK EXHAUST

SUPPLEMENTARY PRODUCTS

BRONZE BUSHINGS • GASKET PAPER • HARDWARE • HELICOIL
 LOCKING HUBS • LOCITE • MORSE CABLES • POLLACK ALARMS

— MAJOR SUPPLIER AND MEMBER —

CAPE COD CRANBERRY GROWERS ASSOCIATION • CAPE COD TURF MANAGERS ASSOCIATION
 MASSACHUSETTS LOBSTERMENS ASSOCIATION

100 CAMELOT DR., PLYMOUTH, MASS. 02360

agriculture practices. It's like saying they're not going to pay attention to those who have tried it and failed. Whenever questions are raised about productivity and yield, they say that's no problem, but there is no proof for that conclusion."

chilled Spiced Fruits will deliciously complement your turkey duet.

And to begin your Thanksgiving feast, Cranberry Soubise Soup is the perfect choice. A delicately creamy puree of fresh cranberries and onions, this elegant soup, served either hot or

cold, will subtly enhance the taste buds for the gustier flavors to come.

Whether your decorative plans call for a formal dining room setting—or a gracious buffet—your twin turkeys, generously garnished with fruits and greens, on either one or two platters,



Cranberries Flavor Twin Turkeys For a Doubly Tantalizing Thanksgiving Feast

Oh glorious Thanksgiving! All the beautiful bounty harvested from our land surely makes this holiday the most treasured and nostalgic of our American heritage. It is hardly an exaggeration to say that almost all Americans deem it their inalienable right to have turkey, dressing and cranberries on this day. And so we shall—but in new and delicious versions.

Rather than follow the tradition of serving one giant bird, why not try a new approach? Serve two small turkeys. Your twin turkeys will be easier to store, handle, season—and, happily, will roast in less time. But even more exciting, they can be prepared in a duo of delectable tastes made possible by the versatility of our very own native cranberry.

After seasoning and stuffing, roast your birds as usual. But just 30 minutes before the birds are done, anoint each with two very different cranberry glazes. Both are simply mixed and ready to use ahead of time.

Glaze your first "twin" with a savory Cranberry-Maple Sauce. This bird, dressed with a Fruited Fresh Cranberry Stuffing, will have tremendous appeal for those whose palates crave a succulently sweet flavor. For your second turkey taste-sensation, use Cranberry Soy Sauce for glazing. This "twin," appropriately stuffed with a spicy Cranberry Bacon dressing, will be relished for its piquancy. A bowl of

SKIPPAR

POLE  SERVICE

- Private Poles • Line Construction
- Sonotube Drilling • New & Used Poles

(508) 690-2238

208 Franklin St., East Bridgewater, MA 02333

WOLLSCHLAGER EXCAVATING

Dragline Work — All Kinds

Also Have Clam & Scalping Buckets

Route 1 Necedah, WI 54646

1-800-565-2436

WANTED

Gravel & Sand

in the southeastern Massachusetts area

Quantities of 10,000 yards and up

Complete site work, bog construction and finished contouring of surrounding area plus the best price for your material.

Michael Coan
(508) 866-5285

Earl White
(508) 359-7291

Distributors of:



TERRA-SORB™

**"Cut Your Watering
In Half"**

will afford a colorfully new and enchanting look to your Thanksgiving table.

CRANBERRY TWIN TURKEYS

Make the two stuffings and the two sauces for glazing as directed. Stuff each turkey with a different stuffing just before placing them into the oven. Sprinkle turkeys inside and out with salt and pepper. Stuff turkeys and sew or skewer opening. Place turkeys on a rack side by side in a shallow roasting pan. If turkeys become too brown, cover with foil tents. Roast turkey at 350°F. as usual. Thirty minutes before turkeys are ready, spoon over half of each of the glazes. Remove from oven and place turkeys on a large platter. Spoon remaining glazes over turkeys again, garnish with parsley sprigs and green grapes.

CRANBERRY-MAPLE GLAZE SAUCE

(Enough glaze for 10 pound turkey)

- 1/2 cup melted butter or margarine
- 1 teaspoon maple flavoring
- 1 tablespoon cornstarch
- 1 cup cranberry juice cocktail

In a saucepan, mix butter, maple flavoring and cornstarch. Gradually stir in cranberry juice cocktail. Stir over low heat until sauce bubbles and thickens.

CRANBERRY FRUITED STUFFING

(Enough stuffing for 10 pound turkey)

- 1/2 cup butter or margarine
- 2 large onions, chopped
- 1 can (11 ounces) mandarin oranges, undrained
- 1/2 teaspoon nutmeg
- 1 loaf (1 pound) bread, cut into cubes
- 2 cups fresh cranberries
- 1 teaspoon salt
- 2 teaspoons poultry seasoning
- 1/4 teaspoon black pepper

In a large skillet, melt butter and saute onions until golden. Stir in remaining ingredients. Mix well and use mixture to stuff turkey. If any stuffing is left over, it may be baked in a greased casserole for 1 hour.

CRANBERRY SOY GLAZE SAUCE

(Enough glaze for 10 pound turkey)

- 1 can (1 pound) jellied cranberry sauce
- 1/4 cup soy sauce
- 1 teaspoon garlic powder
- 1/4 cup sherry

Press cranberry sauce through a sieve and stir in remaining ingredients.

CRANBERRY BACON STUFFING

(Enough stuffing for 10 pound turkey)

- 1/2 pound bacon, diced
- 2 cups chopped celery
- 2 cups shredded carrots
- 4 cups bread cubes
- 1 cup cranberry juice cocktail
- 1 teaspoon salt
- 1 cup chopped parsley

In a large saucepan, fry bacon until crisp. Saute celery and carrots in bacon drippings until wilted. Stir in remaining ingredients. Use mixture to stuff turkey.

SPICED FRUITS

(Serves 6 to 8)

- 2 cups fresh cranberries
- 1/2 cup sugar
- 1/2 cup water
- Juice of 1 orange
- 2 cups stemmed, seedless green grapes
- 1 pear, cored and diced
- 2 cups diced canned peaches
- 2 cinnamon sticks
- 8 whole cloves

In a large saucepan, mix cranberries, sugar, water and orange juice. Bring to a boil, lower heat and then simmer 5 to 6 minutes or until cranberries are tender. Stir in remaining ingredients and let stand until cool. Chill until ready to serve. When ready to serve, remove whole spices. Recipe can be doubled to feed a larger group.

CRANBERRY SOUBISE SOUP

(Serves 6 to 8)

- 1/2 cup butter or margarine
- 6 large onions, chopped
- 2 cups fresh cranberries
- 1 pint half-and-half
- 2 cups milk
- Salt and pepper

In a large saucepan, heat butter and saute onions and cranberries until onions are soft but not brown. Pour half of the onion mixture and half-and-half into a blender and whirl at top speed until smooth. Mixture may appear curdled before blending. Repeat with remaining onion mixture and half-and-half. Pour into saucepan again and stir in milk. Heat until bubbly. Season to taste with salt and pepper. Can also be served icy cold. Recipe can be doubled to feed a larger group.



A MEMORABLE Thanksgiving table laden with twin turkeys—each with a different cranberry glaze and stuffed with its very own sauce and dressing. A creamy Cranberry Soubise Soup and Cranberry Spiced Fruits all combine for this fabulous holiday feast.

Sandoz Official Says System Needs Changes

Olav Messerschmidt, director of biotechnology affairs for the Sandoz Crop Protection Corporation, recently told the 74th annual meeting of County Agricultural Agents in Somerset, N.J., that changes in the regulatory system governing the development, testing and use of pesticides could help restore consumer confidence in the nation's food supply.

"U.S. cancer rates are declining and our regulatory process guarantees Americans the safest food supply in the world," Messerschmidt remarked. "But there is always room for improvement and we are not opposed to change."

Messerschmidt said potential improvements could include compulsory training and certification of chemical applicators, enforcement of existing civil penalties against pesticide misuse, and additional funding to increase analyses of fresh produce.

Great Bog Sand!

Right from the Heart of Cranberry Country

Reserve your supply now for winter delivery (depending on ice) or we will stockpile at your bog anytime.

Very Competitive Price

Call Today

1-800-696-SAND

Casoll Sand & Gravel Inc.

P.O. Box 750

Hanson, MA 02341

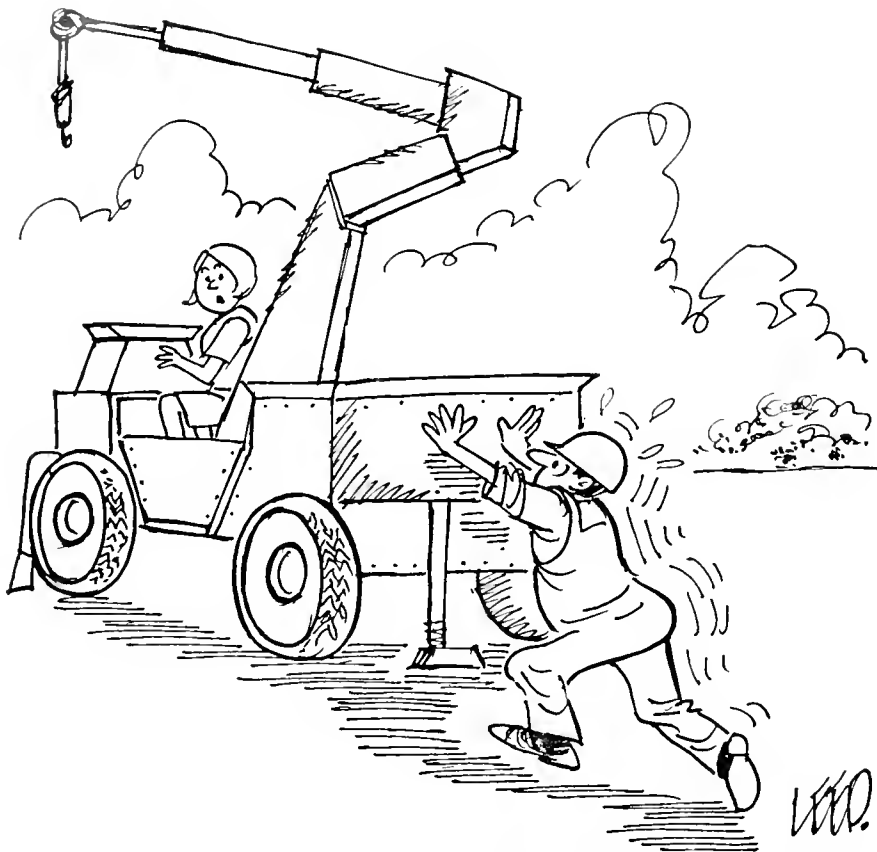

'SHOULD I TAKE IT OUT OF REVERSE, DEAR?'

NEW PRODUCT INFO

Two portable microscopes designed for horticulture use are available from RF Inter-Science Co. Designed to fill the need for superior image quality in a reasonably priced instrument, these wide-field units are also camera adaptable. Two models are available—Macroscope 2, a fixed magnification unit, and Macroscope 18-36 Zoom, a unit providing variable magnification. Both portable units can be taken into the greenhouse and used for on-the-spot identification of plant lesions or insects.

* * * * *

The Du Pont Company has developed a program of reusable and returnable containers for some of its pesticides. A company spokesman said the program was developed because growers and applicators are concerned about the environmental impact and added costs of container disposal.

Statement of Ownership, Management and Circulation Required by 39 USC 3685 1. Title of Publication: Cranberries 2. Date of filing Sept 14, 1989 3. Frequency of issue: monthly 3A. No. of issues published annually 12. 3B. Annual subscription price \$15 4. Complete mailing address of known office of publication 2 Freestone Ave., Portland, Middlesex County CT 06480 5. Complete mailing address of the headquarters of general business offices of the publisher same 6. Full names and complete mailing addresses of publisher, editor and managing editor publisher, Robert Taylor, Wellwyn Drive, Portland CT 06480; editor, same, managing editor, same 7. Owner Robert Taylor, Wellwyn Drive., Portland CT 06480 8. Known bondholders, mortgagees, and other security holders owning or holding 1 percent or more of total amount of bonds, mortgages or other securities none 9. not applicable. 10. Extent and nature of circulation (average no. copies each issue during preceding 12 months and actual no. copies of single issue published nearest to filing date) A. total no. copies, 650 and 650, B. paid circulation (1. sales through dealers and carriers, street vendors and counter sales, 0 and 0) and (2. mail subscriptions, 592 and 615); C. total paid circulation 592 and 615, D. free distribution by mail, carrier or other means, samples, complimentary and other free copies 0 and 0, E. total distribution, 592 and 615, F.

copies not distributed (1. office use, left over, unaccounted, spoiled after printing, 58 and 35) and (2. returns from news agents, 0 and 0), G. total 650 and 650. I certify that the statements made by me above are correct and complete (Signed) Robert Taylor, Publisher/Editor.

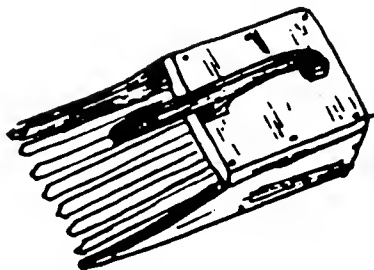

**The
CHARLES W. HARRIS
Company**

451 Old Somerset Avenue
North Dighton, Mass.
Phone (508) 824-5607

AMES
Antisiphon Devices
RAINBIRD
Sprinklers
HALE
Pumps

*Highest Quality Products
With Satisfaction Guaranteed*

**YANKEE
PLANNERS,
INC.**

59 North Main Street
Middleboro, MA 02346
(508) 947-0527

Sound and Objective
Advice
Suited to
Your Needs

Do You Know . . .
How the Government
will value the assets in
your estate? Do you
know what transfer
taxes will be due? Do
you know how they
will be paid? Do you
know that with
effective planning
these taxes can be
significantly reduced?

Mr. William H. Bestgen, Jr.
Chartered Financial Consultant

Mr. Peter W. Hutchings
Attorney at Law practicing as
a Tax Attorney

Mr. Roger H. Parent, Jr.
Accountant, Enrolled to Practice
before the Internal Revenue
Service

*Call For Your Free Brochure
(508) 947-0527*



DRESSER + BARK RIVER

*Quality products and
trained, dedicated people
standing behind them.*

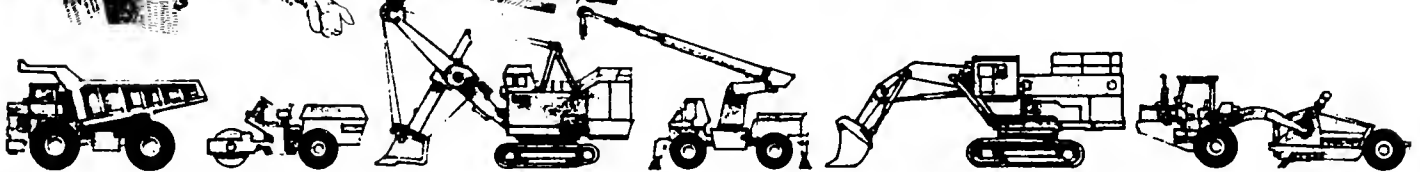

It's a combination that adds up to top production for you!

Then add BARK RIVER's full line of other quality tools and equipment and you have a complete source for all your equipment needs, all backed with dependable product support.

D DRESSER.

Crawler Loaders
Crawler Tractors

Draglines
Drills
Graders

Hydraulic Excavators
Hydraulic Shovels
Planers

Rollers
Scrapers
Shovels

Trucks (off-highway)
Wheel Loaders

- FRINK SNOW-PLOWS
- FMC WAYNE STREET SWEEPERS
- CLARK-BOBCAT SKID STEER LOADERS
- WISCONSIN TRAILERS
- VAC-ALL BY LEACH
- GAFNER IRON MULE
- TIGER HIGHWAY MOWERS
- HITACHI EXCAVATORS AND CRANES
- PAPER, CALMENSON BLADES AND CUTTING EDGES
- FOX SPREADERS
- WALDON LOADERS
- GRADALL INC. EXCAVATORS
- MURPHY DIESEL ENGINES
- KOLMAN CONVEYORS
- MORBARK EGER BEEVER CHIPPERS
- FAIR SNOWBLOWERS
- AMZ ASPHALT PATCHING EQUIPMENT
- SICARD SNOWBLAST SNOWBLOWERS

Manufacturers of corrugated steel & aluminum culvert pipe and drainage products.



BARK RIVER Culvert & Equipment Co.

Backing you with 83 years of experience.

EAU CLAIRE
1700 Western Avenue
Phone (715) 835-5157

MADISON
Highway 51 & Buckeye Rd.
Phone (608) 222-4151

ESCANABA
430 N. Lincoln Street
Phone (906) 786-6920

GREEN BAY
600 Liberty Street
Phone (414) 435-6676

SUPERIOR
1213 Winter Street
Phone (715) 392-2243

MILWAUKEE
11715 W. Silver Spring Rd.
Phone (414) 461-5440

Take Good Care of Yourself Have an Ocean Spray!



The farmer's cooperative that brings you
a wide range of natural fruit juices, drinks and sauces

Ocean Spray Cranberries, Inc., Lakeville-Middleboro, MA 02349

An Equal Opportunity Employer

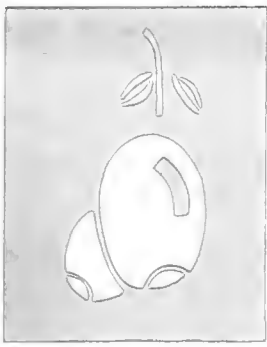

CRANBERRIES

THE NATIONAL CRANBERRY MAGAZINE

December 1989

Vol. 53, No. 12



Rutgers Research Lab Expands

Baked Goods Firm Built Around Berry

S

Cranberries a Health Campaign

UNIV OF MASS LIBRARY
SERIALS DEPT
AMHERST
MA
01003

For A . . .

Merrier Xmas . . .

*Give A
"Cranberry Insect"
Portfolio*

Know the Insects

The major cranberry insects: cranberry girdler, the fireworms, tipworm, blossom worm, cranberry fruitworm and Sparganothis fruitworm.

The periodic cranberry insects: cranberry scale, fire beetle, blossom weevil, armyworm and bluntnose leafhopper.

Color photographs of all these insects and more are now arranged with text in a portfolio that is available.

The portfolio endeavors to bring together the words of research complementing the photographs and making a summary of cranberry insect information that will be of use to the cranberry grower for a lifetime.

The portfolio is available for \$100 and, if you wish to examine a copy, telephone (609) 894-8556 evenings around 6 p.m. or write to:

**Walter Z. Fort
P.O. Box 183
Pemberton, NJ 08068**

BJ Foods Inc.

Successful Baked Goods Company Starts Up On Proverbial Shoestring and Box of Berries

By JOAN RUSSELL

Everybody makes a cranberry muffin now and then.

And, during the holiday season, you find a cranberry nut bread in almost any bakery.

But try to find commercially produced, cranberry baked goods year-round at any supermarket or fast food chain store.

That's the market Jose Moniz and Bea Reale decided to tackle.

TWO YEARS ago, armed with the proverbial shoestring, a handful of recipes and a small supply of cranberries, they originated BJ Foods in Hanson, Mass.

Their first product was a cranberry cake equivalent of carrot cake or banana cake.

Then came Bea's Cape Cod Cranberry Cake with Lemon Orange Glaze made from an old recipe that Bea's mom used.

The latter cake was packaged in boxes and sold to several local supermarket chains for their freezer sections. But Moniz quickly changed strategy when he found this aspect of the business wasn't profitable.

"We decided to market the cake fresh to specialty stores and small supermarkets," he says. "We found a 20 to 30 percent increase in sales per store when we did this."

Jose and Bea learned the commonplace demands of small business: long hours and holiday work. And they did everything themselves: bake, market, sell, deliver.

Their hard work paid dividends. Soon they were able to hire help.



EMPLOYEES fold cranberry cake boxes at the BJ Foods plant in Hanson, Mass.

(CRANBERRIES photo by Joan Russell)

COVER PHOTO

DR. ERWIN ELSNER, specialist in entomology at the Rutgers University blueberry/cranberry research center, is focusing his research at present on the sparganothis fruitworm. For a story about cranberry research in New Jersey and more photos of the staff at the expanded research center, turn to page 8.

(CRANBERRIES photo by Elizabeth G. Carpenter)

SKIPPAR

POLE



SERVICE

- Private Poles • Line Construction
- Sonotube Drilling • New & Used Poles

(508) 690-2238

208 Franklin St., East Bridgewater, MA 02333

In an effort to attract customers year-round, BJ Foods offered a variety of cranberry nut breads mixed with seasonal fruits. During the spring and summer, the company markets cranberry orange and cranberry lemon nut breads. In the fall and winter, cranberry pumpkin and cranberry caraway nut breads are sold to complement the season.

The nut breads are wrapped by the slice and sold to food services, including one that supplies Logan Airport and convenience stores. Moniz hopes to market products to the school food service industry in the near future.

Besides the aforementioned baked goods, BJ Foods also has developed cranberry sweet bread rolls, cranberry chocolate chip cookies, cranberry oatmeal cookies, and even cranberry bread pudding.

The company's baked goods line is marketed under the trade name Bea's.

GROWTH has been so steady and good that the company will soon move from its present 2,000 square foot facility in Hanson to a 25,000 square foot plant in New Bedford, Mass.

"The new facility will be centrally located near the areas where we market the products . . . southern Massachusetts, Cape Cod, Connecticut, Rhode Island and Boston," Moniz said.

Baking is now done manually. In New Bedford, the operation will be



JOSE MONIZ keeps an eye on a 120 quart mixer used for mixing dough at BJ Foods.

(CRANBERRIES photo by Joan Russell)

completely automated. And staff will be increased from five to ten, leaving Jose and Bea more time to focus on administrative tasks.

Many new products are in the offing. Currently being developed in a joint venture with a liquor company is a line of cranberry

liquor cakes. These include a cranberry rum cake with pineapple, cranberry cognac cake and a cranberry bourbon cake.

"I like to keep a new product in mind all the time," says Reale. "We develop our own recipes through trial and error until they are true

**The
CHARLES W. HARRIS
Company**

451 Old Somerset Avenue
North Dighton, Mass.
Phone (508) 824-5607

AMES
Antisiphon Devices
RAINBIRD
Sprinklers
HALE
Pumps

*Highest Quality Products
With Satisfaction Guaranteed*

Irrigation Supplies

- 2" to 12" PVC Pipe with Fittings
- Quik Couple Risers
- Felker Aluminum Flumes & Culverts

Replace old aluminum mains with government approved 4", 6" and 8" polyethylene pipe buried just below bog surface. No insert fittings. Rent our butt fusion welder for a continuous main line. Beat the high cost of custom installation by renting our small 4-wheel drive tractor with mole hole plow for buried laterals.

STEARNS IRRIGATION, INC.
790 Federal Furnace Rd.
Plymouth MA 02360
Tel. (508) 746-6048

good products."

The company also is back to dealing with large supermarkets. This time it is to sell their freezer departments a cranberry cake as a special holiday item.

BJ FOODS buys approximately 90 percent of its cranberries from Ocean Spray. This year the company used 150,000 pounds of cranberries alone.

Much of the feedback regarding its success comes to BJ Foods via letters written by tourists who visit Cape Cod. Letters containing kudos about their baked goods have arrived from as nearby as Watertown, Conn., and from as far away as Nova Scotia.

FERTILIZER COMPANY PRODUCES NEW VIDEO

IMC Fertilizer of Northbrook, Ill., has produced an 11-minute video, "Facing Facts About the Future of Agriculture," that the company is making available to interested groups and individuals.

In part, the video deals with alternative methods of farm management.

Single copies of the brochure and video can be obtained by contacting Dr. Lindsay Brown at IMC Fertilizer Inc., 501 East Lange St., Mundelein, IL 60060.



BEA REALE & JOSE MONIZ pause for a chat during inspection of an oven at BJ Foods.

(CRANBERRIES photo by Joan Russell)

CRANBERRIES

THE NATIONAL CRANBERRY MAGAZINE

SEND CORRESPONDENCE TO:

**P.O. BOX 249
COBALT CT 06414
(203) 342-4730**

Fax #: (203) 342-1977

PUBLISHER & EDITOR: BOB TAYLOR

**ASSOCIATE EDITOR: CAROLYN GILMORE
(508) 783-5208**

ADVISORS & CORRESPONDENTS

MASSACHUSETTS — Irving E. Demoranville, Director, Cranberry Experiment Station

NEW JERSEY — Phillip E. Marucci, Cranberry & Blueberry Specialist, Buddtown; Elizabeth G. Carpenter, Chatsworth

NOVA SCOTIA — Robert A. Murray, Horticulturist, Berry Crops, Research Station, Truro.

OREGON — Arthur Poole, Coos County Extension Agent, Coquille.

WASHINGTON — Azmi Y. Shawa, Horticulturist and retired Director, Coastal Washington Research & Extension Unit, Long Beach.

WISCONSIN — Tod. D. Planer, Farm Management Agent, Wood County.

CRANBERRIES is published monthly by Taylor Publishing, 2 Freestone Ave., Portland, CT 06480. Second class postage is paid at the Portland, CT Post Office. Price is \$15 a year, \$28 for two years, \$2 a copy in the U.S.; \$17 a year in Canada, \$20 a year in all other countries. Back copies \$2.50, including postage. Copyright 1989 by Taylor Publishing

ISSN 0011-0787

Postmaster, send Form 3749 to
CRANBERRIES
P O BOX 249
COBALT, CT 06414



THIS BJ Foods ad is for Bea's Cape Cod Cranberry Cake.

REGIONAL NOTES

MASSACHUSETTS

By IRVING E. DEMORANVILLE

Members of the Massachusetts Cranberry Experiment Station staff that attended the 8th International Cranberry Research and Extension Workers Conference at Corvallis and Bandon, Ore., Sept. 20-23 were Dr. Anne Averill, Dr. Frank Caruso, Dr. Robert Devlin, Dr. Irena Zbiec, Carolyn Demoranville, Martha Averill and this author.

The first day of the conference was spent in and around Corvallis where the highlight was a tour of the USDA Germplasm Repository.

We also visited the Tyce vineyard and winery, a peppermint farm, a blueberry field and a farm that produced grass seed. The remainder of the day was spent in traveling to Bandon. The balance of the conference was held in and around Bandon.

The group visited 10 cranberry operations plus the Ocean Spray receiving station the second day. The third day was reserved for presenting papers and a poster session. There were 22 talks and five posters given.

The final morning we visited one bog and then met in a number of group sessions by specialty: insects, diseases, soils and fertilizers, weeds and growth regulators, and plant breeding. A short business meeting to decide on the time and place of the next meeting wound up the proceedings.

The spouses attending were treated to two excellent tours of the Bandon area while the research and extension people were busy. There were probably 50 people in attendance and it was particularly satisfying to see many younger people there.

Until someone has had to be the ramrod for a meeting like this, they have no conception of the work and planning involved. So my sincere thanks to Art and Toni Poole, John Hart, Bernadine Strik, Kris Wilder and all of the people at the Germplasm Repository. To all of the others on the team, forgive me for not noting you individually, but be assured that the kind thoughts are for you also.

On a personal note, it was wonderful to visit with friends from the past, especially Jim Chandler, Ray Hopper and Dave and Jeanette Brooks.

.....

Some dry harvesting began soon after Labor Day but berries were miserably small.

Size did improve as the month progressed but was only average for the Early Blacks. Color was good but not outstanding. No frost warnings until the 24th and then on the 27th.

Quality of Early Blacks is on the weak side. Crop only about 30 percent harvested by Oct. 1, but came in fast after that.

There were some outstanding crops. However, most growers are slightly or more under estimate.

There is a good Howe crop.

It appears that the crop is not a record, but

probably near the USDA August estimate, maybe a little below.

OREGON

Despite rain—sometimes heavy—the Bandon Cranberry Festival attracted the most people ever, according to police.

This year's queen was Darcie Elliott. Princesses were Kristi Hofess, Mandy Scott and Kim Gore.

There were more than 80 entries in the parade.

WASHINGTON

Champion fiddlers, surrey rides, a chimpanzee, several llamas, a play and bog tours were among the highlights of Ilwaco's sixth Cranberry Festival.

WISCONSIN

Federal regulatory and environmental officials, staff from the U.S. Congress and members of the Army Corps of Engineers recently heard cranberry growers tell of how

they preserve the environment by protecting wetlands and setting aside undeveloped woods and fields around their marshes.

Speaking to the visitors at Ken Rezin Cranberries in Cranmoor were Russ and Karen Rifleman.

"Cranberry growers support President Bush's 'no net loss of wetlands' proposal," said Russ Rifleman. "In fact, we are making the president's goal of saving wetlands—at no expense to taxpayers—a reality."

"The cranberry growers are obviously attuned to a number of environmental concerns," said Col. Roger Baldwin of the Army Corp of Engineers.

BIOTECH PREXY CALLS FOR TAX LAW CHANGES

Dr. Jerry Caulder, Mycogen Corp. president and CEO, recently told the House Subcommittee on Science, Research and Technology that the research and development tax credit should be restored to make U.S. industry more competitive.

The head of Mycogen, a company engaged in the development of biopesticides, said that current tax laws inhibit the start-up of high technology companies.

Cranberry Vines For Sale

Ben Lears at \$3,700 per ton

Pilgrims at \$5,000 per ton

Available for Spring of 1990

Prices F.O.B.

(608) 378-4069

Or Write:

Jensen Cranberry Bogs, Inc.

Route 2 Box 92

Warrens, WI 54666

J.A. JENKINS & SON CO.

Grower Service

MOWING (ALL TYPES)
SANDING

DITCHING
WEED WIPING

Serving Cape Cod

227 Pine St., W. Barnstable, Ma. 02668

Phone 362-6018



25 years experience   construction lifts 

Specialist in
Construction
Survey
Charter
Photography
Aerial Application

Supply our own
ground support
crew & equipment

AERIAL LIFTING



◦ **BERRY LIFTING** ◦
mat rentals & sales

◦ **MUD LIFTING** ◦
NEW MATS

*lightweight
durable*

contact

PETER or CHUCK
508-295-2222

**JOE
BRIGHAM
INC**

 **BEATON'S
CRANBERRY
GROWERS SERVICE**

WAREHAM, MASS.

Office
295-2222

**BEATON'S
CRANBERRY
GROWERS SERVICE**

K. Beaton
295-2207

WAREHAM, MASS.

D. Beaton
888-1288

P. Beaton
947-3601

Specializing in

● COMPLETE BOG
MANAGEMENT

● NETTING

● DITCHING

● HARVESTING
(Wet & Dry)

● SANDING

● CUSTOM
HERBICIDE
APPLICATION

Complete line of portable Crisafulli Pumps 2" - 16"
Plastic netting for suction boxes



Expanded Research Center Team Tackles Nagging Problems

By ELIZABETH CARPPENTER

Ernest W. Bowker, the American Cranberry Growers' Association (ACGA) president, greeted New Jersey growers on a recent rain free August morning, a rarity during a season of record breaking precipitation. The question for the summer of '89 was not "how much rain," but "where to put it," as reservoirs and streams filled to the brim.

DESPITE the deluge, Bob Battaglia of New Jersey's Agricultural Statistics Service brought growers encouraging news. Crop projections, he said, indicate a harvest of 340,000 barrels, with overall berry size ranging from medium to large. Although production will be down about 8 percent from last

year's record crop, it is 21 percent more than the 1987 yield.

Ray Samulis, Burlington County agricultural agent, reviewed symptoms of vine dieback and suggested ways of controlling it. Caused by phytophthora fungus, three phases of the disease's progress in cranberry bogs include:

- appearance of small, grayish-colored areas of vines in bogs;
- lesions on stems and vines turn brown and darken;
- stems and underground runners totally darken.

Spread of the disease is enhanced by extremely wet conditions and, when an area is infected, plant tissue may be completely destroyed.

Two recommendations made by Dr. Frank Caruso, extension plant pathol-

ogist with the University of Massachusetts, are being tested in New Jersey: application of Ridomil and bog sanding. Caruso cautioned that positive results from Ridomil application may not be seen for approximately 18 months.

Sanding on New Jersey bog test plots has yielded unexpected results, with disease control being better on unsanded "check" plots than on sanded plots.

DR. ERWIN ELSNER, specialist in entomology at the Rutgers University blueberry/cranberry research center, updated growers on his integrated pest management (IPM) research as it relates to sparganothis fruitworm, a hardy pest that appears to be able to overwinter in flooded bogs.

Research in 1990 will begin with a spray when moths are in flight. The results of this

Cranberry Harvesting Equipment

Warrens Equipment & Manufacturing Co., Inc.

Growing cranberries is something you as a grower do best. Manufacturing of harvesting equipment, air flow, radar controlled fertilizer spreading equipment, and flow gates or flumes is something we do that can be of service to you.



NEWS FLASHES

Standard WEM Bog-Trac Tractors & Beaters Available For Immediate Shipment

- Beater reels available, your choice of designs
- You as a grower tell us what is best for your bog
- Change your reel rpm from bog to bog or variety to variety
- Engine horsepower available from 18 h.p. to 48 h.p.
- Safety parking brake
- Ground speed and reel speed Indicator
- Lighter weight

Be sure to check this new model harvester before you make a purchase for 1989.

WEM Factory *servicing Wisconsin, West Coast, British Columbia*
111 Grant St.
Warrens, WI 54866
Tel. (608) 378-4794
(608) 378-4137

WEM East Coast
Stearns Irrigation, Inc.
790 Federal Furnace Rd.
Plymouth, MA 02360
Tel. (508) 746-6048

Photos of New Jersey Research Center Team

(Elizabeth G. Carpenter, Photographer)



DR. NICHOLI Vorsa (right), associate director, and **Dr. Erwin Elsner,** specialist in entomology, examine one of Vorsa's many blueberry bushes used in the research center's extensive breeding programs.



DR. Leo Bruederle, a botanist, is a recent addition to the research center team.



JOHN Sarracino, "hands on" plant breeder, is Dr. Nicholi Vorsa's assistant.



DR. ALLAN Stretch, long-time USDA plant pathologist, will be devoting an increased amount of his time to field disease research.

year's research suggest a single early application may have the greatest impact. Control is very difficult once eggs hatch and worms infest the berries, Elsner said. Damage from the growing worms increases even though the population remains stable. Although the infected fruit may fall off the vine in July and August, the berries still float and end up as part of the harvest.

Elsner noted that a second application, or "revenge spray," has little impact on this voracious pest, since most worms remain inside the berries, untouched by a later application. Next year's research efforts will benefit from tests and sampling conducted on high yield commercial bogs. Development of sampling techniques for eggs, application timing, and efforts to identify most effective control products are three key tasks in future IPM research related to sparganothis fruitworm.

DAVID Farrimond, Cranberry Marketing Committee general manager, presented growers with a slightly more optimistic crop report of 360,000 barrels, 20,000 barrels higher than the total projected by the New Jersey Agricultural Statistics Service.

He went on to remind growers that their marketing order representatives were Joseph Darlington, Stephen Lee III, Alvin Brick Sr. and Charles Thompson. Marketing Committee hearings are scheduled for January and February 1990 and will focus on amendments related to base quantity as well as financial support for industry-related research and production.

DR. ROGER Wyse, senior associate director of the New Jersey Agricultural Experiment Station, told growers that the blueberry/cranberry research center receives funding from four sources: the state legislature, special congressional grants, the agricultural research service and Ocean Spray. This funding supports 12 to 15 faculty members involved in cranberry and blueberry research.

A considerable amount of the team's future effort will be directed toward finding methods to minimize the impact of pesticides while maintaining high crop productivity. Some of the team members include Dr. Nicholi Vorsa, who will continue his plant breeding and genetic research, Dr. Erwin Elsner, who will continue to head integrated pest management efforts, Dr. Allan Stretch, who will devote an increased amount of his time to field diseases, and Dr. Paul Eck, who will continue his water management experiments. Wyse also noted that, in addition to increased staff, the research center now has expanded laboratory facilities and a new conference room.

A SOMBER note clouded morning reports of industry progress as Edward V. Lipman led growers in paying tribute to Hobart Gardner, an Indian Mills grower who was recently killed in a heavy equipment accident. The 75-year-old Gardner will be remembered for his commitment to New Jersey's cranberry industry, as well as his community service.

After lunch, growers adjourned to the research center bogs, where they had an



CHRIS Constantelos, senior lab technician, continues to assist Dr. Stretch with his plant disease research.

opportunity to examine the productivity and coloring capability of different cranberry varieties, compare the impact of sprinkler irrigation for summer temperature control on sanded and unsanded bogs,

and evaluate the effectiveness of different herbicides for control of red root in test plots.

They also had a chance to tour the new facilities at the expanded research center.

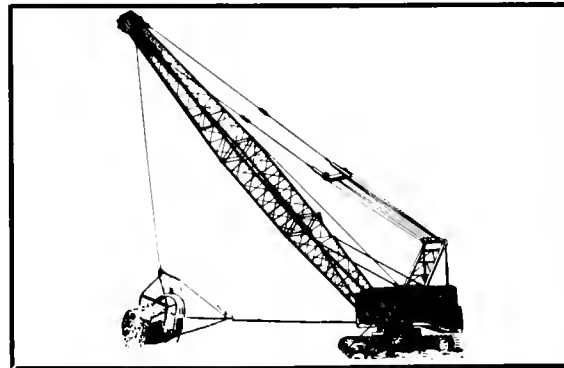

Krause Excavating, Inc.

Canal Work

Ditching

Pond Construction

Land Clearing

1-1/4—3 yd. draglines with 80' boom and matts, 2 yd. backhoe, swamp dozer and other related equipment.

Contact:

Roger Krause 1-414-398-3322
Route 3 Markesan, Wis. 53946

Spring 1990



Vines For Sale

Ben Lear	\$3,700.00 per ton
Crowley	\$3,500.00 per ton
Stevens	\$3,500.00 per ton
Pilgrims	\$5,000.00 per ton
LeMunyon	\$5,000.00 per ton

Buy 10 tons, get one ton free.

Prices F.O.B.

Contact:

20% down payment with order.

Call for large order pricing.

LeRoy Miles
Northland Cranberries, Inc.
(715) 424-4444
251 Oak Street
Wisconsin Rapids, WI 54494



**MIDDLEBOROUGH
TRUST COMPANY**

The Business Bank.

MTC offers you business banking built to your needs.
Personal attention to your special
financial requirements now and as you grow. Cooperation.
Flexibility. Complete business and personal banking.
Member FDIC



Main Office

10 John Glass, Jr. Square, Middleborough

Branch Offices

Middleboro Square, Rt. 28, Middleborough • Middleboro Plaza, Middleborough
Cranberry Plaza, East Wareham • Carver Square, Carver • Trucchi's Plaza, Taunton
Telephone all offices **947-1313**



THE BEST — IN EVERY RESPECT

CRANBERRY Model 400 GT

Precision Chemigation System



- Developed *Exclusively* for the Cranberry Industry
- Exceeds or Meets ALL Current EPA Requirements
- Simple to Operate and Easy to Calibrate
 - Self-Timer Application (1 minute increments)
 - Easy Access Handle & Simple Reference Scale
 - Precise Visual Flow Calibration
- Outstanding Field Performance
 - Down-Line Venturi Injection System
 - High Capacity 0-7 GPM Injection Rate
 - Large Volume 175 Gallon Mix Tank
 - 12 Volt Gear Reduction Mixer
- Designed for Trouble-Free Operation
 - Reliable 11 HP Honda Electric Start Engine
 - Critical Components Are Stainless Steel & Polypropylene
- Completely Self-Contained and DOT Approved Transportable
- Personalized, Experienced Support Service as Close as Your Phone

CHEMIGATION SYSTEMS INTERNATIONAL, INC.

Corporate Offices: P.O. Box 247
(608) 297-2041

Montello, WI 53949
FAX: (608) 297-7248

Call us today for the dealer nearest you, or contact:

Skip Tenpas
Central Sands Irr. & Bldg., Inc.
Hwy 51 & 73 Interchange
Plainfield, WI 54966
(715) 335-6372

Bruce Sunnerberg
AAA Industrial Pump & Ser., Inc.
66 Lake Street
Plympton, MA 02367
(617) 585-2394

NOTICE
Selected exclusive
dealer territories
still available —

Inquiries invited

**WANT YOUR CROP DELIVERY RESULTS FAST?
NOW YOU CAN HAVE **DIRECT** ACCESS TO THE
RECEIVING STATION IN YOUR OWN AREA!**

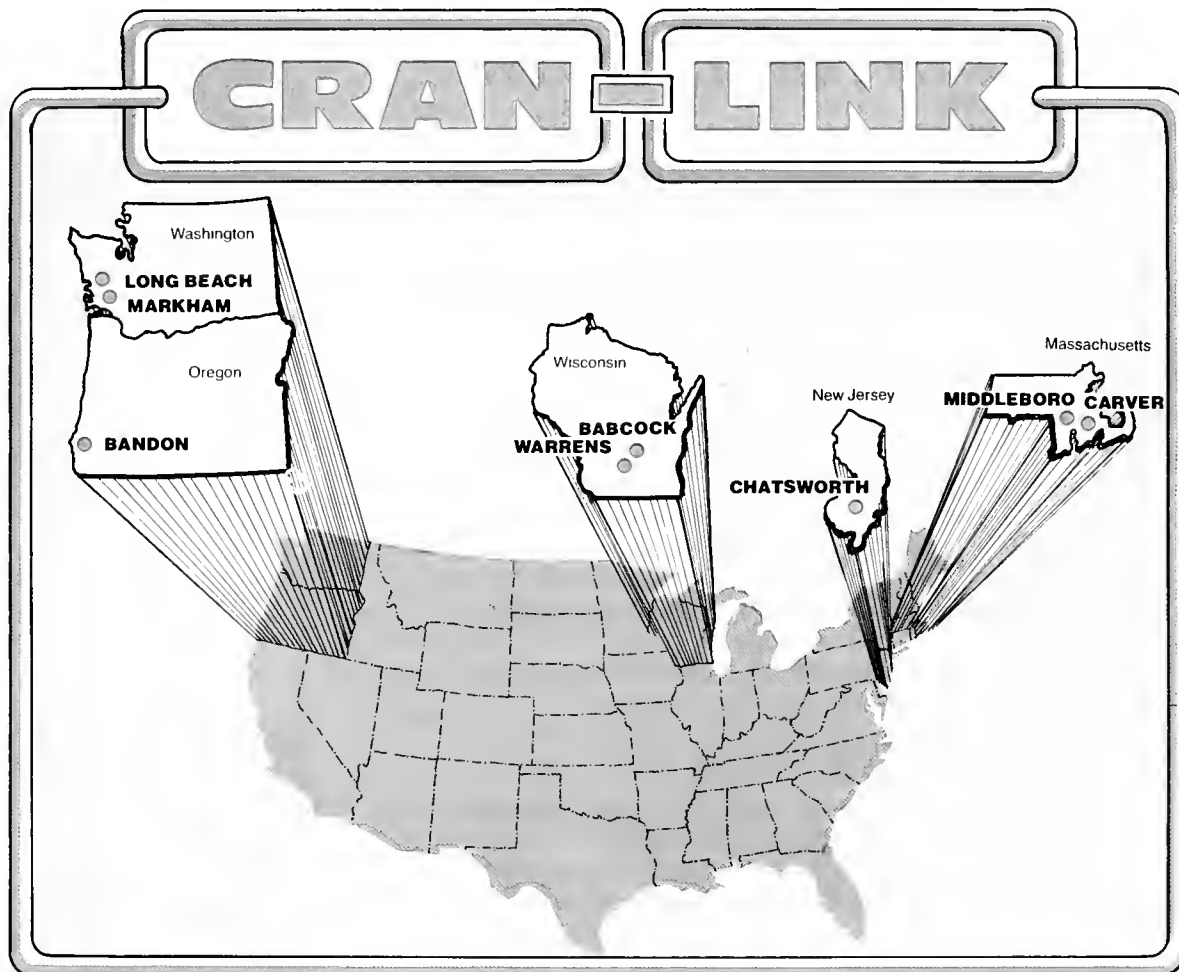

CRAN-LINK

Automatically feeds your delivery information into the Cranberry Growers System, a complete production, chemical and fertilizer tracking system designed exclusively for cranberry growers.

REQUIREMENTS: IBM Micro Computer or 100% compatible • DOS 3.3 • 640 K • Hard Disk
Cranberry Growers System (or CGS Limited Edition)



Call or write:

CRANBERRY COMPUTER, INC.

P.O. Box 1037 • Plymouth, MA 02360 • Telephone (508) 747-3033 • Fax (508) 747-6918

editorial



Cranberries Get Lots of Exposure

We cannot remember another year in the decade we have been publishing CRANBERRIES that we have seen so much news and so many newspaper and magazine features about the berry.

The Daily Tribune (Wisconsin Rapids, Wisc.), *Chinook Observer* (Long Beach, Wash.), *Western World* (Bandon, Ore.) and the *Wareham Courier* (Wareham, Mass.) all carried long stories about the harvest as well as fine photos, many of them in color.

Amtrak travelers who happened to pick up the October/November issue of *Amtrak Express* saw an article, "Native Sauce," by J. Wandres, which begins:

"The cranberry has been with us from our beginnings on this continent, as much a part of our festivities as turkey or corn. Henry David Thoreau, that archetypal American, called cranberries 'perhaps the prettiest and certainly the most novel and interesting berry.'"

We must admit that our interest in the story was heightened by the fact that CRANBERRIES received a mention.

The reasons for the fascination of the cranberry are not so mysterious. Its unique culture is one of them. So is its bright red color. And the fact that it is so native a fruit.

There are a substantial number of books about the cranberry, which keep an interest in the fruit alive. Ever hear of books on other fruits? Ever hear of books about the lemon? Or the kumquat?

Latest entry on the book scene is "Cranberries from A to Z: An Educational Picture Book" by Ann Kurz. Kurz, a Wisconsin artist and author knows her cranberries, a fact that is obvious from a reading of this delightful children's book.

Each page contains bright watercolor paintings, devoted to cranberry culture and to a single letter of the alphabet. On the "M" page, for example, the child reads:

McFarlin berries are
Magnificent!

and

Marsh
Managers
Must be
Mechanically
Minded



AGGIE HALL OF FAME INDUCTS 3 LEADERS

The Agricultural Hall of Fame and National Center in Bonner Springs, Kans., recently inducted Dr. Curtis Fletcher Marbut, Dr. Marion Dorset and Jerome Increase Case.

Marbut, chief of the U.S. Soil Survey, 1913, was the founder of the present system of soil classification and mapping that is used throughout the world. He died in 1935.

Dorset developed the vaccine which eradicated hog cholera throughout the nation. Dorset also died in 1935.

Case, who died in 1891, was the founder of the J.I. Case Co. He was called the "threshing machine king."

CAULDER NAMED HEAD OF BIOTECH ASSOCIATION

The Industrial Biotechnology Association recently named Jerry D. Caulder, president and CEO of Mycogen Corporation, as its chairman.

Caulder's election took place at IBA's eighth annual meeting, held this year in Washington, D.C.

Wanted to Buy

40 Tons of Stevens
Vines for
1990 Planting.

Would Like to See
Vines Now.

Contact: Timothy Finch
Rt. 3
Box 320
Black River Falls
Wisconsin 54615

CRANBERRY GROWERS REALTY

Listings of buyers and
sellers welcomed on
cranberry acreage
and upland.
Appraisals

DOUGLAS R. BEATON
E. Sandwich, Mass
02537
(617) 888-1288

Cranberry Sales Up in Caribbean

By LEWIS MANUEL MEDINA

"Could you pass the cranberry sauce, please?"

Decades ago, those words were unheard in the Caribbean. Today the sales of cranberry products are up. Why?

One major reason is that Americans are taking vacations closer to home. And the Eastern Caribbean or West Indies Region is benefitting from that fact.

According to the Barbados based Caribbean Tourism Association, the number of tourists in 1988 was 10 million. And that number is expected to continue growing.

Most of those tourists are Americans, followed by Canadians. More Americans mean that more hotel restaurants are serving cranberries and cranberry juices. With the importation of more cranberries, more natives become familiar with the fruit.

Another factor is the large migration of Caribbean natives to the U.S. About

2.85 million Puerto Ricans live on the mainland. So do about 1.7 million from other places in the Caribbean. About 2 million people in Puerto Rico had once lived in the U.S.

Among the influences of all this travel has been a familiarity with cranberries. Those who have lived in the U.S. or return to visit their homeland expect to find cranberries in Puerto Rican supermarkets. Hence, availability of cranberry products increases.

The most common cranberry products are fruit drinks, including both cranberry and mixed drinks.

How much is consumed? That's hard to say since cranberries are not a local crop nor are they processed locally, so little track is kept of them.

What is known is that Puerto Rico provides the biggest market, followed by the U.S. Virgin Islands, Bermuda, the Bahamas and the Cayman Islands.

Respectably increasing their consumption are the British Virgin Islands, Anguilla, Saba, Saint Eustaquius, Saint Marteen, Saint Martin, Aruba, Bonaire and Curacao.

Other nations with still low consumption are the Dominican Republic, Jamaica, Saint Kitts and Nevis, Antigua and Barbuda, Dominica, Saint Lucia, Saint Vincent, Trinidad and Tobago, Guyana, Venezu-

ela, Panama and Costa Rica.

For those cranberry wholesalers, exporters and processors looking for more export opportunities, two directories could be very useful. One is the 60 page *Barbados Directory*. The other is the voluminous 424 page *Puerto Rico: Business to Business Executive Guide*, which covers most of the Caribbean.

Both books can be obtained from Allied Publications, PO Box 388, Lares, Puerto Rico 00669-0388.

CRANLAND SERVICES

Cranberry Property Appraisals

★ ★ ★ ★ ★

Listings and Sales of Cranberry Properties.

License # 68987

Lawrence W. Pink
Old Cordwood Path
Duxbury, MA 02332
(617) 934-6076

Irrigation Equipment Designed Especially for the Cranberry Industry

- Gorman-Rupp Self Priming Electric Sprinkler Pumps
- Proven Quick Couple Riser
- Polyethylene Main Lines, 3" - 12"
- Butt Fusion Equipment Available
- Paco/Wemco Water Harvest Pump
- Berkeley Self-Priming and Centrifugal Pumps

A Most Complete Inventory of Irrigation Accessories

LARCHMONT

IRRIGATION / SNOWMAKING

P.O. Box 66, 11 Larchmont Lane
Lexington, Massachusetts 02173 (508) 862-2550

Contact

Larchmont Engineering
Phil Tropeano, President
(508) 862-2550
(Call Collect)

Stearns Irrigation, Inc.
790 Federal Furnace Rd.
Plymouth, MA 02360
(508) 746-6048

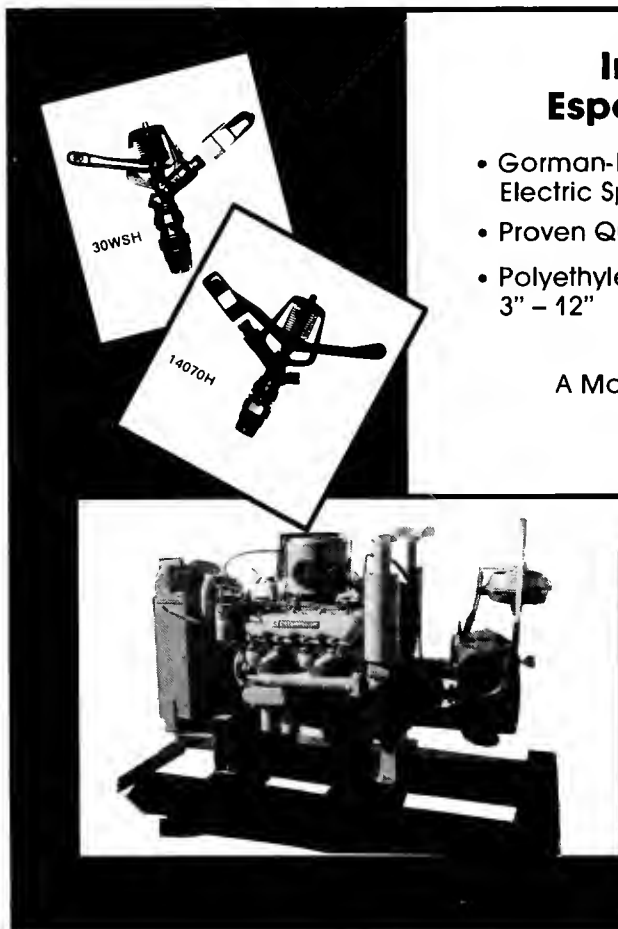

30 Years Ago

Philip H. Gibbs, third generation Massachusetts grower, was the subject of the cover story in CRANBERRIES. South Carver resident Gibbs, first vice president of the Cape Cod Cranberry Growers Association, told editor Clarence J. Hall, "I don't expect to make a million dollars growing cranberries, but I intend to stay in the business as long as I can make a living." Gibbs served in the Merchant Marine during World War II.

* * * * *

The industry gathered statistics about the falloff of sales due to the aminotriazole scare. Consumer purchases of canned goods during the week of Nov. 15-21 had dropped 79% from the prior year. The decline for fresh cranberries was 63%. Still, those figures were better than those of the previous week, when Arthur S. Fleming, U.S. Secretary of Health, Education and Welfare, had provoked the scare.

* * * * *

J. Richard Beattie, extension cranberry specialist, wrote that adequate supplies of both seasonal and full-time workers continue to be a problem. "The major alternative is greater mechanization of the entire industry," Beattie said.

* * * * *

Miss Judy Keene of Onset, Mass., was crowned "Miss Cranberry Highway of 1960."

Weather MASSACHUSETTS

September was slightly on the warm side, averaging 0.5 degrees a day above normal. Maximum temperature was 85 degrees on the 10th and the minimum was 34 degrees on the 28th. Generally, the last week of the month was cool, with part of the second and third week warm, wet and humid.

Rainfall totaled 5.23 inches, nearly 1½ inches above normal. There was rain on 12 days, with 2.17 inches on the 16th-17th as the greatest storm. This was the wettest September since 1977. We are about 5 inches above normal for the year and 8½ inches ahead of 1988.

I.E.D.

IRRIGATION VIDEO MADE

A video, "Micro-Irrigation Management," has been made available to the agriculture industry by the Coachella Valley and Riverside-Corona resource conservation districts in California.

Among subjects dealt with in the video are water contamination, soil types, algae

buildup, improper installation, salt intrusion, root and insect infestation and pH water values.

For information about the video, write Coachella Valley Resource Conservation District, 80-975 Indio Blvd., Suite B-11, Indio, CA 92201 or call (619) 347-7658.

Financial Strength... Personalized Service. Isn't That What You Need In A Bank?

The Jackson County Bank has supported agriculture in the area for more than 110 years.

We recognize the importance of the cranberry industry and are pleased to provide financial services for all your banking needs.

We're large enough to serve you and yet we offer personalized service which your business demands. Call us at 715-284-5341

The Jackson County Bank. A name to count on throughout the years.

You'll like the difference.



**JACKSON
COUNTY
BANK** Member FDIC
(715) 284-5341

Black River Falls, Alma Center, Hixton, Merrillan, Taylor, WI 54615

Vines For Sale

Spring 1990 Delivery

Ben Lear	\$3,700 a ton
Stevens	\$3,500 a ton
Crowley	\$3,500 a ton

\$500 ton less with 50% down by April 1

Spring 1991 Delivery

Ben Lear	\$3,100 a ton
Stevens	\$2,900 a ton
Crowley	\$2,900 a ton
Bergman	\$3,100 a ton
Le Munyon	\$3,000 a ton
Pilgrim	\$3,100 a ton

The above low prices are available with a \$500 down payment by April 1, 1990

Lake Nokomis Cranberries, Inc.

David Zawistowski

**6031 County Highway D
Eagle River, WI 54521**

**(715) 479-4658
(715) 479-6546**

YANKEE PLANNERS, INC.

59 North Main Street
Middleboro, MA 02346
(508) 947-0527

Sound and Objective
Advice
Suited to
Your Needs

Do You Know . . .
How the Government
will value the assets in
your estate? Do you
know what transfer
taxes will be due? Do
you know how they
will be paid? Do you
know that with
effective planning
these taxes can be
significantly reduced?

Mr. William H. Bestgen, Jr.
Chartered Financial Consultant

Mr. Peter W. Hutchings
Attorney at Law practicing as
a Tax Attorney

Mr. Roger H. Parent, Jr.
Accountant, Enrolled to Practice
before the Internal Revenue
Service

Call For Your Free Brochure
(508) 947-0527



**'I KNOW THEY'RE CRANBERRIES. THEY'RE
BETTER THAN A MISTLETOE!'**

WANTED

Gravel & Sand

in the southeastern Massachusetts area

Quantities of 10,000 yards and up

*Complete site work, bog construction and finished con-
touring of surrounding area plus the best price for your
material.*

Michael Coan
(508) 866-5285

Earle White
(508) 359-7291

Distributors of:



"Cut Your Watering
In Half"

Wisconsin Growers Fund Grad Student Research & Study

By ELDEN J. STANG

Cranberry research in the department of horticulture at the University of Wisconsin recently received a significant boost through the generosity of a number of Wisconsin cranberry growers.

Among those growers were Frank and Betty Koller, Leasure-Koller Cranberry Co., Manitowish Waters. A ceremony of appreciation and reception for the couple was held Sept. 6 at the horticulture department on the University of Wisconsin/Madison campus.

Cranberry growers, cranberry industry representatives, administrators of the UW/Madison College of Agricultural and Life Sciences and department faculty, staff and students joined in expressing appreciation to the Kollers for a major contribution of \$100,000 to initiate the Frank B. Koller Century II Cranberry Fund in memory of their son.

A plaque was presented to the Kollers, which reads, "In appreciation for the Frank B. Koller Century II Cranberry Fund in memory of Frank B. Koller 1947-1978, endowed by Frank R. and Betty J. Koller."

The plaque will be permanently on display in the department, along with recognition for other major contributors to the Horticulture 2000 Centennial Fund drive, currently in progress.

FRANK AND BETTY KOLLER, through the Koller Family Foundation they established, have generously supported many significant civic activities and projects. Among them are a carillon and tower for their local Manitowish Waters Community Church, the purchase, landscaping and equipping of a public park, construction of the new Frank B. Koller Memorial Library in Manitowish Waters, a veterans memorial recognizing all area veterans of the armed services, and a permanent scholarship fund for a local high school student to attend a vocational school of his or her choice.

The library, elegantly designed for its northwoods setting, is recognized as the outstanding facility in the Northwest Wisconsin library system.

Recognizing the need for psychiatric care in the area, more recently the Koller Foundation established and funded the Frank B. Koller Outpatient Mental Health Center at the Howard Young Health Care Center in Woodruff, Wisc.

Their most recent contribution to fund graduate student training and research at



FRANK AND BETTY KOLLER, Leasure-Koller Cranberry Co. Inc., Manitowish Waters, Wisc., took a moment to pose during a reception recognizing their endowment of the Frank B. Koller Century II Cranberry Fund for graduate student education and research in the Department of Horticulture at the University of Wisconsin/Madison.

(Photo by Elden J. Stang)

UW/Madison recognizes the need for long-term support to ensure that the teachers, researchers and extension faculty of tomor-

row have a working knowledge of cranberries, one of the most important specialty crops of Wisconsin's agricultural economy.



*Lampert, Lee
& Associates*

**CONSULTING ENGINEERS
SURVEYORS**

Extensive experience in all aspects of cranberry land development: evaluation, purchase, survey, design, permit acquisition, phased construction and planting both in wetlands and uplands.

Have references. Will travel.

Contact: Will Lee
10948 Highway 54 East
Wisconsin Rapids, WI 54494
(715) 424-3131

TWO Century II Cranberry Funds, in the amount of \$150,000 each, were originally proposed as a part of the Horticulture 2000 Development Fund drive initiated at the start of the UW Department of Horticulture's Centennial celebration in October 1988. The Development Fund drive will continue through 1989 and beyond.

The Century II Cranberry Funds are specifically intended to provide support for graduate student education and research programs to benefit the Wisconsin cranberry industry.

Support for students is to be continuing and long-term well into the next century, since only the interest on the funds will be utilized. With current interest rates, at least \$150,000 is required to generate \$15,000 annual interest, the approximate amount needed to support a graduate student for one year.

Funds are managed by the University of Wisconsin Foundation. Research projects assigned to these graduate students will be reviewed for their applicability by a committee of Wisconsin cranberry growers and University of Wisconsin faculty.

THE very significant Koller family contribution is a major step toward completion of one of the Century II Cranberry funds. Other Wisconsin cranberry growers, including Newell and Helen Jaspersen, Habelman Brothers Cranberries Inc., R.S. Brazeau Cranberries Inc., Olson Brothers Cranberry Co. and Biron Cranberry Co., have also contributed generously to a second Century II fund.

A program is planned to recognize these contributions on completion of that second fund.

The department of horticulture expressed appreciation for the generosity of Wisconsin's cranberry industry as well as hope for continued contributions to complete both Century II funds at the earliest possible date.

Pump Repairs & Sales

All Types

- **Field Service**
- **Chemigation Equipment Sold**
- **Demonstration by Appointment**

**AAA Industrial
Pump Service Inc.**

Bruce Sunnerberg
66 Lake Street
Plympton, MA 02367
(617) 585-2394

Great Bog Sand?

Right from the Heart of Cranberry Country

Reserve your supply now for winter delivery (depending on ice) or we will stockpile at your bog anytime.

Very Competitive Price

Call Today

1-800-696-SAND

Casoll Sand & Gravel Inc.

P.O. Box 750

Hanson, MA 02341

WOLLSCHLAGER EXCAVATING

Dragline Work — All Kinds

Also Have Clam & Scalping Buckets

Route 1

Necedah, WI 54646

1-808-565-2436

Vines For Sale

Ben Lear \$5,000 a ton

Stevens \$4,000 a ton

Crowley \$4,000 a ton

Bergman \$4,000 a ton

Prices are F.O.B.

\$500 a ton less with 50% payment before cutting

Richberry Farms Ltd.

**11280 Mellis Drive
Richmond, B.C.
V6X 1L7 Canada**

**Res. (604) 273-4505
Bus. (604) 273-0777**

Cranberry Antiquing Enriches Their Appreciation of History



CHARLES Adams, collector of cranberry antiques, poses with a Makepeace scoop.

(CRANBERRIES photo by Carolyn Gilmore)

By CAROLYN GILMORE

For Charles and Barbara Adams, their avocation in antiques is an opportunity to travel, to research, to meet new people and to participate in history, both oral and written.

The Middleboro, Mass., couple are authorities on early American baskets and Bennington pottery, for which they are in demand as lecturers, suppliers of materials for books and appraisers. Antique cranberry equipment also figures in their stock.

Charles, who knows many Massachusetts growers, retired two years ago from Farm Family Insurance and now operates a general insurance company. Barbara has taught second grade for 33 years. Weekends find them antiquing anywhere from Vermont to Pennsylvania.

Charles said antique dealers "carry a lot of one-of-a-kind material. We spend a great deal of time searching sources."

A fondness for antiques grew out of a childhood closely associated with bogs.

"As a kid, I scooped bogs," the Middleboro man says. "My aunt was Vir-

ginia Washburn. The family had bogs on Rochester Road (South Carver)."

CHARLES has been cooperating with curator Mary Anne Thompson in setting up a cranberry museum in Chatsworth, N.J. Because he is always on the prowl for antiques, he has also been able to find old scoops, labels, long handle rakes, dibbles, historic books and the like for Massachusetts growers.

"Predominantly professional and better educated people" are interested in antiques, he noted. "It is a very expensive business and prices are hard . . . you buy something because you like it."

He finds that people around the country are interested in cranberries.

"A lot of people in other parts of the country have a historic heritage in New England," he said. "If their ancestors came from the Cape or Plymouth County, cranberries fall right in there."

MANAGERS, APPRAISERS HOLD 60TH CONVENTION

Seminars on American farm policy, trade and the environment highlighted the 60th annual gathering of the American Society of Farm Managers and Rural Appraisers (ASFMRA) in Savannah, Ga., recently.

About 800 members attended.

Founded in 1929, ASFMRA has some 4,000 members.

Mycogen Announces BlotoxIn Discovery

San Diego's Mycogen Corp. recently announced that company scientists have discovered novel strains of the bacteria *Bacillus thuringiensis* (B.t.) that are toxic to plant parasitic nematodes.

"Plant parasitic nematode control represents a potentially significant market with a clear need for alternative technologies," said Dr. Leo Kim, Mycogen's chief technical officer and vice president of research.

A recent Society of Nematologists survey found plant parasitic nematode damage exceeds \$77 billion annually.

WISCONSIN CRANBERRY HEADQUARTERS FOR SEVIN XLR



DEVRIKOL 10G • EVITAL • GUTHION
DIAZINON 14G • PARATHION • ETHREL

Cole/Grower Service

537 Atlas Ave., P.O. Box 7211, Madison, WI 53707
(608) 221-6204 or 1-800-362-8049

HYDRAULICS

- ★ Industrial Hydraulic Hose Assemblies & Fittings
- ★ Large Inventory of Hydraulic Filters
- ★ Engineering service for your special problems

- ★ O-Rings
- ★ Cylinder Repair & Rebuilding
- ★ Pumps, Motors, Valves

FREE ESTIMATES

WARD

HYDRAULICS, INC.



103 Middleboro Rd., E. Freetown, MA 02717

(508) 763-5567

SALES • SERVICE • ENGINEERING



**PINELANDS GETS PRAISE;
COURT VERDICT UPHELD**

During a recent visit to the Pinelands, New Jersey's cranberry growing region, U.S. Interior Secretary Manuel Lujan said the Pinelands Plan could become "a model for other places in the country."

Said Lujan: "For a long time I've had an interest in the whole Pinelands experiment, even when I was in Congress. It's a new way of preserving lands by good state and federal cooperation."

A New Jersey appeals court recently upheld a Superior Court judge's ruling in favor of the Pinelands Plan that restricts new, nonfarm housing to one home for every 40 acres in an Agricultural Production Area.

Landowner Hobart Gardner had contended that the restriction constituted a partial taking of his property. The appeals court said it was "satisfied that Pinelands farms are uniquely ecologically sensitive, and that measures fairly designed to bar unsuitably intensive development are thereby justified."

A fund for the reforestation of the Pinelands has been established by the Pinelands Commission in behalf of Kathleen M. Lynch Van de Sande, an environmental specialist with the commission who died in an auto accident. The resolution establishing the fund noted Van de Sande's "love of the New Jersey Pinelands and commitment to its preservation."

**Market Research Firm Says
Juice Industry Future Bullish**

Buoyed by a strong national interest in diet and fitness, the \$10.9 billion juice and juice-drink industry will continue to be healthy.

So said FIND/SVP, a market research and consulting firm, in a recent report.

The New York city company predicted growth over the next five years will equal the five year period from 1983 to 1988, when the overall market for fruit and vegetable juices and drinks grew by 35% from \$8 billion in sales.

Nonpowdered fruit and juice drinks are the fastest growing market segment. The category achieved a 17.8% compound annual growth rate from 1983 to 1988 and presently accounts for 23% of retail sales, while growth is expected to average from 6% to 7.5% a year through 1993. The report noted that sales of juice drinks are expected to exceed those of 100% pure fruit juices sometime within the next decade.

FIND/SVP attributes the fruit drink category's success to an increasing array of exotic flavors, more convenient packaging, such as single-serve containers, and a consumer preference for natural, "healthy" ingredients. At the same time, many consumers perceive 100% fruit juices as "heavy" and most regard them primarily as breakfast beverages, the report said.

Regionally, the strongest sales potential lies in the South and West, where current juice consumption is lowest. In the South, consumption of juices and juice drinks on a per capita basis is only half that of the Northeast, which boasts the highest nationwide consumption.

Adult female homemakers are still the primary target of juice advertising, the report noted. More than 80% of all households consume orange juice, which makes it the most widely consumed of any juice. Twenty percent of households are heavy users, consuming orange juice more than twice a week. The report also found that 20% of all households regularly consume fruit juices or drinks other than orange juice.

CRANBERRIES

from

A

to

Z



by Ann Kurz

An Educational Picture Book

32 pages of colorful watercolor paintings of blossoms, berries, harvesting, winter and summer scenes depicting all aspects of cranberry culture, equipment and lore with accompanying short text. The large letters are appropriate for children. Every age child and adult can learn from this book. The glossary of cranberry terms will allow adults to enrich the educational experience.

*"A classic book!" - Dr. Donald Boone
International Cranberry Consultant*

Author/Artist Ann Kurz is noted nationally among cranberry growers for her accurate portrayal and knowledge of cranberry culture.

\$13.95 plus \$2 shipping & handling

send check or money order to:
CRANBERRIES
P.O. Box 249
Cobalt, CT 06414

Name
Address
City State Zip



Cape Cod Jam

This recipe is reprinted from The Cranberry Connection: Cranberry Cookery with Flavour, Fact and Folklore by Beatrice Ross Buszek.

3/4 lb. gooseberries
1/2 lb. cranberries
3 cups sugar
1/2 lb. cooking apples
1 lemon

Remove cases from gooseberries before weighing. Put fruit in large

saucepan and crush with potato masher. Sprinkle half of sugar over the fruit. Cover and stand overnight to draw out the juice. Next day add peeled, cored, finely chopped apple and bring to boil. Add remaining sugar and juice of the lemon and boil steadily until jam will set when tested. Pour into warm, dry jars and seal when

cooled.

This recipe makes a splendid gift

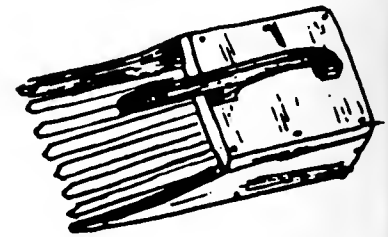

General Excavating

Pond Construction & Maintenance
Land Clearing, Ditching, Canal Work

Dragline (63' reach) & Clamshell
Gradall 6' Bucket *D-8 Dozer*
Road Grader

Bill Conway
228 W. Britannia St.
Taunton, MA 02780
(508) 822-1085

K Ag Laboratories International, Inc.

2323 Jackson Street
Oshkosh, WI 54901

Serving Cranberry
Growers in U.S.A.
& Canada since 1984

Over 20 years
of Experience on
Acid Soil Interaction

K Ag Laboratory has
run over 30,000
cranberry soil and over
17,500 cranberry vines
tests since 1984, and
gave fertilizer
recommendations with
great success.

- ★ *Cranberry Soil Analysis*
- ★ *Cranberry Vine Analysis*
- ★ *Cranberry Water Analysis, Usage & Interpretation*
- ★ *Liquid & Dry Fertilizer Recommendation*
- ★ *Soil Problems & Consultation*
- ★ *Seminars*
- ★ *Cranberry Crop Monitoring Program, testing and monitoring nutrient status with 30 day intervals during the growing season.*

Highly computerized cranberry soil, tissue and water testing program in U.S.A. and Canada.

For more information contact: **Dr. Akhtar Khwaja, Ph.D.**
Certified Professional Soil Scientist
Certified Professional Agronomist

Phone Number 414-426-2220; Out of WI 1-800-356-6045; FAX 414-426-2664



***For Reliable Dredges and Pumps,
Cranberry Growers Look to Crisafulli***

Your Crisafulli pumping equipment will be manufactured just for you, with your choice of power options and discharge size. If you need to dredge sand, call us for quotations and specifications. We will supply you with exactly what you need, not something designed for somebody else! For information, quotations, local representation, call:

1-800-442-7867

or FAX 406-365-8088

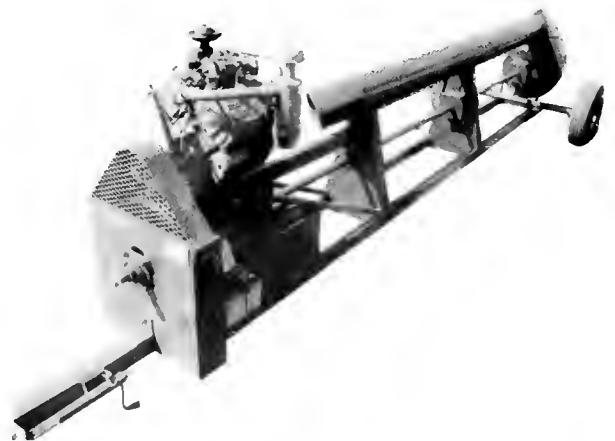

Take Good Care of Yourself Have an Ocean Spray!



The farmer's cooperative that brings you
a wide range of natural fruit juices, drinks and sauces

Ocean Spray Cranberries, Inc., Lakeville-Middleboro, MA 02349

An Equal Opportunity Employer

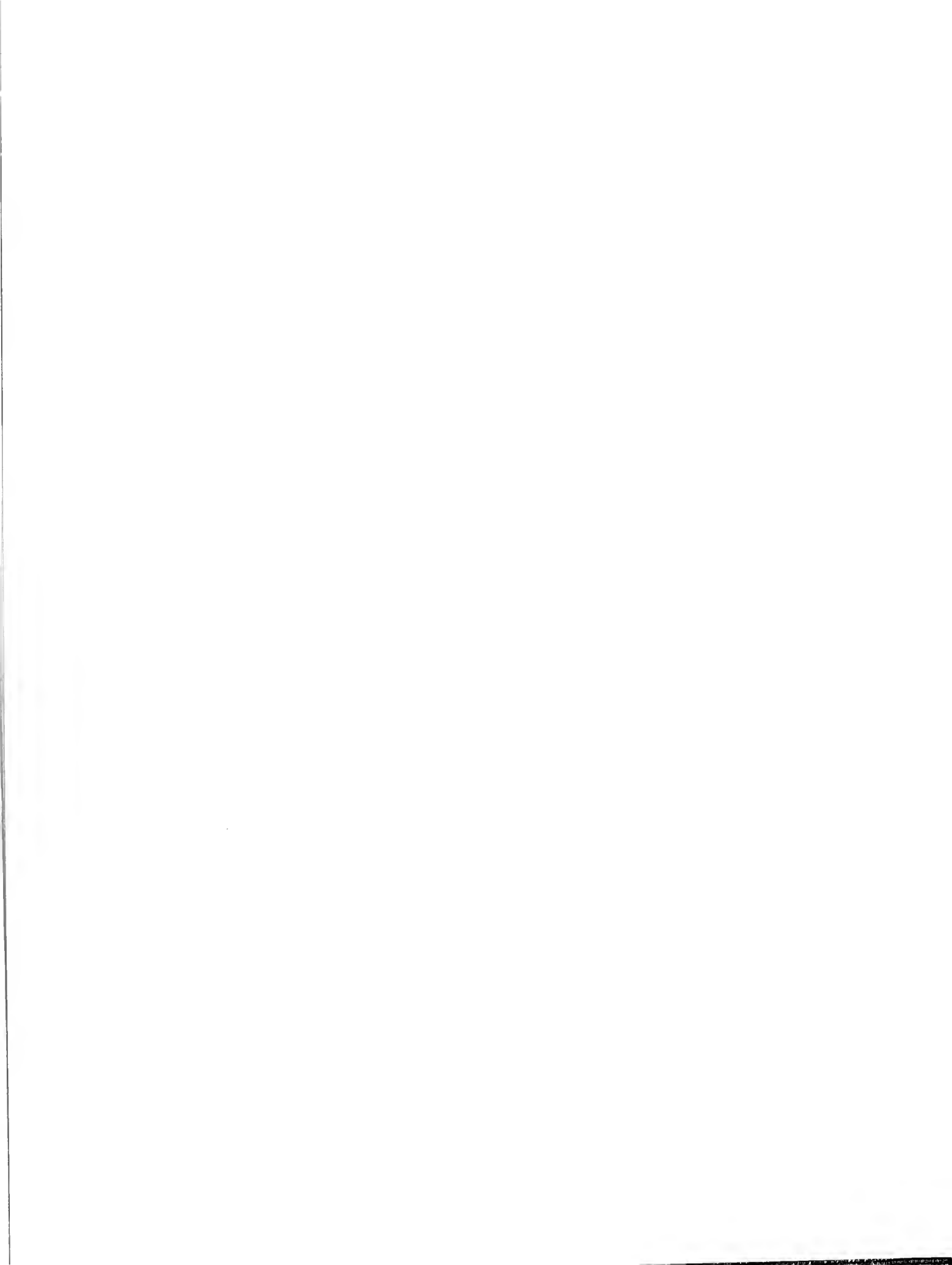

W. H. C. B. & C. CO. INC.

DEC 5 1934

100 CANAL STREET
NEW YORK, N. Y.

