

# CREAMERY BUTTER-MAKING

---

MICHELS

The D. H. Hill Library



North Carolina State College

SF263

M6

NORTH CAROLINA STATE UNIVERSITY LIBRARIES



S01949427 -

Date Due

AP 26 '24		
MY 19 '24	DEC - 1 1982	
UN 8 '31		
Dec 18 '31		
Jun 3 '32		
Jan 19 '33		
29 Oct 34		
20 Mar 35		
24 Jan '38		
8 Jul '48		
22 JI '48S		
26 JI '48S		
14 Oct 52 v		

4372





a. Skim milk.

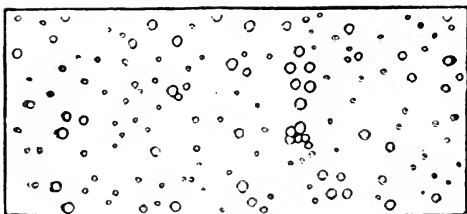

b. Milk.

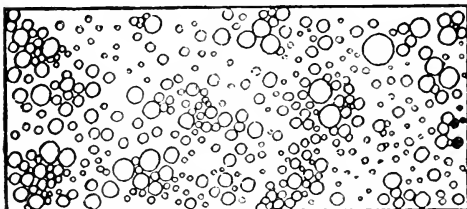

c. Cream.

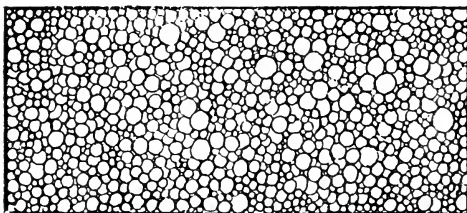

d. Colostrum.

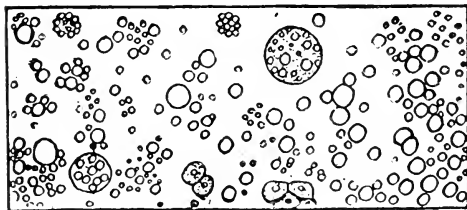

Fat globules magnified 300 times. (U. S. Farmers' Bulletin 42.)

# CREAMERY BUTTER-MAKING

BY

JOHN MICHELS, B. S. A., M. S.

Professor of Dairying and Animal Husbandry in the New York  
State School of Agriculture

Author of "Dairy Farming," "Market Dairying and Milk  
Products"

EIGHTH EDITION, REVISED

*ILLUSTRATED*

FARMINGDALE, NEW YORK

Published by the Author

1914

*All Rights Reserved*

COPYRIGHT, 1904, 1909 AND 1911  
BY JOHN MICHELS





## PREFACE TO FIRST EDITION

The author's experience in teaching creamery students has demonstrated to him the need of a suitable reference book to be used in conjunction with the lectures on creamery butter making. An attempt to supply this need has resulted in the preparation of this work, which embodies the results of a long experience both as a practical butter maker and as a teacher of creamery management.

Special emphasis has been laid upon starters, pasteurized butter making, methods of creamery construction, and creamery mechanics, subjects which have usually been treated only in a very elementary way in similar publications that have appeared heretofore.

The historical side of the various phases of butter making has in the main been omitted, not because it was deemed uninteresting, but for fear of making this volume too bulky.

With the appended glossary explaining all unavoidable technical terms, this treatise is offered to the public as a suitable hand-book for the student as well as for the butter maker who cannot attend a dairy school.

JOHN MICHELS.

Michigan Agricultural College,

March, 1904.

## PREFACE TO SIXTH EDITION

In preparing the sixth edition of Creamery Buttermaking, a thorough revision has been made of the entire book, and six new chapters have been added. The new chapters are: "Creamery Ice Cream Making," "Eggs As a Creamery Side Line," "Creamery By-Products," "Advice To Young Buttermakers," "Gasoline Power" and "Determination of Salt in Butter."

Nothing has been left undone to bring the book strictly up-to-date in every particular. All available sources of information have been made use of, including scores of leading buttermakers and creamery managers whose assistance has been especially valuable in determining the soundness of many new features that have recently sprung up in creamery work. Much information relating to the latest developments in creamery work has been secured at first hand by visiting the leading creamery sections of the country.

The general adoption of the book as a text and reference book in American Dairy Schools and the warm reception that has been accorded it in foreign dairy countries, naturally has been a source of much satisfaction to the author and has prompted him more than ever to leave nothing undone in the present revision to make the book worthy of the confidence in which it is being held.

## INTRODUCTION.

The "rule of thumb" butter making days are gone by. No one at the present time can hold any important position in the profession of butter making unless thoroughly grounded in the principles that underlie it. It is true many obscure problems yet remain to be solved, but by the aid of the bacteriologist and chemist butter making has now been fairly placed upon a scientific basis.

Bacteriology has shed no less light upon the various processes involved in the manufacture of butter than it has upon the nature and causes of the diseases with which mankind is afflicted. The souring of milk, the ripening of cream, the causes of the various taints common to milk and cream are now quite thoroughly understood. Along with this understanding have come many radical changes in the handling of milk and cream and their manufacture into butter as well as in the handling of butter itself.

The best butter makers at the present time are the men who are the most diligent students of bacteria and their relation to butter making processes. Above their doors is written in emblazoned letters "Cleanliness is next to Godliness." For cleanliness is the foundation of success in butter making.

•



## TABLE OF CONTENTS.

		Page.
Chapter	I. Chemical and Physical Properties of Milk .....	11
Chapter	II. The Babcock Test.....	23
Chapter	III. The Lactometer and Its Use.....	34
Chapter	IV. Bacteria and Milk Fermentations.....	42
Chapter	V. Composite Sampling .....	51
Chapter	VI. Creaming .....	57
Chapter	VII. Cream Ripening .....	66
Chapter	VIII. Starters .....	84
Chapter	IX. Churning .....	96
Chapter	X. Packing and Marketing Butter.....	111
Chapter	XI. Calculating Dividends .....	119
Chapter	XIa. Actual Overrun .....	127
Chapter	XII. Theoretical Overrun .....	128
Chapter	XIII. Handling of Skim-milk and Buttermilk	130
Chapter	XIV. Butter Judging .....	137
Chapter	XV. Pasteurization as Applied to Butter-making .....	145
Chapter	XVI. Control of Water in Butter .....	154
Chapter	XVII. Sampling, Weighing and Testing Gathered Cream .....	161
Chapter	XVIII. Location and Construction of Creameries .....	171
Chapter	XIX. Ice House and Refrigerator.....	182
Chapter	XX. Sewage Disposal .....	188
Chapter	XXI. Washing and Sterilizing Vessels.....	194
Chapter	XXII. Detection of Tainted Milk and Cream	200
Chapter	XXIII. Mechanical Refrigeration .....	205
Chapter	XXIV. Creamery Book-keeping .....	215
Chapter	XXV. Co-operative Creameries .....	224
Chapter	XXVI. Handling Milk and Cream at the Farm	230
Chapter	XXVII. Sanitary Milk Production.....	241

		Page.
Chapter	XXVIII.	Transportation of Cream..... 251
Chapter	XXIX.	Water Supply for Farm and Creamery 256
Chapter	XXX.	Marketing Cream ..... 262
Chapter	XXXI.	Grading Milk and Cream..... 267
Chapter	XXXII.	Creamery Mechanics ..... 272
Chapter	XXXIII.	Creamery Ice Cream Making..... 307
Chapter	XXXIV.	Eggs as a Creamery Side Line..... 317
Chapter	XXXV.	Creamery By-Products ..... 326
Chapter	XXXVI.	Advice to Young Buttermakers..... 333
Chapter	XXXVII.	Gasoline Power ..... 339
Chapter	XXXVIII.	Determination of Salt in Butter..... 343
	Appendix	..... 345
	Glossary	..... 352
	Index	..... 357

# CREAMERY BUTTER MAKING.

## CHAPTER I.

### CHEMICAL AND PHYSICAL PROPERTIES OF MILK.

Milk, in a broad sense, may be defined as the normal secretion of the mammary glands of animals that suckle their young. It is the only food found in Nature containing all the elements necessary to sustain life. Moreover it contains these elements in the proper proportions and in easily digestible and assimilable form.

Designed by Nature to nourish the young, milk was originally used entirely for this purpose and secreted only a short time after parturition. For many centuries, however, it has been

used as an important part of the human dietary and cows at the present time yield milk almost incessantly. Because of its nutritive qualities its use as a dietetic is rapidly increasing.

**Physical Properties.** Milk is a whitish opaque fluid possessing a sweetish taste and a faint odor suggestive of cow's breath. It has an amphoteric reaction, that is,

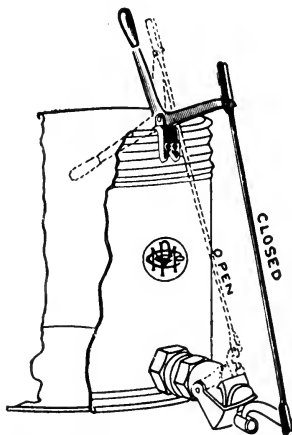

Weigh can showing gate opener.

it is both acid and alkaline. This double reaction is due largely to acid and alkaline salts and possibly to small quantities of organic acids.

Milk has an average normal specific gravity of 1.032, with extremes rarely exceeding 1.029 and 1.033. After standing a few moments it loses its homogenous character. Evidence of this we have in the "rising of the cream." This is due to the fact that milk is not a perfect solution but an *emulsion*. All of the fat, the larger portion of the casein, and part of the ash are in suspension.

In consistency milk is slightly more viscous than water, the viscosity increasing with the decrease in temperature. It is also exceedingly sensitive to odors, possessing great absorption properties. This teaches the necessity of placing milk in clean pure surroundings.

**Chemical Composition.** The composition of milk is very complex and variable, as will be seen from the following figures:

*Average Composition of Normal Milk. A compilation of figures from various American Experiment Stations.*

Water .....	87.1%
Butter fat .....	3.9%
Casein .....	2.9%
Albumen .....	.5%
Sugar .....	4.9%
Ash .....	.7%
Fibrin .....	Trace.
Galactase .....	Trace.
	<hr/>
	100.0%

The great variations in the composition of milk are shown by the figures from Koenig, given below:



	<i>Maximum.</i>	<i>Minimum.</i>
Water .....	90.69	80.32
Fat .....	6.47	1.67
Casein .....	4.23	1.79
Albumen .....	1.44	.25
Sugar .....	6.03	2.11
Ash .....	1.21	.35

These figures represent quite accurately the maximum and minimum composition of milk except that the maximum for fat is too low. The author has known cows to yield milk testing 7.6% fat, and records show tests even higher than this.

BUTTER FAT.

This is the most valuable as well as the most variable constituent of milk. It constitutes about 83% of butter and is an indispensable constituent of the many kinds of whole milk cheese now found upon the market. It also measures the commercial value of milk and cream, and is used as an index of the value of milk for butter and cheese production.

**Physical Properties.** Butter fat is suspended in milk in the form of extremely small globules numbering about 100,000,000 per drop of milk. These globules vary considerably in size in any given sample, some being five times as large as others. The size of the globules is affected mostly by the period of lactation. As a rule the size decreases and the number increases with the advance of the period. In strippers' milk the globules are sometimes so small as to render an efficient separation of the cream and the churning of same impossible.

The size of the fat globules also varies with different breeds. In the Jersey breed the diameter of the globule

is one eight-thousandth of an inch, in the Holstein one twelve-thousandth, while the average for all breeds is about one ten-thousandth.

Night's milk usually has smaller globules than morning's. The size of the globules also decreases with the age of the cow.

The density or specific gravity of butter fat at 100° F. is .91 and is quite constant. Its melting point varies between wide limits, the average being 92° F.

**Composition of Butter Fat.** According to Richmond, butter fat has the following composition:

Butyrin .....	3.85	} Soluble or volatile.
Caproin .....	3.60	
Caprylin .....	.55	
Caprin .....	1.90	} Insoluble or non-volatile.
Laurin .....	7.40	
Myristin .....	20.20	
Palmitin .....	25.70	
Stearin .....	1.80	
Olein, etc.....	35.00	

This shows butter fat to be composed of no less than nine distinct fats, which are formed by the union of glycerine with the corresponding fatty acids. Thus, butyrin is a compound of glycerine and butyric acid; palmitin, a compound of glycerine and palmitic acid, etc. The most important of these acids are palmitic, oleic, and butyric.

Palmitic acid is insoluble, melts at 144° F., and forms (with stearic acid) the basis of hard fats.

Oleic acid is insoluble, melts at 57° F., and forms the basis of soft fats.

Butyric acid is soluble and is a liquid which solidifies at  $-2^{\circ}$  F. and melts again at  $28^{\circ}$  F.

**Insoluble Fats.** A study of these fats is essential in elucidating the variability of the churning temperature of cream. As a rule this is largely determined by the relative amounts of hard and soft fats present in butter fat. Other conditions the same, the harder the fat the higher the churning temperature. Scarcely any two milks contain exactly the same relative amounts of hard and soft fats, and it is for this reason that the churning temperature is such a variable one.

The relative amounts of hard and soft fats are influenced by:

1. Breeds.
2. Feeds.
3. Period of lactation.
4. Individuality of cows.

The butter fat of Jerseys is harder than that of Holsteins and, therefore, requires a relatively high churning temperature, the difference being about six degrees.

Feeds have an important influence upon the character of the butter fat. Cotton seed meal and bran, for example, materially increase the percentage of hard fats. Gluten feeds and linseed meal, on the other hand, produce a soft butter fat.

With the advance of the period of lactation the percentage of hard fat increases. This chemical change, together with the physical change which butter fat undergoes, makes churning difficult in the late period of lactation.

The individuality of the cow also to a great extent influences the character of the butter fat. It is inherent

in some cows to produce a soft butter fat, in others to produce a hard butter fat, even in cows of the same breed.

**Soluble Fats.** The soluble or volatile fats, of which butyric is the most important, give milk and sweet cream butter their characteristic flavors. Butyric is found only in butter fat and distinguishes this from all vegetable and other animal fats.

The percentage of soluble fats decreases with the period of lactation, also with the feeding of dry feeds and those rich in protein. Succulent feeds and those rich in carbohydrates, according to experiments made in Holland and elsewhere, increase the percentage of soluble fats. This may partly account for the superiority of the flavor of June butter.

It may be proper, also, to discuss under volatile or soluble fats those abnormal flavors that are imparted to milk, cream, and butter by weeds like garlic and wild onions, and by various feeds such as beet tops, rape, partially spoiled silage, etc. These flavors are undoubtedly due to abnormal volatile fats.

Cows should never be fed strong flavored feeds shortly before milking. When this is done the odors are sure to be transmitted to the milk and the products therefrom. When, however, feeds of this kind are fed shortly after milking no bad effects will be noticed at the next milking.

**Albumenoids.** These are nitrogenous compounds which give milk its high dietetic value. Casein, albumen, globulin, and nuclein form the albumenoids of milk, the casein and albumen being by far the most important.

**Casein.** This is a white colloidal substance, possessing neither taste nor smell. It is the most important tissue-forming constituent of milk and forms the basis of an almost endless variety of cheese.

The larger portion of the casein is suspended in milk in an extremely finely divided amorphous condition. It is intimately associated with the insoluble calcium phosphate of milk and possibly held in chemical combination with this. Its study presents many difficulties, which leaves its exact composition still undetermined.

Casein is easily precipitated by means of rennet extract and dilute acids, but the resulting precipitates are not identically the same. It is not coagulated by heat.

**Albumen.** In composition albumen very closely resembles casein, differing from this only in not containing sulphur. It is soluble and unaffected by rennet, which causes most of it to pass into the whey in the manufacture of cheese. It is coagulated at a temperature of 170° F. It is in their behavior toward heat and rennet that casein and albumen radically differ.

**Milk Sugar.** This sugar, commonly called lactose, has the same chemical composition as cane sugar, differing from it chiefly in possessing only a faint sweetish taste. It readily changes into lactic acid when acted upon by the lactic acid bacteria. This causes the ordinary phenomenon of milk souring. The maximum amount of acid in milk rarely exceeds .9%, the germs usually being checked or killed before this amount is formed. There is therefore always a large portion of the sugar left in sour milk. All of the milk sugar is in solution.

**Ash.** Most of the ash of milk exists in solution. It is composed of lime, magnesia, potash, soda, phosphoric acid, chlorine, and iron, the soluble lime being the most important constituent. It is upon this that the action of rennet extract is dependent. For when milk is heated to high temperatures the soluble lime is rendered insoluble and rennet will no longer curdle milk. It seems also that

the viscosity of milk and cream is largely due to soluble lime salts. Cream heated to high temperatures loses its viscosity to such an extent that it can not be made to "whip." Treatment with soluble lime restores its original viscosity. The ash is the least variable constituent of milk.

**Colostrum Milk.** This is the first milk drawn after parturition. It is characterized by its peculiar odor, yellow color, broken down cells, and high content of albumen which gives it its viscous, slimy appearance and causes it to coagulate on application of heat.

According to Eugling the average composition of colostrum milk is as follows:

Water .....	71.69%
Fat .....	3.37
Casein .....	4.83
Albumen .....	15.85
Sugar .....	2.48
Ash .....	1.78

The secretion of colostrum milk is of very short duration. Usually within four or five days after calving it assumes all the properties of normal milk. In some cases, however, it does not become normal till the sixth or even the tenth day, depending largely upon the condition of the animal.

A good criterion in the detection of colostrum milk is its peculiar color, odor, and slimy appearance. The disappearance of these characteristics determines its fitness for butter production.

**Milk Secretion.** Just how all of the different constituents of milk are secreted is not yet definitely understood. But it is known that the secretion takes

place in the udder of the cow, and principally during the process of milking. Further, the entire process of milk elaboration seems to be under the control of the nervous system of the cow. This accounts for the changes in flow and richness of milk whenever cows are subjected to abnormal treatment. It is well known that a change of milkers, the use of rough language, or the abuse of cows with dogs and milk stools, seriously affects the production of milk and butter fat. It is therefore of the greatest practical importance to milk producers to treat cows as gently as possible, especially during the process of milking.

**How Secreted.** The source from which the milk constituents are elaborated is the blood. It must not be supposed, however, that all the different constituents already exist in the blood in the form in which we find them in milk, for the blood is practically free from fat, casein, and milk sugar. These substances must then be formed in the cells of the udder from material supplied them by the blood. Thus there are in the udder cells that have the power of secreting fat in a manner similar to that by which the gastric juice is secreted in the stomach. Similarly, the formation of lactose is the result of the action of another set of cells whose function is to produce lactose. It is believed that the casein is formed from the albumen through the activity of certain other cells. The water, albumen, and soluble ash probably pass directly from the blood into the milk ducts by the process known as osmosis.

**Variations in the Quality of Milk.** Milk from different sources may vary considerably in composition, particularly in the percentage of butter fat. Even the

milk from the same cow may vary a great deal in composition. The causes of these variations may be assigned to two sets of conditions: I.—Those natural to the cow. II.—Those of an artificial nature.

#### I. QUALITY OF MILK AS AFFECTED BY NATURAL CONDITIONS.

1. The composition of the milk of all cows undergoes a change with the advance of the period of lactation. During the first five months the composition remains practically the same. After this, however, the milk becomes gradually richer until the cow “dries up.” The following figures from Van Slyke illustrate this change:

<i>Month of lactation.</i>	<i>Per cent of fat in milk.</i>
1.....	4.54
2.....	4.33
3.....	4.28
4.....	4.39
5.....	4.38
6.....	4.53
7.....	4.56
8.....	4.66
9.....	4.79
10.....	5.00

It will be noticed from these figures that the milk actually decreases somewhat in richness during the first three months of the period. But just before the cow dries up, it may test as high as 8%.

2. The quality of milk also differs with different breeds. Yet breed differences are less marked than those of the individual cows of any particular breed.

Some breeds produce rich milk, others relatively poor



milk. The following data obtained at the New Jersey Experiment Station illustrates these differences:

Breed.	Total Solids.	Fat.	Milk Sugar.	Proteids.	Ash.
	Per cent.	Per cent.	Per cent.	Per cent.	Per cent.
Ayshire.....	12.70	3.68	4.84	3.48	.69
Guernsey .....	14.48	5.02	4.80	3.92	.75
Holstein .....	12.12	3.51	4.69	3.28	.64
Jersey.....	14.34	4.78	4.85	3.96	.75

3. Extremes in the composition of milk are usually to be ascribed to the individuality or "make up" of the cow. It is inherent in some cows to produce rich milk, in others to produce poor milk. In other words, Nature has made every cow to produce milk of a given richness, which can not be perceptibly changed except by careful selection and breeding for a number of generations.

## II. QUALITY OF MILK AS AFFECTED BY ARTIFICIAL CONDITIONS.

1. When cows are only partially milked they yield poorer milk than when milked clean. This is largely explained by the fact that the first drawn milk is always poorer in fat than that drawn last. Fore milk may test as low as .8%, while the strippings sometimes test as high as 14%.

2. Fast milking increases both the quality and the quantity of the milk. It is for this reason that fast milkers are so much preferred to slow ones.

3. The richness of milk is also influenced by the length of time that elapses between the milkings. In general, the shorter the time between the milkings the richer the milk. This, no doubt, in a large measure accounts for the differences we often find in the richness of morning's and night's milk. Sometimes the morning's milk is the richer, at other times the evening's, depending largely upon the time of day the cows are milked. Milk can not, however, be permanently enriched by milking three times in stead of twice a day.

4. Unusual excitement of any kind reduces the quality of milk. The person who abuses cows by dogs, milk stools, or boisterousness, pays dearly for it in a reduction of both the quality and the quantity of milk produced.

5. Starvation also seriously affects both the quality and the quantity of milk. It has been repeatedly shown, in this country and in Europe, that under-feeding to any great extent results in the production of milk poor in fat.

6. Sudden changes of feed may slightly affect the richness of milk, but only temporarily.

So long as cows are fed a full ration, it is not possible to change the richness of milk permanently, no matter what the character of feed composing the ration.

7. Irregularities of feeding and milking, exposure to heat, cold, rain, and flies, tend to reduce both the quantity and the quality of milk produced.

## CHAPTER II.

### THE BABCOCK TEST.

This is a cheap and simple device for determining the percentage of fat in milk, cream, skim-milk, buttermilk, whey, and cheese. It was invented in 1890 by Dr. S. M. Babcock, of the Wisconsin Agricultural Experiment Station, and ranks among the leading agricultural inventions of modern times. The chief uses of the Babcock test may be mentioned as follows:

1. It has made possible the payment for milk according to its quality.
2. It has enabled butter and cheese makers to detect undue losses in the process of manufacture.
3. It has made possible the grading up of dairy herds by locating the poor cows.
4. It has, in a large measure, done away with the practice of watering and skimming milk.

**Principle of the Babcock Test.** The separation of the butter fat from milk with the Babcock test is made possible:

1. By the difference between the specific gravity of butter fat and milk serum.
2. By the centrifugal force generated in the tester.
3. By burning the solids not fat with a strong acid.

**Sample for a Test.** Whatever the sample to be tested, always eighteen grams are used for a test. In testing cream and cheese, the sample is weighed. For testing milk, skim-milk, buttermilk, and whey, weighing requires

too much time. Indeed, with these substances weighing is not necessary as sufficiently accurate samples are ob-

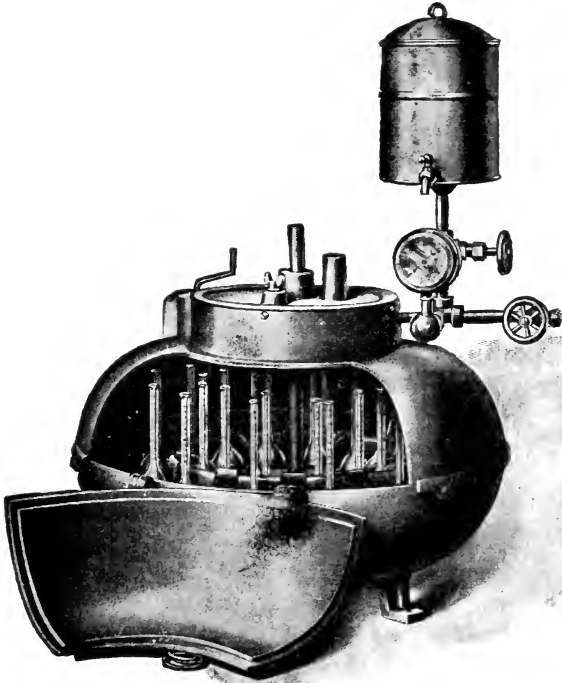

Fig. 1.—Babcock tester.

tained by measuring which is the method universally employed. In making a Babcock test it is of the greatest importance to secure a uniform sample of the substance to be tested.

**Apparatus.** This consists essentially of the following parts: A, Babcock tester; B, milk bottle; C, cream bottle; D, skim-milk bottle; E, pipette or milk measure; F, acid measures; G, cream scales; H, mixing cans; I, dividers.

**A. Babcock Tester.** This machine, shown in Fig. 1, consists of a revolving wheel placed in a horizontal position and provided with swinging pockets for the bottles. This wheel is rotated by means of a steam turbine wheel in the bottom or at the top of the tester. When the tester stops the pockets hang down allowing the bottles to stand up. As the wheel begins rotating the pockets move out causing the bottles to assume a horizontal position. Both wheels are enclosed in a cast iron frame provided with a cover.

**B. Milk Bottle.** This has a neck graduated to ten large divisions, each of which reads one per cent. Each large division is subdivided into five smaller ones, making each subdivision read .2%. The contents of the neck from the zero mark to the 10% mark is equivalent to two cubic centimeters. Since the Babcock test does not give the percentage of fat by volume but by weight, the 10% scale on the neck of the bottle will, therefore, hold 1.8 grams of fat. In other words, if the scale were filled with water it would hold two grams; but fat being only .9 as heavy, 2 cubic centimeters of it would weigh nine-tenths of two grams or 1.8 grams. This is exactly 10% of 18 grams, the weight of the sample used for testing. A milk bottle is shown in Fig. 2.

**C. Cream Bottles.** These are graduated from 30% to 55%. A 30% bottle is shown in Fig. 3. Since cream usually tests more than 30%, the sample must be divided when the 30% bottles are used. See p. 167.



Fig. 2.—Milk bottle.



Fig. 3.—Cream bottle.

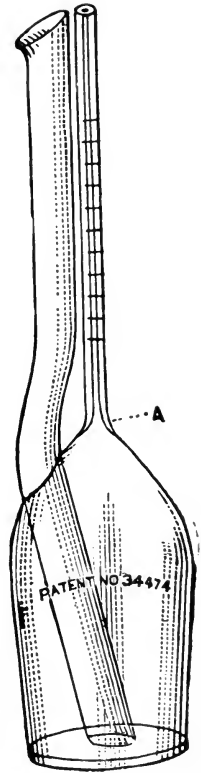

Fig. 4.—Skim-milk bottle.

**D. Skim-milk Bottle.** This bottle, shown in Fig. 4. is provided with a double neck, a large one to admit the milk, and a smaller graduated neck for fat reading. The entire scale reads one-half per cent. Being divided into ten subdivisions each subdivision reads .05%. The same bottle is also used for testing buttermilk.



Fig. 5.—Pi-  
pette.



Fig. 6.—  
Acid meas-  
ure.



Fig. 7 --  
Acid meas-  
ure.

**E. Pipette.** This holds 17.6 c.c., as shown in Fig. 5. Since about .1 c.c. of milk will adhere to the inside of the pipette it is expected to deliver only 17.5 c.c., which is equivalent to 18 grams of normal milk.

**F. Acid Measures.** In making a Babcock test equal quantities, by volume, of acid and milk are used. The acid measure, shown in Fig. 6, holds 17.5 c.c. of acid, the amount needed for one test. The one shown in Fig. 7 is divided into six divisions, each of which holds 17.5 c.c. or one charge of acid. Where

many tests are made a graduate of this kind saves time in filling, but should be made to hold twenty-five charges.

**H.** A cream scales commonly used is illustrated in Fig. 8.

**Acid.** The acid used in the test is commercial sul-

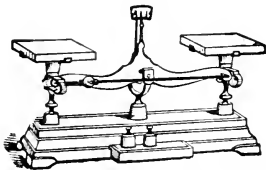

Fig. 8.—Cream Scales. (See pp. 167 and 168.)

phuric acid having a specific gravity of 1.82 to 1.83. When the specific gravity of the acid falls below 1.82 the milk solids are not properly burned and particles of curd may appear in the fat. On the other hand, an acid with a specific gravity above 1.83 has a tendency to blacken or char the fat.

The sulphuric acid, besides burning the solids not fat, facilitates the separation of the fat by raising the specific gravity of the medium in which it floats.

Sulphuric acid must be kept in glass bottles provided with glass stoppers. Exposure to the air materially weakens it.

**Making a Babcock Test.** The different steps are indicated as follows:

1. Thoroughly mix the sample.
2. Immediately after mixing insert the pipette into the milk and suck until the milk has gone above the mark on the pipette, then quickly place the fore finger over the



Fig. 9.—Showing manner of emptying pipette.



top and allow the milk to run down to the mark by slowly relieving the pressure of the finger.

3. Empty the milk into the bottle in the manner shown in Fig. 9.

4. Add the acid in the same manner in which the milk was emptied into the bottle.

5. Mix the acid with the milk by giving the bottle a slow rotary motion.

6. Allow mixture to stand a few minutes.

7. Shake or mix again and then place the bottle in the tester.

8. Run tester four minutes at the proper speed.

9. Add moderately hot water until contents come to the neck of the bottle.

10. Whirl one minute.

11. Add moderately hot water until contents of the bottle reach about the 8% mark.

12. Whirl one minute.

13. Leave tester open a few minutes.

14. Read test.

**How to Read Milk Tests.** At the top of the fat column is usually quite a pronounced meniscus as shown in Fig. 10. A less pronounced one is found at the bottom of the column. The fat should be read from the extremes of the fat column, 1 to 3, not from 2 to 4, when its temperature is about 140° F. Too high a temperature gives too high

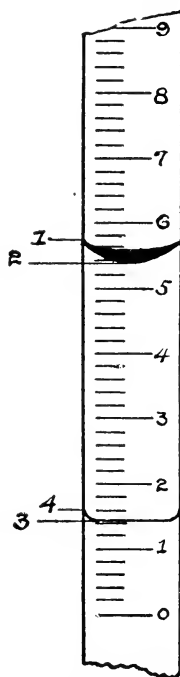

Fig. 10.—Fat column showing menisci.

a reading, because of the expanded condition of the fat, while too low a temperature gives an uncertain reading.

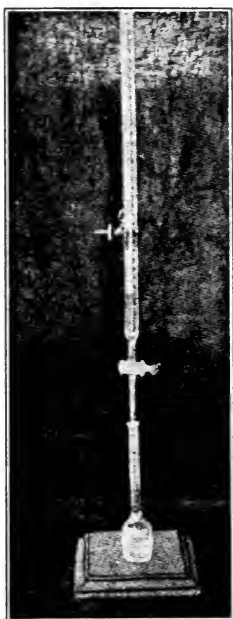

Fig. 11. Burette method.



Fig. 12.—Milk bottle tester.

**Precautions in Making a Test.** 1. Be sure you have a fair sample.

2. The temperature of the milk should be about 60 or 70 degrees.

3. Always mix twice after acid has been added.

4. Be sure your tester runs at the right speed.

5. Use nothing but clean, soft water in filling the bottles.
6. Be sure the tester does not jar.
7. Be sure the acid is of the right strength.
8. Mix as soon as acid is added to milk.
9. Do not allow the bottles to become cold before reading the test.
10. Read the test twice to insure a correct reading.

The water added to the test bottles after they have been whirled should be clean and pure. Water containing much lime seriously affects the test. Such water may be used, however, when first treated with a few drops of sulphuric acid.

As stated before skim-milk, buttermilk, and cream are tested in the same way as milk, with the exception that the cream sample is weighed not measured.

**Cleaning Test Bottles.** As soon as the test is read, the bottles are emptied by shaking them up and down so as to remove the white sediment. Next wash them in hot water containing some alkali, and finally rinse them with hot water. Occasionally the bottles should be rinsed with a special cleaning solution, which is made by dissolving about one ounce of potassium bichromate in one pint of sulphuric acid. A small brush should also occasionally be run up and down the neck of the bottle.

**Testing or Calibrating Milk Bottles.** Fill the bottle to the zero mark with water, or preferably wood alcohol to which a little coloring matter has been added. Immerse the lower section of the tester, shown in Fig. 12, in the contents of the bottle. If the bottle is correct, the contents will rise to the 5% mark. Next immerse both sections of the tester which will bring the contents to the 10% mark if the bottle is correctly calibrated.

It has been learned that the volume of the graduated part of the neck is 2 c.c. Each section of the tester is made to displace 1 c.c. when immersed in the liquid, hence the two sections will just fill the scale if the latter is correct.

The method recommended below for calibrating cream bottles may also be used with milk bottles.

**Calibrating Cream Bottles.** According to Hunziker,\* the most satisfactory method of calibrating cream test bottles is as follows (see Fig. 11): Fill the bottle to the zero mark with water. Remove any drops adhering to the inside of the neck with a coiled piece of filter or blotting paper. Now slowly add measured amounts of water from an accurate burette graduated to at least 0.1 c.c. Every 0.1 c.c. of water run into the neck is equivalent to 0.5% on the scale of an 18 gram cream bottle and 1.0% on a 9 gram cream bottle. That is, with an 18 gram 30% bottle, 6 c.c. of water would be required to exactly fill the scale on the neck.

In calibrating milk and cream bottles, different parts of the neck should be tested as well as the neck as a whole.

**Calculating Speed of Tester.** The speed at which a tester must be run is dependent upon the diameter of the wheel carrying the bottles. The larger this wheel the fewer the revolutions it must make per minute to effect a complete separation of the fat.

In the following table by Farrington and Woll the necessary speed per given diameter is calculated:

---

\*Bulletin No. 145, Indiana Experiment Station.

<i>Diameter of wheel in inches.</i>	<i>No. of revolutions of wheel per minute.</i>
10 .....	1,074
12 .....	980
14 .....	909
16 .....	848
18 .....	800
20 .....	759
22 .....	724
24 .....	693

**General Pointers.** Black fat is caused by

1. Too strong acid.
2. Too much acid.
3. Too high a temperature of the acid or the milk.
4. Not mixing soon enough.
5. Dropping the acid through the milk.

Foam on top of fat is caused by hard water, and can be prevented by adding a few drops of sulphuric acid to the water.

Unclean or cloudy fat is caused by

1. Insufficient mixing.
2. Too low speed of tester.
3. Too low temperature.
4. Too weak acid.

Curd particles in fat are caused by

1. Too weak acid.
2. Not enough acid.
3. Too low temperature.

## CHAPTER III.

### I. THE LACTOMETER AND ITS USE.

This instrument, shown in Fig. 13, is used to determine the specific gravity of milk. The stem has two scales upon it, a thermometer scale at the upper end and a lactometer scale at the lower. The latter scale reads from fifteen to forty, being divided into twenty-five divisions, each of which reads one *lactometer degree*. The lower end of the instrument consists of two bulbs: an upper one containing the mercury for the thermometer scale, and a lower and larger one weighted with shot or mercury which serves to immerse and to keep in an upright position the large oblong bulb or float below the stem.

**Making the Test.** In making a lactometer test the sample of milk is carefully mixed and placed in the lactometer cylinder. (Fig. 14.) The lactometer is now carefully lowered into it and enough milk is added to the cylinder to fill it brim full. Now place your eye in a horizontal position with the surface of the liquid and read down as far as the liquid will permit. The reading thus obtained is the correct lactometer reading, provided the temperature as indicated by the thermometer scale is  $60^{\circ}$ .

**Corrections for Temperature.** Lactometers are standardized at a temperature of  $60^{\circ}$  F.; but, since it is difficult to have a sample always at this temperature, corrections may be made for temperatures ranging from  $50^{\circ}$  to  $70^{\circ}$ . As the temperature rises the liquid expands and the specific gravity decreases. This decrease amounts to

one-tenth of a lactometer degree for every degree of temperature above 60. A decrease in temperature would result in a corresponding increase in the specific gravity. For every degree below 60, therefore, we subtract one-tenth degree from, and for every degree above 60 we



Fig. 13.  
Lactometer.

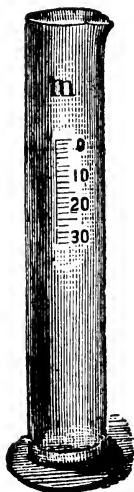

Fig. 14.—Lactometer cylinder.

add one-tenth degree to, the lactometer reading. Examples:

1. Lactometer reading is 32.5 at a temperature of 55. Corrected reading is 32.5 less .5, equals 32.
2. Lactometer reading is 31.7 at a temperature of 63. Corrected reading is 31.7 plus .3, equals 32.

**Interpretation of Lactometer Reading.** In the chapter on milk we learned that normal milk has an average

specific gravity of 1.032. This means that a tank that holds just 1,000 pounds of water would hold 1,032 pounds of milk. On the lactometer scale the 1.0 is omitted. A reading of 32, expressed in terms of specific gravity, would therefore read 1.032.

**Precautions in Making a Lactometer Test.** 1. A lactometer test should not be made until three or four hours after the milk leaves the udder of the cow. The reason for this is that milk, immediately after it is drawn, holds mechanically mixed with it air and probably other gases, which tends to give too low a reading.

2. The sample must be thoroughly mixed. If a layer of cream is allowed to form at the surface, the consequence is that the hollow oblong bulb will float in partially skimmed milk and give too high a reading.

3. A dirty lactometer is certain to give a false reading. A lactometer should be washed in luke warm (not hot) water to which a little soda or other alkali has been added, and then rinsed off with clean water and wiped.

## II. MILK SOLIDS.

The solids of milk include everything but the water. If a sample of milk be kept at the boiling temperature until all the water is evaporated, the dry, solid residue that remains constitutes the solids of milk. It is convenient to divide the solids into two classes, one including all the fat, the other all the solids which are not fat. In referring, therefore, to the different solids of milk, we speak of the "fat" and the "solids not fat" which, together, constitute the "total solids." The amount of each of these different solids present in milk is easily seen from the composition of milk. Thus, besides water, milk contains:



3.9%	fat	} = 9.% = solids not fat.
2.9%	casein	
0.5%	albumen	
4.9%	sugar	
0.7%	ash	

Total 12.9% = total solids.

**Relationship of Fat and Solids not Fat.** In normal milk a fairly definite relationship exists between the fat and the solids not fat. For example, milk rich in fat is likewise rich in solids not fat. On the other hand, milk poor in fat is also poor in solids not fat. As a general rule, an increase in the solids not fat always accompanies an increase in the percentage of fat. The increase is, however, not quite proportionate, the fat increasing the more rapidly.

Since the casein represents the most valuable constituent of the solids not fat, the following ratio between this substance and the fat very well illustrates the relationship that exists between the fat and solids not fat in milk:

*According to Van Slyke.*

<i>Per cent fat.</i>	<i>Per cent casein.</i>
3.00	2.10
3.25	2.20
3.50	2.30
3.75	2.40
4.00	2.50
4.25	2.60
4.50	2.70

**Specific Gravity as Affected by Richness of Milk.** The richness of milk seems to have but a very slight effect on its specific gravity. Usually a four per cent milk shows a slightly higher reading than a three per

cent milk, but the specific gravity of a four per cent milk is practically the same as that of a four and one-half per cent milk. From what has been said about the relationship of the fat and solids not fat in milks of different richness, it is quite natural that the specific gravity of such milks should vary but little. If the fat alone were increased, the lactometer reading would naturally be depressed. But since the solids not fat increase in nearly the same proportion as the fat, the depression caused by the latter is compensated for by the former.

**Calculation of Milk Solids.** The milk solids are calculated from the fat and the lactometer reading of milk. This is done by means of the following formula worked out at the Wisconsin Agricultural Experiment Station:

Formula for solids not fat equals one-fourth L R plus one-fifth F, in which L stands for lactometer, R for reading, and F for fat. Expressed in another way, *the solids not fat are obtained by adding one-fifth of the fat to one-fourth of the lactometer reading.* The total solids are obtained by adding the fat to the solids not fat. Examples:

1. To calculate solids not fat when the milk shows a lactometer reading of 31.6 and fat reading of 3.5. Substituting these figures for the letters in the formula, one-fourth L R plus one-fifth F, we get:

$\left(\frac{31.6}{4} \text{ plus } \frac{3.5}{5}\right)$  equals (7.9 plus .7) equals 8.6 equals solids not fat.

2. The total solids in the above sample are obtained by adding the fat and solids not fat. Thus: 8.6 plus 3.5 equals 12.1 equals total solids.

### III. DETECTION OF MILK ADULTERATION—WATERING AND SKIMMING.

A knowledge of the methods of detecting watering and skimming of milk is in many cases of considerable value to butter makers, even when the milk is bought on the fat basis. Where the milk is bought irrespective of its fat content, such a knowledge is simply indispensable for the welfare of the creamery.

In normal milk ranging in fat from 3% to 5%, it is not difficult to detect a moderate amount of watering and skimming. We speak of *normal* milk because this means the milk from a full milking and excludes colostrum milk, milk from diseased cows and those far advanced in lactation. Normal milk cannot be expected when cows are either only partially milked, diseased, or very far advanced in lactation.

The accuracy of determining the amount of watering and skimming becomes greater in proportion as the sample represents more cows. For example, no sample of milk from a herd consisting of six or more cows has been known to average below 3% fat. For this reason any sample of milk testing below 3%, when taken from a herd, is to be looked upon with suspicion. On the other hand there are records of individual cows that show tests as low as 1.7% and as high as 8%. It is owing to these extreme variations in the composition of milk from individual cows, that small amounts of adulteration cannot be estimated with the same degree of accuracy in such milk as in herd milk.

**Detection of Adulteration.** The general procedure in determining whether milk has been watered or skimmed, or both, is as follows:

1. Determine the percentage of fat in the sample under consideration.
2. Determine its specific gravity.
3. From the fat and specific gravity calculate the solids not fat and total solids.
4. Compare the results obtained with the average specific gravity, per cent of fat, solids not fat, and total solids given for normal cows' milk, or compare with the legal State Standard.
5. In drawing conclusions remember that
  - a. Fat is lighter than water.
  - b. Milk is heavier than water.
  - c. Skimming increases the lactometer reading.
  - d. Skimming slightly increases solids not fat.
  - e. Skimming decreases fat and total solids.
  - f. Watering decreases fat, solids not fat, lactometer reading, and total solids.
  - g. Watering and skimming decrease fat (materially), solids not fat, and total solids.
  - h. The solids not fat are less variable than the fat.
  - i. Skimming and watering may give a normal lactometer reading.

From i it is seen that a normal lactometer reading is possible when milk is skimmed and watered in the right proportions. A lactometer reading without a Babcock test is therefore worthless.

For herd milk a lactometer reading above 33.5 is positive evidence of skimming when accompanied with a low percentage of fat. Herd milk showing a lactometer reading below 28 is considered watered.

Examples of milk adulteration in which only herd milk is considered are given as follows:

1. Suspected sample shows:		Normal milk shows:	
Lactometer reading.....	32	Lactometer reading.....	32
Fat .....	2.5	Fat .....	3.9
Solids not fat.....	8.5	Solids not fat.....	8.78
Total solids.....	11.0	Total solids.....	12.68

Conclusion: Sample is watered and skimmed because (a) lactometer reading is normal and fat low; (b) solids not fat are nearly normal and total solids low.

2. Suspected sample shows:	
Lactometer reading .....	33.2
Fat .....	3.1
Solids not fat.....	8.92
Total solids .....	12.02

Conclusion: Sample is skimmed because lactometer reading is high and fat low.

3. Suspected sample shows:	
Lactometer reading shows.....	29
Fat .....	3.4
Solids not fat.....	7.93
Total solids .....	11.33

Conclusion: Sample is watered because everything is much below normal, which is to be expected in the case of watered milk.

## CHAPTER IV.

### BACTERIA AND MILK FERMENTATIONS.

A thorough knowledge of bacteria and their action forms the basis of success in butter making. Indeed the man who is lacking such knowledge is making butter in the dark; his is chance work. Much attention will therefore be given to the study of these organisms in this work.

#### I. BACTERIA.

The term bacteria is applied to the smallest of living plants, which can be seen only under the highest powers of the microscope. Each bacterium is made up of a single cell. These plants are so small that it would require 30,000 of them laid side by side to measure an inch. Their presence is almost universal, being found in the air, water, and soil; in cold, hot, and temperate climates; and in living and dead as well as inorganic matter.

Bacteria grow with marvelous rapidity. A single bacterium is capable of reproducing itself a million times in twenty-four hours. They reproduce either by a simple division of the mother cell, thus producing two new cells, or by spore formation in which case the contents of the mother cell are formed into a round mass called a spore. These spores have the power of withstanding unfavorable conditions to a remarkable extent, some being able to endure a temperature of  $212^{\circ}$  F. for several hours.

Most bacteria require for best growth a moist, warm, and nutritious medium such as is furnished by milk, in

which an exceedingly varied and active life is possible.

In nature and in many of the arts and industries, bacteria are of the greatest utility, if not indispensable. They play a most important part in the disintegration of vegetable and animal matter, resolving compounds into their elemental constituents in which form they can again be built up and used as plant food. In the art of butter and cheese making bacteria are indispensable. The tobacco, tanning, and a host of other industries cannot flourish without them.

## II. MILK FERMENTATIONS.

**Definition.** In defining fermentation processes, Conn says that, "In general, they are progressive chemical changes taking place under the influence of certain organic substances which are present in very small quantity in the fermenting mass."

With few exceptions, milk fermentations are the result of the growth and multiplication of various classes of bacteria. The souring of milk illustrates a typical fermentation, which is caused by the action of lactic acid bacteria upon the milk sugar breaking it up into lactic acid. Here the chemical change is conversion of sugar into lactic acid.

The most common fermentations of milk are the following:

Milk Fermentations	{ Normal.....  Abnormal...	{ Lactic. Curdling and Digesting. Butyric.  Bitter. Slimy or Ropy. Gassy. Toxic. Chromogenic.

## NORMAL FERMENTATIONS.

We speak of normal fermentations because milk always contains certain classes of bacteria even when drawn and kept under cleanly conditions. These fermentations will be discussed in the following pages.

## I. LACTIC FERMENTATION.

This is the most common and by far the most important fermentation of milk. Indeed it is indispensable in the manufacture of butter of the highest quality. The germ causing this fermentation is called *Lactici Acidi*. It is non-spore bearing and has its optimum growth temperature between 90° and 98° F. At 40° its growth ceases. Exposed to a temperature of 140° for fifteen minutes it is killed.

The souring of milk and cream, as already mentioned, is due to the action of the lactic acid bacteria upon the milk sugar changing it into lactic acid. Acid is therefore always produced at the expense of milk sugar. But the sugar is never all converted into acid because the production of acid is limited. When the acidity reaches about .9% the lactic acid bacteria are either checked or killed and the production of acid ceases. Owing to the universal presence of these bacteria it is almost impossible to secure milk free from them.

Under cleanly conditions the lactic acid type of bacteria always predominates in milk. When, however, milk is drawn under uncleanly conditions the lactic organisms may be outnumbered by other species of bacteria which give rise to the numerous taints often met with in milk.

Contradictory as it may seem, the lactic acid bacteria are alike friend and foe to the butter maker. Creamery



patrons are expected to have milk as free as possible from these germs so that it may arrive at the creamery in a sweet condition. They are therefore expected to thoroughly cool and care for it, not alone to suppress the action of the lactic acid bacteria but also that of the abnormal species that might have gained access to the milk.

While the acid bacteria are objectionable in milk, in cream made into butter they are indispensable. The highly desirable aroma in butter is the result of the growth of these organisms in the process of cream ripening. There are a number of different species of bacteria that have the power of producing lactic acid.

## 2. CURDLING AND DIGESTING FERMENTATION.

In point of numbers this class of bacteria ranks perhaps next to the lactic acid type. Indeed it is very difficult to obtain milk that does not contain them. It is not often, however, that their presence is noticeable owing to their inability to thrive in an acid medium.

According to bacteriologists most of these bacteria secrete two enzymes, one of which has the power of curdling milk, the other of digesting it. The former has the power of rennet, the latter of trypsin. "As a rule," says Russell, "any organism that possesses the digestive power, first causes a coagulation of the casein in a manner comparable to rennet."

It is only occasionally when the lactic acid organisms are in a great minority, or when for some reason their action has been suppressed, that this class of bacteria manifests itself by curdling milk while sweet. The curd thus formed differs from that produced by lactic acid in being soft and slimy.

Most of the curdling and digesting bacteria are spore bearing and can thus withstand unfavorable conditions better than the lactic acid bacteria. For this reason milk that has been heated sufficiently to kill the lactic acid bacteria, will often undergo the undesirable changes attributable to the digesting and curdling organisms.

### 3. BUTYRIC FERMENTATION.

It was mentioned that many bacteria have the power of producing lactic acid but that the true lactic acid fermentation is probably caused by a single species. So it is with the butyric acid bacteria. While a number of different organisms are known to produce this acid, Conn is of the opinion that the common butyric fermentation of milk and cream is due to a single species belonging to the anaerobic type.

The butyric acid produced by these organisms is the chief cause of rancid flavors in cream and butter. These bacteria are widely distributed in nature, being particularly abundant in filth. They are almost universally present in milk, from which they are hard to eradicate on account of their resistant spores. It is on account of these spores and their ability to grow in the absence of oxygen that the butyric fermentation is often found in ordinary sterilized milk from which the air has been excluded.

The influence of the butyric acid bacteria is felt mainly in butter and in overripened cream. The latter frequently possesses a rancid odor which must be charged to these bacteria, especially since it is known that overripened cream possesses conditions favorable for their development. Overripening should, therefore, be carefully guarded against.

The butyric fermentation is rarely noticeable during the early stage of cream ripening and its subsequent development in a highly acid cream is explained by Russell as being "probably due, not so much to the presence of lactic acid, as to the absence of dissolved oxygen, which at this stage has been used up by the lactic acid organisms."

Butter that is apparently good in quality when freshly made, will usually turn rancid when kept at ordinary temperatures a short time. The quickness with which this change comes is dependent largely upon the amount of acid present in cream at the time of churning. Butter made from cream in which the maximum amount of acid consistent with good flavor has been developed, usually possesses poor keeping quality. This seems to indicate that at least part of the rancidity that develops in butter after it is made is due to the butyric acid bacteria, while light and air, doubtless, also contribute much to this end.

#### ABNORMAL FERMENTATIONS.

No trouble needs to be anticipated from these fermentations so long as cleanliness prevails in the dairy. The bacteria that belong to this class are usually associated with filth, and dairies that become infested with them show a lack of cleanliness in the care and handling of the milk. Since milk is frequently infected with one or another of these abnormal fermentations a brief discussion will be given of the most important.

##### I. BITTER FERMENTATION.

Bitter milk and cream are quite common and there are several ways in which this bitterness is imparted: it may

be due to strippers' milk and to certain classes of feeds and weeds, but most frequently to bacteria. This class of bacteria has not yet been studied very thoroughly but we know a great deal about it in a practical way. In milk and cream in which the action of the lactic acid germs has been suppressed by low temperatures, bitterness due to the development of the bitter fermentation is almost certain to be noticeable. When the temperature is such as to cause a rapid development of the lactic fermentation, the bitter fermentation is rarely, if ever, present. It is quite evident from this that the bitter organisms are capable of growing at much lower temperatures than the lactic and that so long as the latter are rapidly growing the bitter fermentation is held in check.

This teaches us that it is not safe to ripen cream below 60° F. The author has found that cream quickly ripened and then held at a temperature of 45° for twenty-four hours would show no tendency toward bitterness, while the same cream held sweet at 45° for twenty-four hours and then ripened would develop a bitter flavor. This indicates that the lactic acid is unfavorable to the development of the bitter fermentation.

The bitter germs produce spores capable of resisting the boiling temperature. This accounts for the bitter taste that often develops in boiled milk.

## 2. SLIMY OR ROPY FERMENTATION.

This is not a common fermentation and rarely causes trouble where cleanliness is practiced in the dairy. The bacteria that produce it are usually found in impure water, dust, and dung. These germs are antagonistic to

the lactic organisms and for this reason milk infected with them sours with great difficulty.

The action of this class of bacteria is to increase the viscosity of milk, which in mild cases simply assumes a slimy appearance. In extreme cases, however, the milk develops into a ropy consistency, permitting it to be strung out in threads several feet long.

Slimy or ropy milk cannot be creamed and is therefore worthless in the manufacture of butter. Such milk should not be confused with gargety milk which is stringy when drawn from the cow. The bacteria belonging to this class are easily destroyed as they do not form spores.

### 3. GASSY FERMENTATION.

This is an exceedingly troublesome fermentation in cheese making and is also the cause of much poor flavored butter. The gas germs are very abundant during the warm summer months but are scarcely noticeable in winter. Like the bitter germs, they are antagonistic to the lactic acid bacteria and do not grow during the rapid development of the latter. They are found most abundantly in the barn, particularly in dung.

### 4. TOXIC FERMENTATIONS.

Toxic or poisonous products are occasionally developed in milk as a result of bacterial activity. They are most commonly found in milk that has been kept for some time at low temperature.

### 5. CHROMOGENIC FERMENTATIONS.

Bacteria belonging to this class have the power of imparting to milk various colors. The most common of

these is blue. It is, however, not often met with in dairy practice since the color usually does not appear until the milk is several days old. The specific organism that causes blue milk has been known for more than half a century and is called cyanogenous. Another color that rarely turns up in dairy practice is produced by a germ known as prodigiosis, causing milk to turn red. Other colors are produced such as yellow, green, and black, but these are of very rare occurrence.

## CHAPTER V.

### COMPOSITE SAMPLING.

Where milk is bought on the fat basis, it is essential that it be sampled daily as it arrives at the creamery. It is not practicable, however, to make daily tests of the samples because this would involve too much work. Each patron is therefore provided with a pint jar to which samples of his milk are added daily for one or two weeks, the sample thus secured being called a *composite* sample. A test of this composite sample represents the average percentage of butter fat in the milk for the period during which the sample was gathered.

Careful experiments have shown that quite as accurate results can be obtained with the composite method of testing as is possible by daily tests, besides saving a great deal of work. This has led to its universal adoption wherever milk is bought by the Babcock test.

All composite jars should be carefully labeled by placing numbers upon them. These numbers should be written in large indelible figures as exhibited by the composite jar shown in Fig. 15. Shelves are provided in the intake upon which the jars are arranged in regular consecutive order. Numbers corresponding to those on the jars are placed on the milk sheet opposite the names of the patrons which should be arranged alphabetically.

**Taking the Samples.** Whatever the method of sampling, all milk should be sampled immediately after it enters the weigh can, not, as is frequently the case, after it is weighed.

Most of the sampling is done by either of two methods: (1) by means of a half ounce dipper, shown in Fig. 16, or (2) by means of long narrow tubes, one of which is shown in Fig. 17.

The dipper furnishes a simple and easy means of sampling milk. Where the milk is thoroughly mixed, and the variations in quantity from day to day are slight, the dipper method of sampling is accurate.

The other method of sampling is illustrated by the Scovell sampler (Fig. 17). The main tube of the sampler is open at both ends, the lower of which closely fits into a cap provided with three elliptical openings. As the sampler is lowered into the milk the latter rushes through the openings filling the tube to the height of the milk in the can. When the cap strikes the bottom of the can the tube slides over the openings, thus permitting the sample to be withdrawn and emptied into the composite jar.

This sampler has the advantage of always taking an aliquot portion of the milk, and furnishing an accurate sample when the sampling is somewhat delayed, because it takes as much milk from the top as it does from the bottom of the can.

The McKay sampler designed by McKay, works on the same principle as the Scovell and has proven very satisfactory.

**Preservatives.** Milk cannot be satisfactorily tested after it has loppered owing to the difficulty of securing an accurate sample. This makes it necessary to add some preservative to the composite samples to keep them sweet.

The best preservatives for this purpose are corrosive sublimate, formalin, and bichromate of potash. All of these are poisons and care must be taken to place them



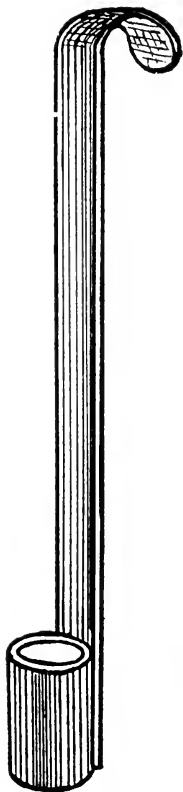

Fig. 16.—Milk sampler.



Fig. 18.—Milk thief.



Fig. 17.—Scovell sampling tube.

where children, and others unfamiliar with their poisonous properties, can not have access to them.

The bichromate of potash and corrosive sublimate can be purchased in tablet form, each tablet containing enough preservative to keep a pint of milk sweet for about two

weeks. The tablets color the milk so that there can be no mistake about its unfitness for consumption.

When colorless preservatives are used, like ordinary formalin and corrosive sublimate, a little analine dye should be added to prevent mistaking the identity of milk treated with these preservatives.

During the warm summer time the bichromate of potash is not as satisfactory as either of the other two preservatives mentioned, because of its comparative weakness and liability to interfere with the test when too much of it is used. When the bichromate is used in the ordinary solid form not more than a piece the size of a pea should be used, otherwise a good, clear test is not possible.

For spring, fall, and winter use, however, bichromate of potash is excelled by no other preservative, either in cheapness, or safety and convenience in handling.

**Care of Composite Samples.** It is a duty which the butter maker owes his patrons to keep the sample jars carefully locked up in the refrigerator when not in use so as to prevent the possibility of anyone's tampering with them. This will serve the additional purpose of excluding the light and heat from the samples, for they will keep but a short time when exposed to light and heat.

When the sample jars are permitted to stand a few days without shaking, the cream which rises will dry and harden, especially that in contact with the sides of the jar, so that it becomes difficult to secure a fair sample on testing day without special treatment of the sample. This is prevented by giving the jar a rotary motion every time a sample of milk is added.

It is important, too, that the covers of the jars fit tight, otherwise evaporation takes place, resulting in an increased test. In several instances the author has ob-

served that the butter maker (?) did not cover the jars at all! Can we wonder why patrons complain so frequently about the testing? Where the jars are kept uncovered for several weeks the cream is in a condition in which it can not be reincorporated with the milk and the Babcock test in this case becomes truly a snare and delusion.

Should the samples show any dried or churned cream on testing day, the sample jars must be placed in water at a temperature of 110° F. for five or ten minutes to allow the cream or butter to melt. When this is done the sample for the test bottle must be taken instantly after mixing, as the melted fat separates very quickly.

**Frequency of Testing.** It must not be supposed that if enough preservative can be added to the sample jars to keep the milk sweet for a month or longer that it is just as well to make monthly tests as weekly. Far from it. Even if the milk does remain sweet, the tendency of the cream to churn and become dried and crusty is in itself sufficient protest against monthly testing. It is rare, indeed, that samples that have been kept for a month or longer can be sampled satisfactorily without warming them in a water bath, which means a great deal of extra work.

The best tests are secured when the samples are tested weekly or at most every two weeks. When the tests are made weekly it rarely becomes necessary to warm the samples if they have been properly cared for. Then, too, if an error is made anywhere in the testing, there are three other tests for the month that help to minimize it. It is not strange at all that a sample jar should break occasionally. If the jar should contain a whole month's milk the patron is deprived of his test for

that month. On the weekly basis of testing there would still be three tests to fall back on.

**Supervision of Test.** To relieve the butter maker from any suspicion of unfairness or carelessness in the testing of the composite samples, one or two of the patrons should be present at each testing. When one of the patrons thus witnesses the details of the testing and is furnished with a copy of the test, the butter maker is practically exempt from the suspicions that usually rest upon him, no matter how honest or careful a man he may be.

**Duplicate Set of Jars.** Where the testing is not under the supervision of one of the patrons, some butter makers have adopted the scheme of providing a double set of sample jars. After the test is made the jars, instead of being emptied, are set aside for a week, so that anyone who has any complaint to offer on the test may call on the buttermaker for a retest, another set of sample jars being used in the meantime.

**Composite Cream Samples.** When cream is received in good condition, the method of composite sampling may be employed in the same manner as with milk.

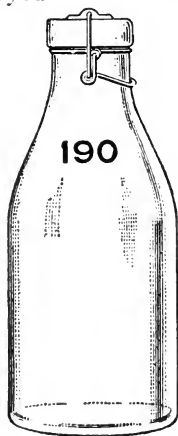
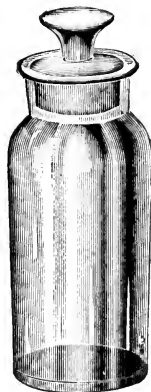

Fig. 15.—Composite test jar.



Glass top composite jar.

## CHAPTER VI.

### CREAMING.

**Definition.** Milk upon standing soon separates into two portions, one called cream, the other skim-milk. This process of separation is known as *creaming*, and is due to the difference in the specific gravity of the fat and the milk serum. The fat being light and insoluble, rises, carrying with it the other constituents in about the same proportion in which they are found in milk. The fat together with these other constituents forms the *cream*. After the cream has been skimmed off, there remains a more or less fat-free watery portion called *skim-milk*.

**Processes of Creaming.** The processes by which milk is creamed may be divided into two general classes: (1) that in which milk is placed in shallow pans or long narrow cans and allowed to set for about twenty-four hours, a process known as natural or gravity creaming; (2) that in which gravity is aided by subjecting the milk to centrifugal force, a process known as centrifugal creaming. The centrifugal force has the effect of increasing the force of gravity many thousands of times, thus causing an almost instantaneous creaming. This force is generated in the cream separator.

Before the days of the centrifugal cream separator, creameries either bought the milk and creamed it at the creamery by the gravity process, or bought and gathered the cream that had been creamed at the farms by the same process. The practice of gathering cream is now extensively employed by creameries throughout the country;

but the cream thus gathered is largely the product of the cream separator, only a small portion being still creamed by the gravity process. The discussion on creaming will therefore be confined to the centrifugal process.

#### CREAM SEPARATORS.

**History.** The cream separator had its beginning in 1864 when Prandtl, of Munich, creamed milk by means of two cylindrical buckets revolving upon a spindle. In 1874 Lefeldt constructed a separator with a revolving drum similar to the later hollow bowl separators. This drum had a speed of 800 revolutions per minute. But it lacked an arrangement permitting a continuous discharge of cream and skim-milk, so that the separator had to be stopped at regular intervals when the cream was skimmed off, the skim-milk removed, and the bowl refilled for the next separation.

It was not until 1879 that real separators appeared upon the market. During this year two machines were perfected which permitted continuous cream and skim-milk discharges. One was known as the Danish Weston, invented in Denmark, the other the De Laval, invented in Sweden. Both of these separators were hollow bowl machines.

Other separators soon followed but no decided improvement was made until 1891, when the De Laval separator appeared with a series of discs inside the bowl which had the effect of separating the milk in thin layers, thus increasing both the efficiency and the capacity of the separator. Since then various bowl devices have been invented by numerous separator manufacturers.

Hand separators first appeared on the market in 1886. They are extensively used on dairy farms at the present time and are rapidly replacing the gravity methods of creaming.

In 1887 a machine appeared on the market which extracted the butter directly from sweet milk. This machine was called butter extractor. The butter made with the extractor was inferior in quality and the machine has practically gone out of existence.

**Choice of Separator.** In choosing a cream separator we should be guided by three things: 1. Efficiency of skimming; 2. Power required to operate; 3. Its durability.

#### I. EFFICIENCY OF SKIMMING.

Under favorable conditions a separator should not leave more than .05% fat in the skim-milk by the Babcock test. There are a number of conditions that affect the efficiency of skimming and these must be duly considered in making a separator test. The following are some of these conditions:

- A. Speed of bowl.
- B. Steadiness of motion.
- C. Temperature of milk.
- D. Manner of heating milk.
- E. Amount of milk skimmed per hour.
- F. Acidity of milk.
- G. Viscosity of milk.
- H. Richness of cream.
- I. Stage of lactation. (Stripper's milk.)

A. The greater the speed the more efficient the creaming, other conditions the same. It is important to see

that the separator runs at full speed during the separating process. The speed indicator should always be applied before turning on the milk and several times during the run. Loose belts, pulleys slipping on the shaft, and low steam pressure will reduce the speed of the separator.

B. A separator should run as smoothly as a top. The slightest trembling will increase the loss of fat in the skim-milk. Trembling of bowl may be caused by any of the following conditions: (1) loose bearings, (2) separator out of plum, (3) dirty oil or dirty bearings, (4) unstable foundation, or (5) unbalanced bowl.

C. The best skimming is not possible with any separator when the temperature falls below 60° F. A temperature of 85° F. is the most satisfactory for ordinary skimming. Under some conditions the cleanest skimming is obtained at temperatures above 100° F. The reason milk separates better at the higher temperatures is that the viscosity is reduced.

D. Sudden heating tends to increase the loss of fat in skim-milk in ordinary skimming. The reason for this is that the fat heats more slowly than the milk serum which diminishes the difference between their densities. When, for example, milk is suddenly heated from near the freezing temperature to 85° F. by applying live steam, the loss of fat in the skim-milk may be four times as great as it is under favorable conditions. If, instead of suddenly heating the milk to 85°, it is heated to 160° or above, then no extra loss of fat occurs. Hence the advantage of separating milk at pasteurizing temperature during the winter.

E. Unduly crowding a separator increases the loss of fat in the skim-milk. On the other hand, a marked underfeeding is apt to lead to the same result.



F. The higher the acidity of milk the poorer the creaming. With sour milk the loss of fat in the skim-milk becomes very great. This emphasizes the importance of having the milk delivered to the creamery in a sweet condition.

G. Sometimes large numbers of undesirable (slimy) bacteria find entrance into milk and materially increase its viscosity. This results in very unsatisfactory creaming. Low temperatures also increase the viscosity of milk which accounts for the poor skimming at these temperatures.

H. Most of the standard makes of separators will do satisfactory work when delivering cream of a richness of 50%. A richer cream is liable to result in a richer skim-milk. The reason for this is that in rich cream the skim-milk is taken close to the cream line where the skim-milk is richest.

I. Owing to the very small size of the fat globules in stripper's milk, such milk is more difficult to cream than that produced in the early period of lactation.

**Keeping the Bearings Clean.** To insure a smooth and easy running of the separator, the bearings must be kept free from any traces of gumminess by frequently washing them with kerosene or gasoline.

#### SEPARATING TEMPERATURE.

During the summer time, when milk is fresh and requires little heating, a separating temperature of 70° F. gives good results. In the late fall and during the winter, when milk is received cold and often two days old, it is necessary to raise the temperature of the milk to 85° before separating. When milk is received in a partly frozen condition or when permeated with bad odors, a

separating temperature of 140° to 170° is preferred. Whenever such high temperatures are employed it is necessary to cool the cream immediately after it leaves the separator to a temperature of 70° or lower.

#### MILK HEATERS.

There are to be found upon the market two general classes of milk heaters: Those which admit the steam directly to the milk called direct heaters, and those in which the steam enters a jacket surrounding the milk known as indirect heaters.

**Direct Heaters.** These are practically nothing more than an expansion in the feed pipe in which the steam enters the milk. They are permissible only when first class steam is available and when milk is to be heated through a short range of temperature. But even under these conditions indirect heaters are always preferred.

The two main objections to the direct heaters are: (1) the liability of contaminating the milk with impure steam, and (2) the effect of the sudden heating upon the loss of fat in the skim milk which may be quite considerable when the milk is heated through a long range of temperature.

It is well known that the exhaustiveness of skimming with any separator is greatly influenced by the manner in which the milk is heated. In general very sudden heating has the effect of diminishing the difference in the specific gravity between the fat and milk serum, consequently rendering the separation of the fat from the milk more difficult.

In experiments conducted by the author it was found that in many instances where the milk was received in a partly frozen condition and suddenly heated to a separat-

ing temperature of  $80^{\circ}$  to  $85^{\circ}$  F., the loss of fat in the skimmilk was from .08% to .12%. When, however, such milk was suddenly heated to a temperature of  $160^{\circ}$  F. or above, the loss of fat in the skimmilk was from .02% to .03%.

The addition of water to the milk through the condensation of the steam is also objectionable in heating milk with steam direct.

The practice of turning steam into milk should be abandoned.

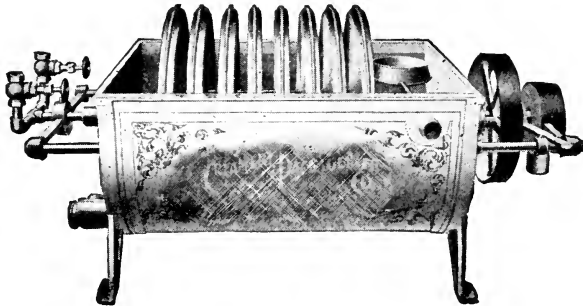

Fig. 19.—Milk heater.

**Indirect Heaters.** A satisfactory heater of this class is shown in Fig. 19. In this heater the steam passes into a series of hollow discs, which is in motion during the heating process, agitating the milk so as to insure uniform heating.

A heater like that shown in Fig. 20 has proven satisfactory as a heater and has the further advantage of elevating the milk.

#### RICHNESS OF CREAM.

**How Regulated.** The richness of cream is usually

regulated by means of a cream screw in the separator bowl. When a rich cream is desired the screw is turned toward the center of the bowl, and for a thin cream it is turned away from the center.

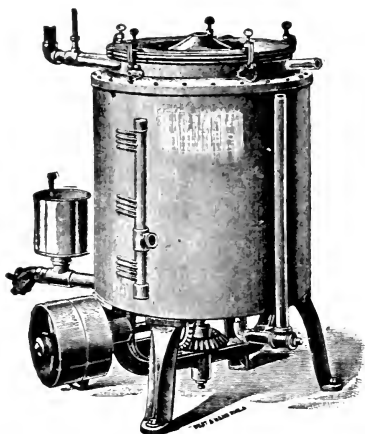

Fig. 20.—Heater and Pasteurizer which elevates milk and cream.

The richness of cream is also affected by the rate of separation. With all separators the more milk separated per hour and the lower the speed the thinner the cream. Too low a speed always results in a rich skim-milk and poor cream.

Temperatures between  $60^{\circ}$  and  $90^{\circ}$  have little effect on the richness of cream. When, however, the temperature is raised to  $140^{\circ}$  or above,

the cream becomes thinner.

**Advantages of Rich Cream.** In whole milk creameries 45% is about the ideal richness of cream. Where a large amount of starter is to be added to the cream it is necessary to separate a rich cream so that the starter will not bring it below the churning richness.

In case milk is tainted it is desirable to separate a very heavy cream so as to get rid of as much milk serum as possible. In this way most of the taints, which develop in the milk serum, can be gotten rid of. The cream is then reduced to churning richness with starter, or partly with starter and partly with fine flavored milk.

The fat globules in a rich cream are close together

which permits churning at a comparatively low temperature. The chief advantage gained in this is the greater exhaustiveness of churning.

For hand separator cream, 40% should be placed as the limit.

A further discussion of this subject will be found on page 237.

#### CREAM COOLING.

With the modern cream ripeners no special cream cooler is necessary since the cooling is very quickly done in the ripener. Cream should be cooled to about 70° F. as quickly as possible after separating. Where a large amount of starter is used, cream may be satisfactorily ripened at 65° F.

## CHAPTER VII.

### CREAM RIPENING.

This chapter will be discussed under three heads :

- Part I. Theory and Methods of Cream Ripening.
- Part II. The Control of the Ripening Process.
- Part III. Cream Acid Tests.

#### PART I.—THEORY AND METHODS OF CREAM RIPENING.

Cream ripening is a process of fermentation in which the lactic acid organisms play the chief role. In every-day language, cream ripening means the souring of the cream. So important is this process that the success or failure of the butter maker is largely determined by his ability to exercise the proper control over it. In common creamery practice the time consumed in the ripening of cream varies from six to twenty-four hours and includes all the changes which the cream undergoes from the time it leaves the separator to the time it enters the churn.

**Object.** The ripening of cream has for its prime object the development of flavor and aroma in butter, two qualities usually expressed by the word flavor. In addition to this, cream ripening has several minor purposes, namely: (1) renders cream more easily churnable; (2) obviates difficulties from frothing or foaming in churning; (3) permits a higher churning temperature; (4) increases the keeping quality of butter.

**Flavor.** This, so far as known at the present time,

is the result of the development of the lactic fermentation. If other fermentations aid in the production of this important quality of butter, they must be looked upon as secondary. In practice the degree or intensity of flavor is easily controlled by governing the formation of lactic acid. That is, the flavor develops gradually with the increase in the acidity of the cream. Sweet cream butter for example is almost entirely devoid of flavor, while cream with an average richness possesses the maximum amount of good flavor possible when the acidity has reached .6%.

Exhaustive experiments conducted by the author (See Rept. Wis. Exp. Sta., 1905) show that the desirable butter flavor develops in the milk serum (skimmilk) and is absorbed from this by the butterfat. Such absorption may take place either during the ordinary course of cream ripening, or during the process of churning as would be the case when well ripened skimmilk (starter) is added to sweet cream and the mixture churned immediately. This explains why in creamery practice such good results have been obtained by churning sweet cream immediately after the addition of a large amount of well ripened starter.

**Churnability.** Practical experience shows that sour cream is more easily churnable than sweet cream. This is explained by the fact that the development of acid in cream tends to diminish its viscosity. The concussion produced in churning causes the little microscopic fat globules to flow together and coalesce, ultimately forming the small granules of butter visible in the churn. A high viscosity impedes the movement of these globules. It is

evident, therefore, that anything that reduces the viscosity of cream, will facilitate the churning.

As a rule, too, the greater the churnability of cream the smaller the loss of fat in the buttermilk.

**Frothing.** Experience shows that ripened cream is less subject to frothing or foaming than unripened. This is probably due to the reduced viscosity of ripened cream and the consequent greater churnability of same.

**Temperature.** Sour cream can be churned at higher temperatures than sweet cream with less loss of fat in the buttermilk. This is of great practical importance since it would be difficult, if not impossible, for most creameries to get low enough temperatures for the successful churning of sweet cream. Indeed, many creameries fail to get a low enough churning temperature for ripened cream.

**Keeping Quality.** It has been found that butter with the best keeping quality is obtained from well ripened cream. It is true, however, that butter made from cream that has been ripened a little too far will possess very poor keeping quality. An acidity of .5% should be placed as the limit when good keeping quality is desired.

#### METHODS OF CREAM RIPENING.

There are three ways in which cream is ripened at the present time:

1. By the unaided development of the lactic fermentation called *natural ripening*.

2. By first destroying the bulk of the bacteria in cream by heat and then inoculating same with cultures of lactic acid bacteria. This method is known as *pasteurized cream ripening*.



3. By the aided development of the lactic fermentation called *starter ripening*.

#### I. NATURAL RIPENING.

By this is meant the natural souring of the cream. In this method no attempt is made to repress the abnormal fermentations or to assist in the development of the lactic. From the chapter on Milk Fermentations we have learned that milk normally contains a number of different kinds of germs, frequently as many as a dozen or more. Naturally, therefore, where this method of ripening is practiced, a number of fermentations must go on simultaneously and the flavor of the butter is impaired to the extent to which the abnormal fermentations have developed. If the cream is clean and uncontaminated the lactic fermentation greatly predominates and the resulting flavor is good. If, on the other hand, the cream happens to contain many bad germs the probability is that the abnormal ferments will predominate and the flavor of the butter will be badly "off."

Where cream is therefore allowed to take its own course in ripening the quality of the butter is a great uncertainty. This method, though still practiced by many butter makers, is to be condemned as obsolete and unsatisfactory.

#### 2. PASTEURIZED CREAM RIPENING.

Theoretically and practically the ideal way of making butter is to pasteurize the cream, a process which consists in heating cream momentarily to a temperature of 160° to 185° F. and then quickly cooling to 60° F. In this manner most of the bacteria in the cream are destroyed. After this treatment the cream is heavily inoculated with the lactic acid bacteria, and the lactic fermentation is given

a favorable temperature for development. When cream is treated in this way the lactic fermentation is practically the only one present and a butter with the desirable flavor and aroma is the result. It is the only way in which a uniform quality of butter can be secured from day to day.

This system of cream ripening is almost universally followed in Denmark, whose butter is recognized in all the world's markets as possessing qualities of superior excellence. The method is also gradually gaining favor in America and its general adoption can only be a matter of time. In the chapter on Cream Pasteurization this method is discussed in detail.

### 3. STARTER RIPENING.

This method of ripening consists in adding "starters," or carefully selected sour milk, to the cream after it leaves the separator. A full discussion of starters will be found in the following chapter.

In America this is at present the most popular method of cream ripening. While it does not, and can not, give the uniformly good results obtained by pasteurizing the cream, it is far superior to natural or unaided ripening.

When we have a substance which contains many kinds of bacteria, there naturally follows a struggle for existence and the fittest of the species will predominate.

We always have a number of different types of bacteria in cream, both desirable and undesirable. The latter can be held in check by making the conditions as favorable as possible for the former. Fortunately, when milk is properly cared for the lactic acid germs always predominate. But where milk is received at the creamery from 30 to 200 patrons, undesirable germs are frequently present in such large numbers as to seriously endanger

the growth of the lactic acid bacteria. However, when a large amount of starter containing only lactic acid germs is added to the cream from such milk these organisms are certain to predominate.

The best results with the starter method are secured when the milk is received at the creamery in a sweet condition and when a large amount of starter is used. Generally when milk is received in a sweet condition, especially during the summer months, it indicates that it has been thoroughly cooled and that the germs are present only in small numbers. When the cream from such milk is heavily inoculated with lactic acid germs by adding a starter, the development of the lactic fermentation is so rapid as to either check or entirely suppress the action of undesirable bacteria that may be present in the cream.

#### PART II.—THE CONTROL OF THE RIPENING PROCESS.

In Part I an attempt was made to convey some idea as to our present theory and methods of cream ripening. We learned that the highly desirable flavor and aroma of butter are produced by the development of the lactic fermentation. In the following discussion we shall take up the means of controlling this fermentation and treat of the more mechanical side of cream ripening. This will include: 1. The time the starter should be added to the cream; 2. The amount of starter to be added; 3. The ripening temperature; 4. Time in ripening; 5. Agitation of cream during ripening; 6. Means of controlling temperature.

1. The value of a starter in cream ripening has already been made evident in the discussion of the theory of cream ripening. To secure the maximum effect of a starter it should be added to the cream vat soon after the separation

of the milk has begun but not until the cream has reached a temperature of  $70^{\circ}$  F. The cream thus coming in contact with the starter as it leaves the separator insures a vigorous development of the starter germs, so that by the time the separation is completed, the starter fermentation is almost certain to predominate, especially when a large amount of starter is used.

2. The maximum amount of starter that may be consistently used is one pound to two pounds of cream. A larger amount than this would be liable to result in too thin a cream. Experience teaches us that the maximum richness of cream permissible in clean skimming under average conditions is 50%. Adding one pound of starter to two pounds of such cream would give us a 33 1-3 % cream, the ideal richness for churning. But this amount of starter is rarely permissible on account of the poor facilities for controlling the temperature of the cream.

3. Since the lactic acid bacteria develop best at a temperature of  $90^{\circ}$  to  $98^{\circ}$  F. it would seem desirable to ripen cream at these temperatures. But this is not practicable because of the unfavorable effect of high temperatures on the body of the cream and the butter. Good butter can be produced, however, under a wide range of ripening temperatures. The limits may be placed at  $60^{\circ}$  and  $80^{\circ}$ . Temperatures below  $60^{\circ}$  are too unfavorable for the development of the lactic acid bacteria. Any check upon the growth of these germs increases the chances for the development of other kinds of bacteria. But it may be added that when cream has reached an acidity of .4% or more, the ripening may be finished at a temperature between  $55^{\circ}$  and  $60^{\circ}$  with good results. In general practice a temperature between  $60^{\circ}$  and  $70^{\circ}$  gives

the best results. This means that the main portion of the ripening is done at this temperature. The ripening is always finished at temperatures lower than this.

4. As a rule quick ripening gives better results than slow. The reason for this is evident. Quick ripening means a rapid development of the lactic fermentation and, therefore, a relatively slow development of other fermentations. Practical experience shows us that the growth of the undesirable germs is slow in proportion as that of the lactic is rapid. For instance, when we attempt to ripen cream at 55° F., a temperature unfavorable for the growth of the lactic acid bacteria, a more or less bitter flavor is always the result. This is so because the bitter germs develop better at low temperatures than the lactic acid bacteria.

The main portion of the ripening should be done in about six hours. After this the temperature should be gradually reduced to a point at which the cream will not overripen before churning.

5. It is very essential in cream ripening to agitate the cream frequently to insure uniform ripening. When cream remains undisturbed for some time the fat rises in the same way that it does in milk, though in a less marked degree. The result is that the upper layers are richer than the lower and will sour less rapidly, since the action of the lactic acid germs is greater in thin than in rich cream.

This uneven ripening leads to a poor bodied cream. Instead of being smooth and glossy, it will appear coarse and curdy when poured from a dipper. The importance of stirring frequently during ripening should therefore not be underestimated.

6. The subject of cream cooling is a very important

one and will be discussed under the head of cream ripeners.

#### CREAM RIPENERS.

During the summer months much butter of inferior quality is made by overripening the cream and churning at too high a temperature. This is due chiefly to a lack of proper cooling facilities. With the open cream vats the control of temperature is a difficult thing. Fortunately these vats have been largely replaced by the more modern cream ripeners. These ripeners possess two important advantages over the open vats, namely: first, they permit a more rapid cooling by agitating the cream while cooling; second, they maintain a more uniform temperature because of tight fitting covers and better all round construction.

There are a number of different makes of ripeners on the market that are giving good satisfaction.

Since some of these ripeners are so constructed as to render the addition of ice to the water in them impossible, they can not therefore be considered complete without an ice water attachment. In Fig. 21 an ice water tank may be seen attached to the ripener.

Tank A contains ice water which is kept circulating through the ripener by means of pump B. By using the water over and over again, only a very small quantity of ice is required in cooling cream to the desired temperature. When the great cooling power of ice is once fully understood it is easy to see what a great amount of cooling a small quantity of ice will do. One pound of ice in melting will give out 142 times as much cold as one pound of water raised from 32° to 33° F. In other

words, the cooling power of ice is 142 times as great as that of water.

With uniced water, a low temperature is not possible. On warm days the ripener may be run during the greater

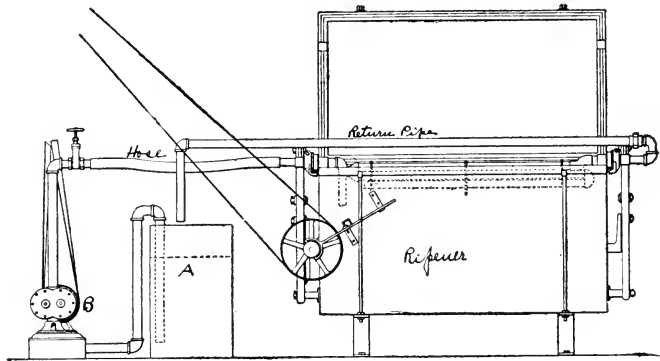

Fig. 21.—Showing method of circulating ice water through ripener.

part of the day without reducing the temperature below  $56^{\circ}$  F., and this too when the water is pumped directly from the well into the ripener. It is rarely possible to obtain a lower temperature than this with water that has a temperature of  $51^{\circ}$  to  $52^{\circ}$  F. as it enters the ripener.

When we compare the quick cooling with iced water and the slow and inadequate cooling with uniced water, it is easily seen that the saving in fuel and wear and tear of machinery will more than cover the cost of the ice. Moreover, quick cooling has a very important advantage in cream ripening. It permits the use of a large amount of starter which is not possible where good cooling facilities are not at hand. Using iced water makes it possible to have cream with the same degree of acidity 365 days in the year, and it is believed that the general

use of the improved cream ripeners and ice water attachments will result in a great improvement in both the quality and uniformity of butter and do away with the dangerous practice of adding ice directly to the cream.

#### DANGER OF ADDING ICE TO CREAM.

Adding ice to the cream is a pernicious practice, both because of its tendency to lower the quality of the butter and of the danger of infecting it with disease producing germs. This is so because most of the ice used is more or less contaminated with filth and various kinds of germs. Moreover, a good bodied cream cannot be obtained where it becomes excessively diluted with ice water.

Butter makers generally realize these facts but are often forced into the practice of adding ice to the cream because proper cooling facilities are not available. One of the contestants in the Michigan Butter Scoring Test writes as follows: "The ice we have been using comes from a mill pond, a very filthy hole. I did not use it in the cream until July when I was obliged to in order to get the cream cold enough. I am satisfied that is one reason my butter has such a poor flavor." Compare his scores for May and June when no ice was used in the cream, with those for July and August when ice was added. Score for May, 92½; score for June, 94; score for July, 87; score for August, 88.

#### WHEN BUTTERMILK MAY BE USED AS A STARTER.

Creameries using two ripeners and finding it difficult to get enough starter, will find it advantageous to ripen the best cream with a good starter and to use the butter-



milk from this for ripening the second vat of cream; or in case the second vat consists of partly soured hand separator cream it would be best to churn this cream as soon as possible after the addition of the buttermilk.

#### PART III. ACID TESTS FOR MILK AND CREAM.

Buttermakers who have had years of experience and who rank high in the profession of buttermaking do not find it safe to rely upon their noses in determining the ripeness of cream for churning. They use in daily practice tests by which it is possible to determine the actual amount of acid present. The method of using these tests is based upon the simplest form of titration.

**Titration.** This consists in *neutralizing* an *acid* with an *alkali* in the presence of an *indicator* which determines when the point of neutrality has been reached.

Acids and alkalies are substances that have entirely opposite chemical properties. The acid in milk gives it its sour taste, and for our purpose, illustrates very well what we mean by an acid. Ordinary lime may be used to illustrate what we mean by an alkali.

When lime is added to sour milk the acid unites with the lime forming a neutral substance which is neither alkaline nor acid. If we keep on adding lime to the milk we reach a point at which all the acid has combined with the lime. This is called the point of *neutrality*. The moment this point is passed is made visible to the eye by means of the indicator, (phenolphthalein) which is colorless in the presence of an acid but pink in the presence of an alkali. One drop of alkali added to milk after the acid has been neutralized will turn it pink.

In the tests used for milk and cream the alkali used is sodium hydroxide. This is made up of a definite strength so that the amount of acid can be calculated from the amount of alkali used.

**Kinds of Tests.** There are two tests in general use at the present time: one devised by Prof. Manns and known as the Manns' Test; the other devised by Prof. Farrington and known as Farrington's Alkaline Tablet Test.

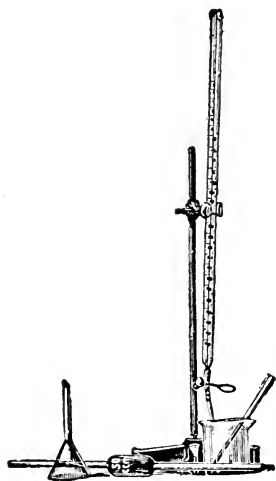

Fig. 22.—Manns' acid test apparatus.

#### MANNS' TEST.

The apparatus used in this test is illustrated in Fig. 22. It consists of a 50 c.c. burette, a 50 c.c. pipette, a small funnel, and a glass beaker with stirring rod. The alkali (not shown in the figure) can be bought ready made in gallon bottles and is labeled "neutralizer." This alkali or neutralizer is made by dissolving

four grams of sodium hydroxide in enough water to make one liter solution. The solution thus formed is called a one-tenth normal solution, each cubic centimeter of which contains .004 of a gram of sodium hydroxide which will neutralize .009 of a gram of lactic acid.

**Making the Test.** Measure 50 c.c. of cream with the pipette into the beaker, then with the same pipette add 50 c.c. of water. Now add five or six drops of indicator. Next fill the burette to the zero mark with the neutralizer

and slowly run this from the burette into the cream, shaking the beaker after each addition of alkali. With the first few additions of alkali the pinkish color produced quickly disappears. But when the point of neutrality approaches, the color disappears very slowly and the neutralizer must be added drop by drop only. The moment the cream remains pink indicates that the acid has all been neutralized. The number of cubic centimeters of alkali added to the cream is then noted, and from this the percentage of acid is calculated according to the following formula:

$$\text{Per cent acid} = \frac{\text{No. c.c. alkali} \times .009}{\text{No. c.c. cream}} \times 100.$$

Example: What is the percentage of acidity when 30 c.c. of alkali are required to neutralize 50 c.c. of cream?

$$\frac{30 \times .009}{50} \times 100 = .54\%.$$

From the formula it is evident that any amount of cream may be used for a test. But more accurate results are obtained by using 50 c.c. than less. Where this amount of cream is always used the formula may be considerably simplified.

Thus, by dividing the numerator and denominator by 50, the expression  $\left( \frac{\text{No. c.c. alkali} \times .009}{50} \times 100 \right)$  becomes  $(\text{No. c.c. alkali} \times .009 \times 2)$  or  $(\text{No. c.c. alkali} \times .018)$ . The acidity in the problem above would therefore equal  $30 \times .018 = .54\%$ .

#### FARRINGTON'S ALKALINE TABLET TEST.

In the Farrington test the same alkali is used as in Manns', but in a dry tablet form in which it is more

easily handled than in the liquid form. Each tablet contains enough alkali to neutralize .034 gram of lactic acid.

**Apparatus Used for the Test.** This is shown in Fig. 23 and consists of a porcelain cup, one 17.6 c.c. pipette, and a 100 c.c. rubber-stoppered graduated glass cylinder.

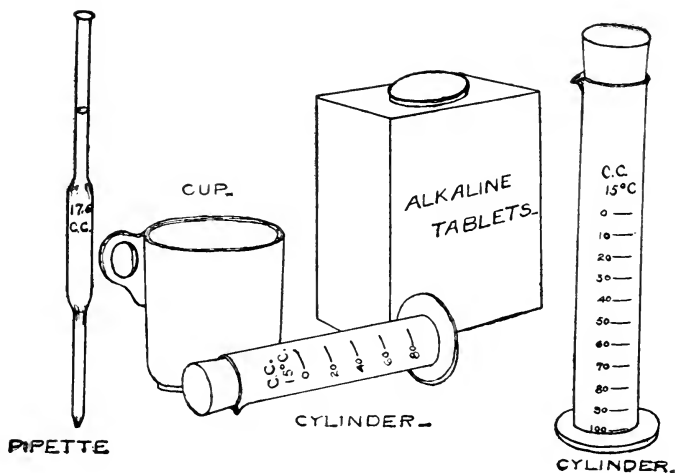

Fig. 23.—Farrington acid test apparatus.

**Making the Solution.** The solution is made in the graduated cylinder by dissolving 5 tablets in enough water to make 97 c.c. solution. When the tablets are dissolved, which takes from six to twelve hours, the solution should be well shaken and is then ready for use. The solution of the tablets may be hastened by placing the graduate in a reclining position as shown in the cut.

**Making the Test.** With the pipette add 17.6 c.c. of cream to the cup, then with the same pipette add an equal amount of water. Now slowly add of the tablet solution.

rotating the cup after each addition. As soon as a permanent pink color appears, the graduate is read and the number of c.c. solution used will indicate the number of hundredths of one per cent of acid in the cream. Thus, if it required 50 c.c. of the tablet solution to neutralize the cream then the amount of acid would be .50%. From this it will be seen that with the Farrington test no calculation of any kind is necessary.

#### TESTING THE ACIDITY OF MILK.

The acidity of milk may be determined in the same way as that of cream, except that the milk need not be diluted with water before adding the alkali.

**A Rapid Acid Test for Milk.** Where milk is pasteurized it is often desirable to determine approximately the acidity of each lot as it arrives at the creamery. It has been found that milk that contains more than .2% acid cannot be satisfactorily pasteurized. Farrington and Woll have devised the following rapid method for testing the acidity of milk that is to be pasteurized:

Prepare a tablet solution by adding two tablets for each ounce of water. When the tablets have dissolved, take the solution into the intake. Now, as each lot is dumped into the weigh can a sample of milk is taken with a No. 10 brass cartridge shell and emptied into a teacup. With another, or the same, No. 10 shell add a measure of tablet solution to the cup. Mix the alkali and milk by giving the contents of the cup a rotary motion. If the milk remains white it contains more than .2% acid; if it is colored, there is less than .2% acid present.

Where the tablet solution is prepared as above care must be taken to secure equal quantities of milk and solution for the test.

## PRECAUTIONS IN MAKING ACID TESTS.

1. Always thoroughly mix the cream or milk before taking a sample for a test.

2. Prepare the tablet solution and dilute the cream with water as nearly neutral as possible. Soft water is better than hard.

3. Keep the tablets dry and well bottled.

4. Keep the Manns neutralizer and the Farrington tablet solution carefully stoppered with a rubber stopper, as exposure to the air will weaken the solutions by absorbing carbonic acid.

5. With the Farrington tablets it is best to prepare a new solution every day.

6. Make the tests where there is plenty of light so that the first appearance of a permanent pink color can readily be noticed.

## RELATION OF RICHNESS AND ACIDITY IN CREAM.

In practice we find that the ripening is slower in rich than in poor cream. The reason for this is that the acid develops in the milk serum, which really should be used as the basis in measuring the degree of acidity, if this were possible.

In a cream testing 25% we find that more acid must be developed to get the desired effects in cream ripening than is necessary in a 35% cream. This is so because in the 25 % cream we have the acid distributed through 75% milk serum, while in the 35% cream it is distributed through only 65% milk serum.

If both the above creams show an acidity of .5%, this means that in the poor cream the .5 pound of acid is distributed through 75 pounds of serum, while in the rich

cream it is distributed through only 65 pounds of serum, hence the latter must have the greater intensity of acidity. This may be graphically shown as follows:

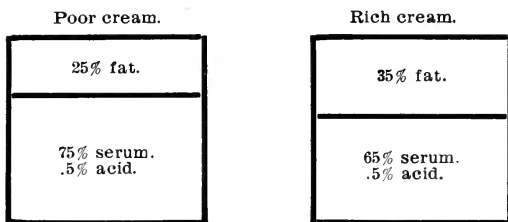

In the illustrations above it is seen that the acid in the rich cream is distributed through less space than in the poor, hence the degree of acidity must be higher in the rich cream.

We find in practice where the same results are to be expected from the ripening process, a 25% cream must show about .6% acidity, while a 35% cream, about .5%.

In bulletin No. 24 of the Washington Experiment Station, Prof. Spillman gives a table showing the required acidity for cream of different richness.

## CHAPTER VIII.

### STARTERS.

The value of carefully selected cultures of lactic acid producing bacteria in cream ripening was first demonstrated by Dr. Storch, of Copenhagen, a little more than a decade and a half ago. Since then the use of these cultures has spread so rapidly that few successful creameries can be found at the present time in which they are not used.

**Definition.** *Starter* is the general term applied to cultures of lactic acid organisms, whether they have been selected artificially in a laboratory, or at creameries by picking out lots of milk that seem to contain these organisms to the exclusion of others. A good starter may be defined as a clean flavored batch of sour milk or sour skim-milk.

The word starter derives its name from the fact that a starter is used to "start" or assist the development of the lactic fermentation in cream ripening.

**Object of Starters.** Cream ordinarily contains many kinds of bacteria—good, bad, and indifferent—and to insure the predominance of the lactic acid type in the ripening process it is necessary to reinforce the bacteria of this type already existing in the cream by adding large quantities of them in a pure form, that is, unmixed with undesirable species.

The bacterial or plant life of cream may be aptly compared with the plant life of a garden. In both we find plants of a desirable and undesirable character. The



weeds of the garden correspond to the bad fermentations of cream. If the weeds get the start of the cultivated vegetables, the growth of the latter will be checked or suppressed. So with the bacterial fermentations of cream. When the lactic acid bacteria predominate, other fermentations will be checked or crowded out. The use of a liberal amount of starter nearly always insures a majority of good bacteria and the larger this majority the better the product.

**Classification of Starters.** The following is a classification of the various starters in use at the present time:

Starters.	Natural.....	{	Sour skim-milk.....	} Desirable.	
		{	Sour milk.....		} Undesirable.
	Commercial (American)...	{	O. Douglas Cultures	{	
			(Boston, Mass.)...		2. Lactic Acid Culture.
		3. Duplex Culture.			
{		S. C. Keith, Jr.	{	1. Boston Butter Culture	
{	(Charleston, Mass.)	2. Lactic Acid Culture.			
		3. Duplex Culture.			
				Elov Erricson (Mankato, Minn.).	
				Hansen's Lactic Ferment (Little Falls, N. Y.)	
				and a few others.	

#### NATURAL STARTERS.

**Sour Milk and Skim-milk.** Natural starters are those obtained by allowing milk, skim-milk, or possibly cream, to sour in the ordinary way.

The earlier methods of using natural starters consisted in selecting milk or skim-milk from the patrons who furnished the best milk at the creamery, and allowing this to sour by holding it over till the following day. While good milk could be selected in this way, the method of souring it was very unsatisfactory. On warm days the milk might oversour, while on cooler days it would be

found comparatively sweet unless a good deal of attention was given to keeping the temperature where it would sour in the proper length of time. This method of starter making is rapidly falling into disuse.

The most satisfactory natural starters are selected and prepared in the following manner: Secure, say, one quart of milk from each of half a dozen healthy cows not far advanced in lactation, and fed on good feed. Before drawing the milk, brush the flanks and udders of the cows and then moisten them with water or, preferably, coat thinly with vasaline to prevent dislodgement of dust. Then, after rejecting the first few streams, draw the milk into sterilized quart jars provided with narrow necks. Now allow the milk to sour, uncovered, in a clean, pure atmosphere at a temperature between  $65^{\circ}$  and  $90^{\circ}$  F. When loppered pour off the top and introduce the sample with the best flavor into fifty pounds of sterilized skim-milk and ripen at a temperature at which it will sour in twenty-four hours (about  $65^{\circ}$  F.).

A starter thus selected can be propagated for a month or more by daily inoculating newly sterilized or pasteurized milk with a small amount of the old or mother starter. Usually three or four pounds of the mother starter added to one hundred pounds of pasteurized skim-milk will sour it in twenty-four hours at a temperature of  $65^{\circ}$  F. Under certain conditions of weather this amount may possibly have to be modified a little, for it is well known that on hot sultry days milk will sour more quickly at a given temperature than on cooler days. The best rule to follow is to use enough of the mother starter to sour the milk in twenty-four hours at a temperature of  $65^{\circ}$  F.

**Buttermilk and Sour Cream.** If the cream has a good flavor, a portion of this, or the buttermilk from it,

may be used as a starter. But in the case of unpasteurized cream, even though the flavor is good, there are always present some undesirable germs which will multiply in each successive batch of cream or buttermilk used as a starter, so that after a week's use the flavor may actually be bad. Where cream is slightly off flavored and a portion of this, or the buttermilk from it, is used as a starter, it will readily be seen that the taint will not only be transmitted but will multiply in the cream from day to day. The use of either cream or buttermilk as a starter is therefore not to be recommended.

#### COMMERCIAL STARTERS.

Commercial starters may consist of a single species of lactic acid organisms, but usually they are made up of a mixture of several species. These starters are prepared in laboratories where the utmost precautions are taken to keep them free from undesirable germs. The methods by which the good bacteria are separated from the bad are quite complicated and of too little practical value to permit a discussion of them here. Suffice it to say that such separation is possible only with the skilled bacteriologist.

Keith and Douglas each manufacture three different cultures which are put upon the market in liquid form, the liquid usually being bouillon, or beef extract, treated with milk sugar. The development of the germs in this medium is very rapid and the cultures should therefore not be used later than ten days after they are sent out from the manufacturer unless they are kept at low temperatures. The reason for this is that the rapid growth of the bacteria will quickly result in vast numbers of them,

which, together with their by-products, is fatal to their development.

The chief difference in the three cultures prepared by these men lies in the intensity of acid produced. The "lactic" is the most vigorous, and the "Boston" the least vigorous acid producing culture, while the "duplex" seems to take an intermediate position. Sometimes, however, it is difficult to distinguish between these cultures.

Erricson's culture has only recently been placed upon the market but is already popular. It is sent out in the form of a liquid (also as a powder) which appears to consist of sterilized milk to which some sugar has been added.

Hansen's lactic ferment is put up in the form of a powder which consists chiefly of sterilized milk with possibly slight additions of casein and starch. In this dry powdery medium the germs remain in a dormant condition. When held a long time in this condition their vitality seems to become impaired.

**Preparation.** Most of the commercial cultures are sent out in one ounce bottles which are hermetically sealed. The method of making starters from them is the same for all whether they are obtained in the liquid or in the dry form.

In making the first batch of commercial starter, the entire contents of the bottle is put into a quart of skim-milk, sterilized by keeping it at a temperature of 200° F. for two hours, and then cooling to 80° which temperature should be maintained until the starter has thickened. A new starter is now prepared by introducing the quart of starter into fifty pounds of skim-milk, pasteurized by keeping it at a temperature of 170° to 185° for thirty minutes and then cooling to 65° F. All subsequent starters are prepared in the same way except that the amount of

mother starter for inoculation must be reduced a little for a few days because the germs become more vigorous after they have propagated several days.

In preparing the first starter from a bottle of culture it is necessary to have the skim-milk *sterile*. For if any spores should remain, the slow souring would give them a chance to develop which might spoil the starter. Moreover, the cooked flavor imparted by the prolonged heating at high temperatures does not matter in the first starter as this should never be used to ripen cream. The first and second starters prepared from a new culture seldom have the good flavor produced in subsequent starters. The cause of this in all probability is the inactive condition of the germs and the peculiar flavor of the medium in which they are sent out.

In the starters prepared later the destruction of the spores is not so essential as the lactic acid germs are then in a vigorously growing condition which renders the spores practically harmless. At any rate the harm done by them would be less than that caused by the sterilizing process. When milk is pasteurized at 170° to 185° F. for thirty minutes the vegetative germs are destroyed and but little cooked flavor is noticeable.

#### NATURAL VERSUS COMMERCIAL STARTERS.

Experimental tests have shown that equally good results can be secured with commercial and natural starters. It is believed, however, that the average butter maker can get the best results with commercial starters. Too few are good judges of milk and for this reason are not always capable of selecting the best for natural starters. Standard commercial cultures can be relied upon as giving uniformly good results.

From what has been said of the methods of preparing starters it must have been noticed that they are essentially the same for both the natural and the commercial, the chief difference being in the original ferment, which in the case of the natural starter consists of a quart of selected milk allowed to sour naturally, while in the commercial it consists of a bottle of culture prepared in a laboratory.

#### USING A STARTER EVERY OTHER DAY.

During the winter when milk is received every other day at creameries the ordinary method of preparing starters daily is, of course, out of question. There are two ways, however, in which starters may be carried along during this time. One way is to keep the starter an extra twenty-four hours by holding it at a temperature below  $50^{\circ}$  after it has soured. The other and more satisfactory way is to prepare a small starter on the day the milk is separated; and, in addition, to pasteurize, but not inoculate, the amount of skim-milk needed for the regular starter. This milk is repasteurized the following day and then inoculated from the small starter prepared the day previous.

The object in repasteurizing the milk is to destroy the spores that have developed into the vegetative state.

#### HOW TO SELECT MILK FOR STARTERS.

It is poor practice to select starter milk promiscuously. The sweetest and best flavored milk should be obtained for the preparation of starters. Where possible the best plan is to select the morning's milk of one of the earliest patrons at the creamery and separate this first. In case

the best milk is received toward the middle or close of the run, it should be carried into the creamery and separated by itself so as to secure the skim-milk without contamination from other milk of inferior flavor.

It must not be supposed that any milk may be made into a first-class starter by thorough pasteurization and inoculation with good cultures of bacteria. The best starters are possible only with the best milk.

#### WHOLE MILK STARTERS.

Where whole milk is used for making starters the cream should always be skimmed off before using the starter. Indeed it is good practice to skim off the top of any starter before using as the surface is liable to become contaminated from exposure to the air.

#### ACIDITY OF STARTERS.

It has already been stated that a starter is at its best immediately after it has thickened when it usually shows about .7% acid. It must not be supposed, however, that all starters are at their best when they show this amount of acid, because different starters thicken with different degrees of acidity. Nor must it be supposed that a starter that tends to sour very quickly is better than one that sours slowly. Marshall, of the Michigan Agricultural College, has recently found that when certain alkali producing bacteria are associated with the lactic acid organisms the milk sours more quickly than when the alkali bacteria are not present. These alkali producing bacteria, while they hasten the souring, produce an undesirable flavor. This probably explains why starters that have a tendency to sour very rapidly are often inferior to those

that sour less rapidly. Usually, too, starters after they have been propagated for some time, become intensely acid producing, which is probably due to contamination with the peculiar alkali producing bacteria.

#### RENEWAL OF STARTERS.

Under average creamery conditions it is policy to renew the starter at least once a month by purchasing a new bottle of culture. It will be found that after the starter has been propagated for two or three weeks bad germs will begin to manifest themselves as a result of imperfect pasteurization, contamination from the air, or from overripening, so that its original good flavor may be seriously impaired at the end of one month's use. It is only where the utmost precautions are taken in pasteurizing the milk and ripening the starter, that it is possible to propagate a starter for many weeks and still maintain a good flavor.

#### VALUE OF CARRYING SEVERAL STARTERS.

There is always some possibility of losing a starter by overripening or by accidental contamination which would deprive the butter maker of the use of a starter for several days. To insure against this, butter makers should practice carrying a few extra ones in quart cans. This has the additional advantage of offering some choice. The best is, of course, always selected for regular use. The milk for the small starters should be sterilized rather than pasteurized.

This practice of carrying several starters is strongly recommended.



## STARTER CANS.

The most difficult thing in connection with starters is to get them just ripe when ready to use. A starter has its best flavor right after it has thickened. When it begins to show whey it indicates that the ripening has gone too far and should not then be used in the cream. The strong and curdy flavors found in butter are often directly attributable to overripened starters.

It is evident that to secure the proper acidity in the starter from day to day, cans or vats must be used in which it is possible to obtain perfect control of temperature. The improved modern starter cans answer the requirements. They are provided with a double jacket between which steam, hot water, cold water, or ice water may be circulated. They are also provided with power agitators.

## MOTHER STARTERS.

About two per cent of the bacteria in milk are present in the form of spores in which condition they cannot be destroyed by the ordinary pasteurizing process. To destroy the spores, or to render milk sterile, requires pasteurization on three successive days. It is for this reason that mother starters should be carried independently of the regular starter, the milk for which it is impracticable to sterilize.

A good method of handling the mother starter is as follows:

Have a tinner make four narrow cylindrical tin cans, each large enough to hold the mother starter for one day. Number the cans 1, 2, 3, 4. The first day pasteurize can No. 1; the second day pasteurize cans Nos. 1 and 2; the

third day pasteurize cans Nos. 1, 2 and 3. Can No. 1 has now been pasteurized three times which makes it sterile. Inoculate this can with a bottle of pure culture of lactic acid bacteria. The next day pasteurize cans Nos. 2, 3 and 4 and inoculate can No. 2 from can No. 1, the former having now been pasteurized on three successive days. The next day pasteurize cans Nos. 1, 3 and 4 and inoculate can No. 3 from can No. 2. And so the process is continued day after day. The mother starters thus prepared are used to inoculate the regular starter milk for cream ripening.

The pasteurization of the small cans is best accomplished in a whisky barrel sawed in two. The cans are put into the half barrel and the latter is then covered with a piece of oilcloth or other material and a small stream of steam turned into the barrel. The cans being narrow, only a small amount of steam is required to heat the milk close to 200° F. Half an hour of heating will usually be found sufficient. The milk should be kept at 170° F. or above for at least 15 minutes. The cans are cooled in the same barrel with cold water, the overflow of the barrel being placed at least two inches below the top of the cans.

#### POINTERS ON STARTERS.

1. Starters give best results when added to cream immediately after they have thickened.
2. An overripe starter produces somewhat the same effect in butter as overripened cream. Curdy flavors are usually the result of such starters.
3. To prevent overripening, starter cans or starter vats must be used in which the temperature can be kept under perfect control.

4. Skim-milk furnishes the best medium for starters, since this has undergone the cleansing action of the separator and is free from fat, which hampers the growth of lactic acid bacteria.

5. Agitate and uncover the milk while heating to insure a uniform temperature and to permit undesirable odors to escape.

6. Always dip the thermometer in hot water before inserting it in pasteurized milk. The pasteurizing process becomes a delusion when dirty thermometers are used for observing temperatures.

7. Always use a sterilized can for making a new starter.

8. Keep the starter can loosely covered after the milk has been heated to prevent germs from the air getting into it.

9. Stir the starter occasionally the first five hours after inoculation to insure uniform ripening.

10. Never disturb the starter after it has begun thickening until ready to use.

11. When a new bottle of commercial culture is used, the first two starters from it should not be used in cream as the flavor is usually inferior on account of the slow growth of the bacteria and the undesirable flavor imparted by the medium in which the cultures are sent out. A commercial starter is usually at its best after it has been propagated a week.

12. Always sterilize the neck of a new bottle of culture before emptying the contents into sterilized skim-milk.

**Starter a Vast Army Fighting Against Evil Doers.** The lactic acid germs are antagonistic to the other species of bacteria and the two classes may well be likened to two armies on the field of battle. In cream there are

frequently as many of the taint producing organisms present as of the lactic acid kind. But by adding a reasonable amount of starter to such cream, the lactic acid bacteria will so far outnumber the others that a good flavor may be expected.

In order to better understand how the addition of a good starter will increase the fighting force of lactic acid bacteria in cream, we have represented in the accompanying illustration the relative number of good and bad bacteria present in a given sample of cream just before and just after the addition of starter.

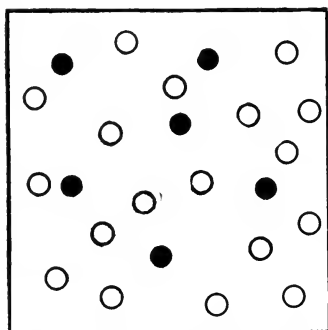

Fig. A. Cream just before adding starter.

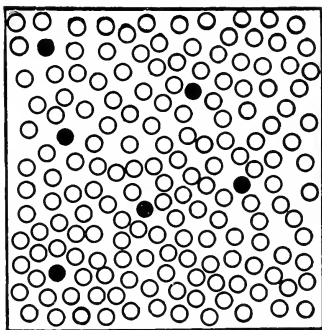

Fig. B. Same cream just after adding 10% of starter.

Fig. A represents a sample of cream rather below the average in quality, assumed to contain 6,000,000 bacteria per c.c. Two-thirds of these in this instance belong to the lactic acid group, which is represented by the circles. The other third of the bacteria belong to the taint producing group, which is represented by dots.

What an insignificant chance taint-producing bacteria have to taint cream that has been treated with a good starter compared with their opportunity for mischief in the same cream, untreated!

## CHAPTER IX.

### CHURNING.

Under the physical properties of butter fat it was mentioned that this fat existed in milk in the form of extremely minute globules, numbering about 100,000,000 per drop of milk. In rich cream this number is increased at least a dozen times owing to the concentration of the fat globules during the separation of the milk.

So long as milk and cream remain undisturbed, the fat remains in this finely divided state without any tendency whatever to flow together. This tendency of the globules to remain separate was formerly ascribed to the supposed presence of a membrane around each globule. Later researches, however, have proven the falsity of this theory and we know now that this condition of the fat is due to the surface tension of the globules and to the dense layer of casein that surrounds them.

Any disturbance great enough to cause the globules to break through this caseous layer and overcome their surface tension will cause them to unite or coalesce, a process which we call *churning*. In the churning of cream this process of coalescing continues until the fat globules have united into masses visible in the churn as butter granules.

### CONDITIONS THAT INFLUENCE CHURNING.

There are a number of conditions that have an important bearing upon the process of churning. These may be enumerated as follows:

1. Temperature.
2. Character of butter fat.
3. Acidity of cream.
4. Richness of cream.
5. Amount of cream in churn.
6. Speed of churn.
7. Abnormal fermentations.

**1. Temperature.** To have the microscopic globules unite in churning they must have a certain degree of softness or fluidity which is greater the higher the temperature. Hence the higher the temperature, within certain limits, the quicker the churning. To secure the best results the temperature must be such as to churn the cream in from thirty to forty-five minutes. This is brought about in different creams at quite different temperatures.

The temperature at which cream must be churned is determined primarily by the character of the butter fat and partly also by the acidity and richness of the cream.

*Rule for Churning Temperature.* A good rule to follow with regard to temperature is this: When the cream enters the churn with a richness of 30 to 35 per cent and an acidity of .5 to .6 per cent, the temperature should be such that the cream will churn in from thirty to forty-five minutes. This will insure an exhaustive churning and leave the butter in a condition in which it can be handled without injuring its texture. Moreover, the buttermilk can then be easily removed so that when a plug is taken with a trier the day after it is churned the brine on it will be perfectly clear.

**2. Character of Butter Fat.** The fat globules in cream from different sources and at different times have the proper fluidity to unite at quite different temperatures.

This is so because of the differences in the relative amount of "soft" and "hard" fats of which butter fat is composed. When the hard fats largely predominate the butter fat will of course have a high melting point. Such fat may be quite hard at a temperature of  $60^{\circ}$  while a butter fat of a low melting point would be comparatively soft at this temperature. For a study of the conditions that influence the hardness of butter fat the reader is referred to the discussion of the "insoluble fats" treated in the chapter on milk.

**3. Acidity of Cream.** This has a marked influence on the churning process. Sour or ripened cream churns with much greater ease than sweet cream because the acid renders it less viscous. The ease with which the fat globules travel in cream becomes greater the less the viscosity. Ripe cream will therefore always churn more quickly than sweet cream. Ripe cream also permits of a higher churning temperature than sweet which is of great practical importance where it is difficult to secure low churning temperatures.

**4. Richness of Cream.** It may naturally be inferred that the closer the fat globules are together the more quickly they will unite with the same amount of concussion. In rich cream the globules are very close together which renders it more easily churnable than thin cream. The former can therefore be churned in the same length of time at a lower temperature than the latter.

The ideal richness lies between 30% and 35%. A cream much richer than this will stick to the sides of the churn which reduces the amount of concussion. The addition of water to the churn will overcome this stickiness and cause the butter to come in a reasonable length of

time. It is better, however, to avoid an excessive richness when an exhaustive churning is to be expected.

**5. Amount of Cream in Churn.** The best and quickest churning is secured when the churn is one-third full. With more or less cream than this the amount of concussion is reduced and the length of time in churning correspondingly increased.

**6. Speed of Churn.** The speed of the churn should be such as to produce the greatest possible agitation or concussion of the cream. Too high or too low a speed reduces the amount of concussion. The proper speed for each particular churn must be determined by experiment.

**7. Abnormal Fermentations.** The slimy or ropy fermentation sometimes causes trouble in churning by rendering the cream excessively viscous. Cream from single herds may become so viscous as to render churning impossible. At creameries where milk is received from many herds very little trouble is experienced from these fermentations.

#### CHURNS.

A churn is a machine in which the cream is made to slide or drop, or is in some way agitated to bring about the union of the fat globules, which changes the liquid fat into a solid. For many years the factory churns had assumed the form of a box or barrel free from any inside fixtures. Such churns were revolved by power and did very satisfactory work. But it was necessary to transfer the butter, after it was churned, to a worker upon which it was worked.

This transfer from one piece of apparatus to another was obviated by the invention of "combined" churns and



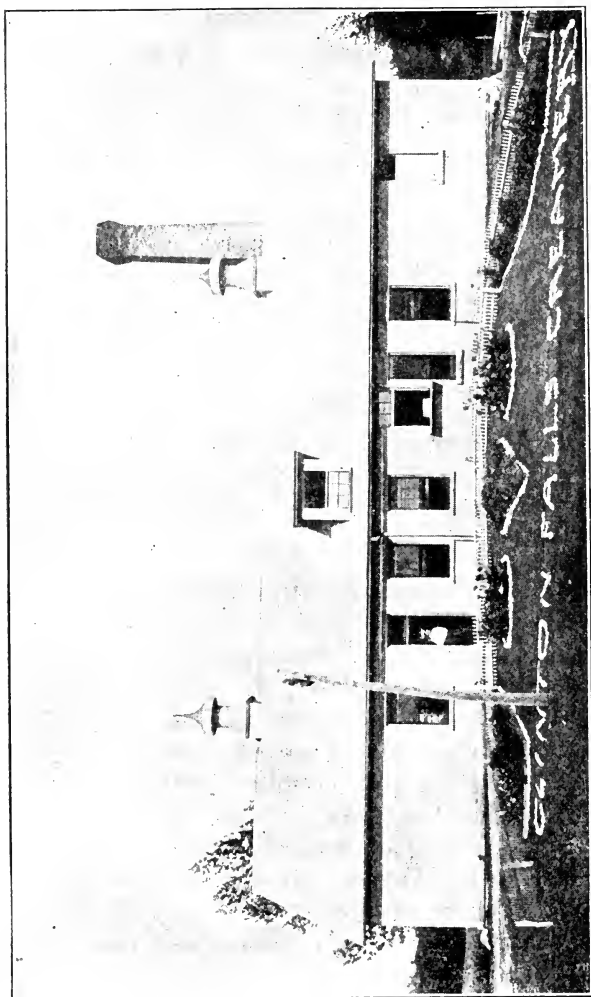

Fig. 25. — Creamery surroundings that teach patrons a valuable lesson in cleanliness.

workers. These are provided with rollers inside, which remain stationary during churning, but can be made to revolve when it is desired to work the butter.

The combined churns have to a great extent replaced the old box and barrel styles because of the many advantages they possess over the latter. The principal advantages may be stated as follows:

1. They occupy less space.
2. Require less belting and fewer pulleys.
3. The churn can be kept closed while working which keeps the warm air and flies out during the summer.
4. The butter can be made with considerably less labor.

A few disadvantages might be mentioned such as the greater original cost and the greater difficulty of cleaning and salting. But with proper care the butter may be evenly salted and the churns kept clean.

#### CHURNING OPERATIONS.

A medium rich cream well soured and at the right temperature, will make churning a comparatively simple operation. Great losses are suffered, both in quantity and in quality, by churning cream at too high a temperature. No matter how good the churn or how good the buttermaker, if proper cooling facilities are lacking, the results will be unsatisfactory not only in churning but in ripening the cream as well. A few degrees in temperature will make a big difference in results.

**Preparing the Churn.** Before adding the cream, the churn should be scalded with hot water and then thoroughly rinsed with cold water. This will "freshen"

the churn and fill the pores of the wood with water so that the cream and butter will not stick.

**Straining Cream.** All cream should be carefully strained into the churn. This removes the possibility of white specks in butter which usually consist of curd or dried particles of cream.

**Adding the Color.** The amount of color to be added depends upon the kind of cream, the season of the year, and the market demands.

Jersey or Guernsey cream requires much less color than Holstein because it contains more natural color.

During the summer when the cows are feeding on pastures the amount of color needed may be less than half that required in the winter when the cows are feeding on dry feed.

Different markets demand different shades of color. The butter must therefore be colored to suit the market to which it is shipped.

In the winter time about one ounce of color is required per one hundred pounds of butter. During the summer less than one-half ounce is usually sufficient.

In case the color is not added to the cream (through an oversight) it may be added to the butter at the time of working by thoroughly mixing it with the salt. When the colored salt has been evenly distributed through the butter the color will also be uniform throughout.

*Kinds of Color.* There are two classes of butter color found upon the market. One is a vegetable color having its origin in the annatta and other plants, the other is a mineral color, a product of coal tar. Both are entirely satisfactory so far as they impart to butter a desirable color. But from a sanitary standpoint the vegetable color

seems to be preferred and this is the color now used in creameries.

**Gas in Churn.** During the first five minutes of churning the vent of the churn should be opened occasionally to relieve the pressure developed inside. This pressure according to Babcock "is chiefly due to the air within becoming saturated with moisture and not to gas set free from the cream."

**Size of Granules.** Butter should be churned until the granules are about half the size of a pea. When larger than this it is more difficult to remove the buttermilk and distribute the salt. When smaller, some of the fine grains are liable to pass out with the buttermilk, and the percentage of water in the butter is reduced. When the granules have reached the right size, cold water should be added to the churn to cause the butter to float. Salt will answer the same purpose. The churn is now given two or three revolutions and the buttermilk drawn off.

**Washing Butter.** One washing in which as much water is used as there was cream is usually sufficient. When butter churns very soft two washings may be advantageous. Too much washing is dangerous, however, as it removes the delicate flavor of the butter.

Too much emphasis cannot be laid upon the importance of using clean, pure water for washing. Experiments conducted at various experiment stations have shown that impure water seriously affects the flavor of butter. When the water is not perfectly pure it should be filtered or pasteurized.

#### SALTING.

It is needless to say that nothing but the best grades of salt should be used in butter. This means salt readily

soluble in water and free from impurities. If there is much foreign matter in salt, it will leave a turbid appearance and a slight sediment when dissolved in a tumbler of clear water.

**Rate of Salt.** The rate at which butter should be salted, other conditions the same, is dependent upon market demands. Some markets like Boston require much salt in butter while some buyers in the New York market require scarcely any. The butter maker must cater to the markets with regard to the amount of salt to use as he does with regard to color.

The rate of salt used does not necessarily determine the amount contained in butter. For instance it is perfectly possible under certain conditions to get a higher percentage of salt in butter by salting at the rate of one ounce per pound than is possible under other conditions by salting at the rate of one and a half ounces. This means that under some conditions of salting more salt is lost than under others.

The amount of salt retained in butter is dependent upon :

1. Amount of drainage before salting.
2. Fineness of butter granules.
3. Amount of butter in churn.

1. When the butter is salted before the wash water has had time to drain away, any extra amount of water remaining will wash out an extra amount of salt. It is good practice, however, to use a little extra salt and drain less before adding it as the salt will dissolve better under these conditions.

2. Small butter granules require more salt than large ones. The reason for this may be stated as follows: The surface of every butter granule is covered with a thin

film of water, and since the total surface of a pound of small granules is greater than that of a pound of larger ones, the amount of water retained on them is greater. Small granules have therefore the same effect as insufficient drainage, namely, washing out more salt.

3. Relatively less salt will stick to the churn in large churnings than in small, consequently less will be lost.

**Standard Rate.** The average amount of salt used in butter made in the combined churns comes close to one and a half ounces per pound of butter. But the rate demanded by different commission men may vary from no salt to two and a half ounces per pound of butter.

With the combined churns great care must be exercised to get the salt evenly distributed from one end of the churn to the other as it can not redistribute itself in the working.

**Brine Salting.** This consists in dissolving the salt in water and adding it to the butter in the form of a brine. This will usually insure an even distribution with less working since the salt is already dissolved. Where butter containing a high percentage of salt is demanded the method of brine salting is not practical, because it limits the amount that can be incorporated in butter.

Where there is difficulty in securing an even distribution of the salt without excessive working, an oversaturated brine may be used to advantage. Salt added to butter in this form very quickly dissolves and a butter with any degree of salt is possible.

But it is believed that where butter is drained little and a somewhat higher rate of salt is used, dry salting will never require overworking and will insure greater uniformity than is possible with brine salting.

**Object of Salting.** Salt adds flavor to butter and

materially increases its keeping quality. Very high salting, however, has a tendency to detract from the fine delicate aroma of butter while at the same time it tends to cover up slight defects in the flavor. As a rule a butter maker will find it to his advantage to be able to salt his butter rather high.

**Salt an Absorbent.** Salt very readily absorbs odors and must therefore be kept in clean, dry places where the air is pure. Too frequently it is stored in musty, damp store rooms where it will not only lump, but become impregnated with bad odors which seriously impair the quality of the butter.

#### WORKING BUTTER.

The chief object in working butter is to evenly incorporate the salt. Working also assists in expelling moisture.

After the wash water has sufficiently drained away, the salt is carefully distributed over the butter and the churn revolved a few times with the rollers stationary. This will aid in mixing the salt and butter. The rollers are then set in gear and the butter worked until the salt has been evenly distributed. To work butter twice reduces the water content but is a safeguard against mottles.

**How Much to Work.** Butter is worked enough when the salt has been evenly distributed. Just when this point has been reached can not always be told from the appearance of the butter immediately after working. But after four or six hours standing the appearance of white streaks or mottles indicates that the butter has not been sufficiently worked. The rule to follow is to work the butter just enough to prevent the appearance of mottles

after standing about six hours. Just how much working this requires every butter maker must determine for himself by experiment, for the reason that there are a number of conditions that influence the length of time that butter needs to be worked in a combined churn. These conditions are :

1. Amount of butter in the churn.
2. Temperature of the butter.
3. Time between workings.
4. Size of granules.
5. Solubility of salt.

1. When there is a moderately large amount of butter in the churn the working can be accomplished with fewer revolutions than with a small amount. Satisfactory working can not be secured, however, when the capacity of the churn is overtaxed.

2. Hard, cold butter is difficult to work because the particles will not knead together properly.

3. A moderately long time between workings allows the salt to dissolve and diffuse through the butter and hence reduces the amount of working.

4. Coarse or overchurned butter needs a great deal of working because of the greater difficulty of distributing the salt.

5. A salt that does not readily dissolve requires excessive working and is therefore productive of overworked butter. With such salt the brine method of salting is undoubtedly preferable.



## DIFFICULT CHURNING.

The causes of trouble in churning may be enumerated as follows: (1) thin cream, (2) low temperature, (3) sweet cream, (4) high viscosity of cream, (5) churn too full, (6) too high or too low speed of churn, (7) colostrum milk, (8) advanced period of lactation, and (9) abnormally rich cream.

**Foaming.** This is usually due to churning a thin cream at too low a temperature, or to a high viscosity of the cream. When caused by these conditions foaming can usually be overcome by adding warm water to the churn. Foaming may also be caused by having the churn too full, in which case the cream should be divided and two churnings made instead of one.

## CLEANING CHURNS.

After the butter has been removed, the churn should be washed, first with moderately hot water, next with boiling hot water containing a little alkali, and finally with hot water. If the final rinsing is done with cold water the churn dries too slowly, which is apt to give it a musty smell.

This daily washing should be supplemented once a week with a washing with lime water, which is prepared as follows: Gradually slake half a bushel of freshly burned lime by adding water to it at short intervals until about 150 pounds of water has been added. Stir the mixture once every half hour for several hours, after which allow it to remain undisturbed for about ten hours. This permits the undissolved material to settle. The clear liquid is now poured off and added to the churn, which is

slowly revolved for at least half an hour so that the lime water may thoroughly penetrate the pores of the wood.

Nothing is equal to the cleansing action of well prepared lime water and its frequent use will prevent the peculiar churn odor that is bound to develop in churns not so treated.

The outside of the churn should be thoroughly cleaned with moderately hot water containing a small amount of alkali.

**Churning Cream Immediately After Adding the Starter.** Where much hand separator cream is handled, it is usually received with varying amounts of acid, ranging in some cases from 0.15% to 0.8%. When the average acidity of the cream is such that when treated with a large amount of starter the mixture will show 0.5% acid or more, the cream should be churned as soon as the proper churning temperature can be secured. If, for example, the vat of cream shows 0.4% acid and the starter 0.7%, then one part of starter to two parts of cream would give an average acidity of 0.5%, the right amount for churning cream of moderate richness.

**Pumping Cream into the Churn.** Cream may be forced into the churn either by means of air pumps, sanitary milk and cream pumps, or with pumps working on the principle of an ordinary well pump.

The air pumps require air-tight cream ripeners for their successful operation. The air is pumped into the ripener to create sufficient pressure to force the cream into the churn. Forcing air into the ripener has the advantage of permitting the cream to be conducted to the churn through an open spout.

Pumps worked with a handle have the advantage of

enabling the buttermaker to put his cream into the churn in the morning before there is sufficient steam pressure to work pumps with the engine.

Fig. 27 shows a very satisfactory cream pump which

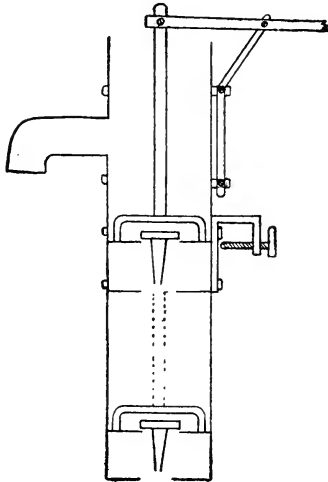

Fig. 27.—Cream pump.

can be made by any tinner. It simply consists of a heavy tin cylinder four inches in diameter which is provided with two brass valves having two inch openings. This pump is attached to the cream ripener and the cream pumped by hand into the churn through an open spout. Both valves can be removed so that there is not the slightest difficulty in cleaning the pump. Such a pump will readily pump 25 gallons of cream per minute.

## CHAPTER X.

### PACKING AND MARKETING BUTTER.

Butter is usually in the best condition for packing immediately after it has been worked. It can then be packed solidly into the packages without the vigorous ramming necessary when the butter becomes too cold. When allowed to stand in the churn some time after working during the warm summer days, the butter will usually get too soft for satisfactory packing.

There is a great variety of packages in which butter may be packed for the markets. These may be conveniently divided into two groups: (1) those used for home trade, and (2) those designed for export trade.

**Home Trade Packages.** The bulk of the butter for home trade is packed in ash and spruce tubs, the former holding 20, 30, and 60 pounds, while the latter are made in 10, 20, 30, and 50 pound sizes.

Before adding the butter, the tubs must be thoroughly scrubbed inside and outside, the hoops carefully set, and then soaked in hot water for about half an hour. After this they are steamed for three minutes and then allowed to soak in cold water not less than four hours. The sides and bottom of the tubs are next lined with parchment paper which has been soaked in strong brine for twenty-four hours. See "paraffining tubs," page 114.

The wet liners are easily placed in the tubs by allowing them to project an inch and turning this over the edge.

The tubs are now weighed and the butter packed into

them directly from the churn, adding about five pounds at a time and firmly packing it with a wooden packer made for this purpose. The butter should be packed solid so that when stripped of its package on the retailer's counter no open spaces will appear in it.

When ash tubs are used they are packed brim full and trimmed off level with the tub by running a string across the top. The tubs are then weighed and the weights marked on the outside, allowing not less than half a pound for shrinkage for a sixty pound tub. A cheese cloth circle is next placed over the top and an oversaturated brine is pasted upon this. After careful cleaning place the covers on the tubs and fasten them with not less than three butter tub fasteners.

With spruce tubs the method of packing is the same with the exception that most markets require an even number of pounds in a tub, as 30 or 50 pounds. The tubs are, therefore, trimmed down till the required weight, plus half a pound for shrinkage, is reached. Some markets do not require the spruce tubs to be lined but it is always better to do so.

*Prints.* Considerable quantities of butter made in creameries are put up in one pound oblong blocks called *prints*. Where many of these prints are made a printer like that shown in Fig. 28 is most serviceable. This makes twenty-five prints at a time.

The prints are carefully wrapped in parchment paper which has been soaked in strong brine for twenty-four hours, and then packed in cheap wood boxes which usually hold about fifty of them. These boxes should be held not less than one day in a refrigerator before they are shipped. Print butter is growing in popularity.

There are various other packages in which butter is

packed, such as five pound crocks, gem fibre paper boxes lined with parchment and holding 2, 3, 4, 5, and 10 pounds, and the wooden bail boxes holding from 5 to 10 pounds. Most of these packages are used for local trade.

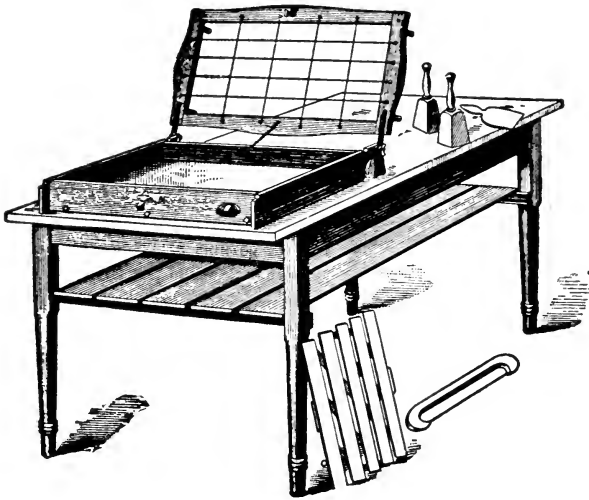

Fig. 28.—Butter printer.

**Foreign Trade Packages.** For export trade butter is preferably packed in cubical spruce boxes lined with paraffin and holding 56 pounds. These boxes are prepared by rinsing them with cold brine and then lining with parchment paper (double thickness at top and bottom) which has been soaked in brine. The boxes are now weighed and carefully packed, after which they are trimmed down to a weight of 57 pounds, which allows one pound for shrinkage. Finish the packing by placing a

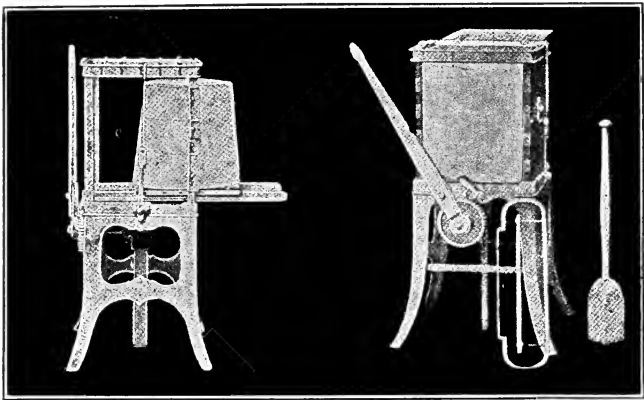

Fig. 29.—Butter printers for printing butter from square boxes and from tubs after thorough chilling in the refrigerator.

double thickness of parchment paper over the top and upon this oversaturated brine.

Butter shipped to tropical countries is packed in tin cans which are hermetically sealed.

**Paraffining Butter Packages.** During recent years buttermakers and butter dealers have suffered considerable losses from moldy butter caused by the growth of mold on the liners and on the inside of the tubs. Rogers of the United States Department of Agriculture has shown that this trouble can be prevented with certainty by coating the inside of the tub with a layer of paraffin. He says: "With paraffining not only are the molds and their spores already on the tub prevented from growing, but the wood is covered with a surface from which molds

can not get nourishment. The wood is made impervious to water, and the space between the tub and the liner remains filled with water, so that the molds which may be on the liner can not get the supply of air necessary to their growth." He has also shown that loss from shrinkage is largely prevented in this way.

Testimonials from buttermakers indicate that the practice of paraffining tubs is giving good satisfaction and many have already adopted it as a permanent feature in creamery work.

To secure the best results from the paraffin, it should be applied at a temperature of about 240° F., immediately after steaming the tub. The steaming may or may not be preceded by soaking; under present conditions, however, soaking is recommended, if for no other reason than to give tubs their full weight. Butter dealers are accustomed to handle soaked tubs and where they are not soaked, the creamery is liable to lose an amount of butter equal to the difference between the weights of the soaked and unsoaked tubs.

Special machines are now upon the market for paraffining tubs. The paraffin may, however, be applied by pouring the same into the tub and rotating the latter until it is entirely coated. A brush may also be used for this purpose. Those who contemplate paraffining should investigate the merits of the machines now upon the market.

**Printing Cold Butter.** Until recently the common practice has been to print butter directly from the churn by using printers of the style shown in Fig 28. With the advent of the "cold" butter printers or cutters, much butter is being printed outside the creameries, and the latter are also adopting the practice of cooling the butter before printing. Cold butter makes better looking prints,



injures the butter less, causes less water to be lost, facilitates the wrapping, and makes it easier to pack the butter.

The butter is preferably packed directly from the churn into square boxes of a size to fit the printer. Where butter is printed from tubs, there is too much butter left in irregular pieces, which are hard to repack and must be disposed of in bulk.

#### MARKETING BUTTER.

The producer of any commodity is always confronted with the problem of finding the best markets for his product. Indeed his success is measured more or less by his ability in handling this end of the business.

Buttermakers lose thousands and thousands of dollars every year because they do not fully understand how to manage the sale of their product. They fall into the clutches of men without credit or credentials who offer big prices but no returns. Swindlers are always on the lookout for victims and every year many buttermakers are entrapped by them. To the one who is just beginning to seek a market for his butter the following course of procedure is recommended.

1. Find the names of three or more leading reputable butter firms in the leading butter markets by inquiring of men from whom trustworthy information may be expected.

2. Divide a day's standard make among these butter firms and instruct each to send you statement as to the price they can give you net (f. o. b.) at your station for regular shipments, the price to be based on quotations of some leading market. Inform them further that you are ready and willing to comply with their demands as to color, package, and salt, in future shipments.

3. Ship your butter to the firm that offers you the best price, but do not deal with this firm exclusively. A tub should occasionally be sent to a new and reliable firm with a view to securing better prices.

4. Remember, however, that it requires time to establish a good trade for butter. Frequent changes from one firm to another are therefore undesirable.

5. Do not sell butter on commission, but ask for prices f. o. b. your station, based on some market quotation like New York, Chicago or Elgin.

6. Demand that payment shall be made for each shipment of butter within two weeks after it is sent out.

7. Never send a firm a third shipment until the first has been paid for.

8. Butter that is not up to the standard should be marked and the firm properly instructed regarding its disposition. An attempt to crowd in an inferior shipment may cost you your regular trade.

9. Do not feel hurt when criticisms come regarding defects in your butter but seek to overcome them.

10. Always allow one-half pound of butter for shrinkage on fifty and sixty pound tubs. If this allowance proves inadequate it indicates that the tubs have not been properly soaked or that the "house" is cutting you on weights.

11. Never contract butter for more than a year at a time.

**How to Sell to Commission Houses.** A common mistake in marketing butter is to sell it at prices based upon the score of the butter. This places the butter-maker at the mercy of the commission man who may, or may not, give an honest score. If he is not strictly honest he may easily place butter that would naturally grade as extras in the class of firsts, and butter

that would naturally grade as firsts in the class of seconds.

One of the best methods of selling butter to commission houses is as follows: Furnish the buyer enough samples of butter to give him a good idea as to the average quality of the butter produced by the creamery. An agreement can then be made as to the price the creamery shall receive for regular shipments, the price to be based upon some standard market quotation. If, for example, the buyer agrees that the quality of the butter merits one-half cent above Elgin, and the seller is satisfied with this price, future shipments shall be paid for at the rate of one-half cent above Elgin until such time as either party may become dissatisfied with the original agreement. If the butter maker feels that he is receiving a good price for his butter, he will do his best to maintain the standard of his product.

**Selling to Retailers and Wholesalers.** Wherever possible creameries should try to sell their butter direct to retailers and wholesale houses and in this way save the commission man's profits. This method of marketing, of course, necessitates visiting retailers and wholesalers in nearby cities, but this trouble will be more than compensated for by bringing the buttermaker in closer touch with the markets and with general market requirements.

**Branding Butter.** As with hundreds of other commodities, the branding of good butter is absolutely essential in creating a strong demand for it. A high quality butter without a distinguishing mark is bound to sell at a disadvantage because consumers are not willing to pay high prices for products about whose quality they have no positive assurance. The brand advertises the butter and increases the demand for it, and an increased demand is always followed by better prices.

## CHAPTER XI.

### CALCULATING DIVIDENDS.

Milk and cream yield butter in proportion to their butter fat content. That is the reason why practically all milk and cream made into butter are now bought by the "Babcock test," that is, on the "butter fat basis." In discussing the method of paying for milk and cream, therefore, only the "butter fat basis" will be considered.

The periodical payments made for milk and cream at creameries are known as creamery dividends. These payments or dividends are sometimes made daily, as in the case of some gathered cream plants; more often, however, they are made weekly, semi-monthly and even monthly.

The different steps in the calculation of dividends at creameries are as follows:

First, find the total pounds of butter fat received from all the patrons. This is done by finding the total amount of butter fat furnished by each patron separately and adding together the totals so found. In finding each patron's total butter fat, every delivery of cream is multiplied by its test and the results of the different deliveries added together.

Second, find the net money from the sale of butter by multiplying each sale of butter by its price and deducting from the amount thus found the cost of making the butter.

Third, find the price per pound of butter fat by divid-

ing the total net money by the total pounds of butter fat delivered by all the patrons.

Fourth, find each patron's share of the money by multiplying the total pounds of butter fat delivered by him by the price per pound of butter fat.

To make the above steps perfectly clear, let us calculate a weekly dividend at a creamery where only cream is received and where A, B and C are the patrons:

**Illustrating the First Step.** The total butter fat delivered by A, B and C is as follows:

		Pounds of cream.		Test.		Pounds of butter fat.
A.	{	May 2 .....	42	×	35.4	= 14.87
		May 4 .....	50	×	30.1	= 15.05
		May 6 .....	48	×	30.5	= 14.64
		May 7 .....	20	×	36.6	= 7.32
		Total .....				51.88
B.	{	May 2 .....	23	×	40.5	= 9.32
		May 4 .....	29	×	30.0	= 8.00
		May 6 .....	25	×	36.4	= 9.10
		May 7 .....	13	×	35.0	= 4.55
		Total .....				30.97
C.	{	May 2 .....	64	×	33.0	= 21.12
		May 4 .....	69	×	31.1	= 21.46
		May 6 .....	58	×	37.5	= 21.75
		May 7 .....	30	×	34.4	= 10.32
		Total .....				74.65

The total butter fat delivered by A, B and C equals 51.88 + 30.97 + 74.63 equals 157.48 pounds.

**Illustrating the Second Step.** The net money is found as follows:

	Pounds of butter sold.	Price per pound.		Amount.
May 3 .....	86	× 26½c	=	\$22.79
May 7 .....	103	× 26c	=	26.78
<hr style="width: 20%; margin: 0 auto;"/>				
Total lbs. butter.....	189	Total money		\$49.57

At 3½ cents a pound for making, the cost of manufacture will be  $3\frac{1}{2} \times 189$ , or \$6.62. Deducting this amount from the total money, there remains \$42.95, which is the total net money due the patrons.

**Illustrating the Third Step.** The price per pound of butter fat is obtained by dividing the total net money found in step two by the total pounds of butter fat found in step one. Thus:  $\$42.95 \div 157.48 = 27.27$  cents = price per pound of butter fat.

**Illustrating the Fourth Step.** Find the money due each patron by multiplying the butter fat furnished by him as determined in step one by the price per pound of butter fat as determined in step three. Thus:

$$\begin{array}{rclcl}
 51.88 & \times & \$.2727 & = & \$14.15 & = & \text{A's money.} \\
 30.97 & \times & .2727 & = & 8.44 & = & \text{B's money.} \\
 74.65 & \times & .2727 & = & 20.36 & = & \text{C's money.}
 \end{array}$$

#### WHERE WHOLE MILK IS RECEIVED.

The method of calculating dividends at whole milk creameries is the same as that at hand separator creameries except that a test is not made of each delivery of milk. Where whole milk is received a composite sample is made of each patron's milk; that is, each patron is provided with a pint jar to which samples of his milk are added daily for one or two weeks when the composite sample is tested. A test of the composite sample represents the

average per cent of butter fat in the milk for the period during which the sample was gathered.

The method of composite sampling employed by whole milk creameries is also used to some extent at hand separator creameries, but unless the cream is delivered in a fine, sweet condition, sufficiently accurate results cannot be obtained with this method. Usually hand separator cream is delivered in a more or less sour condition which does not permit of composite sampling. The fact that the deliveries of cream vary considerably in quantity and richness is a further reason why the composite method of testing cream is liable to lead to inaccurate results.

WHERE BOTH MILK AND CREAM ARE RECEIVED.

The calculation of dividends at creameries receiving both milk and cream differs from the method used where only milk or cream is received in that allowance must be made for the fat lost in the milk skimmed at the creamery. On an average 2 per cent of the total fat of milk is lost in the skimming process. Hence, if cream patrons are credited with all the fat they bring in the cream, it will be necessary to deduct 2 per cent of the fat brought in the milk by the whole milk patrons, which represents the amount carried home by them in the skimmed milk.

Heretofore most creameries have equalized the payment for milk and cream by increasing the butter fat from cream patrons by 2 per cent, which, so far as dollars and cents are concerned, will have the same effect as deducting 2 per cent from the fat delivered by whole milk patrons. The latter method, however, results in a greater overrun and therefore in a greater price per pound of butter fat. In order, therefore, to put cream-

eries receiving both whole milk and cream on a par with those receiving only cream, so far as overrun and price per pound of fat is concerned, it will be necessary to deduct 2 per cent from the fat delivered by whole milk patrons and not, as commonly done, add 2 per cent to the fat delivered by cream patrons.

The following example illustrates how milk and cream patrons are credited with butter fat in making dividends at creameries receiving both milk and cream:

Patron A delivers 6,500 pounds of milk testing 4.0 per cent.

Patron B delivers 600 pounds of cream testing 30 per cent.

A's total fat =  $6,500 \times .04 = 260$  pounds. B's total fat =  $600 \times .30 = 180$  pounds. To decrease A's fat by 2 per cent, multiply 260, the total pounds of fat furnished in his milk, by .98, which equals 254.8.

In making the dividend, therefore, A is paid for 254.8 pounds of fat and B for 180 pounds.

#### THE TWO PER CENT—HOW CALCULATED.

In a well conducted creamery the average loss of fat in the skim-milk should not be more than .078%. Dividing this figure by the average percentage of fat in milk, 3.9, we get .02. So that in the separating process, .02 pound of fat is lost in the skim-milk for every pound of fat present in the milk.

From the above calculation it will be seen that the cream factor (2%) would necessarily vary with the efficiency of skimming and the average test of the milk. To determine what this shall be for any particular creamery divide the average loss of fat in the skim-milk by the average test of the milk at the creamery.



## METHODS OF PAYING FOR MILK AND CREAM.

While practically all creameries buy milk or cream according to the amount of fat contained in it, the method of paying for same varies with different creameries. With proprietary whole milk creameries, the usual custom has been to guarantee patrons a certain price for butter based upon some leading market quotation and charge a fixed price for making the butter, say  $3\frac{1}{2}$  cents per pound. All of the butter made belongs to the patrons.

Cooperative creameries, as a rule, pay for butter fat according to the net returns from the creamery; that is, they deduct from the total gross returns the actual cost of making the butter, plus a small sinking fund, and divide the balance on the basis of the amount of butter fat furnished by each.

Many hand separator creameries, and most of the centralizers, pay for butter fat according to market quotations on butter. The price paid averages, as a rule, from one to three cents below the average market price for butter, transportation charges being paid by the creamery.

## AVERAGING TESTS.

In whole milk creameries, where the amount of milk delivered from day to day and the tests of the same vary but slightly, reasonably accurate results may be obtained by averaging two composite tests, each representing, say, one week's milk. With cream the matter is different. Cream deliveries from the same patron vary considerably in quantity and quality and hence averaging cream tests is almost certain to lead to fallacious results, as may be seen from the following example:

The quantity and quality of cream delivered by a certain patron for three days is as follows:

Date.	Lbs. cream.	Per cent fat.
May 1 .....	33	40.5
May 2 .....	48	30.0
May 3 .....	55	28.5
	136	3)99.0
		33.0

Wrong average test =

Wrong total fat =  $136 \times 33 = 44.88$  lbs.

The correct average test is obtained by multiplying each delivery of cream by its test and dividing the total butter fat thus found by the total number of pounds of cream and multiplying the quotient by 100. Thus:

Lbs. cream.	Per cent fat.	Lbs. fat.
33	40.5	13.36
48	30.0	14.40
55	28.5	15.68
136		43.44

Correct average test =  $(43.44 \div 136) \times 100 = 31.94\%$ .

Correct total fat = 43.44.

#### CREAMERY STATEMENT.

When the monthly or weekly payment is made, each patron is presented with an envelope upon which is printed his individual account with the creamery and also the entire transactions of the creamery. A check on the nearest bank, or the money, is placed in the envelope and handed to the patron on "pay day." Such a statement is shown on the next page.

**Creamery Co.**

IN ACCOUNT WITH

Mr. \_\_\_\_\_

For the month of \_\_\_\_\_ 190\_\_\_\_\_

Cr.	Dr.
No. lbs. milk delivered	Lbs. butter.....@.....
by you, - - - .....	Cans, @.....
Average test. - .....	Cash, - - - .....
No. lbs. of butter fat, .....	Hauling, @.....
Price per lb. " " .....	per 100 lbs., - .....
\$.....	\$.....

Balance due you,           -       -       -       \$ \_\_\_\_\_

Total lbs. milk delivered at creamery, -       -       \_\_\_\_\_

Average test at creamery,           -       -       \_\_\_\_\_

Total lbs. of Butter fat at creamery, -       -       \_\_\_\_\_

Sales of Butter.	{	_____ lbs. @ _____ \$ _____
		_____ " " _____ _____
		_____ " " _____ _____
		_____ " " _____ _____

Less \_\_\_\_\_ cts. for making.

Balance due patrons,           -       -       -       \$ \_\_\_\_\_

Per cent. overrun           -       =       =       \_\_\_\_\_

Testing witnessed by \_\_\_\_\_

\_\_\_\_\_ Prest.

\_\_\_\_\_ Sec'y.

## CHAPTER XIa.

### ACTUAL OVERRUN.

In a well conducted creamery the total pounds of butter made is always greater than the total pounds of butter fat received; the difference is called the overrun. Thus, if during a certain time a creamery makes 2,400 pounds of butter from 2,000 pounds of butter fat, the overrun equals 2,400 less 2,000, or 400 pounds. The *per cent* of overrun is found by dividing the number of pounds of overrun by the total pounds of butter fat received and multiplying the quotient by 100. Putting this in the form of a formula, we have:

$$\left. \begin{array}{l} \text{Per cent} \\ \text{Overrun} \end{array} \right\} = \frac{\text{pounds of overrun}}{\text{total pounds of butter fat}} \times 100$$

Where 2,000 pounds of butter fat will make 2,400 pounds of butter, the overrun will therefore equal:

$$\frac{400}{2000} \times 100, \text{ or } 20\%.$$

A mistake not uncommonly made in calculating the per cent overrun is to divide the pounds of overrun by the total pounds of butter, instead of the total pounds of butter fat.

### FACTORS THAT INFLUENCE THE OVERRUN.

It is well known that the overrun varies considerably at different creameries as well as at the same creamery.

The amount of overrun is directly dependent upon the following factors:

1. Efficiency of skimming and churning.
2. Composition of the butter.
3. Richness of milk and cream.
4. Mechanical losses.
5. Correct reading of tests.

**Efficiency of Skimming and Churning.** It is evident that the more fat there is lost in skimming and churning the lower will be the overrun. To obtain a maximum overrun, the loss of fat as shown by the Babcock test should not exceed 0.05 per cent for skim-milk and 0.15 per cent for buttermilk.

In this connection it should be stated that during the summer season it is not at all uncommon to find buttermilk testing from 0.3 to 0.5 per cent, largely a result of employing too high a churning temperature.

**Composition of the Butter.** Besides butter fat, butter contains water, curd and salt, and, other conditions the same, the greater the amount of non-fatty matter in butter the greater the overrun. Water, being present in large quantity and subject to considerable variation, very appreciably affects the percentage of overrun. There has been a tendency among creameries the past few years to manipulate butter so as to increase its normal water content and thereby increase the overrun.

The water in butter easily fluctuates between 10 and 15 per cent, and a good overrun can be obtained by keeping it within the limits of 13 and 14 per cent.

Salt as a rule has little influence on the per cent of overrun because under normal conditions an increase in

the amount of salt usually results in a decrease in the amount of water. Of course, where special methods of manipulating the water content are resorted to, it is possible to increase the overrun by increasing the amount of salt.

Curd is present in butter in very small quantities, and its influence on the overrun is very slight.

**Richness of Milk and Cream.** The test of skim-milk is practically independent of the richness of the milk—that is, other conditions the same, skim-milk from 2.5% milk will test the same as that from 5 per cent milk. But since it takes twice as much 2.5 per cent milk to obtain 100 pounds of butter fat as is required with 5 per cent milk, it follows that the loss of fat in the skim-milk will be twice as great with the poorer milk.

Assuming a loss of 0.05 per cent fat in the skim-milk, the loss of fat in the amount of milk needed to yield 100 pounds of butter fat is one pound greater for the poorer milk. The extra pound of fat thus lost would have made approximately 1.18 pounds of butter, so that the overrun from a 5 per cent milk may be expected to be approximately 1.18 per cent greater than that from milk testing 2.5 per cent.

Rich cream yields a higher overrun than poor cream because of the smaller loss of fat in the buttermilk. That is, there is less buttermilk from rich cream than poor cream, and, since the per cent of butter fat in the buttermilk will be about the same in both cases, it follows that the loss will be greater from the poor cream, which yields the greater amount of buttermilk.

Assuming a loss of 0.2 per cent of fat in the buttermilk, 100 pounds of butter fat in 35 per cent cream will

yield about one-half pound more of butter than the same amount of fat in a 20 per cent cream; in other words, the overrun from a 35 per cent cream will be one-half per cent greater than that from a 20 per cent cream.

**Mechanical Losses.** By mechanical losses is meant the small losses of cream remaining in cans, vats, strainers, etc., and the butter particles remaining in the churns and on the packers, butter spades, etc. Where care is exercised in properly rinsing the cans and ripeners and in the handling of the butter, losses from this source will be rather slight. On the other hand, carelessness in these matters may result in heavy losses and in a material lowering of the overrun.

**Correct Reading of Tests.** It is very evident that a little too high or a little too low a reading will materially affect the overrun. If a cream whose actual test is 30 per cent should be read only 29 per cent, the overrun will be abnormally increased by approximately 4.0 per cent. It is easy to make a mistake of one per cent in the reading of cream tests and, what is worse, many cream tests are purposely read too low so as to enable the creameryman to show a big overrun. It is to every creameryman's interest to read tests accurately, because inaccuracies are bound to be discovered sooner or later and may lead to the disruption of the creamery.

**Per Cent Overrun.** The overrun from whole milk should average about 18%, that from gathered cream, 20%.

## CHAPTER XII.

### THEORETICAL OVERRUN.

For the purpose of instructing patrons with regard to the percentage of overrun the following calculation is submitted which incidentally involves the calculation of the amount of skim-milk and buttermilk to be returned from 100 pounds of milk, a calculation with which every butter maker should be familiar.

1. To calculate the amount of skim-milk per 100 pounds of milk.

Rule: Divide the per cent of fat in milk by the per cent of fat in cream and multiply the result by 100; the product subtracted from 100 will be the number pounds of skim-milk.

Example: How much skim-milk is obtained from 100 pounds of 4% milk when the separator delivers a 40% cream?

$$4 \div 40 = .10, .10 \times 100 = 10, 100 - 10 = 90 = \\ \text{No. lbs. skim-milk.}$$

COROLLARIES. (1) The richer the milk and the poorer the cream the less skim-milk.

(2.) The poorer the milk and the richer the cream the more skim-milk.

To allow for variations in richness of cream and small overweights at the creamery, 3 should be subtracted from the calculated amount of skim-milk. Thus in the problem above, the skim-milk should be distributed on the basis of 87 instead of 90 pounds per 100 pounds of milk as calculated.



2. To calculate the amount of buttermilk per 100 pounds of milk.

Rule: This is approximately found by increasing the pounds of butter fat in the cream by one-sixth and subtracting the result from the total pounds of cream.

Example: How much buttermilk from 100 pounds of 4% milk yielding 10 pounds of cream testing 40%?

$$\begin{aligned} 10 \times .40 &= 4.0 = \text{lbs. of butter fat.} \\ 4 \times 1 \frac{1}{6} &= 4.66, \quad 10 - 4.66 = 5.34 = \text{No. lbs.} \\ &\text{buttermilk.} \end{aligned}$$

OVERRUN. The method of calculating the *actual* overrun at creameries has already been discussed in Chapter XI. With the following known conditions the *theoretical* overrun can be calculated with a fair degree of accuracy:

- (1) Average per cent of fat in butter.
- (2) Loss of fat in skim-milk.
- (3) Loss of fat in buttermilk.

Problem: 100 pounds of milk testing 4% yields cream testing 40%. Test of skim-milk is .05%, that of buttermilk .15%. Per cent of fat in butter is 84. Calculate butter and overrun.

By applying the rules for calculating skim-milk and buttermilk we find that there will be 90 pounds of skim-milk and 5.34 pounds buttermilk.

$$\begin{aligned} .90 \times .05 &= .045 = \text{lb. fat in skim-milk.} \\ .0534 \times .15 &= \underline{.008} = \text{lb. fat in buttermilk.} \\ \text{Total loss} &= .053 \\ 4 - .053 &= 3.947 = \text{fat made into butter.} \\ 3.947 \div .84 &= 4.70 = \text{lbs. butter made.} \\ 4.70 - 4 &= .70 = \text{overrun in lbs.} \\ .7 \div 4 \times 100 &= 17.5 = \text{overrun in per cent.} \end{aligned}$$

## CHAPTER XIII.

### HANDLING OF SKIMMILK AND BUTTERMILK.

In recent years much attention has been given to the problem of skim-milk distribution at creameries. The old way of weighing on a common pair of scales is too slow and tedious. Efforts to improve upon this method of weighing have resulted in bringing upon the market various kinds of automatic weighing and measuring devices such as our skim-milk weighers and check pumps. With the skim-milk weigher the patron drops into the machine a check corresponding to the amount of milk delivered, and the amount of skim-milk called for by the check is weighed or measured out automatically. In the case of the check pump the operation is somewhat different. A check is dropped into the pump and, instead of flowing out, the amount of skim-milk called for by the check is pumped out.

Some of these skimmilk weighers are giving good satisfaction when properly handled. But some of the creameries are still adhering to the old method of weighing on a common platform scales which, though tedious, is still perhaps the most accurate method.

Attention is here called to an automatic valve closing arrangement, shown in Fig. 30, which reduces the labor of weighing on a platform scales at least fifty per cent. A is a common pair of scales, B an ordinary receiving can with a two inch valve instead of a faucet, and C a device which closes the inlet valve, D, when the proper amount of skim-milk has run into the can.

It will be seen that one end of the rod, C, is attached to

the beam rod of the scales, while upon the other rests the handle which opens and closes the skim-milk valve. When the beam rises the connection is broken and the weight of the handle closes the valve. This makes it an automatic valve. Without this device the closing of the valve at the right time requires a good deal of watching which consumes too much time.

A skim-milk table like that shown below should be posted in a conspicuous place so that no time needs to be wasted in calculating each patron's skim-milk.

SKIM-MILK TABLE—85 POUNDS PER 100 POUNDS MILK.

Milk.	Skim-milk.	Milk.	Skim-milk.	Milk.	Skim-milk.	Milk.	Skim-milk.
10	8	110	93	210	178	310	263
20	17	120	102	220	187	320	272
30	25	130	110	230	195	330	280
40	34	140	119	240	204	340	289
50	42	150	127	250	212	350	297
60	51	160	136	260	221	360	306
70	59	170	144	270	229	370	314
80	68	180	153	280	238	380	323
90	76	190	161	290	246	390	331
100	85	200	170	300	255	400	340

With the automatic valve it is possible for the man who weighs in the milk also to weigh out the skim-milk with little additional work. The device is unpatented and costs not more than one dollar. Attached to an ordinary plat-

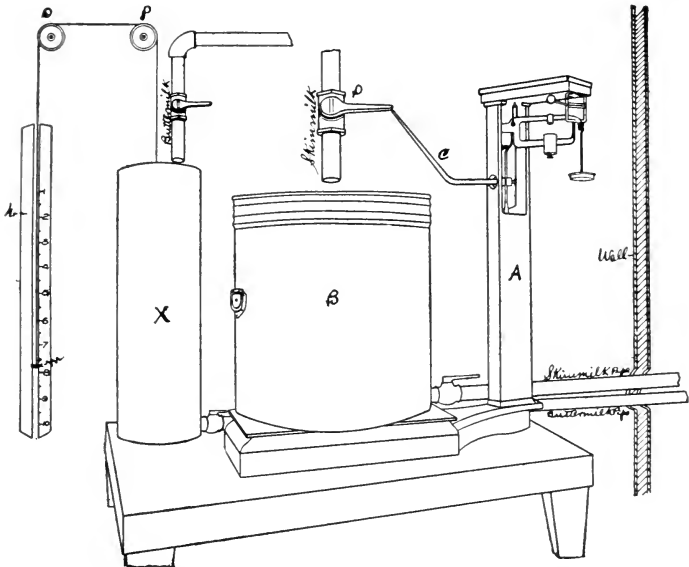

Fig. 30.—Apparatus for distributing skim-milk and buttermilk.

form scales, it furnishes with them an ideal skim-milk weigher which is cheap, simple, accurate, and needs no repairs.

#### PASTEURIZATION OF SKIMMILK.

**Objects.** There are two main purposes in pasteurizing skimmilk: One is to preserve the feeding value by

keeping it sweet; the other is to kill the tubercle bacilli that may be found in it.

To secure the greatest feeding value of skimmilk it must be fed sweet. During the summer months skimmilk as it is ordinarily returned from creameries keeps sweet but a short time, a fact which has compelled many a farmer to purchase a hand separator and separate the milk at the farm.

The danger of spreading tuberculosis among cattle and swine through creamery skimmilk is so well established now that several states have passed laws making pasteurization of skimmilk compulsory. Indeed such laws have existed in Denmark for many years.

Either of the above purposes should be sufficient to cause butter makers and creamery managers to feel it their duty to pasteurize the skimmilk without being driven to it by law.

Where the skimmilk is returned hot from the creamery, pasteurization has the additional advantage of sterilizing the milk cans.

**Pasteurizing Temperature.** The minimum temperature should be placed at  $176^{\circ}$  F, which makes it possible to determine by means of Storch's test (see appendix) whether the skimmilk has been pasteurized or not.

This minimum limit is necessary to insure a thorough destruction of bacteria. It is hardly necessary to fix a maximum limit of temperature since it is difficult to exceed  $190^{\circ}$  F, and little objection can be raised to approaching this temperature. Indeed it is believed that where thorough pasteurization is desired it is advisable to keep the temperature close to  $190^{\circ}$  F.

**Methods of Pasteurizing.** Pasteurization is accom-

plished (1) by admitting either "live" or "exhaust" steam directly to the skimmilk; (2) by admitting either live or exhaust steam to pasteurizers which do not allow the steam to come in contact with the skimmilk. The former is usually spoken of as the direct method, the latter as the indirect method.

**Direct Method.** This is the method most commonly employed by creameries at the present time, and undoubtedly so because it does not require any special outlay for pasteurizers. Where this method is employed the

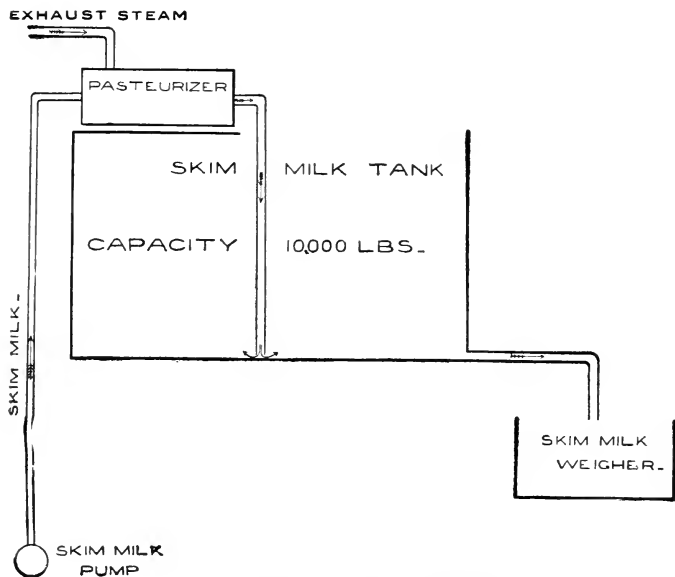

Fig. 31.—Skim-milk tank and pasteurizer

heating is usually accomplished by the use of the exhaust steam from the engine.

There are three objections to this method of pasteuriz-

ing: (1) the dilution of the skimmilk by condensed steam; (2) the cylinder oil carried into the milk where exhaust steam is used; and (3) the trouble from excessive foaming.

There are pasteurizers upon the market provided with oil traps which have been reported as eliminating the trouble from cylinder oil. The trouble from foaming can also be largely eliminated. Various so-called "foam killers" have been placed upon the market which have been more or less successful in obviating this trouble.

Fig. 31 illustrates a method of handling skimmilk which prevents, to a great extent, the difficulty usually experienced from foam.

The pasteurizer may be placed on top of the skimmilk tank and the pasteurized skimmilk allowed to flow through a pipe which runs to within an inch or an inch and a half of the bottom of the tank. A pipe so placed will tend to destroy a portion of the foam formed in the heater. The tank is of ample size to hold the foam not thus destroyed, which, during the early summer, is quite considerable. The larger the tank the less trouble will be experienced from the foam.

While the trouble from oil and foam may be largely obviated, the dilution resulting from the condensed steam must always stand as an objection to the direct method of pasteurizing skimmilk.

**Indirect Method.** Skimmilk can be pasteurized with the "continuous" style of pasteurizers in the same way as cream. This method is now employed in many creameries and should be adopted wherever possible. The extra cost of a pasteurizer is more than compensated for in doing away with the objections inherent in the direct method of

pasteurizing. With the indirect method as with the direct, either live or exhaust steam, or both, may be used.

**Cooling Undesirable.** While cooling the skimmilk has some advantages, these are more than counterbalanced by the expense necessary in doing this and by losing the sterilizing effect of the hot milk on the cans. The danger from tubercle organisms cannot be eliminated by placing (cooled) pasteurized skimmilk in cans containing residues of the original, infected milk.

**Handling Buttermilk.** To insure a just distribution of buttermilk at creameries it is necessary to either weigh or measure it out to the patrons. The long cylindrical can, X, shown at the left in Fig. 30, illustrates a very convenient and satisfactory measuring device. The measuring is done by means of a long hollow shaft, N, which consists of two boards between which a pointer, M, is made to slide. Attached to the pointer is a string which passes over pulleys, O and P, and ends in the buttermilk can where it is attached to a wooden disc floating on top of the buttermilk. As the buttermilk flows into the can the disc rises, causing the pointer to sink in the shaft. Marks on the shaft indicate the number of pailfuls measured out.

Where milk or cream is infected with tubercle organisms, the butter and buttermilk from the same will also be infected. To eliminate the danger from these sources, all cream should be pasteurized for buttermaking, and fortunately this is the prevailing tendency. Buttermilk can not be pasteurized as successfully as skimmilk, because the high temperature necessary will tend to cause the curd to separate.



## CHAPTER XIV.

### BUTTER JUDGING.

Expert butter judges, like great musicians, are "born" not "made." A good musician must be born with a good ear, a good butter judge with a good nose. Most people, however, can become fair musicians with proper training, and the same may be said of butter judges.

By repeated judging and comparing of different samples of butter one will soon become able to make fair discriminations. The important point to learn is to know an ideal butter when you see it. A butter maker can not expect to reach or even approach an ideal butter unless he has the ideal fixed in mind.

One can learn much about butter judging by daily examining his own make. But to become expert, he must be able to compare his score with that of recognized experts. Dairy conventions and butter scoring tests offer excellent opportunities for such comparison.

### BASIS FOR JUDGING.

Butter is judged commercially on the basis of 45 points for flavor, 25 for texture, 15 for color, 10 for salt, and 5 for package, total 100.

**Flavor.** Strictly speaking flavor means taste. But the use of the term flavor in butter judging usually includes both taste and aroma, the emphasis resting on the latter. Aroma is the odor noticeable when a sample of butter is held close to the nose, hence frequently called "nose" aroma.

It is difficult to describe an ideal butter flavor. It may, perhaps, be likened to the flavor of clean, uncontaminated, well ripened cream, that is, it should be rich and creamy.

**Texture.** This includes three distinct things: (1) grain, (2) body, and (3) brine.

An ideal grain is indicated by a somewhat granular appearance when a piece of butter is broken, an appearance quite similar to that of the broken ends of a steel rod.

Body refers to the consistency of butter. In other words, it refers to its degree of firmness or its ability to "set up" well at ordinary temperatures.

Brine refers to the amount and character of the water in butter. It should be as clear as water and not present in such quantities as to run off the trier.

**Color.** The essential thing in color is to have it uniform. It should have a little deeper shade than that produced by June pasturage. Artificial coloring is therefore necessary.

**Salt.** As with color, the essential thing with salt is to have it evenly worked through the butter and none of it should remain undissolved.

**Package.** Butter should be well packed and the top covered with cheese cloth and saturated brine. The package should be neat and clean and in no way mutilated.

#### BUTTER SCORE CARDS.

The score card contains the "score" or judgment as given by the judge. In commercial judging of butter a score card is used which is quite similar to the one given below.

## BUTTER SCORE CARD.

Name \_\_\_\_\_

Sample.	No.	1	2	3					
Flavor - -	45	40	38	36					
Texture -	25	23	23	23					
Color - - -	15	15	14	14					
Salt - -	10	10	10	9					
Package - -	5	5	5	5					
<b>Total - -</b>	<b>100</b>	<b>93</b>	<b>90</b>	<b>87</b>					

Date \_\_\_\_\_

Judge \_\_\_\_\_

In such scoring no attempt is made to point out the particular defects any further than to indicate the number of points for each sample. The total number of points determines the class to which the butter belongs. Thus in the score card above, sample No. 1 grades as "extras," sample No. 2 as "firsts," and sample No. 3 as "seconds."

At dairy conventions and in educational butter scoring tests the object in judging is not so much to determine the score of the butter as to point out as nearly as possible the causes of any defects and to suggest remedies for overcoming them. The score card that may be used in this case is shown on the next page.

**BUTTER SCORE CARD**

No.

	Perfect.	1st Scoring Date.....	2d Scoring. Date.....	
Flavor.....	45			{ Curdy. Light. Rancid. Fishy. Feverish Oily or greasy. Weedy. Stable. Unclean. High acid. Bitter.
Texture.....	25			
Color.....	15			{ Mottles, White specks. Too high. Too light. Color specks.
Salt.....	10			
Package.....	5			{ Dirty. Poorly packed. Poorly nailed. Poorly lined.
Total.....	100			

Remarks :

Judges

Date.....

A brief discussion of the defects indicated on this score card is given below :

#### FLAVOR.

*Curdy* flavor is caused by overripened starters or adding starters to cream while the latter is at too high a temperature. Also by ripening very thin cream at high temperatures.

*Light* flavor is generally due to churning cream too sweet. It may be due also to too much washing and to the character of the feed. It is well known that good succulent June pasturage produces a higher flavored butter than average dry winter feed.

*Rancid* flavor is due chiefly to overripened cream. The age of the milk, cream, and butter is also frequently the cause of rancidity. Good butter exposed to light and air at ordinary temperatures turns rancid in a very short time.

*Feverish* flavor is noticeable principally in the spring of the year when cows are turned out on pasture and is, no doubt, due in most cases to the sudden change from dry feed to luxuriant pasturage. It is possible that this feverish or grassy odor is due partly to the grass itself and partly to a feverish condition of the cow caused by the sudden change of feed. We find that any feverish condition of the cow will manifest itself in the milk and the products therefrom.

*Oily or greasy* flavor may be caused by churning and working butter at too high a temperature, or by keeping the milk and cream at high temperatures. It may also be caused by using poor color or too much color. Bad smelling color that shows sediment at the bottom should not be used. Bacteriologists claim that certain species of

bacteria have the power of imparting an oily flavor to butter.

*Weedy* flavors are caused by cows feeding on weeds. Leeks or wild onions are frequently the cause of very serious trouble when cows have free access to them. The trouble may also be caused by exposing milk and cream to an atmosphere charged with objectionable odors.

*Fishy* flavor, according to L. A. Rogers, is due to oxidation which is favored by a high acid cream and overworking. The latter favors oxidation by increasing the amount of air in butter.

*Stale* flavor is caused by lack of cleanliness in milking, and by keeping milk too long in, or near, a dirty stable.

*Unclean* flavors are caused by dirty pails, strainers, and cans, filthy creamery conditions, and general uncleanness in the care and handling of milk.

*High acid* flavor is due to oversoured cream or starter.

*Bitter* flavor is caused by keeping cream too long at low temperatures.

#### TEXTURE.

*Poor grain* is caused by overworking and overchurning; also by too high temperatures in churning and working.

*Weak body* is usually caused by employing too high temperatures in the entire process of manufacture, including the ripening of the cream. These high temperatures usually result in overripened cream, overchurned butter and consequently butter with too high a water content. The character of the butter fat also influences the body of the butter.

*Too much brine* is caused chiefly by underworking and by churning to small granules.

*Cloudy brine* is caused by churning at too high a temperature and also by granulating too coarse. Insufficient washing has a tendency to produce a cloudy brine.

*Greasy* butter is caused by overworking or by handling at too high temperatures.

#### COLOR.

*Mottles* are discolorations in butter caused by the uneven distribution of salt. Those portions of the butter that contain the most salt will have the deepest color because of the attraction of salt for color. Mottles can always be removed from butter by working, but frequently the conditions are such as to require overworking to secure this end.

Van Slyke and Hart have shown that mottles can not be caused in butter when the latter is thoroughly freed from proteids. This suggests the importance of churning and washing in such a manner as to remove the buttermilk as completely as possible.

The following are conditions that favor mottles:

1. Coarse uneven grained salt.
2. Carelessly adding the salt to the churn.
3. Butter too cold for working.
4. Using too cold or too warm wash water.
5. Too much buttermilk in the butter.
6. Not enough moisture in butter when worked.

*White specks* are due either to curd particles in cream caused by overripening and lack of stirring during ripening, or to dried and hardened cream.

*Color specks* are tiny specks of color caused by using a poor grade of color, old color, or color that has been kept at too high a temperature.

## SALT.

*Undissolved salt* may be due to three things:

1. Poor salt.
2. Too much draining before salting.
3. Salting the butter at too low a temperature.

## SAMPLE FOR SCORING.

In judging butter only a small sample is necessary which is secured by inserting a "trier" into the butter and giving it a whole turn, after which the plug of butter may be removed.



## CHAPTER XV.

### PASTEURIZATION AS APPLIED TO BUTTER MAKING.

The process known as pasteurization derives its name from the eminent French bacteriologist Pasteur. It consists in heating and cooling in a manner which will destroy the vegetative or actively growing bacteria. Milk or cream is also considered pasteurized when only the bulk of the vegetative bacteria is destroyed.

**Beginning of Cream Pasteurization.** About twenty years ago Storch, the noted Danish scientist, succeeded in isolating from milk the bacteria that are needed in successfully ripening cream. Cultures of these bacteria were prepared and propagated in his laboratory and placed upon the market for cream ripening. It became evident to Storch, however, that the best results could not be expected when these cultures were added to cream that was already teeming with various species of bacteria. This led him to the idea of preparing a clean field for his cultures by destroying the germs that already existed in the cream by **pasteurizing it**. After this treatment the cream was inoculated with the desirable germs that he had isolated and propagated for this purpose. The result of this practice was that it became possible to produce butter which not only possessed a very fine flavor but which was characterized by its extreme uniformity and good keeping quality.

Storch soon succeeded in introducing this method of butter making into Danish creameries which has done

much toward making Denmark the most noted butter-producing country in the world. Practically all butter produced in that country at the present time is made from pasteurized cream.

**Pasteurized Butter in America.** The growth of the system of pasteurized butter making has been slow in America up to within recent years. That pasteurized butter possesses merits over unpasteurized has, however, long since been demonstrated by American agricultural colleges and private investigators. It remained, nevertheless, for our practical butter makers to place the merits of this system beyond a possible doubt. During the past two years most of the important prizes awarded to butter makers have gone to makers of pasteurized butter. Many of the leading and champion butter makers of the United States, are the firmest advocates of pasteurization. Creameries all over the country are now turning their attention to pasteurization and the general adoption of the system in America can only be a matter of time. Indeed a large percentage of the creameries including some of the largest in the world, are now making butter exclusively from pasteurized cream.

**Why We Should Pasteurize.** It must not be forgotten that the standard of American butter is becoming higher year after year. Methods which only six years ago produced a butter that fairly suited the general market, are now obsolete and unsatisfactory. In illustration of this may be cited the practice of using buttermilk starters, or the use of no starters at all, in creamery practice. The author has closely watched the careers of several young men who, only a few years ago, had met with a fair degree of success in ripening cream with but-

termilk starters, but whose persistence in adhering to old methods has driven them out of the profession of butter making.

The rational use of starters has done much to raise the general standard of butter in America. But the finest starters added to cream already teeming with many species of good and bad bacteria, can not produce the best results. It is obvious that the best results with good starters are possible only when the bacteria in the cream are first destroyed by pasteurization so that the good germs introduced by the starter may have a clean field for development.

If nothing but good cream and milk were delivered at our creameries pasteurization could hold no place in our system of butter making, for such milk could not be improved by this process. But we can not hope, for many years at least, to have all milk arrive at the creameries in good, clean condition, though of course great possibilities remain for improvement in this direction. Some milk will persist in coming to the creamery too good to reject and too poor to make the best quality of butter.

Then, too, with the advent of the hand separator system in creamery butter making, pasteurization has become more imperative than ever before. Where cream of varying ages and acidity is received it is more difficult to secure uniformity and good keeping quality in butter than is the case where the milk is daily delivered to the creamery.

It is hoped that the general recognition of the merits of pasteurization will soon be followed by the adoption of this method of butter making in all of our creameries. We need to produce a butter of better keeping quality and

of greater uniformity, two qualities which American butter notably lacks.

**Processes of Pasteurization.** There are two processes of pasteurizing cream: (1) the "continuous" or "flash" process by which the cream is permitted to pass in continuous stream through the pasteurizer and is subjected on an average less than one minute to the pasteurizing temperature; (2) the discontinuous or "held" process by which every particle of cream is heated from ten to sixty minutes according to the degree of heat employed.

Obviously where cream is heated only a minute a higher temperature must be employed than where the time of exposure is longer. The temperature and time of exposure should always be such as to insure the destruction of the tubercle bacillus.

**Continuous or Flash Method.** Until recently, practically all pasteurized cream butter was made by the continuous method of pasteurization. The temperature employed with this method ranges from 165° to 185° F. Immediately after heating, the cream is quickly cooled to at least 65° F.

**Discontinuous or Held Method.** This method of pasteurizing cream is growing in popularity. Exposing cream to a temperature of 145° F. for 30 minutes results in more thorough pasteurization than is possible with the continuous method. With the latter process reasonably satisfactory results in destroying bacteria cannot be obtained unless the milk is heated to 176°F. But a stream of cream coming from a continuous machine and showing a temperature of 176° F., does not necessarily mean that every particle of the cream has been heated to this

temperature; indeed, quite the contrary is to be expected. It is easily conceivable that where cream passes through a machine in a constant stream, some particles will be heated higher than others, that is, some particles will exceed  $176^{\circ}$  while others will fall short of this temperature. It is generally conceded that perfectly uniform heating is practically impossible with the continuous or flash process, and for this reason it is perfectly possible for some bacteria with a thermal death point of  $176^{\circ}$  F., or even lower, to escape destruction by this process.

In addition to the more thorough and uniform heating possible with the discontinuous method, there are other advantages. Where the discontinuous method is used, the cream, as a rule, is pasteurized in the cream ripener, thus dispensing with extra pasteurizing machinery as well as reducing the amount of labor in handling the cream. Scores of butter makers report excellent results in pasteurizing cream in the cream ripener at say  $145^{\circ}$  F., and keeping it at this temperature about 30 minutes when it is rapidly cooled to ripening temperature.

Pasteurizing cream in a cream ripener by the discontinuous method requires reasonably sweet cream. Very sour cream will curdle, causing an excessive loss of fat in the buttermilk. Results so far seem to indicate that it is best to pasteurize very sour cream in a continuous machine.

**The Chief Advantages** of pasteurizing cream are as follows:

1. Improves the flavor of butter.
2. Leads to greater uniformity.

3. Increases the keeping quality.
4. Eliminates undesirable odors.
5. Renders butter safe from disease germs.

Milk and cream always contain bad flavor producing bacteria in varying quantities. The destruction of these by the pasteurizing process and their subsequent replacement by good flavor producing bacteria, must afford sufficient proof for the first three advantages above mentioned.

The keeping quality of the butter made from pasteurized cream is so much superior to that from the unpasteurized, that the author feels that the increased keeping quality alone should warrant the general introduction of pasteurization in our system of butter making.

Experience has also shown that there is nothing so effective in eliminating bad odors from milk and cream as the high temperatures employed in pasteurizing. High temperatures in themselves tend to expel from milk or cream undesirable odors so frequently present, especially during the weedy season. When the high temperature is assisted by the whirling motion to which milk and cream are subjected in the pasteurizer, or possibly the separator, the power of eliminating bad odors is materially increased.

In regard to the advantage of pasteurizing cream to safeguard butter against disease germs, it should be borne in mind that when milk is infected with this class of organisms the butter from the same will also be infected. Thus it has been shown that not only will butter contain tubercle bacilli when made from milk containing them, but the bacilli retain their virulence in butter for a considerable period of time.

The danger from tubercle bacilli has recently caused the Chicago board of health to pass an ordinance ex-

cluding from the city all butter which has not been safeguarded against these organisms, either by pasteurizing the cream or by applying the tuberculin test to herds from which the butter is obtained and excluding all reacting animals.

Certainly if it is necessary to pasteurize skimmilk to prevent the spread of tuberculosis among live stock, it should be all the more imperative to pasteurize the cream to prevent the spread of tuberculosis in the human family through infected butter.

As in the case of cream ripeners, there are a number of different makes of cream pasteurizers upon the market which are giving good satisfaction. Pasteurization will not prove successful with any pasteurizer unless the cream is heated to the proper temperature and *rapidly* cooled to at least 65° F. *immediately* after it leaves the pasteurizer.

**Pasteurization of Gathered Cream.** There is probably no problem along pasteurizing lines of greater importance at present than the pasteurization of hand separator or gathered cream. Heretofore the apparent difficulty in the way of pasteurizing this cream has been the high degree of acidity which it often reaches before delivery to the creamery. Experiments and practical creamery results show beyond doubt that sour cream containing not less than 30% fat can be successfully pasteurized. Much greater care is necessary when the fat content falls below 30% and buttermakers should insist upon making 30% the minimum, which can easily be done with hand separators.

The chief danger in pasteurizing thin sour cream is the coagulation of the casein and the consequent greater loss

of fat in the buttermilk. High temperatures are less liable to produce this result than relatively low. Cream of this kind should be pasteurized at not lower than 185° F. The coagulation of the casein interferes with the cooling and straining of the cream, and it has been shown that the high loss of fat in the buttermilk is at least partly due to the fat globules which are enclosed in the curd particles.

In general, pasteurized cream must be churned at a lower temperature than unpasteurized to get exhaustive churnings. Where cream has been heated it is also necessary to keep it at a low temperature longer before churning than unheated cream, because of the slowness with which the fat becomes thoroughly chilled.

The acidity of cream is somewhat diminished by the pasteurizing process. This process also diminishes the heavy consistency of sour cream, which it does not seem to recover even when ripened with a heavy starter. This, however, has no effect on the quality of butter.

To obtain good results from pasteurizing sour cream it is absolutely essential to treat the pasteurized product with a heavy starter even if the latter shows an acidity of 0.6% or more.

**Cost of Pasteurizing Cream.** According to Danish experiments the cost of pasteurizing cream is approximately .1 cent per pound of butter. These results seem to be confirmed by the best practical butter makers in this country who have pasteurized for several years.

The cost of pasteurizing must, however, always depend largely upon the manner in which the pasteurizing process is carried out. For example, if the water used for cooling the cream is pumped into the water supply tank



for the boiler, a large portion of the heat used for pasteurizing is recovered. Further, if the proper coolers are used, ordinary well water will cool the cream to the ripening temperature without the use of ice. Some have also found it practical to use the exhaust steam from the engine for pasteurizing cream.

The care and cleaning of the pasteurizer and cooler will, of course, entail extra labor, but the labor thus involved will not materially add to the expense of pasteurizing.

## CHAPTER XVI.

### CONTROL OF WATER IN BUTTER.

**Importance of Water Control.** First of all it is necessary to know how to control the water in butter in order to keep within the limits of the law which classes butter as adulterated when it contains 16% or more of water. That there is danger of exceeding this limit is evinced by the number of penalties which buttermakers have been obliged to pay in recent years.

There is also a great deal of butter on the market which is unnecessarily low in water content. This means a reduced yield in butter, and consequently places the manufacturers of such butter at a disadvantage with competitors who are obtaining normal yields.

Finally it is necessary to understand the means of controlling water in order that uniformity may be secured with respect to this constituent of butter.

**The Buttermaker's Limit.** While 16% water is legally approachable, the buttermaker, to be on the safe side, should make 15% *his* limit. To allow one per cent. latitude for possible inaccuracies in making water determinations is manifestly the least that can possibly be allowed. Buttermakers who are striving to run the water content up to within one-half or one-quarter per cent. of the legal limit are constantly in danger of falling into the clutches of the law.

### FACTORS THAT CONTROL THE WATER CONTENT OF BUTTER.

**Temperature.** This is the main factor in the control of moisture in butter. A temperature which keeps the

butterfat in a soft, plastic condition during churning and working favors the retention of water in butter. The temperature, however, must never be so high as to injure the texture of the butter or to cause an undue loss of fat in the buttermilk.

**Size of Granules.** As a rule, the larger the butter granules the more water will be retained in the butter. The size of the granules should be limited to that of a pea, because larger granules will make it difficult to properly wash the butter and distribute the salt.

**Amount of Working.** When butter is worked in the presence of little moisture, the water content decreases with the amount of working. On the other hand, it has been shown that when butter is worked with considerable water present in the churn, the water content may be actually increased by continued working. Overworking must be carefully avoided.

**Time Between Workings.** The shorter the time between workings the higher the water content. The highest water content is secured by working butter only once.

**Amount of Salt.** It has long been known that salt expels moisture from butter. The more salt used, therefore, the smaller the amount of water retained in the butter.

**Richness of Cream.** Rich cream which churns into flaky, irregular granules, tends to increase the water content of butter.

**Amount of Cream in Churn.** Large churnings are more conducive to high water content than small.

**Dry and Wet Salt.** The moister the salt when applied to the butter the less water it will expel.

**Composition of Butterfat.** This may be considered

as exerting an indirect influence upon the water content of butter. Feeds, breeds, and period of lactation for example change the proportion of soft and hard fats in butterfat and therefore have an influence upon the churning temperature of cream. Butter from stable-fed cows receiving feeds like cottonseed meal, which produces a hard butterfat, may be perfectly normal in water content, while butter from the same cows feeding upon pasture (yielding a relatively soft butterfat) may be overloaded with water, if the same churning and working temperature is employed in both cases.

The author recalls several cases where buttermakers have exceeded the legal limit for water in butter. These occurred in the spring while the cows were being changed from dry feed to pasture. It is possible that the buttermakers in these instances failed to change the churning temperature to meet the changed conditions as to feed. The lactation period may also have exerted some influence in these cases, since it is possible that many of the cows freshened during the transition period from dry feed to pasture. (See discussion under "insoluble fats," page 15.)

#### DETERMINATION OF WATER IN BUTTER.

One of the most important points in testing butter for moisture is to get a sample that will accurately represent the whole lot of butter to be tested. Such a sample is best secured by making a *composite* sample, the components being taken from various parts of the tub or churn.

**Sampling Tub Butter.** Run the trier diagonally through the tub and collect butter from different points

of the plug. Put the composite sample thus collected at once into a tightly covered glass jar, and keep it there until ready for testing.

**Sampling Butter from the Churn.** Take samples from as many points of the churn as possible, making sure to get some from the ends as well as the middle portion of the churn. The more points from which the sample is taken the more accurate the results. As in sampling tub butter, the composite sample is placed at once into an air-tight glass jar where it is kept until ready for testing.

**Preparing the Composite Sample for Testing.** In order to insure a thorough mixing of the sample, it should be melted by placing the sample jar in water at a temperature slightly higher than the melting point of the butter. As soon as melted, the butter is re-solidified by running cold water over the jar. The sample, however, must be thoroughly shaken during the solidifying process to insure an even distribution of moisture.

Some have secured satisfactory results by simply warming the butter (at about 100° F.) until it assumes a creamy consistency and then thoroughly mixing the same just before weighing.

**Weighing the Sample.** In weighing the butter, first weigh the sample dish, making sure that the dish is *clean* and *dry*. Next place about ten grams of butter in the dish and weigh again. The difference between the two weighings represents the weight of butter.

To secure accurate weighings, use scales sensitive to at least one centigram and allow the dishes, both with and without the butter, to cool to about 100° F. before weighing. While it is necessary to cool the sample, a

long delay in weighing, on the other hand, is to be avoided on account of the danger of the samples absorbing moisture. Draughts must also be avoided in weighing. Furthermore, small samples and dishes are more conducive

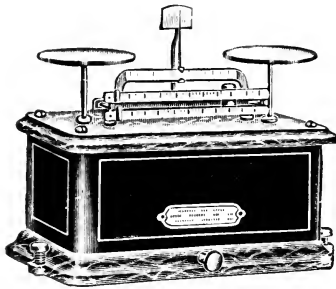

Fig. 33.—Scales for moisture determination in butter.

to accuracy in weighing than large ones. This is so because the ordinary scales used in weighing butter samples are rather light in construction and hence not adapted to heavy weighing. For this reason a ten-gram sample will give better results than a fifty-gram sample.

**Weighing Samples Direct.** M. Michels, formerly in charge of the Wisconsin Butter and Cheese scoring exhibitions, has found that where there is no loose water in butter satisfactory results can be secured by transferring the butter direct from the sampler to the sample dish.

**Duplicate Tests.** Results from a single moisture determination can not be positively relied upon as being correct. In all important testing work duplicate tests should be made. Where the duplicates correspond closely the average of the two tests may be considered correct.

**Calculating the Per Cent. of Water.** Where exactly ten grams of butter are used, multiply the loss in weight during drying by 10 to get the per cent. of water. Example: Weight of butter before drying is 10 grams; weight after drying is 8.5 grams; the difference, 1.5, multiplied by 10 equals 15 per cent. of moisture.

When somewhat more or less butter is weighed out,

use the following rule for calculating the per cent. of water:

Rule: Multiply the loss in weight during drying by 100 and divide the result by the weight of butter used. Example: weight of butter before drying is 10.45 grams; weight after drying is 8.90 grams. The difference 1.55, multiplied by 100 and divided by 10.45 equals 14.83 equals per cent. of water.

#### MOISTURE TESTS.

There are a number of methods in use for determining the water content of butter, a few of which will be described here.

**The Eclipse Method.** This consists of a strong, double-walled casting with a depression into which an aluminum beaker fits. The casting is attached to a steam pipe which allows steam under pressure to pass between its walls. The greater the steam pressure the higher the evaporating temperature and hence the shorter the time required to evaporate.

About ten grams of butter are placed in the aluminum beaker and as soon as it begins to show a light brown color the evaporation as a rule is complete. With the steam pressure ordinarily carried in creameries (about 50 lbs.) the evaporation is complete in about fifteen minutes.

To make sure that all the moisture has been evaporated, re-heat and re-weigh the sample. If the weight after the first heating is the same as that after the second, it is proof that the first heating was sufficient.

The Eclipse method especially commends itself for its simplicity.

**The Richmond Method.** With this method about ten grams of butter are placed in a porcelain dish which is heated over an alcohol (or other) flame. The butter must be constantly stirred during the heating and care must be taken to so regulate the flame as to avoid sputtering. The evaporation can usually be completed in about three minutes. This method commends itself especially for the rapidity with which the test can be made.

**The Wisconsin Method.** This consists of a square, double-walled, cast-iron oven heated with steam under pressure. The steam circulates between the walls. About ten grams of butter are weighed in flat bottom aluminum dishes which are placed inside of the oven. At ordinary steam pressure (about 50 pounds) the evaporation is usually completed in thirty minutes. The sample should always be re-heated and re-weighed to make sure that the first heating was sufficient. This method commends itself especially where a large number of samples are to be tested, since the oven easily holds from nine to sixteen dishes, depending upon the size of the dishes.



## CHAPTER XVII.

### SAMPLING, WEIGHING AND TESTING GATHERED CREAM.

#### CREAM SAMPLING AND SAMPLERS.

**Taking an Aliquot Sample.** This means that the amount of cream taken for the composite test jar, must always be proportional to the amount of cream furnished. If cream always had the same richness, or if always the same amount were furnished, the dipper method of sampling would give satisfactory results, provided the cream was thoroughly mixed before sampling. But since we rarely find two batches of cream alike, either in quantity or quality, the necessity of taking an aliquot sample becomes apparent. This may be made perfectly plain by the following illustration:

Feb. 1 patron X furnishes 50 lbs. of 20% cream.

Feb. 2 patron X furnishes 30 lbs. of 30% cream.

Feb. 3 patron X furnishes 20 lbs. of 40% cream.

Dividing the total butterfat furnished during the three days by the total pounds of cream we get 27, which represents the correct average test. This test would be secured by taking aliquot samples. The test by the dipper method would equal the sum of the three tests divided by three. Thus  $20+30+40 \div 3=30$ , the average test by the dipper method, differing from the correct average test by 3%. By the dipper method the same amount of cream is taken for a sample, regardless of the amount of cream furnished.

**Cream Samplers.** While an aliquot sample is necessary only where composite samples are made, samplers taking an aliquot sample, like the Scovell, McKay and Michels, have the further advantage of securing a more accurate sample when the cream is not thoroughly mixed. These samplers take a uniform sample from the top to the bottom of the cream in the can. The "milk thief," which also takes an aliquot sample, does not take as satisfactory a sample when the cream is not thoroughly mixed.

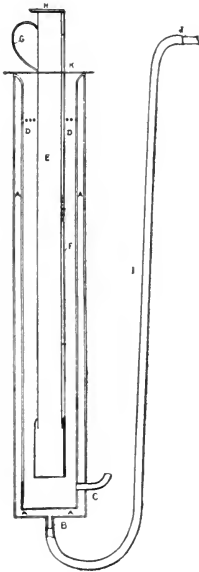

Fig. 34.—Michels sampler.

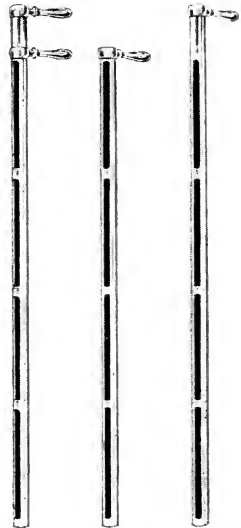

Fig. 35.—McKay sampler.

**McKay Sampler.** This consists of two tubes, one of which slides into the other. One side of each tube is open so that the cream enters along the entire side of the

sampler. When the sampler is filled the tubes are turned with the openings or slots at right angles to each other, thus closing the sampler and permitting the withdrawal of the sample of cream. See Fig. 35.

**Michels Sampler.** This consists of a modified Scovell sampler heated in a tin heater as shown in Fig. 34.

*A* is a steam and hot water reservoir with an inlet at *B*. The steam and hot water discharge through a circle of small openings at *D*. The condensed steam finds exit at *C*. *E* is a Scovell sampler provided with a handle, *G*, and a circular piece of heavy tin, *K*, which holds the sampler in position and prevents the escape of steam. *F* is a strong wire attached to the cap which opens and closes the sampler. The wire ends at the top in a right angle turn, *H*, which rests across the top of the sampler when the latter is open. The construction of the heater prevents the entrance of water into the sampler and necessitates the use of but a very small amount of steam, which is admitted through the steam hose, *I*. The latter connects with the pipe, *J*, leading to the boiler.

When ready to sample, remove the sampler from the heater, plunge at once to the bottom of the can of cream to be sampled, and remove quickly. While holding the composite sample jar in the left hand, discharge the contents of the sampler into it by pressing down on *II* with the thumb of the hand holding the sampler. Owing to the heated condition of the sampler, the cream discharges instantly and, what is equally important, all of it discharges.

The sampler is accurate, quick, convenient and simple, and makes the sampling of heavy, rich cream, or thick, sour cream, no more difficult than that of milk.

The McKay sampler can also be heated in the tin heater and is probably to be preferred to the modified Scovell sample for sampling extremely cold or extremely rich cream.

**Scovell Sampler and Milk Thief.** These samplers are illustrated and described on page 52.

#### SAMPLING AND WEIGHING AT THE FARM.

In addition to the regular supply of empty, sterile cream cans, the cream gatherer should be provided with a pair of scales, a cream pail, tubes or jars for carrying the cream samples, a cream stirrer, and a sampling tube or a small sample dipper. The dipper may be used when the samples are tested after each delivery. Where composite samples are taken the sampling tube must be used owing to the daily variation in the quantity and quality of cream.

Thoroughly mix the cream before taking the sample. This is best accomplished by pouring it several times from one vessel to another. If the cream is lumpy, the lumps should be broken up with the stirrer. Immediately after mixing the cream, a sample is taken and placed in the patron's sample tube or jar. The receptacle should be plainly numbered and provided with a tight-fitting cover. The cream is then weighed and poured into the regular supply cans.

The samples should be carefully placed in a carrying case where they are protected from breakage and outside temperatures. Promptly on arrival at the creamery the samples are emptied into their respective composite sample jars, if the composite method of testing is followed.

Where the cream is too thick for satisfactory sampling

with the sampling tubes, a proportionate amount of cream may be measured by putting into a graduated tube, with a dipper, say one c.c. of cream for every pound of cream furnished.

#### SAMPLING AND WEIGHING AT THE CREAMERY.

There are several methods of weighing and sampling in vogue at the present time. One is to sample and weigh the cream in the cans in which it is delivered. In this case the sample is taken with a dipper or sampling tube after the cream has been thoroughly mixed with a stirrer. The cream is then weighed and emptied directly into the cream vat or into a receiving can. From the latter it may be conducted into the cream vat by gravity or by means of a pump. A better method of handling the cream is to pour it from one can to another several times before sampling. This insures better mixing than is possible with the stirrer alone. But even where the cream is poured, the stirrer may be of value in supplementing the mixing, especially in case the cream is lumpy. Weigh the cream in the delivery can or the receiving can and run it by gravity into the cream vat.

In case composite samples are made, an aliquot portion of cream must be taken by means of one of the sampling tubes. And where the cream is not thoroughly mixed before sampling, the Scovell, McKay, or Michels sampler is preferred.

All cream samplers except the Michels must be rinsed in hot water after each sampling. This is especially important when sampling heavy cream.

Where the cream is weighed in the cans, the weight of the empty can should be permanently marked upon it.

## TESTING CREAM.

**Frequency of Testing.** Where the cream is delivered to the creamery in good condition, *composite* samples may be taken in the same manner as with milk. Usually, however, where a great deal of hand separator cream is handled, some of it is delivered in too bad condition for composite sampling. In this case it becomes necessary to test the cream as often as it is delivered.

At present in many of the larger and in some of the smaller creameries, a test is made of each delivery of cream. This practice insures the most satisfactory tests, but requires more work than where composite samples are taken. On this account a great deal of cream is still tested by the latter method.

Where composite samples are made, these are preferably tested once a week and should *never* be tested less than twice a month. See chapter on "Composite Sampling."

**Necessity of Weighing Cream.** Accurate tests of cream can not be secured by measuring the sample into the bottle as is done in the case of milk. The reason for this is that the weight of cream varies with its richness. The richer the cream the less it weighs per unit volume. This is illustrated in the following table by Farrington and Woll:

Weight of fresh separator cream delivered by a 17.6 c.c. pipette.

Per cent of fat in cream.	Specific gravity (weighed.)	Weight of cream in grams.
10	1.023	17.9
15	1.012	17.7
20	1.008	17.3
25	1.002	17.2
30	.996	17.0
35	.980	16.4
40	.966	16.3
45	.950	16.2
50	.947	15.8

These figures plainly show that justice can not be done to patrons where cream is sampled with a 17.6 c.c. pipette. Cream is therefore always weighed on a cream scales, the amount necessary for a full sample being eighteen grams.

**Cream Bottles and Their Uses.** Numerous styles of cream bottles are now upon the market. They range in length from six to nine inches with necks graduated from 30 to 55%. The nine-inch bottles are graduated from 50 to 55% and require special testers on account of their unusual length. These long-necked bottles have the

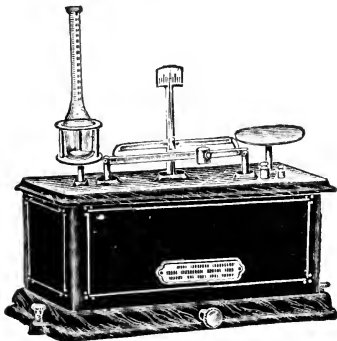

Fig. 36.—Torsion cream scales.

advantage of permitting the use of a full sample of cream which insures a more accurate reading than is possible where only half a sample of cream is put in an

ordinary cream bottle, or where shorter wide-mouthed 50% bottles are used.

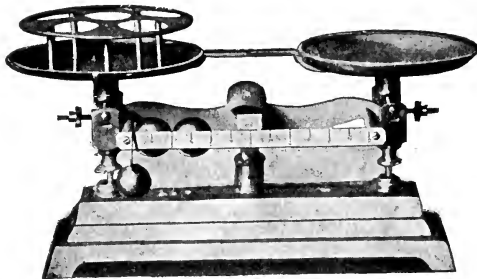

Fig. 37.—Cream scales.

A cream bottle commonly used is the Winton 30% bottle, shown in Fig. 3. With this bottle only half a sample (9 grams) of rich cream can be used. To the half sample of cream a scant half-measure of acid is added, and the testing finished in the usual way. What is better, however, is to add to the nine grams of cream approximately 9 c.c. of water and then use the full amount of acid. Obviously where only half a sample of cream is used in the ordinary bottle, the test must be multiplied by 2 to get the correct reading.



Fig. 38.—Nine gram cream bottle.

Lately, a small bore cream bottle (Fig. 38) has been placed upon the market in which only half a sample of cream is used, but which gives a reading for a full sample. This does away with multiplying tests by 2 when only half a



sample is used, and reduces the error in reading by one-half. The small bore of the neck also lessens any error in reading the test.

In testing cream with this bottle, add 9 grams of cream, 9 c.c. of water, 17.6 c.c. of sulphuric acid and proceed with the test in the usual way, remembering that the fat column gives the reading for an 18 gram sample.

**Preparing the Sample.** Before weighing the cream on the balance, care should be taken to thoroughly mix the sample by pouring and repouring a few times. Should the samples show any dried or churned cream, the sample jars must be placed in water at a temperature of about 110° F. until the lumps of cream or butter have melted. When this is done the sample for the test bottle must be taken instantly after mixing, as the melted fat separates very quickly. In general, warming the sample jars somewhat before sampling by placing them in warm water will facilitate the mixing and sampling of the cream.

**Making and Reading Cream Tests.** The different steps in testing cream are essentially the same as in testing milk. However, as already stated, the cream must be weighed and tested in a special bottle. Furthermore, special precautions must be used in reading the test.

It is well known that reading the extremes of the fat column gives too high a reading. This error is due to the meniscus at the top of the fat column, the size of which varies with the width of the neck. Farrington and Woll recommend reading from the lowest extremity of the fat column to the bottom of the upper meniscus. This is the method commonly employed in reading tests. Eckles and Wayman recommend removing the meniscus by adding a small quantity of amyl alcohol (colored red)

to the top of the fat column. Farrington suggests adding a few drops of fat-saturated alcohol to the top of the fat as a means of removing the meniscus. Ordinary alcohol has a solvent action on butter fat, hence the necessity of using fat-saturated alcohol.

Hunziker\* after a thorough investigation of the subject, has found "glymol" best suited for the removal of the meniscus. Glymol is known commercially as white mineral oil and is used for typewriters, sewing machines, etc. It will give satisfactory results without the addition of coloring matter. It may be colored, however, by placing a small cheese cloth bag containing "alkanet root" in a bottle of glymol for a day or two. One ounce of alkanet root will color one quart of glymol.

A few drops of the glymol are sufficient, and should be carefully added to the top of the fat column before reading the test.

To get accurate readings the bottles should be read while the temperature of the fat is between  $135^{\circ}$  and  $140^{\circ}$  F. The bottles should be taken from the tester and placed in a water bath having a temperature of  $140^{\circ}$  F. and kept there several minutes, or long enough to cool the fat to  $140^{\circ}$  F. The water in the vessel should extend to the extreme top of the fat in the bottles, or preferably a little above. Accurate readings cannot be obtained by reading the bottles directly from the tester; the first bottles removed have too high a temperature while those removed last have too low a temperature.

---

\*Bulletin 145, Indiana Experiment Station.

## CHAPTER XVIII.

### LOCATION AND CONSTRUCTION OF CREAMERIES.

The creamery industry has had a marvelous growth during the past decade and at no time in its history has it been in a more healthy, flourishing condition than it is at the present time. This growth has been the result of a gradual change in agricultural methods, necessitated chiefly by the need of conserving the fertility of lands now under cultivation. As our lands become older, an agricultural practice that will have for one of its objects the preservation and restoration of soil fertility, must grow more and more imperative. We have, therefore, much assurance that the creamery industry will flourish in the future as it has in the past, and that the creamery has come to stay as a permanent institution. The same care and attention should therefore be given to the location and construction of creameries that is now given to our schools, churches, and other institutions.

**Location of Creamery.** In deciding upon the location of a creamery, we should carefully consider the following points: (1) the number of cows in the community; (2) the slope necessary to insure good drainage; (3) the center of the milk producing territory; and (4) the supply of pure water.

(1.) Before building a creamery we must first ascertain the number of cows available for its support. There should be an assurance of not less than 400 cows in a radius of five miles of the creamery to start with. Too

frequently creamery "promoters" are the cause of creamery failures because the creamery has been placed in a territory containing too few cows.

(2.) The ground upon which the creamery stands should slope at least one foot in ten. This amount of slope is necessary for two reasons: (a) to secure sufficient drainage, and (b) to permit the construction of a creamery with an ideal interior and exterior arrangement, such as will do away with extra can lifting, and extra pumps and piping.

(3.) Locations far removed from railroad stations are undesirable. It makes transportation to and from the station too expensive. Besides, during the summer the butter is liable to get too warm before it reaches a refrigerator car.

(4.) Pure water is absolutely indispensable to the success of a creamery. Experiments have abundantly demonstrated that butter washed with impure water will be inferior in flavor and particularly poor in keeping quality.

**Fireproof Creamery.** The best and most permanent creameries are constructed of brick or hollow concrete blocks. They are the most sanitary and cheapest in the long run. The original cost may be somewhat greater than that of a frame building but the insurance and repairs are considerable less. A brick or concrete block creamery with galvanized iron roof, cement floors, and the walls partly of cement, is practically fire proof. Fires occur too frequently in creameries to permit their construction without regard to protection against fire. Indeed scarcely a week passes but that from one to three creameries are burned to the ground. In Denmark, the great butter producing country, the creameries are nearly all constructed of brick.

A good solid concrete or stone foundation adds much to the durability of a creamery building.

It matters not whether the creamery is constructed of wood or brick, a shingle roof is undesirable because of the danger from fire. Twenty-six gage galvanized iron, when properly laid, will make a cheap and very durable roof. The roofing should be laid with standing seams to allow for expansion and contraction of the material. To protect the under side of the roof from moisture and corroding gases it is desirable to lay the galvanized iron on acid and waterproof paper.

Slate makes the neatest and most durable roof but it is rather expensive.

**Creamery Dimensions.** These should be such as not to crowd the machinery, nor to leave a great deal of unnecessary space. Where the machinery and vats are placed too close together they cannot be conveniently cleaned and attended to. On the other hand, too much space means extra steps, extra pipes and conductors, and added cost to the creamery, to say nothing of the additional cleaning.

**Plan of Creamery:** There are two general plans upon which creameries have been constructed in the past. One is known as the gravity plan, the other as the one floor plan. In the gravity plan the milk flows by gravity from the intake to the separator, thus dispensing with the use of a milk pump. It necessitates, however, two floors on a different level; one for the receiving vat, the other, five feet lower, for separators and cream vats. In the one floor plan all vats and machinery stand on one floor, the milk being forced into the separators by means of a pump.

The chief objection to the gravity plan is that it necessitates the climbing of high steps, which makes going from one floor to the other difficult and tiresome. Yet, not many years ago, such steps were preferable to the un-

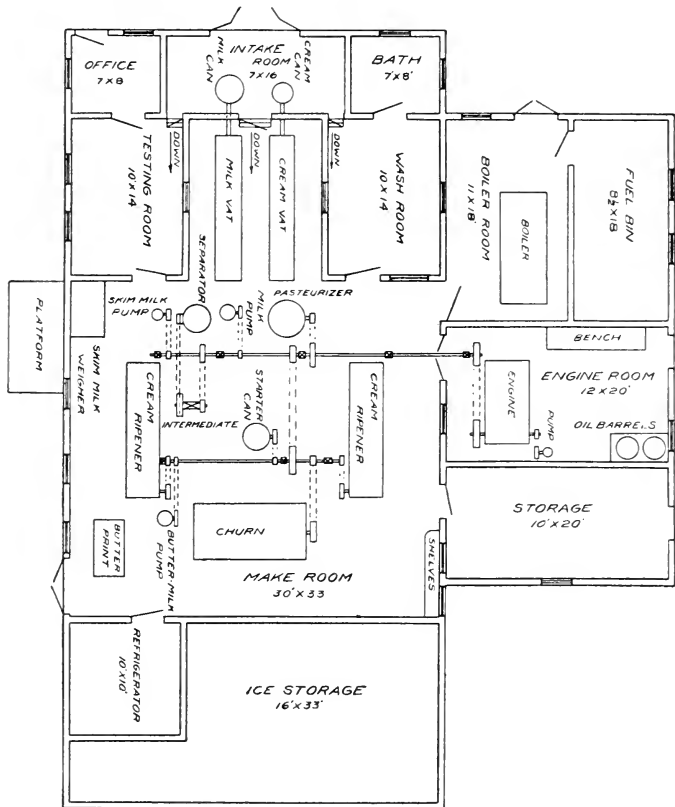

Fig. 39.—Floor plan of combined gathered cream and whole milk creamery.

sanitary milk pumps then in use for elevating the milk into the separators. With the vanishing of the old un-

cleanable milk pumps and with the advent of pumps for forcing cream into the churn, vanish the chief objections that have always been raised against the one floor creamery. Our present sanitary milk pumps can be cleaned as readily and thoroughly as our milk and cream vats.

Fig. 39 illustrates a floor plan of a combined gathered cream and whole milk creamery. Only the intake in this plan is elevated so as to permit the milk and cream to flow by gravity into the receiving vats.

Some prefer to dispense with the cream can shown in the intake. In such cases the cream receiving vat is placed against the intake and the cream is conducted into it by means of a wide spout running through the intake partition, in a manner similar to dumping grain at grain elevators.

The ceiling in the storage room should be six feet high, allowing just one tier of salt barrels to be stored there. The space above is utilized for storing butter tubs. The engine room is ceiled and the space above utilized for a hot water tank and butter tub storage. The water and steam gauges should be placed in the make room next to the boiler room where they can be observed from all points of the creamery.

In regard to the cold water tank, it is well to remember to locate this where it is easily accessible. This tank should be frequently cleaned, a matter whose importance is too often underrated by buttermakers. Both the hot water and cold water tanks should have overflow pipes about twice the size of the inlet pipes to prevent slop and damage from overflowing tanks.

**Location of Refrigerator and Ice House.** It is a

great mistake to have the ice house detached from the creamery. Where this is the case much unnecessary labor has to be performed in filling the refrigerator. The ice house and refrigerator should adjoin with only a well built wall between them.

**Intake for Whole Milk Creamery.** Nowhere in the creamery can so much labor be economized as in the intake when properly constructed. The author can state from years of experience at the intake, handling from 10,000 to 15,000 pounds of milk daily, that the work in a poor intake is by far the hardest that falls to the lot of the butter maker. Where cans weighing from 100 to 200 pounds have to be raised one or two feet to get them from the wagon onto the platform, and then three feet more to get them emptied into the weigh can, the amount of work necessary in weighing in 15,000 pounds of milk is easily imagined. Intakes of this type are numerous.

On the other hand, an intake that dispenses with all this can lifting offers comparatively easy work. Fig. 40 illustrates such an intake. The top of the wagon box is on a level with the platform. The can after reaching the platform is dumped without practically any lifting. When ten gallon cans are used (and these are always preferred) and a moderately strong boy draws the milk, the butter maker need not step upon the platform at all. He smells of every can before it is dumped, weighs and samples the milk, and distributes the skimmilk and buttermilk. Any creamery that is located where there is a moderate slope can have an intake like that here referred to with the little extra cost of the platform.

**Construction of Floor.** Construct a six-inch concrete floor upon a well tamped foundation consisting of gravel,



cobble stones and cinders. These materials afford good drainage and thus prevent the cold and dampness usually associated with concrete floors. In preparing the concrete for the floor use one part cement, two parts clean, coarse sand and four parts gravel or crushed stone. Finish with one part cement and one part sand.

All parts of the floor should slope toward the drain in the center. Round out the corners and edges of the floor with concrete to make them more easily cleanable.

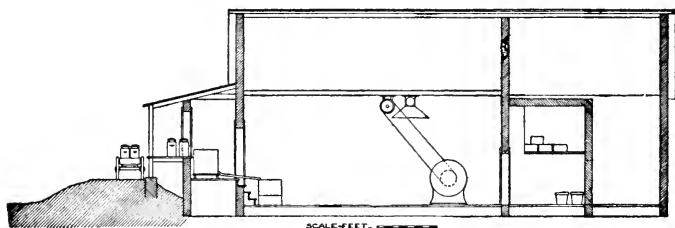

Fig. 40.—Section through whole milk creamery.

To provide insulation for the concrete floor of the refrigerator, asbestos, hollow brick or tile is used as shown in Fig. 42, p. 185. The asbestos must be protected from moisture by covering both sides with waterproof paper.

**Construction of Walls and Ceiling.** The inside of the brick or block walls are preferably finished with cement plaster as follows: First apply about one inch of cement plaster, consisting of one part cement, three parts clean, coarse sand, and one part slaked lime paste. Follow this with a finish consisting of one part cement and one part sand and trowel off as smoothly as possible. The appearance of a wall thus constructed is much improved by coat-

ing it with a cement filler which produces a uniform, grayish color.

The ceiling should be built of the best ceiling lumber and must be kept well painted.

**Sewerage.** Effective sewerage must be provided at the time the floor is laid. A bell trap (Fig. 41) should be placed in the center of each room and carefully connected with the sewer. Conduct the sewage far enough away to keep its odors a safe distance from the creamery. See chapter XX.

**Ventilation.** Hitherto this subject has received little or no attention whatever from creamery builders.

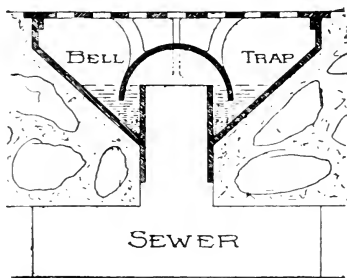

Fig. 41.—Bell trap.

The influence of foul, moist air upon the quality of the butter and the general health of the buttermaker is too little appreciated. We hear much about that "peculiar creamery odor" which is simply another expression for

the foul, moist, stifling air that prevails in a great many of our creameries. Almost daily we learn of butter makers who are forced into retirement or compelled to take up other lines of work because of lung trouble, rheumatism, or general ill health. Unsanitary creamery conditions are held accountable.

Ventilating shafts, extending from the creamery room to the top of the building where they end in cupolas, are serviceable but inadequate for the best ventilation. The most effective ventilator with which the author is ac-

quainted is installed in the Michigan Dairy School. This ventilator consists of a galvanized iron pipe, fifteen inches in diameter, which is suspended from the ceiling. The pipe starts from the middle of the creamery room, where it is expanded into a cowl five feet in diameter, and is placed right up against the ceiling. It ends in a fan or blower four feet in diameter which is located in the boiler room. Here the blower connects with a chimney extending from the floor through the roof of the building. The fan is so run that it will suck the air from the creamery room into the ventilating pipe whence it is discharged into the chimney. With a speed of two hundred revolutions per minute the air of an ordinary creamery room can be changed six to eight times per hour. Less than one horse power is required to run the fan.

Sucking the air out of the room will, of course, necessitate an inlet of air from the outside. A two-inch screen under a few windows will answer this purpose very well.

The cost of pipes and blower will not exceed \$125, an amount that should be no consideration where the health of the butter maker and the quality of the butter are at stake.

**Bath Room.** Some, no doubt, will look upon a bath room as a novelty and luxury rather than as a necessary adjunct to the creamery. But where everything needs to be kept so scrupulously clean, it must be important for the butter maker and his assistants to keep themselves clean also. The sweaty smell of the butter maker can certainly have no favorable effect upon his produce, so sensitive to all odors, nor upon his own precious health. A light daily bath after the work is done can not fail to add much to the comfort and health of the

butter maker and his helpers. The bath room will add to the sanitary aspect of the whole creamery and will teach the patrons an object lesson in personal cleanliness in the care and handling of their milk.

Where a septic tank is used there is no reason why the bath room should not be equipped with a water closet. This should be done both as a matter of sanitation and convenience.

**Heating of Creamery.** Creameries should be heated by steam, not with stoves. Either the exhaust steam from the engine or steam taken directly from the boiler may be used for this purpose. The heating pipes should be so arranged that either may be used when desired.

Where the exhaust steam is used to heat water for the boiler and for washing, it may be best to heat the building with steam taken directly from the boiler.

A very satisfactory method of piping is the following: Run one and one-half inch pipes from the boiler to within two feet of the floor, and close to the walls of the creamery room. The pipes should pass all around the creamery room and end in a steam trap which discharges the condensed steam into a hot well located near the injector, so that the hot water may readily be drawn into the boiler. The heating pipes must all slope towards this well. Where the boiler floor is lower than the creamery floor an oil barrel sawed in two may be made to serve the purpose of a hot well.

A *reducing* valve should be placed near the boiler so that any amount of pressure may be carried in the heating pipes. With a good valve of this kind a pressure as low as one pound may be carried when the boiler pressure varies from twenty to fifty pounds.

The cost of steam trap and reducing valve should not exceed \$15.

**Screening.** Where proper sanitation is expected it is absolutely necessary to guard against flies, and this can easily be done by screening all doors and windows. Flies are a prolific source of milk contamination and must therefore be rigidly excluded from the creamery.

## CHAPTER XIX.

### ICE, ICE HOUSE AND REFRIGERATOR.

#### ICE.

**Necessity of Ice.** Where there is no equipment for mechanical refrigeration, an abundant supply of ice becomes indispensable in making the best quality of butter. A low refrigerator temperature can not be maintained without the use of a great deal of ice. The increased use of starters and pasteurizers also demands increasingly large supplies of ice.

**Cooling Power of Ice.** A great deal of cooling can be done with a comparatively small amount of ice. This is due to the latent or "hidden" cold in ice. Thus to convert one pound of ice at  $32^{\circ}$  F. into water at the same temperature requires 142 units of heat, or, in other words, enough cold is given out to reduce the temperature of 142 pounds of water one degree Fahr.

**Source of Ice.** Always select the cleanest ice available. Lake ice usually proves very satisfactory. Where the source of ice is at too great a distance from the dairy, an artificial pond should be made upon ground with a reasonably impervious subsoil and with a natural concave formation. If such a piece of ground is flooded with water during the coldest weather, an ample supply of ice will be available in a very short time.

**Cost of Making Ice.** Where ice can be obtained within a reasonable distance, the cost of cutting, hauling and packing should not exceed one dollar per ton.

## ICE HOUSE.

**Location.** The ice house should be joined to the creamery, preferably at the north end, which affords the greatest protection from the sun. Where the ice house is detached from the creamery, too much unnecessary labor must be performed in filling the refrigerator. See Fig. 39, page 174.

**Size of Ice House.** The size of the ice house will depend, of course, upon the amount of ice to be used. When this has been determined, calculate the necessary storage space by allowing 57.5 pounds for every cubic foot of ice. For a creamery making on an average 1,000 pounds of butter a day, an ice house 16 feet high, 32 feet long and 16 feet wide will usually be found adequate. It should be remembered, however, that the amount of ice necessary to make a given amount of butter will depend, to no small extent, upon the degree of insulation of ice house and refrigerator and the amount used for cooling cream, making ice cream, selling cream, etc.

**Construction of Ice House.** To keep ice satisfactorily three things are necessary, (1) good drainage at the bottom, (2) good insulation, and (3) abundant ventilation at the top.

Good drainage and insulation at the bottom can be secured by laying an eight-inch foundation of stones and gravel and on top of this six inches of cinders, the whole being underlaid with drain tile. One foot of sawdust should be packed upon the cinders and the ice laid directly upon the sawdust.

Satisfactory walls are secured by using matched boards on the outside of the studs and common rough boards on

the inside, leaving the space between the studs empty. The ice should be separated from the walls by one foot of sawdust.

Solid foundation walls must be provided to prevent the entrance of air along the base.

The space between the sawdust covering on top of the ice and the roof should be left clear. Openings in the gable ends as well as one or two ventilating shafts projecting through the roof, should be provided to insure a free circulation of air under the roof. This will not only remove the hot air which naturally gathers beneath the roof, but will aid in drying the sawdust.

The ice must be packed solidly, using no sawdust except at the sides and bottom of the ice house and on top of the ice when the filling is completed. At least one foot of sawdust must be packed on top of the ice.

As a matter of convenience in filling and emptying the ice house, doors should be provided in sections from the sill to the gable at one end of the building.

#### REFRIGERATOR.

**Location.** When convenience in filling is desired, the refrigerator should be built in a corner of the ice house, as shown in Fig. 39.

**Size.** This will depend, of course, upon the amount of butter made. For a creamery making from 800 to 1,000 pounds of butter a day a refrigerator 8 to 10 feet wide by 10 feet long will be found large enough.

**Refrigerator With Ice Overhead.** From the standpoint of efficiency, the ice should be placed overhead, and not at the end or sides of the refrigerator as is commonly done. With ice placed overhead it is possible to



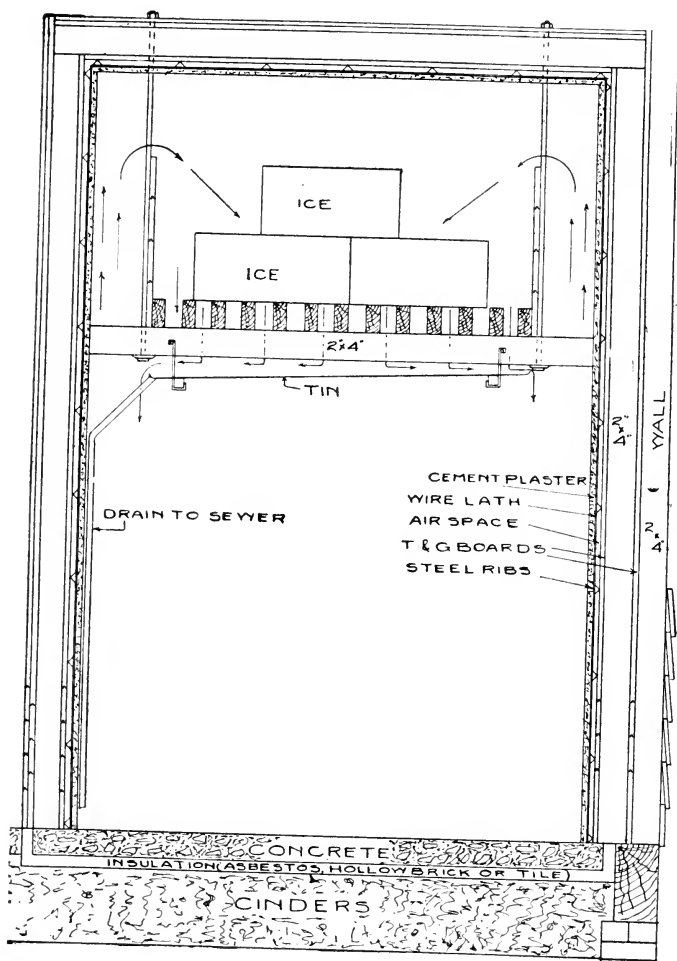

Fig. 42 — Refrigerator with ice overhead.

secure a drier and cooler air. This method of refrigeration is illustrated in Fig. 42. The entire inside of this refrigerator is finished with cement plaster making it both durable and sanitary. Two dead air spaces are provided: a three-quarter-inch space between the concrete and the boards to which the wire lathing is fastened and a four-inch space between the 2x4-inch studding. These two spaces together with the four layers of paper used, provide a high degree of insulation.

The concrete floor of the refrigerator is constructed upon a foundation of twelve inches of cinders, overlaid with hollow brick, tile, or asbestos wrapped in waterproof paper. This construction provides the necessary insulation.

The floor of the ice chamber is built of 2x4-inch studding running the length of the refrigerator. These studs are laid about three inches apart to allow the water from the melting ice to drip through. Below the ice chamber is a shallow pan, which catches the drip from the ice and conducts it into the sewer. The pan is supported by means of two 2x4-inch studs running the full length of the ice chamber. Both ends of the studs are provided with hooks by means of which the pan is readily attached to, and detached from, the ice chamber. This method of attachment is necessary to permit the easy removal of the pan for cleaning.

The refrigerator must be provided with a door having at least two dead-air spaces and two flanges which fit snugly into the frame of the refrigerator.

The ice is admitted to the ice chamber through a door in the rear end of the refrigerator.

**Refrigerator With Ice at End.** This style of refrig-

erator, while less efficient than that using ice overhead, is commonly preferred because of the greater ease of filling the ice chamber. Fig 43 illustrates the general plan of construction. The details as to floor and wall construction are the same as those shown in Fig. 42.

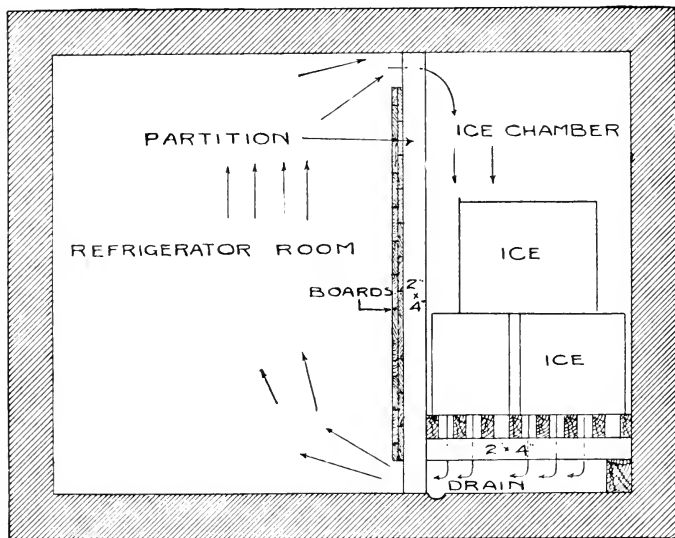

Fig. 43.—Refrigerator with ice box at end.

**Refrigerator Cooled with Ammonia.** Such a refrigerator may be constructed in the same way as the one described in the preceding pages, with the exception of the ice chamber. In place of this a brine tank and refrigerator coils are used as shown in Fig. 52, page 206. For further particulars regarding this method of refrigeration, see chapter on Mechanical Refrigeration.

## CHAPTER XX.

### SEWAGE DISPOSAL.

To secure a high degree of sanitation in and about the creamery it is necessary to see that proper disposal is made of the sewage from both the creamery and the dwelling of the buttermaker. Where the latter is situated close to the creamery its surroundings may do about as much harm as those of the creamery itself.

With open privies and the careless dumping of kitchen slops near the dwelling, we have a double means of endangering the creamery. If the ground near the dwelling and privy slopes in the direction of the water supply, the latter is likely to become contaminated through seepage in the manner indicated in Fig. 69. In addition to this there is the danger of flies carrying various kinds of bacteria from these places to the creamery. Flies not only carry the obnoxious, putrefactive species, but too often also the deadly pathogenic kinds, such as cause typhoid fever, to say nothing of the offensive excrementitious matter conveyed in this manner.

Obviously the accumulation of sewage about the creamery itself is attended by even greater dangers than those arising from the unsanitary surroundings of the dwelling. Moreover there is certain to be trouble also from bad odors.

### SEPTIC TANK.

The best means of taking care of the sewage from

both the creamery and the dwelling is to run it into a septic tank (see Fig. 44, designed by the author) and from this into a net-work of tile laid underground where it will irrigate and fertilize the soil.

**Object of Septic Tank.** The main purpose of the tank, as its name indicates, is to thoroughly decompose all organic matter entering it. This is accomplished by numerous species of bacteria, and the tank may be properly designated as a germ incubator. Where the

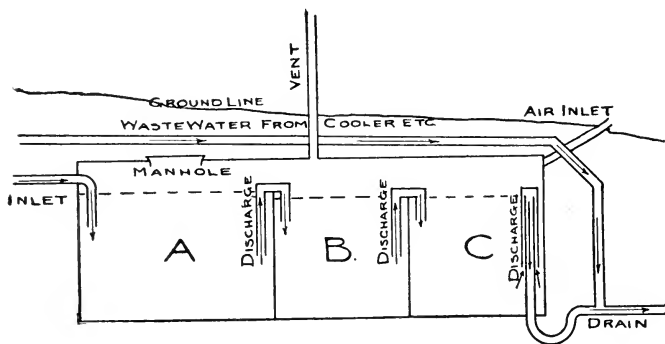

Fig. 44.—Septic Tank.

sewage is emptied into underground tile, the tank also serves as a storage, discharging its contents intermittently. This is necessary to force the liquid to all points of the system and to allow time for each discharge to soak away before the appearance of the next.

**Construction of Tank.** The general plan of construction is illustrated in Figs. 44 and 45. The tank is located in the ground with the top within a foot or two of the surface. For durability it is preferably constructed of brick, stone or concrete. The tank is so constructed as to

retain all sediment and floating material, since the discharges permit the withdrawal of the liquid from near the middle of the tank only. This is one of the main features of the tank. All inorganic matter entering the tank will gradually settle and, of course, remain in it. Some of the organic matter tends to settle during the first 24 hours,

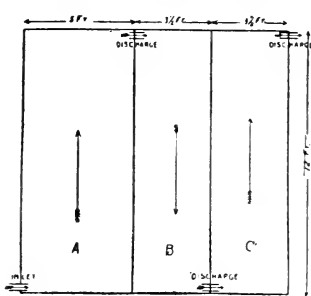

Fig. 45.—Cross Section of Septic Tank.

after which it comes to the surface to be gradually wasted away by the action of bacteria. This wasting away is naturally very slow, and since the slowly gathering organic matter nearly all remains in the first section of the tank, this must be large enough to provide for a considerable accumulation of it.

The tank should be built air tight, except in two places. At the right is an air inlet, consisting of a goose-neck pipe, which renders the vent at the top more effective. This vent consists of a long shaft extending beyond the top of the dairy, thus carrying off the foul gases caused by the decomposition of the material within. One-inch gas pipe, properly fastened, will serve as a satisfactory vent.

In order to afford communication of sections A and C with the vent, the two partitions should not be built quite as high as the tank. There should be at least one inch space between the top of the partitions and the cover.

A 1½-inch gas pipe should be laid over the tank through which the water from the cooler and vats may be discharged directly into the drain. This water

requires no purification and, if conducted through the tank, would necessitate one of too large dimensions. Moreover, the large amount of cold water needed for cooling milk and cream would cool the contents of the tank too much for a rapid decomposition of the material within.

**Size of Tank.** This must necessarily depend upon the amount of sewage run into it. In general it should have capacity sufficient to hold all of one day's waste in the smallest section (C). It will be noticed from the cut that section A is considerably larger than either of the other two. The reason for this is that nearly all of the inorganic matter remains in the bottom of this part of the tank, while the organic matter, as already stated, gradually accumulates at the surface in this section, in spite of constant decomposition. Where the tank receives the sewage from both the dairy and the dwelling, a tank 12 feet square by  $4\frac{1}{2}$  feet deep will be large enough, provided the water used for cooling is not run into it. It is well to remember, however, that the larger the tank used the better the results that may be expected from it.

**Flow of Sewage Through Tank.** Four-inch tile, carefully laid, may be used to conduct the sewage from the creamery to the tank. A trap is placed near the creamery to shut off the odors coming from the drain. At the point at which the sewage enters the tank it is desirable to attach an elbow with an arm sufficiently long to keep the lower end always in the sewage. This prevents undue mixing of the incoming sewage with that already in the tank, a matter of importance in the successful operation of the tank.

When the sewage in section A has reached the dotted line, it begins to discharge into section B through three-

inch gas pipe as shown in Fig. 45. The liquid is withdrawn from a point near the middle of the tank as indicated by the discharge pipes. The eight-inch space above the discharge permits the accumulation of organic matter. The discharge from 'B into C is the same as that from A into B; but the discharge pipes are of necessity lower by an amount indicated by the dotted lines. Compartment C discharges intermittently by means of an automatic syphon.

The sewage becomes gradually purified in its passage through the tank, and as it flows from the last section it is nearly as clear as water, but has a slightly sour odor, which it seems to retain and which is in no way objectionable. The purified sewage has been kept for weeks with no sign of the development of putrefactive odors.

The discharges should be arranged as shown in Fig. 45. This arrangement will cause the least mixing of old and new sewage. There is no discharge from A into 'B until the second day's sewage flows into A. Similarly there is no discharge from B into C until the second discharge into B, etc. The sewage, therefore, requires from three to four days in its passage through the tank.

**Cost of Septic Tank.** A double partition tank, 12 feet square and  $4\frac{1}{2}$  feet deep, constructed of concrete consisting of one part cement, two parts sand and four parts gravel, will cost approximately \$50.00 when the walls are five inches thick.

#### SEWAGE DISPOSAL FROM DWELLING.

The open privy and the cesspool of kitchen slops are objectionable not only in so far as they affect the creamery, but also in that they constitute a source of danger to the members of the family in ways entirely disconnected with the milk supply. With the creamery



already equipped with power to pump and elevate water, there is apparently no reason why the dwelling should not be equipped with a water closet. And with a water closet in the house there would be practically no expense connected with the disposal of the kitchen waste, since this would be discharged directly into the soil pipe connected with the closet. What a convenience such an equipment would afford to the housewife and members of the family!

If the dwelling and creamery are reasonably close together, one septic tank will answer for both. In such a case the tank is located between the two buildings. Where a great distance separates the buildings, a tank is provided for each and the outlets are brought together as near the tank as possible to save extra expense of tile.

#### SUBSURFACE IRRIGATION.

While the septic tank sufficiently decomposes the organic matter to leave the sewage from the tank without offensive odors, it is best to run the discharge into a system of underground tile where it will serve as a fertilizer and as an irrigating agent. The tile should be laid below the frost line. In loose soils one foot of tile per gallon of sewage will answer. Clayey soils require two to three times this amount.

Three-inch agricultural drain tile are best adapted for drainage work of this kind, the tile being laid with open joints and with a slope of three or four inches per hundred feet.

It is important that this subsurface irrigating system be located where there is no seepage into the water supply. In places where there is no danger from frost it is best to lay the tile only about one and one-half feet below the surface.

## CHAPTER XXI.

### WASHING AND STERILIZING MILK VESSELS.

**Wash Sinks.** A matter of importance in washing milk vessels is to have the right kind of sinks, three of which are needed for the most satisfactory work: One

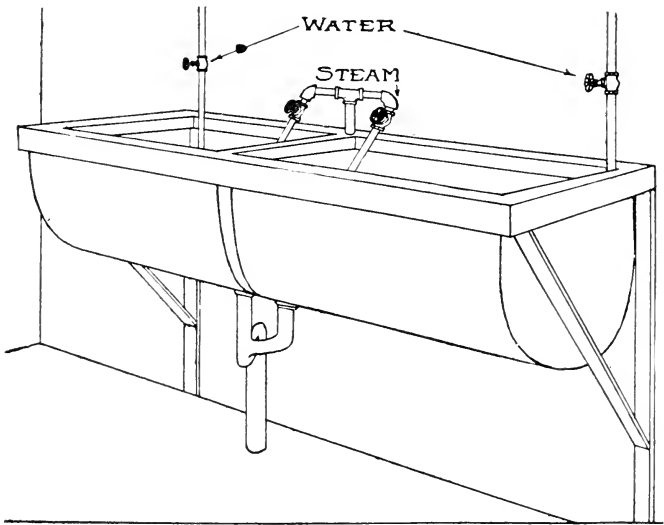

Fig. 46.—Wash Sinks.

for rinsing before washing, one for washing and one for final rinsing.

For convenience the wash sink should be thirty-six

inches long, twelve inches deep, and sixteen inches wide. The bottom should be round and two feet from the floor. When closer to the floor than this too much stooping is required.



Fig. 47.—A Good Cleaning Brush.



Fig. 48.—Milk Bottle Brush.

Galvanized iron furnishes one of the most suitable materials for the construction of wash sinks. They should be provided with steam and cold water pipes as shown in Fig. 46.

**Method of Washing.** All vessels should be thoroughly rinsed in warm water to remove small residues of milk and cream. The rinsing is followed by washing with moderately hot water to which a handful of some cleaning powder has been added. The washing should be done with brushes rather than cloths because the bristles enter into crevices which a cloth could not possibly reach. Finally rinse the vessels in clean water.

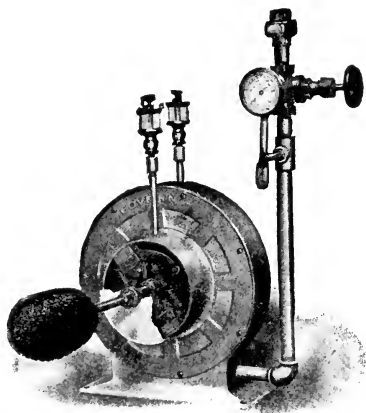

Fig. 49.—Bottle Washer.

A bottle washer, like that shown in Fig. 49, saves much

labor and does very efficient work. The motive power may be either steam or water.

Where many cans are washed a can washer will be found helpful. In cleaning cans it is well to remember that water alone will not clean them. The water must be reinforced with a brush and some cleaning powder.

**Sterilizing.** Vessels that have been washed in the manner described above may look perfectly clean, but may still be far from being free from bacteria. These can be destroyed only by exposing the vessels to the boiling temperature for some time.

Cans may be sterilized by inverting them over a steam jet several minutes. They should be left inverted some time after steaming to drain.

Open vats, milk tanks, butter printers, etc., can not be satisfactorily steamed; they should be sterilized with boiling water.

Dippers, pails, separator parts, bottles, butter ladles, packers, etc., are preferably sterilized with steam in a closed sterilizer. The author has designed and thoroughly tested a cheap, concrete sterilizer which answers the purpose entirely satisfactorily. This sterilizer should be built in a corner of the wash room.

**Sterilizer Designed by the Author.** A section through this sterilizer is shown in Fig. 50. Essentially, it is a rectangular concrete tank with a wooden cover, which is lined with zinc. The sides and bottom are five inches thick and are built of concrete, which is made up of one part cement, two parts of sand, and two parts of coarse gravel. A thin coat, consisting of one part cement and two parts sand, is used as an inside finish. A piece of 2x4-inch studding is placed around the top of the tank

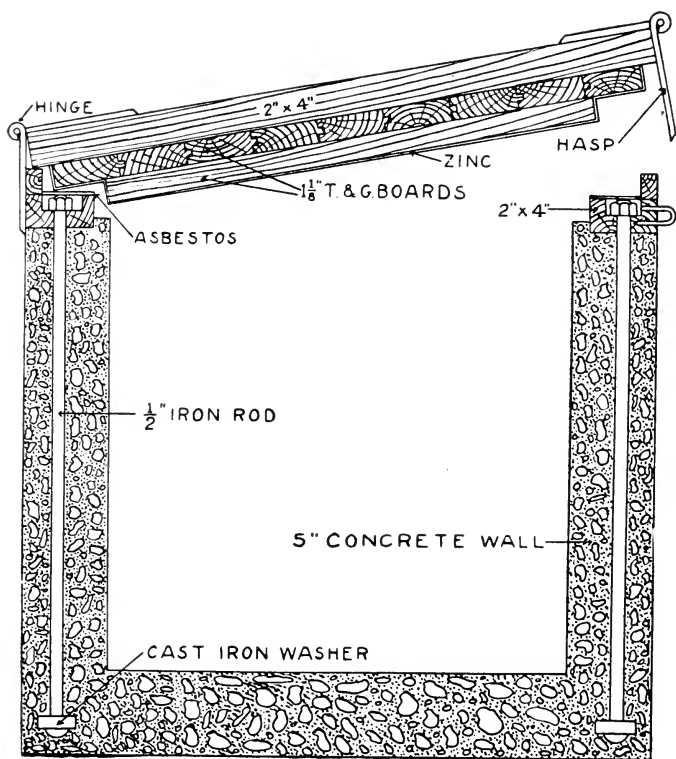

Fig. 50.—Cross-section of concrete sterilizer.

and is secured by six one-half inch iron rods, two feet long and embedded in the concrete walls, one being placed at each corner, and one on either side midway between the corners. This arrangement not only strengthens the tank, but also makes the cover fit tighter.

The cover consists of two thicknesses of one and one-eighth inch tongued and grooved flooring three and one-half inches wide. The upper boards run lengthwise and the lower crosswise of the tank. The lower boards fit into a shoulder projecting from the base of the 2x4-inch studding. The entire inside portion of the cover is covered with zinc. To insure additional tightness of the cover, a layer of asbestos is placed on top of the 2x4s. A heavy weight attached to a one-half inch rope running over a pulley fastened to the ceiling, raises the cover and holds it open when desired. The cover is strengthened by running three pieces of 2x4-inch studding crosswise of the tank, one at the middle and one at either end. The hinges by which the cover is fastened are attached to these 2x4s, as shown in Fig. 50.

A safety valve, set at ten pounds pressure, is inserted through the top of the cover at the most convenient place. A bell trap (see Fig. 41) placed in the bottom of the sterilizer serves as an outlet for the condensed steam.

The steam is admitted either through the sides or through the bottom of the sterilizer, and both inlet and outlet pipes should be laid in the concrete at the time the sterilizer is being built.

A false, perforated metallic bottom is placed one inch from the bottom of the sterilizer, on which all vessels are placed in an inverted position.

The following is an itemized statement of the cost of the material used in the construction of this sterilizer, whose inside dimensions are: length, 7 1-3 feet; width, 2 1-4 feet; depth, 2 1-3 feet.

2 bbls. of Portland cement.....	\$5.20
20 ft. of 2 x 4 studding.....	.30
110 ft. of 1 $\frac{1}{8}$ tongued and grooved flooring, 3 $\frac{1}{2}$ wide.....	4.40
4 hinges .....	.40
5 lbs. nails .....	.20
6 $\frac{1}{2}$ -inch iron rods 2 $\frac{1}{2}$ feet long.....	1.20
3 hasps .....	.30
20 sq. ft. zinc .....	1.75
Ball and lever safety-valve.....	1.00
3 pounds sheet asbestos .....	.30
Total .....	<u>\$15.05</u>

**Elevated Hot Water Tank.** A tank providing hot water should be located in or near the boiler room and elevated so that hot water can be conducted to the churn, butter printer and vats. A few coils of gas pipes placed in the bottom of the tank, through which the exhaust steam from the engine can be conducted, will furnish all the hot water necessary. This tank should be covered and provided with a vent to permit the escape of steam during excessive heating of the water within.

## CHAPTER XXII.

### DETECTION OF TAINTED MILK AND CREAM.

In well regulated creameries the head butter maker will usually be found at the intake every morning carefully examining the milk as it arrives at the factory. It requires skill and training to detect and properly locate the numerous taints to which milk is heir. It also requires considerable tact to reform patrons who have been careless in the handling of their milk. The best skill available in the creamery should therefore be placed in the intake.

In the daily examination of milk, defects can usually be detected by smelling of it as soon as the cover is removed from the cans. When, however, milk arrives at the creamery at a temperature of  $50^{\circ}$  F. or below, it becomes more difficult to detect taints; indeed during the winter when milk is often received in a partly frozen condition, experts may be unable to detect faults which become quite prominent when the milk is heated to a temperature of  $100^{\circ}$  F. or above.

Frequently milk is seeded with undesirable kinds of bacteria which have not had time to develop sufficiently to manifest themselves at the time the milk is delivered to the creamery, but which later in the course of cream ripening produce undesirable flavors. It is necessary, therefore, in making a thorough examination of milk to heat it to a temperature of from  $95^{\circ}$  to  $100^{\circ}$  F. and to keep it there for some time to permit a vigorous bacterial development. Such bacterial development can be carried on in what is known as the Wisconsin Curd Test and the Gerber fermentation test.



## WISCONSIN CURD TEST.

This test originated at the Wisconsin Dairy School. The name of the test implies that the samples of milk to be tested are curded, which is accomplished in a manner similar to that in which milk is curded for cheese making.

The Wisconsin Curd Test is frequently spoken of as "fermentation test," since the process involved consists in fermenting the milk by holding it at a temperature at which the bacterial fermentations go on most rapidly.

**Apparatus.** This consists of one pint cylindrical tin cans placed in a tin frame, and of a well insulated box made so that the tin frame will nicely slide into it. Added to this is a case knife, and a small pipette used to measure rennet extract.

The construction of the box and the position of the cans inside is illustrated in Fig. 51. This box consists of three-eighths inch lumber, the inside of which is lined with a quarter inch thickness of felt. Narrow strips are tacked on the felt and tin upon these, the object of the strips being to prevent conduction of heat by contact of the tin with the felt. The cover of the box is constructed in the same way and made to fit tight. This construction makes it possible to maintain a nearly constant temperature of the samples which are surrounded by water as shown in the illustration.

**Making the Test.** A curd or fermentation test is made at the creamery by selecting from each patron about two-thirds of a pint of milk and placing this in the tin pint cans after they have been thoroughly sterilized. Each pint can should be provided with a sterilized cover which is placed upon it as soon as the sample has been taken.

The sample cans are next placed in the insulated box provided for them. Here they are warmed by adding water at a temperature of  $103^{\circ}$  F. to the box, a temperature which should be maintained throughout the whole test.

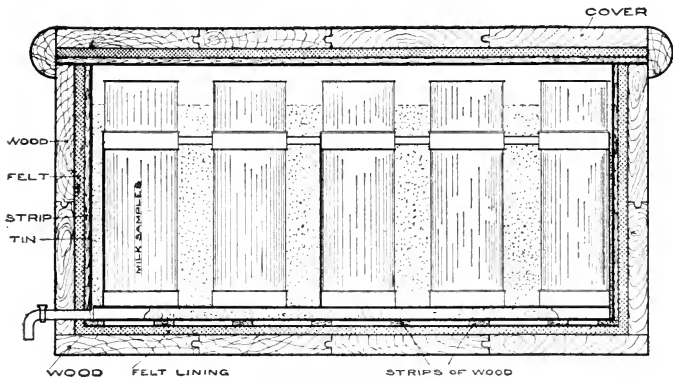

Fig. 51.—Section through curd test.

With a sterile thermometer watch the rise in temperature until it has reached  $86^{\circ}$  F. when 10 drops of rennet extract are added to each sample and mixed with it for a few moments with a sterile case knife. This knife must be sterilized for each sample to avoid transferring bacteria from one can to another.

As soon as the milk has curdled it is sliced with the case knife to permit the separation of the whey. After the whey has been separating for half an hour, the samples should be examined for flavor, which can be told far better at this stage than is possible by smelling of the milk as it arrives at the creamery.

After the samples have all been carefully examined, the whey is poured off at intervals of from twenty to forty minutes for not less than eight hours. At the end

of this time a mass of curd will be found at the bottom of the can in which there has been a vigorous development of bacteria throughout the test.

If the sample of milk is free from taint, this curd when cut with a knife will be perfectly smooth and close. If, on the other hand, the sample contains gas germs, these in course of eight hours' development will have produced enough gas to give the curd an open spongy appearance when cut. The openings are usually small and round, hence the name "pin holes" has been applied to them indicating holes the size of a pin's head.

Whenever, therefore, milk produces a curd that answers this description it may be taken for granted that it contains undesirable bacteria.

Sometimes the milk may be tainted and yet produce a close textured curd, but in such cases the taint can be detected by carefully smelling of the curd.

**Precautions.** In making a test as above outlined two things must constantly be kept in mind: first, that to secure the desired bacterial development, the temperature of the samples must be maintained as nearly as possible at  $98^{\circ}$  F., which is accomplished by surrounding them with water at a temperature of  $103^{\circ}$ ; second, that to avoid contaminating one sample with another, the knife used for mixing the rennet with the milk and cutting the curd must be sterilized for each can. The thermometer used must also be sterile.

The temperature of the samples can easily be maintained by using a well insulated box like that shown in Fig. 51. When a common tin box is used it becomes necessary to change the water in it about once every half hour.

## GERBER FERMENTATION TEST.

This test is simpler than the Wisconsin Curd Test and can be used for both milk and cream. Where milk need not be examined specially for gas-producing organisms, this test will give as satisfactory results as the curd test. The essential difference between the two tests is the elimination of rennet extract with the Gerber.

**Making the Test.** The samples of milk or cream are placed in glass tubes which are numbered to correspond with the names of the patrons. These tubes are warmed in a tin tank containing water whose temperature is maintained at 104° F. throughout the test by placing a lamp under the tank. At the end of about six hours the samples are examined for flavor, color, taste and consistency. After this examination, they are put back into the tank to be re-examined after another interval of about six hours. Any "off" condition of the milk or cream can usually be told at the end of six to twelve hours.

## CHAPTER XXIII.

### MECHANICAL REFRIGERATION.

In warm climates and in localities where ice is not obtainable or only so at a high cost, cold may be produced by artificial means known as mechanical refrigeration. This system of refrigeration is also finding its way into creameries that are able to procure ice at a moderate cost but which are seeking more satisfactory means of controlling the temperature of their cream, refrigerator, make room, etc.

**Refrigerating Machines.** There are four kinds of machines used for refrigerating purposes: (1) vacuum machines in which water is used as the refrigerating medium; (2) absorption machines in which a liquid of a low boiling point is used as the refrigerating medium, the vapors being absorbed by water and again separated from it by distillation; (3) compression machines which operate practically the same as the absorption machines except that the vapors in this case are compressed instead of absorbed; and (4) mixed absorption and compression machines.

Most of the machines in use at the present time belong to the compression type; the following discussion will therefore confine itself strictly to this class of machines.

**Principle.** The principle employed in mechanical refrigeration is the production of cold by the evaporation of liquids which have a low boiling point, like liquid ammonia, liquid carbonic acid, ether, etc.

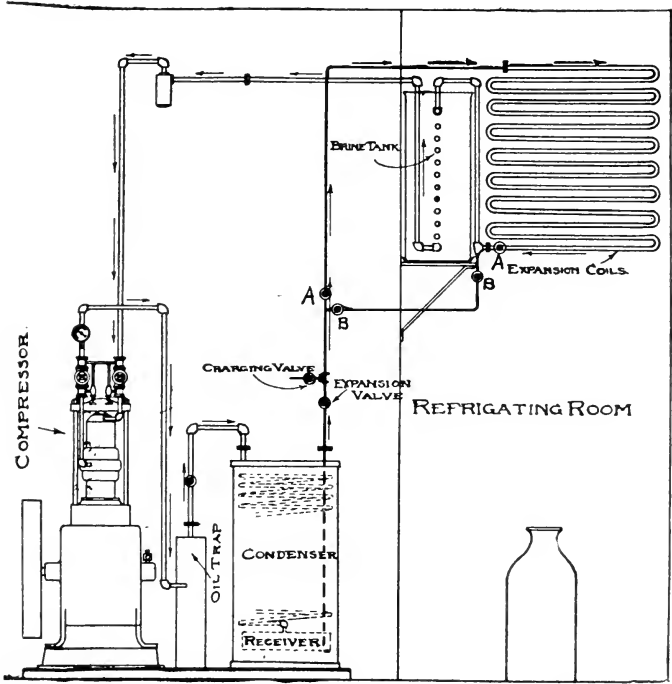

Fig. 52.—Showing circulation of ammonia in mechanical refrigeration.

When a liquid evaporates or changes into the gaseous state it absorbs a definite amount of heat called heat of vaporization or "latent" heat. Thus to change water from  $212^{\circ}$  F. to steam at  $212^{\circ}$  F. requires a considerable amount of heat which is apparently lost, hence the term latent (hidden) heat.

Ether changes into its gas at a much lower temperature than water which is illustrated by its instant evaporation when poured upon the hand. The heat of the hand in this case is sufficient to cause vaporization and the sensation of cold indicates that a certain amount of heat has been abstracted from the hand in the process.

Manifestly for refrigerating purposes a liquid must be used that can be evaporated at a very low temperature; for the cold in mechanical refrigeration is produced by the evaporation of the liquid in iron pipes, the heat for the purpose being absorbed from the room in which the pipes are laid. Anhydrous ammonia has thus far proven to be the best refrigerant for ordinary refrigeration.

**Anhydrous Ammonia (Refrigerant).** This substance is a gas at ordinary temperatures but liquifies at  $30^{\circ}$  F. under one atmospheric pressure. In practical refrigeration the ammonia is liquified at rather high temperatures by subjecting it to pressure. The ammonia is alternately evaporated and liquified so that it may be used over and over again almost indefinitely.

**Circulation of Ammonia.** The cycle of operations in mechanical refrigeration is as follows: The liquid ammonia starts on its course from a *liquid receiver*, and enters the *refrigerating coils* in which it evaporates, absorbing a large amount of heat in the process. By means of a *compression pump*, operated by an engine, the ammonia vapors are forced in the *condenser coils* where the

ammonia, under pressure, is again liquified by running cold water over the coils. From the condenser coils it enters the liquid receiver, thence again on its journey through the refrigerating coils.

The intensity of refrigeration is regulated by an *expansion valve*, which is placed between the liquid receiver and the refrigerating coils. This valve may be adjusted so as to admit the desired quantity of liquid ammonia to the coils.

**Systems of Refrigeration.** There are two ways in which the cooling may be accomplished by mechanical refrigeration: (1) by evaporating the liquid ammonia in a series of pipes placed in the room to be refrigerated; and (2) by evaporating the liquid ammonia in a series of coils laid in a tank of brine and forcing the cold brine into coils laid in the room to be refrigerated. The former is known as the direct expansion system, the latter as the indirect expansion or brine system.

**Brine System.** In creameries where the machinery is run only five or six hours a day the brine system is the more satisfactory as it permits the storing of a large amount of cold in the brine, which may be drawn upon when the machinery is not running.

The brine tank is preferably located near the ceiling in the refrigerator where it will serve practically the same purpose as an overhead ice box. In addition to this, the refrigerator should contain a coil of direct expansion pipes which may be used when extra cold is desired.

Brine from the above tank may be used for cooling cream by conducting it through coils which are movable in the cream vat; it may also be conducted through stationary pipes placed in the make room for the purpose



of controlling the temperature during the warm summer months.

The brine is kept circulating by means of a *brine pump*.

**Strength of Brine.** The brine is usually made from common salt (sodium chloride). The stronger the brine the lower the temperature at which it will freeze. Its strength should be determined by the lowest temperature to be carried in the brine tank. The following table from Siebel shows the freezing temperature as well as the specific heat of brine of different strengths:

Percentage of salt by weight.	Pounds of salt per gallon of solution.	Freezing point (F.).	Specific heat.
1.....	0.084	30.5	.992
2.....	0.169	29.3	.984
3.....	0.256	27.8	.976
4.....	0.344	26.6	.968
6.....	0.523	23.9	.946
8.....	0.708	21.2	.919
10.....	0.897	18.7	.892
12.....	1.092	16.0	.874
15.....	1.389	12.2	.855
20.....	1.928	6.1	.829
25.....	2.488	0.5	.783
26.....	2.610	-1.1	.771

The fact that the specific heat grows less as the brine becomes stronger shows it to be wise not to have the solution stronger than necessary, because the less the specific heat the less heat a given amount of brine is able to take up.

**Refrigerating Capacity.** When speaking of a machine of one ton refrigerating capacity, we mean that it will produce, in the course of twenty-four hours, the amount of cold that would be given off by one ton of ice at 32° F.

melting into water at the same temperature. Its actual ice making capacity is usually about 50% less.

**Size of Compressor.** In a moderately well insulated creamery handling from twenty to twenty-five thousand pounds of milk daily, a four-ton compressor will be large enough. With a compressor of this size the machinery will not have to be run more than five or six hours a day. If the machinery is run longer than this a smaller compressor will do the work.

**Power Required to Operate.** The power required per ton of refrigeration is less the larger the machine. With a four-ton compressor the power required is from two to two and one-half horse power per ton of refrigerating capacity in twenty-four hours.

**Refrigerating Pipes.** The refrigerating pipes vary from one to two inches in diameter. With moderately good insulation it is estimated that by the direct expansion system one running foot of two-inch piping will keep a room of forty cubic feet content at a temperature of 32° F. With brine nearly twice this amount of piping would be necessary.

For cooling the brine in the brine tank, about 140 feet of 1¼-inch pipes are required per ton of refrigerating capacity.

**Expense of Operating.** When a refrigerating plant has once been installed and charged with the necessary ammonia, the principal expense connected with it will be the power required to operate the compressor. This power in a creamery is supplied by the creamery engine. The ammonia, being used over and over again, will add but a trifle to the running expenses. Nor can the water used for cooling the ammonia vapors add much to the cost of operating. It is true, however, that the refrigera-

ting plant will require some of the butter maker's time and attention, but this is probably no more than would be consumed in the handling of ice in the creamery.

**Charging and Operating an Ammonia Plant.** This subject is so ably discussed in *The Engineer* by H. H. Kelley that the author feels he can do no better than present the following extracts from that article.

"When about to start an ice or refrigerating plant, the first thing necessary is to see that the system is charged with the proper amount of ammonia. Before the ammonia is put in, however, all air and moisture must be removed; otherwise the efficiency of the system will be seriously interfered with. Special valves are usually provided for discharging the air, which is removed from the system by starting the compressor and pumping the air out, the operation of the gas cylinder being just the reverse of that when it is working ammonia gas. It is practically impossible to get all the air out of the entire system by this means, so that some other course must be taken to remove any remaining air after the compressor has been started at regular work. This can be accomplished by admitting the ammonia a little at a time, permitting the air to escape through a purge valve, the air being thus expelled by displacement. The cylinder containing the anhydrous ammonia is connected to the charging valve by a suitable pipe, and the valve opened. The compressor is then kept running slowly with the suction and discharge valves wide open and the expansion valve closed. When one cylinder is emptied put another in its place, being careful to close the charging valve before attempting to remove the empty cylinder, opening it when the fresh cylinder is connected up.

"From sixty to seventy-five per cent of the full charge is

sufficient to start with so that the air may have an opportunity of escaping with as little loss of ammonia as possible. An additional quantity of ammonia may then be put in each day until the full charge has been introduced. When the ammonia cylinders have been emptied and a charge of, say, seventy-five per cent of the full amount has been introduced, the charging valve is closed and the expansion valve opened. The glass gauge on the ammonia receiver will indicate the depth of ammonia. The appearance of frost on the pipe leading to the coils and the cooling of the brine in the tank will indicate that enough ammonia has been introduced to start with. It is sometimes difficult to completely empty an ammonia cylinder without first applying heat. The process of cooling being the same when the ammonia expands from the cylinder into the system as when leaving the expansion valve, a low temperature is produced and the cylinder and connections become covered with frost. When this occurs the cylinder must be slightly warmed in order to be able to get all the ammonia out of it. The ammonia cylinders, when filled, should never be subjected to rough handling and are preferably kept in a cool place free from any liability to accident. The fact that ammonia is soluble in water should be well understood by persons charging a refrigerating system, or working about the plant. One part of water will absorb about 800 parts of ammonia gas and in case of accident to the ammonia piping or machine, water should be employed to absorb the escaping gas. Persons employed about a plant of this kind should be provided with some style of respirator, the simplest form of which is a wet cloth held over the mouth and nose.

“After starting the compressor at the proper speed and adjusting the regulating valve note the temperature of

the delivery pipe, and if there is a tendency to heat open it wider, and vice versa. This valve should be carefully regulated until the temperature of the delivery pipe is practically the same as the water discharged from the ammonia condenser. With too light a charge of ammonia the delivery pipe will become heated even when the regulating valve is wide open. As a general thing when the plant is working properly the temperature of the refrigerator is about  $15^{\circ}$  lower than the brine being used, the temperature of the water discharged from the ammonia condenser will be about  $15^{\circ}$  lower than that of the condenser, the pointers on the gauges will vibrate the same distance at each stroke of the compressor and the frost on the pipes entering and leaving the refrigerator will be about the same. By placing the ear close to the expansion valve the ammonia can be heard passing through it, the sound being uniform and continuous when everything is working properly.

“When air is present the flow of ammonia will be more or less intermittent, which irregularity is generally noticeable through a change in the usual sound heard at the expansion valve. The pressure in the condenser will also be higher and the effect of the apparatus as a whole will be changed, and, of course, not so good. These changes will be quickly noticed by a person accustomed to the conditions obtaining when everything is in order and working properly.

“The removal of air is accomplished in practically the same manner as when charging the system, permitting it to escape through the purging valve a little at a time so as not to lose any more gas than is absolutely necessary.

“The presence of oil or water in the system is generally detected by shocks occurring in the compressor cylinder.

“In nearly all plants the presence of oil in the system of piping is unavoidable. The oil used for lubricating purposes, especially at the piston rod stuffing boxes, works into the cylinders and is carried with the hot gas into the ammonia piping, where it never fails to cause trouble. The method of removing the air from the system has already been referred to, but the removal of oil is accomplished by means of an oil separator. This is placed in the main pipe between the compressor and the condenser, and is of about the size of the ammonia receiver. Sometimes another oil separator is placed in the return pipe close to the compressor, which serves to eliminate any remaining oil in the warmer gas and to remove pieces of scale and other foreign matter which, if permitted to enter the compressor cylinder, would tend to destroy it in a very short time.

“The oil, which always gets into the system sooner or later and in greater or less quantity, depending upon the care exercised to avoid it, acts as an insulator and prevents the rapid transfer of heat from the ammonia to the pipe that ought to obtain, and also occupies considerable space that is required for the ammonia where the best results are to be obtained.”

## CHAPTER XXIV.

### CREAMERY BOOK-KEEPING.

The object of book-keeping is to keep a record of business transactions, enabling the proprietor or proprietors at any time to determine the true condition of the business.

In most businesses usually one of two forms of book-keeping is followed: either double entry which makes use of three books—day book, journal, and ledger—or single entry which makes use of only two books, a day book or journal, and ledger.

The day book contains a detailed record of business transactions. Entries are made in this book as soon as the transaction occurs.

The journal contains the debits and credits arranged in convenient form for transferring to the ledger.

The ledger contains the final results.

**Debits and Credits.** These words are usually abbreviated Dr. and Cr. respectively. The *debits* and *credits* in any business transaction are determined by the following rule: *debit whatever costs value; credit whatever produces value.* In a journal entry the sum of the debits and the sum of the credits must be equal.

**Double and Single Entry Book-keeping.** While double entry is the most complete form of keeping a business record, it entails too much work for creameries, which have but a limited time to devote to keeping books.

Single entry book-keeping when properly carried out has proved very satisfactory and most creameries follow this method in a more or less modified form.

In the following pages a simple and approved method of book-keeping is presented which may be followed by any creamery whether proprietary, co-operative, or otherwise. In this method the following books and papers are made use of:

(1) Day book, (2) order book, (3) sales book, (4) cash book, (5) pay roll register, (6) ledger, (7) milk sheet, (8) milk book, (9) test book, and (10) butter slips.

**Day Book.** All transactions made at the creamery should be at once recorded in the day book. At the close of the day or at some convenient time the records made in the day book are transferred to the order book, sales book, or cash book, according to the transaction. The following examples illustrate the manner of making records in the day book.

January 6, 1900.

Sold to J. D. Steele & Co. on account 1,100 lbs. of butter @ 24c.....			\$264	00
Bought of Newman & Co., for cash, 1 san- itary milk pump.....	\$20	00		
5 gal. butter color @ \$1.70.....	8	50		
20 gal. separator oil @ 20c.....	4	00	32	50
Bought of H. Chandler on account 11 cords of wood @ \$3.00.....			33	00

When payment is made for goods at the time the transaction occurs the term "for cash" is used. When payment is made some time after the transaction occurs the term "on account" is used.



**Order and Sales Books.** All purchases and sales are recorded in the manner illustrated below :

ORDER BOOK.

Date, 1898.	Name.	Address.	Order.	Price.
March 3	Thorbin & Son.....	Chicago, Ill.....	300 butter tubs @ 30c.	\$90 00
" 7	Paul Burger.....	Thompsonville, Mich.	Tinning.....	3 00
" 16	R. S. D. & Co.....	Chicago, Ill.....	Butter printer.....	20 00
" 16	R. S. D. & Co.....	Chicago, Ill.....	1 bbl. cleaning powder	11 00
" 18	J. R. Smith & Co.....	Rushtown, Mich.....	Boiler repair.....	14 00

SALES BOOK.

Date, 1898.	Name.	Address.	No. Tub.	Our Weight.	Their Weight.	Price.	Proceeds.	Charges.	Net Proceeds.
Mar. 3	Willson & Co.....	Buffalo, N. Y.	18	900	900	\$0 20	\$180 00	.....	\$180 00
" 10	Willson & Co.....	Buffalo, N. Y.	20	1,050	1,040	20	208 00	.....	208 00
" 12	Nicholson & Fish..	N. Y. City....	30	1,800	1,800	21	378 00	\$3 50	374 50
" 18	Willson & Co.....	Buffalo, N. Y.	20	1,190	1,190	21	249 90	.....	249 90

**Cash Book.** Cash book records are illustrated below:

## CASH BOOK

Date, 1898.		Cash received.					
Mar. 1	*	Balance.....	From Feb.....	\$181	00		
" 10	4	Butter.....	Willson & Co.....	180	00		
" 14	4	" .....	Willson & Co.....	208	00		
" 20	5	" .....	Nicholson & Fish.....	374	50		
" 24	5	" .....	Willson & Son.....	249	90		
" 24	5	" .....	Nicholson & Fish.....	139	80		
" 28	5	" .....	Willson & Son.....	201	00		
" 28	5	" .....	J. C. R. & Co.....	10	10		
" 30	5	" .....	Nicholson & Fish.....	848	38		
				-----	-----	\$2,392	68

\* Sales book Page.

—(monthly record).

Date, 1898.		Cash paid.					
Mar. 10	§ 6	Butter tubs....	Thorbin & Son.....	\$90	00		
" 11	6	Tinning .....	Paul Burger.....	3	00		
" 18	7	Butter printer.	R. S. D. & Co.....	20	00		
" 24	7	Cleaning po'der	R. S. D. & Co.....	11	00		
" 27	7	Boiler repair...	J. R. Smith & Co.....	14	00		
" 27	7	Salary.....	John Smith.....	95	00		
" 28	7	Wood.....	W. Saunders .....	55	00		
" 29	7	Sundries.....	John Jones.....	4	35		
" 31	7	Patrons.....	Monthly dues.....	1,902	48		
" 31	7	Balance.....	To new account.....	197	85		
				-----	-----	\$2,392	68

§ Order book page.

**Pay Roll Register.** Each patron's monthly account is recorded in the pay roll register as illustrated below :

PAY ROLL REGISTER.

Date, 1899.	Number.	Name.	Milk.	Test.	Butter fat.	Price.	Amount.	Charges.	Check.	Check No.
April 5	1	John Smith.....	7,850	3.9	306.15	\$0 20	\$61 23	\$1.48	\$59 75	123V
" 5	2	Paul Wirth.....	4,575	4.0	183.00	20	36 60	.....	36 60	124V

V Means paid.

**The Ledger.** Where a good, permanent, and easily accessible record is desirable, the main items of all transactions should be posted under suitable heads in the ledger. Where there is liable to be a frequent change of bookkeepers the additional work involved in keeping a ledger is well justified.

In case monthly payments are made at the creamery all accounts should be closed once a month and those with different individuals should be kept separate. The following illustrates a ledger account with a butter firm in New York.

Dr.	John Johnson & Co.				Cr.			
1898.				New York City.				
Sept. 3	Balance.....	*12	\$90 40	Sept. 6	Check.....	¶14	\$80 35	
" 7	Sale .....	12	103 38	" 18	Check.....	14	139 85	
" 20	Sale .....	13	84 50	" 31	Balance.....	14	58 08	
Oct. 1	Balance .....	13	58 08					

\* Sales book page.

¶ Cash book page.

Below is illustrated a ledger account with a creamery supply house in Chicago:

Dr.				J. D. Murray & Co.				Cr.							
1898.								Chicago.							
Aug. 4	Check.....	*15	\$29 00	Aug. 1	Balance....	¶16	\$18 50								
" 11	Check.....	15	64 50	" 5	Order.....	16	70 38								
" 31	Balance .....	15	19 38	" 19	Order.....	16	24 00								
				Sept. 1	Balance....	16	19 38								

\* Cash book page.

¶ Order book page.

The following illustrates a ledger record with a patron of the creamery:

Dr.				William Sampson.				Cr.							
1898.								Piketown.							
August	31	Check.....	\$61 50	August	Milk.....	\$61 50	*18								
Sept.	31	Check.....	83 92	Sept.	Milk.....	83 92	19								

\* Pay roll register page.

✱ **Milk Sheet and Milk Book.** Immediately after milk is weighed it is recorded upon a milk sheet placed in the intake. This sheet consists of heavy paper with the date, name, and number of the patron upon it. The names should be arranged in alphabetical order. A suitable milk sheet is illustrated in Fig. 53.

Where care is taken in recording the milk upon the milk sheet, the milk book may be dispensed with. In that case a record of the milk is preserved by filing the milk sheets after each patron's total has been transferred

to the pay roll register. In case, however, a careful daily record of the milk is to be preserved, it is better to copy the milk from the milk sheet into a milk book in which a record may be preserved for a long time.

The figure shows a milk sheet form. At the top, there is a header area with diagonal hatching. Below this is a grid. The left side of the grid is labeled with numbers from 1 to 31, representing days of the month. The top of the grid is labeled 'STROPS' and 'TANKS'. The grid is used for recording milk production data.

Fig. 53.—Milk sheet.

**Test Book.** A permanent record of milk tests is made in the test book. The following illustrates the method of keeping such a record:

Patron's name. 1898.	Arenz, J. P.	Blake, E. S.						
Test No.....	1	2						
Date—Aug. 7.....	3.8	4.3						
"    15.....	3.9	4.3						
"    23.....	3.8	4.1						

**Butter Slips.** It is customary with creamery patrons to take the butter for their use at the creamery and have the value of it deducted from their check. If all butter thus taken were to be recorded in the day book and from this transferred to a patron's butter book, it would involve a great deal of labor for the butter maker. Hence the use of butter slips. These are small slips of paper on which the small butter accounts are kept until the close of the month. Below is illustrated one of these slips:

**BUTTER SLIP.**

DATE.....

NAME.....

LBS..... Oz.....

The butter slips are all placed on file until the close of the month when each patron's total butter charged to him is found from these slips. The charge thus found is entered directly in the column marked "charge" in the pay roll register, while the slips are preserved for future reference.

## CHAPTER XXV.

### CO-OPERATIVE CREAMERIES.

**I. Co-operative Creameries.** There are two distinct classes of creameries in existence at the present time. (1) Those owned and operated by private individuals, called proprietary creameries; (2) those owned and operated by the patrons, known as co-operative creameries.

Most of the creameries built at the present time belong to the co-operative type. This is the ideal plan upon which creameries should be built and operated and it has in most cases proved successful.

**Methods of Organizing Co-operative Creameries.** Too frequently co-operative creameries are established by so-called "promoters," whose aim is to make money for themselves by taxing the farmers a thousand dollars or more in excess of the actual cost of the creamery.

If a community of farmers is interested in the establishment of a creamery, the following method of organizing should be pursued:

1. Let those most interested in the project make a thorough canvass of the milk producers in that community to ascertain the number of cows available. There should not be less than 400 cows to start with.

2. If the desired number of cows is available, the next step is to secure a subscription of \$4,500 by selling shares for that amount. This sum of money is necessary to build and equip a substantial fire proof creamery containing all the modern creamery machinery. Where possible it is



desirable to sell shares only to prospective creamery patrons, so that the creamery may be a truly co-operative one.

3. When the necessary funds have been subscribed, call a meeting of the shareholders to elect a president, secretary, treasurer, manager, and a board of directors which should consist of the president, secretary, treasurer, and at least three other shareholders.

4. The next step is to specify a certain time within which all subscriptions must be paid. The money is preferably turned over to a reliable banker in the form of notes bearing interest.

5. The treasurer should be authorized to draw upon the bank for the money thus deposited whenever occasion demands, but he should be required to give security for the money that comes into his hands.

6. When all subscriptions have been paid, a meeting of the board of directors should be called for the purpose of hiring a butter maker who shall not only be able to make a first class article of butter, but who shall also be competent to plan and superintend the construction of the creamery. This is a point which most co-operative creameries overlook. The result is there are dozens of creameries scattered all over the country which are faulty in both design and construction.

Before drawing up his plans it would be policy for the butter maker to visit several up-to-date creameries so as to get the latest ideas on creamery construction.

7. The creamery is paid for out of a sinking fund created by charging the patrons, in addition to the charge necessary to cover running expenses, say one cent for every pound of butter fat delivered until the creamery is paid for.

8. After the creamery is paid for, there should be an annual dividend declared to the shareholders as interest on their investment.

9. A sufficient sinking fund must be maintained to cover the annual dividend and the running expenses, by charging from two to three cents for every pound of butter fat delivered.

**Management of Co-operative Creameries.** Too frequently the management of co-operative creameries is placed in the hands of persons who know little or nothing about creamery matters. Perhaps more co-operative creamery failures can be traced to this cause than to any other.

The stockholders of co-operative creameries should select a manager and managing board who are familiar with the details of the business they are going to manage. Advice should freely be sought from the butter maker who in most cases is the best posted man to govern the affairs of the creamery.

**2. Co-operation of Butter maker and Patron.** The relationship of butter maker and patron should be one of mutual interest—a business relationship. Butter making is a business and, as such, should be governed by business principles.

The butter maker, then, besides being able to make a fine quality of butter, must be a business man, dealing as he does with farmers, bankers, merchants, mechanics, and others. He must be honest, tactful, and full of enterprise.

Too frequently self-interest figures too conspicuously in the management of creamery affairs. This can not help but result, sooner or later, in the ruination of the business.

The butter maker has, and must have, certain rights which, if rightly asserted, can not help but be productive

of much good. If used otherwise, these rights will create enmity and become a damage to the creamery. For example, a butter maker has a right to demand of his patrons good clean milk, but he can not attain his object by repeatedly sending back milk that is not right. Tactfully explaining the evils resulting from unclean milk, giving the probable cause, and manifesting a willingness to visit his premises, will accomplish very much more in reforming the patron.

Greeting the patrons with a smile and a "good morning" inspires confidence. Accuracy in sampling, weighing and testing, a clean person and clean surroundings, are things that merit more than ordinary attention.

The best way for butter makers to get along with their patrons is to help them in every way they can. They should act as educators of their patrons in their respective communities. No person has a greater opportunity for doing good in his community than the butter maker.

A few printed instructions to patrons occasionally can not fail to be productive of much good, both to the patron and to the butter maker. The following may be considered as sample instructions:

1. Get cows that are purely dairy animals. Cows that have a tendency to lay on flesh while giving milk are not the most profitable for the dairy. A milch cow should convert her food into milk, not into flesh. Such a cow you will generally find a spare, lean looking animal.

2. Do not be afraid to invest \$100 in a good sire of some good dairy breed to head your herd. See to it that this sire is a descendant of prolific milkers, and that he has good breeding qualities.

3. Feed liberally. Remember that about sixty per cent of what a cow can eat and properly assimilate is

required for her maintenance; that which is fed beyond this is utilized for the production of milk if the cow is a purely milk-producing animal. Hence the wisdom of feeding a cow to her full capacity.

4. Do not feed just one kind of feed. Variety of feeds is essential in economical feeding.

5. Feed liberally of concentrated feeds like bran and oil meal, especially during scarcity of pasturage.

6. Do not be afraid to invest \$16 in a ton of bran, for its value to you as a fertilizer alone is \$11.

7. Always milk your cows at the same time morning and evening. Regularity in milking means more milk.

8. Do not change milkers, and insist that the milkers treat the cows gently.

9. Always thoroughly cool night's milk by placing it in cold water and stirring it frequently.

10. Do not allow the calves to suckle the cows more than three days after calving.

11. Always add a few tablespoonfuls of oil meal or cooked flax seed to the skim-milk before feeding it to your calves.

12. Grow a liberal supply of clover and peas, for these produce a liberal flow of milk, at the same time enriching the soil.

13. Grow an abundance of corn and ensilo it. It may prove your most economical feed.

14. Never place your milk cans in the barn while milking for the barn odors will taint the milk.

15. Do not bed or feed your cows, or in any way disturb the barn dust, while milking.

16. Always provide your cows with a liberal supply of salt and pure water. Never allow them to drink stagnant water.

17. Bring samples of milk from the individual cows of your herd for testing. It will cost you nothing, but it may be of great value to you.

18. A sample consisting of a portion (1 oz.) of the night's and morning's milk is necessary for a test. Always thoroughly mix milk before sampling.

## CHAPTER XXVI.

### HANDLING OF MILK AND CREAM AT THE FARM.

This is a subject which vitally affects the success of every creamery, and one in which patrons have hitherto had too little instruction. A great deal of the poor milk and cream produced at the present time is the result of ignorance. Buttermakers and creamery managers should see to it that their patrons are thoroughly instructed in all that pertains to the correct management of milk and cream at the farm.

### THE DAIRY HOUSE.

All creamery patrons must have a small dairy house in order to properly care for their milk, cream and milk vessels. The added convenience which such a house affords ought to be some inducement toward getting one. A dairy house is especially important for cream patrons.

**Location and Construction.** In selecting a site for a dairy house, convenience and sanitation should be given first consideration. A well-drained spot, free from rubbish and bad odors and within reasonable distance from the barn and well, should be selected.

In the construction of a dairy house sanitary features should be made paramount. The floor should be built of concrete, and it is desirable to have the lower four or six feet of the wall finished with cement. Indeed it is a distinct advantage to have the entire walls covered with hard finish of some kind to make them readily cleanable.

The ceiling should be about 10 feet high and made of well matched ceiling lumber. A ventilating shaft should extend from the middle of the ceiling to the top of the roof to carry off vapors and impure air.

Essentially the same plan of construction may be followed as that outlined for the construction of the creamery.

**Equipment.** For those furnishing milk, the equipment should consist of a cooler, cooling tank, water heater, and wash sinks. When cream is sold, a cream separator, some form of power, and preferably an ice box, are added to the equipment needed for milk.

#### COOLING MILK AND CREAM.

**Importance of Low Temperature.** Milk always contains bacteria no matter how cleanly the conditions under which it is drawn. At ordinary temperatures these bacteria increase with marvelous rapidity; at low temperatures their growth practically ceases. The effect of temperature on bacterial development is graphically shown in Fig. 54. At a temperature of 50° F. the bacteria multiplied five times; at 70° F. they multiplied seven hundred and fifty times.

Roughly speaking, at 98° F. bacteria multiply one hundred times faster than 70° F. At 32° F. bacterial development practically ceases.

Milk or cream may be kept sweet a long time at 40° to 45° F. because the lactic acid bacteria practically stop growing at these temperatures. But there are other classes of bacteria that can grow at these temperatures, as evidenced by the production of undesirable flavors.

Such flavors usually become noticeable after thirty-six hours. That bad flavors occur at these low temperatures should be sufficient reason for making frequent deliveries of cream.

**Prompt Cooling.** Immediately after the milk is drawn, it should be removed from the barn to a clean, pure

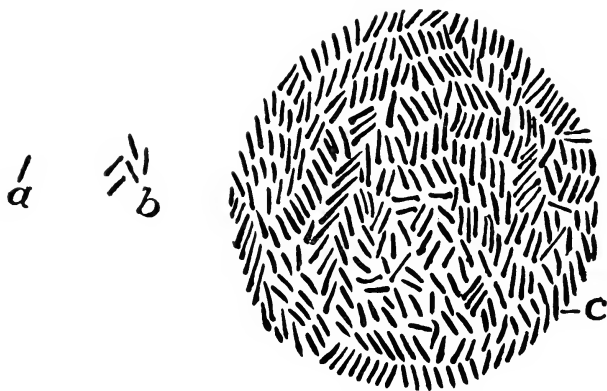

Fig. 54.—Relation of temperature to bacterial growth.

*a* represents a single bacterium; *b*, its progeny in twenty-four hours in milk kept at 50° F.; *c*, its progeny in twenty-four hours in milk kept at 70° F. (Bul. 26, Storrs, Conn.)

atmosphere where it is aerated and cooled by using coolers like those shown in Figs. 55 and 56. The ordinary method of cooling milk and cream in five and ten gallon cans is too slow for best results.

**Cone-Shaped Cooler.** For small and medium sized dairies a cheap cooler like that shown in Fig. 55 may be used to advantage. The water enters at the bottom of the cooler and discharges at the top, while the milk flows in a thin sheet over the outside. Ice may be placed inside the cooler, if desired. The can at the top is the milk re-



ceiver, which has small openings at the bottom near the outside, through which the milk discharges in fine streams directly upon the cone below.

**Corrugated Cooler.** For large dairies a cooler like that shown in Fig. 56 answers very satisfactorily. An elevated barrel is connected with the cooler and filled with



Fig. 55.—Cone-shaped cooler.

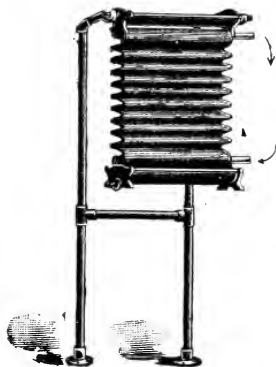

Fig. 56.—Corrugated cooler.

cold water which circulates between the two surfaces of the cooler, the milk and cream flowing over the outside. An ice water attachment may be added to the cooler if desired, or ice may be added to the water in the barrel.

Both the cone-shaped and corrugated coolers permit cooling to within a few degrees of the temperature of the water used, and also give milk and cream sufficient aeration. (See page 240.)

#### HOW TO SECURE HOT WATER.

Where no steam is available, the best means of procuring hot water is the apparatus shown in Fig. 57.

The hot water tank is that commonly used in residences for heating water for the bath tub and can be obtained from plumbers for about \$7.00. Any stove in which iron coils can be heated will answer as a heater.

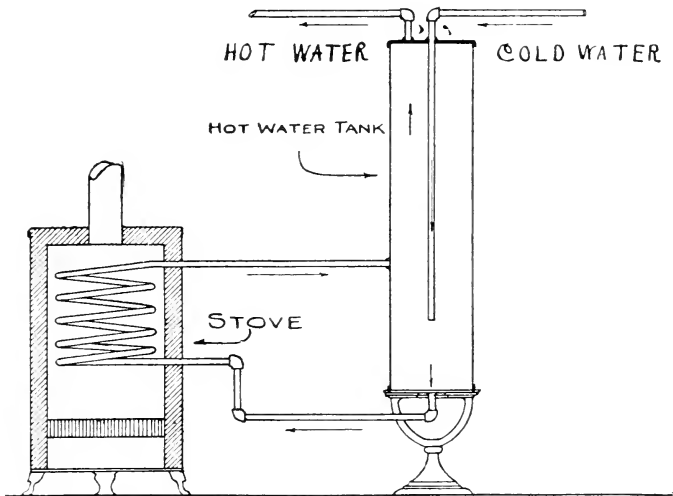

Fig. 57.—Cheap arrangement for securing hot water.

After the milk vessels have been thoroughly washed, they should be placed in boiling water for about five minutes and then inverted upon clean shelves. For details of washing see chapter on Washing and Sterilizing.

#### POWER ON THE FARM.

The use of some form of power upon dairy farms has frequently been recommended in the past, but never before has its use been more urgent than at the present time. The increasing scarcity of labor, the rapid increase of

hand separators, and the general convenience it affords, have made power an actual necessity upon progressive dairy farms.

The kind of power needed upon a dairy farm depends upon certain conditions. If a tread power is used for exercising the bull, this will serve satisfactorily for separating milk, pumping water, and doing other light work. In recent years gasoline engines have become very popular. A two horse power engine will serve very satisfactorily for running the cream separator, pumping water and doing other light work such as running the wash machine, grindstone, etc.

Power not only affords great convenience upon a farm but will also curtail the running expenses.

If, for example, we assume that one hour is required daily in running the separator, and another in pumping water for stock, the total time consumed in this work in one year would be 730 hours, or 73 days of 10 hours each. At \$1 a day, the cost of separating and pumping would amount to \$73 a year. With a gasoline engine running the pump and separator at the same time, this work could be done in 365 hours. Allowing 6c per hour for gasoline and oil, which is a high estimate, the cost of doing the above work with an engine would be \$21.90, or less than one-third of what it can be done for with hired labor. This saving is equivalent to about 25 per cent. on the investment of the engine, if used for no other purpose than separating milk and pumping water.

The fuel cost of running a gasoline engine may be stated as follows: When gasoline is worth 10c per gallon, gasoline power will cost 1c per brake horse power per hour.

## FASTENING THE SEPARATOR.

To secure steady motion, the separator must be fastened to a solid foundation. There is nothing better in this respect than a concrete floor with which every dairy should be provided.

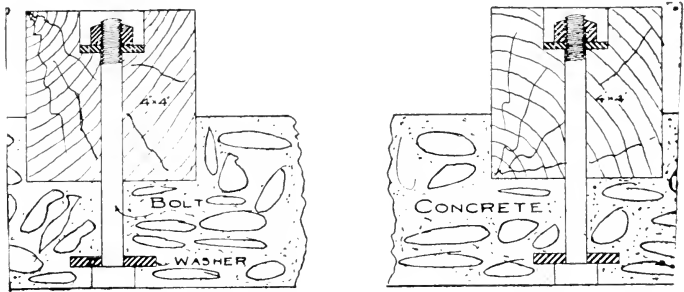

Fig. 58.—Method of fastening separator.

There are two common methods of fastening a separator to a concrete floor: One is to fasten two 4x4-inch blocks into the concrete floor as illustrated in Fig. 58. The separator is then fastened to these blocks in the same manner as to a wood floor. The other method of fastening consists in chiseling four conical holes into the concrete floor, at a distance corresponding with the four holes in the separator base. The cavities thus made are filled with Babbitt metal, into which holes a little smaller than the lag screws are drilled. The separator is then fastened by turning the lag screws into the Babbitt. (See Fig. 59.)

The Babbitt may be dispensed with by fastening the bolts with cement as shown in Fig. 59.

## MANAGEMENT OF SEPARATOR.

This subject is fully discussed in the chapter on Creaming. What is said there of power machines applies equally to hand separators.

Farmers should be cautioned against using any but the best grade of hand separator oil. They should also be taught the importance of cleaning the separator after each use.

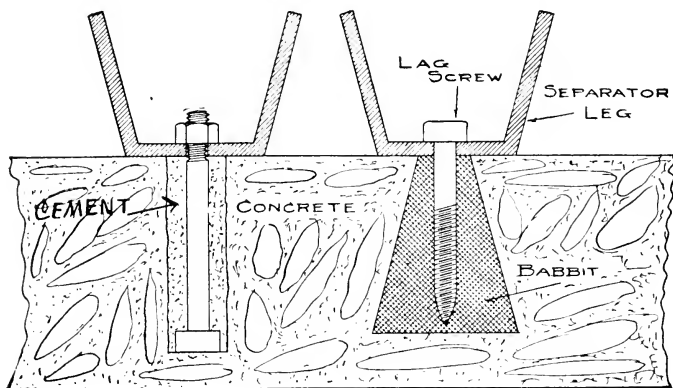

Fig. 59.—Methods of fastening separator.

## ADVANTAGES OF RICH CREAM.

To separate a rich cream at the farm results in mutual benefit to producer and manufacturer. The main advantages are as follows: (1) Less bulk to handle; (2) less cream to cool; (3) less transportation charges; (4) more skimmilk for the farmer; (5) better keeping quality; (6) allows more starter to be added; (7) gives better results in churning, and (8) makes pasteurization easier, especially with sour cream.

Too rich a cream must be avoided, however, since this sticks too much to the cream vessels; 40% is about the right richness.

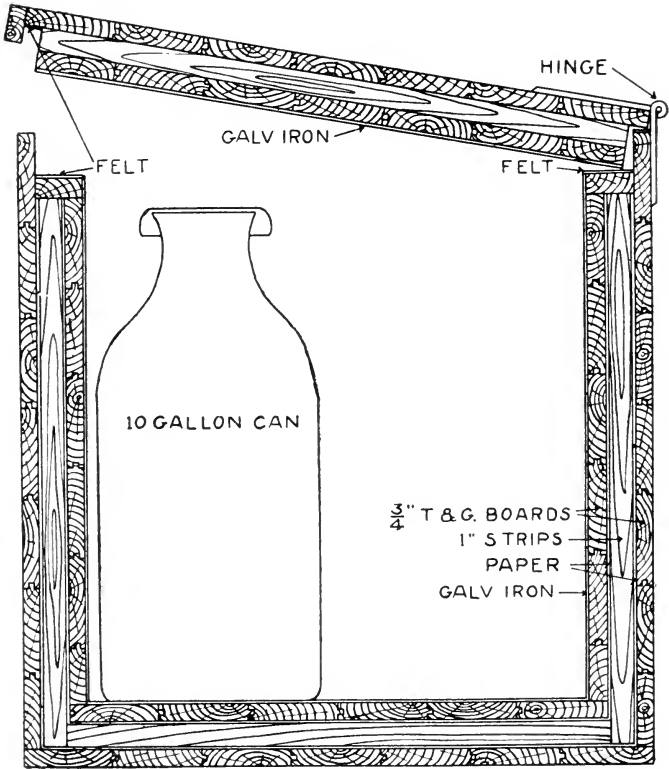

Fig. 60. — A cross section of ice box.

## THE VALUE OF AN ICE HOUSE.

Where cream can not be delivered daily, ice is indispensable in keeping it in satisfactory condition. In addition to cooling milk and cream, ice can be employed to good advantage in several other ways. Its value in the household in preserving meats, vegetables and fruits can not be overestimated. And what is so refreshing as cold drinks and frozen desserts during the summer months! Ice is also frequently necessary in case of sickness. Careful study will show that these advantages will far more than offset the small cost of laying in a store of ice. For further particulars regarding ice and the construction of ice houses, see chapter on Ice House and Refrigerator.

## A CHEAP ICE BOX.

A simple, cheap, and effective ice box for keeping milk and cream cold is shown in Fig. 60. This box was designed by the author and has been in successful use for nearly two years. It consists essentially of two boxes separated by one-inch strips, placed at intervals of about one foot. Double thickness of building paper is placed on both sides of the strips and tacked to the boxes. The inside is lined with galvanized iron.

Three-quarter inch tongued and grooved lumber is used in the construction of the sides, bottom and cover, while the ends are built of one and one-eighth inch tongued and grooved flooring, three and one-half inches wide. A heavy weight attached to a one-half inch rope running over a pulley fastened to the ceiling, raises the cover and holds it open when desired.

A short piece of gas pipe is inserted through the bottom

of the box to provide drainage, the outlet of this pipe being connected with a trap to prevent entrance of air into the box.

The total cost of the ice box used by the author was \$27.40, including labor. The inside dimensions of this box are: Length, 7 1-3 feet; width, 2 1-4 feet; depth, 2 1-3 feet. A box half the size of this would answer for the average sized dairy.

#### CLEAN MILK.

This is the basis of high quality in all dairy products. The method of securing clean, sanitary milk is fully discussed in the following chapter.

#### COOLING WITHOUT SPECIAL COOLERS.

When no special coolers are at hand milk and cream should be cooled in small cans by placing them in a tank or an oil barrel cut in two. Cold water is pumped into the tank or barrel in such a way that the cold water drops into the bottom of the tank, thus forcing out the warm surface water.

Water should be pumped into the tank at frequent intervals until the milk or cream has nearly reached the temperature of the water. The time of cooling is materially shortened by frequent stirring, which is a very essential part in cooling milk and cream in cans.

Where milk is placed in large cans and stirred little, farmers lose in having the test lowered by hard particles of cream forming at the top. Where milk is properly cooled, hard flakes of cream or churned cream will not be found on top of the milk.



## CHAPTER XXVII.

### SANITARY MILK PRODUCTION.

**Sanitary Milk Defined.** Sanitary milk is milk from healthy cows, produced and handled under conditions in which contamination from filth, bad odors, and bacteria, is reduced to a minimum.

**Importance of Sanitary Milk.** The production of clean, pure milk is one of the most important subjects which confronts buttermakers at the present time. Further improvements in the quality of butter must largely be sought in the use of cleaner milk.

No matter how skillful a buttermaker may be, he can not produce the highest quality of butter from milk of inferior quality. Skill may do much to improve quality but it can never make perfection out of imperfection. It should, therefore, be as much a duty of the butter maker to keep his patrons properly instructed in the care and handling of milk as it is to keep himself posted on the latest and most approved methods of making butter.

**The Necessary Conditions** for the production of sanitary milk are as follows: (1) Healthy cows; (2) sanitary barn; (3) clean barn yard; (4) clean cows; (5) clean milkers; (6) clean milk vessels; (7) clean, wholesome feed; (8) pure water; (9) clean strainers; (10) dust-free stable air; (11) clean bedding; (12) milking with dry hands; (13) thorough cooling of milk after milking; (14) sanitary milk room.

**Healthy Cows.** The health of the cow is of prime importance in the production of sanitary milk. All milk

from cows affected with contagious diseases should be rigidly excluded from the dairy. Aside from the general unfitness of such milk there is danger of the disease producing organisms getting into the milk. It has been found, for example, that cows whose udders are affected with tuberculosis, yield milk containing these organisms. The prevalence of this disease among cows at present makes it imperative to determine definitely whether or not cows are affected with the disease, by the application of the tuberculin test.

Any feverish condition of the cow tends to impart a feverish odor to the milk, which should therefore not be used. Especially important is it that milk from diseased udders, no matter what the character of the disease, be discarded.

**Sanitary Barn.** Light, ventilation, and ease of cleaning are essential to a sanitary dairy barn. The disinfectant action of an abundance of sunlight, secured by providing a large number of windows, is of the highest importance.

Of equal importance is a clean, pure atmosphere, secured by a continuous ventilating system. The fact that odors of any description are absorbed by milk with great avidity, sufficiently emphasises the great need of pure air.

To permit of easy cleaning, the barn floors and gutters should be built of concrete. They should be scrubbed daily, and care should be taken to keep the walls and ceiling free from dust and cobwebs. The feed boxes must also be cleaned after each feed.

The stalls should be of the simplest construction, to afford as little chance for lodgement of dust as possible. Furthermore, they should so fit the cows as to cause the latter to stand with their hind feet on the edge of the gut-

ter, a matter of the highest importance in keeping cows clean.

The walls and ceiling should be as smooth as possible. Moreover, they should be frequently disinfected by means of a coat of whitewash. The latter gives the barn a striking sanitary appearance.

**Clean Barn Yard.** A clean, well drained barn yard is an essential factor in the production of sanitary milk. Where cows are obliged to wade in mire and filth, it is easy to foretell what the quality of the milk will be. To secure a good barn yard it must be covered with gravel or cinders, and should slope away from the barn. If the manure is not taken directly from the stable to the fields, it should be placed where the cows cannot have access to it.

**Clean Cows.** Where the barn and barn-yard are sanitary, cows may be expected to be reasonably clean. Yet cows that are apparently clean, may still be the means of infecting milk to no small degree. When we consider that every dust particle and every hair that drops into the milk may add hundreds, thousands, or even millions of bacteria to it, we realize the importance of taking every precaution to guard against contamination from this source.

To keep cows as free as possible from loose hair and dust particles they should be carded and brushed regularly once a day. This should be done after milking to avoid dust. Five to ten minutes before the cow is milked her udder and flanks should be gently washed with clean, tepid water, by using a clean sponge or cloth. This will allow sufficient time for any adhering drops of water to drip off, at the same time it will keep the udder and flanks sufficiently moist to prevent dislodgment of dust particles

and hairs at milking time. This practically means that the milker must always have one or two cows washed ahead. He should be careful to wash his hands in clean water after each washing.

Under ordinary conditions the cow is the greatest source of milk contamination. The rubbing of the milker against her and the shaking of the udder will dislodge numerous dust particles and hairs unless the foregoing instructions are rigidly followed.

Attention should also be given to the cow's switch, which should be kept scrupulously clean. The usual switching during milking is no small matter in the contamination of milk when the switch is not clean.

**Clean Milkers.** Clothes which have been worn in the fields are not suitable for milking purposes. Every milker should be provided with a clean, white milking suit, consisting of cap, jacket and trousers. Such clothes can be bought ready made for one dollar; and, if frequently laundered, will materially aid in securing clean milk.

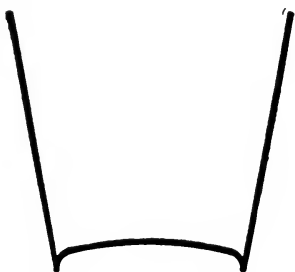

Fig. 61. Unflushed seam.

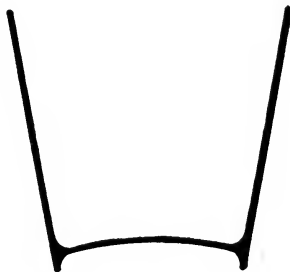

Fig. 62. Flushed seam.

Milkers should also wash and dry their hands before milking, and, above all, should keep them dry during milking.

**Clean Vessels.** All utensils used in the handling of

milk should be made of good tin, with as few seams as possible. Wherever seams occur, they should be flushed with solder. Unflushed seams are difficult to clean, and, as a rule, afford good breeding places for bacteria. Fig. 61 illustrates the character of the unflushed seam; Fig. 62 shows a flushed seam, which fully illustrates its value.

Fig. 63 illustrates a modern sanitary milk pail. The value of a partially closed pail is evident from the reduced opening, which serves to keep out many of the micro-organisms that otherwise drop into the pail during



Fig. 63. Sanitary Milk Pail.

milking.' While such a pail is somewhat more difficult to clean than the ordinary open pail, it is believed that the reduced contamination during milking far outweighs this disadvantage.

All utensils used in the handling of milk should be as nearly sterile as possible. A very desirable method of cleaning them is as follows:

First, rinse with warm or cold water. Second, scrub

with moderately hot water containing some sal soda. The washing should be done with brushes rather than cloth because the bristles enter into any crevices present which the cloth cannot possibly reach. Furthermore, it is very difficult to keep the cloth clean. Third, scald thoroughly with steam or hot water, after rinsing out the water in which the sal soda was used. After scalding, the utensils should be inverted on the shelves without wiping and allowed to remain in this place until ready to use. This will leave the vessels in a practically sterile condition. Fourth, if it is possible to turn the inside of the vessels to the sun, in a place where there is no dust, then it is desirable to expose the utensils during the day to the strong germicidal action of the direct sun's rays.

**Clean, Wholesome Feed.** Highly fermented and aromated feeds, like sour brewers grains and leeks should be rigidly withheld from dairy cows when anything like good flavored milk is sought. So readily does milk absorb the odors of feeds through the system of the animal, that even good corn silage, when fed just previous to milking, will leave its odor in the milk. When fed after milking, however, no objection whatever can be raised against corn silage because not a trace of its odors is then found in the milk. Aromatic feeds of any kind should always be fed after milking.

**Pure Water.** Since feeds are known to transmit their odors to the milk through the cow, it is reasonable to expect water to do the same. Cows should, therefore, never be permitted to drink anything but pure, clean-flavored water. The need of pure water is further evident from the fact that it enters so largely into the composition of milk.

The water of ponds and stagnant streams is especially dangerous. Not only is such water injurious to the health of cows, but in wading into it, they become contaminated with numerous undesirable bacteria, some of which may later find their way into the milk.

**Strainers and Straining.** Milk should be drawn so clean as to make it almost unnecessary to strain it. This operation is frequently done under the delusion that so long as it removes all visible dirt the milk has been entirely purified. The real harm, however, that comes from hairs and dust particles dropping into the milk is not so much in the hairs and dust particles themselves as in the millions of bacteria which they carry with them. These bacteria are so small that no method of straining will remove them. Straining can not even remove all of the dirt, because some of it will go in solution.

A good strainer consists of two thicknesses of cheese cloth with a layer of absorbent cotton between. The strainer is to be placed on the can or vat into which the milk is to be strained and not on the milk pail. While a strainer like the above placed upon the milk pail, reduces the bacterial content slightly in the hands of careful milkers, it is believed that the slight advantage gained would be more than off-set by greater carelessness in milking; especially might this be true with ignorant milkers who are apt to think that the strainer will make up for any carelessness on their part. A cheese cloth strainer on the milk pail is worse than useless with any kind of milker.

New sterilized cotton must be used at each milking and the cloths must be thoroughly washed and sterilized. Like the cotton, it is best to use the cloth but once.

**Dust-Free Air.** Great precaution should be taken not

to create any dust in the stable about milking time, for this is certain to find its way into the milk. Cows should, therefore, never be bedded or receive any dusty feed just before or during milking.

Dry roughage, such as hay and corn fodder, always contains a considerable amount of dust, and when fed before or during milking may so charge the air with dust as to make clean milk an impossibility.

Moistening the floor and walls with clean water previous to milking materially minimizes the danger of getting dust into the milk. A mistake not infrequently made even in the better class of dairies is to card and brush the cows just before milking. While this results in cleaner cows, the advantage thus gained is far more than offset by the dirtier air, which, as will be shown later, materially increases the germ content of the milk. The carding and brushing should be done at least thirty minutes before the milking commences.

**Clean Bedding.** Clean shavings and clean cut straw should preferably be used for bedding. Cows stepping and lying on dirty bedding will soil themselves and create a dusty barn air.

**Milking With Dry Hands.** A prolific source of milk contamination is the milking with wet hands. Where the milker wets his hands with milk, some of it is bound to drip into the pail, carrying with it thousands or millions of bacteria, depending upon the degree of cleanliness of the milker's hands and the cow's udder. There is no excuse for the filthy practice of wet milking, since it is just as easy to milk with dry hands.

**Fore-Milk.** Where the purest milk is sought, it is desirable to reject the first stream or two from each teat, as this contains many thousands of bacteria. The reason



for this rich development of germs is found in the favorable conditions provided by the milk in the milk-ducts of the teats, to which the bacteria find ready access.

**Flies.** Flies not only constitute a prolific but also a dangerous source of milk contamination. These pests visit places of the worst description and their presence in a dairy suggests a disregard for cleanliness. Of 414 flies examined by the Bacteriologist of the Connecticut Station, the average number of bacteria carried per fly was *one and a quarter millions*. Flies should be rigidly excluded from all places where they are apt to come in contact with the milk.

**Experimental Data.** To show to what extent the bacterial content of milk may be reduced by adopting the precautions suggested in the foregoing pages, a few experimental data are herewith presented.

In Bulletin No. 42 of the Storrs (Conn.) Experiment Station, Stocking reports the following:

1. When the cows were milked before feeding the number of bacteria per c. c. was 1,233; when milked immediately after feeding, the number of bacteria was 3,656, or *three* times as many.

2. When the udder and flanks of the cows were wiped with a damp cloth, the number of bacteria per c. c. was 716; when not wiped the number was 7,058, or *ten* times as great.

3. When the cows were not brushed just before milking the number of bacteria per c. c. was 1,207; when brushed just before milking, the number was 2,286, or nearly *twice* as great.

4. When students who had studied the production of clean milk did the milking, the number of bacteria per c. c. was 914; when the milking was done by regular

unskilled milkers the number of bacteria was 2,846, or *three* times as great.

Wiping or washing udders before milking not only very materially reduces the bacterial content of the milk, but also lessens the amount of dirt to a very great extent. Frazer has shown that "the average weight of dirt which falls from muddy udders during milking is *ninety* times as great as that which falls from the same udder after washing, and when the udder is slightly soiled it is eighteen times as great."

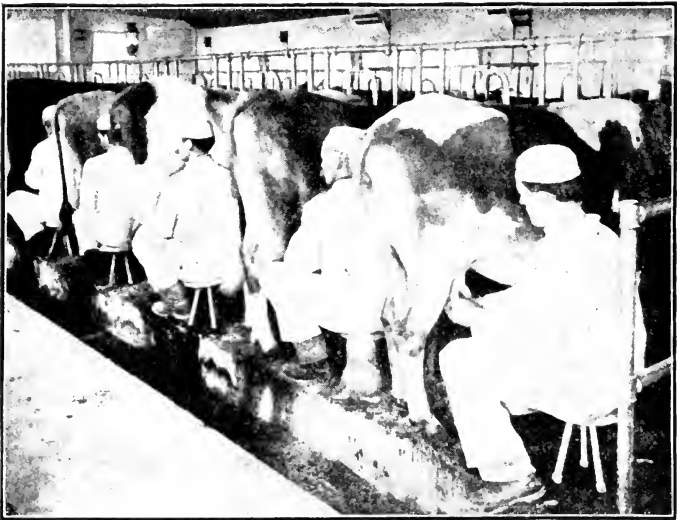

Fig. 64.— Clean Milking. (From Da. Div., U. S. Dept. of A.)

## CHAPTER XXVIII.

### TRANSPORTATION OF CREAM.

The two essentials in successful cream transportation are cleanliness and low temperature. It is possible to

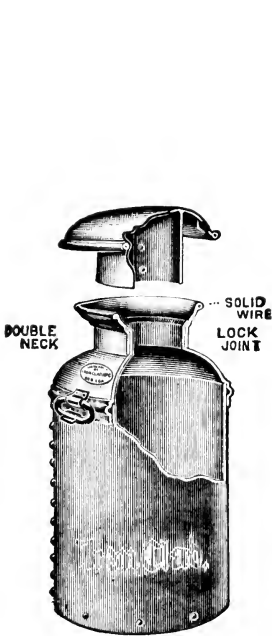

Fig. 65.—Milk can

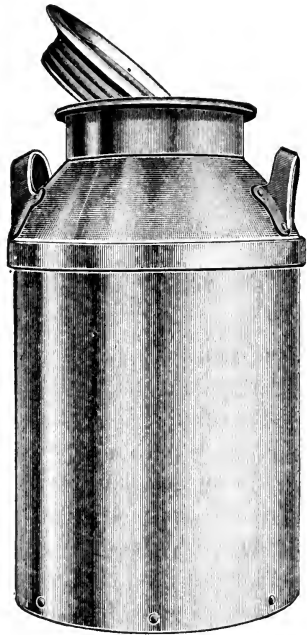

Fig. 66.—Screw top can.

keep cream in good condition for two days, if produced and handled under cleanly conditions and cooled directly after milking to  $50^{\circ}$  F. or below. This low temperature

must be maintained when long keeping quality is desired.

**Cans.** Various insulated cans are now upon the market and a number of these have been tested by the author. The tests showed that these cans possess about the same insulating effect as the felt jackets that are commonly wrapped around ordinary milk cans. The latter, as a rule, are preferred on account of their greater ease of handling. The insulated cans, however, have an advantage in the extra cover inside, which can be pushed to the top of the cream, thus preventing it from churning when the cans are only partially filled.

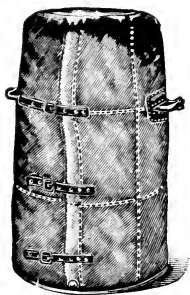

Fig. 67.—Felt jacket.

**Hauling Cream.** In gathering cream the most satisfactory results are secured by providing a separate can for each patron. The driver starts out with a load of clean, empty cans which replace those picked up along the route. This method gives the buttermaker an opportunity to examine each patron's cream, leaves in his hands the important matter of sampling and weighing and also insures clean cans for the patrons.

Where there are too many small producers the above plan has the objection of requiring too many cans for the amount of cream collected. With producers of this kind the common method is to weigh and sample the cream at the farm and empty the same in large collecting cans. Where the patrons' cream is hauled to the creamery in separate cans, the latter must bear, upon brass plates, either the patrons' names or numbers corresponding to the names.

**Skimming Station Cream.** In many localities where there is not sufficient milk to warrant the establishment of a creamery, skimming stations have been built which separate the cream from the milk and deliver it to a creamery for churning. Hundreds of such stations are scattered throughout the country and they are serving a most useful purpose. The cream from such stations should be delivered to the creamery daily.

**Shipping Cream.** In shipping cream, have the name and address of the patron permanently marked in brass upon both can and cover; also have it sewed or stitched on the felt jackets. This is necessary to insure the return of your own goods. The name

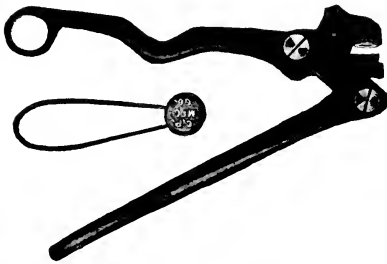

Fig. 68.—Lead seal and seal press.

and address will be put upon the cans and covers by the dealer from whom they are purchased, if so requested; or, in case unmarked cans are already on the premises, the brass plates with the name and address may be purchased from dairy supply firms and placed upon the cans and covers by a local tinner.

The empty cans should be washed before they are returned. This should be done for sanitary reasons as well as for the protection of the cans, which are short-lived unless washed and dried immediately after use.

Another matter of importance in shipping is to have the cans full to prevent churning.

It is necessary also to have the cans sealed to prevent

tampering with the contents. The sealing is easily accomplished by means of lead seals and a seal press (Fig. 68).

**Care of Cream During Transportation.** During the summer months a great deal of cream is damaged while in transit to the creamery. If the cream is collected in wagons, the latter should be covered and provided with springs. The cans should be wrapped in felt jackets. When no jackets are used, the cans must be covered with heavy blankets. Too many precautions can not be taken to protect the cream from either very high or very low outside temperatures.

The felt jackets are also desirable in shipping cream. Especially important is this where the cream is left exposed to the hot rays of the sun at the station platform, a matter of no unusual occurrence.

**Mode of Shipping.** The usual way of shipping milk and cream is by express. In the main dairy sections baggage rates are available. These rates are lower than express rates and can be obtained nearly everywhere by special arrangement with the railroad companies.

Shipping rates should always be obtained in advance of shipment and the charges should be prepaid. A considerable saving is certain to be effected by rigidly adhering to this practice. Insist upon getting the lowest rates possible.

**Frequency of Delivering Cream.** To save cost in transportation, a practice that has been altogether too common is to deliver cream only once, twice, or three times a week, when in no case it should be delivered fewer than four times a week. Indeed, it is well known that the best butter is possible only when the cream is delivered daily.

It is, of course, entirely possible to so cool cream as to keep it sweet for two days, but cream that has been kept cold this length of time invariably develops a more or less off-flavor. This is due to the development of certain classes of bacteria which are capable of growing at temperatures at which the growth of the lactic acid organisms is entirely checked.

The greatest defect in the gathered cream system of buttermaking today is the too infrequent delivery of the cream.

## CHAPTER XXIX.

### WATER SUPPLY FOR FARM AND CREAMERY.

#### WATER SUPPLY FOR FARM.

**Importance of Pure Water.** A great deal of disease in farm homes is directly traceable to infected water. Typhoid fever especially is so frequently caused by polluted well water that physicians at once look to this as the probable cause wherever this disease is found to exist.

Where wells infected with disease germs happen to exist on dairy farms, disease is not limited to the dairyman's own family, but may spread through the products of the creamery. Many typhoid fever epidemics have been positively traced to milk which has become infected through water containing the disease germs. Nowhere is pure water so important, therefore, as upon dairy farms.

The disease germs usually find their way into the milk through milk vessels which have been washed with infected water. The use of such water for washing cows' udders previous to milking may also be the means of infecting the milk supply.

**Construction of Well.** In a properly constructed well, no water should enter it except near the bottom. This compels the water to pass through a thickness of earth sufficient to purify it where the wells are of a reasonable depth.

Where there is no rock or hard clay and where the water can be had at a reasonable depth, the driven well,



commonly known as the Abyssinian tube well, is the cheapest and one of the safest. This well is made by driving into the ground a water-tight iron tube, the lower end of which is pointed and perforated.

In case rocks and hard clay must be penetrated, or great depth must be reached to secure water, the bored or drilled well, piped from top to bottom with water-tight iron pipes, will be found most satisfactory.

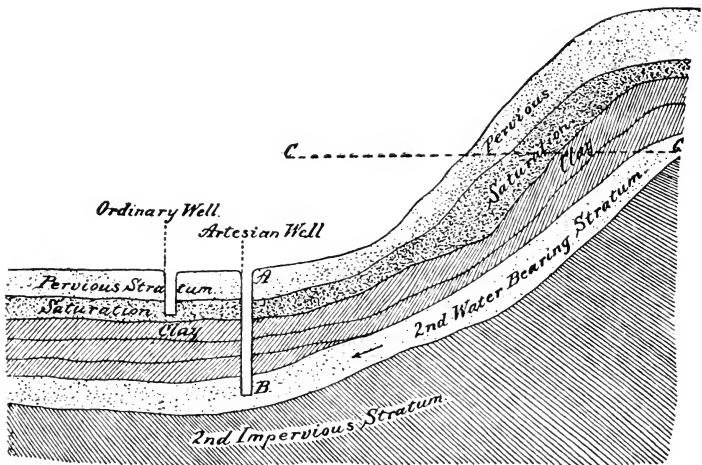

Fig. 68.—Soil strata. (From Harrington's "Practical Hygiene.")

Water from the upper pervious stratum should be avoided wherever possible, even with wells of the kind just described. Especially is this necessary where the wells are shallow. The purest water is obtained by sinking the well through an impervious stratum, like that shown in Fig. 68.

The most dangerous well is the common dug well with pervious walls and so located as to permit seepage into

it from outhouses, barnyards and cesspools. Wells of this type are altogether too common on dairy farms.

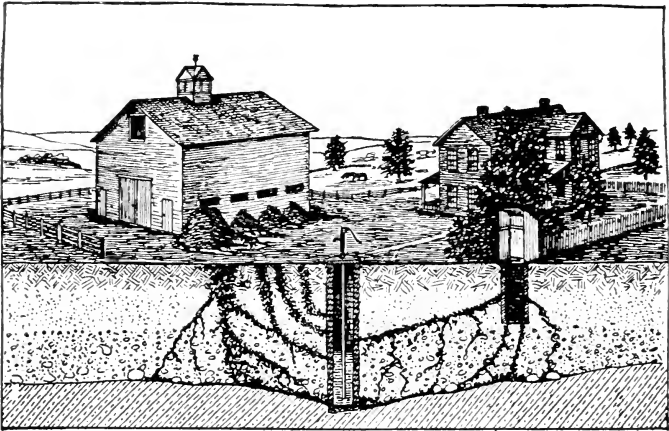

Fig. 69.—Source of well water contamination. (From Bul. 143  
Kan. Ex. Sta.)

All wells, whatever their construction, must be provided with water-tight metallic or concrete covers to prevent the entrance of impurities into the shaft.

#### WATER SUPPLY FOR CREAMERY.

The matter of using clean, pure water for washing butter has hitherto not received the attention which this subject demands. There is no question that much butter is robbed of its rich, creamery flavor by too much washing with impure water. Impure water materially affects the keeping quality of butter and may seriously affect its wholesomeness if infected with disease-producing organisms. In constructing a creamery well, therefore,

the same care should be taken as that outlined above for the construction of a farm well.

**Purifying Water by Filtration.** Most people are familiar with the purifying action which water undergoes in its passage through sand, gravel, charcoal, etc. For purifying water used for washing butter, artificial filter beds constructed of such material have given excellent satisfaction.

The filter can described in bulletin No. 71 from the Iowa Experiment Station is 48 inches high, 18 inches in diameter, and constructed of 22 gage galvanized iron. Beginning at the bottom the filtering material was placed in the can in the following order: (1) 2 inches of small flint stones; (2) 22 inches of fine sand; (3) 12 inches of fine coke; (4) 9 inches of charcoal; (5) 2 inches of fine stone or coarse gravel. Two perforated plates are placed in the can, one near the bottom upon which the filtering material rests, the other on top of the fine sand. A third and concave plate is placed near the top with a hole in the center, which directs the water to the center of the filter bed.

This can has a filtering capacity of 16 gallons per hour, and it is claimed that the filter does not need to be cleaned or renewed oftener than once in four months and possibly not this often. The cost of the can is \$11.11.

Filtration offers one of the cheapest methods of purifying water and is the method generally employed by cities that are dependent upon lakes for their water supply.

**Purification of Water by Heating.** Water may be pasteurized in the same manner as cream. There is, however, one objection to this method of purifying water, and that is the bad effect which it has on the pasteurizer.

In the course of time a distinct layer of the mineral impurities of the water will be deposited upon the walls of the pasteurizer in a manner similar to the formation of scale in the boiler. This mineral deposit will in time destroy the usefulness of the pasteurizer.

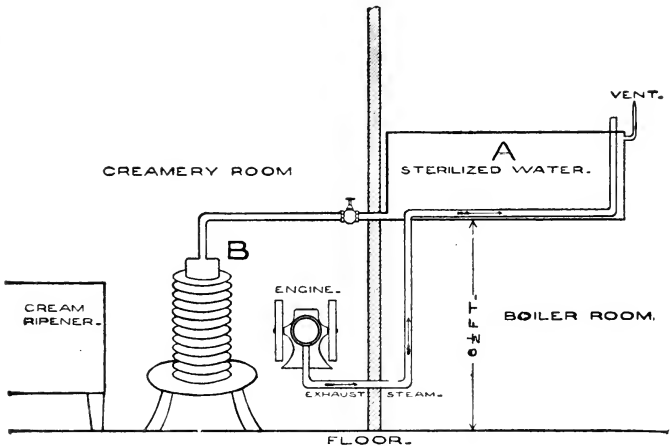

Fig. 70.—Showing method of sterilizing wash water for butter.

A satisfactory method of purifying water by heating is illustrated in Fig. 70. The water is pumped from the well into the galvanized iron tank, A, which is placed about 6 feet above the floor in the boiler room. This tank is tightly covered with the exception of a small vent in the cover.

The water is heated by placing a series of galvanized iron pipes in the bottom of the tank through which all, or a part, of the exhaust steam from the engine is conducted. In this way the expense of heating water will

amount to nothing more than a slight back pressure on the engine.

The hot water may be drawn off from this tank whenever desirable and cooled in the same manner as the cream, that is, by running it over the cream cooler B. From the cooler the water should be run into a tank in which it can be cooled to the desired temperature by means of ice water. The water as it leaves the cooler will have a temperature of from 60 to 65 degrees, so that only enough ice will be needed to reduce the temperature about 10 degrees.

Fig. 70 also illustrates the method of heating water for the boiler and for general washing.

**Determining the Purity of Water.** The author has found that a good idea of the purity of well water may be had by adding about ten c. c. of the water to one pint of *sterile* milk and keeping the inoculated milk at a temperature of about 85 degrees for 36 to 48 hours. If the water contains many putrefactive organisms it will produce an odor in the milk which is akin to that of rotten eggs. A *control* sample of sterile milk should always be carried as a check on the efficiency with which the milk has been sterilized. Obviously pathogenic bacteria can not be detected by this method.

## CHAPTER XXX.

### MARKETING CREAM.

#### RELATIVE VALUE OF BUTTER, CREAM AND ICE CREAM.

Creameries located near good markets can often dispose of a portion of their cream to good advantage in the forms of cream and ice cream. To illustrate this, let us assume that butter, cream and ice cream can be sold at the following prices: Butter, 25 cents per pound; 30% cream, \$1.00 per gallon; and ice cream made from 15% cream, \$1.00 per gallon. Taking 100 pounds of 4% milk as a basis, this will have the following values when sold at the above prices:

**Value of Butter.** One hundred pounds of 4% milk will yield 4 2-3 pounds of butter, because where up-to-date methods of creaming and churning are followed every pound of butterfat will make fully 1 1-6 pounds of butter. Four and two-thirds pounds of butter at 25 cents per pound are worth \$1.17. Valuing buttermilk and skimmilk at one-half cent per pound, 47 cents should be added to the \$1.17 as the value of the skimmilk and buttermilk, making a total value of \$1.64 for the 100 pounds of 4% milk.

**Value of Cream.** One hundred pounds of 4% milk will make 13.33 pounds of 30% cream, as determined by the following rule: To find the number of pounds of cream from a given amount of milk, multiply the milk by its test and divide the product by the test of the cream. Thus,  $100 \times 4 \div 30 = 13.33$ , the number pounds of cream from 100 pounds of 4% milk.

Since a gallon of 30% cream weighs practically the same as a gallon of water (8.35 lbs.), the 13.33 pounds of cream are equal to 1.6 gallons, which, at \$1.00 per gallon, are worth \$1.60. Allowing one-half cent per pound for skimmilk, we have 43 cents as the value of the 86 pounds of skimmilk, which gives a total value of \$2.03 for the 100 pounds of 4% milk.

**Value of Ice Cream.** Since a gallon of 15% cream weighs 8.45 pounds, 100 pounds of 4% milk will make 3.15 gallons of 15% cream (see rule for calculating cream, p. 262) or, allowing an overrun of 60%, 5.04 gallons of ice cream. At 75 cents per gallon this is worth \$3.78. To this must be added the value of 73 pounds of skim-milk, which, at one-half cent per pound, are worth 37 cents, making a total value of \$4.15 for the 100 pounds of milk made into ice cream.

**Summary.** The preceding calculations show that 100 pounds of 4% milk are worth

\$1.64 when sold as butter,  
2.03 when sold as cream,  
4.15 when sold as ice cream.

It is to be remembered that the above figures show the relative gross returns at the prices given. The net returns will vary, depending largely upon the cost of marketing and the quantity of cream handled. In the case of ice cream, 20 to 25 cents per gallon must be deducted as the cost of the materials used in its manufacture.

#### SELLING CREAM.

In marketing cream only the sweetest and best flavored should be selected. Its temperature should at once be

reduced below 50° F. When transported long distances in bulk, the cream should be handled according to the method outlined in chapter XXVIII, Transportation of Cream.

All cream sold must be guaranteed to contain a definite fat content. The process by which cream is brought to a definite percentage of fat is known as "standardizing" cream.

#### STANDARDIZING CREAM.

**Reducing Cream with Skimmilk.** When a definite quantity of standardized cream is called for, determine first the amount of original cream (cream as it leaves the separator) required according to the following rule:

Rule: Multiply the number of pounds of standardized cream called for by its test and divide the product by the test of the original cream.

The difference between the amounts of original and standardized cream represents the amount of skimmilk required.

Problem: How many pounds each of 45% cream and skimmilk (zero test) are required to make 60 pounds of 18% cream?

Applying the above rule we get,

$$(60 \times 18) \div 45 = 24 = \text{No. lbs. of original cream.}$$

$$60 - 24 = 36 = \text{No. lbs. of skimmilk.}$$

**Mixing Two Milks or Two Creams, or Milk and Cream, of Different Richness.** In the preceding formula the test of the skimmilk was considered zero. When milks or creams of different tests are mixed the calculation becomes more difficult. Pearson, however, has devised a method by which calculations of this kind are very much simplified. This method is as follows:



Draw a rectangle with two diagonals, as shown below. At the left hand corners place the tests of the milks or creams to be mixed. In the center place the richness desired. At the right hand corners place the differences between the two numbers in line with these corners. The number at the upper right hand corner represents the number of pounds of milk or cream to use with the richness indicated in the upper left hand corner. Likewise the number at the lower right hand corner represents the number of pounds of milk or cream to use with the richness indicated in the lower left hand corner.

Example: How many pounds each of 30% cream and 3.5% milk required to make 25% cream?

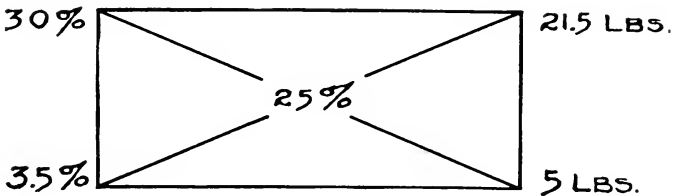

21.5, the difference between 3.5 and 25, is the number of pounds of 30% cream needed; and 5, the difference between 25 and 30, is the number of pounds of 3.5% milk needed.

From the ratio of milk and cream thus found, any definite quantity is easily made up. If, for example, 300 pounds of 25% cream is desired, the number of pounds each of 30% cream and 3.5% milk is determined as follows:

$$21.5 + 5 = 26.5$$

$$\frac{21.5}{26.5} \times 300 = 243.4, \text{ the number of pounds} \\ \text{of 30\% cream.}$$

$$\frac{5}{26.5} \times 300 = 56.6, \text{ the number of pounds} \\ \text{of 3.5\% milk.}$$

## CHAPTER XXXII.

### GRADING CREAM AND MILK.

As long as bad cream and milk continue to be accepted by creameries, just so long will grading remain a desirable practice. Statistics show that in spite of the rapid extension of inspection and educational work, there has been a distinct deterioration in the quality of butter in recent years, caused undoubtedly by increasing supplies of inferior cream. The general acceptance of such cream must be attributed to the present strenuous competition in the creamery sections.

It has been argued that because of this very competition the grading of cream would be impracticable. This may be true, to some extent at least, where grading is done solely with a view to paying farmers according to the quality of cream delivered, and while such a basis of payment is entirely just (and because of this should be employed), it is too well known that creameries have lost patronage by its adoption.

**Grading to Improve Butter:** There is, however, another important side to the grading of cream which of itself should justify its adoption, and that is the improvement of the quality of butter. The mixing of all grades of cream—sour, sweet, stale, putrid, fresh, rancid—can manifestly not produce a high quality of butter. The oldest, strongest and sourest cream should be separated from the best. Immediately after pasteurizing the old, sour cream, it should be treated with a heavy starter and churned

as soon as the proper churning temperature is reached. The remaining cream is preferably also pasteurized and then treated with starter and ripened in the usual way. The same practice may also be followed with reference to milk.

Grading is advantageously practiced in a great many of the larger creameries, but owing to the extra labor and expense involved, it can not be adopted with the same advantage by the smaller creameries.

With small creameries that can not make separate churnings, grading may still be followed to advantage. Where it is desired to churn all the cream in the same churning, a better quality of butter is possible when the sweet cream is ripened by itself with a heavy starter and the sour, stale cream added to this a few hours previous to churning. Adding sour, stale cream to sweet cream is equivalent to adding so much starter of a kind not likely to produce very good results. Moreover when a fine flavored starter is added to such a mixture its influence is small compared with what it is when added to sweet cream, because acid is a hindrance to the development of the lactic acid bacteria.

Where old, sour cream is held some hours it should be kept at a low temperature.

**Grading to do Justice and Improve Raw Material.** The butter maker has far better control over sweet cream than he has over sour cream and can therefore make a better quality of butter from it. It is then no more than just that the patron who takes good care of his cream and endeavors to deliver it often, should receive more for it than the man who is careless and delivers the cream only once a week. Wherever possible patrons should be paid according to the quality of cream delivered.

Grading should also stimulate careless patrons to improve the quality of their milk and cream. Indeed this would certainly follow in many cases, unless the patron is so situated that he might patronize a competing creamery which is willing to accept his cream on a par with the best cream.

**Number of Grades.** In general creamery practice two grades will perhaps be found to give better satisfaction than more grades. A number of the larger creameries, however, make use of three grades.

**Basis of Grading Cream.** Cream is ordinarily graded on taste, smell and acidity. In some cases the grading is done wholly on the basis of acidity, in others it is done wholly by taste and smell. In a few cases frequency of delivery and richness are considered. All of the above factors have a bearing upon the quality of cream.

Where an expert examines the cream, the sense of taste and smell yields the best judgment as to the quality of butter that can be made from such cream. Whatever basis of grading is employed, the sense of smell must always form a part of it.

The grading upon a basis of acidity alone may result in unfairness, because a fine flavored, sour cream is not as objectionable as a sweet, stale smelling cream. However where this test is employed in conjunction with the sense of smell the results are usually very satisfactory.

In regard to the frequency of delivery, it is evident that any cream four days old, regardless of how it has been produced and handled, will not make a first class quality of butter. Where cream of this age or older is received, therefore, it can justly be barred from grade No. 1, without any examination whatever. For this reason the age of the cream should prove valuable as aid in grading.

Since sour cream containing less than 30% fat can not be satisfactorily pasteurized and since rich cream has the further advantages mentioned on page 237, the richness of cream may well be considered in grading.

The basis for grading cream must necessarily vary under different conditions.

**A Rapid Acid Test for Cream.** Such a test is described on page 81, and can be used for milk as well as for cream. If a higher standard of acidity is to be fixed than the one employed on page 81, the only change necessary is to make the solution stronger.

For tests employed in general grading of milk and cream, see Chapter XXII.

**Frequent Deliveries vs. Grading.** Many no doubt could save themselves the trouble and expense of grading by insisting that cream be delivered more frequently. Cream produced and handled under the best conditions will not make the highest quality of butter when allowed to become three or four days old. While there is plenty of room for improvement at the farms in the matter of securing better cream, it is believed that more poor butter is produced at the present time as a result of infrequent deliveries of cream than from unsanitary conditions at the farms.

Many of our local creameries have the matter of gathering cream entirely in their own hands, and, while there are no statistics to offer, it seems that it would be less expensive for many such creameries to gather cream more frequently than to attempt to grade; and what is of no small importance, it would create less dissatisfaction among the patrons.

It is well known that cream will rot just like any other

perishable product. No cream, regardless of how it is produced or handled, is fit to make into a high quality of butter when four days old. Where attempts are made to keep cream several days, the conditions under which it is kept are usually such as to check the development of the lactic acid bacteria; and the more these germs are checked the more favorable the conditions for the development of other kinds.

Every creamery man before starting to grade cream should consider his local conditions and fully satisfy himself whether the advantages afforded are sufficient to cover the extra labor and expense which this system of handling cream involves. To divide the cream into two separate grades requires an extra cream vat, an extra churning, extra work in handling the cream and butter, extra work in marketing the butter and extra work in paying for the cream.

## CHAPTER XXXI.

### CREAMERY MECHANICS.

#### THE STEAM BOILER.

There are three principal types of boilers in use at the present time: (1) water tube boilers; (2) internally fired, or marine, boilers; and (3) fire tube boilers.

In the water tube boiler the water circulates through tubes which receive the heat directly from the furnace. These tubes communicate with an iron cylinder, placed directly over them, which serves the purpose of a steam reservoir. Boilers of this type are rapidly gaining favor as economical steam generators. They occupy somewhat more space, however, than the other types of boilers.

In the marine boiler, the firing is done in the shell, the entire fire box being surrounded by water. The return heat passes through a series of tubes which nearly surround the upper half of the fire box. The entire boiler consists of a round iron cylinder supported on short legs. It is heavily covered with asbestos which dispenses with the brick work necessary with the fire tube boilers.

The marine boiler is neat and attractive and has grown much in popularity in recent years. As its name implies this type of boiler has been mostly used on the sea, but is now to be seen nearly everywhere in power plants.

The common form of creamery boiler belongs to the fire tube kind. Fig. 75 illustrates this boiler partly laid in brick. The grates, or iron bars, upon which the fire is placed are seen in the front half of the brick work. The



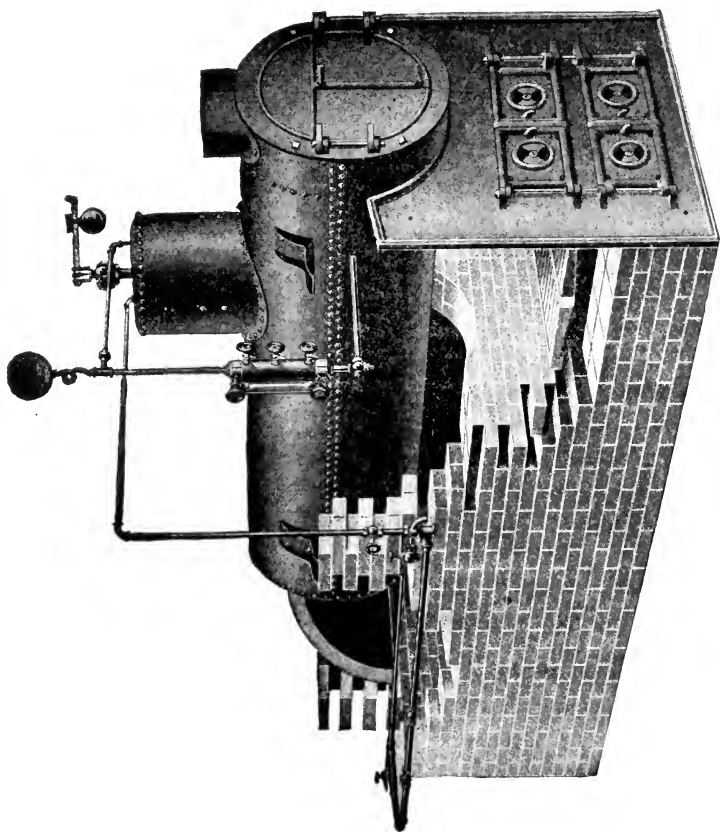

Fig. 75. — Firetube boiler.

heat and smoke pass along the underside of the boiler toward the rear and return through the fire tubes. To prevent radiation of heat the brick work must be built up to cover the entire boiler. The fire box must be constructed of the best fire brick.

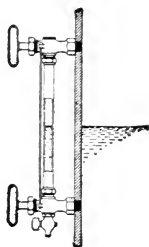

Fig. 76.—Glass gauge.

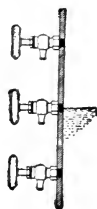

Fig. 77.—Gauge cocks.

The various boiler accessories will be described in the following paragraphs.

**Glass Gauge.** This is a glass tube attached to the side of the boiler to indicate the height of the water in it. The gauge is represented in Fig. 76. It is so attached that its lowest point is about two inches above the highest part of the fire line of the boiler, its entire length being usually about fifteen inches. The cock at the bottom is used to blow out the sediment that is liable to block the opening between it and the boiler. When this occurs the gauge becomes a false indicator. Frequent blowing out is therefore necessary. The cock next to the blow out admits the water from the boiler. The cock above this admits the steam. When the glass breaks shut off the water first, then the steam. Always have a few extra glasses on hand so that the broken one can be immediately replaced. Owing to its tendency to clog, the gauge can

not always be relied upon, hence the use of water cocks placed next to the glass gauge.

**Water Gauge Cocks.** Fig. 77 shows the attachments of these cocks. The water level should be kept as near as possible to the middle cock. It should never go below the lower cock, nor above the upper. These cocks should be opened many times during the day and so long as steam issues from the upper and water from the lower cock, the water level is all right.

**Steam Gauge.** This shows the number of pounds of steam pressure per square inch on the boiler by means of a pointer moving around a dial. Below the dial is a loop which contains water to prevent injury to the gauge from the hot steam. The steam gauge is liable to get out of order and will then fail to show the true pressure. Such a condition is indicated by the safety valve.

**Safety Valve.** This is placed on top of the steam chamber and permits the escape of steam when the steam pressure reaches the danger limit. It is an indispensable boiler attachment as without it the boiler would be a dangerous thing. There are two kinds of safety valves, the "pop" and "ball and lever" types. The former is considered the more desirable because it is not so easily tampered with. Both can be set to blow off at different pressures.

**Water Feed Apparatus.** There are two ways of feeding water into a boiler, namely, with injectors and with pumps.

**Injector.** This important boiler accessory, illustrated in Fig. 78, is attached to the side of the boiler. It utilizes the steam directly from the boiler for forcing water into it against a pressure as great as that which sends it forth. The principle which makes this possible may be stated

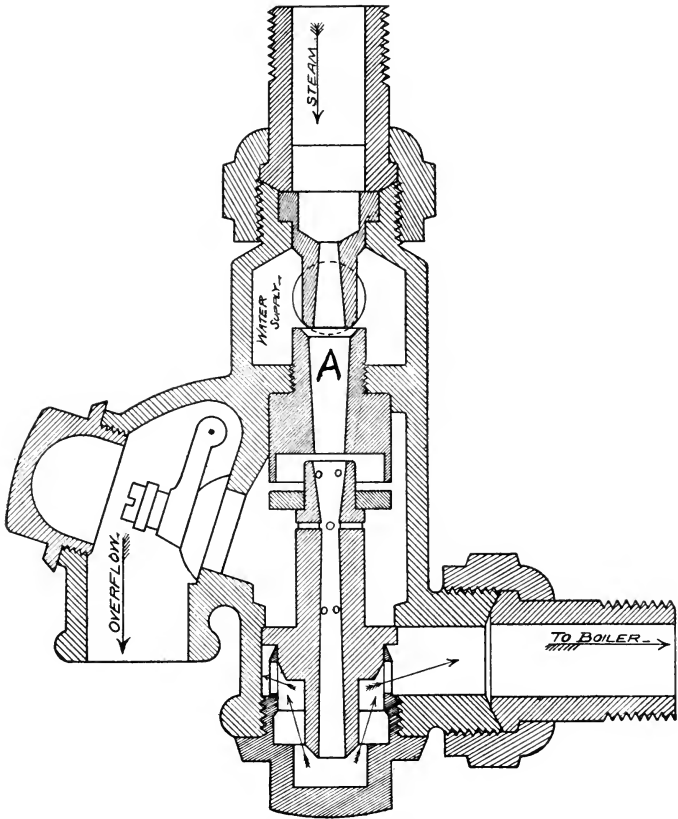

Fig. 78.—Injector.

as follows: Steam issuing from a boiler under 70 pounds pressure has a velocity of 1,700 feet per second. When steam with this high velocity strikes the combining tube A, it produces suction which in turn induces a flow of water. As soon as the water enters the combining tube it is given motion by the high velocity of the steam,

which immediately condenses and moves with the water into the boiler at a comparatively low velocity. The energy, therefore, by which steam can force water into the boiler against its own pressure is the latent heat resulting from the condensation of the steam in the combining tube.

From this it must be evident that the efficiency of the injector is dependent upon the completeness with which the steam condenses. This is clearly proved by every day practical experience. When, for instance, the feed water is too hot, the steam pressure too high, or the steam is wet, the injector fails to work properly because the steam does not sufficiently condense when it strikes the feed water.

**Starting the Injector.** This is done by opening the supply water valve one or two turns, then the steam valve wide. If steam issues from the overflow admit a little more water; if water overflows admit less.

**Care of Injector.** An injector will become coated with sediment or scale the same as the boiler and must, therefore, be frequently cleaned. This is best done by immersing it in a solution of one part muriatic acid and ten parts water. Allow to remain in this solution until the scale becomes soft enough to permit washing out. A clean injector rarely causes trouble but if trouble does occur it may be due to: (1) low steam pressure; (2) too hot water; (3) leaks in pipes and injector; (4) clogging of water pipe; (5) wet steam; (6) poor working condition of check and overflow valves; (7) clogging of feed pipe where it enters the boiler.

The injector is commonly used to feed water into the boiler because it is cheap and simple, and occupies little space.

**Pumps.** There are two kinds: (1) those run with

steam directly, and (2) those run by the engine. The latter is the more economical and handles hot water with less trouble. It has one disadvantage, however, and that is it does not work unless the engine is running. With good pumps, especially those run by the engine, good work may be expected when the feed water has been heated to  $200^{\circ}$  F. with the exhaust steam from the engine. With the injector such high temperatures are not permissible, hence the greater economy of the pump. The great saving of fuel by feeding water hot into the boiler is illustrated by experiments made by Jacobus which show that with a direct acting pump 12.1% fuel is saved by heating the feed water from  $60^{\circ}$  to  $200^{\circ}$  before pumping it into the boiler. With injectors the feed water used usually has a temperature of about  $60^{\circ}$  F.

#### STEAM.

Water is practically a non-conductor of heat. This means that it cannot conduct its heat to its neighboring particles. When, therefore, heat is applied to the bottom of a vessel containing water, the particles at the bottom do not communicate their heat to the particles next above them, but expand and rise, cool ones taking their places. This gives rise to convection currents which tend to equalize the temperature of the water in the vessel. When the water has reached a uniform temperature of  $212^{\circ}$  F. the particles begin to fly off at the surface in the form of vapor, and this we call *steam*. To generate steam in a boiler, then, it is necessary to impart to the water in it a considerable amount of heat, which is produced by burning fuel in the fire box.

## FIRING OF BOILER.

The immense amount of heat stored in wood and coal is rendered effective in the boiler by burning (combustion). To understand how to fire a boiler intelligently we must first learn what the process of burning consists of.

**Process of Burning.** Anything will burn when the temperature has been raised high enough to cause the oxygen of the air to unite with it. Thus, in "striking" a match the temperature is raised high enough by the friction produced to cause the match to burn. The burning match will produce heat enough to ignite the kindling, which in turn, produces the necessary heat to ignite the wood or coal in the fire box of the boiler. Burning may, therefore, be defined as the union of the oxygen of the air with the fuel. In burning a pound of coal or wood a definite amount of air must be admitted to furnish the necessary oxygen for complete combustion. When oxygen is lacking part of the fuel passes out of the chimney unburned in the form of gases. If, on the other hand, too much air is admitted the excess simply passes through the chimney, absorbing heat as it passes through the boiler. The problem of firing becomes, therefore, a difficult one.

**Burning Coal and Wood.** When hard coal is burned the fire should be thin. A thickness of three to four inches on the grates gives very satisfactory results. For best results with soft coal a thickness of six to seven inches is recommended. Whenever fresh coal is added it should be placed near the front and the hot coals pushed back.

In case wood is burned the fire box should be kept well filled, care being necessary to keep every part of the grate well covered.

## GENERAL POINTERS ON FIRING.

1. Boilers newly set should not be fired within two or three weeks after setting and then the firing should be very gradual for several days to allow the masonry to harden without cracking.

2. Never fire a boiler before determining the water level by trying the water gauge cocks. You can not entirely rely upon glass gauges, floats, and water alarms.

3. When starting the fire, open the upper water gauge cock and do not close it until steam begins to issue from it. This permits the escape of confined air.

4. Kindle the fire on a thin layer of coal to protect the grate bars.

5. Always examine the safety valve before starting a fire.

6. When starting the fire all drafts should be open.

7. The firing should be gradual until all parts of the boiler have been heated.

8. Never allow any part of the grate bars to become uncovered during firing.

9. Frequently clean the ash pit to prevent overheating of grates from the hot cinders underneath.

10. The coals upon the grates should not be larger than a man's fist.

11. Remember that firing up a boiler rapidly is apt to cause leaks.

12. Remember that too little water in the boiler causes leaks and explosions.

13. Remember that soot and ashes on heating surfaces always waste fuel.

14. When fire is drawn close dampers, and doors of furnace and ash pit.



15. Never open or close valves when the water is too low in the boiler, but immediately bank the fire with ashes or earth. Opening the safety valve at such a time will throw the water from the heated surfaces, resulting in overheating and possibly in explosions.

16. Use the poker as little as possible in firing.

17. Keep the grate bars free from "clinkers."

18. When the steam pressure goes too high, start the pump, open the doors of the furnace and close the ash pit.

19. A steady and even fire saves fuel.

#### GENERAL CARE OF BOILER.

1. Always close the steam and water valves of the glass gauge when you leave the building for half an hour or more.

2. Water gauges should frequently be blown out and cleaned.

3. Keep the exterior of the boiler dry. Moisture will corrode and weaken it.

4. The boiler should be blown off under low pressure every two or three days.

5. A boiler that is not used for some time should be emptied and dried. If this cannot readily be done, fill it full of water to which a little soda has been added.

6. Frequently examine the safety valve to see that it is in good working order.

7. Do not empty boiler while brick work is very hot.

8. Never pump cold water into a hot boiler. Leaks and explosions may be the result.

9. Leaky gauges, cocks, valves, and flues should be repaired at once.

10. Do not fail to examine the pressure gauge frequently.

11. It is good policy to have two means of feeding a boiler. The pump or injector may get out of order and cause delay and danger.

12. Feed pumps and injectors need frequent cleaning to keep them in good working order.

13. Look out for air leaks. If air is admitted anywhere except through the grates serious waste may result. Such leaks are to be looked for in broken doors and poor brick work.

14. Flues should be cleaned often, especially if soft coal is burned. This will prevent over heating of metal, at the same time save fuel.

15. Do not allow filth to accumulate around the boiler or boiler room.

16. Keep all the bright work about the boiler "shiny."

17. Do not fail to empty the boiler every week or two and refill with fresh water.

18. Have your steam gauge tested at least twice a year.

#### BOILER INCRUSTATION.

In all boilers after a period of use, there is deposited upon the parts below the water level a scale or sediment known as boiler incrustation.

**Cause of Scale.** The formation of scale is due to the impurities contained in the feed water. When impure water is fed into the boiler the impurity first manifests itself in the form of scum on top of the boiling water. The heavier particles of the scum slowly unite and sink to the bottom where they first appear as mud. By continued exposure to high temperature, this mud gradually

forms into a hard impervious scale which usually consists largely of lime.

**Objection to Scale.** 1. The excessive formation of boiler scale is the immediate cause of most boiler explosions. The scale acts as a non-conductor of heat, so that in cases where the capacity of the boiler is severely taxed, the metal becomes overheated, thus materially weakening it. The scale is, therefore, not only dangerous, but by overheating the metal, also materially shortens the life of the boiler. 2. Another most serious objection to scale is its wastefulness of fuel. This becomes evident when we note that the heat before reaching the water must first be conducted through a non-conducting layer of incrustation.

**Prevention of Scale.** Since nearly all water used for boilers is more or less impure, it is evident that to prevent scale, boilers must receive frequent cleaning. How often this needs to be done is, of course, dependent upon the amount and character of the impurity in the water. Boilers are kept clean in three different ways: (1) by blowing off at low pressure, (2) by cleaning through man hole, and (3) by using boiler compounds.

(1.) By blowing the boiler off at low pressure most of the mud will be blown out. But care must be taken that the pressure is not above ten pounds and that there is no more fire in the fire box, otherwise the mud, instead of flowing out with the water, will bake on and form scale.

(2.) A good way of removing mud is to allow the boiler to cool off and then run a rubber hose through the man hole. By working the hose and forcing water through it the sediment can be removed.

(3.) Boiler compounds are used to keep boilers free

from scale. The kind of compound to be used is determined by the character of the impurities of the water. Most creameries use well water for the boiler and the chief impurity in this is lime. The best compound for water of this kind is soda. Well water contains the lime in widely different proportions. In order, therefore, to ascertain the proportion of soda to feed water the following method is recommended by Hawkins:

“1. Add one sixteenth part of an ounce of soda to a gallon of the feed water and boil it. 2. When the sediment thrown down by the boiling has settled to the bottom of the kettle, pour the clear water off and add one-half drachm of soda to this. Now, if the water remains clear, the soda which was put in has removed the lime. But if it becomes muddy, the second addition of soda is necessary.” In this way the amount of soda to be added to the feed water can be calculated with sufficient accuracy.

Tan bark is very efficient in removing boiler scale but may injure the iron.

Kerosene answers the same purpose but renders the steam unfit for use in the creamery.

When the water is salt or acid, a piece of metallic zinc occasionally placed in the boiler will prevent corrosion. Water of this kind can usually be told by its corrosive effect on copper and brass. Acid water can also be detected with blue litmus paper, which it turns red.

#### WET AND DRY STEAM.

**Wet Steam.** This is steam holding in suspension extremely small particles of water which are thrown off from the water surface while steam is generating. The following are the causes of wet steam:

1. Impure water in the boiler.
2. Too much water in the boiler.
3. Too little evaporating surface for the amount of steam used. This is one of the chief objections to upright and too small boilers.
4. Violent agitation of the water in the boiler caused by too rapid a generation of steam.

Wet steam causes "priming" and is wasteful of heat.

**Dry Steam.** This is saturated steam holding no water mechanically in suspension. High steam pressure and a large steam space above the water level are conducive to dry steam.

#### HORSE POWER OF BOILERS.

A horse power of a steam boiler is thirty pounds of feed water at a temperature of  $100^{\circ}$  F. converted into steam in one hour at 70 pounds gauge pressure.

The horse power of a boiler may be approximately calculated by dividing the total square feet of heating surface in the shell, heads, and tubes, by fifteen.

#### SMOKE STACK.

It is difficult to state the exact size of a smoke stack for a given boiler because conditions vary so much. It is evident that it must be longer for a boiler placed at the foot of a hill than for the same boiler placed on top of the hill.

A smoke stack for a 25 H. P. boiler should be about one foot square inside and from 30 to 40 feet high and built of brick. A small smoke stack which affords inadequate draught is wasteful of fuel and gives rise to much trouble in firing.

## THE STEAM ENGINE.

The engine may be defined as a machine which converts heat into mechanical power. This heat is obtained

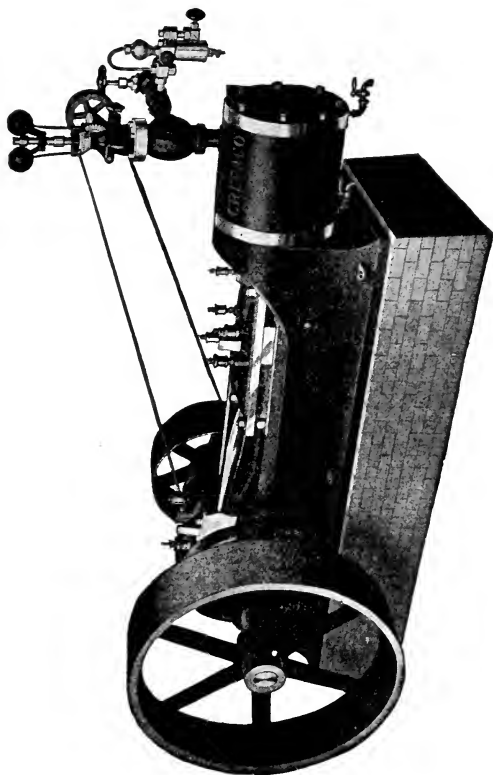

Fig. 79.—Steam engine.

in the form of steam under pressure from the burning fuel in the boiler. A common form of creamery engine is illustrated in Fig. 79.

**Engine Foundation.** The engine to run smoothly must be placed upon a solid foundation constructed of hard burned brick laid in cement. Where the ground is soft and loose the brick work must be built upon a foundation of coarse stones laid in cement.

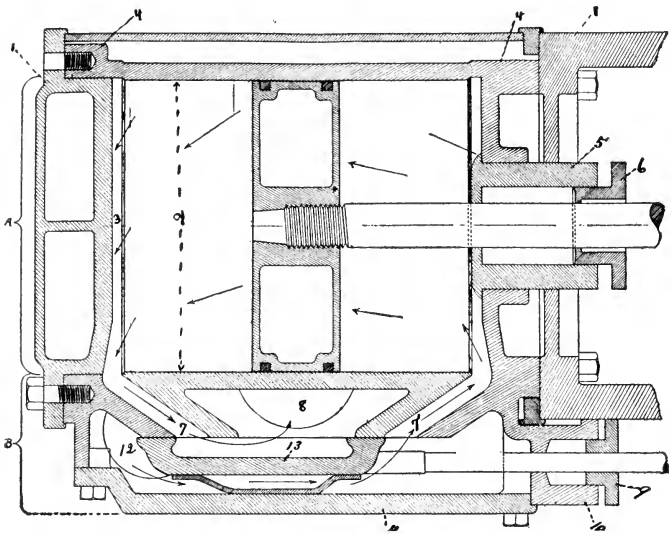

Fig. 80.—Steam cylinder and valve chest.

#### PARTS OF THE ENGINE.

**Steam Cylinder and Valve Chest.** These are the vital parts of the engine. A section through the cylinder and valve chest is shown in Fig. 80. A represents the cylinder part, B the valve chest.

Parts of A: 1, cylinder heads; 2, bore of cylinder; 3, counter bore; 4, flanges; 5, stuffing box; 6, gland.

Parts of B: 7 and 7', steam ports; 8, exhaust port;

9, valve stem gland; 10, valve stem stuffing box; 11, valve chest cover; 12, steam inlet; 13, slide valve.

**Working of Piston.** The arrows in the preceding cut show the course which the steam takes in the valve chest and cylinder. As the steam enters at port 7<sup>1</sup> the piston is

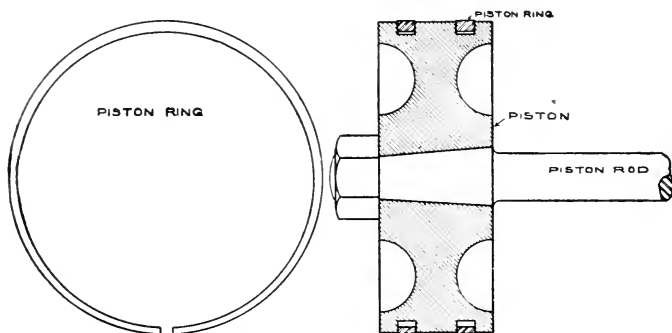

Fig. 81.—Piston and ring.

pushed back and the exhaust steam escapes through port 7. The slide valve 13 gradually moves forward while the piston moves back so that both ports will be closed when the piston has traveled about four-fifths of the distance of the cylinder. There is, however, enough energy stored in the fly wheel or drive pulley to carry the piston beyond the dead center when steam will enter the cylinder through port 7, causing the piston to move forward while the exhaust steam escapes through port 7<sup>1</sup>. When the piston has traveled about four-fifths of the distance of the cylinder both ports are again closed, so that at every revolution of the crank the dead center is passed twice.

Fig. 81 shows the piston and piston ring.

The piston must fit the cylinder tight enough to prevent leakage of steam, yet not so tight as to cause undue



friction. A good way to find out whether a piston leaks steam is to put the engine on the dead center on the crank end. Then take off the cylinder cover on the head end and admit steam back of the piston. If the piston leaks, steam may be seen escaping between the packing ring and the wall of the cylinder.

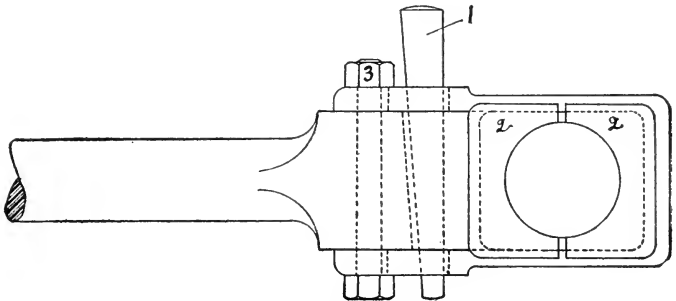

Fig. 82.—Connecting rod end.

**Crosshead.** This connects the piston rod and connecting rod and serves to guide the former so as to have it move in a straight line.

**Connecting Rod.** This forms the connection between the crosshead and crank. The crank end of the rod is shown in Fig. 82. 1 represents the crank pin key; 2, crank brasses, and 3, burr that fixes the crank pin key.

**Crank.** This rotates the shaft of the engine and permits the change of rectilinear into circular motion.

**Eccentric.** This forms a sort of crank which, as its name implies, does not turn around a true center. It opens and closes the steam ports in the valve chest by means of the eccentric rod which forms the connection between it and the slide valve.

**Setting the Slide Valve.** The slide valve should be

so set on the valve stem that its edges will pass each steam port an equal amount during a full revolution of the engine. If not so set, the valve should be moved, by loosening the nuts on the valve stem, until the correct position is reached.

The next thing to do is to place the engine on its true center with the outward stroke. Now turn the eccentric upon the shaft in the direction in which the engine is to run until the valve has uncovered the port sufficiently for the required *lead*, which should be about one-sixteenth of an inch.

**Governor.** This device governs or regulates the speed of the engine by controlling the inlet of steam in to the cylinder.

There are two kinds of governors: one is known as the automatic cut-off which consists of centrifugal weights placed in the fly wheel, which vary the point of cut-off by revolving the governor eccentric upon the shaft. With governors of this kind the steam is entirely cut off when the speed gets too high, while with the other form of governor the steam is throttled. The "throttle" or "ball" governor is more common on creamery engines than the automatic cut-off. Fig. 83 illustrates the working of the ball governor. The important parts are: 1, governor balls; 2, pulley; 3, stem; 4, valve discs; 5, stuffing box; and 6, valve seats. As the speed of the engine increases the balls are thrown farther out and the valve discs come nearer the valve seats, thus throttling or reducing the amount of steam that enters the cylinder.

The automatic cut-off is considered the more economical of the two governors though it is somewhat more difficult to regulate. Most engines now made are of the automatic cut-off type.

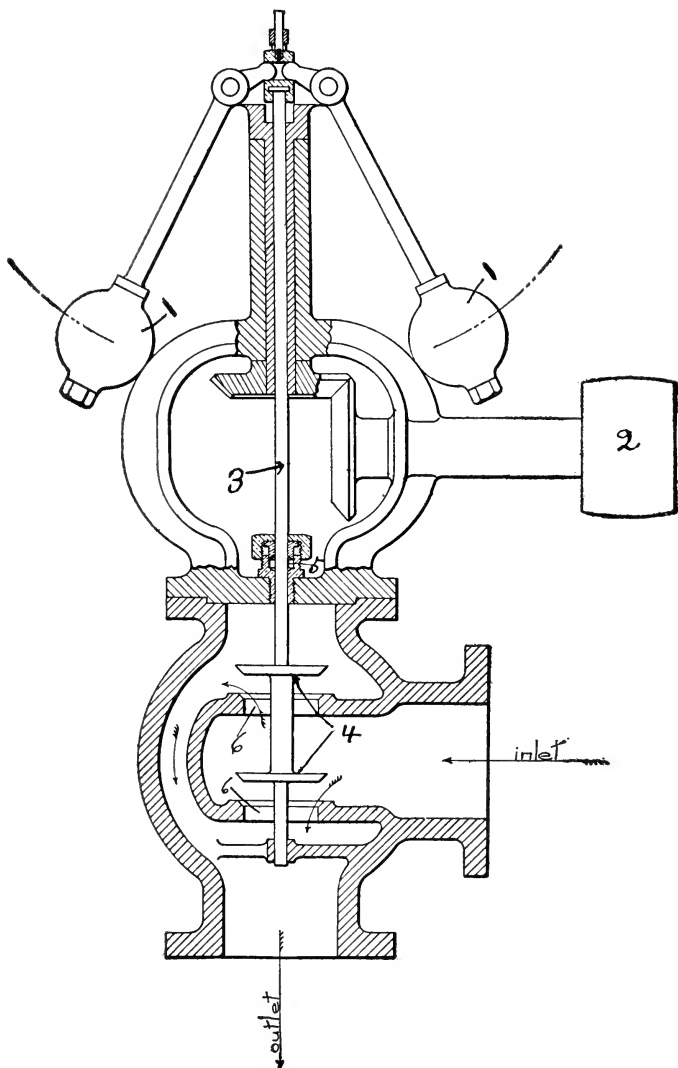

Fig. 83.—Governor.

**Lubricator.** This device serves to supply oil to the cylinder. There are various forms of lubricators one of which is illustrated in Fig. 84. The working of this lubricator may readily be understood by following the course of the steam as indicated by the arrows.

The steam condenses in the small pipe, enters the bottom of the oil cup where the condensed steam displaces an equal quantity of oil, which, being lighter than water, is forced up and overflows into a pipe placed inside the lubricator whence it may be seen to escape in drops through the glass tube. From here it passes with the steam into the cylinder.

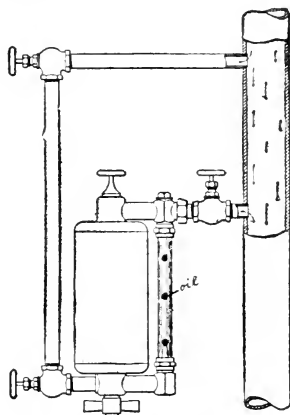

Fig. 84.—Lubricator.

**Pipes and Piping.** The main pipe is that which conducts the steam from the boiler to the engine. This pipe should be well covered with non-conductor to prevent loss of heat.

A very efficient and inexpensive pipe covering is made by mixing wood sawdust and common starch, using them in the proportion to form a thick paste. Such a paste will adhere perfectly to wrought or cast iron pipes when absolutely free from grease. A thickness of one inch is sufficient.

The *exhaust steam* pipe carries away the steam after it has been used in the cylinder. To make the best use of the heat that remains in exhaust steam, this pipe should first be carried through a water tank located in the

boiler room, thence outside the building. The exhaust steam will be ample to heat all the water needed for washing as well as that used for the boiler. A great deal of fuel can be saved in a creamery by properly utilizing the exhaust steam. A drip cock will have to be placed at the bottom turn of the exhaust pipe to permit draining it.

When the engine is placed in the creamery proper, it is very essential to have cylinder drain pipes to carry away the water and partially condensed steam that is found in the cylinder when the engine is started.

In piping avoid turns as much as possible and provide exhaust pipes of ample size.

#### CARE AND MANAGEMENT OF ENGINE.

1. It is essential to have all parts of the engine well oiled, using nothing but the best oil.

2. Keep the engine clean. The shiny parts should be brightened at least once a day.

3. Keep the engine well "keyed up." At both ends of the connecting rod are keys, one of which is shown in Fig. 51. The purpose of these keys is to keep the brass boxes tight enough to prevent undue play. The "keying" consists in loosening the burrs next to the key and then tapping the latter lightly until the unnecessary play is taken up. Care must be taken, however, not to get the brasses too tight or a hot box will be the result. "Pounding" is usually caused by not having the keys properly set. It is also caused by wet steam and water in the cylinder.

4. Keep stuffing boxes carefully packed to prevent leakage of steam. The packing should be treated with graphite or good cylinder oil and packed firmly around

the rod, but it must not be too tight, otherwise power is lost in friction. If the rod has become scored or rusty, smooth it with emery cloth before packing.

5. The packing rings in the piston should be kept in good repair. The clicking noise sometimes heard in cylinders is due either to the packing ring wiping over the edge of the counter bore or to its being too narrow for the groove in which it is placed. A ring is needed that fits this groove properly. If the packing ring is too small for the cylinder bore it should be set out by peening or by tightening the setting out bolts.

6. When gumminess is noticeable in any of the bearings, remove same with benzine and use a purer oil.

7. When the engine "races" look for the trouble in the governor.

8. Thoroughly drain cylinder when not in use. This *must* be done in the winter to prevent freezing.

#### HORSE POWER OF ENGINE.

The horse power of an engine is calculated from the following formula:

$$\text{H. P.} = \frac{p \times l \times a \times n}{33,000} \text{ in which}$$

P = Mean effective steam pressure.

l = length of stroke in feet.

a = area of piston in square inches.

n = number of strokes per minute.

H. P. = Horse power.

33,000 = Number of foot-pounds.

A foot-pound is one pound raised through one foot of space.

Length of stroke = twice the length of crank.

No. of strokes per min. = twice the number of revolutions.

$$\text{Area of piston} = \frac{\pi d^2}{4}$$

Example :

$$P = 40 \text{ lbs.}$$

$$l = 2 \text{ ft.}$$

$$a = 20 \text{ sq. inches.}$$

$$n = 400.$$

$$40 \times 2 \times 20 \times 400 = 640,000$$

$$640,000 \div 33,000 = 19.4 = \text{H. P.}$$

#### CALCULATING SIZE AND SPEED OF PULLEYS.

In creameries where new shafting and new machinery are being put up, it is important to know how to determine the required speed of the shafting as well as the speed and size of the pulleys. This calculation is not difficult when we remember the following rule:

*The speed varies inversely with the diameter of the pulley.* Thus, with the same speed of the engine, the speed of the main shaft becomes less as the diameter of the pulley on that shaft is increased.

It must be remembered, also, that in a creamery where the churn and separators are run directly from the main shaft, the speed of this shaft must be fixed at from 175 to 200 revolutions per minute in order to permit the use of suitable sized pulleys.

We usually speak of two kinds of pulleys: the *drive* pulley and the *driven* pulley. Where the engine drives the main shaft the pulley on the engine is called the drive pulley and that on the main shaft the driven pulley. When we refer to the main shaft driving the intermediate, then the pulley on the main shaft becomes the driver and that on the intermediate the driven pulley.

In creameries there are two problems that present themselves with respect to pulleys: one is to find the speed of

the pulley when the diameter is given; the other is to find the diameter when the speed is given.

1. To find the speed of a driven pulley: Multiply the diameter of the driver by its speed and divide the product by the diameter of the driven pulley.

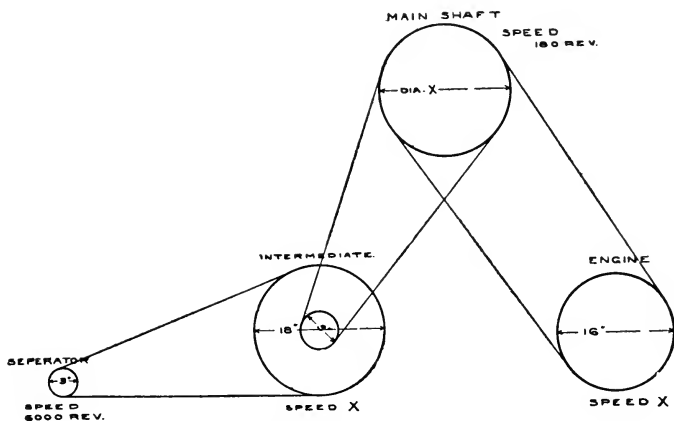

Fig. 85.—Belting from engine to separator.

Example: Diameter of engine pulley, 20 inches; speed of engine, 200 revolutions per minute; diameter of driven pulley, 25 inches.

$$20 \times 200 \div 25 = 160 = \text{No. rev. per min. of driven pulley.}$$

2. To find diameter of driven pulley: Multiply the diameter of driver by its speed and divide the product by the required speed of driven pulley.

Example: Diameter of engine pulley, 20 inches; speed of engine, 200 revolutions per minute; speed of driven pulley, 200 revolutions per minute.

$$20 \times 200 \div 200 = 20 = \text{diameter of driven pulley.}$$



Let us calculate the size and speed of pulleys necessary to run a separator 6,000 revolutions per minute when the following conditions are known: Size of drive pulley on engine, 16 inches; size of separator pulley, 3 inches; size of large pulley on intermediate, 18 inches; size of small pulley on intermediate, 5 inches; speed of shaft, 180 revolutions per minute.

The known conditions given here are indicated in the diagram above by figures, the unknown by  $x$  (Fig. 85).

The calculation in this problem begins at the separator, where both the speed and diameter of the pulley are known, and ends with the determination of the speed of the engine.

1. Determine the speed of the intermediate which has a large pulley at one end and a small one at the other. Applying the foregoing rules, the speed of intermediate is equal to:

$$6000 \times 3 \div 18 = 1000 \text{ rev. per min.}$$

2. Determine diameter of pulley on main shaft. This is equal to:

$$1000 \times 5 \div 180 = 27.7 \text{ inches.}$$

3. Determine speed of drive pulley on engine. This is equal to:

$$180 \times 27.7 \div 16 = 312 \text{ rev. per min.}$$

With most engines a great range of speed is possible by regulating the governor. It is better, however, to have the drive pulley of such size as to keep the speed under 300 revolutions per minute.

## FRICTION : ITS ADVANTAGE AND DISADVANTAGE.

The resistance produced by one body sliding over another is called friction. No matter how smooth a surface may appear it always contains irregularities (molecular) which are not unlike the teeth of a saw, though so small as to render them invisible to the naked eye. Whenever, then, two surfaces are put together they interlock and when made to slide over each other produce friction.

**Friction as Applied to Belts.** Practical application of friction is made in transmitting power by means of belts. Without friction such transmission would be impossible. The highest efficiency of belts is obtained where there is no slipping or stretching, conditions made possible by observing the following points:

1. Use only good leather belting.
2. Avoid too slack or too tight belts.
3. Run belts with the hair side next to the pulley.
4. Cover face of pulley with belting and have the hair side out.
5. Keep belts dry and flexible.

**Size of Belting.** A two-ply belt may be subjected to an effective tension of 40 pounds per inch of width without straining it. In determining, therefore, the width of a belt for a given horse power the effective tension of the belt must be considered. Further, since a fast running belt is capable of transmitting a greater horse power per given width than a slow running belt, the speed of the belt must also be considered. Hence the following formula:

$$\text{Width of belt} = \frac{\text{No. H. P.} \times 33,000}{\pi D \times \text{No. rev.} \times 40}$$

In which

H. P. = Horse power.

33,000 = Number of foot-pounds in one H. P.

No. rev. = Number of revolutions of drive pulley  
per minute.

40 = Effective tension.

$\pi = 3.1416$ .

D. = Diameter of drive pulley in feet.

Example: What width of two-ply belting is required with a drive pulley fourteen inches in diameter, making three hundred revolutions per minute and developing ten horse power?

Applying our formula we have:

$$\text{Width} = \frac{10 \times 33,000}{3.1416 \times 14 \times 300 \times 40} = 7.5 \text{ inches.}$$

**Lacing Belts.** In lacing belts care must be taken never to cross the lacing on the side of belt next to the pulley, nor to have more than a double thickness of lacing. The ends of the belt should be cut off squarely so as to have them come together at all points. Holes are punched in a line one inch from the cut edges with the outer ones within half an inch of the edge of the belt. They should be just large enough to permit double lacing. The lacing is best begun at the middle of the belt, care being taken to have the smooth side of the lace on the side of the belt that runs on the pulley. The ends are fastened either by running them through small holes punched in line with the lace holes, or by cutting a small slit in the middle of one end, then cutting into the edge and toward the end of the other, which is run through the slit just beyond the cut edge.

Rubber belts are not as desirable for creamery use as leather belts.

**Adjustment of Shafts.** To avoid straining a belt the shafts must be parallel. This means that where the intermediate and engine are hitched to the same shaft the latter must be placed in position first. The engine and intermediate are then lined up so as to have their shafts run parallel with the main shaft. When the shafts are parallel the pulleys are easily adjusted so as to have the belts run on the middle of the pulley.

**Lubricants or Oils.** These slippery substances act in a two-fold way in minimizing the friction between sliding surfaces: (1) by filling up the inequalities of the sliding surfaces, thus preventing interlocking; (2) by allowing oil to slide on oil instead of one solid surface upon another.

The best oils are those that are entirely free from any tendency to gumminess and it is economy to use only such. Indeed in fast running machinery no other oils are permissible.

**Consistency of Oils.** This is determined by the use to which the oil is put. In fast running machinery where there is little pressure on the bearings, as, for example in a cream separator, very thin oil is most serviceable. The reasons for this are (1) that only a very thin layer of oil is required in the bearings of such machinery, and (2) that there is some friction produced in one layer of oil sliding upon another, and the thinner the oil the less will be the friction produced in this way.

The crank shaft of an engine, which runs at a comparatively low speed and is subjected to more or less pressure, requires a rather heavy oil for best service.

**Hot Bearings.** These are most frequently caused by

using an insufficient amount, or the wrong kind, of oil. Hot bearings are also frequently caused by dirt, slipping belts, too tight belts, and too tight bearings.

#### TOOLS, PACKING, AND STEAM FITTINGS.

A creamery contains a great deal of machinery and

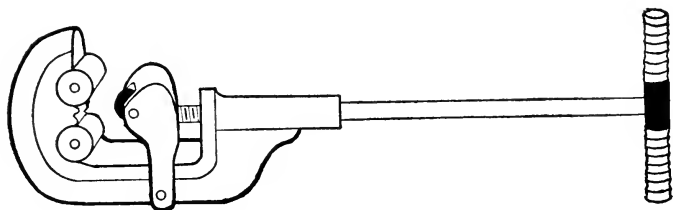

Fig. 86.—Pipe cutter.

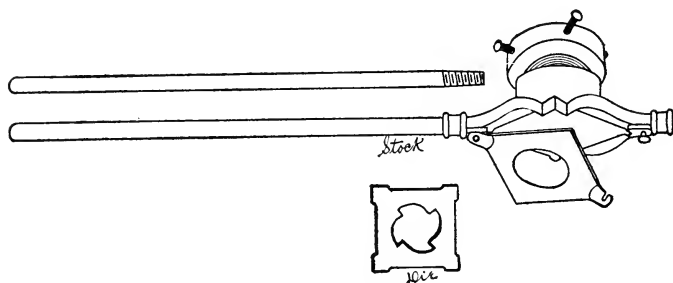

Fig. 87.—Stock and die.

pipng. The need of an ample supply of tools, packing, and steam fittings is therefore evident.

**Tools.** These consist mainly of pipe cutter, two pipe tongs, vise, stock and dies, alligator wrench, a pair of gas pliers, hammer, punch, and screw driver. Fig. 86 shows pipe cutter; Fig. 87, stock and dies; Fig. 88, alligator wrench; Fig. 89, vise; and Fig. 90, pipe wrench.

**Packing.** All steam stuffing boxes should be packed with asbestos which has been treated with a mixture of oil and graphite.

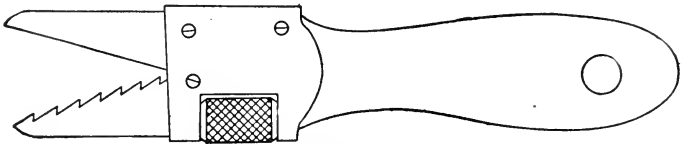

Fig. 88.—Adjustable alligator wrench.

Pipe joints, such as unions, should be fitted with rainbow gaskets to which a little graphite or chalk is added to prevent their sticking to the joints. Pipes that must be frequently taken apart should have ground joints. These will do away with the use of gaskets which are troublesome in such cases.

**Steam Fittings.** Extra fittings for one-half to two inch pipes should always be on hand. The necessary fittings are elbows, nipples, bushings, tees (Ts), plugs, lock nuts, couplings, reducing couplings, and unions.

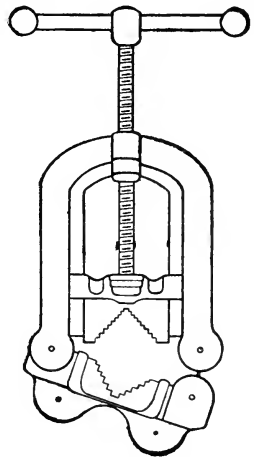

Fig. 89.—Vise.

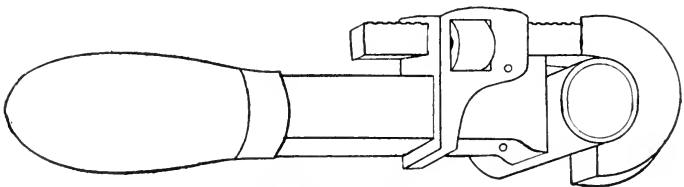

Fig. 90.—Pipe wrench.

When using right and left nipples, that is, nipples with a right thread at one end and left thread at the other, screw each end separately into the pipe which it is to fit and count the number of threads covered. If, for example, four right threads are covered and six left threads,

then cover two left threads before joining with the other end. In this way the two ends turn tight at the same time, which is necessary to prevent leaking.

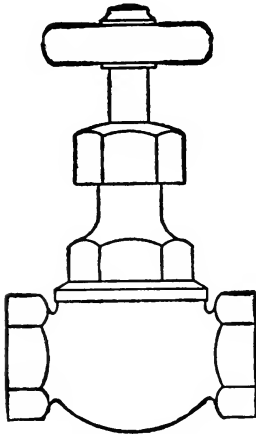

Fig. 91.—Globe valve.

#### VALVES.

The subject of valves is an important one and deserves much attention. Usually the ordinary creamery contains from twenty-five to fifty valves. It is, therefore, not surprising to find steam and water leaks in a creamery building. To replace a valve as soon as it begins leaking is too expensive. The proper thing to do is to repair it. In the following paragraphs a brief discussion will be given of the kinds of valves and the methods of repairing them.

**Globe Valve.** This valve, shown in Fig. 91, takes its name from its globular form. It is preferably so placed as to allow the pressure of the steam to come under the valve.

**Check Valve.** This is placed between the boiler and the feed pipe to prevent the return of water and steam.

**Gate Valve.** As its name implies, this is a valve closed by a gate.

**Throttle Valve.** This is the valve that admits the steam to the engine.

**Stop or Gas Valve.** This is opened by giving it a half turn. It is commonly used on receiving vats, and on milk and skim-milk pipes.

**Rotary Valve.** This is illustrated by the stop cocks used on the boiler.

**Ball Valve.** This is an automatic valve illustrated by the float that regulates the feed of the separator.

**Parts of a Globe Valve.** These are: (1) chamber; (2) seat; (3) stem; (4) stuffing box; (5) disc; and (6) handle. The chamber is the place where the valve operates. The disc is attached to the stem and closes the valve by turning it onto the seat.

**Repairing of Globe Valves.** There are three parts in a valve that may cause it to leak: (1) the seat, (2) the disc, and (3) the stem. In valves like the Huxley where the seat and disc are replaceable, extras should always be kept on hand so that either may be replaced when leaking. In valves like the Jenkins where only the disc is replaceable a "reseater" should be at hand whereby the seat of the valve can be made to fit tight again. A reseater for valves from one-half to one and one-half inches in diameter can be bought for twenty-five dollars, and creameries that use valves in which the seat is not removable should be provided with one.

The valve discs are made of various materials, but, for ordinary steam pressure, brass and "composition" discs are giving the best satisfaction.



The stuffing box of the valve is packed with asbestos to which a mixture of oil and graphite is first added. This packing will prevent the stem from leaking. The burr of the stuffing box must be tightened from time to time when it shows signs of leaking.

In case of water valves the stuffing boxes are best packed with oiled candle wicking.

#### LINING UP SHAFTING.

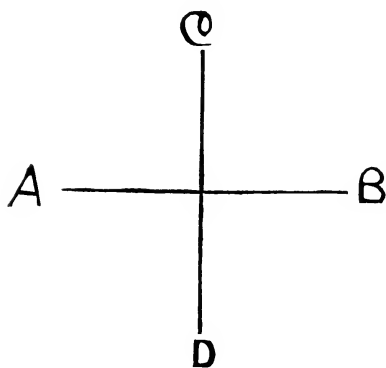

Fig. 92.—Intersecting planes.

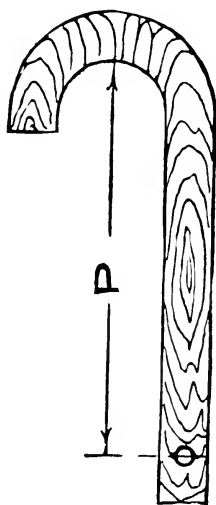

Fig. 93.—An aid to lining up shafts.

Fasten a heavily chalked string along the ceiling parallel to the direction the shafting is to take. Snap the string, and a white mark will indicate the position of the

shafting in a plane parallel to the floor. This plane is indicated by the line *ab* in Fig. 92. Next determine the position of the shafting in a plane at right angles to the floor, indicated by the line *cd*. This is done as follows: Loosely fasten the hangers along the white chalk line and properly fasten the shafting. Now hang on the shafting, at intervals of three feet, pieces of board like that shown in Fig. 93. The upper end is rounded to fit over the shaft, while the lower end is perforated as indicated by the dot. These pieces of board must be carefully cut so that the distance *P* is the same in all. If the holes at the lower ends are all in line the shafting is properly lined up. If not, the shaft needs readjusting.

## CHAPTER XXXIII.

### CREAMERY ICE CREAM MAKING.

Scores of creameries throughout the country are now making ice cream in connection with butter with very satisfactory results. At prevailing prices, cream converted into ice cream will yield approximately double the profit obtained by making it into butter.

Creameries have several important advantages in the manufacture of ice cream not possessed by exclusive ice cream manufacturers. In the first place the creamery can obtain its cream at a lower cost than the ice cream factory; and, secondly, most creameries are in a better position to meet the varying demands for ice cream because of the abundance of cream they always have on hand. This makes it possible for them to double their output on short notice, as well as enables them to pull through a sudden slump in the demand without loss because any surplus cream can be manufactured into butter.

**Kind of Cream.** Select the best flavored sweet cream containing about 20% butter fat. To secure the best bodied ice cream and the proper swell, cream should be kept as near the freezing point as possible for twenty-four hours previous to freezing.

Where sweet, clean flavored cream is not obtainable, pasteurization is very essential. Pasteurized cream has better keeping quality and will also produce a better bodied ice cream when properly handled.

Pasteurize the cream at a temperature of from 140°

to 150° F., and hold at this temperature for 15 minutes. Then quickly cool and keep the cream as near freezing temperature as possible for at least 24 hours before freezing. Holding the pasteurized cream cold this length of time restores to a great extent the viscosity which it has lost in the pasteurizing process.

Cream can also be satisfactorily pasteurized in continuous pasteurizers, but greater care is necessary because of the higher temperature that must be employed. But even with the higher temperature the pasteurizing is bound to be less thorough than where the cream is held some time at a lower temperature.

**Freezing Process.** With an initial temperature of about 35° F., the time required to freeze ice cream should average about twelve minutes, and to get the best consistency the temperature at the close of the freezing process should be approximately 28° F.

Too quick freezing causes the water to separate from the cream, which results in a granular ice cream. Freezing too slowly reduces the overrun and tends to make the ice cream smeary.

To reduce the temperature of a mass of cream below the freezing point, requires a freezing mixture of a low temperature. Such a mixture is secured by mixing salt and crushed ice in the proportion of one of salt to about twelve of ice. The purpose of the salt is to lower the freezing point of the melting ice and to hasten the melting.

To melt one pound of ice at 32° F. into water at the same temperature requires 142 heat units. Rapidly melting ice, therefore, absorbs a large quantity of heat which in the freezing of cream is largely extracted from the cream.

The temperature of the ice cream mixture when starting the freezer should be as near freezing as possible to prevent churning the cream. The tendency to churn is also lessened by revolving the freezer slowly the first few minutes in freezing.

In packing the freezing mixture around the cream container, fill the freezer about half full of finely crushed ice and finish the filling by using salt and ice in the proportion of about one to six. As the ice mixture works down during the freezing process, continue adding more salt and ice as needed.

If the freezer is started while the cream is still warm (about 60° F.), the speed of the freezer must be kept down to about fifty revolutions until a temperature of about 35° F. is reached. After this the speed is increased to 150 to 200 revolutions per minute until the cream is frozen. This speed insures the proper incorporation of air and the desirable smoothness of the finished product.

The freezer should be stopped before the cream becomes too thick, else it will lose some of the air that has been incorporated as well as show a tendency to coarseness in texture. Yield and quality therefore demand that the freezer be stopped while the cream is still a trifle soft.

**Vanilla Flavor.** Of all ice cream flavors vanilla is the most popular. The majority of ice cream manufacturers use vanilla extract, but great care should be used in its selection as there are many different grades upon the market.

The best flavors are obtained from the Mexican vanilla beans, which are dark in color, measure 9 to 9½ inches in length, weigh about 1-6 of an ounce, and are oily and

pliable, so that they can be wound around the fingers. They must be very fragrant and closed, leaving none of the seeds exposed, which are the seat of much of the vanilla flavor. The lower grades of Mexican and other varieties of vanilla beans can easily be recognized by their length, as shown in the accompanying illustration.

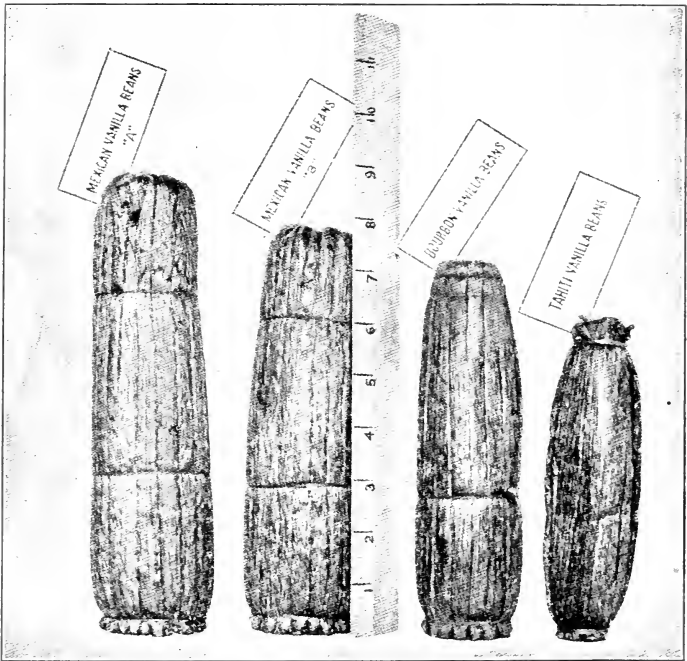

Mexican, Bourbon and Tahiti Vanilla Beans.

The finest vanilla flavor is secured by purchasing the best quality of Mexican vanilla beans and preparing them as follows:

Cut the beans in small pieces and grind them as fine

as possible with loaf sugar. Immediately after grinding, the vanilla sugar is bottled and corked and set aside until ready for use. On an average one bean is required per gallon of ice cream.

Add the vanilla sugar (sugar containing the ground beans) required for a given batch of ice cream to one or more gallons of the cream and keep the latter at a temperature of about 150° F. for five or ten minutes and then strain through three thicknesses of cheese cloth while still hot. While extracting the flavor with the hot cream the cream container should be kept covered as much as possible. The high temperature aids in extracting the flavor as well as aids in straining out the remnants of the beans. The seeds are very fine and require a very fine strainer to remove them.

Some grind up the beans and extract the flavor by means of alcohol, an ounce of the cut up beans being soaked in about ten ounces of a mixture consisting of equal parts of grain alcohol and water. The flavor of the alcohol and other spirituous substances used in the extraction of vanilla flavor, are objectionable and can be recognized in the ice cream.

The vanilla beans when prepared with sugar as suggested, not only produce a better flavor than is possible with extracts, but also cost less.

**Vanilla Ice Cream.** To make ten gallons of finished ice cream, requires about six gallons of cream to which should be added about nine pounds of sugar, or one and one-half pounds to the gallon. The sugar should be well mixed with the cream and allowed to dissolve before starting the freezer. Next add four ounces of vanilla ex-

tract or six best quality Mexican vanilla beans prepared as directed under "Vanilla Flavor," and freeze.

**Chocolate Ice Cream.** This can be made by adding chocolate flavor to finished vanilla ice cream. The chocolate flavor for ten gallons of finished ice cream is prepared as follows: Dissolve one and one-half pounds of bitter chocolate by placing it in a double boiler and adding a little water; then heat slowly working the chocolate to a smooth paste; add more water and work until the mass is smooth;\* add one pound of sugar, heat and work smooth; add more water, heat the mixture nearly to the boiling point and add one pound of sugar; stir and bring to a boil, care being taken not to scorch it. Nearly three pints of water are required to dissolve the chocolate.

In making a regular batch of chocolate ice cream, the chocolate is added before starting to freeze.

**Lemon Ice Cream.** In making lemon flavored ice cream, use the best paper-wrapped lemons, free from any signs of decay. Wash the lemons lightly in cold water and grate off the outer, yellowish portion of the rind, being careful not to grate off any of the white portion which is very bitter. Mix the grated rind with sugar, using one ounce of sugar for each lemon rind. Next cut the lemons in two and squeeze out the juice, removing any seeds that may have dropped in from the squeezer. Mix the juice with the sugared rind and add orange juice to the mixture, using one orange to every three or four lemons. Allow the mixture to stand for about one hour, stirring it occasionally, and then strain. Use at the rate of one-half pint per gallon of cream.

---

\*Bulletin No. 155, Vermont Experiment Station.



The flavor is added to the cream when nearly frozen to prevent curdling it. Use two pounds of sugar per gallon of cream.

**Walnut Ice Cream.** Use six gallons of cream, nine pounds of sugar, four ounces vanilla extract (or bean equivalent) and four pounds of ground walnut meats. Freeze the same as vanilla ice cream.

**Other Nut Ice Creams.** Chestnut, filbert, hazelnut, pecan, peanut and almond ice creams may be prepared essentially as walnut ice cream.

**Strawberry Ice Cream.** Use six gallons of cream, nine pounds of sugar and one-half gallon of crushed strawberries. The fruit should be added to the cream after it is partially frozen so as not to curdle the cream or to have the fruit settle to the bottom.

**Other Fruit Ice Creams.** Cherry, raspberry, pineapple, peach, apricot, currant, grape and cranberry ice creams are made the same as strawberry, except that the amount of sugar is varied according to the acidity of the fruit.

**Packing Ice Cream.** Remove the ice cream from the freezer while still in rather soft condition and put the same in packing cans which have been thoroughly chilled by having the ice and salt packed around them about ten minutes before receiving the ice cream. Most of the salt should be put near the top, the same as in freezing. The ice cream should be held in the packing cans at a temperature below 20° F.

Remove the brine and repack often enough to prevent melting. In the melting process the water separates and forms undesirable crystals when the cream is refrozen.

Always repack with a new freezing mixture just before the ice cream leaves the creamery.

**The Use of Gelatin or Binders.** Many look upon gelatin as an adulterant in ice cream and in some states its use is prohibited by law. It is true that the highest quality of ice cream is produced without the use of gelatin, still, under commercial conditions, the use of a limited amount of good gelatin has been commended for several reasons:

1. It prevents, to a great extent, the granulation or crystallization of the ice cream that usually occurs with advancement of age. Ice cream without any binder, such as gelatin, will become coarse and granular and the older the ice cream, the more aggravated this condition becomes. This, however, is the very reason why the use of gelatin has been condemned by many in the past. Where no gelatin is used the extent of crystallization is an indication of the age of the ice cream, thus affording protection to consumers against old ice cream.

2. Gelatin assists in maintaining the body of the ice cream under comparatively high temperature conditions. Ice cream without any binder will immediately become soft and mushy on exposure to a high temperature, a condition which materially lessens the palatability of the cream. The advantages thus afforded by the use of gelatin have some disadvantages, so far as the consumer is concerned, in that the ice cream can be held under temperature conditions which favor the development of the various kinds of organisms usually present in ice cream.

Where gelatin is used, place the gelatin in a double boiler, add two or three quarts of cream and heat, stirring until the gelatin is all dissolved. Next strain the

hot gelatin mixture into the regular batch of cream to be frozen and thoroughly mix. In melting the gelatin the heating should be stopped as soon as melted to prevent danger from curdling the gelatin.

**The Overrun or Swell.** This refers to the excess of ice cream over cream. Anything that tends to incorporate and hold air in cream conduces to a large overrun. Thus excessive beating of the cream during freezing mixes a great deal of air with it, and hence, increases the overrun. A high viscosity of the cream holds the air incorporated during freezing. Fresh separator cream has a low viscosity, that is, does not whip well, hence will not swell up so much in freezing as cream that has been kept cold for twenty-four hours. Pasteurized cream also has a low viscosity, but this will improve by keeping the cream at a low temperature a number of hours before freezing.

An overrun of from 60 to 70 per cent is large enough. Overruns approximating 80 to 90 per cent are obtained at the expense of quality.

**Cost of Ice Cream.** The cost of making ice cream will depend largely upon the richness and cost of the cream, the amount of overrun, and the kind and quantity of ice cream manufactured. An average ten-gallon batch of vanilla ice cream made in a creamery will cost approximately as follows:

6 gallons of 20 per cent cream.....	\$3.36
9 pounds sugar .....	.50
4 ounces vanilla .....	.30
3 ounces gelatin .....	.10
Ice and salt .....	.70
Labor and power .....	1.00

---

\$5.96

Total cost per gallon, 59.6 cents.

The six gallons of cream would weigh approximately forty-eight pounds and contain 9.6 pounds of butter fat. Valuing butter fat at 35 cents per pound, the cost of the cream used will be \$3.36, as stated above.

Where 100 or more gallons of ice cream are made daily, and cream containing, say, 15 per cent butter fat is used, the cost of a gallon of ice cream will be about 45 cents.

The gelatin may be omitted.

**Marketing Ice Cream.** The essential thing in building up a good ice cream trade is to make the best product possible. The market is glutted with cheap, inferior ice cream, and the call now is for a high grade product. Fortunately the public is beginning to realize that there is positive danger in eating ice cream made from old, stale milk or cream, and the public also seems to begin to understand that the bulk of ice cream is made with so-called thickeners, like gelatin, corn starch, tapioca, arrow root, and others. Many so-called ice creams contain no cream whatever. The highest quality of ice cream contains nothing but good, pure cream, sugar and flavoring.

Creameries making ice cream are not limited to their own home town as a market for this product. With proper refrigeration, ice cream may easily be shipped several hundred miles. A great deal of the ice cream consumed in Charleston, S. C., is shipped from New York. New Orleans gets much of its ice cream from North Carolina, Virginia and Tennessee.

If you haven't sufficient market near home for your ice cream, don't hesitate to ship it several hundred miles. Study the available markets, small and large, and keep reaching out until you have market for all of your product.

## CHAPTER XXXIV.

### EGGS AS A CREAMERY SIDE LINE.

The creamery is just as much the logical market for the farmer's eggs as it is for his milk and cream. In all essential respects the egg situation today is similar to the butter situation before the days of creameries. The United States government estimates that forty-five million dollars are lost annually on eggs which are spoiled through improper methods of handling. Similar losses used to be sustained on dairy butter owing to poor quality and poor markets. The country grocery is just as much the wrong market for eggs as it is for butter.

It has long been known that farmers who make good butter cannot afford to sell it to the local grocer because such butter commands no better price than poor butter. That is, the grocer figures on making up losses on poor butter by cutting the price of good butter, and hence establishes an average price for all which is considerably less than that received for creamery butter.

The egg situation is similar to that of dairy butter. At the country grocery, poor eggs command the same price as good ones. This is one reason why so many eggs are spoiled when they reach the grocer, who, in turn, allows many more to spoil by holding them too long at high temperatures. A further objection to selling eggs at the local stores is that cash, as a rule, cannot be realized for them.

**Preventable Losses in Eggs.** In placing the annual

loss of spoiled eggs at forty-five million dollars, the U. S. Department of Agriculture\* estimates this loss on the basis that 17% of the total egg crop is spoiled from the following causes:

Dirties .....	2	per cent.
Breakage .....	2	per cent.
Chick development .....	5	per cent.
Shrunken or held eggs.....	5	per cent.
Rotten eggs .....	2½	per cent.
Moldy and bad flavored eggs.....	½	per cent.
	<hr/>	
Total .....	17	per cent.

About half of these losses could be prevented by handling the eggs through the creameries. This would mean a saving of over twenty-two millions of dollars annually.

**Creamery a Successful Market.** Many creameries in Denmark and the United States are successfully handling the farmers' eggs at the present time. Indeed so successful has this creamery side line proven that it is safe to predict that the bulk of the eggs produced in proximity to creameries will eventually be marketed through the creameries.

#### METHOD OF HANDLING AND BUYING EGGS.

**Gathering the Eggs.** The eggs, of course, are to be delivered or gathered with the milk and cream, and the oftener the better. Where the milk and cream are delivered to the creamery by the producer, the cost of delivering the eggs would amount to practically nothing, since it is more than likely that the milk wagons as ordinarily run have enough spare room to accommodate the eggs without extra trouble. The eggs should be delivered daily, if possible.

\*Circular No. 140, U. S. Department of Agriculture.

The larger egg producers can be provided with regular sized cases while the smaller ones can use the special egg carton in which to deliver the eggs. Or the eggs can be transported in baskets, etc., just as they are when taken to the village grocer. On cream routes the driver will carry the eggs in cases, and in order to know each patron's eggs when they are being candled, it will be necessary for the driver to place a piece of paper with the producer's name on it over each lot of eggs as they are put into the case. In this way a number of patrons can use the same case without getting the eggs mixed up.

**Paying for the Eggs.** As a rule eggs are paid for on delivery to the creamery, or where the cream hauler gathers them he pays for them on the route. This method of paying for eggs has proved very satisfactory. It is possible, however, to pay for eggs at intervals the same as for milk and cream.

The price paid varies. Most creameries are able to buy the eggs at prevailing store prices and some pay even less. Where the farmer guarantees the quality, the creamery can afford to pay above store prices, provided that a good market has been established for the eggs.

**Handling Eggs at the Creamery.** Egg shells are porous and will absorb water, dirt, odors and bacteria. This should emphasize the importance of keeping eggs in a clean, dry place, free from odors. It is well known how quickly eggs spoil at high temperatures. The putrefactive bacteria are in the eggs, and the higher the temperature at which they are kept the more rapid will be the development of these bacteria and the quicker the eggs will spoil. Eggs should be kept as near 32° F. as possible to preserve them in the best possible condition.

Those who are handling eggs as a side line should handle them just as they do cream, because the same conditions that will spoil cream will spoil eggs.

It seems important to have the eggs from each patron examined at the creamery before shipping. Some eggs are bound to be received in an unsatisfactory condition and if any complaint is to be offered this will likely be received with better grace from the buttermaker than from some unknown buyer at the other end of the line. Besides it is a business proposition for the seller to know the condition of his goods before selling them, so that he may know what price they ought to command in the market. Furthermore where eggs are bought from many different sources suggestion for improvement in the condition of the eggs should come from as near the source as possible.

#### TESTING (CANDLING) AND GRADING EGGS.

During the summer months at least, the eggs should be tested (candled) at the creamery, and this is a comparatively simple matter.

To test the quality of an egg it is held in front of a strong light or flame, which enables one to note the condition of its contents. A simple testing outfit consists of a piece of stove pipe with two holes cut into it about the size of a silver dollar, the holes to be in a horizontal plane about one inch apart and right opposite the flame. The only objection to the stove pipe is that it radiates too much heat. A wooden box lined with tin and provided with a lamp makes a very satisfactory tester. The chimney of the lamp, of course, should be allowed to project through the top of the box. A 16 candlepower elec-



tric lamp will be found superior to a kerosene lamp and should be used wherever possible. Any variety of testers may be purchased upon the market at present at a very small cost.

The tester should be placed in a fairly dark room; the darker the room the more effective the light from the tester.

In testing an egg it is held in front of the flame, large end upward, and then turned quickly, so that the entire contents may be viewed. An expert candler holds two eggs in each hand and with a deft movement turns one in each hand at the same time. Where the eggs average fairly good in quality, an expert tester can test as many as 1,000 dozen in one day.

**Appearance of a Good Egg.** A good, fresh egg when held in front of the opening of the tester, looks clear, having the appearance of being devoid of any contents. Often, however, the shell presents a speckled appearance, which, however, does not disqualify the egg.

**Defects Seen by the Tester.** Since more eggs are damaged by heat than by any other agency, the tester is always on the lookout for heated eggs. Heat causes development of the germ, and eggs showing germ development are usually known as "floats."

Defects found in eggs are commercially classified about as follows:

1. **Light floats**, which are eggs lightly heated, causing the yolk to appear much darker than that of a fresh egg, giving it the appearance of a dark spot.

2. **Heavy floats** are eggs having the defects noted in light floats intensified.

3. **Blood Rings** indicate a still more heated condition,

and this fault extends to the point where chicks become visible.

4. **Chicks**, of course, indicate the last stage in the deterioration of eggs from heat.



Candling eggs and grading them according to quality: No. 1, No. 2, Checks, Dirties and Rots.

5. **Stale** eggs are those in which the outline of the yolk is plainly visible, sometimes presenting a muddy appearance, and the air cell is very large.

6. **Rotten** eggs present a very dark, muddy appearance, having the yolk and white mixed and a large air cell, sometimes movable.

7. **Checks** are eggs more or less cracked and presenting white lines showing irregularities in the shell.

8. **Moldy** eggs show mold along the checks, which are sufficiently large for mold to feed on the contents of the eggs. If placed under conditions favoring mold, eggs will mold even when the shell is entire.

9. **Shrunken** eggs are those from which a certain amount of water has been evaporated, thus showing a noticeable shrinkage in the contents.

To become proficient in testing eggs it is desirable to spend at least one day with an expert tester. Or, if this is not possible, a number of eggs should be broken in order to verify any suspected defects as seen through the tester.

**Conspicuous Defects.** In the customary market grading of eggs a number of objectionable features are taken into consideration other than those already considered, but which do not require the aid of a tester. Among these should be mentioned size and cleanliness, checks and leakers, manner of packing, character of package, color and whether washed or not.

Washing eggs favors the entrance of bacteria and molds and should, therefore, be avoided as much as possible. If dirty, eggs should be wiped with a moist cloth.

**Grades of Eggs.** Eggs are commonly graded into firsts, seconds, checks, dirties and rots. The big markets, however, recognized many different grades as illustrated by the following quotations from the New York market:

Fresh gathered, extras, per dozen.....	21	@24
Fresh gathered, extra firsts .....	18	@19½
Fresh gathered, firsts .....	16	@17

Fresh gathered, seconds .....	13½	@15
Fresh gathered, thirds .....	12	@13
Fresh gathered, very poor .....	8	@11
Fresh gathered, dirties, No. 1.....	11	@12
Fresh gathered, dirties, No. 2 .....		@10
Fresh gathered, dirties, poor to fair.....	6	@ 9
Fresh gathered, checks, good to prime.....	8	@10
Fresh gathered, checks, poor to fair, case.....	3	@ 8
State, Pa. and nearby, Hennery whites.....	22	@28
State, Pa. and nearby, gathered whites.....	21	@25
Western, gathered whites .....	17	@21
State, Pa. and nearby, Hennery browns.....	22	@24
State, Pa. and nearby, gathered brown and mixed colors .....	16	@21

## SELLING EGGS.

Creamerymen know that the best prices for butter are realized by selling it to retailers, or possibly to consumers direct. In selling eggs the same rule applies and, perhaps, even more forcibly. First of all then aim to sell the eggs as direct to the consumer as possible. Remember that fancy grocers, jobbers, restaurants, hotels, etc., like to buy eggs as direct as possible from the producer, not so much to get an advantage in price as to get fresh eggs. And who would be in a better position to furnish fresh eggs than the creamery which buys direct from the producer and can ship perhaps several times a week? If the creamery will carefully examine all eggs received by it, it will put itself in a position to attract the best buyers of eggs everywhere.

At present most of the eggs are bought by the wholesale and commission houses in the large cities, just as is the bulk of the creamery butter. Most of the buyers

from whom good prices may be realized for butter also buy eggs, and both might be sold to mutual advantage when shipped to the same buyer.

**Stamping the Eggs.** All creameries do not test or candle the eggs but require each farmer to stamp his eggs, so that in case complaint is made by buyers regarding the quality of some of the eggs, the stamp at once shows who produced them. In one creamery\* where this method of stamping is followed, the eggs are graded only as to size and color and the results have been very satisfactory. The eggs from this creamery were all sold to one retailer in a medium sized city at several cents above the market price. Only two complaints were made, during eighteen months, concerning the quality of the eggs.

**Cost of Handling the Eggs.** As a rule the farmers are supplied with cartons in which to deliver the eggs and the cost of these per dozen of eggs is about one-half cent. The cost of the labor in handling the eggs at the creamery has been found to average one-half cent per dozen. The entire cost to the creamery of handling the eggs will, therefore, amount to approximately one cent per dozen. This, of course, does not include transportation charges.

---

\*Farmers' Bulletin 445. U. S. Department of Agriculture.

## CHAPTER XXXV.

### CREAMERY BY-PRODUCTS.

#### SKIM-MILK AND ITS PRODUCTS.

**Skim-milk as a Feed.** This is a question in which creamerymen should take greater interest because, as a rule, the feeding value of skim-milk is underestimated. Feeding trials show that five pounds of skim-milk are equal to about one pound of grain (corn, barley, oats). They also show that on an average four pounds of grain will produce one pound of gain with young pigs, while five pounds will produce the same gain with pigs from six to twelve months old. On this basis twenty pounds of skim-milk are required to produce one pound of gain with young pigs and twenty-five pounds with older pigs. With pork at 8 cents a pound, one hundred pounds of skim-milk will produce 40 cents worth of pork with young pigs and 32 cents worth with older ones.

The amount of skim-milk required to produce a pound of veal is shown by feeding trials to range on an average from fifteen to twenty pounds. Taking the latter figure and valuing veal at 7 cents a pound, skim-milk is worth 35 cents per 100 pounds for veal production.

The highest returns from the feeding of skim-milk are secured when fed to poultry. Careful experimental tests show that as high as 75 cents per 100 pounds may be realized for skim-milk when fed to poultry.

For composition of skim-milk, see "appendix."

**Skim-milk as a Fertilizer.** Many who are selling the skim-milk off the farm do not sufficiently appreciate the fertilizing value of this material. At the lowest estimate skim-milk has a fertilizing value of ten cents per hundred pounds.

**Cottage Cheese Making.** A creamery side line that has received altogether too little attention in the past is the manufacture of cottage cheese from the surplus of creamery skim-milk and buttermilk. The demand for this class of cheese is rapidly increasing and no one is in better position to make this cheese than the creameries. Cottage cheese is a cheap, wholesome food which, in these days of high food prices, is eagerly sought by a large class of consumers. A number of creameries are already making cottage cheese and others should not be slow to profit by their example.

Put the skim-milk in a vat and sour it with a good starter at a temperature of between 90 and 95° F. The more starter used, up to 25 per cent, the better the quality of the cheese. Thoroughly mix the starter with the skim-milk and allow to remain undisturbed until firmly curdled. When this stage is reached, cut the curd, the same as in cheddar cheese making, and at once begin stirring by hand. Raise the temperature to 104° F., keeping the curd constantly stirred during the heating process. After this the curd should be stirred occasionally for about 40 minutes, when the whey may be drained off.

The draining is best accomplished in a tin strainer covered with a piece of cheese-cloth. The curd must be hand-stirred as soon as it has been dumped into the strainer, but the stirring should be done very gently at the start to prevent loss by mashing the curd particles.

Continue the stirring until the curd is firm enough to prevent the particles sticking together, which usually requires about five minutes. As soon as the curd has been stirred dry enough it is wrapped in the cloth strainer and squeezed with the hands until most of the free whey has been removed, that is, until it is dry enough to permit granulating it to fine particles by rubbing with the hands.

When the curd has been squeezed dry enough and thoroughly granulated by rubbing and stirring with the hands, it should be salted at the rate of about one and one-half ounces of salt per ten pounds of curd. After salting the curd is soaked with skim-milk or milk; or where a high quality of cheese is desired a thin cream should be used.

The amount of milk used for soaking varies somewhat from day to day, depending upon the amount of moisture left in it at the time of salting. The rule to follow is to leave the curd fairly moist, but not so moist as to have the milk drip from it.

If the cheese is intended for bakers, it need not be squeezed and soaked as above described. It is simply allowed to drain until enough moisture has been removed to permit packing it.

**Marketing Cottage Cheese.** Where cottage cheese is made on a fairly extensive scale most of it is packed in sixty-pound tubs in the same manner as butter. Dealers buying the cheese either retail it from the tubs or sell it to bakers. In some cases it is packed in small pasteboard boxes holding from one to two pounds. Others mold the cheese into prints with a butter printer and wrap it in parchment paper. The prints are often cut in two before wrapping, thus making half-pound packages.



Fifteen to sixteen pounds of cottage cheese are obtained from one hundred pounds of skim-milk, and the cheese retails at from five to fifteen cents per pound.

**Skimmilk-Buttermilk.** To ordinary skim-milk add from 20 to 25% starter and sour at a temperature of from 65 to 70° F. When thoroughly curdled, churn the same as cream. Fifteen minutes churning is usually sufficient. Next cool to 45° F. or below and strain. Soda fountains prefer this skimmilk-buttermilk to ordinary buttermilk, being of better flavor and heavier consistency. The less the skim-milk is churned the heavier the consistency.

Skim-milk containing about one per cent of fat makes a more palatable buttermilk than pure skim-milk and retails at from five to ten cents per quart.

**Commercial Casein Making.** In some sections where the creameries receive much whole milk, a great deal of the skim-milk is converted into casein which nets the farmers approximately twenty cents per hundred pounds of skim-milk. The process of manufacturing casein is essentially as follows:

Place the skim-milk in a vat and heat it to a temperature of from 120 to 130° Fahrenheit; then add at the rate of about one pint of commercial sulphuric acid per thousand pounds of skim-milk. Thoroughly mix and in a short time the whole mass is coagulated. As soon as thoroughly curdled, the whey is drawn off, the curd placed in a strong, heavy cloth and then pressed. Usually an upright press is used in which the curd remains over night. The next morning the pressed curd is ground up fine and spread upon trays which are piled about twenty deep on special trucks which, in turn, are run into a dryer about four feet high, three feet wide and twenty

feet long. At one end of this dryer is a steam radiator which heats the air that is forced over it by means of a blower. After about twenty-four hours of drying, the dried casein is packed in grain bags and shipped to casein companies.

**Lacto.** This is a frozen sour skim-milk product\* which has proven very popular. The skim-milk for lacto is prepared in the same manner as for starter. Indeed a first class starter furnishes the best milk for this product. The following are a few of the formulas used for making lacto:

**Cherry Lacto:** 3 gallons lacto milk, 9 pounds sugar, 12 eggs, 1 quart of cherry juice or concentrated cherry syrup, 1½ pints lemon juice.

**Orange Lacto:** 3 gallons lacto milk, 11 pounds sugar, 12 eggs, 2½ quarts orange juice, 1½ pints lemon juice.

**Grape Lacto:** 3 gallons lacto milk, 9 pounds sugar, 12 eggs, 1 quart grape juice, 1½ pints lemon juice.

In making up the mixture for the different formulas, the following procedure is recommended:

The sugar is first dissolved in the lacto milk. The eggs are then prepared. The whites and yolks are kept in separate containers and each lot is beaten with an egg beater. Both the yolks and whites are then added to the milk. The mixture is thoroughly stirred and strained through a fine wire gauze. The fruit juices are added last. If there is any indication of the juices precipitating the casein, they should be left out until the mixture has begun to freeze, when they may be added. The freezer is now run until it turns with difficulty, when the paddle is removed. The brine is removed and the freezer re-

---

\*Bulletin No. 118, Iowa Experiment Station.

packed with ice and salt and left for an hour before the contents are served.

Buttermilk has not proven very satisfactory for making a high quality lacto.

#### BUTTERMILK AND ITS PRODUCTS.

**Buttermilk as a Feed.** Buttermilk has essentially the same composition as skim-milk. It contains a little more fat, but less sugar, part of which has been changed into lactic acid. For pig feeding, except in the case of very young pigs, it has practically the same feeding value as skim-milk, as shown by numerous feeding experiments. It is also a good poultry feed. It can not be recommended, however, for calf feeding, though it has been used with fair success in some instances. See "Skim-milk as a Feed," page 326.

**Cottage Cheese from Buttermilk.** By mixing at the rate of one pound of skim-milk to about five pounds of buttermilk, cottage cheese can be made from buttermilk in essentially the same way as from skim-milk.

Cottage cheese can be made from buttermilk without the addition of skim-milk, by a special method which originated at the Wisconsin Dairy School. The method is briefly as follows:\*

The buttermilk is curdled by heating it to 80° F. and then allowing it to stand undisturbed for one hour. It is then heated to 130° and after standing quiet for about an hour, the clear whey is drawn off the curd, and the latter is placed on a draining rack, which is covered with cheese-cloth. Here it remains half a day or over night, until as dry as desired, when it is salted at the rate of

---

\*Bulletin No. 211, Wisconsin Experiment Station.

one and one-half pounds of salt per hundred pounds of curd. The curd is then ready for use.

Cream containing 50 per cent or more fat, as well as buttermilk from cream which has been pasteurized when very sour, is not suitable for making buttermilk cheese by the Wisconsin method. The curd from such buttermilk is always so fine grained that it runs through the draining cloth and is lost.

**Buttermilk as a Drink.** The question has often come up as to whether it pays a creamery to cater to the buttermilk trade. In this connection it might be said that many creameries have sold buttermilk to advantage in the past, catering to hotels, lunch rooms and soda fountains. Buttermilk as a beverage is becoming more and more popular and good prices can often be realized for it where it can be delivered in good condition. This is a matter it will pay every creamery to investigate. Buttermilk cooled to 40° F. and placed in insulated cans can be shipped satisfactorily a considerable distance.

## CHAPTER XXXVI.

### ADVICE TO YOUNG BUTTERMAKERS.

Most of those who enter the field of butter making and cheese making do so with the laudable ambition of ultimately reaching the highest position possible in their chosen work. Many, however, fail to achieve their ambition because they either ignore or underrate the importance of matters which are absolutely essential to the success of their business. Some of the most important of these matters will be discussed in the following paragraphs:

**Overcoming Obstacles.** In taking hold of a creamery there are sure to be encountered some features which are objectionable to the maker. The churn may not be to his liking, the vats may not suit, the patrons may seem disgruntled about one thing or another, and many other matters may be displeasing. Under such conditions the weakling, who always remains at the bottom, will keep up an incessant wail about conditions and spend valuable time in looking for an "easier job"—time that should be spent in overcoming the difficulties under which he is laboring.

The man that is made of the right stuff will not only not complain when placed under trying conditions, but will actually welcome them. It is the adverse conditions that afford the best opportunity for making a "showing."

**Honesty and Reliability.** An employer prizes honesty and reliability above any other qualifications the em-

ploye may possess. A man who cannot be depended upon is worthless in any business.

In a creamery great losses may be suffered through lack of responsibility on the part of the buttermaker. Any act of the buttermaker which indicates that he is shirking responsibility will destroy his usefulness in the eyes of his employer. It is easy for a careless man to waste a pailful of cream or double the loss of fat in the buttermilk, and any indication of shirking, no matter how trivial, will lead employers to suspect all kinds of waste and extravagance.

**Courtesy and Tact.** These qualities are indispensable in retaining and increasing the patronage of the creamery. The first thing a business man asks of his employes is to be courteous to his customers. Courtesy is one of the keynotes to success in the business world. Greet the patrons with a smile and a few good words whenever you meet them. It is a paying proposition. "Smile and the world smiles with you."

**Punctuality.** It pays to be on time. People realize this when they expect to meet a train which they know will not wait for them. But because patrons will wait for you when half an hour or so late in the morning is no reason why the same efforts should not be made to meet them as promptly as you would your train. Many a creamery has lost patronage because of the tardiness of buttermakers. Time is valuable to farmers and they want to get away from the creamery as quickly as possible.

**Cleanliness.** Cleanliness is recognized as the first essential in the manufacture of good butter. Indeed where strict cleanliness is not observed the production of a high grade of butter is impossible. It is especially important

to have the creamery and surroundings in a cleanly condition, because of the object lesson it affords to patrons in the matter of cleanliness. Patrons cannot be expected to bring clean milk in clean cans while the factory and surroundings are in anything but a cleanly condition.

**Keeping Records.** A careful record which shows the complete transactions of the creamery, is absolutely necessary. Many a creamery has failed to prosper because of confusion and dissatisfaction resulting from poor records. Nothing in any business can be trusted to memory. As soon as transactions of any kind occur they should be recorded on paper.

**Practicing Economy.** There are many buttermakers and cheesemakers who obtain excellent results from the sale of their butter and cheese, but who are too indifferent concerning the expense of securing these results. Every factory and creamery owner has a pretty fair idea of the running expenses of his plant, and when a new maker takes hold of the business his expenditures in the matter of fuel and supplies are compared with those of his predecessor. It is an easy matter to save 30 per cent in the fuel bill by proper management of the boiler and careful use of steam, and there is nothing that appeals so much to an employer as economy. The maker who can run his plant with 30 per cent less fuel than that required by his predecessor is sure of a promotion. Employers realize the value of such a man and will be loath to lose him.

**Control Your Temper.** The management of fifty or more patrons is a difficult task under the most favorable conditions, and woe to the maker who is easily irritated by trifling matters and will "talk back" when doing so

will only aggravate matters. "Kickers" are found among the patrons of any creamery, and if reason and kind persuasion cannot reform them, loud arguments certainly cannot. It is always better to ignore the kickers than to say things that will irritate them.

Many men are naturally irritable, but there are few who cannot learn to control their temper. This is an education that each man can give himself and is of first importance in controlling a set of patrons. The main thing to learn in this connection is to say nothing when most prompted to say something that is likely to hurt someone's feelings.

**Accuracy.** Worlds of trouble have been caused and many a creamery and factory ruined through careless weighing and testing of milk and cream and in making mistakes in calculating dividends. Patrons as a rule are naturally more or less suspicious, and when a mistake is made inadvertently, the patron is likely to consider it as a deliberate "cheat."

Knowing this, it behooves the maker to be extremely careful in giving accurate weights and figures. A shortage of one pound of milk means little financially to the farmer, but it is sufficient to lead him to look with suspicion upon the conduct of the entire affairs of the creamery. Imagine your going to the grocer for a pound of sugar, and on weighing it found you got only 14 ounces. You will probably buy your sugar elsewhere in the future. The patron who finds his cream or milk weights short, even if this occurs only once in six months, is likely to send it elsewhere or will cast reflections upon the honesty of the creamery's transactions.

Inaccuracies in calculating dividends breed dissatis-



faction among the patrons. Rather than run the chance of a single mistake, it will pay to run over the entire figures again. Accuracy in figures is one of the first principles recognized by business men everywhere. They realize the futility of building up a business where accuracy in figures is lacking. This is no less true in running a creamery than in any other business.

In weighing out butter to the patrons, special care must be exercised in getting accurate weights. The butter should be weighed to ounces and, not as some do, to a quarter of a pound. To mark a jar of butter  $3\frac{1}{4}$  pounds when it weighs only 3 pounds 2 ounces is certain to cause trouble sooner or later.

**When "Silence Is Golden."** Many are the times when "silence is golden" in the management of creamery patrons. A man living in the midst of dozens of people with whom he is doing business, cannot afford to make disparaging remarks about any of them, no matter how great the provocation or temptation. Remember that whatever you may say about a patron is certain to reach the ears not only of that patron, but those of others as well. There are always dissatisfied patrons and the only safe policy to pursue in regard to them is to pass them over in silence.

Many a business man has ruined his career by talking too much about his customers. Remarks may be ever so truthful, but it does not pay to pass them along, even to your friends, if their publicity can in any way injure your business.

If a patron, through ignorance or otherwise, should prove abusive, pass the matter over as unworthy of note and don't make "a fuss" to others about the matter. The

man who continually carries "a chip on his shoulder" is unqualified for any kind of business.

**Keep Posted.** Read and study the best books and dairy papers published on the subject. No man however well trained can keep up-to-date on any subject unless he continually reads the current news relating to that subject. The modern trend of affairs in creamery conditions calls for increasingly greater knowledge on the part of creamery operators. Not only is greater expertness in the handling and management of milk and cream required, but a broader knowledge is necessary to cope successfully with modern competitive conditions in the creamery world.

Conventions should be attended and active participation taken in educational butter scoring contests. In fact no one can afford to miss anything that is intended to make him more proficient in his business.

One thing that holds many buttermakers down is the idea that they have only to concern themselves with making good butter. The matter of learning the best methods of marketing butter and ways and means of increasing the patronage of the creamery cannot well be overlooked. Indeed a man cannot be called a full fledged buttermaker until he also understands everything in connection with the economical production of clean milk.

## CHAPTER XXXVII.

### GASOLINE POWER.

The use of gasoline power for creameries has long since passed the experimental stage. Dozens of creameries are now using gasoline engines and with the best of satisfaction. It is certain that even though the creamery has a steam engine, a small gasoline engine would more than pay for itself in the great convenience as well as saving it affords.

But what has lead so many creameries to turn their attention to gasoline power is the increasing cost of wood and coal, and the relative cheapness of gasoline as a source of power.

A gasoline engine has the following advantages over a steam engine: (1) Saves fuel; (2) requires less attention; (3) is more convenient; (4) requires smaller boiler; and (5) is handier in fire emergency.

**Saving of Fuel.** Average data secured from competent engineers as to the relative economy of steam, gasoline, and crude illuminating gas may be briefly stated as follows:

1. When coal is worth \$4.50 per ton, steam power will cost 1.8c per brake horse power per hour.
2. When gasoline is worth 10c per gallon, gasoline power will cost 1c per brake horse power per hour.
3. When gas producers are used, the cost per brake horse power per hour is 1-6c.

The above figures show that at the prices indicated for coal and gasoline, the fuel cost with a steam engine is 80 per cent greater than with a gasoline engine, and 1080 per cent greater than with a gas producer. It is necessary to add, however, that gas producers are not practical where engines of less than 40 or 50 H. P. are required.

The testimony of dozens of creameries who are using gasoline power, indicates that gasoline costs approximately only half as much as coal to produce a given amount of power.

**Saving Time.** The reason that gasoline power requires less attention than steam power is due to the fact that the former runs independently of a boiler. This is a very important advantage, especially in a skim station where one man attends to the weighing and sampling of the milk, watches the milk heater and separator, attends to the injector and the firing of the boiler, and does a dozen or more odd jobs, which may incidentally come up in connection with the regular routine work. Here a good gasoline engine would unquestionably be a great advantage, as it would relieve the operator from the constant care of the boiler necessary during the running of the machinery.

**Convenience.** Regarding the convenience of a gasoline engine, this will be apparent when we consider that it may be started any time in a very few moments. A steam engine cannot be started without a certain steam pressure in the boiler. About an hour of firing is, therefore, required in the morning before power is available for separating or churning. With a gasoline engine the

machinery may be started as soon as the buttermaker gets into the creamery.

Another matter to be considered in this connection is the necessity of keeping up steam for cooling cream in the afternoon, especially where much hand separator cream is received. With gasoline power this is not necessary. Also much cream is churned at too high a temperature because it must go into the churn in the morning before there is enough steam to pump water. With a gasoline engine cooling may be begun as soon as the buttermaker enters the creamery in the morning.

**Other Advantages.** It is evident also that a smaller boiler would answer in a creamery where the machinery is run with gasoline power. This would mean a saving in both space and original cost of boiler.

In case there is no special storage of water for fire emergencies, a fire would be difficult to extinguish if it occurred at a time when no steam pressure was available. A gasoline engine can be started at any time and might therefore be of much service in a fire emergency.

**Heating Water.** This discussion would not be complete without considering the possibilities of utilizing the waste heat from the gasoline engine for heating the necessary wash water and feed water for the boiler. Statements from engineers and observation lead to the belief that this could be done very satisfactorily with gasoline engines. By sinking a water tank in the floor of the engine room near the boiler and providing this with a suitable muffle, most of the heat from the exhaust could be recovered by running the exhaust pipe through this tank. Water thus heated could be used for the boiler and other purposes. For washing and cleaning

purposes, the cylinder would undoubtedly supply enough heat to furnish the necessary hot water. In most gasoline engines water is kept circulating around the cylinder which will heat a considerable quantity of water.

## CHAPTER XXXVIII.

### DETERMINATION OF SALT IN BUTTER.\*

Weigh out 10 grams of butter exactly as is done in moisture determinations. Put the butter in a pint composite milk jar and add 250 c.c. of warm water. Some

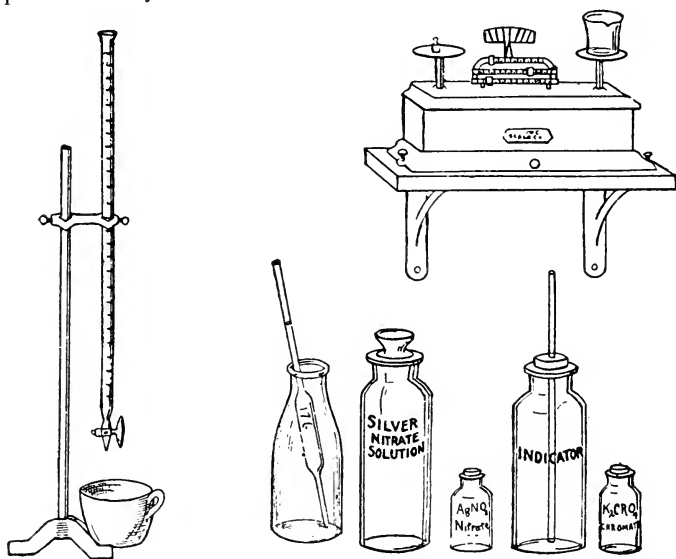

Apparatus needed in salt determination.

of this water is used to rinse out the cup in which the butter was weighed, the rinsings being returned to the pint jar. Shake the jar with a rotary motion to wash the salt out of the butter. When sure that the salt has all

\*Circular 14, Wisconsin Experiment Station.

been washed out, put the jar down and allow to remain quite a few minutes, or until all the fat floats on top of the water. The salt contained in the butter is in the clear liquid below the fat.

Now remove 17.6 c.c. of the clear liquid by inserting a pipette through the layer of fat, blowing through it as the point passes through the fat to keep the latter out of the pipette. Put the sample thus selected in a white tea cup and add one drop of "indicator" prepared as directed below. Next add, from a burette "silver nitrate solution" prepared as explained later on. Shake the cup after each addition of the nitrate solution. Continue adding small quantities of silver nitrate solution until a faint red color is produced, which remains after shaking. Every c.c. of silver nitrate solution added represents 1 per cent of salt in the butter. For example, if 3.5 c.c. of solution are required to produce the faint red color, the butter contains 3.5 per cent salt.

**Silver Nitrate Solution.** This is prepared by dissolving 5.1 grams of chemically pure silver nitrate crystals in 250 c.c. of pure water. The silver nitrate solution should be preserved in a brown, glass stoppered bottle. The brown glass protects the solution from light which decomposes it. Keep the solution in a dark place when not in use. Owing to the tendency of the solution to lose strength, it is best to make up a new solution at least once in two months.

**Indicator.** The indicator is prepared by dissolving one ounce of chemically pure potassium chromate in 100 c.c. of water.



## APPENDIX.

**Composition of Butter.** According to analyses reported by various experiment stations, American butter has the following average composition:

	Per cent.
Water .....	13
Fat .....	83
Proteids .....	1
Salt .....	3

**Composition of Cream.** Cream contains all the constituents found in milk, though not in the same proportion. The fat may vary from 8% to 68%. As the cream grows richer in fat it becomes poorer in solids not fat. This is illustrated in the following figures by Richmond:

Total solids.	Solids not fat.	Fat.
Per cent.	Per cent.	Per cent.
32.50	6.83	25.67
37.59	6.14	31.45
50.92	5.02	45.90
55.05	4.65	50.40
57.99	4.17	53.82
68.18	3.30	64.88

The same authority also reports the following detailed analysis of a thick cream:

	Per cent.
Water .....	39.37
Fat .....	56.09
Sugar .....	2.29
Proteids .....	1.57
Ash .....	.38

**Composition of Buttermilk.** According to Vieth, buttermilk from ripened cream has the following composition:

	Per cent.
Water .....	90.39
Fat .....	.50
Milk sugar .....	4.06
Lactic acid .....	.80
Proteids .....	3.60
Ash .....	.75

Creamery buttermilk should not average above .2% fat.

**Composition of Skim-milk.** Richmond has found the following average composition of separator skim-milk:

	Per cent.
Water .....	90.50
Fat .....	.10
Milk sugar .....	4.95
Casein .....	3.15
Albumen .....	.42
Ash .....	.78

COMPARISON OF CENTIGRADE AND FAHRENHEIT THERMOMETER SCALES.

Thermometer.	F.	C.
Boiling point (water).....	212	100
Freezing point (water).....	32	0
Difference between boiling and freezing point.....	180	100

From the above it will be seen that one degree Centigrade is equivalent to 9.5 degrees Fahrenheit. Hence the following rules:

1. To change C. into F. reading, multiply by 9.5 and add 32.

$$\text{Example: } 50^{\circ}\text{C} = (50 \times \frac{9}{5}) + 32 = 112^{\circ}\text{F.}$$

2. To change F. into C. reading, subtract 32 and multiply by 5.9.

$$\text{Example: } 182^{\circ}\text{F} = (182 - 32) \times \frac{5}{9} = 83\frac{1}{3}^{\circ}\text{C.}$$

#### METRIC SYSTEM OF WEIGHTS AND MEASURES.

This system was devised by the French people and has very extensive application wherever accuracy in weights and measures is desired. Some of its equivalents in ordinary weights and measures are given in the following table:

Ordinary weights and measures.	Equivalents in metric system.
1 ounce (av.).....	28.35 grams.
1 quart.....	0.9464 liter.
1 gallon.....	3.7854 liters.
1 fluid ounce.....	29.57 cubic centimeters (c.c.)
1 pound (av.).....	0.4536 kilogram.
1 grain.....	64.8 milligrams.
1 inch.....	2.54 centimeters.
1 foot.....	0.3048 meter.

CONSTITUTION AND BY-LAWS FOR A CO-OPERATIVE CREAM-  
ERY ASSOCIATION.\*

Articles of Agreement of the ..... Association.

We the undersigned residents of the county of .....,  
State of ....., do hereby associate ourselves together  
as a co-operative association under the laws of the State  
of ..... and have adopted the following constitution:

Article I.

This association shall be known as the.....  
Association.

Article II.

The object of this association shall be the manufacture  
of butter from milk and cream bought on the fat basis.

Article III.

The regular meetings of this association shall be held  
annually on the ..... day of the month of .....  
Special meetings may be called by the president, or on  
written request of one-third of the members of the asso-  
ciation, provided three days' notice of such meeting is  
sent to all members.

Article IV.

The officers of this association shall be a president,  
secretary, treasurer, and three trustees, who shall be  
elected annually at the regular annual meeting. The

---

\* In drawing up this constitution and by-laws, free use has been made of  
Vye's Creamery Accounting and Farrington & Woll's Testing Milk and Its  
Products.

president or secretary shall also act as general manager of the creamery.

#### Article V.

The duties of the president shall be to preside at all meetings of the association, sign all drafts and documents, and pay all money which comes into his possession by virtue of his office to the treasurer, taking his receipt therefor.

The secretary shall keep a record of all the meetings of the association and make and sign all orders upon the treasurer. He shall conduct the correspondence and general business of the association and keep a correct financial account between the association and its members.

The treasurer shall receive and receipt for all moneys belonging to the association, and pay out the same only upon orders which shall be signed by the president and the secretary. He shall give bonds in such amount as the association shall prescribe.

The president, secretary, and three trustees shall constitute a board of directors, whose duties shall be to audit the accounts of the association, invest its funds, and determine all compensations. They shall prescribe and enforce the rules and regulations of the creamery. They shall cause to be kept a record of the weights and tests of the milk and cream received from each patron, of the products sold, and of the running expenses, and shall divide among the patrons the money due them each month.

The board of directors shall cause the secretary to make, in writing, a report at the annual meeting of the association, setting forth in detail the gross milk receipts, the net receipts of products sold, and all other receipts.

the amount paid for milk and running expenses, and give a complete statement of all other matters pertaining to the business of the association. They shall also make some provision for the withdrawal of any member from the association, and make a report in detail to the association at the annual meeting.

The board of directors shall borrow a sum of money not exceeding . . . . . thousand dollars to be used by them solely for the purpose of building and equipping a creamery.

#### Article VI.

Ten members of the association, or three of the board of directors, shall constitute a quorum to transact business.

#### Article VII.

Each member shall be entitled to one vote only at any meeting of the association. New members may be admitted as provided by the by-laws. Members shall be permitted to withdraw only as provided by the by-laws.

#### Article VIII.

The constitution may be amended at any annual meeting, or at any special meeting, provided that two-thirds of all the members present vote in favor of such a change.

#### *By-Laws of the . . . . . Association.*

1. The milk of each patron shall be tested not less than twice a month.
2. No milk shall be received at the creamery later than ten o'clock a. m.

3. One cent for each pound of butter fat received at the creamery shall be reserved to form a sinking fund.

4. The treasurer shall give bonds in the sum of ..... dollars, the bond to be approved by the board of directors.

5. Patrons shall furnish all of the milk from all the cows promised at the organization of the creamery.

6. Nothing but sweet and pure milk shall be accepted at the creamery.

7. All milk received at the creamery shall be paid for on the basis of the amount of fat it contains.

8. Dividends shall be made on the twentieth day of each month.

**Storch's Test for Milk and Its Products.** This test makes it possible to determine whether milk, cream, skim-milk or buttermilk has been heated to  $176^{\circ}$  F. or above. It is made as follows: Put one teaspoonful of milk into a test tube, add one drop of 2% solution of peroxid of hydrogen and two drops of 2% solution of paraphenylenediamin; shake the mixture; if a dark violet color promptly appears, the milk has not been heated to  $176^{\circ}$  F.

## GLOSSARY.

- ALBUMENOID.—Substances rich in albumen, like the white of an egg which is nearly pure albumen.
- ANAEROBIC.—Living without free oxygen.
- CALIBRATING.—Determining the caliber of the neck of a test bottle in order to ascertain the accuracy of the scale upon it.
- CARBOHYDRATES.—Substances like starch and sugar.
- CENTRIFUGAL FORCE.—That force by which a body moving in a curve tends to fly off from the axis of motion.
- CHEMICAL COMPOSITION.—This refers to the elements or substances of which a body is composed.
- COLLOIDAL.—Resembling glue or jelly.
- CONCUSSION.—The act of shaking or agitating.
- CONSTITUENTS.—The components or elements of a substance.
- DEAD CENTER.—That position of the engine when the crank arm and the piston rod are in a straight line.
- DIVIDERS.—An instrument used in reading tests.
- EMULSION.—A mixture of oil (fat) and water containing sugar or some mucilaginous substance.
- ENZYMES.—Unorganized ferments, or ferments that do not possess life.
- FIBRIN.—A substance which at ordinary temperatures forms a fine network through milk which impedes the rising of the fat globules.
- FOREMILK.—The first few streams of milk drawn from each teat.
- GALACTASE.—An unorganized ferment in milk which digests casein.



- INOCULATION.—To seed, to transplant; as to inoculate milk with lactic acid germs.
- INSULATION.—The state of being protected from heat and cold by non-conducting material.
- LEAD.—The amount of opening of the steam ports when the engine is on the dead center.
- LOPPERED MILK.—Milk that has thickened.
- MAMMARY GLAND.—The organ which secretes milk.
- MEDIUM.—The substance in which bacteria live. Thus, milk furnishes an excellent *medium* for the growth of bacteria.
- MENISCUS.—A body curved like a first quarter moon.
- MILK SERUM.—Milk free from fat. Thus, skim-milk is nearly pure milk serum.
- MIXING CANS.—Small tin cans used for mixing milk preparatory to testing.
- NEUTRAL.—Possessing neither acid nor alkaline properties.
- NON-CONDUCTOR.—A material which does not conduct heat or cold, or only so with great difficulty.
- OSMOSIS.—The tendency in fluids to diffuse or pass through membranes.
- PARTURITION.—The act of being delivered of young.
- PASTEURIZATION.—The process of destroying all or most of the vegetative bacteria by the application of heat from 140° to 185° F.
- PERIOD OF LACTATION.—The time from calving to “drying up.”
- PHYSICAL PROPERTIES.—The external characteristics of a body, like color, odor, hardness, solubility, density, form, etc.
- PROPAGATE.—To continue to multiply. Thus, to *propagate* a starter means to continue multiplying the lactic

- acid bacteria by daily transferring them to a new medium such as sweet pasteurized skim-milk.
- PROTEIDS.—Nitrogenous substances like casein and albumen.
- REDUCING VALVE.—A valve used for regulating steam pressure.
- REFRIGERANT.—In mechanical refrigeration a substance whose evaporation produces cold.
- RENNET.—The curdling and digesting principle of calf stomach.
- SCORING.—A term used synonymously with judging.
- SECRETION.—The act of separating or producing from the blood by the vital economy.
- SEPTIC.—Promoting decay.
- SPECIFIC GRAVITY.—The weight of one body as compared with an equal volume of some other body taken as a standard.
- SPECIFIC HEAT.—The quantity of heat required to raise the temperature of a body one degree.
- SOLUTION.—The state of being dissolved.
- SPORE.—The resting or non-vegetative stage of certain kinds of bacteria.
- STEAM TRAP.—An arrangement by which condensed steam may be taken out of heating pipes without the escape of steam.
- STERILIZATION.—The process of destroying all germ life by the application of heat near 212° F.
- STRIPPERS' MILK.—The milk from cows far advanced in the period of lactation.
- STRIPPINGS.—The last few streams of milk drawn from each teat.
- SUSPENSION.—The state of being held mechanically in a liquid, like butter fat in milk.

TRYPSIN.—The active agent in the secretion of the pancreas.

VEGETATIVE BACTERIA.—Those bacteria that are in an actively growing condition.

VISCOSITY.—The quality of being sticky; stickiness.

VOLATILE.—The state of wasting away on exposure to the atmosphere. Easily passing into vapor like ammonia.

WHOLE MILK.—Milk which has neither been watered nor skimmed.

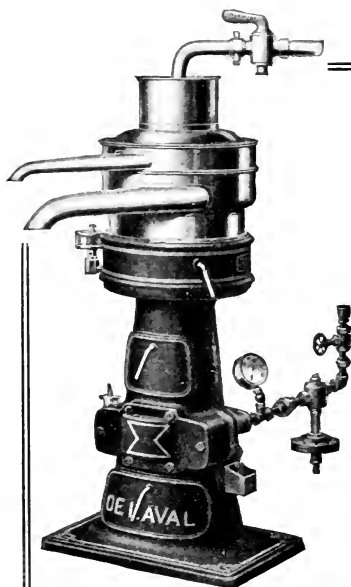

The New and  
Improved  
Factory Size  
**De Laval**  
Cream  
**Separators**

Steam Turbine Driven  
and Belt Styles

**New Capacities**  
4000 and 6000 lbs.

**A FEW ADVANTAGES**

**Greater Efficiency** With cool milk, very heavy cream, irregular speed, or any of the more difficult separating conditions, better results can be obtained from the new style factory size De Laval machines than from the old style machines at present in use.

**Increased Capacity** The increased capacity of the new style machines means that a larger amount of milk can be handled more quickly and economically, and a better quality of product is thus made possible.

**Automatically Oiled** The oil is automatically sprayed into all the bearing parts in such a manner that they literally float in a film of oil, and the wearing surfaces scarcely ever come in contact with each other.

**Less Power Required** The power required for the new style De Laval machines is just about one-half, in proportion to capacity, that required with previous types of De Laval Separators.

The new bowl is center balanced, the bottom being of the cupped or concave type, similar to that of the present style De Laval hand machines. The bowl is detachable from the spindle and is easily removed from the frame for washing purposes. The bowl is equipped with a new cream regulation device which gives a wider range of cream regulation and makes possible separation of cream varying from ten to sixty per cent in butter-fat content.

**THE DE LAVAL SEPARATOR CO.**

NEW YORK  
MONTREAL

CHICAGO  
PETERBORO

SAN FRANCISCO  
WINNIPEG

SEATTLE  
VANCOUVER

# INDEX.

	Page
Acid, butyric .....	15, 46
Acidity of cream, effect of richness on.....	82
Acid measures .....	27
Acid, oleic .....	14
palmitic .....	14
sulphuric .....	28
Acid tests for cream.....	77
Albumen .....	17
Albumenoids .....	16
Appendix .....	345
Ash of milk.....	17
Babcock test .....	23
directions for making....	28
how to read.....	29, 169
principle of .....	23
sample for .....	23
Babcock Tester .....	24
calculating speed for....	32
Bacteria (see fermentations)	42
butyric acid .....	46
lactic acid .....	44
Barn air .....	247
Barn, sanitary .....	242
yard, clean .....	243
Bath room .....	179
Bearings, hot .....	300
Belting, size of.....	298
lacing of .....	299
Bichromate of potash.....	52
Bitter fermentation .....	47
Boiler, care of.....	281
firing of .....	279
scale .....	282
smoke stack for.....	285
Book-keeping .....	215
Bottles, Babcock, how to calibrate.....	31
how to clean.....	31
Brine salting .....	105
Butter, calculating water in .....	158
Butter, color of.....	102, 143
composition of .....	345
control of water in.....	154
fat .....	13
composition of .....	14
globules .....	13
insoluble .....	14
melting point of.....	14
percentage of, in milk	20
physical properties of	13
soluble .....	14
specific gravity of....	14
flavor of .....	66, 141
foreign packages for....	113
granules, size of.....	103
judging .....	137
marketing of .....	116
packages for .....	111
preparing .....	111
packing .....	111
printer .....	113
printing cold .....	115
salting .....	103
sampling of .....	156
score cards .....	138
texture of .....	142
tubs, paraffining of.....	114
preparation of .....	111
washing of .....	103
water in .....	154
working of .....	106
value of .....	262
Buttermakers, advice to....	333
Buttermilk, composition of	346
cottage cheese from....	331
feeding value of.....	331
for starter .....	76, 86
handling of .....	136
skim-milk .....	329
value of as a drink.....	332
Butyric fermentation .....	46
Calculating dividends .....	119

	Page		Page
Cans, starter .....	93	Cream, marketing of.....	262
milk and cream.....	251	pasteurization .....	148
Cans, weigh .....	11	pasteurization of gath-	
Casein .....	16	ered .....	151
making of .....	329	paying for .....	124
Chromogenic fermentation..	49	pumps .....	109, 110
Churn, gas in .....	103	rapid method of deter-	
pumping cream into....	109	mining acidity of....	81
straining cream into....	102	richness of, how regulat-	
Churning .....	96	ed .....	63
at once .....	109	ripeners .....	74
conditions that influence	96	ripening .....	66
difficult .....	108	control of .....	71
foaming in .....	108	methods of .....	68
operations .....	101	objects of .....	66
Churns .....	99	sample .....	169
cleaning .....	108	samplers .....	53, 162
Color, butter .....	102	sampling at creamery...165	
Colostrum milk .....	18	at farm .....	164
Composite samples, care of	54	gathered .....	161
frequency of testing....	55	scales .....	28, 167, 168
sampling .....	51	selling of .....	263
test jars .....	56	separator, choice of.....	59
Compressor, size of.....	210	efficiency of .....	59
expense of operating....	210	history of .....	58
power required to oper-		shipping of .....	253
ate .....	210	skim station .....	253
Cooling of milk and cream..	231	standardizing .....	264
Co-operative creameries ...	224	straining .....	102
Corrosive sublimate .....	52	taints, detection of .....	200
Cottage cheese, making of..	327	testing .....	166
marketing of.....	328	frequency of .....	166
Cream acid tests.....	77	transportation .....	251
adding color to.....	102	cans .....	252
bottles, Babcock ....	25, 167	value of .....	262
calibration of .....	32	weighing at creamery...165	
churnability of .....	67	at farm .....	165
composition of .....	345	boiler .....	272
coolers .....	149, 233	accessories .....	274
cooling of .....	65, 231	Creamery bath room.....	179
danger of adding ice to..	76	book-keeping .....	215
effect of richness on		by-products .....	326
weight of .....	167	construction .....	72
flavor of .....	66	Creamery, co-operative ...	224
frequency of delivering..	254	constitution for .....	348
frothing of .....	68	floor, construction of....	176
grading of .....	267	plan .....	174
hauling of .....	252	heating of .....	180

	Page		Page
Creamery intake .....	176	Fermentations, lactic .....	44
location .....	171	normal .....	44
management of .....	226	slimy orropy.....	48
mechanics .....	272	toxic .....	49
method of organizing....	224	Feed, wholesome .....	246
sewage .....	188	Firing of boiler.....	279
sewerage .....	178	Fore-milk .....	248
statement .....	126	Formalin .....	52
ventilation .....	178	Friction, discussion of....	298
Creaming .....	57	Gasoline power .....	339
efficiency of .....	59	Gassy fermentation .....	9
Curdling fermentation .....	45	Gerber fermentation test....	204
Dairy house .....	230	Globules, fat .....	13
construction .....	230	Globulin .....	16
equipment of .....	231	Glossary .....	352
Digesting fermentation .....	45	Governor, engine .....	290
Dividends, calculating .....	119	Grading cream and milk....	307
Eggs, a side line.....	317	Hansen starter .....	88
cost of handling .....	325	Ice box, a cheap.....	239
gathering of .....	318	Ice, cost of making.....	182
grades of .....	323	cooling power of.....	182
handling of .....	319	source of .....	182
losses in .....	317	Ice cream, chocolate.....	312
marketing of .....	324	cost of .....	315
paying for .....	319	freezing of .....	308
stamping of .....	325	fruit flavored .....	313
testing of .....	329	gelatin, use in.....	314
Engine, care and manage-		kind of cream for.....	307
ment of .....	293	lemon .....	312
horse power of.....	294	making of .....	307
parts of .....	287	marketing of .....	316
Ericsson starter .....	88	nut flavored .....	313
Farrington acid test.....	79	overrun in .....	315
Fat globules .....	13	packing of .....	313
insoluble .....	15	strawberry .....	313
soluble .....	16	vanilla flavored .....	311
Fermentations, milk .....	43	Ice house, construction of..	183
abnormal .....	47	for creamery .....	183
bitter .....	47	for farm .....	239
butyric .....	46	location of .....	175
chromogenic .....	49	Index .....	357
classification of .....	43	Injector .....	275
curdling and digesting...	45	Insoluble fat .....	15
gassy .....	49	Intake .....	176

Page	Page		
Judging butter .....	137	Oils .....	300
Lactic fermentation .....	44	Oleic acid .....	14
Lactometer, use of.....	34	Overrun, actual .....	127
Lacto .....	330	factors that influence.....	127
Lubricator .....	292	ice cream .....	315
		theoretical .....	128
Mann's acid test.....	78	Packages, butter .....	111
Marketing butter .....	116	Packing butter .....	111
cream .....	263	Palmitic acid .....	14
ice cream .....	270	Paraffining tubs .....	114
McKay sampler .....	162	Pasteurization, advantages	
Mechanical refrigeration ..	205	of .....	149
Metric system .....	347	of cream .....	145, 148, 266
Michels sampler .....	162	cost of .....	152
Milk adulteration .....	39	of skim-milk .....	132
bottle, Babcock .....	25	Piston of engine.....	288
colostrum .....	18	Power on farm.....	234
composition of .....	12	Preservatives .....	52
coolers .....	232, 233	Printing butter .....	112, 115
cooling .....	231	Pulleys .....	295
fermentations .....	43	calculating size of.....	295
grading of .....	267	speed of .....	295
heaters, direct .....	62	Pumps for boiler.....	277
indirect .....	63	for cream .....	109, 110
pail, sanitary .....	245	Refrigerating plant—	
physical properties of...	11	charging of .....	211
preservatives .....	52	operating of .....	211
samplers .....	53, 162	pipes .....	210
sanitary production of..	241		
secretion .....	18	Refrigeration,	
solids .....	36	mechanical .....	205
calculation of .....	38	principle in .....	205
specific gravity of.....	12	strength of brine in..	209
sugar .....	17	systems of .....	208
taints, detection of.....	200	Refrigeration, natural .....	182
Milk, testing acidity of.....	81	Refrigerator .....	185, 187
thief .....	53	cooled with ammonia...	206
variation in quality of...	19	with ice at end.....	186
Milkers .....	244	with ice overhead...	184
Moisture, control of.....	154	location of .....	175
Moisture tests (see water		size of .....	184
tests for butter) .....	159	Rule for calculating butter-	
Mottles in butter.....	143	milk .....	129
		cream from milk.....	262
Nuclein .....	16	ice cream yield .....	263



	Page		Page
Rule for calculating size of		Starters, natural vs. com-	
pulleys .....	295	mercial .....	89
skim-milk .....	128	object of .....	84
solids not fat.....	36	pointers on .....	94
total solids .....	36	renewal of .....	92
for churning temperature	97	use of every other day..	90
		whole milk .....	91
Salt an absorbent.....	106	Steam .....	278
determination of .....	343	wet and dry.....	284
rate of .....	104	Sterilizer, author's .....	196
Salting, object of.....	155	Sterilizing milk vessels.....	196
Sample, aliquot .....	161	Storch test .....	317
Sanitary milk production...	241	Strainers .....	247
Scovell sampler.....	53	Straining .....	247
Separator, method of fasten-		Sulphuric acid .....	28
ing .....	236		
Septic tank .....	188	Tester, calculating speed of	32
construction of .....	189	Testing cream .....	166
cost of .....	192	Tests, averaging of.....	124
flow through .....	191	reading cream .....	169
object of .....	189	reading milk .....	29
size of .....	191	Thermometer scales .....	312
Sewage disposal .....	188	Titration .....	77
from creamery .....	188	Toxic fermentation .....	49
from dwelling .....	192		
Shafting, lining up.....	305	Valves .....	303
Shafts, adjustment of.....	300	repairing of .....	304
Shipping cream .....	253	slide .....	289
ice cream .....	271	Vanilla beans .....	310
Skimmilk-buttermilk .....	329	Vanilla flavor .....	308
Skim-milk, composition of..	346	Ventilation of creamery....	178
feeding value of.....	326	Vessels, clean .....	244
fertilizing value of.....	327		
handling of .....	130	Washing butter .....	103
pasteurization of .....	132	milk vessels.....	194
Slimy fermentation .....	48	Wash sinks .....	194
Standardizing cream .....	264	Water, content of butter...154	
Starters, acidity of.....	91	factors that influence 154	
buttermilk .....	76, 86	methods of determin-	
classification of .....	85	ing .....	156
cans .....	93	determining purity of..	261
carrying several .....	92	filtering of .....	259
commercial .....	87	importance of pure.....	256
fighting army .....	95	pasteurization of .....	259
how to select milk for... 90		tank, hot .....	199
mother .....	93	tests for butter.....	159
natural .....	85	Well, construction of.....	256
		Wisconsin curd test.....	201

# Torsion Balance Cream and Butter Test Scales

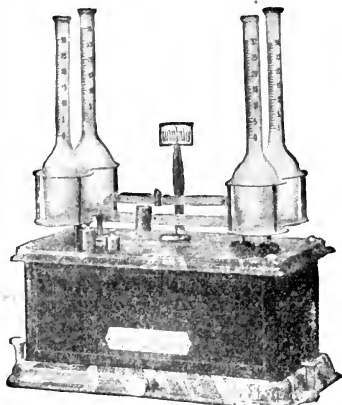

№ 1530

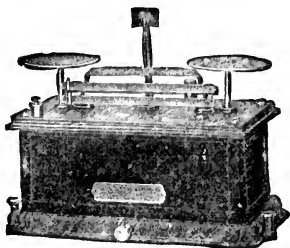

1700

## Style No. 1530

Four-bottle Cream Test Scale. Used with Babcock Test. We make scales for one, two and twelve bottles

## Style No. 1700

Butter Moisture Test Scale. Percentage read direct from beams. No figuring  
No small weights

## We Make a Scale for Determining the Specific Gravity in Liquids

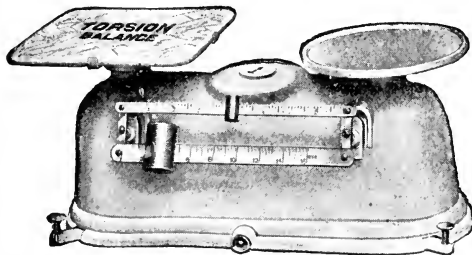

№ 779

No. 779—Butter Print Scale for weighing pound prints  
No weights required

We make Special Scales for Special Purposes

Our Scales are Sold by all Leading Jobbers

## The TORSION BALANCE COMPANY

Office: 92 Reade St., New York

Factory: Jersey City, N. J.

Pacific Coast Branch: San Francisco, Cal.

# THE VILTER MFG. CO.

ESTABLISHED 1867

877 Clinton Street, Milwaukee, Wis.

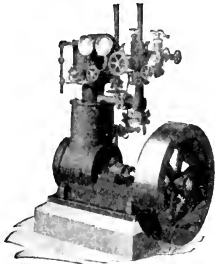

Belt Driven Single-  
Acting Com-  
pressor

## Ice Making and Refrigerating Machinery

Vertical or horizontal. Capacity from  $\frac{1}{2}$  ton to 600 tons Refrigeration

Ask for Bulletin 16.

## CORLISS ENGINES

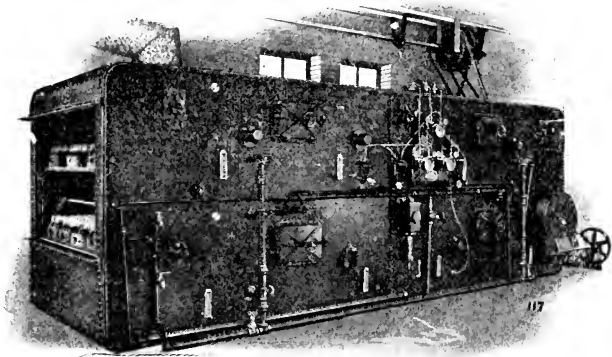

The "BADGER" Pasteurizer  
Pasteurizes In-The-Bottle "The Ideal Way"

*Write for Bulletin*





1900

1901



