

~~FL~~
~~a~~

~~Fly~~
~~M 2~~
~~(1)~~

QP

34
M65

THE
Roswell P. Flower Library
THE GIFT OF
ROSWELL P FLOWER
FOR THE USE OF
THE N. Y. STATE VETERINARY COLLEGE.

4.5

Cornell University Library
QP 34.M65

A text-book of animal physiology, with in



3 1924 000 353 601

vet

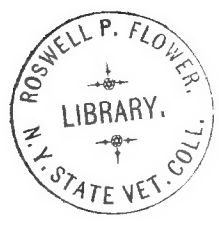

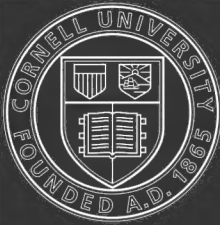

Cornell University Library

The original of this book is in
the Cornell University Library.

There are no known copyright restrictions in
the United States on the use of the text.



A TEXT-BOOK OF ANIMAL PHYSIOLOGY

WITH INTRODUCTORY CHAPTERS
ON GENERAL BIOLOGY
AND A FULL TREATMENT OF REPRODUCTION

FOR STUDENTS OF HUMAN AND COMPARATIVE (VETERINARY)
MEDICINE AND OF GENERAL BIOLOGY

BY
WESLEY MILLS
M. A., M. D., L. R. C.^VP. (ENG.)
PROFESSOR OF PHYSIOLOGY IN MC GILL UNIVERSITY AND THE VETERINARY COLLEGE
MONTREAL

WITH OVER FIVE HUNDRED ILLUSTRATIONS

NEW YORK
D. APPLETON AND COMPANY
LONDON: CAXTON HOUSE, PATERNOSTER SQUARE

1889

QP
34
M65

~~F&M62(1)~~
COPYRIGHT, 1889.
BY D. APPLETON AND COMPANY.
No. 6936

To the Memory of
ROBERT PALMER HOWARD, M. D., LL. D.,
LATE DEAN AND PROFESSOR OF MEDICINE IN MCGILL UNIVERSITY,
WHOSE TEACHING AND PRACTICE EVER TENDED TOWARDS
THE RECOGNITION OF THE IMPORTANCE OF PHYSIOLOGY TO MEDICINE,
AND WHOSE LIFE ILLUSTRATED
WHAT IS LOFTY AND NOBLE IN HUMAN EXISTENCE,
THIS WORK IS DEDICATED
IN REVERENCE AND GRATITUDE.



P R E F A C E .

THE comparative method, the introduction of the teachings of embryology and of the welding principles of evolution as part of the essential structure of zoölogy, may be said to have completely revolutionized that science; and there is scarcely a text-book treating of the subject, however elementary, which has not been molded in accordance with these guiding lines of thought. So far as I am aware, this can not be said of a single book on the subject of physiology. Feeling, therefore, that the time had come for the appearance of a work which should attempt to do, in some degree at least, for physiology what has been so well done for morphology, the present task was undertaken. But there were other changes which it seemed desirable to make. I think any one who will examine the methods and reasoning of the physiology of the day will not fail, on close scrutiny, to recognize a tendency to speak of certain conclusions, for various organs (and functions), as though they applied to these organs in whatever group of animals found, or, at all events, for man, no matter what the species of the animal that had been experimented upon. For some years I have, in publications of my own original researches, strongly protested against such methods as illogical. I am wholly at a loss to understand how a work, built upon the most fragmentary and heterogeneous evidence, derived from experiments on a few groups of animals, or a certain amount of human clinical or pathological evidence, can be fittingly termed a treatise on "human physiology." It will scarcely be denied that conclusions such

as this method implies would not be tolerated in the subject of morphology.

While in the present work what is strictly applicable to other animals and to man has not always been kept apart, an effort has been made throughout to be cautious in all the conclusions drawn—a state of mind warranted by the past history and the present tendencies of physiology. Until our laboratory methods become more perfected, the comparative method more extensively applied, and conclusions drawn from “experiments” modified by comparison with the results of clinical, pathological, and all other available sources of information, I feel convinced that we are called upon to teach cautiously and modestly.

Treating, as we do in our books, each subject in a separate chapter, there is, as I know by observation, the greatest danger that the student may get the idea that each function of the body is discharged very much independently; accordingly, there has been throughout a most persistent effort made to impress the necessity for ever remembering the absolute dependence of all parts. Unless this be thoroughly infused into a student, it is impossible that he can ever understand the wide world of natural objects, or the narrower one of unnatural (in a sense) organisms, as seen in the hospital ward.

Recognizing how important it is to teach the young student to become an observer and an investigator in spirit and in some degree in fact, only such treatment of elaborate methods has been introduced as will enable him to form a general acquaintance with the modes in which laboratory work is carried on, while simple ways of verifying the essential truths of physiology have been constantly brought before him. As to how far these are actually carried out will depend not a little on the teacher. The student who learns thus to observe and to verify will not fail to apply the method in his future career, whatever that may be—whether medical or other—nor is he so likely to throw his physiology overboard as a useless cargo as soon as his primary examination has been passed.

By frequently calling attention, as has been done throughout, to actually discovered or possible differences in function for different groups of animals, it is believed that the student will become possessed of a spirit of caution in drawing conclusions that will fit him the better for the hospital ward in another respect, viz., that he will be prepared for those individual differences actually existing, and which seem to have been largely ignored in so many works on physiology, with the natural consequence that the student, not finding his physiology squaring with the facts of the clinique, and not being prepared for the situation, the result is disappointment and disgust, instead of the actual continuation of the study, especially as human physiology.

With a view of widening the student's field of vision, sections, under the heading "Special Considerations," have been introduced, which it is hoped will not fail to interest and stimulate.

Most teachers of experience will welcome the summary with which each chapter concludes. In connection with no subject perhaps can the art of generalizing be better taught than with physiology, and to this end these brief synoptical sections will, it is thought, prove helpful.

Systematic instruction in either macroscopic or microscopic anatomy has not been undertaken—in fact, can not be attempted, it is believed, except at the expense of physiology proper—in a work of moderate compass. At the same time attention has been called to those points which have a special bearing on each function, and a number of illustrations have been inserted with this object in view.

The introduction of the subject of development at so early a stage is a departure that calls for a word of explanation. An attempt has been made to use embryological facts to throw light upon the different functions of the body, and especially their relations and interdependence. It therefore became necessary to treat the subject early. It is expected, however, that the student will return to it after reading the remaining chapters of the work.

As so large a proportion of those who enter upon the study of medicine begin their career without any adequate preparation in general biology, the subject, as presented in this work, will, let me hope, meet an actual need, and prove helpful in attaining a broad and sound view of the special doctrines of biology.

It is scarcely necessary to remark that clinical and pathological facts have not been introduced with the view of teaching either clinical medicine or pathology, but to indicate to the student how his physiology bears on his profession, and how the above-mentioned subjects throw light upon physiology proper and lend interest to that subject.

My aim has been to make the book, from first to last, educative; and, retaining a vivid recollection of the severe strain put upon the memory of the medical student by our present method of crowding so much into at most four years of study, an attempt has been made to avoid overloading the book with mere facts or technical details, as well as to present the whole subject in as succinct a form as is compatible with clearness. Recognizing, too, the very shifting character of physiological theories, the latter have generally been pretty well kept apart from the actual facts.

It is hoped that the abundance of the illustrations will prove more acceptable than would lengthy treatment of subjects in the text, for, if the matter of a book is to be digested and assimilated, either by the student of general biology or by the hard-worked medical student, it must not be bulky.

The illustrations have been chosen from the best available sources, and the authorship of each one duly acknowledged in the body of the work. Several original diagrams, such as I find exceedingly useful in my own lectures, have been introduced.

This book is really an embodiment of my own course of lectures, as given during the past two years more especially, and with the highest satisfaction, I think it may be said, to both students and teacher.

I have unbounded confidence in the plan of the work, and

I trust that its newness may excuse, to some degree, any shortcomings in the execution. Such a book has become a necessity to myself, and it is hoped will be welcomed by others. I trust the work may prove suitable, not only for the student of human medicine, but for the increasing number of students of comparative or veterinary medicine, who may desire a broad basis for the study of disease in the various animals they are called upon to treat. I have endeavored to make the work specially acceptable to the student of general biology.

It only remains for me to crave the indulgence of all readers, and to thank my publishers, Messrs. D. Appleton & Co., for their uniform courtesy and the great pains they have taken to present the work in worthy form.

WESLEY MILLS.

PHYSIOLOGICAL LABORATORY, MCGILL UNIVERSITY,
MONTREAL, *September, 1889.*

CONTENTS.

	PAGE
GENERAL BIOLOGY	1
Introduction	1
Tabular statement of the subdivisions of Biology	4
THE CELL	5
Animal and vegetable cells	5
Structure of cells	5
Cell-contents	7
The nucleus	7
Tissues	8
Summary	8
UNICELLULAR ORGANISMS (VEGETABLE)	9
1. Yeast	9
Morphological	9
Chemical	10
Physiological	10
Conclusions	10
2. Protococcus	11
Morphological	11
Physiological	11
Conclusions	12
UNICELLULAR ANIMALS	12
The proteus animalcule	12
Morphological	12
Physiological	12
Conclusions	14
PARASITIC ORGANISMS	15
Fungi	15
Mucor mucedo	15
The Bacteria	18
UNICELLULAR ANIMALS WITH DIFFERENTIATION OF STRUCTURE	20
The bell-animalcule	20
Structure	20
Functions	21
MULTICELLULAR ORGANISMS	22
The fresh-water polyyps	22
THE CELL RECONSIDERED	26
THE ANIMAL BODY— an epitomized account of the functions of a mammal	27

	PAGE
LIVING AND LIFELESS MATTER—General explanation and comparison of their properties	31
CLASSIFICATION OF THE ANIMAL KINGDOM	33
Tabular statement	35
Man's place in the animal kingdom	35
THE LAW OF PERIODICITY OR RHYTHM IN NATURE—Explanations and illustrations	36
THE LAW OF HABIT	40
Its foundation	40
Instincts	41
THE ORIGIN OF THE FORMS OF LIFE	41
Arguments from :	
Morphology	43
Embryology	43
Mimicry	43
Rudimentary organs	43
Geographical distribution	45
Paleontology	45
Fossil and existing species	45
Progression	46
Domesticated animals	46
Summary	47
REPRODUCTION	50
General	50
The ovum	54
The origin and development of the ovum	57
Changes in the ovum itself	59
The male cell	60
The origin of the spermatozoön	61
Fertilization of the ovum	62
Segmentation and subsequent changes	63
The gastrula	66
The hen's egg	67
The origin of the fowl's egg	68
Embryonic membranes of birds	72
The foetal (embryonic) membranes of mammals	76
The placenta	80
The discoidal placenta	81
The metadiscoidal placenta	81
The zonary placenta	86
The diffuse placenta	86
The polycotyledonary placenta	86
Microscopic structure of the placenta	87
Illustrations	87
Evolution	89
Summary	89
THE DEVELOPMENT OF THE EMBRYO ITSELF	90
Germ-layers	92
Origin of the vascular system	97
The growth of the embryo	102

	PAGE
DEVELOPMENT OF THE VASCULAR SYSTEM IN VERTEBRATES	103
The later stages of the fetal circulation	108
DEVELOPMENT OF THE UROGENITAL SYSTEM	106
THE PHYSIOLOGICAL ASPECTS OF DEVELOPMENT	112
Menstruation and ovulation	113
The nutrition of the ovum	115
The foetal circulation	118
Parturition	120
Changes in the circulation at birth	120
Sexual coitus	121
ORGANIC EVOLUTION RECONSIDERED	127
Different theories criticised—new views	127
THE CHEMICAL CONSTITUTION OF THE ANIMAL BODY	135
Proximate principles	137
General characters of proteids	138
Certain non-crystalline bodies	138
The fats	139
Peculiar fats	140
Carbohydrates	140
Nitrogenous metabolites	140
Non-nitrogenous metabolites	141
PHYSIOLOGICAL RESEARCH AND PHYSIOLOGICAL REASONING	141
THE BLOOD	147
Comparative	148
Corpuscles	149
History of the blood-cells	151
Chemical composition of the blood	154
Composition of serum	155
Composition of the corpuscles	155
The quantity and distribution of the blood	156
The coagulation of the blood	157
Clinical and pathological	163
Summary	165
THE CONTRACTILE TISSUES	166
General	166
Comparative	167
Ciliary movements	168
The irritability of muscle and nerve	169
APPLICATIONS OF THE GRAPHIC METHOD TO THE STUDY OF MUSCLE	
PHYSIOLOGY.	171
Chronographs and various kinds of apparatus	171-174
A single muscular contraction	178
Tetanic contraction	182
The muscle-tone	184
The strength of the stimulus	185
The changes in a muscle during contraction	186
The elasticity of muscle	187
The electrical phenomena of muscle	188
Chemical changes in muscle	192
Thermal changes in the contracting muscle	195

	PAGE
The physiology of nerve	196
Electrotonus	196
Pathological and clinical	198
Law of contraction	198
Electrical organs	199
Muscular work	199
Circumstances influencing the character of muscular and nervous activity	200
The influence of blood-supply and fatigue	200
Separation of muscle from the central nervous system	202
The influence of temperature	202
The intimate nature of muscular and nervous action	203
Unstriped muscle	204
General	204
Comparative	205
Special considerations	205
Functional variations	207
Summary of the physiology of muscle and nerve	208
THE NERVOUS SYSTEM—GENERAL CONSIDERATIONS	210
Experimental	212
Automatism	214
Conclusions	214
Nervous inhibition	215
THE CIRCULATION OF THE BLOOD	216
General	216
The mammalian heart	217
Circulation in the mammal	221
The action of the mammalian heart	223
The velocity of the blood and blood-pressure	224
General	224
Comparative	225
The circulation under the microscope	226
The characters of the blood-flow	227
Blood-pressure	228
THE HEART	232
The cardiac movements	232
The impulse of the heart	233
Investigation of the heart-beat from within	234
The cardiac sounds	235
Causes of the sounds	236
Endo-cardiac pressures	238
The work of the heart	241
Variations in the cardiac pulsation	242
The pulse	244
Features of an arterial pulse-tracing	247
Venous pulse	251
Pathological	251
Comparative	251
The beat of the heart and its modifications	261
The nervous system in relation to the heart	261
Influence of the vagus nerve on the heart	265

CONTENTS.

XV

	PAGE
Conclusions	269
The accelerator nerves of the heart	270
Human physiology	273
The heart in relation to blood-pressure	274
The influence of the quantity of blood	275
Conclusions	277
The capillaries	281
Special considerations	282
Pathological	282
Personal observations	283
Comparative	283
Evolution	285
Summary of the physiology of the circulation	286
DIGESTION OF FOOD	290
Foodstuffs, milk, etc.	290
Embryological	295
Comparative	296
The digestive juices	306
Saliva and its action	306
Secretion of the different glands	307
Comparative	308
Pathological	308
Gastric juice	308
Bile	311
General	311
Pigments	312
Digestive action	313
Comparative	314
Pancreatic secretion	314
Succus entericus	317
Comparative	319
Secretion as a physiological process	319
Secretion of the salivary glands	319
Secretion by the stomach	323
The secretion of bile and pancreatic juice	323
The nature of the act of secretion	326
Self-digestion of the digestive organs	329
Comparative	330
The movements of the digestive organs	331
Deglutition	332
Comparative	335
The movements of the stomach	335
Comparative	336
Pathological	336
The intestinal movements	337
Defecation	337
Vomiting	338
Comparative	339
Pathological	339
The removal of digestive products from the alimentary canal	341

	PAGE
Lymph and chyle	342
The movements of the lymph—comparative	342
Pathological	353
Fæces	353
Pathological	354
The changes produced in the food in the alimentary canal	355
General	355
Comparative	357
Pathological	357
Special considerations	358
Various	358
Human physiology	362
Evolution	363
Summary	364
THE RESPIRATORY SYSTEM	365
General	365
Anatomical	368
The entrance and exit of air	369
The muscles of respiration	372
Types of respiration	373
Personal observation	374
Comparative	375
The quantity of air respired	378
The respiratory rhythm	379
General	379
Pathological	379
Respiratory sounds	381
Comparison of the inspired and the expired air	381
Respiration in the blood	383
Hæmoglobin and its derivatives	385
General	385
Blood-spectra	387
Comparative	389
The nitrogen and the carbon dioxide of the blood	389
Foreign gases and respiration	392
Respiration in the tissues	392
The nervous system in relation to respiration	393
Nerves and centers concerned	395
The influence of the condition of the blood on respiration	397
The Cheyne-Stokes respiration	398
The effects of variations on the atmospheric pressure	399
The influence of respiration on the circulation	400
General	400
Comparative	402
The respiration and circulation in asphyxia	404
Pathological	406
Peculiar respiratory movements	406
Coughing, laughing, etc.	406
Comparative	407
Special considerations	408

	PAGE
Pathological and chemical	408
Personal observation	408
Evolution	409
Summary of the physiology of respiration	410
PROTECTIVE AND EXCRETORY FUNCTIONS OF THE SKIN	412
General	412
Comparative	413
The excretory function of the skin	415
Normal sweat	415
Pathological	415
Comparative—Respiration by the skin	415
Death from suppression of the functions of the skin	416
The excretion of perspiration	416
Experimental	416
Human physiology	417
Absorption by the skin	418
Comparative	418
Summary	418
EXCRETION BY THE KIDNEY	419
Anatomical	419
Comparative	419
Urine considered physically and chemically	422
Specific gravity	422
Color	423
Reaction	423
Quantity	423
Composition: Nitrogenous crystalline bodies	423
Non-nitrogenous organic bodies	424
Inorganic salts	424
Abnormal urine	425
Comparative	425
The secretion of urine	426
Methods of investigation	426
Theories of secretion	427
Nervous influence	428
Pathological	428
The expulsion of urine	429
General	429
Facts of experiment and of experience	429
Pathological	430
Comparative	430
Summary of urine and the functions of the kidneys	430
THE METABOLISM OF THE BODY	431
General remarks	431
The metabolism of the liver	432
The glycogenic function	432
The uses of glycogen	434
Pathological	435
Metabolism of the spleen	436
Histological	436

	PAGE
Chemical	437
Spleen curves	439
The nervous system in relation to the spleen	439
The construction of fat	440
General and experimental	440
Histological	441
Changes in the cells of the mammary gland	442
Milk and colostrum	443
Nature of fat-formation	444
Pathological	445
Comparative	445
The metabolic processes concerned in the formation of urea, uric acid, hippuric acid, and allied bodies	446
General discussion	446
Pathological	448
Evolution	448
The study of the metabolic processes by other methods	449
Various tabular statements	450
Starvation and its lessons	450
Comparative	452
Diets	452
Feeding experiments	454
General	454
Proteid metabolism	455
Nitrogenous equilibrium	456
Comparative	456
The effects of gelatine in the diet	457
Fat and carbohydrates	457
Comparative	458
The effects of salts, water, etc., on the diet	458
Pathological	459
The energy of the animal body	459
Tabular statements	460
The sources of muscular energy	461
Animal heat	461
General	461
Comparative	461
The regulation of temperature	464
Cold-blooded and warm-blooded animals compared	465
Theories of heat formation and heat regulation	466
Pathological	467
Special considerations	467
Evolution	468
Hibernation	470
Daily variations in temperature in man and other mammals	470
The influence of the nervous system on metabolism (nutrition)	471
Experimental facts	471
Discussion of their significance	472
General considerations, chemical and pathological	476
Summary of metabolism	476

	PAGE
THE SPINAL CORD—GENERAL	480
General	480
Anatomical	482
The reflex functions of the spinal cord	484
General and experimental	484
Evolution and heredity	485
Inhibition of reflexes	485
Reflex time	486
The spinal cord as a conductor of impulses	487
Anatomical	488
Decussation	489
Pathological	490
Paths of impulses	491
The automatic functions of the spinal cord	493
General	493
Spinal phenomena	493
Special considerations	495
Comparative	495
Evolution	496
Synoptical	497
THE BRAIN	498
General and anatomical	498
Animals deprived of their cerebrum	500
Behavior of various animals and its significance	500
Have the semicircular canals a co-ordinary function ?	502
Experimental, etc.	502
Discussion of the phenomena	502
Forced movements	503
Functions of the cerebral convolutions	504
Comparative	505
Individual differences in brains	518
The connection of one part of the brain with another	518
The cerebral cortex	521
Theories of different observers	522
The circulation in the brain	525
Sleep—hibernation—dreaming	526
Hypnotism—catalepsy—somniaambulism	528
Pathological	530
Cerebral localization reconsidered	530
Illustrations of localization	535
Different methods criticised	535
Cerebral time	535
Functions of other portions of the brain	536
The corpus striatum and the optic thalamus	536
Corpora quadrigemina	539
The cerebellum	541
Pathological	541
Crura cerebri and and pons Varolii	541
Pathological	542
Medulla oblongata	542

	PAGE
Special considerations	542
Embryological	542
Evolution	543
Synoptical	547
GENERAL REMARKS ON THE SENSES	548
Anatomical	548
General principles	550
THE SKIN AS AN ORGAN OF SENSE	551
General	551
Pathological	553
Pressure sensations	554
Thermal sensations	554
Tactile sensibility	555
The muscular sense	557
General	557
Pathological	557
Comparative	558
Synoptical	559
VISION	559
Physical	559
Anatomical	561
Embryological	562
Dioptrics of vision	563
Accommodation of the eye	563
Alterations in the size of the pupil	569
Phenomena and their explanations	570
Pathological	572
Optical imperfections of the eye	572
Spherical aberration	572
Astigmatism	573
Chromatic aberration	573
Entoptic phenomena	574
Anomalies of refraction	574
Visual sensations	576
General	576
Affections of the retina	578
The nature of the processes which originate visual impulses	580
The laws of retinal stimulation	581
The visual angle	582
Color sensations	583
Theories of color-vision	584
Color-blindness	585
Psychological aspects of vision	586
The visual field	586
Imperfections of visual perceptions as "irradiation," etc.	587
Influence of the pigment of the macula lutea	589
After-images, etc.	589
Misconceptions as to the comparative size of objects	590
Subjective phenomena	591
Co-ordination of the two eyes in vision	591

	PAGE
The visual axes	591
Ocular movements	592
The horopter	594
Estimation of the size and distance of objects	595
Solidity	595
Protective mechanisms of the eye	596
Special considerations	598
Comparative	597
Evolution	600
Pathological	602
Brief synopsis of the physiology of vision	602
HEARING	604
General	604
Anatomical	605
The membrana tympani	606
The auditory ossicles	607
Muscles of the middle ear	608
The Eustachian tube	609
Pathological	609
Auditory impulses	610
Auditory sensations, perceptions, judgments	615
General	615
Auditory judgment	615
Range of auditory discrimination	616
Special considerations	616
Comparative	616
Evolution	618
Synopsis of the physiology of hearing	620
THE SENSE OF SMELL	620
Anatomical	620
General	621
Comparative	622
THE SENSE OF TASTE	623
Anatomical	623
General	623
Experimental	623
Pathological	625
Comparative	626
THE CEREBRO-SPINAL SYSTEM OF NERVES	626
1. Spinal nerves	626
General	626
Exception	627
Additional experiments	627
Pathological	627
2. The cranial nerves	628
General	628
The motor-oculi, or third nerve	628
The trochlear, or fourth nerve	629
The abducens, or sixth nerve	629
The facial, or seventh nerve	629

	PAGE
The trigeminus, or fifth nerve	630
The glosso-pharyngeal, or ninth nerve	633
The pneumogastric, or tenth nerve	633
The spinal accessory, or eleventh nerve	635
The hypoglossal, or twelfth nerve	635
Relations of the cerebro-spinal and sympathetic systems	636
Recent views on this subject	636
THE VOICE AND SPEECH	639
Physical	639
Anatomical	640
Laryngoscopic observations	643
Voice-formation	643
The registers and the falsetto-voice	644
Pathological	646
Comparative	647
Speech	649
General	649
Formation of vowels and consonants	650
Whispering	650
Classification of consonants	651
Pathological	651
Special considerations	652
Evolution	652
Summary	653
LOCOMOTION	655
Anatomical	655
Mechanical	655
Standing	656
Walking	657
Running	659
Jumping	659
Hopping	659
Comparative: the gait of quadrupeds	659
Evolution	662
MAN CONSIDERED PHYSIOLOGICALLY AT THE DIFFERENT PERIODS OF HIS	
EXISTENCE	663
Size and growth	663
Digestive system	664
Circulatory and respiratory systems	664
Dentition	665
Nervous system	666
Puberty	666
The sexes	667
Old age	667
Comparative	668
Death	668
APPENDIX: ANIMAL CHEMISTRY	671
INDEX	691

ANIMAL PHYSIOLOGY.

GENERAL BIOLOGY.

INTRODUCTION.

BIOLOGY (*βίος*, life; *λόγος*, a dissertation) is the science which treats of the nature of living things; and, since the properties of plants and animals can not be explained without some knowledge of their form, this science includes morphology (*μορφή*, form; *λόγος*, a dissertation) as well as physiology (*φύσις*, nature; *λόγος*).

Morphology describes the various forms of living things and their parts; physiology, their action or function.

General biology treats neither of animals nor plants exclusively. Its province is neither zoölogy nor botany; but it attempts to define what is common to all living things. Its aim is to determine the properties of organic beings as such, rather than to classify or to give an exhaustive account of either animals or plants. Manifestly, before this can be done, living things, both animal and vegetable, must be carefully compared, otherwise it would be impossible to recognize differences and resemblances; in other words, to ascertain what they have in common.

When only the highest animals and plants are contemplated, the differences between them seem so vast that they appear to have, at first sight, nothing in common but that they are living: between a tree and a dog an infant can discriminate; but there are microscopic forms of life that thus far defy the most learned to say whether they belong to the animal or the vegetable world. As we descend in the organic series, the lines of distinction grow fainter, till they seem finally to all but disappear.

But let us first inquire: What are the determining charac-

teristics of living things as such? By what barriers are the animate and inanimate worlds separated? To decide this, falls within the province of general biology.

Living things grow by interstitial additions of particles of matter derived from without and transformed into their own substance, while inanimate bodies increase in size by superficial additions of matter over which they have no power of decomposition and recomposition so as to make them like themselves. Among lifeless objects, crystals approach nearest to living forms; but the crystal builds itself up only from material in solution of the same chemical composition as itself.

The chemical constitution of living objects is peculiar. Carbon, hydrogen, oxygen, and nitrogen are combined into a very complex whole or molecule, as protein; and, when in combination with a large proportion of water, constitute the basis of all life, animal and vegetable, known as protoplasm. Only living things can manufacture this substance, or even protein.

Again, in the very nature of the case, protoplasm is continually wasting by a process of oxidation, and being built up from simpler chemical forms. Carbon dioxide is an invariable product of this waste and oxidation, while the rest of the carbon, the hydrogen, oxygen, and nitrogen are given back to the inorganic kingdom in simpler forms of combination than those in which they exist in living beings. It will thus be evident that, while the flame of life continues to burn, there is constant chemical and physical change. Matter is being continuously taken from the world of things that are without life, transformed into living things, and then after a brief existence in that form returned to the source from which they were originally derived. It is true, all animals require their food in organized form—that is, they either feed on animal or plant forms; but the latter derive their nourishment from the soil and the atmosphere, so that the above statement is a scientific truth.

Another highly characteristic property of all living things is to be sought in their periodic changes and very limited duration. Every animal and plant, no matter what its rank in the scale of existence, begins in a simple form, passes through a series of changes of varying degrees of complexity, and finally declines and dies; which simply means that it rejoins the inanimate kingdom: it passes into another world to which it formerly belonged.

Living things alone give rise to living things; protoplasm

alone can beget protoplasm; cell begets cell. *Omne animal (anima, life) ex ovo* applies with a wide interpretation to all living forms.

From what has been said it will appear that life is a condition of ceaseless change. Many of the movements of the protoplasm composing the cell-units of which living beings are made are visible under the microscope; their united effects are open to common observation—as, for example, in the movements of animals giving rise to locomotion we have the joint result of the movements of the protoplasm composing millions of muscle-cells. But, beyond the powers of any microscope that has been or probably ever will be invented, there are molecular movements, ceaseless as the flow of time itself. All the processes which make up the life-history of organisms involve this molecular motion. The ebb and flow of the tide may symbolize the influx and efflux of the things that belong to the inanimate world, into and out of the things that live.

It follows from this essential instability in living forms that life must involve a constant struggle against forces that tend to destroy it; at best this contest is maintained successfully for but a few years in all the highest grades of being. So long as a certain equilibrium can be maintained, so long may life continue and no longer.

The truths stated above will be illustrated in the simpler forms of plants and animals in the ensuing pages, and will become clearer as each chapter of this work is perused. They form the fundamental laws of general biology, and may be formulated as follows:

1. Living matter or protoplasm is characterized by its chemical composition, being made up of *carbon, hydrogen, oxygen, and nitrogen*, arranged into a very complex molecule.

2. Its universal and constant waste and its repair by interstitial formation of new matter similar to the old.

3. Its power to give rise to new forms similar to the parent ones by a process of division.

4. Its manifestation of periodic changes constituting development, decay, and death.

Though there is little in relation to living beings which may not be appropriately set down under zoölogy or botany, it tends to breadth to have a science of general biology which deals with the properties of things simply as living, irrespective very much as to whether they belong to the realm of animals or plants. The relation of the sciences which may be regarded

as subdivisions of general biology is well shown in the following table:*

<p>Morphology. The science of form, structure, etc. Essentially statical.</p> <p>Biology. The science of living things; i. e., of matter in the living state.</p>	<p><i>Anatomy.</i> The science of structure; the term being usually applied to the coarser and more obvious composition of plants or animals.</p>	<p>Botany. The science of vegetal living matter or plants.</p>
	<p><i>Histology.</i> Microscopical anatomy. The ultimate optical analysis of structure by the aid of the microscope; separated from anatomy only as a matter of convenience.</p>	
<p>Physiology. The science of action or function. Essentially dynamical.</p>	<p><i>Taxonomy.</i> The classification of living things, based chiefly on phenomena of structure.</p>	<p>Biology. The science of living things; i. e., of matter in the living state.</p>
	<p><i>Distribution.</i> Considers the position of living things in space and time; their distribution over the present face of the earth; and their distribution and succession at former periods, as displayed in fossil remains.</p>	
	<p><i>Embryology.</i> The science of development from the germ; includes many mixed problems pertaining both to morphology and physiology. At present largely morphological.</p>	<p>Zoölogy. The science of animal living matter or animals.</p>
	<p><i>Physiology.</i> The special science of the functions of the individual in health and in disease; hence including <i>Pathology.</i></p>	
	<p><i>Psychology.</i> The science of mental phenomena.</p>	
	<p><i>Sociology.</i> The science of social life, i. e., the life of communities, whether of men or of lower animals.</p>	

* Taken from the "General Biology" of Sedgwick and Wilson.

THE CELL.*

All living things, great and small, are composed of cells. Animals may be divided into those consisting of a single cell (*Protozoa*), and those made up of a multitude of cells (*Metazoa*); but in every case the animal begins as a single cell or ovum from which all the other cells, however different finally from one another either in form or function, are derived by processes of growth and division; and, as will be seen later, the whole organism is at one period made up of cells practically alike in structure and behavior. The history of each individual animal or plant is the resultant of the conjoint histories of each of its cells, as that of a nation is, when complete, the story of the total outcome of the lives of the individuals composing it.

It becomes, therefore, highly important that a clear notion of the characters of the cell be obtained at the outset; and this chapter will be devoted to presenting a general account of the cell.

The cell, whether animal or vegetable, in its most complete form consists of a mass of viscid, semifluid, transparent substance (*protoplasm*), a cell wall, and a more or less circular body (*nucleus*) situated generally centrally within; in which, again, is found a similar structure (*nucleolus*).

This description applies to both the vegetable and the animal cell; but the student will find that the greater proportion of animal cells have no cell wall, and that very few vegetable cells are without it. But there is this great difference between the animal and vegetable cell: the former never has a *cellulose* wall, while the latter rarely lacks such a covering. In every case the cell wall, whether in animal or vegetable cells, is of greater consistence than the rest of the cell. This is especially true of the vegetable cell.

It is doubtful whether there are any cells without a nucleus, while not a few, especially when young and most active, possess several. The circular form may be regarded as the typical form of both cells and nuclei, and their infinite variety in size and form may be considered as in great part the result of the action of mechanical forces, such as mutual pressure; this is, of course, more especially true of shape. Reduced to its greatest simplicity, then, the cell may be simply a mass of protoplasm with a nucleus.

* The illustrations of the sections following will enable the student to form a generalized mental picture of the cell in all its parts.

It seems probable that the numerous researches of recent years and others now in progress will open up a new world of cell biology which will greatly advance our knowledge, especially in the direction of increased depth and accuracy.

Though many points are still in dispute, it may be safely said that the nucleus plays, in most cells, a rôle of the highest importance; in fact, it seems as though we might regard the nucleus as the directive brain, so to speak, of the individual cell. It frequently happens that the behavior of the body of the cell is foreshadowed by that of the nucleus. Thus fre-

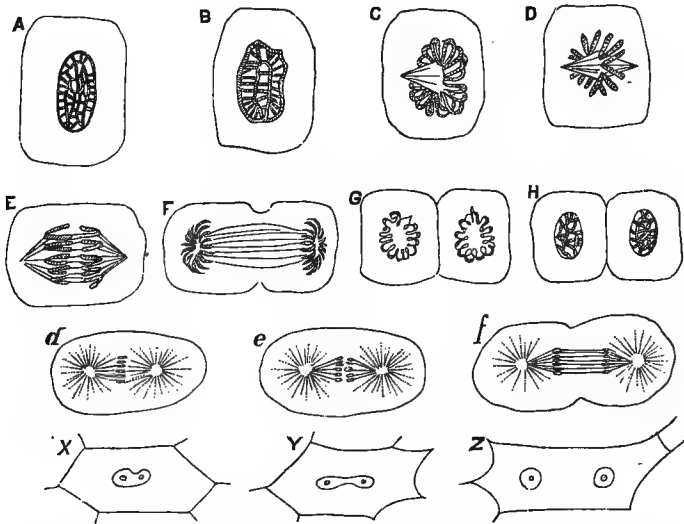

FIG. 1.—NUCLEAR DIVISION. A-H, karyokinesis of a tissue-cell. A, nuclear reticulum in its ordinary state. B, preparing for division; the contour is less defined, and the fibers thicker and less intricate. C, wreath-stage; the chromatin is arranged in a complicated looping round the equator of the achromatin spindle. D, monaster-stage; the chromatin now appears as centripetal equatorial V's, each of which should be represented as double. E, a migration of the half of each chromatin loop towards opposite poles of the spindle. F, diaster-stage; the chromatin forms a star, round each pole of a spindle, each aster being connected by strands of achromatin. G, daughter-wreath stage; the newly formed nuclei are passing through their retrogressive development, which is completed in the resting stage, H. *d-f*, karyokinesis of an egg-cell, showing the smaller amount of chromatin than in the tissue-cell. The stages *d, e, f*, correspond to D, E, F, respectively. The polar star at the end of the spindle is composed of protoplasm-granules of the cell itself, and must not be mistaken for the diaster (F). The coarse lines represent the chromatin, and the dotted lines cell-granules. (Chiefly modified from Flemming.) X-Z, direct nuclear division in the cells of the embryonic integument of the European scorpion. After Blochmann (*Haddon*).

quently, if not always, division of the body of the nucleus precedes that of the cell itself, and is of a most complicated character (*karyokinesis* or *mitosis*). The cell wall is of subordinate importance in the processes of life, though of great value as a mechanical support to the protoplasm of the cell and the aggre-

gations of cells known as tissues. The greater part of a tree may be said to be made up of the thickened walls of the cells, and these are destitute of true vitality, unless of the lowest order; while the really active, growing part of an old and large tree constitutes but a small and limited zone, as may be learned from the plates of a work on modern botany representing sections of the wood.

Animals, too, have their rigid parts, in the adult state especially, resulting from the thickening of a part or the whole of the cell by a deposition usually of salts of lime, as in the case of the bones of animals. But in some cases, as in cartilage, the cell wall or capsule undergoes thickening and consolidation, and several may fuse together, constituting a *matrix*, which is also made up in part, possibly, of a secretion from the cell protoplasm. In the outer parts of the body of animals we have a great abundance of examples of thickening and hardening of cells. Very well known instances are the indurated patches of skin (*epithelium*) on the palms of the hands and elsewhere.

It will be scarcely necessary to remark that in cells thus altered the mechanical has largely taken the place of the vital in function. This at once harmonizes with and explains what is a matter of common observation, that old men are less active—have less of life within them, in a word, than the young. Chemically, the cellulose wall of plant-cells consists of carbon, hydrogen, and oxygen, in the same relative proportion as exists in starch, though its properties are very different from those of that substance.

Turning to cell contents, we find them everywhere made up of a clear, viscid substance, containing almost always granules of varying but very minute size, and differing in consistence, not only in different groups of cells, but often in the same cell, so that we can distinguish an outer portion (*ectoplasm*) and an inner more fluid and more granular region (*endoplasm*).

The nucleus is a body with very clearly defined outline (in some cases limited by a membrane), through which an irregular network of fibers extends that stains more deeply than any other part of the whole cell.

Owing to the fact that it is so readily changed by the action of reagents, it is impossible to ascertain the exact chemical composition of living protoplasm; in consequence, we can only infer its chemical structure, etc., from the examination of the dead substance.

In general, it may be said that protoplasm belongs to the

class of bodies known as proteids—that is, it consists chemically of carbon, hydrogen, a little sulphur, oxygen, and nitrogen, arranged into a very complex and unstable molecule. This very instability seems to explain at once its adaptability for the manifestation of its nature as living matter, and at the same time the readiness with which it is modified by many circumstances, so that it is possible to understand that life demands an incessant adaptation of internal to external conditions.

It seems highly probable that protoplasm is not a single proteid substance, but a mixture of such; or let us rather say, furnishes these when chemically examined and therefore dead.

Very frequently, indeed generally, protoplasm contains other substances, as salts, fat, starch, chlorophyl, etc.

From the fact that the nucleus stains differently from the cell contents, we may infer a difference between them, physical and especially chemical. It (nucleus) furnishes on analysis *nuclein*, which contains the same elements as protoplasm (with the exception of sulphur) together with phosphorus. Nuclei have great resisting power to ordinary solvents and even the digestive juices.

Inasmuch as all vital phenomena are associated with protoplasm, it has been termed the “physical basis of life” (Huxley).

Tissues.—A collection of cells performing a similar physiological action constitutes a tissue.

Generally the cells are held together either by others with that sole function, or by cement material secreted by themselves. An *organ* may consist of one or several tissues. Thus the stomach consists of muscular, serous, connective, and glandular tissues besides those constituting its blood-vessels, lymphatics, and nerves. But all of the cells of each tissue have, speaking generally, the same function. The student is referred to works on general anatomy and histology for classifications and descriptions of the tissues.

The statements of this chapter will find illustration in the pages immediately following, after which we shall return to the subject of the cell afresh.

Summary.—The typical cell consists of a wall, protoplasmic contents, and a nucleus. The vegetable cell has a limiting membrane of cellulose. Cells undergo differentiation and may be united into groups forming tissues which serve one or more definite purposes.

The chemical constitution of protoplasm is highly complex

and unstable. The nucleus plays a prominent part in the life-history of the cell, and seems to be essential to its perfect development and greatest physiological efficiency.

UNICELLULAR PLANTS.

YEAST (*Torula*, *Saccharomyces Cerevisiæ*).

The essential part of the common substance, yeast, may be studied to advantage, as it affords a simple type of a vast group of organisms of profound interest to the student of physiology and medicine. To state, first, the main facts as ascertained by observation and experiment:

Morphological. — The particles of which yeast is composed are cells of a circular or oval form, of an average diameter of about $\frac{1}{3000}$ of an inch.

Each individual *torula* cell consists of a transparent homogeneous covering (*cellulose*) and granular semifluid contents (*protoplasm*). Within the latter there may be a space (*vacuole*) filled with more fluid contents.

The various cells produced by budding may remain united like strings of beads. Collections of masses composed of four or more subdivisions (*ascospores*), which finally separate by rupture of the original cell wall, having thus become themselves independent cells, may be seen more rarely (*endogenous division*).

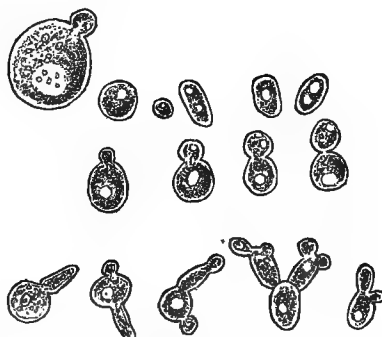

FIG. 2.—Various stages in the development of brewer's yeast, seen, with the exception of the first in the series, with an ordinary high power (Zeiss, D. 4) of the microscope. The first is greatly magnified (Gundlach's $\frac{1}{4}$ immersion lens). The second series of four represents stages in the division of a single cell; and the third series a branching colony. Everywhere the light areas indicate vacuoles.

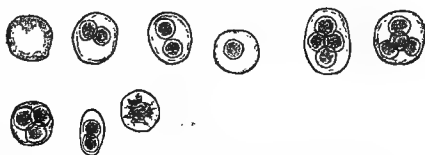

FIG. 3.—The endogonia (ascospore) phase of reproduction—i. e., endogenous division.



FIG. 4.—Further development of the forms represented in Fig. 3.

The yeast-cell is now believed to possess a *nucleus*.

Chemical.—When yeast is burned and the ashes analyzed, they are found to consist chiefly of salts of potassium, calcium, and magnesium.

The elements of which yeast is composed are C, H, O, N, S, P, K, Mg, and Ca; but chiefly the first four.

Physiological.—If a little of the powder obtained by drying yeast at a temperature below blood-heat be added to a solution of sugar, and the latter be kept warm, bubbles of carbon dioxide will be evolved, causing the mixture to become frothy; and the fluid will acquire an alcoholic character (*fermentation*).

If the mixture be raised to the boiling-point, the process described at once ceases.

It may be further noticed that in the fermenting saccharine solution there is a gradual increase of turbidity. All of these changes go on perfectly well in the total absence of sunlight.

Yeast-cells are found to grow and reproduce abundantly in an artificial food solution consisting of a dilute solution of certain salts, together with sugar.

Conclusions.—What are the conclusions which may be legitimately drawn from the above facts?

That the essential part of yeast consists of cells of about the size of mammalian blood-corpuscles, but with a limiting wall of a substance different from the inclosed contents, which latter is composed chiefly of that substance common to all living things—protoplasm; that like other cells they reproduce their kind, and in this instance by two methods: *gemmation* giving rise to the bead-like aggregations alluded to above; and internal division of the protoplasm (*endogenous division*).

From the circumstances under which growth and reproduction take place, it will be seen that the original protoplasm of the cells may increase its bulk or grow when supplied with suitable food, which is not, as will be learned later, the same in all respects as that on which green plants thrive; and that this may occur in darkness. But it is to be especially noted that the protoplasm resulting from the action of the living cells is wholly different from any of the substances used as food. This power to construct protoplasm from inanimate and unorganized materials, reproduction, and fermentation are all properties characteristic of living organisms alone.

It will be further observed that these changes all take place within narrow limits of temperature; or, to put the matter

more generally, that the life-history of this humble organism can only be unfolded under certain well-defined conditions.

PROTOCOCCUS (*Protococcus pluvialis*).

The study of this one-celled plant will afford instructive comparison between the ordinary green plant and the colorless plants or fungi.

Like *Torula* it is selected because of its simple nature, its abundance, and the ease with which it may be obtained, for it abounds in water-barrels, standing pools, drinking-troughs, etc.

Morphological.—Protococcus consists of a structureless wall and viscid granular contents, i. e., of cellulose and protoplasm.

The protoplasm may contain starch and a red or green coloring matter (*chlorophyl*). It probably contains a nucleus. The cell is mostly globular in form.

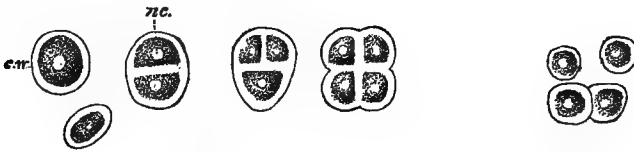

FIG. 5.

FIG. 6.

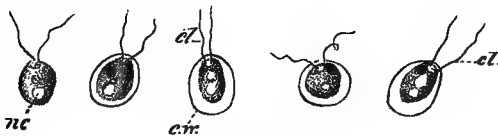

FIG. 7.

FIGS. 5 to 7 represent successive stages observed in the life-history of Protococci scraped from the bark of a tree.

FIG. 5.—A group in the dried state, illustrating method of division.

FIG. 6.—One of the above after two days' immersion in water.

FIG. 7.—Various phases in the later motile stage assumed by the above specimens. The nucleus is denoted by *nc.*; the cell wall by *c.w.*; and the coloring-matter by the dark spot. On the left of Fig. 7 an individual may be seen that is devoid of a cell wall.

Physiological.—It reproduces by division of the original cell (*fission*) into similar individuals, and by a process of budding and constriction (*gemmation*) which is much rarer. Under the influence of sunlight it decomposes carbon dioxide (CO₂), fixing the carbon and setting the oxygen free. It can flourish perfectly in rain-water, which contains only carbon dioxide, salts of ammonium, and minute quantities of other soluble salts that may as dust have been blown into it.

There is a motile form of this unicellular plant, and in this stage it moves through the fluid in which it lives by means of

extensions of its protoplasm (*cilia*) through the cell wall; or the cell wall may disappear entirely. Finally, the motile form, withdrawing its cilia and clothing itself with a cellulose coat, becomes globular and passes into a quiescent state again. Much of this part of its history is common to lowly animal forms.

Conclusions.—It will be seen that there is much in common in the life-history of *Torula* and *Protococcus*. By virtue of being living protoplasm they transform unorganized material into their own substance; and they grow and reproduce by analogous methods.

But there are sharply defined differences. For the green plant sunlight is essential, in the presence of which its chlorophyll prepares the atmosphere for animals by the removal of carbonic anhydride and the addition of oxygen, while for *Torula* neither this gas nor sunlight is essential.

Moreover, the fungus (*Torula*) demands a higher kind of food, one more nearly related to the pabulum of animals; and is absolutely independent of sunlight, if not actually injured by it; not to mention the remarkable process of fermentation.

UNICELLAR ANIMALS.

THE PROTEUS ANIMALCULE (*Amœba*).

In order to illustrate animal life in its simpler form we choose the above-named creature, which is nearly as readily obtainable as *Protococcus* and often under the same circumstances.

Morphological.—*Amœba* is a microscopic mass of transparent protoplasm, about the size of the largest of the colorless blood-corpuseles of cold-blooded animals, with a clearer, more consistent outer zone (*ectosarc*), (although without any proper cell wall), and a more fluid, granular inner part. A clear space (*contractile vesicle, vacuole*) makes its appearance at intervals in the ectosarc, which may disappear somewhat suddenly. This appearance and vanishing have suggested the term pulsating or contracting vesicle. Both a nucleus and nucleolus may be seen in *Amœba*. At varying short periods certain parts of its body (*pseudopodia*) are thrust out and others withdrawn.

Physiological.—*Amœba* can not live on such food as proves adequate for either *Protococcus* or *Torula*, but requires, besides

inorganic and unorganized food, also organized matter in the form of a complex organic compound known as *protein*, which

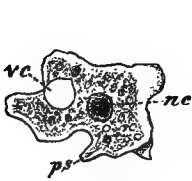

FIG. 8.

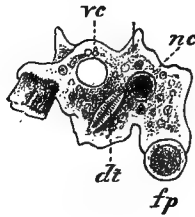

FIG. 9.



FIG. 10.

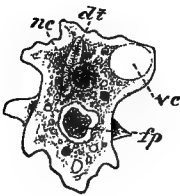

FIG. 11.



FIG. 12.



FIG. 13.

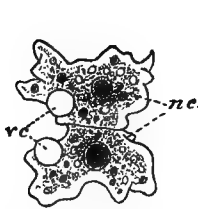

FIG. 14.

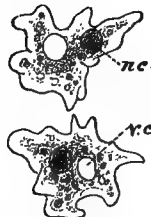

FIG. 15.

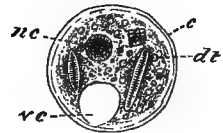

FIG. 16.

FIGS. 8 to 15, represent successive phases in the life-history of an Amœboid organism, kept under constant observation for three days; Fig. 16 a similar organism encysted, which was a few hours later set free by the disintegration of the cyst. (All the figures are drawn under Zeiss, D. 3.)

FIG. 8.—The locomotor phase; the ectoplasm is seen protruding to form a pseudopodium, into which the endoplasm passes.

FIG. 9.—A stage in the ingestive phase. A vegetable organism, *fp*, is undergoing intussusception.

FIG. 10.—A portion of the creature represented in Fig. 9 after complete ingestion of the food-particle.

FIGS. 11, 12.—Successive stages in the assimilative and excretory processes. Fig. 12 represents the organism some twenty hours later than as seen in Fig. 11. The undigested remnants of the ingested organism are represented undergoing ejection (excretion) at *fp*, in Fig. 12.

FIGS. 13, 14, 15, represent successive stages in the reproductive process of the same individual, observed two days later. It will be noticed (Fig. 13) that the nucleus divides first.

In the above figures, *vc*, denotes the contracting vacuole; *nc*, the nucleus; *ps*, pseudopodium; *dt*, diatom; *fp*, food-particle.

contains nitrogen in addition to carbon, hydrogen, and oxygen. In fact, Amœba can prey upon both plants and animals, and thus use up as food protoplasm itself. The pseudopodia serve the double purpose of organs of locomotion and prehension.

This creature absorbs oxygen and evolves carbon dioxide.

Inasmuch as any part of the body may serve for the admission, and possibly the digestion, of food and the ejection of the useless remains, we are not able to define the functions of special parts. *Amœba* exercises, however, some degree of choice as to what it accepts or rejects.

The movements of the pseudopodia cease when the temperature of the surrounding medium is raised or lowered beyond a certain point. It can, however, survive in a quiescent form greater depression than elevation of the temperature. Thus, at 35° C., heat-rigor is induced; at 40° to 45° C., death results; but though all movement is arrested at the freezing-point of water, recovery ensues if the temperature be gradually raised. Its form is modified by electric shocks and chemical agents, as well as by variations in the temperature. At the present time it is not possible to define accurately the functions of the vacuoles found in any of the organisms thus far considered. It is worthy of note that *Amœba* may spontaneously assume a spherical form, secrete a structureless covering, and remain in this condition for a variable period, reminding us of the similar behavior of *Torula*.

Amœba reproduces by fission, in which the nucleus takes a prominent if not a directive part, as seems likely it does in regard to all the functions of unicellular organisms.

Conclusions.—It is evident that *Amœba* is, in much of its behavior, closely related to both colored and colorless one-celled plants. All of the three classes of organisms are composed of protoplasm; each can construct protoplasm out of that which is very different from it; each builds up the inanimate inorganic world into itself by virtue of that force which we call vital, but which in its essence we do not understand; each multiplies by division of itself, and all can only live, move, and have their being under certain definite limitations. But even among forms of life so lowly as those we have been considering, the differences between the animal and vegetable worlds appear. Thus, *Amœba* never has a cellulose wall, and can not subsist on inorganic food alone. The cellulose wall is not, however, invariably present in plants, though this is generally the case; and there are animals (*Ascidians*) with a cellulose investment. Such are very exceptional cases. But the law that animals must have organized material (*protein*) as food is without exception, and forms a broad line of distinction between the animal and vegetable kingdoms.

Amœba will receive further consideration later; in the

mean time, we turn to the study of forms of life in many respects intermediate between plants and animals, and full of practical interest for mankind, on account of their relations to disease, as revealed by recent investigations.

PARASITIC ORGANISMS.

THE FUNGI.

MOLDS (*Penicillium Glaucum* and *Mucor Mucedo*).

Closely related to *Torula* physiologically, but of more complex structure, are the molds, of which we select for convenient study the common green mold (*Penicillium*), found growing in dark and moist places on bread and similar substances, and the white mold (*Mucor*), which grows readily on manure.

The fungi originate in *spores*, which are essentially like *Torula* in structure, by a process of budding and longitudinal extension, resulting in the formation of transparent branches or tubules, filled with protoplasm and invested by cellulose walls, across which transverse partitions are found at regular intervals, and in which vacuoles are also visible.

The spores, when growing thus in a liquid, give rise to upward branches (*aërial hyphæ*), and downward branches or rootlets (*submerged hyphæ*). These multitudinous branches interlace in every direction, forming an intricate felt-work, which supports the green powder (spores) which may be so easily shaken off from a growing mold. In certain cases the aërial hyphæ terminate in tufts of branches, which, by transverse division, become split up into spores (*Conidia*), each of which is similar in structure to a yeast-cell.

The green coloring matter of the fungi is not chlorophyl. The *Conidia* germinate under the same conditions as *Torula*.

Mucor Mucedo.—The growth and development of this mold may be studied by simply inverting a glass tumbler over some horse-dung on a saucer, into which a very little water has been poured, and keeping the preparation in a warm place.

Very soon whitish filaments, gradually getting stronger, appear, and are finally topped by rounded heads or spore-cases (*Sporangia*). These filaments are the *hyphæ*, similar in structure to those of *Penicillium*. The spore-case is filled with a multitude of oval bodies (*spores*), resulting from the subdivision of the protoplasm, which are finally released by the spore-

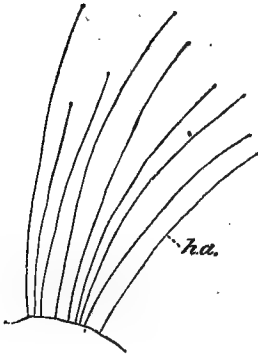

FIG. 17.



FIG. 22.



FIG. 23.



FIG. 24.

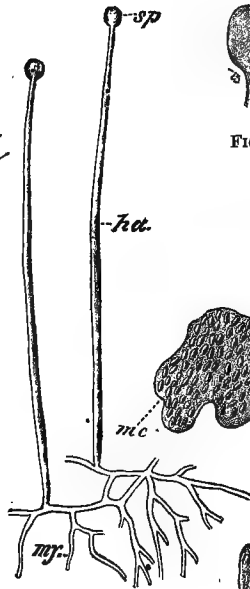

FIG. 18.



FIG. 19.

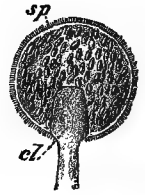

FIG. 20.

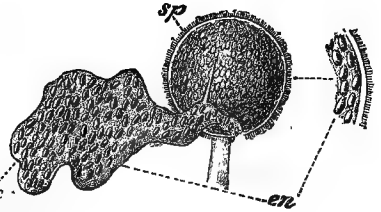

FIG. 21.

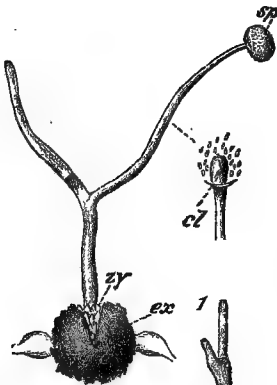

FIG. 27.



FIG. 25.



FIG. 26.

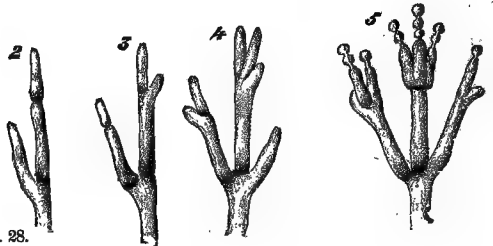

FIG. 28.

- FIGS. 17 to 28.—In the following figures, *ha*, denotes aerial hyphæ; *sp*, sporangium; *zy*, zygospore; *ex*, exosporium; *my*, mycelium; *mc*, mucilage; *cl*, columella; *en*, endogonidia.
- FIG. 17.—Spore-bearing hyphæ of *Mucor*, growing from horse-dung.
- FIG. 18.—The same, teased out with needles (A, 4).
- FIGS. 19, 20, 21.—Successive stages in the development of the sporangium.
- FIG. 22.—Isolated spores of *Mucor*.
- FIG. 23.—Germinating spores of the same mold.
- FIG. 24.—Successive stages in the germination of a single spore.
- FIGS. 25, 26, 27.—Successive phases in the conjugative process of *Mucor*.
- FIG. 28.—Successive stages observed during ten hours in the growth of a conidiophore of *Penicillium* in an object-glass culture (D, 4).

case becoming thinned to the point of rupture. The development of these spores takes place in substantially the same manner as those of *Penicillium*. Sporangia developing spores in this fashion by division of the protoplasm are termed *asci*, and the spores *ascospores*.

So long as nourishment is abundant and the medium of growth fluid, this *asexual* method of reproduction is the only one; but, under other circumstances, a mode of increase, known as *conjugation*, arises. Two adjacent hyphæ enlarge at the extremities into somewhat globular heads, bend over toward each other, and, meeting, their opposed faces become thinned, and the contents intermingle. The result of this union (*zygospore*) undergoes now certain further changes, the cellulose coat being separated into two—an outer, darker in color (*exosporium*), and an inner colorless one (*endosporium*).

Under favoring circumstances these coats burst, and a branch sprouts forth from which a vertical tube arises that terminates in a sporangium, in which spores arise, as before described. It will be apparent that we have in *Mucor* the exemplification of what is known in biology as "*alternation of generations*"—that is, there is an intermediate generation between the original form and that in which the original is again reached.

Physiologically the molds closely resemble yeast, some of them, as *Mucor*, being capable of exciting a fermentation.

The fungi are of special interest to the medical student, because many forms of cutaneous disease are directly associated with their growth in the epithelium of the skin, as, for example, common ringworm; and their great vitality, and the facility with which their spores are widely dispersed, explain the highly contagious nature of such diseases. The media on which they flourish (feed) indicates their great physiological differences in this particular from the green plants proper. They are closely related in not a few respects to an important class of vegetable organisms, known as bacteria, to be considered forthwith.

THE BACTERIA.

The *bacteria* include numberless varieties of organisms of extreme minuteness, many of them visible only by the help of the most powerful lenses. Their size has been estimated at from $\frac{1}{30000}$ to $\frac{1}{10000}$ of an inch in diameter.

They grow mostly in the longitudinal direction, and reproduce by transverse division, forming spores from which new generations arise.

Some of them have vibratile cilia, while the cause of the movements of others is quite unknown.

As in many other lowly forms of life, there is a quiescent as well as an active stage. In this stage (*zoöglæa form*) they

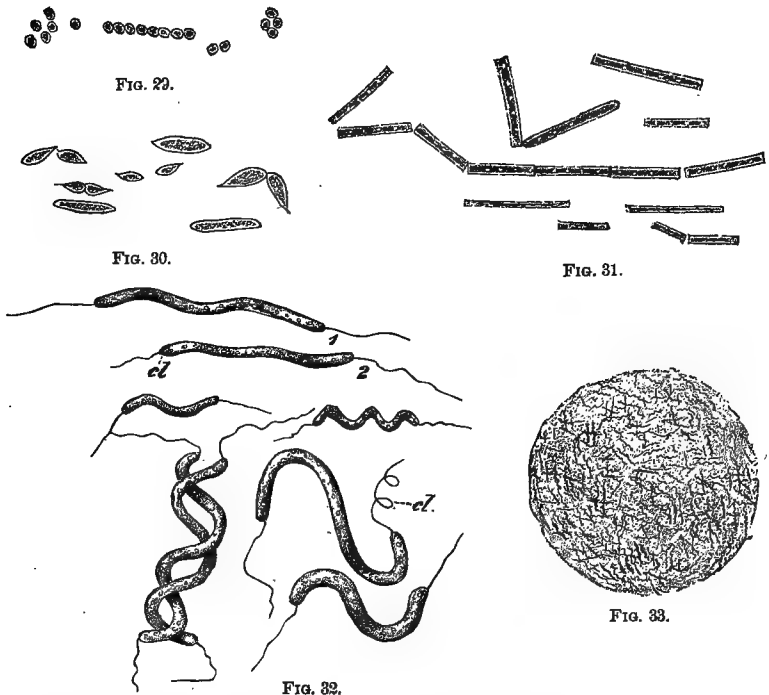

FIG. 29.—Micrococcus, very like a spore, but usually much smaller.

FIG. 30.—Bacterium.

FIG. 31.—Bacillus. The central filament presented this segmented appearance as the result of a process of transverse division occurring during ten minutes' observation.

FIG. 32.—Spirillum; various forms. The first two represent vibrio, which is possibly only a stage of spirillum.

FIG. 33.—A drop of the surface scum, showing a spirillum aggregate in the resting state.

are surrounded by a gelatinous matter, probably secreted by themselves.

Bacteria grow and reproduce in Pasteur's solution, rendering it opaque, as well as in almost all fluids that abound in proteid matter. That such fluids readily putrefy is owing to the presence of bacteria, the vital action of which suffices to break asunder complex chemical compounds and produce new ones. Some of the bacteria require oxygen, as *Bacillus anthracis*, while others do not, as the organism of putrefaction, *Bacterium termo*.

Bacteria are not so sensitive to slight variations in temperature as most other organisms. They can, many of them, withstand freezing and high temperatures. All bacteria and all germs of bacteria are killed by boiling water, though the spores are much more resistant than the mature organisms themselves. Some spores can resist a dry heat of 140° C.

The spores, like *Torula* and *Protococcus*, bear drying, without loss of vitality, for considerable periods.

That different groups of bacteria have a somewhat different life-history is evident from the fact that the presence of one checks the other in the same fluid, and that successive swarms of different kinds may flourish where others have ceased to live.

That these organisms are enemies of the constituent cells of the tissues of the highest mammals has now been abundantly demonstrated. That they interfere with the normal working of the organism in a great variety of ways is also clear; and certain it is that the harm they do leads to aberration in cell-life, however that may be manifested. They rob the tissues of their nutriment and oxygen, and poison them by the products of the decompositions they produce. But apart from this, their very presence as foreign agents must hamper and derange the delicate mechanism of cell-life.

These organisms seem to people the air, land, and waters with invisible hosts far more numerous than the forms of life we behold. Fortunately, they are not all dangerous to the higher forms of mammalian life; but that a large proportion of the diseases which afflict both man and the domestic animals are directly caused, in the sense of being invariably associated with, the presence of such forms of life, is now beyond doubt.

The facts stated above explain why that should be so; why certain maladies should be infectious; how the germs of disease may be transported to a friend wrapped up in the folds of a letter.

Disease thus caused, it must not be forgotten, is an illustra-

tion of the struggle for existence and the survival of the fittest. If the cells of an organism are mightier than the bacteria, the latter are overwhelmed; but if the bacteria are too great in numbers or more vigorous, the cells must yield; the battle may waver—now dangerous disease, now improvement—but in the end the strongest in this, as in other instances, prevail.

UNICELLULAR ANIMALS WITH DIFFERENTIATION OF STRUCTURE.

THE BELL-ANIMALCULE (*Vorticella*).

Amœba is an example of a one-celled animal with little perceptible differentiation of structure or corresponding division of physiological labor. This is not, however, the case with all unicellular animals, and we proceed to study one of these with considerable development of both. The Bell-animalcule is found in both fresh and salt water, either single or in groups. It is anchored to some object by a rope-like stalk of clear protoplasm, that has a spiral appearance when contracted; and which, with a certain degree of regularity, shortens and lengthens alternately, suggesting that more definite movement (contraction) of the form of protoplasm known as *muscle*, to be studied later.

The body of the creature is bell-shaped, hence its name; the bell being provided with a thick everted lip (*peristome*), covered with bristle-like extensions of the protoplasm (*cilia*), which are in almost constant rhythmical motion. Covering the mouth of the bell is a lid, attached by a hinge of protoplasm to the body, which may be raised or lowered. A wide, funnel-like depression (*œsophagus*) leads into the softer substance within which it ends blindly. The outer part of the animal (*cuticula*) is denser and more transparent than any other part of the whole creature; next to this is a portion more granular and of intermediate transparency between the external and innermost portions (*cortical layer*). Below the disk is a space (*contractile vesicle*) filled with a thin, clear fluid, which may be seen to enlarge slowly and then to collapse suddenly. When the *Vorticella* is feeding, these vesicles may contain food-particles, and in the former, apparently, digestion goes on. Such food vacuoles (*vesicles*) may circulate up one side of the body of the animal and down the other. Their exact significance is not known, but it would appear as if digestion went on within them; and

possibly the clear fluid with which they are filled may be a special secretion with solvent action on food.

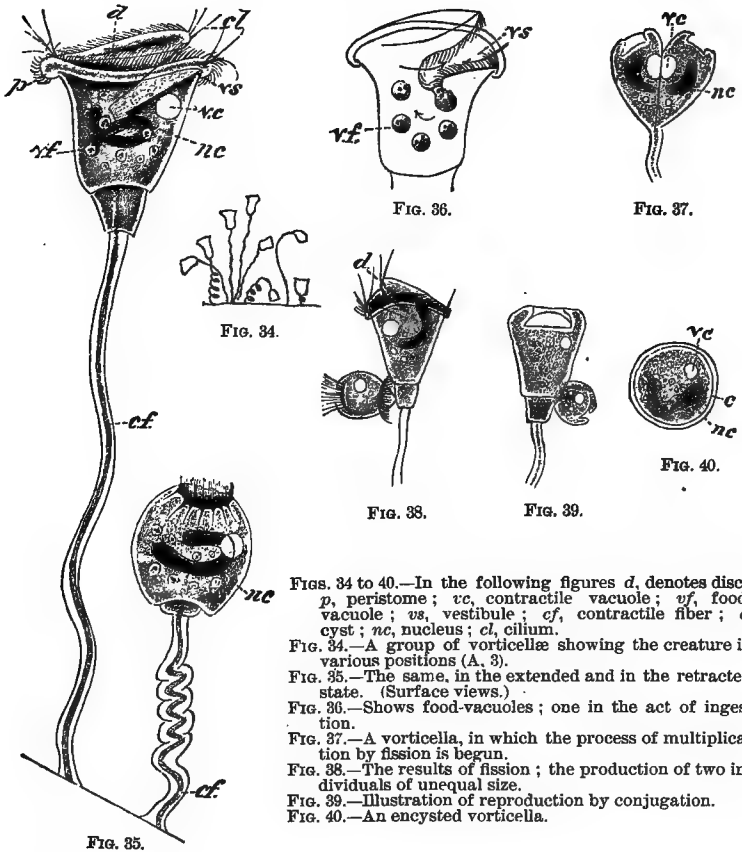

FIGS. 34 to 40.—In the following figures *d*, denotes disc; *p*, peristome; *vc*, contractile vacuole; *vf*, food-vacuole; *vs*, vestibule; *cf*, contractile fiber; *c*, cyst; *nc*, nucleus; *cl*, cilium.
 FIG. 34.—A group of vorticellæ showing the creature in various positions (A, 3).
 FIG. 35.—The same, in the extended and in the retracted state. (Surface views.)
 FIG. 36.—Shows food-vacuoles; one in the act of ingestion.
 FIG. 37.—A vorticella, in which the process of multiplication by fission is begun.
 FIG. 38.—The results of fission; the production of two individuals of unequal size.
 FIG. 39.—Illustration of reproduction by conjugation.
 FIG. 40.—An encysted vorticella.

Situated somewhat centrally is a horseshoe-shaped body, with well-defined edges, which stains more readily than the rest of the cell, indicating a different chemical composition; and, from the prominent part it takes in the reproductive and other functions of the creature, it may be considered the nucleus (*endoplast*).

Multiplication of the species is either by *gemmation* or by *fission*. In the first case the nucleus divides and the fragments are transformed into locomotive germs; in the latter the entire animal, including the nucleus, divides longitudinally, each half becoming a similar complete, independent organism. Still an-

other method of reproduction is known. A more or less globular body encircled with a ring of cilia and of relatively small size may sometimes be seen attached to the usual form of Vorticella, with which it finally becomes blended into one mass. This seems to foreshadow the "sexual conjugation" of higher forms, and is of great biological significance.

Vorticella may pass into an encysted and quiescent stage for an indefinite period and again become active. The history of the Bell-animalcule is substantially that of a vast variety of one-celled organisms known as *Infusoria*, to which Amœba itself belongs. It will be observed that the resemblance of this organism to Amœba is very great; it is, however, introduced here to illustrate an advance in differentiation of structure; and to show how, with the latter, there is usually a physiological advance also, since there is additional functional progress or division of labor; but still the whole of the work is done within one cell. Amœba and Vorticella are both factories in which all of the work is done in one room, but in the latter case the machinery is more complex than in the former; there are correspondingly more processes, and each is performed with greater perfection. Thus, food in the case of the Bell-animalcule is swept into the gullet by the currents set up by the multitudes of vibrating arms around this opening and its immediate neighborhood; the contractile vesicles play a more prominent part; and the waste of undigested food is ejected at a more definite portion of the body, the floor of the œsophagus; while all the movements of the animal are rhythmical to a degree not exemplified in such simple forms as Amœba; not to mention its various resources for multiplication and, therefore, for its perpetuation and permanence as a species. It, too, like all the unicellular organisms we have been considering, is susceptible of very wide distribution, being capable of retaining vitality in the dried state, so that these infusoria may be carried in various directions by winds in the form of microscopic dust.

MULTICELLULAR ORGANISMS.

THE FRESH-WATER POLYPS (*Hydra viridis*; *Hydra fusca*).

The comparison of an animal so simple in structure, though made up of many cells, as the Polyp, with the more complex organizations with which we shall have especially to deal, may

be fitly undertaken at this stage. The Polyps are easily obtainable from ponds in which they are found attached to various kinds of weeds. To the naked eye, they resemble translucent masses of jelly with a greenish or reddish tinge. They range in size from one quarter to one half an inch; are of an elongated cylindrical form; provided at the oral extremity with thread-like tentacles of considerable length, which are slowly moved about in all directions; but they and the entire body may shorten rapidly into a globular mass. They are usually attached at the opposite (aboral) pole to some object, but may float free, or slowly crawl from place to place. It may be observed, under the microscope, that the tentacles now and then embrace some living object, convey it toward an opening (mouth) near their base, from which, from time to time, refuse material is cast out. It may be noticed, too, that a living object within the touch of these tentacles soon loses the power to struggle, which is owing to the peculiar cells (*nettle-cells*, *urticating capsules*, *nematocysts*) with which they are abundantly provided, and which secrete a poisonous fluid that paralyzes prey.

The mouth leads into a simple cavity (*cœlom*) in which digestion proceeds. The green color in *Hydra viridis*, and the red color of *Hydra fusca*, is owing to the presence of *chlorophyl*, the function of which is not known. *Hydra* is structurally a sac, made up of two layers of cells, an outer (*ectoderm*) and an inner (*endoderm*); the tentacles being repetitions of the structure of the main body of the animal, and so hollow and composed of two cell layers. Speaking generally, the outer layer is devoted to obtaining information of the surroundings; the inner to the work of preparing nutriment, and probably, also, discharging waste matters, in which latter assistance is also received from the outer layer. As digestion takes place largely within the cells themselves, or is intracellular, we are reminded of *Vorticella* and still more of *Amœba*. There is in *Hydra* a general advance in development, but not very much individual cell specialization. That of the urticating capsules is one of the best examples of such specialization in this creature. A Polyp is like a colony of *Amœbæ* in which some division of labor (function) has taken place; a sort of biological state in which every individual is nearly equal to his neighbor, but somewhat more advanced than those neighbors not members of the organization.

But in one respect the Polyps show an enormous advance. Ordinarily when nourishment is abundant *hydra* multiplies by

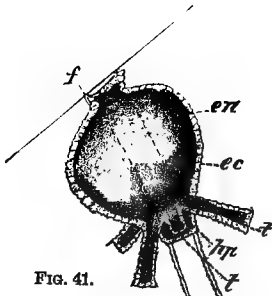

FIG. 41.

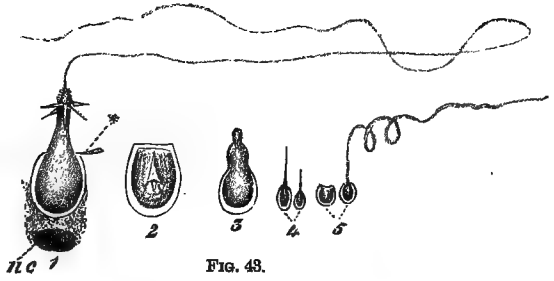

FIG. 43.

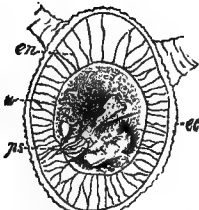

FIG. 42.

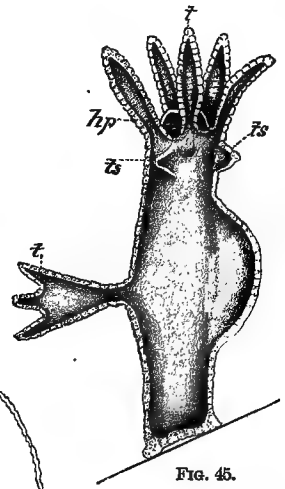

FIG. 45.

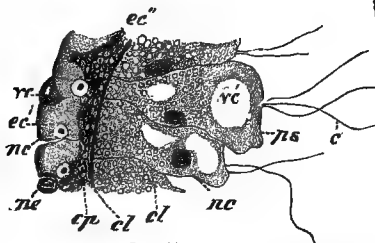

FIG. 44.

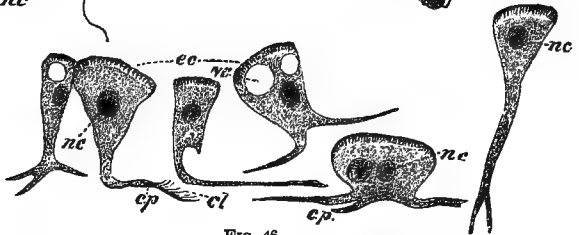

FIG. 46.

FIGS. 41 to 46.—In the following figures, *ec*, denotes ectoderm; *en*, endoderm; *t*, tentacle; *hp*, hypostome; *f*, foot; *ts*, testes; *ov*, ovary; *ps*, pseudopodium; *ec'*, larger ectoderm-cells; *ne'*, larger nematocysts before rupture; *cp*, Kleinenberg's fibers; *c.l.*, supporting lamella; *cl*, chlorophyl-forming bodies; *c*, cilium

FIG. 41.—The green hydra, at the maximum of contraction and elongation of its body. The creature is represented in the act of seizing a small crustacean (A, 2).

FIG. 42.—Transverse section across the body of a hydra, in the digestive cavity of which a small crustacean is represented.

FIG. 43.—The leading types of thread-cells, after liberation from the body (F, 3). The cells are represented in the active and the resting conditions; in the former all the parts are more distinctly seen in consequence of the necessary eversion.

FIG. 44.—Small portion of a transverse section across the body of a green hydra (D, 3).

FIG. 45.—A large brown hydra bearing at the same time buds produced asexually and sexual organs.

FIG. 46.—Larger cells of the ectoderm isolated. Note the processes of the cells or Kleinenberg's fibers. (F, 3.)

All of the cuts on pages, 9, 11, 13, 16, 18, 21 and 24, have been selected from Howes' "Atlas of Biology."

budding, and when cut into portions each may become a complete individual. However, under other circumstances, near the bases of the tentacles the body wall may protrude into little masses (*testes*), in which cells of peculiar formation (*spermatozoa*) arise, and are eventually set free and unite with a cell (*ovum*) formed in a similar protrusion of larger size (*ovary*). Here, then, is the first instance in which distinctly sexual reproduction has been met in our studies of the lower forms of life. This is substantially the same process in *Hydra* as in mammals. But, as both male and female cells are produced by the same individual, the sexes are united (*hermaphroditism*); each is at once male and female.

Any one watching the movements of a Polyp, and comparing it with those of a Bell-animalcule, will observe that the former are much less machine-like; have greater range; seem to be the result of a more deliberate choice; are better adapted to the environment, and calculated to achieve higher ends. In the absence of a nervous system it is not easy to explain how one part moves in harmony with another, except by that process which seems to be of such wide application in nature, adaptation from habitual simultaneous effects on a protoplasm capable of responding to stimuli. When one process of an *Amœba* is touched, it is likely to withdraw all. This we take to be due to influences radiating through molecular movement to other parts; the same principle of action may be extended to *Hydra*. The oftener any molecular movement is repeated, the more it tends to become organized into regularity, to become fixed in its mode of action; and if we are not mistaken this is a fundamental law throughout the entire world of living things, if not of all things animate and inanimate alike. To this law we shall return.

But *Hydra* is a creature of but very limited specializations; there are neither organs of circulation, respiration, nor excretion,

if we exclude the doubtful case of the thread-cells (*urticating capsules*). The animal breathes by the entire surface of the body; nourishment passes from cell to cell, and waste is discharged into the water surrounding the creature from all cells, though probably not quite equally. All parts are not digestive, respiratory etc., to the same degree, and herein does it differ greatly from *Amœba* or even *Vorticella*, though fuller knowledge will likely modify our views of the latter two and similar organisms in this regard.

THE CELL RECONSIDERED.

Having now studied certain one-celled plants and animals, and some very simple combinations of cells (molds, etc.), it will be profitable to endeavor to generalize the lessons these humble organisms convey; for, as will be constantly seen in the study of the higher forms of life of which this work proposes to treat principally, the same laws operate as in the lowliest living creatures. The most complex organism is made up of tissues, which are but cells and their products, as houses are made of bricks, mortar, wood, and a few other materials, however large or elaborate.

The student of physiology who proceeds scientifically must endeavor, in investigating the functions of each organ, to learn the exact behavior of each cell as determined by its own inherent tendencies, and modified by the action of neighboring cells. The reason why the function of one organ differs from that of another is that its cells have departed in a special direction from those properties common to all cells, or have become functionally *differentiated*. But such a statement has no meaning unless it be well understood that cells have certain properties in common. This is one of the lessons imparted by the preceding studies which we now review. Briefly stated in language now extensively used in works on biology, the common properties of cells (protoplasm), whether animal or vegetable, whether constituting in themselves entire animals or plants, or forming the elements of tissues, are these: The collective chemical processes associated with the vital activities of cells are termed its *metabolism*. Metabolism is *constructive* when more complex compounds are formed from simpler ones, as when the *Protococcus*-cell builds up its protoplasm out of the simple materials, found in rain-water, which make up its food. Metabolism is *destruct-*

ive when the reverse process takes place. The results of this process are eliminated as *excreta*, or useless and harmful products. Since all the vital activities of cells can only be manifested when supplied with food, it follows that living organisms convert *potential* or possible energy into *kinetic* or actual energy. When lifeless, immobile matter is taken in as food and, as a result, is converted by a process of *assimilation* into the protoplasm of the cell using it, we have an example of potential being converted into actual energy, for one of the properties of all protoplasm is its *contractility*. Assimilation implies, of course, the absorption of what is to be used, with rejection of waste matters.

The movements of protoplasm of whatever kind, when due to a stimulus, are said to indicate *irritability*; while, if independent of any external source of excitation, they are denominated *automatic*.

Among agents that modify the action of all kinds of protoplasm are heat, moisture, electricity, light, and others in great variety, both chemical and mechanical. It can not be too well remembered that living things are what they are, neither by virtue of their own organization alone nor through the action of their environment alone (else would they be in no sense different from inanimate things), but because of the relation of the organization to the surroundings.

Protoplasm, then, is *contractile*, *irritable*, *automatic*, *absorptive*, *secretory* (and *excretory*), *metabolic*, and *reproductive*.

But when it is affirmed that these are the fundamental properties of all protoplasm, the idea is not to be conveyed that cells exhibiting these properties are identical biologically. No two masses of protoplasm can be quite alike, else would there be no distinction in physiological demeanor—no individuality. Every cell, could we but behold its inner molecular mechanism, differs from its neighbor. When this difference reaches a certain degree in one direction, we have a manifest differentiation leading to physiological division of labor, which may now with advantage be treated in the following section.

THE ANIMAL BODY.

An animal, as we have learned, may be made up of a single cell in which each part performs much the same work; or, if there be differences in function, they are ill-defined as compared

with those of higher animals. The condition of things in such an animal as *Amœba* may be compared to a civilized community in a very crude social condition. When each individual tries to perform every office for himself, he is at once carpenter, blacksmith, shoemaker, and much more, with the natural result that he is not efficient in any one direction. A community may be judged in regard to its degree of advancement by the amount of division of labor existing within it. Thus is it with the animal body. We find in such a creature as the fresh-water *Hydra*, consisting of two layers of cells forming a simple sac, a slight amount of advancement on *Amœba*. Its external surface no longer serves for inclosure of food, but it has the simplest form of mouth and tentacles. Each of the cells of the internal layer seems to act as a somewhat improved or specialized *Amœba*, while in those of the outer layer we mark a beginning of those functions which taken collectively give the higher animals information of the surrounding world.

Looking to the existing state of things in the universe, it is plain that an animal to attain to high ends must have powers of rapid locomotion, capacity to perceive what makes for its interest, and ability to utilize means to attain this when perceived. These considerations demand that an animal high in the scale of being should be provided with limbs sufficiently rigid to support its weight, moved by strong muscles, which must act in harmony. But this implies abundance of nutriment duly prepared and regularly conveyed to the bones and muscles. All this would be useless unless there was a controlling and energizing system capable both of being impressed and originating impressions. Such is found in the nerves and nerve-centers. Again, in order that this mechanism be kept in good running order, the waste of its own metabolism, which chokes and poisons, must be got rid of—hence the need of excretory apparatus. In order that the nervous system may get sufficient information of the world around, the surface of the body must be provided with special message-receiving offices in the form of modified nerve-endings. In short, it is seen that an animal as high in the scale as a mammal must have muscular, osseous (and connective), digestive, circulatory, excretory, and nervous tissues; and to these may be added certain forms of protective tissues, as hair, nails, etc.

Assuming that the student has at least some general knowledge of the structure of these various tissues, we propose to tell in a simple way the whole physiological story in brief.

The blood is the source of all the nourishment of the organism, including its oxygen supply, and is carried to every part of the body through elastic tubes which, continually branching and becoming gradually smaller, terminate in vessels of hair-like fineness in which the current is very slow—a condition permitting that interchange between the cells surrounding them and the blood which may be compared to a process of barter, the cells taking nutriment and oxygen, and giving (excreting) in return carbonic anhydride. From these minute vessels the blood is conveyed back toward the source whence it came by similar elastic tubes which gradually increase in size and become fewer. The force which directly propels the blood in its onward course is a muscular pump, with both a forcing and suction action, though chiefly the former. The flow of blood is maintained constant owing to the resistance in the smaller tubes on the one hand and the elastic recoil of the larger tubes on the other; while in the returning vessels the column of blood is supported by elastic double gates which so close as to prevent reflux. The oxygen of the blood is carried in disks of microscopic size which give it up in proportion to the needs of the tissues past which they are carried.

But in reality the tissues of the body are not nourished directly by the blood, but by a fluid derived from it and resembling it greatly in most particulars. This fluid bathes the tissue-cells on all sides. It also is taken up by tubes that convey it into the blood after it has passed through little factories (lymphatic glands), in which it undergoes a regeneration. Since the tissues are impoverishing the blood by withdrawal of its constituents, and adding to it what is no longer useful, and is in reality poisonous, it becomes necessary that new material be added to it and the injurious components withdrawn. The former is accomplished by the absorption of the products of food digestion, and the addition of a fresh supply of oxygen derived from without, while the poisonous ingredients that have found their way into the blood are got rid of through processes that may be, in general, compared to those of a sewage system of a very elaborate character. To explain this regeneration of the blood in somewhat more detail, we must first consider the fate of food from the time it enters the mouth till it leaves the tract of the body in which its preparation is carried on.

The food is in the mouth submitted to the action of a series of cutting and grinding organs worked by powerful muscles;

mixed with a fluid which changes the starchy part of it into sugar, and prepares the whole to pass further on its course: when this has been accomplished, the food is grasped and squeezed and pushed along the tube, owing to the action of its own muscular cells, into a sac (stomach), in which it is rolled about and mixed with certain fluids of peculiar chemical composition derived from cells on its inner surface, which transform the proteid part of the food into a form susceptible of ready use (absorption). When this saccular organ has done its share of the work, the food is moved on by the action of the muscles of its walls into a very long portion of the tract in which, in addition to processes carried on in the mouth and stomach, there are others which transform the food into a condition in which it can pass into the blood. Thus, all of the food that is susceptible of changes of the kind described is acted upon somewhere in the long tract devoted to this task. But there is usually a remnant of indigestible material which is finally evacuated. How is the prepared material conveyed into the blood? In part, directly through the walls of the minutest blood-vessels distributed throughout the length of this tube; and in part through special vessels with appropriate cells covering them which act as minute porters (*villi*).

The impure blood is carried periodically to an extensive surface, usually much folded, and there exposed in the hair-like tubes referred to before, and thus parts with its excess of carbon dioxide and takes up fresh oxygen. But all the functions described do not go on in a fixed and invariable manner, but are modified somewhat according to circumstances. The forcing-pump of the circulatory system does not always beat equally fast; the smaller blood-vessels are not always of the same size, but admit more or less blood to an organ according to its needs.

This is all accomplished in obedience to the commands carried from the brain and spinal cord along the nerves. All movements of the limbs and other parts are executed in obedience to its behests; and in order that these may be in accordance with the best interests of each particular organ and the whole animal, the nervous centers, which may be compared to the chief officers of, say, a telegraph or railway system, are in constant receipt of information by messages carried onward along the nerves. The command issuing is always related to the information arriving.

All those parts commonly known as sense-organs—the eye,

ear, nose, tongue, and the entire surface of the body—are faithful reporters of facts. They put the inner and outer worlds in communication, and without them all higher life at least must cease, for the organism, like a train directed by a conductor that disregards the danger-signals, must work its own destruction. Without going into further details, suffice it to say that the processes of the various cells are subordinated to the general good through the nervous system, and that susceptibility of protoplasm to stimuli of a delicate kind which enables each cell to adapt to its surroundings, including the influence of remote as well as neighboring cells. Without this there could be no marked advance in organisms, no differentiation of a pronounced character, and so none of that physiological division of labor which will be inferred from our brief description of the functions of a mammal. The whole of physiology but illustrates this division of labor.

It is hoped that the above account of the working of the animal body, brief as it is, may serve to show the connection of one part functionally with another, for it is much more important that this should be kept in mind throughout, than that all the details of any one function should be known.

LIVING AND LIFELESS MATTER.

In order to enable the student the better to realize the nature of living matter or protoplasm, and to render clearer the distinction between the forms that belong to the organic and inorganic worlds respectively, we shall make some comparisons in detail which it is hoped may accomplish this object.

A modern watch that keeps correct time must be regarded as a wonderful object, a marvelous triumph of human skill. That it has aroused the awe of savages, and been mistaken for a living being, is not surprising. But, admirable as is the result attained by the mechanism of a watch, it is, after all, composed of but a few metals, etc., chiefly in fact of two, brass and steel; these are, however, made up into a great number of different parts, so adapted to one another as to work in unison and accomplish the desired object of indicating the time of day.

Now, however well constructed the watch may be, there are waste, wear and tear, which will manifest themselves more and

more, until finally the machine becomes worthless for the purpose of its construction. If this mechanism possessed the power of adapting from without foreign matter so as to construct it into steel and brass and arrange this just when required, it would imitate a living organism; but this it can not do, nor is its waste chemically different from its component metals; it does not break up brass and steel into something wholly different. In one particular it does closely resemble living things, in that it gradually deteriorates; but the degradation of a living cell is the consequence of an actual change in its component parts, commonly a fatty degeneration. The one is a real transformation, the other mere wear.

Had the watch the power to give rise to a new one like itself by any process, especially a process of division of itself into two parts, we should have a parallel with living forms; but the watch can not even renew its own parts, much less give rise to a second mechanism like itself. Here, then, is a manifest distinction between living and inanimate things.

Suppose further that the watch was so constructed that, after the lapse of a certain time, it underwent a change in its inner machinery and perhaps its outer form, so as to be scarcely recognizable as the same; and that as a result, instead of indicating the hours and minutes of a time-reckoning adapted to the inhabitants of our globe, it indicated time in a wholly different way; that after a series of such transformations it fell to pieces—took the original form of the metals from which it was constructed—we should then have in this succession of events a parallel with the development, decline, and death of living organisms.

In another particular our illustration of a watch may serve a useful purpose. Suppose a watch to exist, the works of which are so concealed as to be quite inaccessible to our vision, so that all we know of it is that it has a mechanism which when in action we can hear, and the result of which we perceive in the movements of the hands on the face; we should then be in the exact position in reference to the watch that we now are as regards the molecular movements of protoplasm. On the latter the entire behavior of living matter depends; yet it is absolutely hidden from us.

We know, too, that variations must be produced in the mechanism of time-pieces by temperature, moisture, and other influences of the environment, resulting in altered action. The same, as will be shown in later chapters, occurs in protoplasm.

This, too, is primarily a molecular effect. If the works of watches were beyond observation, we should not be able to state exactly how the variations observed in different kinds, or even different individuals of the same kind occurred, though these differences might be of the most marked character, such as any one could recognize. Here once more we refer the differences to the mechanism. So is it with living beings: the ultimate molecular mechanism is unknown to us.

Could we but render these molecular movements visible to our eyes, we should have a revelation of far greater scientific importance than that unfolded by the recent researches into those living forms of extreme minuteness that swarm everywhere as dust in a sunbeam, and, as will be learned later, are often the source of deadly disease. Like the movements of the watch, the activities of protoplasm are ceaseless. A watch that will not run is, as such, worthless—it is mere metal—has undergone an immense degradation in the scale of values; so protoplasm is no longer protoplasm when its peculiar molecular movements cease; it is at once degraded to the rank of dead matter.

The student may observe that each of the four propositions, embodying the fundamental properties of living matter, stated in the preceding chapter, have been illustrated by the simile of a watch. Such an illustration is necessarily crude, but it helps one to realize the meaning of truths which gather force with each living form studied if regarded aright; and it is upon the *realization* of truth that mental growth as well as practical efficiency depends.

CLASSIFICATION OF THE ANIMAL KINGDOM.

There are human beings so low in the scale as not to possess such general terms as tree, while they do employ names for different kinds of trees. The use of such a word as "tree" implies generalization, or the abstraction of a set of qualities from the things in which they reside, and making them the basis for the grouping of a multitude of objects by which we are surrounded. Manifestly without such a process knowledge must be very limited, and the world without significance; while in proportion as generalization may be safely widened, is our progress in the *unification* of knowledge toward which science is tending. But it also follows that without complete knowl-

edge there can be no perfect classification of objects; hence, any classification must be regarded but as the temporary creed of science, to be modified with the extension of knowledge. As a matter of fact, this has been the history of all zoölogical and other systems of arrangement. The only purpose of grouping is to simplify and extend knowledge; this being the case, it follows that a method of grouping that accomplishes this has value, though the system may be *artificial* that is based on resemblances which, though real and constant, are associated with differences so numerous and radical that the total amount of likeness between objects thus grouped is often less than the difference. Such a system was that of Linnæus, who classified plants according to the number of stamens, etc., they bore.

Seeing that animals which resemble each other are of common descent from some earlier form, to establish the line of descent is to determine in great part the classification. Much assistance in this direction is derived from embryology, or the history of the development of the individual (*ontogeny*); so that it may be said that the ontogeny indicates, though it does not actually determine, the line of descent (*phylogeny*); and it is owing to the importance of this truth that naturalists have in recent years given so much attention to comparative embryology.

It will be inferred that a *natural* system of classification must be based both on function and structure, though chiefly on the latter, since organs of very different origin may have a similar function; or, to express this otherwise, *homologous* structures may not be *analogous*; and homology gives the better basis for classification. To illustrate, the wing of a bat and a bird are both homologous and analogous; the wing of a butterfly is analogous but not homologous with these; manifestly, to classify bats and birds together would be better than to put birds and insects in the same group, thus leaving other points of relationship out of consideration.

The broadest possible division of the animal kingdom is into groups, including respectively one-celled and many-celled forms—i. e., into *Protozoa* and *Metazoa*. As the wider the grouping the less are differences considered, it follows that the more subdivided the groups the more complete is the information conveyed: thus, to say that a dog is a metazoan is to convey a certain amount of information; that it is a vertebrate, more; that it is a mammal, a good deal more, because each of the latter terms includes the former.

Animal Kingdom.	Invertebrata.	Protozoa (amœba, vorticella, etc.).
		Coelenterata (sponges, jelly-fish, polyps, etc.).
		Echinodermata (star-fish, sea-urchins, etc.).
		Vermes (worms).
		Arthropods (crabs, insects, spiders, etc.).
		Mollusca (oysters, snails, etc.).
		Molluscoidea (moss-like animals).
		Tunicata (ascidians).
	Vertebrata.	Pisces (fishes).
		Amphibia (frogs, menobranchus, etc.).
		Reptilia (snakes, turtles, etc.).
		Aves (birds).
		Mammalia (domestic quadrupeds, etc.).

The above classification (of Claus) is, like all such arrangements, but the expression of one out of many methods of viewing the animal kingdom.

For the details of classification and for the grounds of that we have presented, we refer the student to works on zoölogy; but we advise those who are not familiar with this subject, when a technical term is used, to think of that animal belonging to the group in question with the structure of which they are best acquainted.

MAN'S PLACE IN THE ANIMAL KINGDOM.

It is no longer the custom with zoölogists to place man in an entirely separate group by himself; but he is classed with the primates, among which are also grouped the anthropoid apes (gorilla, chimpanzee, orang, and the gibbon), the monkeys of the Old and of the New World, and the lemurs. So great is the structural resemblance of man and the other primates that competent authorities declare that there is more difference between the structure of the most widely separated members of the group than between certain of the anthropoid apes and man.

The points of greatest resemblance between man and the anthropoid apes are the following: The same number of vertebræ; the same general shape of the pelvis; a brain distinguishing them from other mammals; and posture, being bipeds.

The distinctive characters are size, rather than form of the brain, that of man being more than twice as large; a relatively larger cranial base, by which, together with the greater size of the jaws, the face becomes prominent; the earlier closure of the sutures of the cranium, arresting the growth of the brain; more developed canine teeth and difference in the order of eruption of the permanent teeth; the more posterior position of the foramen magnum; the relative length of the limbs to

each other and the rest of the body ; minor differences in the hands and feet, especially the greater freedom and power of apposition of the great-toe.

But the greatest distinction between man and even his closest allies among the apes is to be found in the development to an incomparably higher degree of his intellectual and moral nature, corresponding to the differences in weight and structure of the human brain, and associated with the use of spoken and written language ; so that the experience of previous generations is not only registered in the organism (heredity), but in a form more quickly available (books, etc.).

The greatest structural difference between the races of men are referable to the cranium ; but, since they all interbreed freely, they are to be considered varieties of one species.

THE LAW OF PERIODICITY OR RHYTHM IN NATURE.

The term *rhythm* to most minds suggests music, poetry, or dancing, in all of which it forms an essential part so simple, pronounced, and uncomplicated as to be recognized by all with ease.

The regular division of music into bars, the recurrence of chords of the same notes at certain intervals, of *forte* and *piano*, seem to be demanded by the very nature of the human mind. The same applies to poetry. Even a child that can not understand the language used, or an adult listening to recitations in an unknown tongue, enjoys the flow and recurrences of the sounds. Dancing has in all ages met a want in human organizations, which is partly supplied in quieter moods by the regularity of the steps in walking and similar simple movements.

But as rhythm runs through all the movements of animals, so is it also found in all literature and all art. Infinite variety wearies the mind, hence the fatigue felt by the sight-seer. Recurrence permits of repose, and gratifies an established taste or appetite. The mind delights in what it has once enjoyed, in repetition within limits. Repetition with variety is manifestly a condition of the growth and development of the mind. This seems to apply equally to the body, for every single function of each organism, however simple or complex it may be, exemplifies this law of periodicity. The heart's action is rhythmical (*beats*) ; the blood flows in intermitting gushes from the central pump ; the to-and-fro movements of respiration are so regular

that their cessation would arouse the attention of the least instructed; food is demanded at regular intervals; the juices of the digestive tract are poured out, not constantly but periodically; the movements by which the food is urged along its path are markedly rhythmic; the chemical processes of the body wax and wane like the fires in a furnace, giving rise to regular augmentations of the temperature of the body at fixed hours of the day, with corresponding periods of greatest bodily activity and the reverse.

This principle finds perfect illustration in the nervous system. The respiratory act of the higher animals is effected through muscular movements dependent on regular waves of excitation reaching them along the nerves from the central cells which regularly discharge their forces along these channels. Were not the movements of the body periodic or rhythmical, instead of that harmony which now prevails, every muscular act would be a convulsion, though even in the movements of the latter there is a highly compounded rhythm, as a noise is made up of a variety of musical notes. The senses are subject to the same law. The eye ceases to see and the ear to hear and the hand to feel if continuously stimulated; and doubtless in all art this law is *unconsciously* recognized. That ceases to be art which fails to provide for the alternate repose and excitation of the senses. The eye will not tolerate continuously one color, the ear a single sound. Why is a breeze on a warm day so refreshing? The answer is obvious.

Looking to the world of animate nature as a whole, it is noticed that plants have their period of sprouting, flowering, seeding, and decline; animals are born, pass through various stages to maturity, diminish in vigor, and die. These events make epochs in the life-history of each species; the recurrence of which is so constant that the agricultural and other arrangements even of savages are planned accordingly. That the individuals of each animal group have a definite period of duration is another manifestation of the same law.

Superficial observation suffices to furnish facts which show that the same law of periodicity is being constantly exemplified in the world of inanimate things. The regular ebb and flow of the tides; the rise and subsidence of rivers; the storm and the calm; summer and winter; day and night—are all recurrent, none constant.

Events apparently without any regularity, utterly beyond any law of recurrence, when sufficiently studied are found to

fall under the same principle. Thus it took some time to learn that volcanic eruptions occurred with a very fair degree of regularity.

In judging of this and all other rhythmical events it must be borne in mind that the time standard is for an irregularity that seems large, as in the instance just referred to, becomes small when considered in relation to the millions of years of geological time; while in the case of music a trifling irregularity, judged by fractions of a second, can not be tolerated by the musical organization—which is equivalent to saying that the interval of departure from exact regularity seems large.

As most of the rhythms of the universe are compounded of several, it follows that they may seem, until closely studied, very far from regular recurrences. This may be observed in the interference in the regularity of the tides themselves, the daily changes of which are subject to an increase and decrease twice in each month, owing to the influence of the sun and moon being then either coincident or antagonistic.

In the functions of plants and animals, rhythms must become very greatly compounded, doubtless often beyond recognition.

Among the best examples of rhythm in animals are daily sleep and winter sleep, or hibernation; yet, amid sleep, dreams or recurrences of cerebral activity are common—that is, one rhythm (of activity) overlies another (of repose). In like manner many hibernating animals do not remain constantly in their dormant condition throughout the winter months, but have periods of wakefulness; the active life recurs amid the life of functional repose.

To return to the world of inanimate matter, we find that the crust of the earth itself is made of layers or strata the result of periods of elevation and depression, of denudation and deposition, in recurring order.

The same law is illustrated by the facts of the economic and other conditions of the social state of civilized men. Periods of depression alternate with periods of revival in commercial life.

There are periods when many more marriages occur and many more children are born, corresponding with changes in the material conditions which influence men as well as other animals.

Finally, and of special interest to the medical student, are

the laws of rhythm in disease. Certain fevers have their regular periods of attack, as intermittent fever; while all diseases have their periods of exacerbation, however invariable the symptoms may seem to be to the ordinary observer or even to the patient himself.

Doubtless the fact that certain hereditary diseases do not appear in the offspring at once, but only at the age at which they were manifested in the parents, is owing to the same cause.

Let us now examine more thoroughly into the real nature of this rhythm which pervades the entire universe.

If a bow be drawn across a violin-string on which some small pieces of paper have been placed, these will be seen to fly off; and if the largest string be experimented upon, it can be observed to be in rapid to-and-fro motion, known as vibration, which motion is perfectly regular, a definite number of movements occurring within a measured period of time; in other words the motion is rhythmical. In strings of the finest size the motion is not visible, but we judge of its existence because of the result, which is in each instance a sound. Sound is to us, however, an affection of the nerve of hearing and the brain, owing to the vibrations of the ear caused by similar vibrations of the violin-strings. The movements of the nerves and nerve-cells are invisible and molecular, and we seem to be justified in regarding *molecular movements as constant and associated with all the properties of matter whether living or dead.*

We see, then, that all things living and lifeless are in constant motion, visible or invisible; there is no such thing in the universe as stable equilibrium. Change, ceaseless change, is written on all things; and, so far as we can judge, these changes, on the whole, tend to higher development. Neither rhythm, however, nor anything else, is perfect. Even the motions of planets are subject to perturbations or irregularities in their periodicity. This subject is plainly boundless in its scope. We have introduced it at this stage to prepare for its study in detail in dealing with each function of the animal body. If we are correct as to the universality of the law of rhythm, its importance in biology deserves fuller recognition than it has yet received in works on physiology; it will, accordingly, be frequently referred to in the future chapters of this book.

THE LAW OF HABIT.

Every one must have observed in himself and others the tendency to fall into set ways of doing certain things, in which will and clear purpose do not come prominently into view. Further observation shows that the lower animals exhibit this tendency, so that, for example, the habits of the horse or the dog may be an amusing reflection of those of the master. Trees are seen to bend permanently in the direction toward which the prevailing winds blow.

The violin that has experienced the vibrations aroused by some master's hand acquires a potential musical capability not possessed by an instrument equally good originally, but the molecular movements of which never received such an education.

It appears, then, that underlying what we call habit, there is some broad law not confined to living things; indeed, the law of habit appears to be closely related to the law of rhythm we have already noticed. Certain it is that it is inseparable from all biological phenomena, though most manifest in those organisms provided with a nervous system, and in that system itself. What we usually call habit, however expressed, has its physical correlation in the nervous system. We may refer to it in this connection later: but the subject has relations so numerous and fundamental that it seems eminently proper to introduce it at this early stage, forming as it does one of those corner-stones of the biological building on which the superstructure must rest.

When we seek to come to a final explanation of habit in this case, as in most others, in which the fundamental is involved, we are soon brought against a wall over which we are unable to climb, and through which no light comes to our intellects.

We must simply believe, as the result of observation, that it is a law of matter, in all the forms manifested to us, to assume accustomed modes of behavior, perhaps we may say molecular movement, in obedience to inherent tendencies. But, to recognize this, throws a flood of light on what would be inexplicable, even in a minor degree. We can not explain gravitation in itself; but, assuming its universality, replaces chaos by order in our speculations on matter.

Turning to living matter, we look for the origin of habit in the apparently universal principle that primary molecular movement in one direction renders that movement easier after-

ward, and in proportion to the frequency of repetition ; which is equivalent to saying that functional activity facilitates functional activity. Once accepting this as of universal application in biology, we have an explanation of the origin, the comparative rigidity, and the necessity of habit. There must be a physical basis or correlative of all mental and moral habits, as well as those that may be manifested during sleep, and so purely independent of the will and consciousness. We are brought, in fact, to the habits of cells in considering those organs, and that combination of structures which makes up the complex individual mammal. It is further apparent that if the cell can transmit its nature as altered by its experiences at all, then habits must be hereditary, which is known to be the case.

Instincts seem to be but crystallized habits, the inherited results of ages of functional activity in certain well-defined directions.

To a being with a highly developed moral nature like man, the law of habit is one of great, even fearful significance. We make to-day our to-morrow, and in the present we are deciding the future of others, as our present has been made for us in part by our ancestors. We shall not pursue the subject, which is of boundless extent, further now, but these somewhat general statements will be amplified and applied in future chapters.

THE ORIGIN OF THE FORMS OF LIFE.

It is a matter of common observation that animals originate from like kinds, and plants from forms resembling themselves ; while most carefully conducted experiments have failed to show that living matter can under any circumstances known to us arise from other than living matter.

That in a former condition of the universe such may have been the case has not been disproved, and seems to be the logical outcome of the doctrine of evolution as applied to the universe generally.

By evolution is meant the derivation of more complex and differentiated forms of matter from simpler and more homogeneous ones. When this theory is applied to organized or living forms, it is termed *organic evolution*. There are two views of the origin of life: the one, that each distinct group of plants and animals was independently created ; while by "creation" is simply meant that they came into being in a manner we know

not how, in obedience to the will of a First Cause. The other view is denominated the theory of descent with modification, the theory of transmutation, organic evolution etc., which teaches that all the various forms of life have been derived from one or a few primordial forms in harmony with the recognized principles of heredity and variability. The most widely known and most favorably received exposition of this theory is that of Charles Darwin, so that his views will be first presented in the form of a hypothetical case. Assume that one of a group of living forms varies from its fellows in some particular, and mating with another that has similarly varied, leaves progeny inheriting this characteristic of the parents, that tends to be still further increased and rendered permanent by successive pairing with forms possessing this variation in form, color, or whatever it may be. We may suppose that the variations may be numerous, but are always small at the beginning. Since all animals and plants tend to multiply faster than the means of support, a competition for the means of subsistence arises, in which struggle the fittest, as judged by the circumstances, always is the most successful; and if one must perish outright, it is the less fit. If any variation arises that is unfavorable in this contest, it will render the possessor a weaker competitor: hence it follows that only useful variations are preserved. The struggle for existence is, however, not alone for food, but for anything which may be an advantage to its possessor. One form of the contest is that which results from the rivalry of members of the same sex for the possession of the females; and as the female chooses the strongest, most beautiful, most active, or the supreme in some respect, it follows that the best leave the greatest number of progeny. This has been termed *sexual selection*.

In determining what forms shall survive, the presence of other plants or animals is quite as important as the abundance of food and the physical conditions, often more so. To illustrate this by an example: Certain kinds of clover are fertilized by the visits of the bumble-bee alone; the numbers of bees existing at any one place depends on the abundance of the field-mice which destroy the nests of these insects; the numbers of mice will depend on the abundance of creatures that prey on the mice, as hawks and owls; these, again, on the creatures that specially destroy them, as foxes, etc.; and so on, the chain of connections becoming more and more lengthy.

If a certain proportion of forms varying similarly were sep-

arated by any great natural barrier, as a chain of lofty mountains or an intervening body of water of considerable extent, and so prevented from breeding with forms that did not vary, it is clear that there would be greater likelihood of their differences being preserved and augmented up to the point of their greatest usefulness.

We may now inquire whether such has actually been the course of events in nature. The evidence may be arranged under the following heads:

1. **Morphology.**—Briefly, there is much that is common to entire large groups of animals; so great, indeed, are the resemblances throughout the whole animal kingdom, that herein is found the strongest argument of all for the doctrine of descent. To illustrate by a single instance—fishes, reptiles, birds, and mammals possess in common a vertebral column bearing the same relationship to other parts of the animal. It is because of resemblances of this kind, as well as by their differences, that naturalists are enabled to classify animals.

2. **Embryology.**—In the stages through which animals pass in their development from the ovum to the adult, it is to be observed that the closer the resemblance of the mature organism in different groups, the more the embryos resemble one another. Up to a certain stage of development the similarity between groups of animals, widely separated in their post-embryonic life, is marked: thus the embryo of a reptile, a bird, and a mammal have much in common in their earlier stages. The embryo of the mammal passes through stages which represent conditions which are permanent in lower groups of animals, as for example that of the branchial arches, which are represented by the gills in fishes. It may be said that the developmental history of the individual (ontogeny) is a brief recapitulation of the development of the species (phylogeny). Apart from the theory of descent, it does not seem possible to gather the true significance of such facts, which will become plainer after the study of the chapters on reproduction.

3. **Mimicry** may be cited as an instance of useful adaptation. Thus, certain beetles resemble bees and wasps, which latter are protected by stings. It is believed that such groups of beetles as these arose by a species of selection; those escaping enemies which chanced to resemble dreaded insects most, so that birds which were accustomed to prey on beetles, yet feared bees, would likewise avoid the mimicking forms.

4. **Rudimentary Organs.**—Organs which were once functional

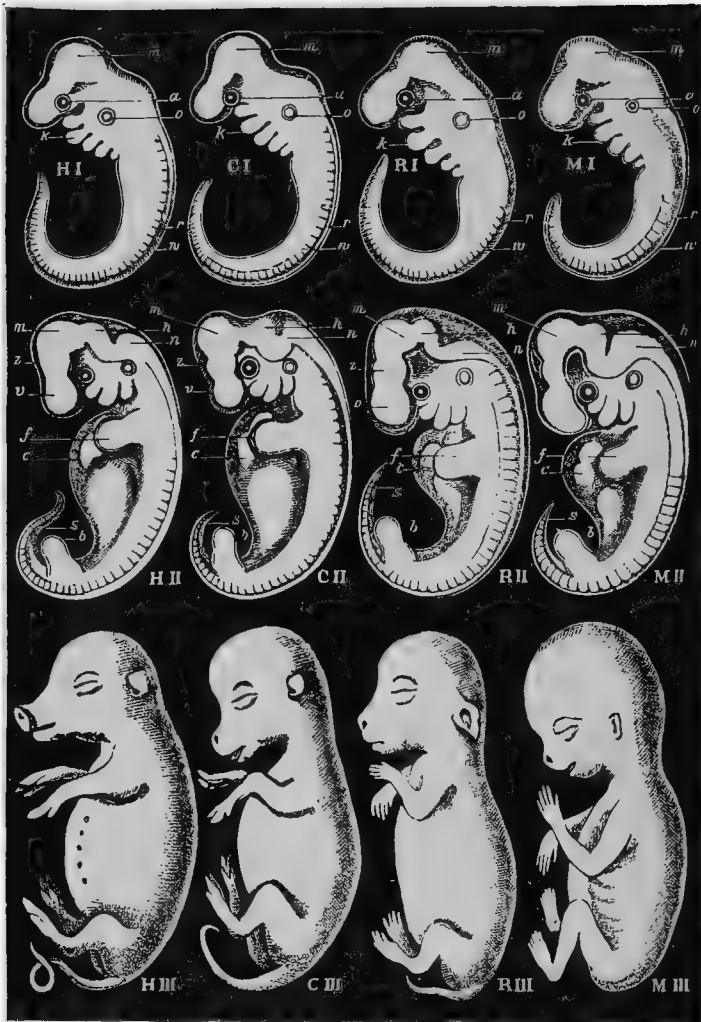

FIG. 47.—Shows the embryos of four mammals in the three corresponding stages: of a hog (H), calf (C), rabbit (R), and a man (M). The conditions of the three different stages of development, which the three cross-rows (I, II, III) represent, are selected to correspond as exactly as possible. The first, or upper cross-row, I, represents a very early stage, with gill-openings, and without limbs. The second (middle) cross-row, II, shows a somewhat later stage, with the first rudiments of limbs, while the gill-openings are yet retained. The third (lowest) cross-row, III, shows a still later stage, with the limbs more developed and the gill-openings lost. The membranes and appendages of the embryonic body (the amnion, yolk-sac, allantois) are omitted. The whole twelve figures are slightly magnified, the upper ones more than the lower. To facilitate the comparison, they are all reduced to nearly the same size in the cuts. All the embryos are seen from the left side; the head extremity is above, the tail extremity below; the arched back turned to the right. The letters indicate the same parts in all the twelve figures, namely: *v*, fore-brain; *z*, twixt-brain; *m*, mid-brain; *h*, hind-brain; *n*, after-brain; *r*, spinal marrow; *e*, nose; *a*, eye; *o*, ear; *k*, gill-arches; *g*, heart; *w*, vertebral column; *f*, fore-limbs; *b*, hind-limbs; *s*, tail. (After Haeckel.)

in a more ancient form, but serve no use in the creatures in which they are now found, have reached, it is thought, their rudimentary condition through long periods of comparative disuse, in many generations. Such are the rudimentary muscles of the ears of man, or the undeveloped incisor teeth found in the upper jaw of ruminants.

5. **Geographical Distribution.**—It can not be said that animals and plants are always found in the localities where they are best fitted to flourish. This has been well illustrated within the lifetime of the present generation, for the animals introduced into Australia have many of them so multiplied as to displace the forms native to that country. But, if we assume that migrations of animals and transmutations of species have taken place, this difficulty is in great part removed.

6. **Paleontology.**—The rocks bear record to the former existence of a succession of related forms; and, though all the intermediate links that probably existed have not been found, the apparent discrepancy can be explained by the nature of the circumstances under which fossil forms are preserved; and the "imperfection of the geological record."

It is only in the sedimentary rocks arising from mud that fossils can be preserved, and those animals alone with hard parts are likely to leave a trace behind them; while if these sedimentary rocks with their inclosed fossils should, owing to enormous pressure or heat be greatly changed (metamorphosed), all trace of fossils must disappear—so that the earliest forms of life, those that would most naturally, if preserved at all, be found in the most ancient rocks, are wanting, in consequence of the metamorphism which such formations have undergone. Moreover, our knowledge of the animal remains in the earth's crust is as yet very incomplete, though, the more it is explored, the more the evidence gathers force in favor of organic evolution. But it must be remembered that those groups constituting species are in geological time intermediate links.

7. **Fossil and Existing Species.**—If the animals and plants now peopling the earth were entirely different from those that flourished in the past, the objections to the doctrine of descent would be greatly strengthened; but when it is found that there is in some cases a scarcely broken succession of forms, great force is added to the arguments by which we are led to infer the connection of *all* forms with one another.

To illustrate by a single instance: the existing group of horses, with a single toe to each foot, was preceded in geological

time in America by forms with a greater number of toes, the latter increasing according to the antiquity of the group.

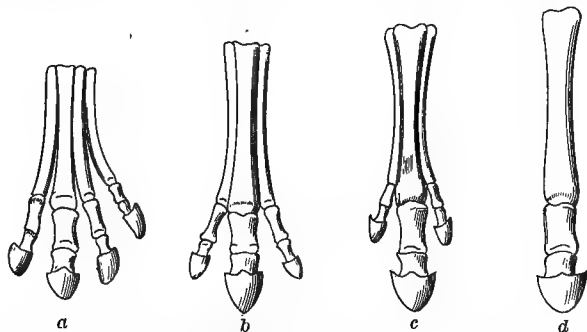

FIG. 48.—Bones of the feet of the different genera of *Equidae* (after Marsh). *a*, foot of *Orohippus* (Eocene); *b*, foot of *Anchitherium* (Lower Miocene); *c*, foot of *Hipparion* (Pliocene); *d*, foot of the recent genus *Equus*.

These forms occur in succeeding geological formations. It is impossible to resist the conclusion that they are related genealogically (phylogenetically).

8. **Progression.**—Inasmuch as any form of specialization that would give an animal or plant an advantage in the struggle for existence would be preserved, and as in most cases when the competing forms are numerous such would be the case, it is possible to understand how the organisms that have appeared have tended, on the whole, toward a most pronounced progression in the scale of existence. This is well illustrated in the history of civilization. Barbarous tribes give way before civilized man with the numberless subdivisions of labor he institutes in the social organism. It enables greater numbers to flourish as the competition is not so keen as if activities could be exercised in a few directions only.

9. **Domesticated Animals.**—Darwin studied our domestic animals long and carefully, and drew many important conclusions from his researches. He was convinced that they had all been derived from a few wild representatives, in accordance with the principles of natural selection. Breeders have, both consciously and unconsciously, formed races of animals from stocks which the new groups have now supplanted; while primitive man had tamed various species which he kept for food and to assist in the chase, or as beasts of burden. It is impossible to believe that all the different races of dogs have originated from distinct wild stocks, for many of them have been formed within recent periods; in fact, it is likely that to the jackal, wolf, and

fox, must we look for the wild progenitors of our dogs. Darwin concluded that, as man had only utilized the materials Nature provided in forming his races of domestic animals, he had availed himself of the variations that arose spontaneously, and increased and fixed them by breeding those possessing the same variation together, so the like had occurred without his aid in nature among wild forms.

Evolutionists are divided as to the origin of man himself; some, like Wallace, who are in accord with Darwin as to the

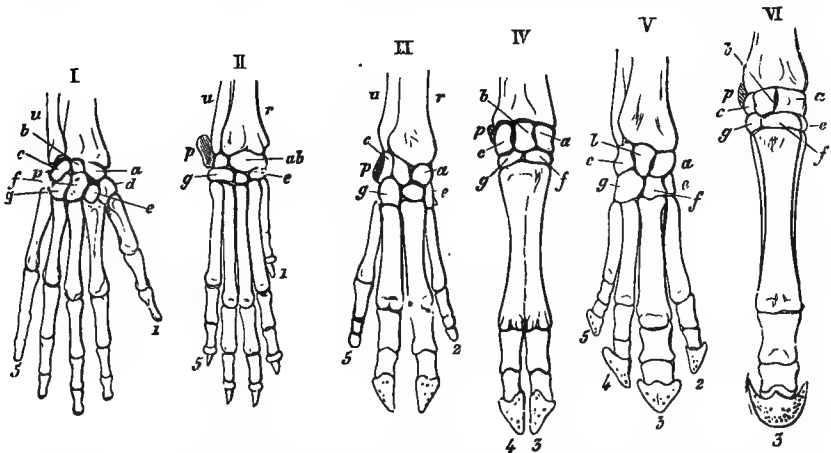

FIG. 49.—Skeleton of hand or fore-foot of six mammals. I, man; II, dog; III, pig; IV, ox; V, tapir; VI, horse. *r*, radius; *u*, ulna; *a*, scaphoid; *b*, semi-lunar; *c*, triquetrum (cuneiform); *d*, trapezium; *e*, trapezoid; *f*, capitatum (unciform process); *g*, hamatum (unciform bone); *p*, pisiform; 1, thumb; 2, digit; 3, middle finger; 4, ring-finger; 5, little finger. (After Gegenbaur.)

origin of living forms in general, believe that the theory of natural selection does not suffice to account for the intellectual and moral nature of man. Wallace believes that man's body has been derived from lower forms, but that his higher nature is the result of some unknown law of accelerated development; while Darwin, and those of his way of thinking, consider that man in his entire nature is but a grand development of powers existing in minor degree in the animals below him in the scale.

Summary.—Every group of animals and plants tends to increase in numbers in a geometrical progression, and must, if unchecked, overrun the earth. Every variety of animals and plants imparts to its offspring a general resemblance to itself, but with minute variations from the original. The variations of offspring may be in any direction, and by accumulation



FIG. 54.
Man. (Haeckel.)

FIG. 53.
Gorilla.

FIG. 52.
Chimpanzee.

FIG. 51.
Orang-outang.

FIG. 50.
Gibbon.

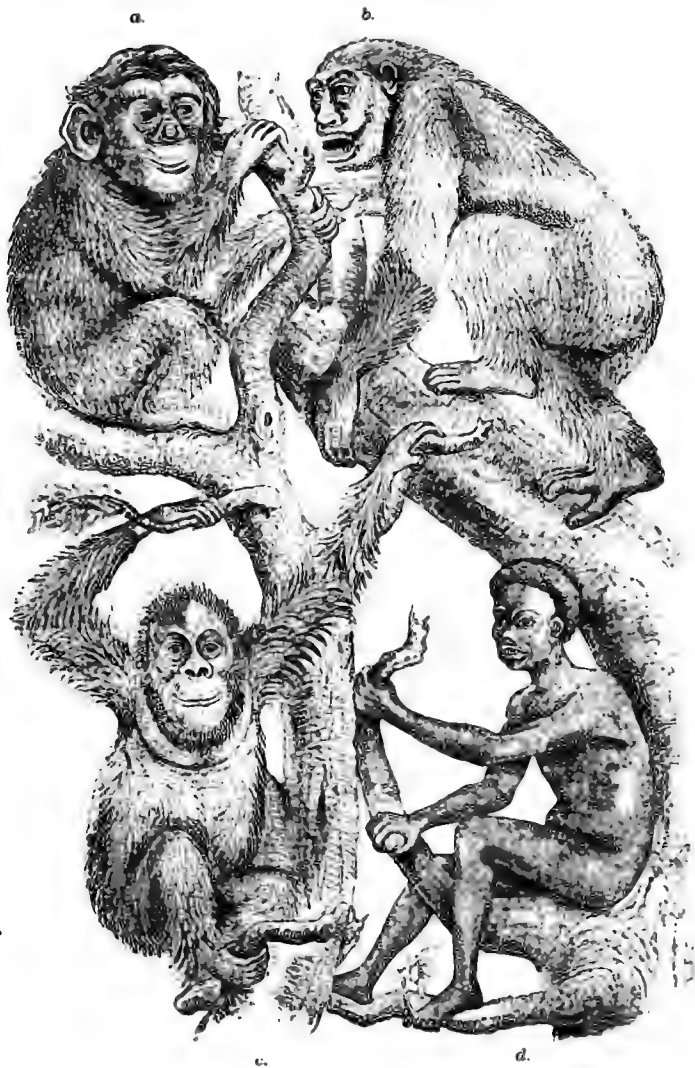

FIG. 55.—*a*, chimpanzee ; *b*, gorilla ; *c*, orang ; *d*, negro. (Haeckel.)



FIG. 56.—Head of a nose-ape (*Semnopithecus nasicus*) from Borneo. (After Brehm.)



FIG. 57.—Head of Julia Pastana. (From a photograph by Hintze.)

constitute fixed differences by which a new group is marked off. In the determination of the variations that persist, the law of survival of the fittest operates.

REPRODUCTION.

As has been already noticed, protoplasm, in whatever form, after passing through certain stages in development, undergoes a decline, and finally dies and joins the world of unorganized matter; so that the permanence of living things demands the constant formation of new individuals. Groups of animals and plants from time to time become extinct; but the lifetime of the species is always long compared with that of the individual. Reproduction by division seems to arise from an exigency of a nutritive kind, best exemplified in the simpler organisms. When the total mass becomes too great to be supported by absorption of pabulum from without by the surface of the body, division of the organism must take place, or death ensues. It appears to be a matter of indifference how this is accomplished, whether by fission, endogenous division, or gemmation, so long as separate portions of protoplasm result, capable of leading an independent existence. The very undifferentiated character of these simple forms prepares us to understand how each fragment may go through the same cycle of changes as the parent form. In such cases, speaking generally, a million individuals tell the same biological story as one; yet these must exist as individuals, if at all, and not in one great united mass. But in the case of conjugation, which takes place sometimes in the same groups as also multiply by division in its various forms, there is plainly an entirely new aspect of the

case presented. We have already shown that no two cells, however much alike they may seem as regards form and the circumstances under which they exist, can have, in the nature of the case, precisely the same history, or be the subjects of exactly the same experiences. We have also pointed out that all these phenomena of cell-life are known to us only as adaptations of internal to external conditions; for, though we may not be always able to trace this connection, the inference is justifiable, because there are no facts known to us that contradict such an assumption, while those that are within our knowledge bear out the generalization. We have already learned that living things are in a state of constant change, as indeed are all things; we have observed a constant relation between certain changes in the environment, or sum total of the surrounding conditions, as, for example, temperature and the behavior of the protoplasm of plants and animals; so that we must believe that any one form of protoplasm, however like another it may seem to our comparatively imperfect observation, is different in some respects from every other—as different, relatively, as two human beings living in the same community during the whole of their lives; and in many cases as unlike as individuals of very different nationality and history. We are aware that when two such persons meet, provided the unlikeness is not so great as to prevent social intercourse, intercommunication may prove very instructive. Indeed, the latter grows out of the former; our illustration is itself explained by the law we are endeavoring to make plain. It would appear, then, that continuous division of protoplasm without external aid is not possible; but that the vigor necessary for this must in some way be imparted by a particle (cell) of similar, yet not wholly like, protoplasm. This seems to furnish an explanation of the necessity for the conjugation of living forms, and the differentiation of sex. Very frequently conjugation in the lowest animals and plants is followed by long periods when division is the prevailing method of reproduction. It is worthy of note, too, that when living forms conjugate, they both become quiescent for a longer or shorter time. It is as though a period of preparation preceded one of extraordinary activity. We can at present trace only a few of the steps in this rejuvenation of life-stuff. Some of these have been already indicated, which, with others, will now be further studied in this division of our subject, both because reproduction throws so much light on cell-life, and because it is so important for the understanding of the physio-

logical behavior of tissues and organs. It may be said to be quite as important that the ancestral history of the cells of an organism be known as the history of the units composing a community. A, B, and C can be much better understood if we know something alike of the history of their race, their ancestors, and their own past; so is it with the study of any individual, animal, or group of animals or plants. Accordingly, embryology, or the history of the origin and development of tissues and organs, will occupy a prominent place in the various chapters of this work. The student will, therefore, at the outset be furnished with a general account of the subject, while many details and applications of principles will be left for the chapters that treat of the functions of the various organs of animals. The more knowledge the student possesses of zoology the better, while this science will appear in a new light under the study of embryology.

Animals are divisible, according to general structure, into *Protozoa*, or unicellular animals, and *Metazoa*, or multicellular forms—that is, animals composed of cell aggregates, tissues, or organs. Among the latter one form of reproduction appears for the first time in the animal kingdom, and becomes all but universal, though it is not the exclusive method; for, as seen in *Hydra*, both this form of generation and the more primitive gemmation occur. It is known as sexual multiplication, which usually, though not invariably, involves conjugation of two unlike cells which may arise in the same or different individuals. That these cells, known as the male and female elements, the ovum and the spermatozoön, are not necessarily radically different, is clear from the fact that they may arise in the one individual from the same tissue and be mingled together. These cells, however, like all others, tell a story of continual progressive differentiation corresponding to the advancing evolution of higher from lower forms. Thus *hermaphroditism*, or the coexistence of organs for the production of male and of female cells in the same individual, is confined to invertebrates, among which it is rather the exception than the rule. Moreover, in such hermaphrodite forms the union of cells with greater difference in experiences is provided for by the union of different individuals, so that commonly the male cell of one individual unites with (fertilizes) the female cell of a different individual. It sometimes happens that among the invertebrates the cells produced in the female organs of generation possess the power of division, and continued development wholly independently of

the access of any male cell (*parthenogenesis*); such, however, is almost never the exclusive method of increase for any group of animals, and is to be regarded as a retention of a more ancient method, or perhaps rather a *reversion* to a past biological condition. No instance of complete parthenogenesis is known among vertebrates, although in birds partial development of the egg may take place independently of the influence of the male sex. The best examples of parthenogenesis are to be found among insects and crustaceans.

It is to be remembered that, while the cells which form the tissues of the body of an animal have become *specialized* to discharge one particular function, they have not wholly lost all others; they do not remain characteristic amœboids, as we may term cells closely resembling *Amœba* in behavior, nor do they wholly forsake their ancestral habits. They all retain the power of reproduction by division, especially when young and most vigorous; for tissues grow chiefly by the production of new cells rather than the enlargement of already mature ones. Cells wear out and must be replaced, which is effected by the processes already described for *Amœba* and similar forms. Moreover, there is retained in the blood of animals an army of cells, true amœboids, ever ready to hasten to repair tissues lost by injury. These are true remnants of an embryonic condition; for at one period all the cells of the organism were of this undifferentiated, plastic character. But *the cell (ovum)* from which the individual in its entirety and with all its complexity arises mostly by the union with another cell (*spermatozoön*), must be considered as one that has remained unspecialized and retained, and perhaps increased its reproductive functions. They certainly have become more complex. The germ-cell may be considered unspecialized as regards other functions, but highly specialized in the one direction of exceedingly great capacity for growth and complex division, if we take into account the whole chain of results; though in considering this it must be borne in mind that after a certain stage of division each individual cell repeats its ancestral history again; that is to say, it divides and gives rise to cells which progress in turn as well as multiply. From another point of view the ovum is a marvelous storehouse of energy, latent or potential, of course, but under proper conditions liberated in varied and unexpected forms of force. It is a sort of storehouse of biological energy in the most concentrated form, the liberation of which in simpler forms gives rise to that complicated chain of events which

is termed by the biologist development, but which may be expressed by the physiologist as the transformation of potential into kinetic energy, or the energy of motion. Viewed chemically, it is the oft-repeated story of the production of forms, of greater stability and simplicity, from more unstable and complex ones, involving throughout the process of oxidation; for it must ever be kept in mind that life and oxidation are concomitant and inseparable. The further study of reproduction in the concrete will render the meaning and force of many of the above statements clearer.

THE OVUM.

The typical female cell, or ovum, consists of a mass of protoplasm, usually globular in form, containing a nucleus and nucleolus.

The ovum may or may not be invested by a membrane; the protoplasm of the body of the cell is usually highly granular, and may have stored up within it a varying amount of proteid material (*food-yelk*), which has led to division of ova into classes, according to the manner of distribution of this nutritive reserve. It is either concentrated at one pole (*telolecithal*); toward the center (*centrolecithal*); or evenly distributed (*alecithal*).

During development this material is converted by the agency of the cells of the young organism (*embryo*) into active protoplasm; in a word, they feed upon and assimilate or build up this food-stuff into their own substance, as *Amœba* does with any proteid material it appropriates.

The nucleus (*germinal vesicle*) is large and well-defined, and contains within itself a highly refractive nucleolus (*germinal spot*). These closely resemble in general the rest of

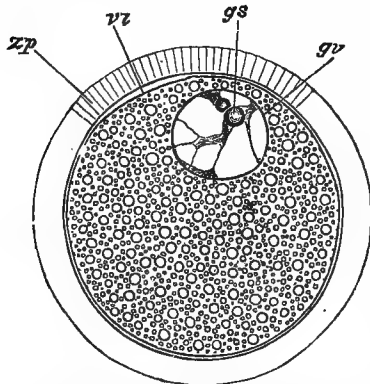

FIG. 58.—Semi-diagrammatic representation of a mammalian ovum (Schäfer). Highly magnified. *zp*, zona pellucida; *vt*, vitellus; *gv*, germinal vesicle; *gs*, germinal spot.

the cell, but stain more deeply and are chemically different in that they contain *nucleine* (*nucleoplasm, chromatin*).

It will be observed that the ovum differs in no essential par-

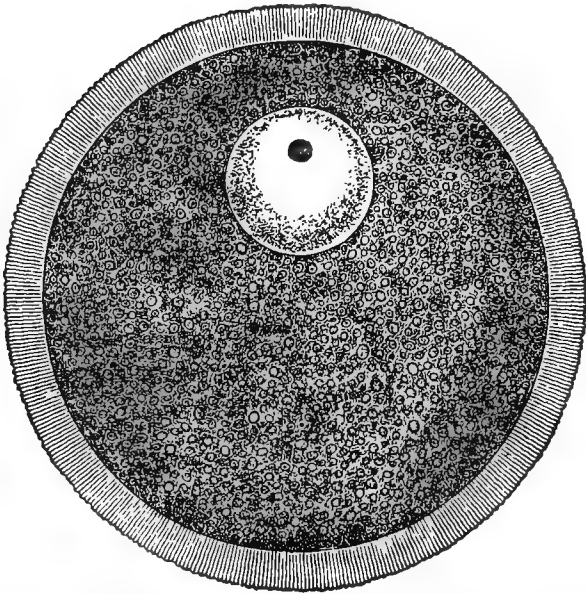

FIG. 59.—A human egg (much enlarged) from the ovary of a female. The whole egg is a simple spherical cell. The greater part of this cell is formed by the egg-yolk, by the granular cell-substance (protoplasm), consisting of innumerable yolk-granules with a little inter-granular substance. In the upper part of the yolk lies the bright, globular, germ-vesicle, corresponding with the cell-kernel (*nucleus*). This contains a darker germ-spot, answering to the nucleolus. The globular yolk-mass is surrounded by a thick, light-colored egg-membrane (*zona pellucida*, or *chorion*). This is traversed by very numerous hair-like lines, radiating toward the central point of the mass: these are the porous canals, through which, in the course of fertilization, the thread-shaped, active sperm-cells penetrate into the egg-yolk. (Haeckel.)

ticular of structure from other cells. Its differences are hidden ones of molecular structure and functional behavior. In accordance with the diverse circumstances under which ova mature and develop, certain variations in structure, mostly of the nature of additions, present themselves.

Thus, ova may be naked, or provided with one or more coverings. In vertebrates there are usually two membranes around the protoplasm of the ovum: a delicate covering (*Vitelline membrane*), beneath which there is another, which is sieve-like from numerous perforations (*zona radiata*, or *z. pellucida*). The egg membrane may be impregnated with lime salts (*shell*). Between the membranes and the yolk there is a fluid albuminous substance secreted by the glands of the oviduct, or by other special glands, which provide proteid nutriment in different physical condition from that of the yolk.

The general naked-eye appearances of the ovum may be learned from the examination of a hen's egg, which is one of

the most complicated known, inasmuch as it is adapted for development outside of the body of the mother, and must, consequently, be capable of preserving its form and essential vital properties in a medium in which it is liable to undergo loss of water, protected as it now is with shell, etc., but which, at the

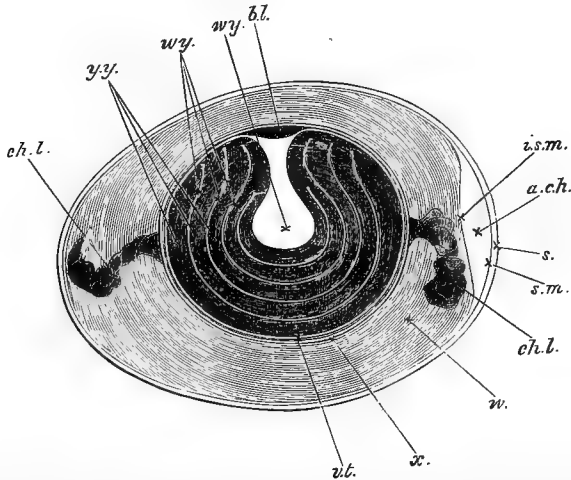

FIG. 60.—Diagrammatic section of an unimpregnated fowl's egg (Foster and Balfour, after Allen Thomson). *bl*, blastoderm or cicatricula; *w. y.*, white yolk; *y. y.*, yellow yolk; *ch. l.*, chalaza; *i. s. m.*, inner layer of shell membrane; *s. m.*, outer layer of shell membrane; *s.*, shell; *a. c. h.*, air-space; *w.*, the white of the egg; *v. t.*, vitelline membrane; *x.*, the denser albuminous layer lying next the vitelline membrane.

same time, permits the entrance of oxygen and moisture, and conducts heat, all being essential for the development of the germ within this large food-mass. The shell serves, evidently, chiefly for protection, since the eggs of serpents (snakes, turtles, etc.) are provided only with a very tough membranous covering, this answering every purpose in eggs buried in sand or otherwise protected as theirs usually are. As the hen's egg is that most readily studied and most familiar, it may be well to describe it in somewhat further detail, as illustrated in the above figure, from the examination of which it will be apparent that the yolk itself is made up of a white and yellow portion distributed in alternating zones, and composed of cells of different microscopical appearances. The clear albumen is structureless.

The relative distribution, and the nature of the accessory or non-essential parts of the hen's egg, will be understood when it is remembered that, after leaving its seat of origin, which will be presently described, the ovum passes along a tube (oviduct)

by a movement imparted to it by the muscular walls of the latter, similar to that of the gullet during the swallowing of food; that this tube is provided with glands which secrete in turn the albumen, the membrane (outer), the lime salts of the shell, etc. The twisted appearance of the rope-like structures (*chalazæ*) at each end is owing to the spiral rotatory movement the egg has undergone in its descent.

The air-chamber at the larger end is not present from the first, but results from evaporation of the fluids of the albumen and the entrance of atmospheric air after the egg is laid some time.

THE ORIGIN AND DEVELOPMENT OF THE OVUM.

Between that protrusion of cells which gives rise to the bud which develops directly into the new individual, and that which forms the ovary within which the ovum as a modified cell arises, there is not in *Hydra* much difference at first to be observed.

In the mammal, however, the ovary is a more complex structure, though, relatively to many organs, still simple. It consists, in the main, of connective tissue supplied with vessels and nerves including modifications of that tissue (*Graafian follicles*) within which the ovum is matured. The ovum and the follicles arise from an inversion of epithelial cells, on a portion of the body cavity (*germinal ridge*), which give rise to the ovum itself, and the other cells surrounding it in the Graafian follicle. At first these inversions form tubules (*egg-tubes*) which later become broken up into isolated nests of cells, the fore-runners of the Graafian follicles.

The Graafian follicle consists externally of a fibrous capsule

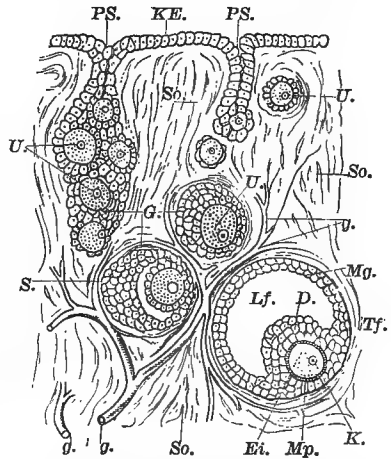

FIG. 61.—Section through portion of the ovary of mammal, illustrating mode of development of the Graafian follicles (Wiedersheim). *D*, discus proligerus; *Ei*, ripe ovum; *G*, follicular cells of germinal epithelium; *g*, blood-vessels; *K*, germinal vesicle (nucleus) and germinal spot (nucleolus); *KE*, germinal epithelium; *Lf*, liquor folliculi; *Mg*, membrana or tunica granulosa, or follicular epithelium; *Mp*, zona pellucida; *PS*, ingrowths from the germinal epithelium, ovarian tubes, by means of which some of the nests retain their connection with the epithelium; *S*, cavity which appears within the Graafian follicle; *So*, stroma of ovary; *Tf*, theca folliculi or capsule; *U*, primitive ova. When an ovum with its surrounding cells has become separated from the nest, it is known as a Graafian follicle.

(*tunica fibrosa*), in close relation to which is a layer of capillary blood-vessels (*tunica vasculosa*), the two together forming the

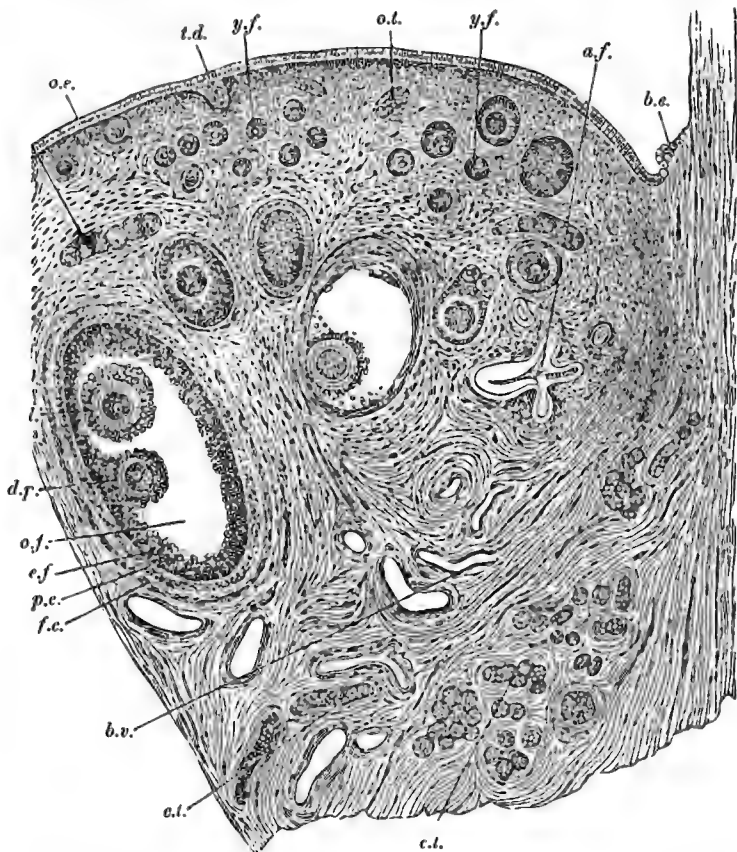

FIG. 62.—Sagittal section of the ovary of an adult bitch (after Waldeyer). *o. e.* ovarian epithelium; *o. t.* ovarian tubes; *y. f.* younger follicles; *o. f.* older follicle; *d. p.* discus proligerus, with the ovum; *e.* epithelium of a second ovum in the same follicle; *f. c.* fibrous coat of the follicle; *p. c.* proper coat of the follicle; *e. f.* epithelium of the follicle (*membrana granulosa*); *a. f.* collapsed atrophied follicle; *b. v.* blood vessels; *c. t.* cell-tubes of the parovarium, divided longitudinally and transversely; *t. d.* tubular depression of the ovarian epithelium, in the tissue of the ovary; *b. e.* beginning of the ovarian epithelium, close to the lower border of the ovary.

general covering (*tunica propria*) for the more delicate and important cells within. Lining the tunic is a layer of small, somewhat cubical cells (*membrana granulosa*), which at one part invest the ovum several layers deep (*discus proligerus*), while the remainder of the space is filled by a fluid (*liquor folliculi*) probably either secreted by the cells themselves, or resulting from the disintegration of some of them, or both.

In viewing a section of the ovary taken from a mammal at the breeding-season, ova and Graafian follicles may be seen in all stages of development—those, as a rule, nearest the surface being the least matured. The Graafian follicle appears to pass inward, to undergo growth and development and again retire toward the exterior, where it bursts, freeing the ovum, which is conducted to the site of its future development by appropriate mechanism to be described hereafter.

Changes in the Ovum itself.—The series of transformations that take place in the ovum before and immediately after the access of the male element is, in the opinion of many biologists, of the highest significance, as indicating the course evolution has followed in the animal kingdom, as well as instructive in illustrating the behavior of nuclei generally.

The germinal vesicle may acquire powers of slow movement (amoeboid), and the germinal spot disappear: the former passes to one surface (*pole*) of the ovum; both these structures may undergo that peculiar form of rearrangement (*karyokinesis*) which may occur in the nuclei and nucleoli of other cells prior to division; in other words, the ovum has features common to it and many other cells in that early stage which precedes the complicated transformations which constitute the future history of the ovum.

A portion of the changed nucleus (*aster*) with some of the protoplasm of the cell accumulates at one surface (*pole*), which

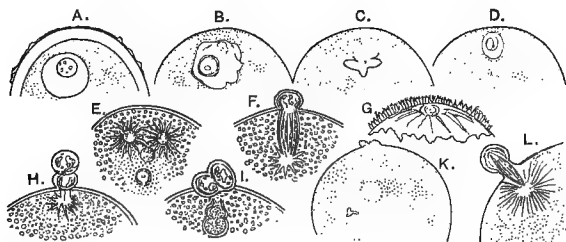

FIG. 63.—Formation of polar cells in a star-fish (*Asterias glacialis*) (from Geddes, A—K after Fol, L after O. Hertwig). A, ripe ovum with eccentric germinal vesicle and spot; B—D, gradual metamorphosis of germinal vesicle and spot, as seen in the living egg, into two asters; F, formation of first polar cells and withdrawal of remaining part of nuclear spindle within the ovum; G, surface view of living ovum in the first polar cell; H, completion of second polar cell; I, a later stage, showing the remaining internal half of the spindle in the form of two clear vesicles; K, ovum with two polar cells and radial striations round female pronucleus, as seen in the living egg (E, F, H, and I from picric acid preparations); L, expulsion of the first polar cell. (Haddon.)

is termed the upper pole because it is at this region that the epithelial cells will be ultimately developed, and is separated; this process is repeated. These bodies (*polar cells*, *polar globules*,

etc.), then, are simply expelled; they take no part in the development of the ovum; and their extrusion is to be regarded as a preparation for the progress of the cell, whether this event follows or precedes the entrance of the male cell into the ovum. It is worthy of note that the ovum may become amœboid in the region from which the polar globules are expelled.

The remainder of the nucleus (*female pronucleus*) now passes inward to undergo further changes of undoubted importance, possibly those by virtue of which all the subsequent evolution of the ovum is determined. This brings us to the consideration of another cell destined to play a brief but important rôle on the biological stage.

THE MALE CELL (*Spermatozoön*).

This cell, almost without exception, consists of a nucleus (head) and vibratile cilium. However, as indicating that the



FIG. 64.—Spermatozoa (after Haddon). Not drawn to scale. 1, sponge; 2, hydroid; 3, nematode; 4, cray-fish; 5, snail; 6, electric ray; 7, salamander; 8, horse; 9, man. In many spermatozoa, as in Nos. 7 and 9, an extremely delicate vibratile band is present.

latter is not essential, spermatozoa without such an appendage do occur. The obvious purpose of the cilium is to convey the male cell to the ovum through a fluid medium—either the water in which the ova are discharged in the case of most invertebrates, or through the fluids that overspread the surfaces of the female generative organs.

The Origin of the Spermatozoön.—The structures devoted to the production of male cells (*testes*), when reduced to their es-

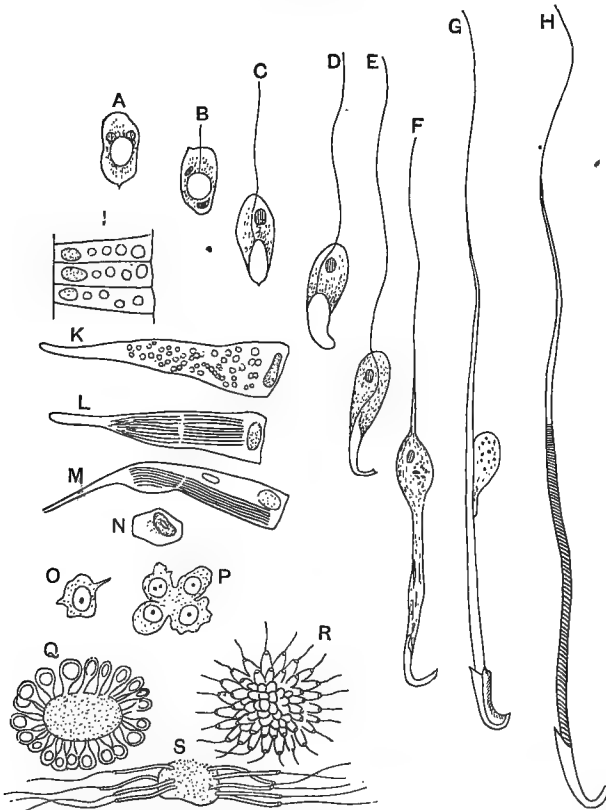

FIG. 65.—Spermatogenesis. A—H, isolated sperm-cells of the rat, showing the development of the spermatozoön and the gradual transformation of the nucleus into the spermatozoön head. In G the seminal granule is being cast off (after H. H. Brown). I—M, sperm-cells of an Elasmobranch. The nucleus of each cell divides into a large number of daughter-nuclei, each one of which is converted into the rod-like head of a spermatozoön. N, transverse section of a ripe cell, showing the bundle of spermatozoa and the passive nucleus (I—N, after Semper). O—S, spermatogenesis in the earth-worm: O, young sperm-cell; P, the same divided into four; Q, spermatosphere with the central sperm-blastophore; R, a later stage; S, nearly mature spermatozoa. (After Blomfield.)

sentials, consist of tubules, of great length in mammals, lined with nucleated epithelial cells, from which, by a series of

changes figured above, a general idea of their development may be obtained.

It will be observed that throughout the series the nucleus of the cell is in every case preserved, and finally becomes the head of the male cell. Once more we are led to see the importance of this structure in the life of the cell.

Fertilization of the Ovum.—The spermatozoön, lashing its way along, when it meets the ovum, enters it either through a special minute gateway (*micropyle*), or if this be not present—as it is not in the ova of all animals—it actually penetrates the membranes and substance of the female cell, and continues active till the female pronucleus is reached, when the head enters and the tail is absorbed or blends with the female cell. The nucleus of the male cell prior to union with the nucleus of the ovum undergoes changes similar to those that the nucleus of the ovum underwent, and thus becomes fitted for its special functions as a fertilizer; or perhaps it would be more correct to say that these altered masses of nuclear substance mutually fertilize each other, or initiate changes the one in the other which conjointly result in the subsequent stages of the development of the ovum. The altered male nucleus (*male pronucleus*), on reaching the female pronucleus, finds it somewhat amœboid, a condition which may be shared in some degree by the entire

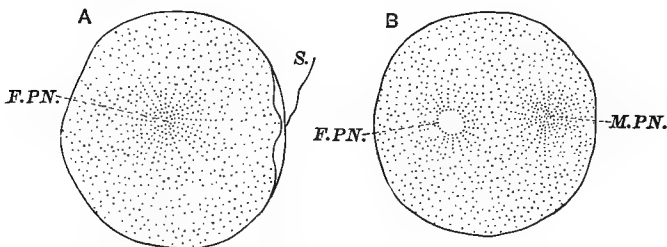

FIG. 66.—Fertilization of ovum of a mollusk (*Elysia viridis*). A. Ovum sending up a protuberance to meet the spermatozoön. B. Approach of male pronucleus to meet the female pronucleus. F. P.N., female pronucleus; M. P.N., male pronucleus; S., spermatozoön.

ovum. The resulting union gives rise to the new nucleus (*segmentation nucleus*), which is to control the future destinies of the cell; while the cell itself, the fertilized ovum (*oö sperm*), enters upon new and marvelous changes.

In reality this process was foreshadowed in the dim past of the history of living things by the conjugation of infusoria and kindred animal and vegetable forms. When lower forms (unicellular) conjugate they become somewhat amœboid sooner

or later, and division of cell contents results. In some cases (septic monads) the resulting cell may burst and give rise to a shower of animal dust visible only by the highest powers of the microscope, each particle of which proves to be the nucleus from which a future individual arises.

The study of reproduction thus establishes the conception of a unity of method throughout the animal and, it may be added, the vegetable kingdom, for reproduction in plants is in all main points parallel to that process in animals.

But why that costly loss of protoplasm by polar globules? For the present we shall only say that it appears necessary to prevent parthenogenesis; or at least to balance the share which the male and female elements take in the work of producing a new creature. It is to be remembered that both the male and female lose much in the process—blood, nervous energy, etc., in the case of the female, while the male furnishes a thousand-fold more cells than are used. But the period when organisms are best fitted for reproduction is that during which they are also most vigorous, and can best afford the superfluous drain on their energies.

SEGMENTATION AND SUBSEQUENT CHANGES.

After the changes described in the last chapter a new epoch in the biological history of the ovum—now the *oö sperm* (or fertilized egg)—begins. A very distinct nucleus (*segmentation nucleus*) again appears, and the cell assumes a circular outline. The segmentation or division of the ovum into usually fairly equal parts now commences. This process can be best watched in the microscopic transparent ova of aquatic animals which undergo perfect development up to a certain advanced stage in the ordinary water of the ocean, river, lake, etc., in which the adult lives.

Segmentation among invertebrates will be first studied, and for this purpose an ovum in which the changes are of a direct and uncomplicated nature will be chosen.

The following figures and descriptions apply to a mollusk (*Elysia viridis*). We distinguish in ova resting stages and stages of activity. It is not, however, to be supposed that absolute rest ever characterizes any living form, or that nothing is transpiring because all seems quiet in these little biological worlds; for we have already seen reason for believing that life and incessant molecular activity are inseparable. It may be that, in

the case of resting ova, changes of a more active character than usual are going on in their molecular constitution; but, on the other hand, there may be really a diminution of these activities in correspondence with the law of rhythm. This seems the more probable. The meaning, however, of a "resting stage" is

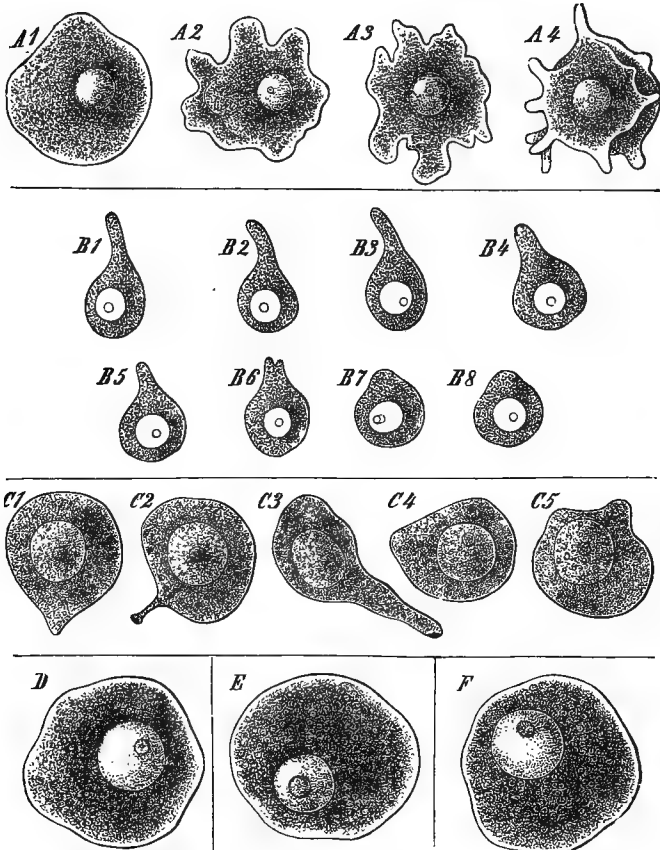

Fig. 67.—Primitive eggs of various animals, performing amoeboid movements (very much enlarged). All primitive eggs are naked cells, capable of change of form. Within the dark, finely granulated protoplasm (egg-yolk) lies a large vesicular kernel (the germ-vesicle), and in the latter is a nucleolus (germ-spot); in the nucleolus a germ-point (nucleolus) is often visible. Fig. A 1—A 4. The primitive egg of a chalk sponge (*Leuculmis echinus*), in four consecutive conditions of motion. Fig. B 1—B 8. The primitive egg of a hermit-crab (*Chondracanthus cornutus*), in eight consecutive conditions of motion (after E. Van Beneden). Fig. C 1—C 5. Primitive egg of a cat, in four different conditions of motion (after Pfäuger). Fig. D. Primitive egg of a trout. Fig. E. Primitive egg of a hen. Fig. F. Primitive human egg. (Haeckel.)

the obvious one of apparent quiescence—cessation of all kinds of movement. Then ensues rapidly and in succession the following series of transformations: The nucleolus divides, later

the nucleus, into two parts. These new nuclei then wander away from each other in opposite directions, and, losing their

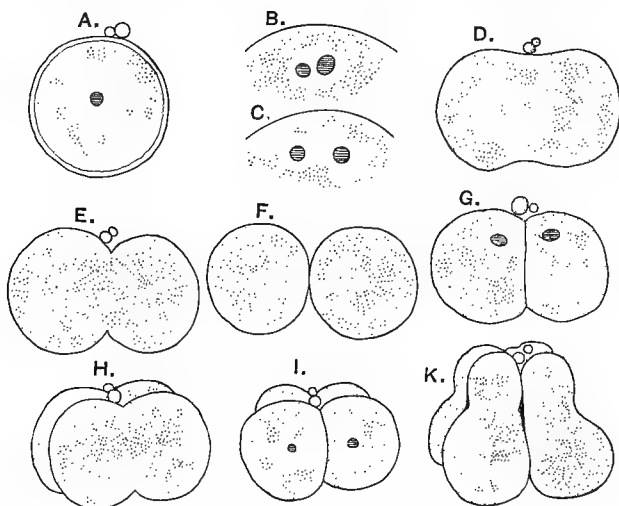

FIG. 68.—Early stages of segmentation of a mollusk, *Elysia viridis* (drawn from the living egg). A, oöspERM in state of rest after the extrusion of the polar cells; B, the nucleolus alone has divided; C, the nucleus is dividing; D, the nucleus, as such, has disappeared, first segmentation furrow appears; E, later stage; F, oöspERM divided into two distinct segmentation spheres, the clear nuclear space in the center of the aster of granules is growing larger; G, resting stage of appressed two spheres; H, I, similar stages in the production of four spheres; K, formation of eight-celled stage. (Haddon.)

character as nuclei and nucleoli, are replaced by asters (*polar stars*), which seem to arise in the protoplasm of the body of the cell, and which are in close juxtaposition at first, but later separate, the oöspERM becoming amœboid in one region at least. A groove, which gradually deepens, appears on the surface, and finally divides the cell into two halves, which at once become flattened against each other. The nucleus may again be recognized in the center of each polar star, while a new nucleolus also reappears within the nucleus, when again a brief period of rest ensues. In the division and reformation of the nucleus, when most complicated (*karyokinesis*), the changes may be generalized as consisting of division and segregation, followed by aggregation.

The subdivision (*segmentation*) of the cell, after the quiescence referred to, again commences, but in a plane at right angles to the first, from which four spheres result, again to be followed by the resting stage. The process continues in the same way, so that there is a progressive increase in the number of segments, at least up to the point when a large number

has been formed. This is rather to be considered as a type of one form of segmentation than as applicable to all, for even at this early stage differences are to be noted in the mode of segmentation which characterize effectually certain groups of animals; but in all there is segmentation, and that segmentation is rhythmical.

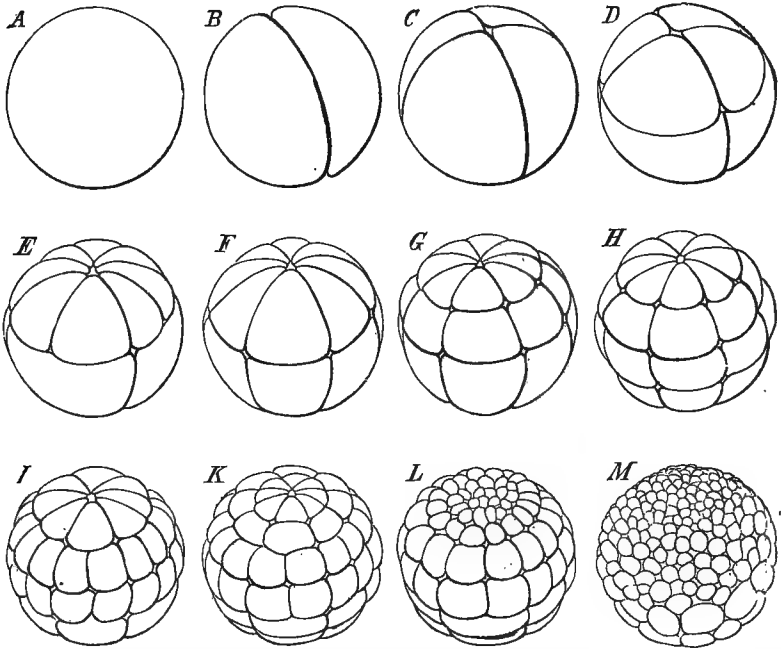
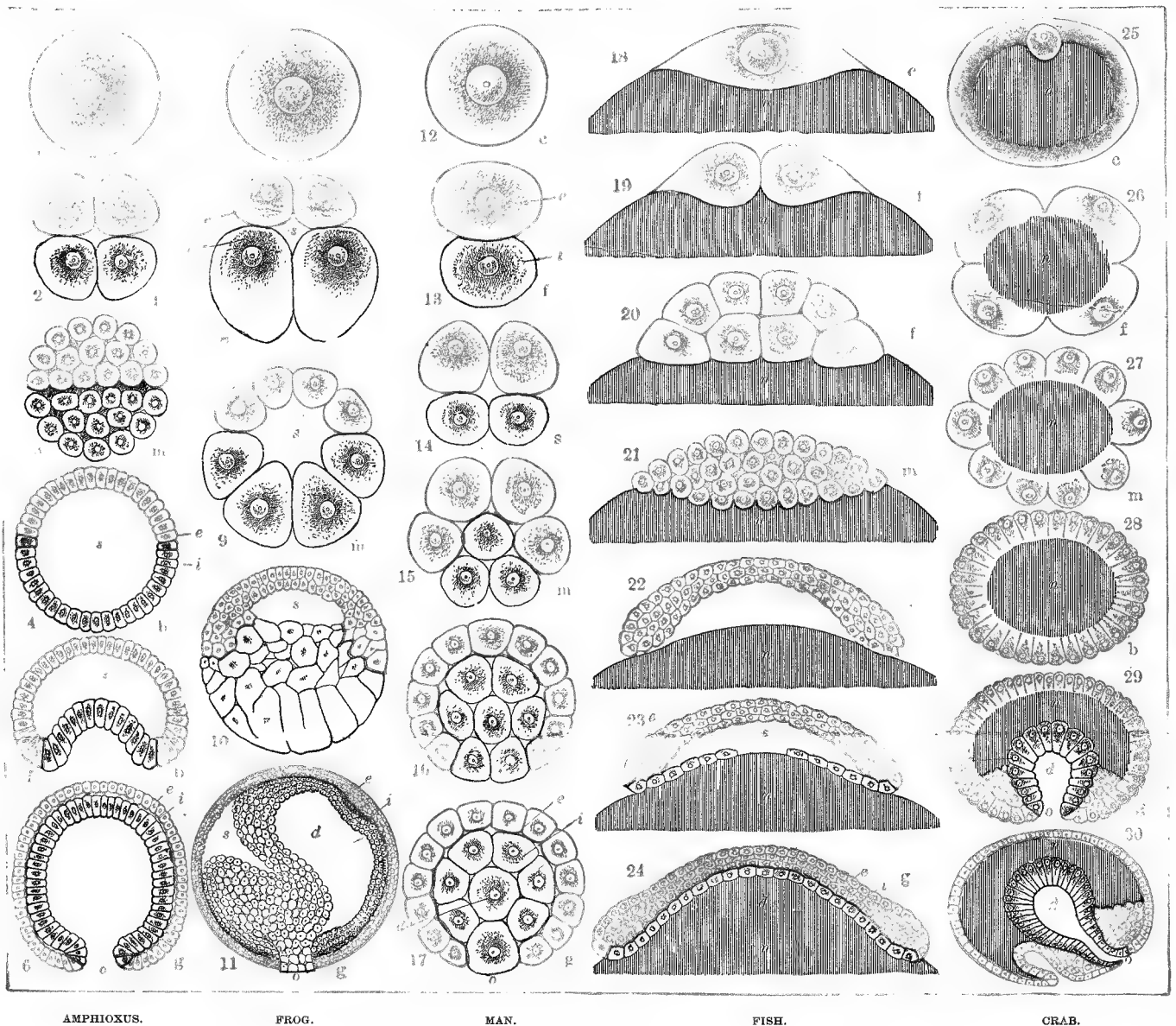

FIG. 69.—The cleavage of a frog's egg (10 times enlarged). *A*, the parent-cell; *B*, the two first cleavage-cells; *C*, 4 cells; *D*, 8 cells (4 animal and 4 vegetative); *E*, 12 cells (8 animal and 4 vegetative); *F*, 16 cells (8 animal and 8 vegetative); *G*, 24 cells (16 animal and 8 vegetative); *H*, 32 cells; *I*, 48 cells; *K*, 64 cells; *L*, 96 cleavage-cells; *M*, 160 cleavage-cells (128 animal and 32 vegetative). (Haeckel.)

Segmentation results in the formation of a multicellular aggregation which, sooner or later, incloses a central cavity (*segmentation cavity*, *blastocoele*). Usually this cell aggregation (*blastula*, *blastosphere*) is reduced to a single layer of investing cells.

The Gastrula.—Ensuing on the changes just described are others, which result in the formation of the gastrula, a form of cell aggregation of great interest from its resemblance to the *Hydra* and similar forms, which constitute in themselves independent animals that never pass beyond that stage. The blastula becomes flattened at one pole, then depressed, the cells at



AMPHIOXUS.

FROG.

MAN.

FISH.

CRAB.

PLATE I. GASTRULATION. (After Haeckel.)

Figs. 1 to 17 represent holoblastic eggs (with total cleavage); Figs. 18 to 30 show meroblastic eggs (with partial cleavage). The animal halves are colored gray, the vegetative halves red. The nutritive yolk is shaded vertically. All the figures show vertical meridional sections through the axis of the primitive intestine. In all, the letters indicate the same parts: *c*, the parent-cell (*cytula*); *f*, cleavage-cells (*segmentella*); *m*, the mulberry-germ (*morula*); *b*, the germ-vesicle (*blastula*); *g*, the cup-germ (*gastrula*); *s*, the cleavage-cavity; *d*, the primitive intestinal cavity; *o*, the primitive mouth; *n*, the nutritive yolk; *i*, the intestinal layer; *e*, the skin-layer.

Figs. 1-6.—Original or primordial egg-cleavage of the lowest vertebrate (*amphioxus*). Fig. 1, parent-cell (*cytula*); Fig. 2, cleavage-stage with 4 cleavage-cells; Fig. 3, mulberry-germ (*morula*); Fig. 4, germ-vesicle (*blastula*); Fig. 5, the same, in process of inversion (*invaginatio*); Fig. 6, bell-gastrula (*archigastrula*).

Figs. 7-11.—Unequal egg-cleavage of an amphibian (frog). Fig. 7, parent-cell (*cytula*); Fig. 8, cleavage-stage with 4 cleavage-cells; Fig. 9, mulberry-germ (*morula*); Fig. 10, germ-vesicle (*blastula*); Fig. 11, hood-gastrula (*amphigastrula*).

Figs. 12-17.—Unequal egg-cleavage of a mammal (man). Fig. 12, parent-cell (*cytula*); Fig. 13, cleavage-stage with 2 cleavage-cells (*e*, mother-cell of the exoderm; *i*, mother-cell of the entoderm); Fig. 14, cleavage-stage with 4 cleavage-cells; Fig. 15, beginning of the inversion of the germ-vesicle; Fig. 16, further advanced inversion; Fig. 17, hood-gastrula (*amphigastrula*).

Figs. 18-24.—Discoidal egg-cleavage of an osseous fish (*Motella* ? *Cottus* ?). The greater part of the nutritive yolk (*n*) is omitted. (Cf. Figs. 42, 43, pp. 217, 219, Haeckel's "Evolution of Man.") Fig. 18, parent-cell (*cytula*); Fig. 19, cleavage-stage with 2 cells; Fig. 20, cleavage-stage with 32 cells; Fig. 21, mulberry-germ (*morula*); Fig. 22, germ-vesicle (*blastula*); Fig. 23, the same, in process of inversion; Fig. 24, disc-gastrula (*discogastrula*).

Figs. 25-30.—Superficial egg-cleavage of a crab (*peneus*). Fig. 25, parent-cell (*cytula*); Fig. 26, cleavage-stage with 4 cells; Fig. 27, cleavage-stage with 32 cells; Fig. 28, mulberry-germ (*morula*), and at the same time the germ-vesicle (*blastula*); Fig. 29, bladder-gastrula (*perigastrula*); Fig. 30, nauplius-germ; the pharynx-cavity has formed in front of the primitive mouth (*d*), owing to an inversion from without.

this region becoming more columnar (*histological differentiation*). This depression (*invagination*) deepens until a cavity is

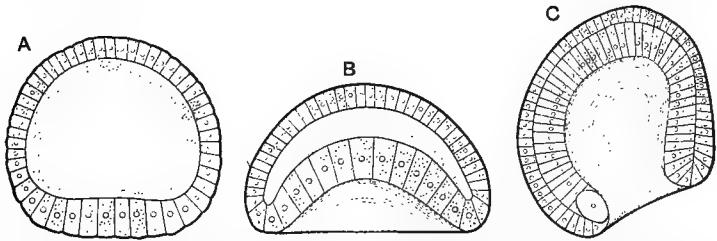

FIG. 70.—Blastula and gastrula of amphioxus (Claus, after Hatschek). A, blastula with flattened lower pole of larger cells; B, commencing invagination; C, gastrulation completed; the blastopore is still widely open, and one of the two hinder-pole mesoderm cells is seen at its ventral lip. The cilia of the epiblast cells are not represented.

formed (as when a hollow rubber ball is thrust in at one part till it meets the opposite wall), in consequence of which a two-layered embryo results, in which we recognize the primitive mouth (*blastopore*) and digestive cavity (*archenteron*), the outer layer (*ectoderm*) being usually separated from the inner (*endoderm*) by the almost obliterated segmentation cavity. Such a form may be provided with cilia, be very actively locomotive, and bear, consequently, the greatest resemblance to the permanent forms of some aquatic animals.

The changes by which the segmented oö sperm becomes a gastrula are not always so direct and simple as in the above-described case, but the behavior of the cells of the blastosphere may be hampered by a burden of relatively foreign matter, in the form of food-yolk, in certain instances; so much so is this the case that distinct modes of gastrula formation may be recognized as dependent on the quantity and arrangement of food-yolk. These we shall pass by as being somewhat too complicated for our purpose, and we return to the egg of the bird.

The Hen's Egg.—By far the larger part of the hen's egg is made up of yolk; but just beneath the vitelline membrane a small, circular, whitish body, about four millimetres in diameter, which always floats uppermost in every portion of the egg, may be seen. This disk (*blastoderm, cicatricula*) in the fertilized egg presents an outer white rim (*area opaca*), within which is a transparent zone (*area pellucida*), and most centrally a somewhat elongated structure, which marks off the future being itself (*embryo*). All of these parts together constitute that portion (*blastoderm*) of the fowl's egg which is alone directly concerned in reproduction, all the rest serving for nutrition and

protection. The appearance of relative opacity in some of the parts marked off as above is to be explained by thickening in the cell-layers of which they are composed.

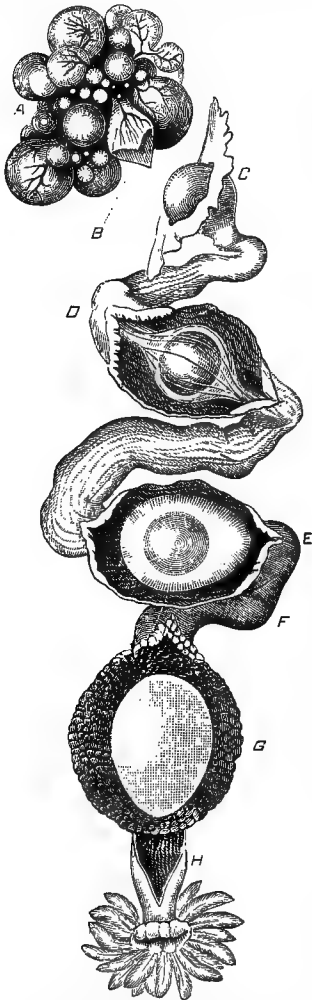

FIG. 71.—Female generative organs of the fowl (after Dalton). *A*, ovary; *B*, Graafian follicle, from which the egg has just been discharged; *C*, yolk, entering upper extremity of oviduct; *D*, *E*, second portion of oviduct, in which the chalaziferous membrane, chalazæ, and albumen are formed; *F*, third portion, in which the fibrous shell membranes are produced; *G*, fourth portion laid open, showing the egg completely formed with its calcareous shell; *H*, canal through which the egg is expelled.

The Origin of the Fowl's Egg.—

The ovary of a young but mature hen consists of a mass of connective tissue (*stroma*), abundantly supplied with blood-vessels, from which hang the capsules which contain the ova in all stages of development, so that the whole suggests, but for the color, a bunch of grapes in an early stage. The ovum at first, in this case as in all others, a single cell, becomes complex by addition of other cells (*discus proligerus*, etc.), which go to make up the yelk. All the other parts of the hen's egg are additions made to it, as explained before, in its passage down the oviduct. The original ovum remains as the blastoderm, the segmentation of which may now be described briefly, its character being obvious from an examination of Fig. 72, which represents a surface view of the segmenting fertilized ovum (*oö sperm*).

A segmentation cavity appears early, and is bounded above by a single layer of epiblast cells and below by a single layer of primitive hypoblast cells, which latter is soon composed of several layers, while the segmentation cavity disappears.

The blastoderm of an unincubated but fertilized egg consists of a layer of epiblastic cells, and beneath this a mass of rounded cells, arranged irregularly and lying loosely in the yelk, constitut-

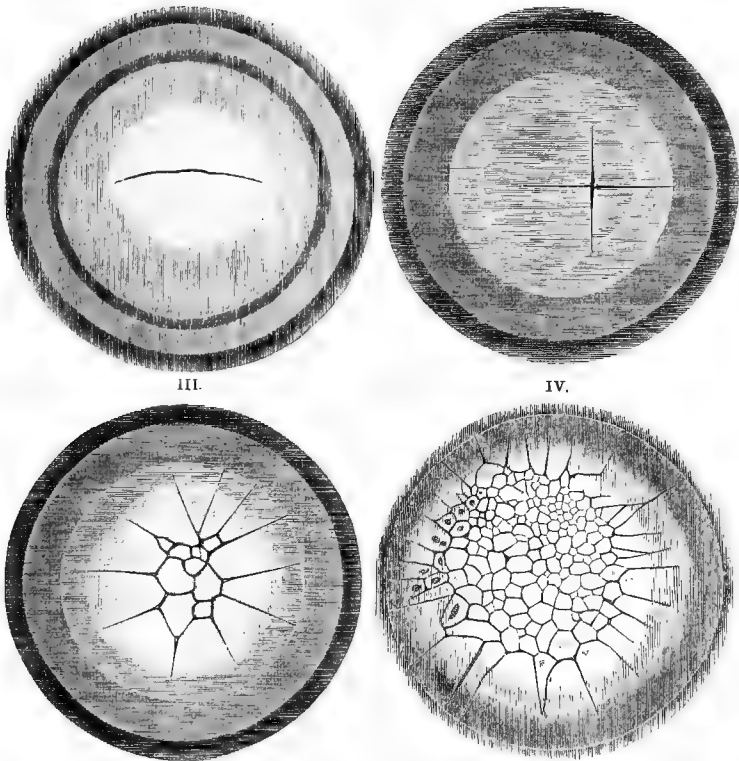

FIG. 72.—Various stages in the segmentation of a fowl's egg (Kölliker).

ing the primitive hypoblast. After incubation for a couple of hours, these cells become differentiated into a lower layer of flattened cells (*hypoblast*), with mesoblastic cells scattered between the epiblast and hypoblast. It is noteworthy that, in the bird, segmentation will proceed up to a certain stage independently of the advent of the male cell, apparently indicating a tendency to parthenogenesis.

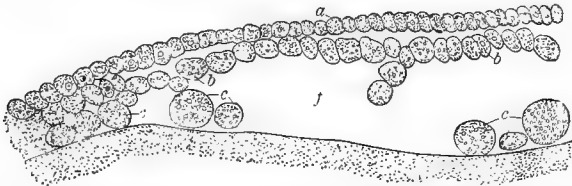

FIG. 73.—Portion of section through an unincubated fowl's oöspERM (after Klein). *a*, epiblast composed of a single layer of columnar cells; *b*, irregularly disposed lower layer cells of the primitive hypoblast; *c*, larger formative cells resting on white yolk; *f*, archenteron. The segmentation cavity lies between *a* and *b*, and is nearly obliterated.

The fowl's ovum then belongs to the class, a portion of which alone segments and develops into the embryo (*meroblastic*), in contradistinction to what happens in the mammalian ovum, the whole of which undergoes division (*holoblastic*); a distinction which is, however, superficial rather than fundamental, for in reality in the fowl's egg the whole of the original ovum does

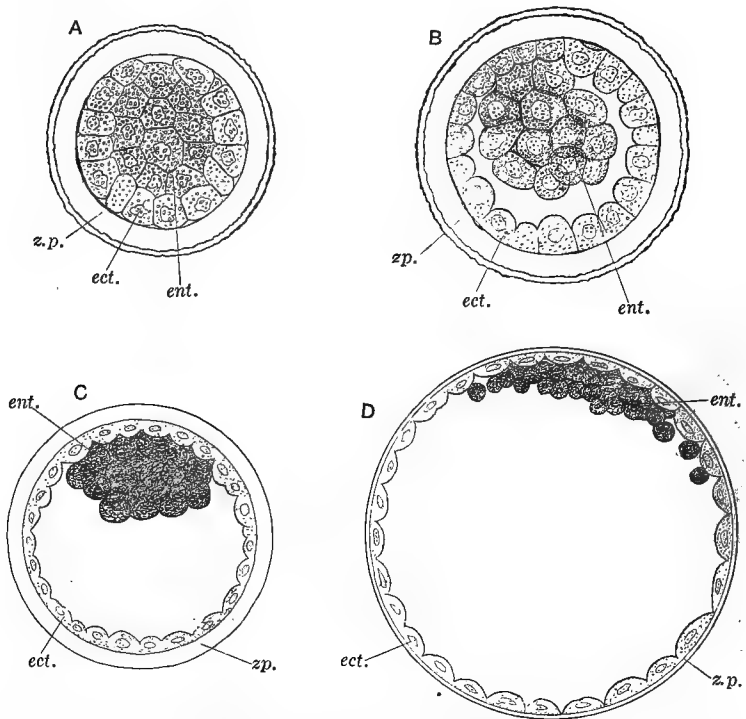

FIG. 74.—Sections of ovum of a rabbit, illustrating formation of the blastodermic vesicle (after E. Van Beneden). A, B, C, D, are ova in successive stages of development. *zp.*, zona pellucida; *ect.*, ectomeres, or outer cells; *ent.*, entomeres, or inner cells.

segment. This holoblastic character of the mammalian ovum and its resemblance to the segmentation of those invertebrate forms previously described may become apparent from an examination of the accompanying figures.

We shall return to the development of the mammalian ovum later; in the mean time we present the main features of development in the bird.

Remembering that the development of the embryo proper takes place within the pellucid area only, we point out that the area opaca gradually extends over the entire ovum, inclosing

the yelk, so that the original disk which lay like a watch-glass on the rest of the ovum, has grown into a sphere. That portion of this area nearest the pellucid zone (*area vasculosa*) develops

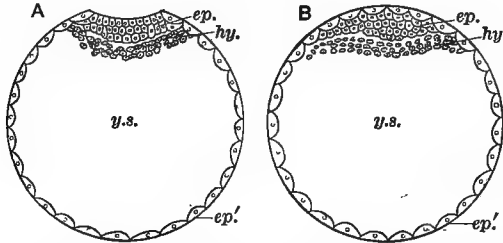

FIG. 75.—Diagrammatic transverse sections through a hypothetical mammal oö sperm (Haddon). A. The yelk of the primitive mammalian oö sperm is now lost. B. Later stage; the non-embryonic epiblast has grown over the embryonic area to form the covering cells. *ep.*, epiblast of embryo; *ep'*, epiblast of yelk-sac; *hy.*, primitive hypoblast; *y. s.*, yelk-sac, or blastodermic vesicle.

blood-vessels that derive the food-supplies, which replenish the blood as it is exhausted, from the hypoblast of the *area opaca*.

The first indications of future structural outlines in the embryo is the formation of the *primitive streak*, an opaque band in the long diameter of the pellucid area, opaque in consequence of cell accumulation in that region. Very soon a groove (*primitive groove*) extends throughout this band, which gradually occupies a more central position. The relative thickness of the several parts and the arrangement of cells may be gathered from Fig. 76. These structures are only temporary, and those that replace them will be described subsequently.

We have thus far spoken of cells as being arranged into epiblast, hypoblast, and mesoblast. The origin of the first two has been sufficiently indicated. The mesoblast forms the intermediate germinal layer, and is derived from the primitive hypoblast, which differentiates into a stratum of flattened cells, situated below the others, and constituting the later hypoblast, and in-

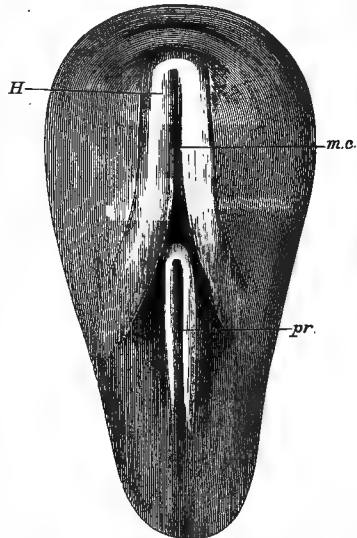

FIG. 76.—Surface view of pellucid area of blastoderm of eighteen hours (Foster and Balfour). *H.*, medullary groove; *mc.*, medullary folds; *pr.*, primitive groove.

intermediate less closely arranged cells, termed, from their position, mesoblast.

It will be noticed that all future growth of the embryo begins axially, at least in the early stages of its development.

As the subsequent growth and advance of the embryo depend on an abundant and suitable nutritive supply, we must now turn to those arrangements which are temporary and of subordinate importance, but still for the time essential to development.

EMBRYONIC MEMBRANES OF BIRDS.

It will be borne in mind throughout that the chief food-supply for the embryo bird is derived from the yolk; and, as would

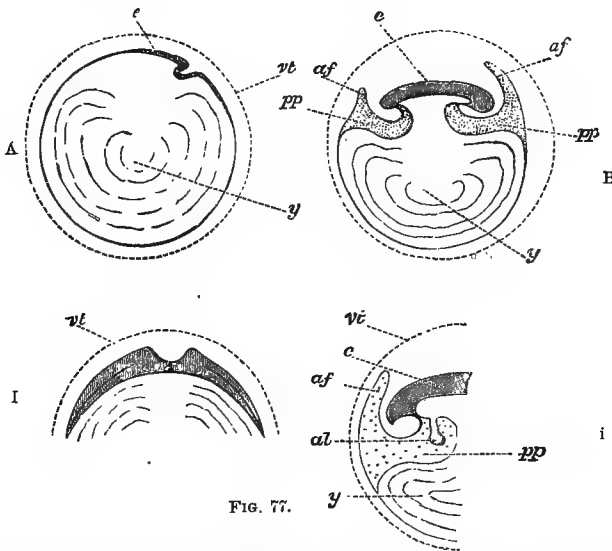

FIG. 77.

FIGS. 77-79.—A series of diagrams intended to facilitate the comprehension of the relations of the membranes to other parts (after Foster and Balfour). A, B, C, D, E, F are vertical sections in the long axis of the embryo at different periods, showing the stages of development of the amnion and of the yolk-sac. I, II, III, IV are transverse sections at about the same stages of development. i, ii, iii, posterior part of longitudinal section, to illustrate three stages in formation of the allantois. e, embryo; y, yolk; pp, pleuroperitoneal cavity; vt, vitelline membrane of amniotic fold; al, allantois; a, amnion; a', alimentary canal.

be expected, the older the embryo the smaller the yolk, or, as it is now called when limited by the embryonic membranes, the *yolk-sac* (*umbilical vesicle* of the mammalian embryo). The manner in which this takes place will appear upon an inspection of the accompanying figures.

Very early in the history of the embryo two eminences, the head and the tail folds, arise, and, curving over toward each

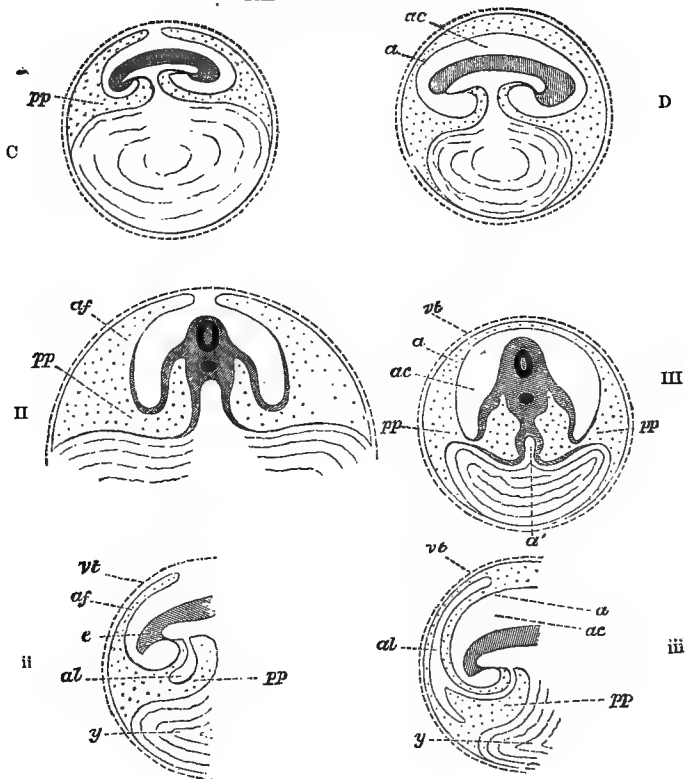

FIG. 78.

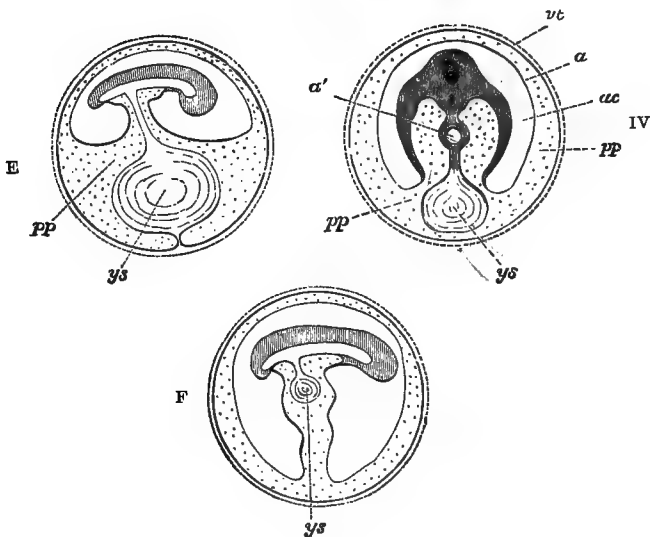

FIG. 79.

other, meet after being joined by corresponding lateral folds. Fusion and absorption result at this meeting-point, in the inclosure of one cavity and the blending of two others. These

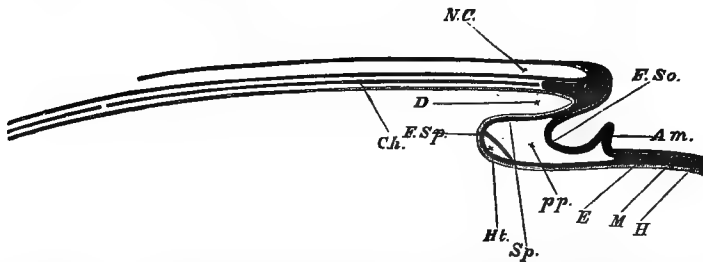

FIG. 80.—Diagrammatic longitudinal section through the axis of an embryo chick (after Foster and Balfour). *N. C.*, Neural canal; *Ch.*, notochord; *Fg.*, foregut; *F. So.*, somatopleure; *F. Sp.*, splanchnopleure; *Sp.*, splanchnopleure, forming lower wall of foregut; *Ht.*, heart; *pp.*, pleuroperitoneal cavity; *Am.*, amniotic fold; *E*, epiblast; *M*, mesoblast; *H*, hypoblast.

folds constitute the amniotic membranes, the inner of which forms the *true amnion*, the outer the *false amnion* (*serous membrane, subzonal membrane*). Within the amnion proper is the amniotic cavity filled with fluid (*liquor amnii*), while the space between the true and false amniotic folds, which gradually increases in size as the yelk-sac diminishes, forms the *pleuroperitoneal cavity, body cavity, or cœlom*. The amniotic cavity also extends, so that the embryo is surrounded by it or lies centrally within it. The enlargement of the cœlom and extension of the false amniotic folds lead finally to a similar meeting and fusion like that which occurred in the formation of the true amniotic cavity. The yelk-sac, gradually lessening, is at last withdrawn into the body of the embryo.

Fig. 80 shows how the amniotic head fold arises, from a budding out of the epiblast and mesoblast at a point where the original cell layers of the embryo have separated into two folds, the *somatopleure* or body fold and the *splanchnopleure* or visceral fold, owing to a division or cleavage of the mesoblast toward the long axis of the body. Remembering this, it is always easy to determine by a diagram the composition of any one of the membranes or folds of the embryo, for the components must be epiblast, mesoblast, or hypoblast; thus, the splanchnopleure is made up of hypoblast internally and mesoblast externally—a principle of great significance, since, as will be learned later, all the tissues of the body may be classified simply, and at the same time scientifically, according to their embryological origin.

The *allantois* is a structure of much physiological importance. It arises at the same time as the amniotic folds are forming, by a budding or protrusion of the hind-gut into the

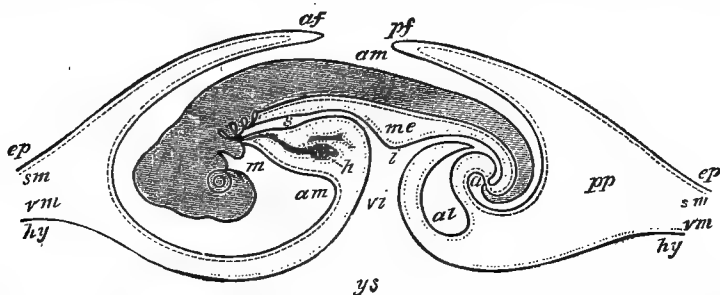

FIG. 81.—Diagrammatic longitudinal section of a chick of the fourth day (after Allen Thomson). *ep*, epiblast; *hy*, hypoblast; *sm*, somatopleure; *vm*, splanchnopleure; *af*, *pf*, folds of the amnion; *pp*, pleuroperitoneal cavity; *am*, cavity of the amnion; *al*, allantois; *a*, position of the future anus; *h*, heart; *i*, intestine; *vi*, vitelline duct; *ys*, yolk; *s*, foregut; *m*, position of the mouth; *me*, mesentery.

pleuro-peritoneal cavity, and hence consists of an outgrowth of mesoblast lined by hypoblast.

The outer membrane of the allantois fuses with the *subzonal* (serous) membrane, and, with the latter extending beyond the yolk-sac, incloses the albumen of the egg in a space termed

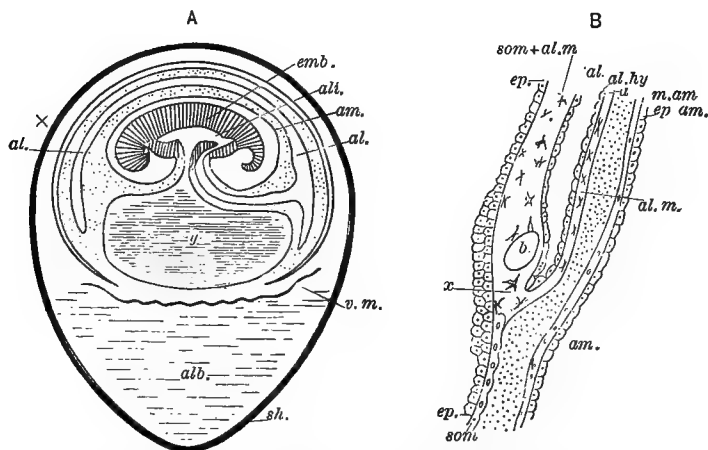

FIG. 82.—A. Diagrammatic longitudinal section through the egg of a fowl. B. Detail of portion of same at a time when the allantois reached the spot marked \times in A (after Duval). *al*, cavity of allantois; *alb*, albumen; *ali*, mesenteron; *al. hy*, hypoblastic epithelium of allantois; *al. m.*, mesoblast of allantois; *am*, cavity of amnion; *b*, blood-vessel; *emb*, embryo; *ep*, epiblast of outer layer of amnion (serous membrane); *ep. am*, epiblastic epithelium of inner layer of amnion (amnion proper); *m. am*, mesoblastic layer of latter; *sh*, egg-shell; *som*, somatic mesoblast of outer layer of amnion; *v. m.*, vitelline membrane; *x*, point where the mesoblastic tissue of the allantois fuses with that of the serous membrane.

the *placental sac* by Duval, who has recently described this process. *Villi*, or tubular vascular outgrowths, spring from the lining of this sac and serve to convey the absorbed and probably altered albumen to the embryo, in which process of vascular transport of nourishment the yelk-sac, that also abounds in blood-vessels as well as the allantois, takes part. The physiological import of the various structures above described will be considered more fully later. At this point a comparison of the formation of the corresponding parts in mammals will be undertaken.

THE FŒTAL (EMBRYONIC) MEMBRANES OF MAMMALS.

The differences between the development of the egg membranes of mammals and birds are chiefly such as result from

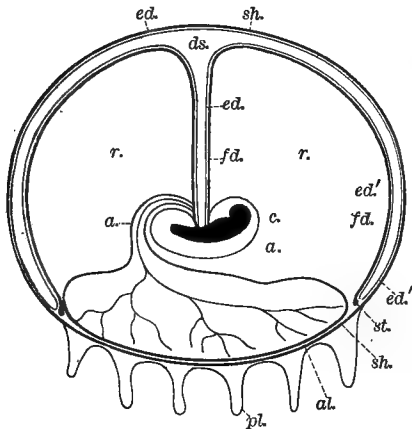

FIG. 83.

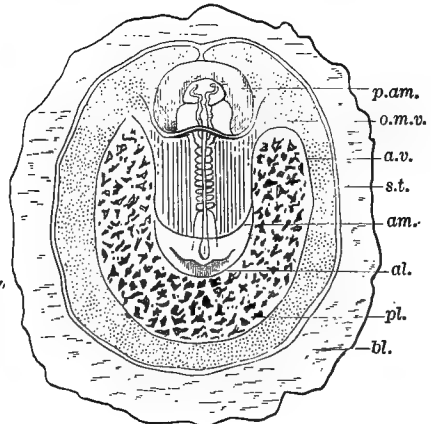

FIG. 84.

FIG. 83.—Diagrammatic longitudinal section of oöperm of rabbit at an advanced stage of pregnancy (Kölliker, after Bischoff). *a*, amnion; *al*, allantois with its blood-vessels; *e*, embryo; *ds*, yelk-sac; *ed*, *ed'*, *ed''*, hypoblastic epithelium of the yelk-sac and its stalk (umbilical vesicle and cord); *fd*, vascular mesoblastic membrane of the umbilical cord and vesicle; *r*, placental villi formed by the allantois and subzonal membrane; *r*, space filled with fluid between the amnion, the allantois, and the yelk-sac; *st*, sinus terminalis (marginal vitelline blood-vessel); *u*, urachus, or stalk of the allantois.

FIG. 84.—Diagrammatic dorsal view of an embryo rabbit with its membranes at the stage of nine somites (Haddon, after Van Beneden and Julin). *al*, allantois, showing from behind the tail fold of the embryo; *am*, anterior border of true amnion; *a.v.*, area vasculosa, the outer border of which indicates the farthest extension of the mesoblast; *bl*, blastoderm, here consisting only of epiblast and hypoblast; *o.m.v.*, omphalo-mesenteric or vitelline veins; *p.am.*, proamnion; *pl*, non-vascular epiblastic villi of the future placenta; *s.t.*, sinus terminalis.

the absence in the former of an egg-shell and its membranes, and of yelk and albumen. The mammalian ovum is inclosed by a *zona radiata* (*zona pellucida*) surrounding another very delicate covering (Fig. 58).

The growth of the *blastodermic vesicle* (yelk-sac) is rapid,

and, being filled with fluid, the zona is thinned and soon disappears.

The germinal area alone is made up of three layers of cells (Fig. 104), the rest of the upper part of the oö sperm being lined with epiblast and hypoblast, while the lower zone of the yelk-sac consists of epiblast only.

Simple, non-vascular villi, serving to attach the embryo to the uterine walls, usually project from the epiblast of the subzonal membrane. In the rabbit they do not occur everywhere, but only in that region of the epiblast beneath which the mesoblast does not extend, with the exception of a patch which soon appears and demarkates the site of the future placenta.

The extension of the mesoblast takes place in every direction from the embryo except directly around the head; but the two

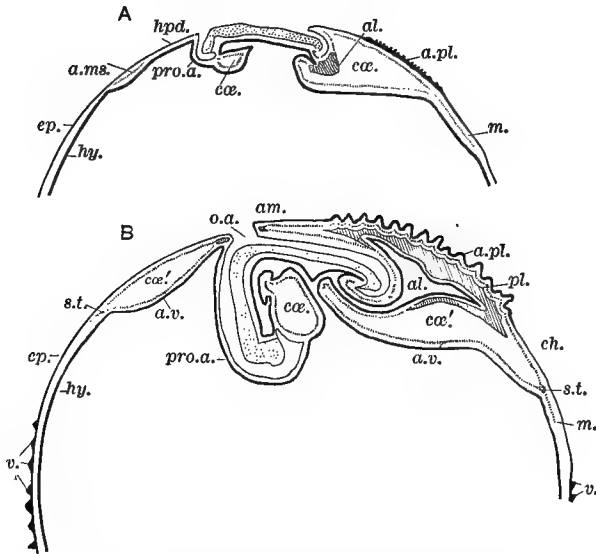

FIG. 85.—Diagrammatic median vertical longitudinal sections through embryo rabbit (Had-don, after Van Beneden and Julin). A. Section through embryo of Fig. 84. B. Section through embryo of eleven days. *al.*, allantois; *am.*, amnion; *a. ms.*, anterior median plate of mesoblast, formed by the junction of the anterior horns of the area opaca; *a. pl.*, area placentalis; *a. v.*, area vasculosa; *ch.*, chorion; *cœ.*, cœlom of embryo; *cœ'*, extra-embryonic portion of the body-cavity; *ep.*, epiblast; *hy.*, hypoblast; *m.*, unsplit mesoblast; *o. a.*, orifice of amnion; *pl.*, placenta; *pro. a.*, proamniotic; *s. t.*, sinus terminalis; *v.*, epiblastic villi of blastodermic vesicle.

expansions of the mesoblast which mark out this area extend for some distance in front of the head, and ultimately unite; so that immediately in front of the head there is a circular region in which the blastoderm consists of epiblast and hypo-

blast only, forming a cavity into which the anterior part of the embryo early projects (*pro-amnion*).

The true amnion arises only from the posterior end of the embryo, and, extending over in a forward direction, meets the raised projection of the pro-amnion with which it fuses.

The amniotic cavity becomes one with that space (extra-embryonic pleuro-peritoneal cavity) arising from the cleavage of

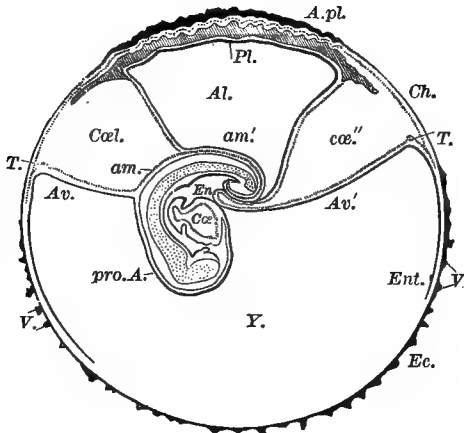

FIG. 86.—Fœtal envelopes of a rabbit embryo (Minot, after Van Beneden and Julin). Later stage than Fig. 85 B. The amnion has become fused with the blastoderm in front of the embryo, and its cavity is therefore continuous with the extra-embryonic portion of the body-cavity in front of the embryo. *Al*, allantois; *am*, amnion; *am'*, portion of the amnion united with the walls of the allantois; *A. pl.*, area placentalis; *Av*, area vasculosa; *Ch*, chorion; *Cœl.*, coelom or body-cavity; *Cœ''*, extra-embryonic portion of the body-cavity; *Cœl.*, anterior portion of the area opaca; *Ec*, epiblast, produced by the fusion of the cavity of the amnion with that of the anterior portion of the area opaca; *Ent.*, hypoblast; *Pl.*, placenta; *pro. A.*, pro-amnion; *T.*, sinus terminalis; *V.*, villi of blastodermic vesicle; *Y.*, cavity of blastodermic vesicle.

the mesoblast, which now advances beyond the head of the embryo and the pro-amnion. The pro-amnion by gradual atrophy gives place to the true amnion.

At about the same period as these events are transpiring the vascular yelk-sac has become smaller, and the allantois with its abundant supply of blood-vessels is becoming more prominent, and extending between the amnion and subzonal membrane.

The formation of the *chorion* marks an important step in the development of mammals in which it plays an important functional part. It is the result of the fusion of the allantois, which is highly vascular, with the subzonal membrane, the villi of which now become themselves vascular and more complex in other respects.

An interesting resemblance to birds has been observed (by Osborn) in the opossum. When the allantois is small the



FIG. 87.—Embryo of dog, twenty-five days old, opened on the ventral side. Chest and ventral walls have been removed. *a*, nose-pits; *b*, eyes; *c*, under-jaw (first gill-arch); *d*, second gill-arch; *e*, *f*, *g*, *h*, heart (*e*, right, *f*, left auricle; *g*, right, *h*, left ventricle); *i*, aorta (origin of); *kk*, liver (in the middle between the two lobes is the cut yolk-vein); *l*, stomach; *m*, intestine; *n*, yolk-sac; *o*, primitive kidneys; *p*, allantois; *q*, fore-limbs; *r*, hind-limbs. The crooked embryo has been stretched straight. (Haeckel, after Bischoff.)

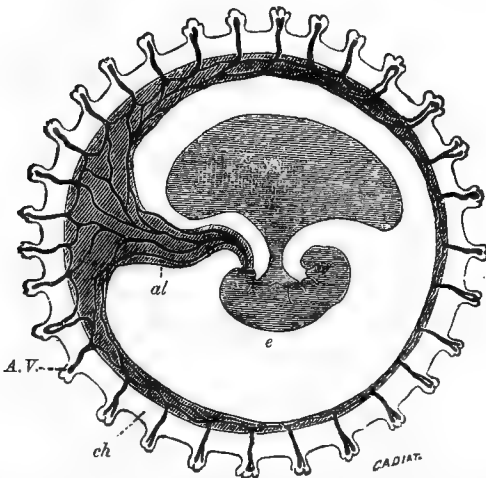

FIG. 88.—Diagram of an embryo showing the relations of the vascular allantois to the villi of the chorion (Cadiat). *e*, embryo lying in the cavity of the amnion; *ys*, yolk-sac; *al*, allantois; *A. V.*, allantoic vessels dipping into the villi of the chorion; *ch*, chorion.

blastodermic vesicle (yelk-sac) has vascular villi, which in all probability not only serve the purpose of attaching the embryo to the uterine wall but derive nourishment, not as in birds, from the albumen of the ovum, but directly in some way from the uterine wall of the mother. It will be remembered that the

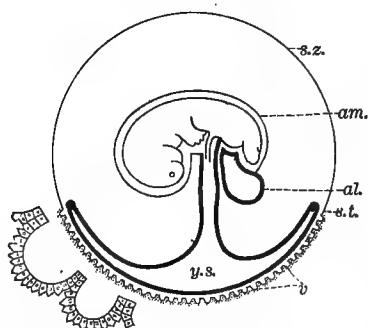

FIG. 89.—Diagram of the foetal membranes of the Virginian opossum (Haddon, after Osborn). Two villi are shown greatly enlarged. The processes of the cells, which have been exaggerated, doubtless correspond to the pseudopodia described by Caldwell. *al.*, allantois; *am.*, amnion; *s. z.*, sinus terminalis; *s. z.*, subzonal membrane; *v.*, villi on the subzonal membrane in the region of the yelk-sac; *ys.*, yelk sac. The vascular splanchnopleure (hy-poblast and mesoblast) is indicated by the black line.

opossum ranks low in the mammalian scale, so that this resemblance is the more significant from an evolutionary point of view.

The term *chorion* is now restricted to those regions of the subzonal membrane to which either the yelk-sac or the allantois is attached. The former zone has been distinguished as the false chorion and the latter as the true chorion. In the rabbit the false chorion is very large (Fig. 83), and the (placental) chorion very small in comparison, but the reverse is the case in most mammals. It will be noted that in both birds and mammals the allantois is a nutritive organ.

Usually the more prominent and persistent the yelk-sac, the less so the allantois, and *vice versa*; they are plainly supplementary organs.

The Placenta.—This structure, which varies greatly in complexity, may be regarded as the result of the union of structures existing for a longer or shorter period, free and largely independent of each other. With evolution there is differentiation and complication, so that the placenta usually marks the site where structures have met and fused, differentiating a new organ; while corresponding atrophy, obliteration, and fusion take place in other regions.

All placentas are highly vascular, all are villous, all discharge similar functions in providing the embryo with nourishment and eliminating the waste of its cell-life (metabolism). In structural details they are so different that classifications of mammals have been founded upon their resemblances and differences. These will now be briefly described.

In marsupials the yelk-sac is both large and vascular; the

allantois small but vascular; the former is said (Owen) to be attached to the subzonal membrane, the latter not; but no villi, and consequently no true chorion, is developed. All mammals other than the monotremes and marsupials have a true allantoic placenta.

The Discoidal Placenta.—This form of placenta is that existing in the rodentia, insectivora, and cheiroptera. The condition found in the rabbit is that which has been most studied. The relation of parts is shown in Fig. 83.

The uterus of the rodent is two-horned; so we find in general several embryos in each horn in the pregnant rabbit. They are functionally independent, each having its own set of membranes. It will be observed from the figure that the true villous chorion is confined to a comparatively small region; there is, however, in addition a false chorion without villi, but highly vascular. This blending of forms of placentation which exist separately in different groups of animals is significant. In the rabbit, at a later stage, there is considerable intermingling of foetal and maternal parts.

The Metadiscoidal Placenta.—This type, which, in general naked-eye appearances, greatly resembles the former, is found in man and the apes. The condition of things in man is by no means as well understood as in the lower mammals, especially in the early stages; so that, while the following account is that usually given in works on embryology, the student may as well understand that our knowledge of human embryology in the very earliest stages is incomplete and partly conjectural. The reason of this is obvious: specimens for examination depending on accidents giving rise to abortion or sudden death, often not reaching the laboratory in a condition permitting of trustworthy inferences.

It is definitely known that the ovum, which is usually fertilized in the oviduct (Fallopian tube), on entering the uterus becomes adherent to its wall and encapsuled. The mucous membrane of the uterus is known to undergo changes, its component parts increasing by cell multiplication, becoming intensely vascular and functionally more active. The general mucous surface shares in this, and is termed the *decidua vera*; but the locality where the ovum lodges is the seat of the greatest manifestation of exalted activity, and is termed the *decidua serotina*; while the part believed to have invested the ovum by fused growths from the junction of the *decidua vera* and *serotina* is the *decidua reflexa*.

The decidua serotina and reflexa thus become the outermost of all the coverings of the ovum. These and some other developments are figured below. It is to be remembered, however, that they are highly diagrammatic, and represent a mixture

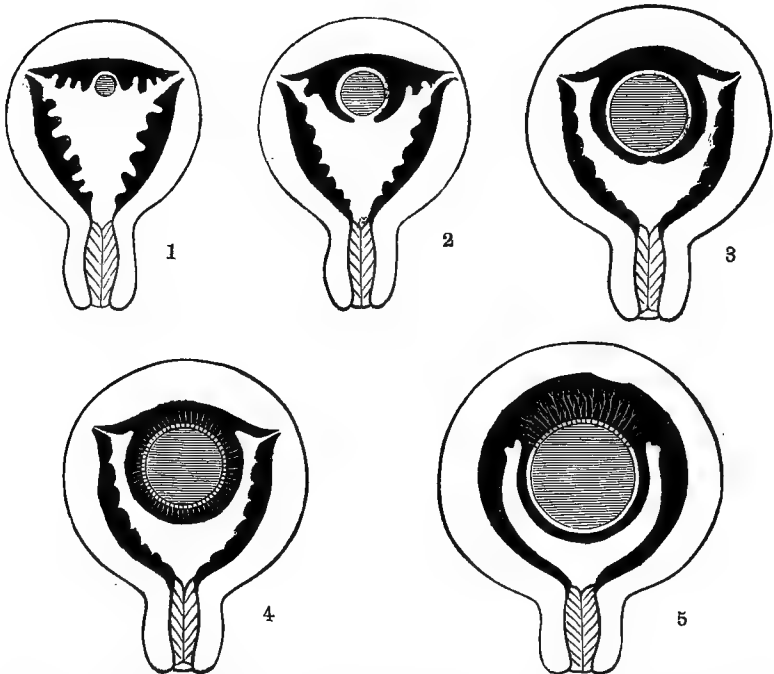

FIG. 90.—Series of diagrams representing the relations of the decidua to the ovum, at different periods, in the human subject. The decidua are dark, the ovum shaded transversely. In 4 and 5 the chorionic vascular processes are figured (after Dalton). 1. Ovum resting on the decidua serotina; 2. Decidua reflexa growing round the ovum; 3. Completion of the decidua around the ovum; 4. Villi, growing out all around the chorion; 5. The villi, specially developed at the site of the future placenta, having atrophied elsewhere.

of inferences based, some of them, on actual observation and others on analogy, etc.

The figures will convey some information, though appearances in all such cases must be interpreted cautiously for the reasons already mentioned.

During the first fourteen days villi appear over the whole surface of the ovum; about this fact there is no doubt. At the end of the first month of fetal life, a complete chorion has been formed, owing, it would seem, to the growth of the allantois (its mesoblast only) beneath the whole surface of the subzonal membrane. From the chorionic surface vascular processes clothed with epithelium project like the plush of velvet.

The allantois is compressed and devoid of a cavity, but abundantly supplied with blood-vessels by the allantoic arteries and

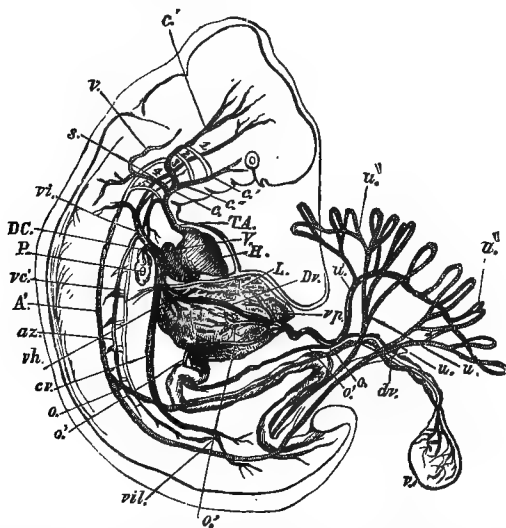

FIG. 91.—Vascular system of the human foetus, represented diagrammatically (Huxley). *H*, heart; *T.A.*, aortic trunk; *c*, common carotid artery; *c'*, external carotid artery; *c''*, internal carotid artery; *s*, subclavian artery; *v*, vertebral artery; 1, 2, 3, 4, 5, aortic arches; *A'*, dorsal aorta; *o*, omphalo-mesenteric artery; *dv*, vitelline duct; *o'*, omphalo-mesenteric vein; *v'*, umbilical vesicle; *vp*, portal vein; *L*, liver; *u, u*, umbilical arteries; *u', u''*, their endings in the placenta; *u'*, umbilical vein; *Dv*, ductus venosus; *vh*, hepatic vein; *cv*, inferior vena cava; *vil*, iliac veins; *az*, vena azygos; *vc'*, posterior cardinal vein; *DC*, duct of Cuvier; *P*, lung.

veins, which of course terminate in capillaries in the villi. Compare the whole series of figures.

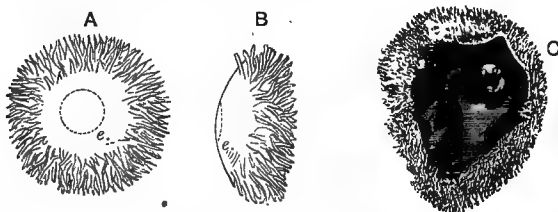

FIG. 92.—Human ova during early stages of development. *A* and *B*, front and side view of an ovum supposed to be about thirteen days old; *e*, embryonic area (Quain, after Reichert); *C*, ovum of four to five weeks, showing the general structure of the ovum before formation of the placenta. Part of the wall of the ovum is removed to show the embryo in position (after Allen Thomson).

At this stage the condition of the chorion suggests the type of the diffuse placenta which is normal for certain groups of animals, as will presently be learned.

The subsequent changes are much better understood, for

parts are in general no longer microscopic but of considerable size, and their real structure less readily obscured or obliterated.

The amniotic cavity continues to enlarge by growth of the walls of the amnion and is kept filled with a fluid; the yolk-sac is now very small; the decidua reflexa becomes almost non-vascular, and fuses finally with the decidua vera and the chorion, which except at one part has ceased to be villous and vascular; so that becoming thinner and thinner with the advance of pregnancy, the single membrane, arising practically from this fusion of several, is of a low type of structure, the result of

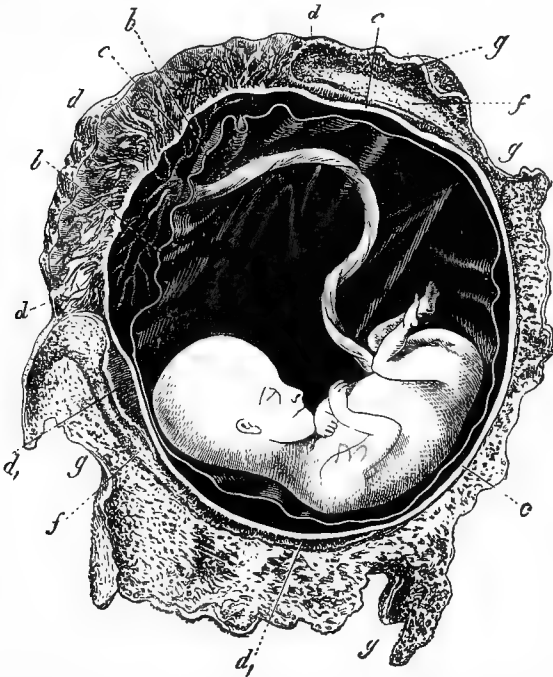

FIG. 93.—Human embryo, twelve weeks old, with its coverings; natural size. The navel-cord passes from the navel to the placenta. *b*, amnion; *c*, chorion; *d*, placenta; *d'*, remains of tufts on the smooth chorion; *f*, decidua reflexa (inner); *g*, decidua vera (outer). (Haeckel after Bernhard Schultze.)

gradual degeneration, as the rôle they once played was taken up by other parts.

But of paramount importance is the formation of the *placenta*. The chorion ceases to be vascular except at the spot at which the villi not only remain, but become more vascular and branch into arborescent forms of considerable complexity. It is discoidal in form, made up of a foetal part just described and

a maternal part, the decidua serotina, the two becoming blended so that the removal of one involves that of more or less of the others. The connection of parts is far closer than that described for the rabbit; and, even with the preparation that Nature makes for the final separation of the placenta from both foetus and

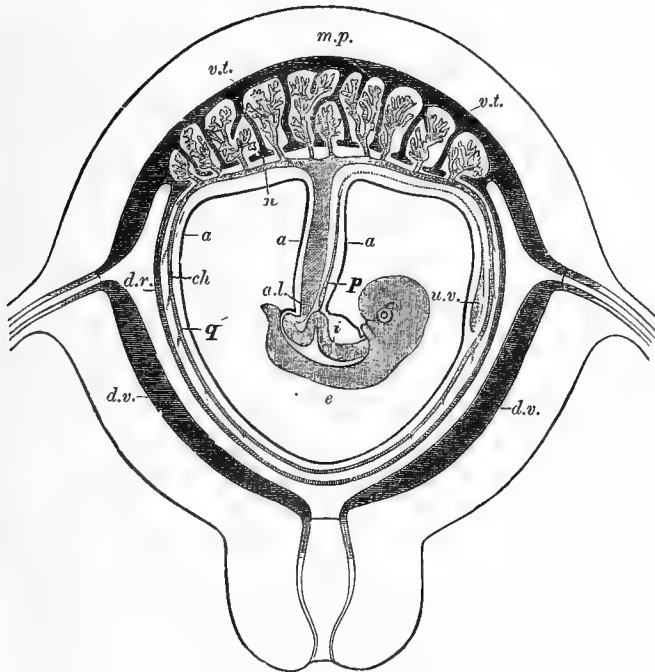

FIG. 94.—Diagram illustrating the decidua, placenta, etc. (after Liégeois). *e*, embryo; *i*, intestine; *p*, pedicle of the umbilical vesicle; *u. v.*, umbilical vesicle; *a*, amnion; *ch*, chorion; *v. t.*, vascular tufts of the chorion, constituting the foetal portion of the placenta; *m. p.*, maternal portion of the placenta; *d. v.*, decidua vera; *d. r.*, decidua reflexa; *a. l.*, allantois.

mother, this event does not take place without some rupture of vessels and consequent hæmorrhage.

It is difficult to conceive of the great vascularity of the human placenta without an actual examination of this structure itself, which can be done after being cast off to great advantage when floating in water; by which simple method also the thinness and other characteristics of the membranes can be well made out.

The great vessels conveying the foetal blood to and from the placenta are reduced to three, two arteries and one vein. The villi of the placenta (chorion) are usually said to hang freely

in the blood of the large irregular sinuses of the decidua serotina; but this is so unlike what prevails in other groups of animals that we can not refrain from believing that the statement is not wholly true.

The Zonary Placenta.—In this type the placenta is formed along a broad equatorial belt, leaving the poles free. This form of placentation is exemplified in the carnivora, hyrax, the elephant, etc.

In the dog, for example, the yolk-sac is large, vascular, does not fuse with the chorion, and persists throughout. A rudimentary discoid placenta is first formed, as in the rabbit; this gradually spreads over the whole central area, till only the extremes (poles) of the ovum remain free; villi appear, fitting into pits in the uterine surface, the maternal and foetal parts of the placenta becoming highly vascular and closely approximated. The chorionic zone remains wider than the placental. As in man there is at birth a separation of the maternal as well as foetal part of the placenta—i. e., the latter is deciduate; there is also the beginning of a decidua reflexa.

The Diffuse Placenta.—As found in the horse, pig, lemur, etc., the allantois completely incloses the embryo, and it becomes villous in all parts, except a small area at each pole.

The Polycotyledonary Placenta.—This form is that met with in ruminants, in which case the allantois completely covers the surface of the subzonal membrane, the placental villi being gathered into patches (*cotyledons*), which are equivalent to so many independent placentas. The component villi fit into corresponding pits in the uterine wall, which is specially thickened at these points. When examined in a fresh condition, under water, they constitute very beautiful objects.

Comparing the formation, complete development, and atrophy (in some cases) of the various foetal appendages in mammals, one can not but perceive a common plan of structure, with variations in the preponderance of one part over another here and there throughout. In birds these structures are simpler, chiefly because less blended and because of the presence of much food-yolk, albumen, egg-shell, etc., on the one hand, and the absence of a uterine wall, with which in the mammal the membranes are brought into close relationship, on the other; but, as will be shown later, whatever the variations, they are adaptations to meet common needs and subserve common ends.

MICROSCOPIC STRUCTURE OF THE PLACENTA.

This varies somewhat for different forms, though, in that there is a supporting matrix, minute (capillary) blood-vessels, and epithelial coverings to the foetal and maternal surfaces, the several forms agree.

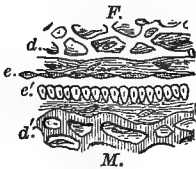

FIG. 95.

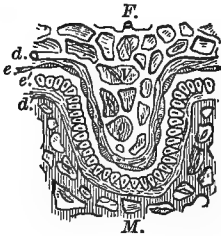

FIG. 96.

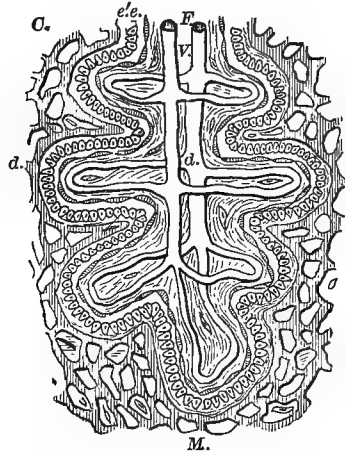

FIG. 97.

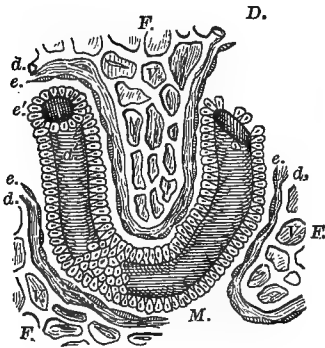

FIG. 98.

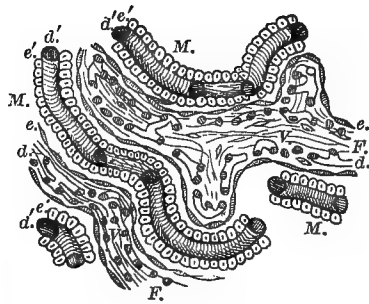

FIG. 99.

FIGS. 95 TO 101.—Diagrammatic representation of the minute structure of the placenta (Foster and Balfour, after Turner). *F*, foetal; *M*, maternal placenta; *e*, epithelium of chorion; *e'*, epithelium of maternal placenta; *d*, foetal blood-vessels; *d'*, maternal blood-vessels; *v*, villus.

FIG. 95.—Placenta in most generalized form.

FIG. 96.—Structure of placenta of a pig.

FIG. 97.—Of a cow.

FIG. 98.—Of a fox.

FIG. 99.—Of a cat.

The pig possesses the simplest form of placenta yet known. The villi fit into depressions or crypts in the maternal uterine mucous membrane. The villi, consisting of a core of connective

tissue, in which capillaries abound, are covered with a flat epithelium; the maternal crypts correspond, being composed of a similar matrix, lined with epithelium and permeated by capillary vessels, which constitute a plexus or mesh-work. It thus results that two layers of epithelium intervene between the maternal and foetal capillaries.

The arrangement is substantially the same in the diffuse and the cotyledonary placenta.

In the deciduate placenta, naturally, there is greater complication.

In certain forms, as in the fox and cat, the maternal tissue shows a system of trabeculæ assuming a meshed form, in which run dilated capillaries. These, which are covered with a somewhat columnar epithelium, are everywhere in contact with the foetal villi, which are themselves covered with a flat epithelium.

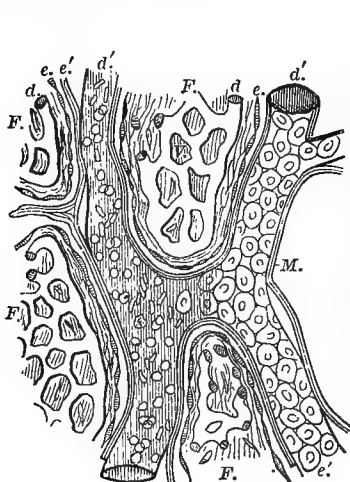

FIG. 100.

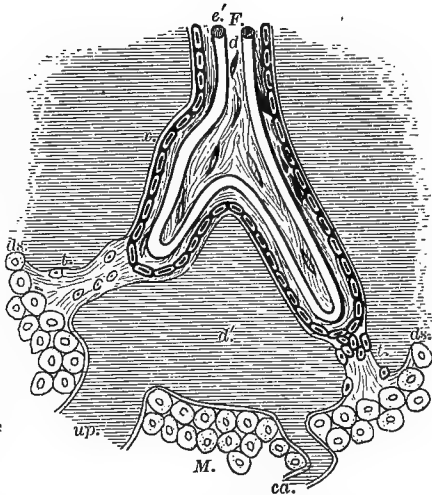

FIG. 101.

FIG. 100.—Placenta of a sloth. Flat maternal epithelial cells shown in position on right side; on left they are removed and dilated; maternal vessel with its blood-corpuscles exposed.

FIG. 101.—Structure of human placenta: *ds*, decidua serotina; *t*, trabeculæ of serotina passing to foetal villi; *ca.*, curling artery; *up.*, utero-placental vein; *x.*, prolongation of maternal tissue on exterior of villus, outside cellular layer *e'*, which may represent either endothelium of maternal blood-vessels or delicate connective tissue of the serotina or both; *e'* maternal cells of the serotina.

In the case of the sloth, with a more discoidal placenta, the dilatation of capillaries and the modification of epithelium are greater.

In the placenta of the apes and of the human subject the most marked departure from simplicity is found. The maternal

vessels are said to constitute large intercommunicating sinuses; the villi may hang freely suspended in these sinuses, or be anchored to their walls by strands of tissue. There is believed to be only one layer of epithelial cells between the vessels of mother and foetus in the later stages of pregnancy. This, while closely investing the foetal vessels (capillaries), really belongs to the maternal structures. The significance of this general arrangement will be explained in the chapter on the physiological aspects of the subject.

It remains to inquire into the relation of these forms to one another from a phylogenetic (derivative) point of view, or to trace the evolution of the placenta.

Evolution.—Passing by the lowest mammals, in which the placental relations are as yet imperfectly understood, it seems clear that the simplest condition is found in the rodentia. Thus, in the rabbit, as has been described, both yelk-sac and allantois take a nutritive part; but the latter remains small. In forms above the rodents, the allantois assumes more and more importance, becomes larger, and sooner or later predominates over the yelk-sac.

The discoidal, zonary, cotyledonary, etc., are plainly evolutions from the diffuse, for both differentiation of structure and integration of parts are evident. The human placenta seems to have arisen from the diffuse form; and it will be remembered that it is at one period represented by the chorion with its villi distributed universally.

The resemblance in the embryonic membranes at any early stage in man and other mammals to those of birds certainly suggests an evolution of some kind, though exactly along what lines that has taken place it is difficult to determine with exactness; however, as before remarked, nearly all the complications of the higher forms arise by concentration and fusion, on the one hand, and atrophy and disappearance of parts once functionally active, on the other.

Summary.—The ovum is a typical cell; unspecialized in most directions, but so specialized as to evolve from itself complicated structures of higher character. The segmentation of the ovum is usually preceded by fertilization, or the union of the nuclei of male and female cells, which is again preceded by the extrusion of polar globules. In the early changes of the ovum, including segmentation, periods of rest and activity alternate. The method of segmentation has relation to the quantity and arrangement of the food-yelk. Ova are divisible generally

into completely segmenting (holoblastic), and those that undergo segmentation of only a part of their substance (meroblastic); but the processes are fundamentally the same.

Provision is made for the nutrition, etc., of the ovum, when fertilized (oö sperm) by the formation of yelk-sac and allantois; as development proceeds, one becomes more prominent than the other. The allantois may fuse with adjacent membranes and form at one part a condensed and hypertrophied chorion (placenta), with corresponding atrophy elsewhere. The arrangement of the placenta varies in different groups of animals so constantly as to furnish a basis for classification. Whatever the variations in the structure of the placenta, it is always highly vascular; its parts consist of villi fitting into crypts in the maternal uterine membrane—both the villi and the crypts being provided with capillaries supported by a connective-tissue matrix covered externally by epithelium. The placenta in its different forms would appear to have been evolved from the diffuse type.

The peculiarities of the embryonic membranes in birds are owing to the presence of a large food-yelk, egg-shell, and egg-membranes; but throughout, vertebrates follow in a common line of development, the differences which separate them into smaller and smaller groups appearing later and later. The same may be said of the animal kingdom as a whole. This seems to point clearly to a common origin with gradual divergence of type.

THE DEVELOPMENT OF THE EMBRYO ITSELF.

We now turn to the development of the body of the animal for which the structures we have been describing exist. It is important, however, to remember that the development of parts, though treated separately for the sake of convenience, really goes on together to a certain extent; that new structures do not appear suddenly but gradually; and that the same law applies to the disappearance of organs which are being superseded by others. To represent this completely would require lengthy descriptions and an unlimited number of cuts; but with the above caution it is hoped the student may be able to avoid erroneous conceptions, and form in his own mind that series of pictures which can not be well furnished in at least the space we have to devote to the subject. But, better than any abstract state-

ments or pictorial representations, would be the examination of a setting of eggs day by day during their development under a

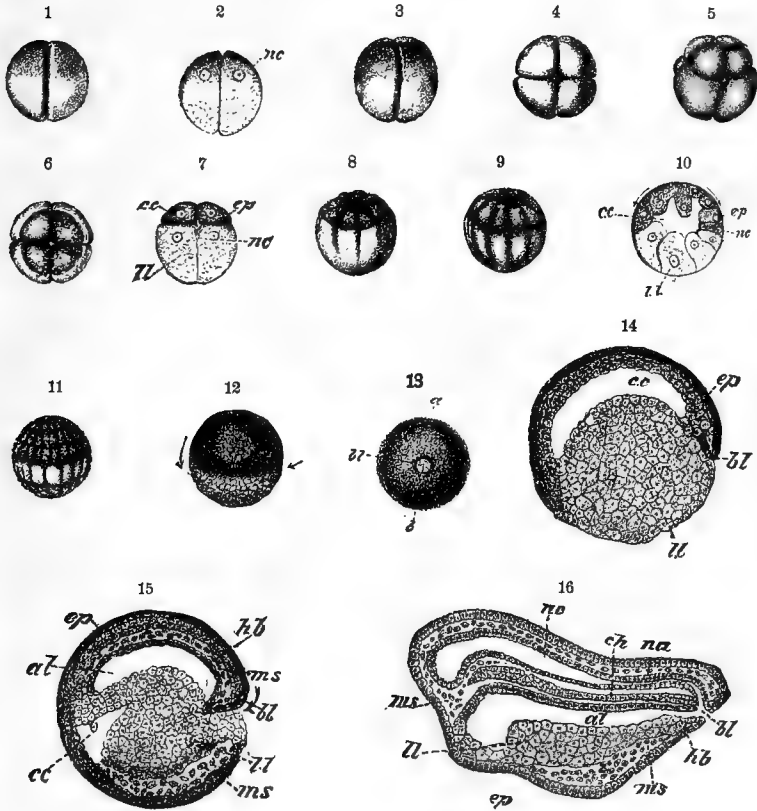

FIG. 102.—Various stages in the development of the frog from the egg (after Howes). 1. The segmenting ovum, showing first cleavage furrow. 2. Section of the above at right angles to the furrow. 3. Same, on appearance of second furrow, viewed slightly from above. 4. The latter seen from beneath. 5. The same, on appearance of first horizontal furrow. 6. The same, seen from above. 7. Longitudinal section of 4. 8 and 9. Two phases in segmentation, on appearance of fourth and fifth furrows. 10. Longitudinal vertical section at a slightly later stage than the above. 11. Later stage. Upper pigmented pole dividing more rapidly than lower. 12. Later phase of 11. 13. Longitudinal vertical section of 12. 14. Segmenting ovum at blastopore stage. 15. Longitudinal vertical section of embryo at a stage later than 14 (1×10). 16. Longitudinal vertical section of embryo at a stage later than 14 (1×10). *nc*, nucleus; *c. c.*, cleavage cavity; *ep*, epiblast; *l. l.*, yolk-bearing lower-layer cells; *bl*, blastopore; *al*, archenteron (mid-gut); *hb*, hypoblast; *ms*, undifferentiated mesoblast; *ch*, notochord; *n. a.*, neural (cerebro-spinal) axis.

hen. This is a very simple matter, and, while the making and mounting of sections from hardened specimens is valuable, it may require more time than the student can spare; but it is neither so valuable nor so easily accomplished as what we have indicated; for, while the lack of sections made by the student

may be made up in part by the exhibition to him of a set of specimens permanently mounted or even by plates, nothing can, in our opinion, take the place of the examination of eggs as we have suggested. It prepares for the study of the development of the mammal, and exhibits the membranes in a simplicity, freshness, and beauty which impart a knowledge that only such direct contact with nature can supply. To proceed with great simplicity and very little apparatus, one requires but a forceps, a glass dish or two, a couple of watch-glasses, or a broad section-lifter (even a case-knife will answer), some water, containing just enough salt to be tasted, rendered lukewarm (blood-heat).

Holding the egg longitudinally, crack it across the center transversely, gently and carefully pick away the shell and its membranes, when the blastoderm may be seen floating upward, as it always does. It should be well examined in position, using a hand lens, though this is not essential to getting a fair knowledge; in fact, if the examination goes no further than the naked-eye appearances of a dozen eggs, selecting one every twenty-four hours during incubation, when opened and the shell and membranes well cleared away, such a knowledge will be supplied as can be obtained from no books or lectures however good. It will be, of course, understood that the student approaches these examinations with some ideas gained from plates and previous reading. The latter will furnish a sort of biological pabulum on which he may feed till he can furnish for himself a more natural and therefore more healthful one. While these remarks apply with a certain degree of force to all the departments of physiology, they are of special importance to aid the constructive faculty in building up correct notions of the successive rapid transformations that occur in the development of a bird or mammal.

Fig. 103 shows the embryo of the bird at a very early period, when already, however, some of the main outlines of structure are marked out. Development in the fowl is so rapid that a few days suffice to outline all the principal organs of the body. In the mammal the process is slower, but in the main takes place in the same fashion.

As the result of long and patient observation, it is now settled that all the parts of the most complicated organism arise from the three-layered blastoderm previously figured; every part may be traced back as arising in one or other of these layers of cells—the epiblast, mesoblast, or hypoblast. It frequently

happens that an organ is made up of cells derived from more than one layer. Structures may, accordingly, be classified as epiblastic, mesoblastic, or hypoblastic; for, when two strata of cells unite in the formation of any part, one is always of subordinate importance to the other: thus the digestive organs are made up of mesoblast as well as hypoblast, but the latter constitutes the essential secreting cell mechanism. As already indicated, the embryonic membranes are also derived from the same source.

The *epiblast* gives rise to the skin and its appendages (hair, nails, feathers, etc.), the whole of the nervous system, and the chief parts of the organs of special sense.

The *mesoblast* originates the skeleton, all forms of connective tissue, including the framework of glands, the muscles, and the epithelial (endothelial) structures covering serous membranes.

The *hypoblast* furnishes the secreting cells of the digestive tract and its appendages—as the liver and pancreas—the lining epithelium of the lungs, and the cells of the secreting mucous membranes of their framework of bronchial tubes.

It is difficult to overrate the importance of these morphological generalizations for the physiologist; for, once the origin of an organ is known, its function and physiological relations generally may be predicted with considerable certainty. We shall endeavor to make this prominent in the future chapters of this work.

Being prepared with these generalizations, we continue our study of the development of the bird's embryo. Before the end

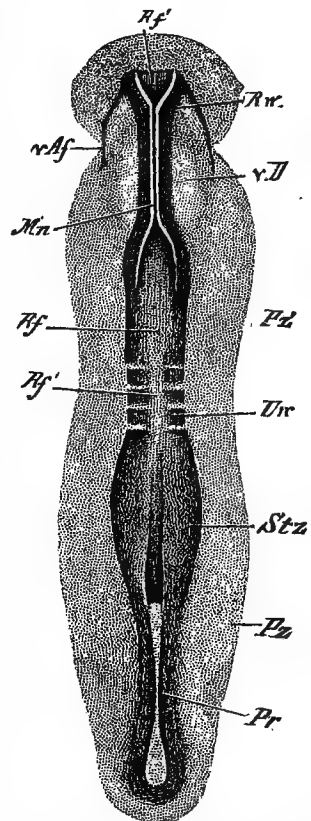

FIG. 103.—Embryo fowl 3 mm. long, of about twenty-four hours, seen from above. 1×39 . (Haddon, after Kölliker.) *Mn*, union of the medullary folds in the region of the hind-brain; *Pr*, primitive streak; *Pz*, parietal zone; *Rf*, posterior portion of widely-open neural groove; *Rf'*, anterior part of neural groove; *Rw*, neural ridge; *Stz*, trunk-zone; *vAf*, anterior amniotic fold; *vD*, anterior umbilical sinus showing through the blastoderm. *His* divides the embryonic rudiment into a central trunk-zone, and a pair of lateral or parietal zones.

of the first twenty-four hours such an appearance as that represented in Fig. 104 is presented.

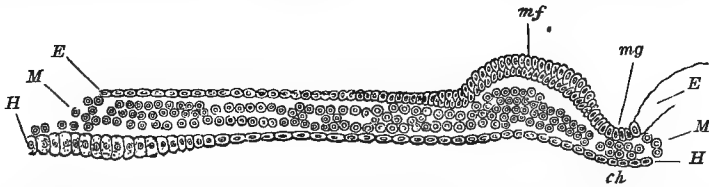

FIG. 104.—Transverse section through the medullary groove and half the blastoderm of a chick of eighteen hours (Foster and Balfour). *E*, epiblast; *M*, mesoblast; *H*, hypoblast; *mf*, medullary fold; *mg*, medullary groove; *ch*, notochord.

The mounds of cells forming the medullary folds are seen coming in contact to form the *medullary (neural) canal*.

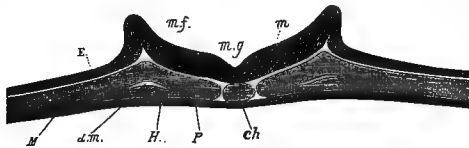

FIG. 105.—Transverse section of embryo chick at end of first day (after Kölliker). *M*, mesoblast; *H*, hypoblast; *m*, medullary plate; *E*, epiblast; *mg*, medullary groove; *mf*, medullary fold; *ch*, chorda dorsalis; *P*, protovertebral plate; *dm*, division of mesoblast.

The *notochord*, marking out the future bony axis of the body, may also be seen during the first day as a well-marked linear extension, just beneath the medullary groove. The cleav-

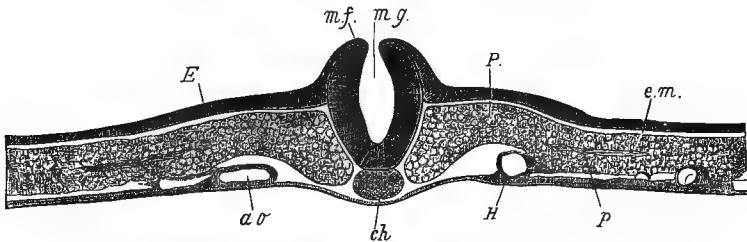

FIG. 106.—Transverse section of chick at end of second day (Kölliker). *E*, epiblast; *H*, hypoblast; *e. m.*, external plate of mesoblast dividing (cleavage of mesoblast); *m. f.*, medullary fold; *m. g.*, medullary groove; *ao*, aorta; *p*, pleuroperitoneal cavity; *P*, protovertebral plate.

age of the mesoblast, resulting in the commencement of the formation of *somatopleure* (body-fold) and the *splanchnopleure* (visceral fold), is also an early and important event. These give rise between them to the *pleuro-peritoneal cavity*. The portions of mesoblast nearest the neural canal form masses (*vertebral plates*) distinct from the thinner outer ones (*lateral plates*).

The vertebral plates, when distinctly marked off, as represented in the figure, are termed the *protovertebræ* (*mesoblastic somites*), and represent the future vertebræ and the voluntary muscles of the trunk; the former arising from the inner subdivisions, and the latter from the outer (*muscle-plates*). It will be understood that the protovertebræ are the results of transverse division of the columns of mesoblast that formed the vertebral plates.

Before the permanent vertebræ are formed, a reunion of the original protovertebræ takes place as one cartilaginous pillar, followed by a new segmentation midway between the original divisions.

It thus appears that a large number of structures either appear or are clearly outlined during the first day of incubation: the primitive streak, primitive groove, medullary plates and groove, the neural canal, the head-fold, the cleavage of the mesoblast, the protovertebræ, with traces of the amnion and area opaca.

During the *second* day nearly all the remaining important structures of the chick are marked out, while those that arose during the first day have progressed. Thus, the medullary folds close; there is an increase in the number of protovertebræ; the formation of a tubular heart and the great blood-vessels; the appearance of the Wolffian duct; the progress of the head region; the appearance of the three cerebral vesicles at the anterior extremity of the neural canal; the subdivision of the first cerebral vesicle into the optic vesicles and the beginnings of the cerebrum; the auditory pit arising in the third cerebral vesicle (hind-brain); cranial flexure commences; both head and tail folds become more distinct; the heart is not only

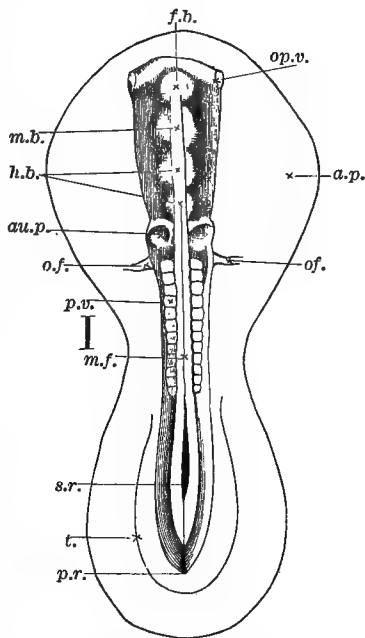

FIG. 107.—Embryo of chick, between thirty and thirty-six hours, viewed from above as an opaque object (Foster and Balfour). *f. b.*, forebrain; *m. b.*, midbrain; *h. b.*, hind-brain; *op. v.*, optic vesicle; *au. p.*, auditory pit; *o. f.*, vitelline vein; *p. v.*, mesoblastic somite; *m. f.*, line of function of medullary folds above medullary canal; *s. r.*, sinus rhomboidalis; *t.*, tail-fold; *p. r.*, remains of primitive groove; *a. p.*, area pellucida.

formed, but its curvature becomes more marked and rudiments of auricles arise; while outside the embryo itself the circulation of the yelk-sac is established, the allantois originates, and the amnion makes rapid progress.

It may be noticed that the cerebral vesicles, the optic vesicles, and the auditory pit are all derived from the epiblastic accumulations which occur in the anterior extremity of the embryo; and their early appearance is prophetic of their physiological importance.

The heart, too, so essential for the nutrition of the embryo, by distributing a constant blood-stream, is early formed, and

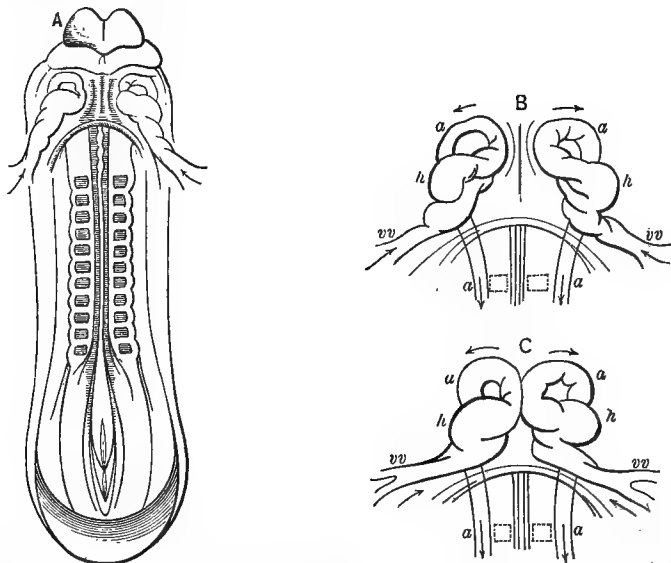

FIG. 108.—Diagram representing under surface of an embryo rabbit of nine days and three hours old, illustrating development of the heart (after Allen Thomson). A, view of the entire embryo; B, an enlarged outline of the heart of A; C, later stage of the development of B; *h h*, ununited heart; *a a*, aortæ; *vv*, vitelline veins.

becomes functionally active. It arises beneath the hind-end of the fore-gut, at the point of divergence of the folds of the splanchnopleure, and so lies within the pleuro-peritoneal cavity, and is derived from the mesoblast. At the beginning the heart consists of two solid columns ununited in front at first; later, these fuse, in part, so that they have been compared with an inverted Y, in which the heart itself would correspond to the lower stem of the letter (λ) and the great veins (vitelline) to its main limbs. The solid cords of mesoblast become hollow prior to their coalescence, when the two tubes become one.

The entire blood-vascular system originates in the mesoblast of the area opaca especially; at first appearing in isolated spots which come together as actual vessels are formed. The student who will pursue the plan of examining a series of incubating eggs will be struck with the early rise and rapid progress of the

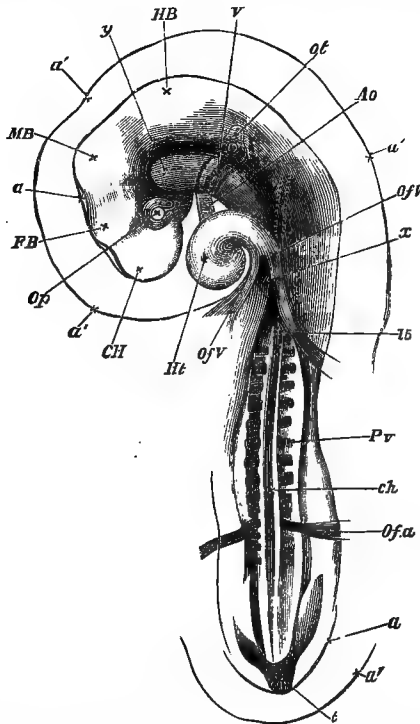

FIG. 109.—Chick on third day, seen from beneath as a transparent object, the head being turned to one side (Foster and Balfour). *a'*, false amnion; *a*, amnion; *CH*, cerebral hemisphere; *FB*, *MB*, *HB*, anterior, middle, and posterior cerebral vesicles; *OP*, optic vesicle; *ot*, auditory vesicle; *ofv*, omphalo-mesenteric veins; *Ht*, heart; *Ao*, bulbus arteriosus; *ch*, notochord; *Ofa*, omphalo-mesenteric arteries; *Fv*, protovertebrae; *x*, point of divergence of the splanchnopleural folds; *y*, termination of the foregut, *v*.

vascular system of the embryo, which takes, when complete, such a form as is represented diagrammatically in Fig. 113.

The blood and the blood-vessels arise simultaneously from the cells of the mesoblast by outgrowths of nuclear proliferation, and in the case of vessels (Fig. 147) extension of processes, fusion, and excavation.

The *fore-gut* is formed by the union of the folds of the splanchnopleure from before backward, and the hind-gut in a similar manner by fusion from behind forward.

The excretory system is also foreshadowed at an early period by the Wolffian duct (Fig. 114), a mass of mesoblast cells near which the cleavage of the mesoblast takes place.

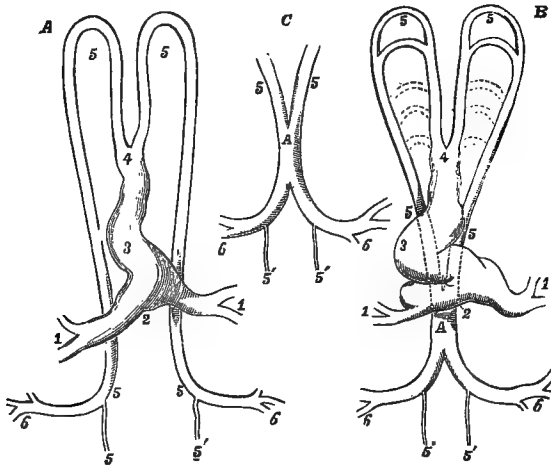

FIG. 110.—Diagram of the heart and principal arteries of the chick (Quain). A represents an earlier, and B and C later stages. 1, 1, omphalo-mesenteric veins; 2, auricle; 3, ventricle; 4, aortic bulb; 5, 5, primitive aortæ; 6, 6, omphalo-mesenteric arteries; A, united aortæ.

During the latter part of the second day the vascular system, including the heart, makes great progress. The latter, in con-

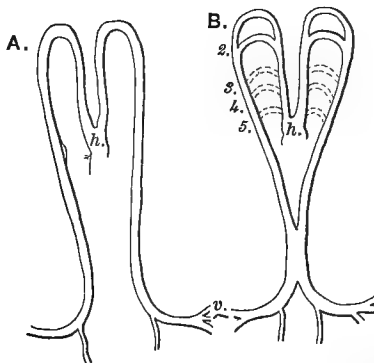

FIG. 111.—Diagrammatic outlines of the early arterial system of the mammal vertebrate embryo (after Allen Thomson). A. At a period corresponding to the thirty-sixth or thirty-eighth hour of incubation. B. Later stage, with two pairs of aortic arches. h, bulbus arteriosus of heart; v, vitelline arteries; 1—5, the aortic arches. The dotted lines indicate the position of the future arches.

sequence of excessive growth and the alteration of the relative position of other parts, becomes bent up on itself, so that it

presents a curve to the right which represents the venous part and one to the left, answering to the arterial. The rudiments of the auricles also are to be seen.

The arterial system is represented at this stage by the expanded portion of the heart known as the *bulbus arteriosus*, and two extensions from it, the aortæ, which uniting above the alimentary canal, form a single posterior or dorsal aorta. From these great arterial vessels the lesser ones arise, and by subdivision constitute that great mesh-work represented diagrammatically in Figs. 112, 113, from which the course of the circulation may be gathered. The beating of the heart commences before the corpuscles have become numerous, and while the tubular system, through which the blood is to be driven, is still very incomplete.

The events of the *third* day are of the nature of the extension of parts already marked out rather than the formation of entirely new ones. The following are the principal changes: The bending of the head-end downward (cranial flexure); the turning of the embryo so that it lies on its left side; the completion of the vitelline circulation; the increase in the curvature of the heart and its complexity of structure by divisions; the appearance of additional aortic arches and of the cardinal veins; the formation of four visceral clefts and five visceral arches; a series of progressive changes in the organs of the special senses, such as the formation of the lens of the eye and a secondary optic vesicle; the closing in of the optic vesicle; and the formation of the nasal pits. In the region of the future brain, the vesicles of the cerebral hemispheres become distinct; the hind-brain separates into cerebellum and medulla oblongata; the nerves, both cra-

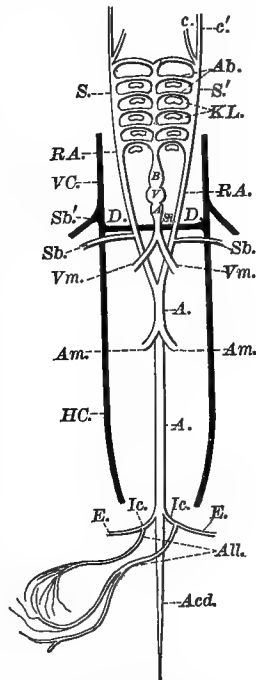

FIG. 112.—Diagram of the embryonic vascular system (Wiedersheim). *a*, atrium; *A. A.*, dorsal aorta; *Ab.*, branchial vesicles; *Acd.*, caudal artery; *All.*, allantoic (hypogastric) arteries; *Am.*, vitelline arteries; *B.*, bulbus arteriosus; *c. c.*, external and internal carotids; *D.*, ductus Cuvieri (precaval veins); *E.*, external iliac arteries; *H. C.*, posterior cardinal vein; *Ic.*, common iliac arteries; *K. L.*, gill clefts; *R. A.*, right and left roots of the aorta; *S. S.*, branchial collecting trunks or veins; *Sb.*, subclavian artery; *Sb.*, subclavian vein; *Sb.*, sinus venosus; *V.*, ventricle; *V. C.*, anterior cardinal vein; *Vm.*, vitelline veins.

niating from the cerebral hemispheres become distinct; the hind-brain separates into cerebellum and medulla oblongata; the nerves, both cra-

nial and spinal, bud out from the nervous centers. The alimentary canal enlarges, a fore-gut and hind-gut being formed, the former being divided into œsophagus, stomach, and duode-

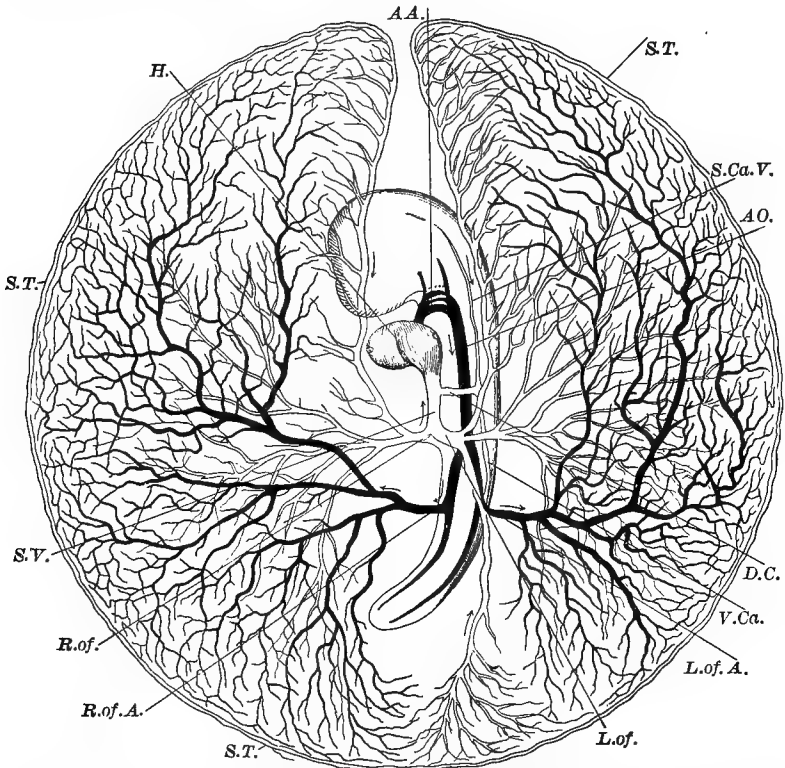

FIG. 113.—Diagram of circulation of yolk-sac at end of third day (Foster and Balfour). Blastoderm seen from below. Arteries made black. *H.*, heart; *A.A.*, second, third, and fourth aortic arches; *A.O.*, dorsal aorta; *L. of. A.*, left vitelline artery; *R. of. A.*, right vitelline artery; *S. T.*, sinus terminalis; *L. of.*, left vitelline vein; *R. of.*, right vitelline vein; *S. V.*, sinus venosus; *D. C.*, ductus Cuvieri; *S. Ca. V.*, superior cardinal or jugular vein; *V. Ca.*, inferior cardinal vein.

num; the latter into the large intestine and the cloaca. The lungs arise from the alimentary canal in front of the stomach; from similar diverticula from the duodenum, the liver and pancreas originate. Changes in the protovertebræ and muscle-plates continue, while the Wolffian bodies are formed and the Wolffian duct modified.

Up to the third day the embryo lies mouth downward, but now it comes to lie on its left side. See Fig. 109 with the accompanying description, it being borne in mind that the view is from below, so that the right in the cut is the left in the em-

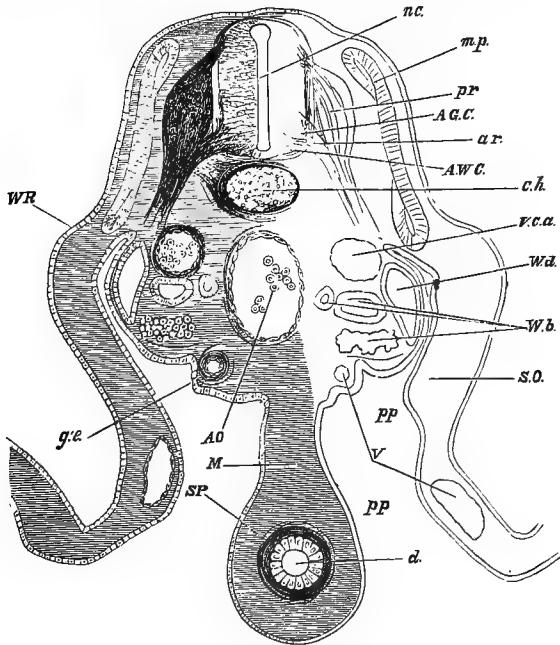

FIG. 114.

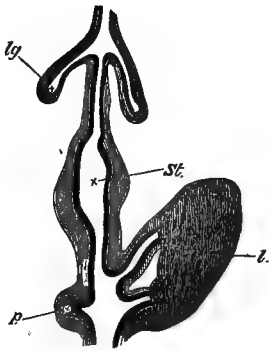

FIG. 115.

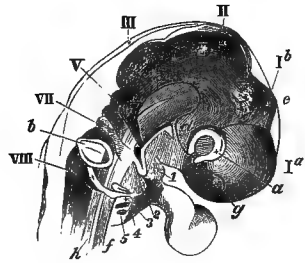

FIG. 116.

- FIG. 114.—Transverse section through lumbar region of an embryo at end of fourth day (Foster and Balfour). *nc*, neural canal; *pr*, posterior root of spinal nerve with ganglion; *ar*, anterior root; *A. G. C.*, anterior gray column of spinal cord; *A. W. C.*, anterior white column in course of formation; *m. p.*, muscle-plate; *ch*, notochord; *W. R.*, Wolffian ridge; *A. O.*, dorsal aorta; *v. c. a.*, posterior cardinal vein; *W. d.*, Wolffian duct; *W. b.*, Wolffian body, consisting of tubules and Malpighian corpuscles; *g. e.*, germinal epithelium; *a.*, alimentary canal; *M*, commencing mesentery; *S. O.*, somatopleure; *S. P.*, splanchnopleure; *V*, blood-vessels; *pp*, pleuroperitoneal cavity.
- FIG. 115.—Diagram of portion of digestive tract of chick on fourth day (after Götte). The black line represents hypoblast; the shaded portion, mesoblast; the unshaded object (Huxley), expanding at bases into primary lung vesicle; *lg*, lung diverticulum; *st*, stomach; *l*, liver; *p*, pancreas.
- FIG. 116.—Head of chick of third day, viewed sidewise as a transparent object (Huxley). *Ia*, cerebral hemispheres; *Ib*, vesicle of third ventricle; *II*, mid-brain; *III*, hind-brain; *a*, optic vesicle; *g*, nasal pit; *b*, otic vesicle; *d*, infundibulum; *e*, pineal body; *h*, notochord; *V*, fifth nerve; *VII*, seventh nerve; *VIII*, united glossopharyngeal and pneumogastric nerves. 1, 2, 3, 4, 5, the five visceral folds.

bryo itself. Fig. 114 gives appearances furnished by a vertical transverse section. The relations of the parts of the digestive tract and the mode of origin of the lungs may be learned from Fig. 115.

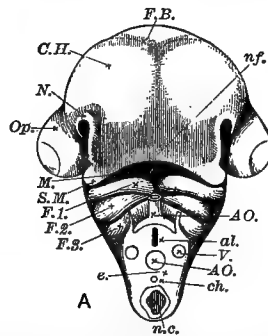

FIG. 117.—Head of chick of fourth day, viewed from below as an opaque object (Foster and Balfour). The neck is cut across between third and fourth visceral folds. *C. H.*, cerebral hemispheres; *F. B.*, vesicle of third ventricle; *Op.*, eyeball; *nf*, naso-frontal process; *n.*, cavity of mouth; *S. m.*, superior maxillary process of *F. 1*, the first visceral fold (mandibular arch); *F. 2*, *F. 3*, second and third visceral arches; *N*, nasal pit.

An examination of the figures and subjoined descriptions must suffice to convey a general notion of the subsequent prog-

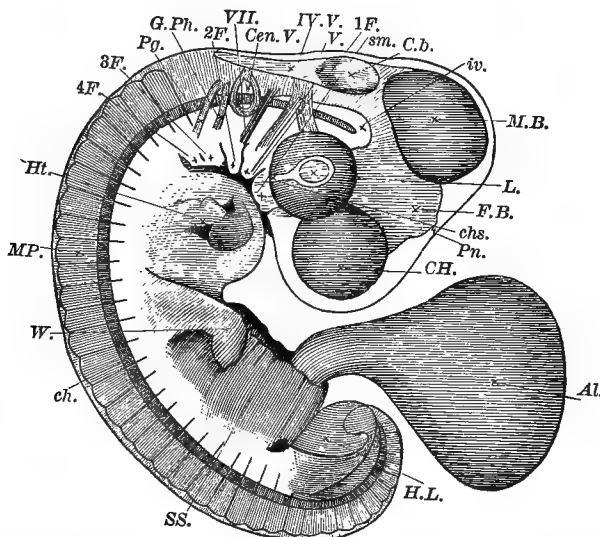

FIG. 118.—Embryo at end of fourth day, seen as a transparent object (Foster and Balfour). *CH.*, cerebral hemisphere; *F. B.*, fore-brain, or vesicle of third ventricle (thalamencephalon), with pineal gland (*Pn*) projecting; *M. B.*, mid-brain; *Cb*, cerebellum; *IV. V.*, fourth ventricle; *L.*, lens; *chs.*, choroid slit; *Cen. V.*, auditory vesicle; *sm.*, superior maxillary process; *1F.*, *2F.*, etc., first, second, etc., visceral folds; *V.*, fifth nerve; *VII.*, seventh nerve; *G. Ph.*, glossopharyngeal nerve; *Pg.*, pneumogastric. The distribution of these nerves is also indicated: *ch.*, notochord; *Ht.*, heart; *MP.*, muscle-plates; *W.*, wing; *H. L.*, hind-limb. The amnion has been removed. *Al.*, allantois protruding from cut end of somatic stalk *SS.*

ress of the embryo. Special points will be considered, either in a separate chapter now, or deferred for treatment in the body of the work from time to time, as they seem to throw light upon the subjects under discussion.

DEVELOPMENT OF THE VASCULAR SYSTEM IN VERTEBRATES.

This subject has been incidentally considered, but it is of such importance morphological, physiological, and pathological, as to deserve special treatment.

In the earliest stages of the circulation of a vertebrate the arterial system is made up of a pair of arteries derived from the single *bulbus arteriosus* of the heart, which, after passing forward, bends round to the dorsal side of the pharynx, each giving off at right angles to the yolk-sac a *vitelline* artery; the aortæ unite dorsally, then again separate and become lost in the posterior end of the embryo. The so-called arches of the aorta are large branches in the anterior end of the embryo derived from the aorta itself.

The venous system corresponding to the above is composed of anterior and posterior pairs of longitudinal (cardinal) veins, the former (jugular, cardinal) uniting with the posterior to form a common trunk (*ductus Cuvieri*) by which the venous blood is returned to the heart. The blood from the posterior part of the yolk-sac is collected by the *vitelline* veins, which terminate in the median *sinus venosus*.

The Later Stages of the Fœtal Circulation.—Corresponding to the number of visceral arches five pairs of aortic arches arise; but they do not exist together, the first two having undergone more or less complete atrophy before the others appear. Figs. 119, 120 convey an idea of how the permanent forms (indicated by darker shading) stand related to the entire system of vessels in different groups of animals. Thus, in birds the right (fourth) aortic arch only remains in connection with the aorta, the left forming the subclavian artery, while the reverse occurs in mammals. The fifth arch (pulmonary) always supplies the lungs.

The arrangement of the principal vessels in the bird, mammal, etc., is represented on page 104. In mammals the two primitive anterior abdominal (*allantoic*) veins develop early and unite in front with the vitelline; but the right allantoic vein and the right vitelline veins soon disappear, while the long

common trunk of the allantoic and vitelline veins (*ductus venosus*) passes through the liver, where it is said the ductus veno-

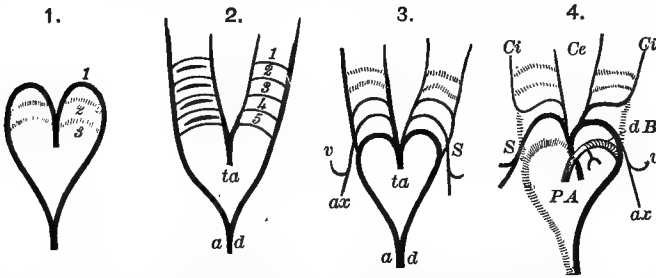

FIG. 119.—Diagrams of the aortic arches of mammal (Landois and Stirling, after Rathke). 1. Arterial trunk with one pair of arches, and an indication where the second and third pairs will develop. 2. Ideal stage of five complete arches; the fourth clefts are shown on the left side. 3. The two anterior pairs of arches have disappeared. 4. Transition to the final stage. *A*, aortic arch; *ad*, dorsal aorta; *ax*, subclavian or axillary artery; *Ce*, external carotid; *Ci*, internal carotid; *dB*, ductus arteriosus Botalli; *P*, pulmonary artery; *S*, subclavian artery; *ta*, truncus arteriosum; *v*, vertebral artery.

sus gives off and receives branches. The ductus venosus Arantii persists throughout life. (Compare the various figures illustrating the circulation.)

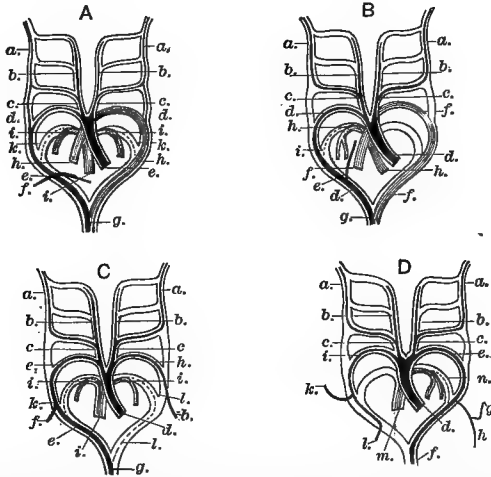

FIG. 120.—Diagram illustrating transformations of aortic arches in a lizard, A; a snake, B; a bird, C; a mammal, D. Seen from below. (Haddon, after Rathke.) *a*, internal carotid; *b*, external carotid; *c*, common carotid. *A*. *d*, ductus Botalli between the third and fourth arches; *e*, right aortic arch; *f*, subclavian; *g*, dorsal aorta; *h*, left aortic arch; *i*, pulmonary artery; *k*, rudiment of the ductus Botalli between the pulmonary artery and the aortic arches. *B*. *d*, right aortic arch; *e*, vertebral artery; *f*, left aortic arch; *h*, pulmonary artery; *i*, ductus Botalli of the latter. *C*. *d*, origin of aorta; *e*, fourth arch of the right side (root of dorsal aorta); *f*, right subclavian; *g*, dorsal aorta; *h*, left subclavian (fourth arch of the left side); *i*, pulmonary artery; *k* and *l*, right and left ductus Botalli of the pulmonary arteries. *D*. *d*, origin of aorta; *e*, fourth arch of the left side (root of dorsal aorta); *f*, dorsal aorta; *g*, left vertebral artery; *h*, left subclavian; *i*, right subclavian (fourth arch of the right side); *k*, right vertebral artery; *l*, continuation of the right subclavian; *m*, pulmonary artery; *n*, ductus Botalli of the latter (usually termed *ductus arteriosus*).

With the development of the placenta the allantoic circulation renders the vitelline-subordinate, the vitelline and the larger mesenteric vein forming the portal. The portal vein at a later period joins one of the *venæ advehentes* of the allantoic vein.

At first the vena cava inferior and the ductus venosus enter the heart as a common trunk. The ductus venosus Arantii becomes a small branch of the vena cava.

The allantoic vein is finally represented in its degenerated form as a solid cord (*round ligament*), the entire venous supply of the liver being derived from the portal vein.

The development of the heart has already been traced in the fowl up to a certain point. In the mammal its origin and early progress are similar, and its further history may be gathered from the following series of representations.

In the fowl the heart shows the commencement of a division into a right and left half on the third day, and about the fourth week in man, from which fact alone some idea may be gained as to the relative rate of development. The division

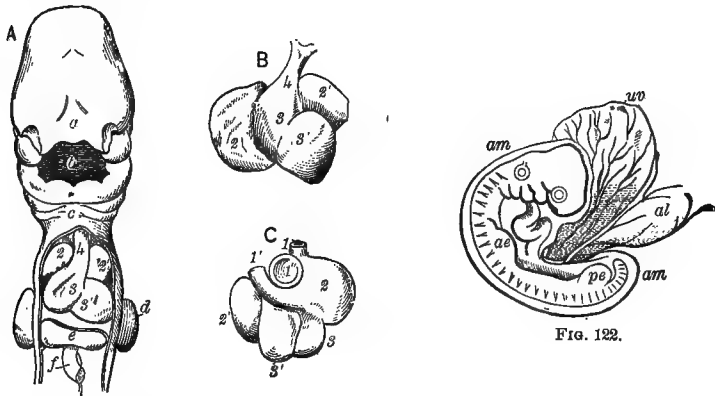

FIG. 121.

FIG. 121.—Development of the heart in the human embryo, from the fourth to the sixth week. A. Embryo of four weeks (Kölliker, after Coste). B, anterior, C, posterior views of the heart of an embryo of six weeks (Kölliker, after Ecker). *a*, upper limit of buccal cavity; *c*, buccal cavity; *b*, lies between the ventral ends of second and third branchial arches; *d*, buds of upper limbs; *l*, liver; *f*, intestine; 1, superior vena cava; 1', left superior vena cava; 1'', opening of inferior vena cava; 2, 2', right and left auricles; 3, 3', right and left ventricles; 4, aortic bulb.

FIG. 122.—Human embryo of about three weeks (Allen Thomson). *w*, yolk-sac; *al*, allantois; *am*, amnion; *ae*, anterior extremity; *pe*, posterior extremity.

is effected by the outgrowth of a septum from the ventral wall, which rapidly reaches the dorsal side, when the double ventricle thus formed communicates by a right and left auriculo-ventricular opening with the large and as yet undivided auricle.

Later an incomplete septum forms similar divisions in the auricle; the aperture (*foramen ovale*) left by the imperfect growth of this wall persisting throughout foetal life.

The Eustachian valve arises on the dorsal wall of the right auricle, between the vena cava inferior and the right and left venæ cavæ superiores; but in many mammals, among which is man, the left vena cava superior disappears during foetal life.

For the present we may simply say that the histories of the development of the heart, the blood-vessels, and the blood itself are closely related to each other, and to the nature and changes of the various methods in which oxygen is supplied to the blood and tissues, or, in other words, to the development of the respiratory system:

THE DEVELOPMENT OF THE UROGENITAL SYSTEM.

Without knowing the history of the organs, the anatomical relations of parts with uses so unlike as reproduction on the one hand and excretion on the other, can not be comprehended; nor, as will be shortly made clear, the fact that the same part may serve at one time to remove waste matters (urine) and at another the generative elements.

The vertebrate excretory system may be divided into three parts, which result from the differentiation of the primitive kidney which has been effected during the slow and gradual evolution of vertebrate forms:

1. The head-kidney (*pronephros*).
2. The Wolffian body (*mesonephros*).
3. The kidney proper, or *metanephros*.

But in this instance, as in others, to some of which allusion has already been made, these three parts are not functional at the same time. The pronephros arises from the anterior part of the segmental duct, pronephric duct, duct of primitive kidney, and archinephric duct, and in the fowl is apparent on the third day; but the pronephros is best developed in the ichthyopsida (fishes and amphibians). A vascular process from the peritoneum (*glomerulus*) projects into a dilated section of the body cavity, which is in part separated from the rest of this cavity (*cœlom*). This process, together with the segmental duct, now coiled, and certain short tubes developed from the original duct, make up the pronephros. The segmental duct opens at length into the cloaca.

The *mesonephros* (Wolffian body), though largely developed in all vertebrates during foetal life, is not a persistent excretory organ of adult life.

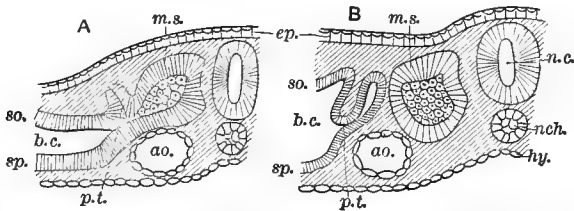

FIG. 123.—Diagrams illustrating development of pronephros in the fowl (Haddon). *ao*, aorta; *b. c.*, body-cavity; *ep.*, epiblast with its epitrichial (flattened) layer; *hy.*, hypoblast; *m. s.*, mesoblastic somite; *n. c.*, neural canal; *n.ch.*, notochord; *p. l.*, pronephric tubule; *so.*, somatic; and *sp.*, splanchnic, mesoblast.

In the fowl recent investigation has shown that the Wolffian (segmental) tubes originate from outgrowths of the Wolffian

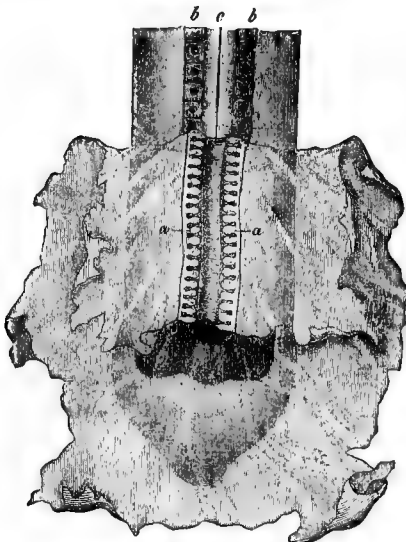

FIG. 124.

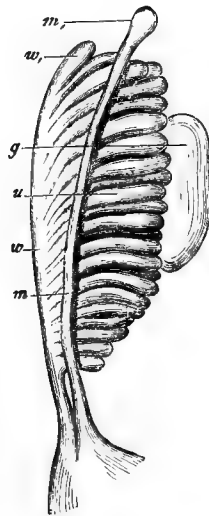

FIG. 125.

FIG. 124.—Rudimentary primitive kidney of embryonic dog. The posterior portion of the body of the embryo is seen from the ventral side, covered by the intestinal layer of the yolk-sac, which has been torn away, and thrown back in front in order to show the primitive kidney ducts with the primitive kidney tubes (*a*). *b*, primitive vertebræ; *c*, dorsal medulla; *d*, passage into the pelvic intestinal cavity. (Haeckel, after Bischoff.)

FIG. 125.—Primitive kidney of a human embryo. *u*, the urine-tubes of the primitive kidney; *w*, Wolffian duct; *w'*, upper end of the latter (Morgagni's hydatid); *m*, Müllerian duct; *m'*, upper end of the latter (Fallopian hydatid); *g*, hermaphrodite gland. (After Kobelt.)

duct and also from an intermediate cell-mass, from which latter the Malpighian bodies take rise. The tubes, at first not con-

nected with the duct, finally join it. This organ is continuous with the pronephros; in fact, all three (pronephros, mesonephros, and metanephros) may be regarded as largely continuations one of another.

The *metanephros*, or kidney proper, arises from mesoblast at the posterior part of the Wolffian body. The ureter origi-

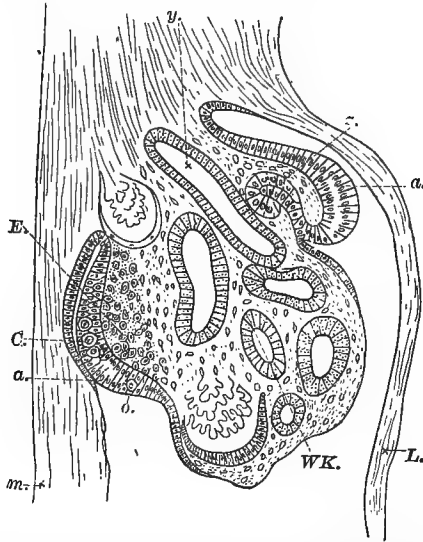

FIG. 126.—Section of the intermediate cell-mass of fourth day (Foster and Balfour, after Waldeyer). 1×160 . *m*, mesentery; *L*, somatopleure; *a'*, portion of the germinal epithelium from the duct of Müller is formed by involution; *a*, thickened portion of the germinal epithelium, in which the primitive ova *C* and *o* are lying; *E*, modified mesoblast which will form the stroma of the ovary; *WK*, Wolffian body; *y*, Wolffian duct.

nates first from the hinder portion of the Wolffian duct. In the fowl the kidney tubules bud out from the ureter as rounded elevations. The ureter loses its connection with the Wolffian duct and opens independently into the cloaca.

The following account will apply especially to the higher vertebrates:

The segmental (archinephric) duct is divided horizontally into a dorsal or Wolffian (mesonephric) duct and a ventral or Müllerian duct. The Wolffian duct, as we have seen, develops into both ureter and kidney proper.

To carry the subject somewhat further back, the epithelium lining the cœlom at one region becomes differentiated into columns or cells (*germinal epithelium*) which by involution into the underlying mesoblast forms a tubule extending from before backward and in close relation with the Wolffian duct, thus

forming the Müllerian duct by the process of cleavage and separation referred to on preceding page.

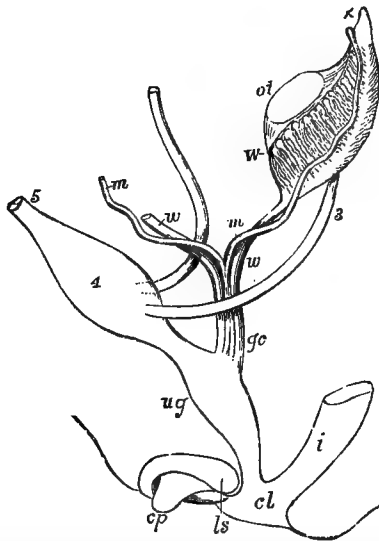

FIG. 127.—Diagrammatic representation of the genital organs of a human embryo previous to sexual distinction (Allen Thomson). *W*, Wolffian body; *gc*, genital cord; *m*, Müllerian duct; *W*, Wolffian duct; *ug*, urogenital sinus; *cp*, clitoris or penis; *i*, intestine; *cl*, cloaca; *ls*, part from which the scrotum or labia majora are developed; *ot*, origin of the ovary or testicle respectively; *x*, part of the Wolffian body developed later into the coni vasculosi; 3, ureter; 4, bladder; 5, urachus.

The future of the Müllerian and Wolffian ducts varies according to the sex of the embryo.

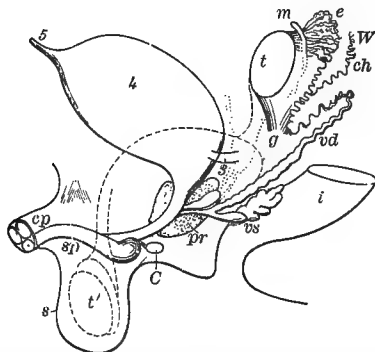

FIG. 128.—Diagram of the mammalian type of male sexual organs (after Quain). Compare with Figs. 127, 129. *C*, Cowper's gland of one side; *cp*, corpora cavernosa penis, cut short; *e*, caput epididymis; *g*, gubernaculum; *i*, rectum; *m*, hydatid of Morgagni, the persistent anterior end of the Müllerian duct, the conjoint posterior ends of which form the uterus masculinus; *pr*, prostate gland; *s*, scrotum; *sp*, corpus spongiosum urethrae; *t*, testis (testicle) in the place of its original formation. The dotted line indicates the direction in which the testis and epididymis change place in their descent from the abdomen into the scrotum; *vd*, vas deferens; *va*, vas aberrans; *vs*, vesicula seminalis; *W*, remnants of Wolffian body (the organ of Giralde's or paradidymis of Waldeyer); 3, 4, 5, as in Fig. 129.

In the male the Wolffian duct persists as the vas deferens; in the female it remains as a rudiment in the region near the ovary (hydatid of Morgagni). In the female the Müllerian duct becomes the oviduct and related parts (uterus and vagina); in the male it atrophies. One, usually the right, also atrophies in female birds. The sinus pocularis of the prostate is the remnant in the male of the fused tubes.

The various forms of the generative apparatus derived from the Müllerian ducts, as determined by different degrees of fusion, etc., of parts, may be learned from the accompanying figures.

In both sexes the most posterior portion of the Wolffian duct gives rise to the *metanephros*, or what becomes the perma-

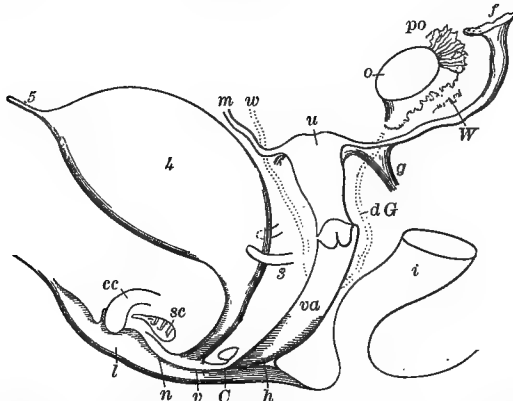

FIG. 129.—Diagram of the mammalian type of female sexual organs (after Quain). The dotted lines in one figure indicate functional organs in the other. *C*, gland of Bartholin (Cowper's gland); *c.c.*, corpus cavernosum clitoridis; *dG*, remains of the left Wolffian duct, which may persist as the duct of Gaertner; *f*, abdominal opening of left Fallopian tube; *g*, round ligament (corresponding to the gubernaculum); *h*, hymen; *i*, rectum; *l*, labium; *m*, cut Fallopian tube (oviduct, or Müllerian duct) of the right side; *n*, nympha; *o*, left ovary; *po*, parovarium; *sc*, vascular bulb or corpus spongiosum; *u*, uterus; *v*, vulva; *va*, vagina; *W*, scattered remains of Wolffian tubes (paroöphoron); *w*, cut end of vanished right Wolffian duct; *3*, ureter; *4*, bladder passing below into the urethra; *5*, urachus, or remnant of stalk of allantois.

nent kidney and ureter; in the male also to the vas deferens, testicle, vas aberrans, and seminal vesicle.

The ovary has a similar origin to the testicle; the germinal epithelium furnishing the cells, which are transformed into Graafian follicles, ova, etc., and the mesoblast the stroma in which these structures are imbedded.

In the female the parovarium remains as the representative of the atrophied Wolffian body and duct.

The bladder and urachus are both remnants of the formerly extensive allantois. The final forms of the genito-urinary or-

gans arise by differentiation, fusion, and atrophy: thus, the cloaca or common cavity of the genito-urinary ducts is divided by a septum (the perineum externally) into a genito-urinary and an intestinal (anal) part; the penis in the male and the corresponding clitoris in the female appear in the region of the cloaca, as outgrowths which are followed by extension of folds of integument that become the scrotum in the one sex and the labia in the other.

The urethra arises as a groove in the under surface of the penis, which becomes a canal. The original opening of the urethra was at the base of the penis.

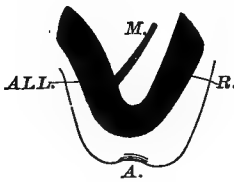

FIG. 130.

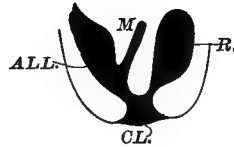

FIG. 131.

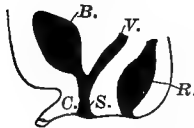

FIG. 132.

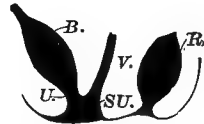

FIG. 133.

FIGS. 130 TO 133.—Diagrams illustrating the evolution of the posterior passages (after Landois and Stirling).

FIG. 130.—Allantois continuous with rectum.

FIG. 131.—Cloaca formed.

FIG. 132.—Early condition in male, before the closure of the folds of the groove on the posterior side of the penis.

FIG. 133.—Early female condition.

A, commencement of proctodæum; ALL, allantois; B, bladder; C, penis; CL, cloaca; M, Müllerian duct; R, rectum; U, urethra; S, vestibule; SU, urogenital sinus; V, vas deferens in Fig. 132, vagina in Fig. 133.

In certain cases development of these parts is arrested at various stages, from which result abnormalities frequently requiring interference by the surgeon.

The accounts of the previous chapters do not complete the history of development. Certain of the remaining subjects that are of special interest, from a physiological point of view, will be referred to again; and in the mean time we shall consider rather briefly some of the physiological problems of this subject to which scant reference has as yet been made. Though the physiology of reproduction is introduced here, so that ties of natural connection may not be severed, it may very well be omitted by the student who is dealing with embry-

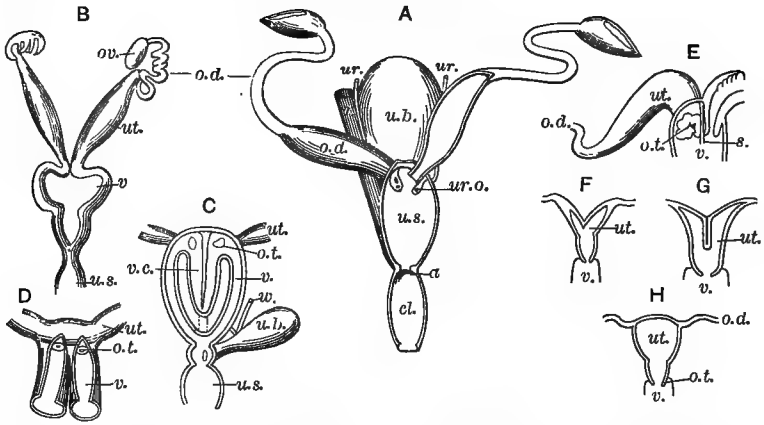

FIG. 194.—Various forms of mammalian uteri. A. *Ornithorhynchus*. B. *Didelphys dorsigera*. C. *Phalangista vulpina*. D. Double uterus and vagina; human anomaly. E. *Lepus cuniculus* (rabbit), uterus duplex. F. Uterus bicornis. G. Uterus bipartitus. H. Uterus simplex (human). a, anus; cl, cloaca; o. d., oviduct; o. t., os tincæ (os uteri); ov, ovary; r, rectum; s, vaginal septum; u. b., urinary bladder; ur, ureter; ur. o., orifice of same; u.s., urogenital sinus; ut, uterus; v, vagina; v. c., vaginal cæcum (Haddon).

ology for the first time, and in any case should be read again after the other functions of the body have been studied.

THE PHYSIOLOGICAL ASPECTS OF DEVELOPMENT.

According to that law of rhythm which, as we have seen, prevails throughout the world of animated nature, there are periods of growth and progress, of quietude and arrest of development; and in vertebrates one of the most pronounced epochs—in fact, the most marked of all—is that by which the young organism, through a series of rapid stages, attains to sexual maturity.

While the growth and development of the generative organs share to the greatest degree in this progress, other parts of the body and the entire being participate.

So great is the change that it is common to indicate, in the case of the human subject, the developed organism by a new name—the “boy” becomes the “man,” the “girl” the “woman.” Relatively this is by far the most rapid and general of all the transformations the organism undergoes during its extra-uterine life. In this the entire body takes part, but very unequally. The increase in stature is not proportionate to the increase in weight, and the latter is not so great as the change in form. The modifications of the organism are localized and yet affect the whole being. The outlines become more rounded; the pel-

vis in females alters in shape; not only do the generative organs themselves rapidly undergo increased development, but certain related glands (mammaræ) participate; hair appears in certain regions of the body; the larynx, especially in the male, undergoes enlargement and changes in the relative size of parts, resulting in an alteration of voice (breaking of the voice), etc.—all in conformity with that excess of nutritive energy which marks this biological epoch.

Correlated with these physical changes are others belonging to the intellectual and moral (psychic) nature equally important, and, accordingly, the future being depends largely on the full and unwarped developments of these few years.

Sexual maturity, or the capacity to furnish ripe sexual elements (cells), is from the biological standpoint the most important result of the onset of that period termed, as regards the human species, puberty.

The age at which this epoch is reached varies with race, sex, climate, and the moral influences which envelop the individual. In temperate regions and with European races puberty is reached at from about the thirteenth to the eighteenth year in the female, and rather later in the male, in whom development generally is somewhat slower.

MENSTRUATION AND OVULATION.

In all vertebrates, at periods recurring with great regularity, the generative organs of the female manifest unusual activity. This is characterized by increased vascularity of the ovary and adjacent parts; with other changes dependent on this, and that heightened nerve influence which, in the vertebrate, seems to be inseparable from all important functional changes. Ovulation is the maturation and discharge of ova from the Graafian follicles. The latter, reaching the exterior zone of the ovary, becoming distended and thinned, burst externally and thus free the ovum. The follicles being very vascular at this period, blood escapes, owing to this rupture, into the emptied capsule and clots; and as a result of organization and subsequent degeneration undergoes a certain series of changes dependent on the condition of the ovary and adjacent parts, which varies according as the ovum has been fertilized or not. When fertilization occurs the Graafian follicle undergoes changes of a more marked and lasting character, becoming a *true corpus luteum of pregnancy*.

The ovum in the fowl is fertilized in the upper part of the oviduct; in the mammal mostly in this region also, as is shown by the site of the embryos in those groups of animals with a two-horned uterus, and the occasional occurrence of tubal pregnancy in woman. But this is not, in the human subject at least, invariably the site of impregnation. After the ovum has been set free, as above described, it is conveyed into the oviduct (Fallopian tube), though exactly how is still a matter of dispute: some holding that the current produced by the action of the ciliated cells of the Fallopian tube suffices; others that the ovum is grasped by the fimbriated extremity of the tube as part of a co-ordinated act. It is likely, as in so many other instances, that both views are correct but partial; that is to say, both these methods are employed. The columnar ciliated cells, lining the oviduct, act so as to produce a current in the direction of the uterus, thus assisting the ovum in its passage toward its final resting place.

Menstruation.—As a part of the general activity occurring at this time, the uterus manifests certain changes, chiefly in its internal mucous lining, in which thickening and increased



FIG. 135.—Diagram of the human uterus just before menstruation. The shaded portion represents the mucous membrane (Hart and Barbour, after J. Williams).



FIG. 136.—Uterus after menstruation has just ceased. The cavity of the body of the uterus is supposed to have been deprived of mucous membrane (J. Williams).

vascularity are prominent. A flow of blood from the uterus in the form of a gentle oozing follows; and as the superficial

parts of the mucous lining of the uterus undergo softening and fatty degeneration, they are thrown off and renewed at these periods (*catamenia, menses, etc.*), provided pregnancy does not take place. In mammals below man, in their natural state, pregnancy does almost invariably take place at such times, hence this exalted activity of the mucous coat of the uterus, in preparation for the reception and nutrition of the ovum, is not often in vain. In the human subject the menses appear monthly; pregnancy may or may not occur, and consequently there may be waste of nature's forces; though there is a certain amount of evidence that menstruation does not wholly represent a loss; but that it is largely of that character among a certain class of women is only too evident. As can be readily understood, the catamenial flow may take place prior to, during, or after the rupture of the egg-capsule.

As the uterus is well supplied with glands, during this period of increased functional activity of its lining membrane, mucus in considerable excess over the usual quantity is discharged; and this phase of activity is continued should pregnancy occur.

All the parts of the generative organs are supplied with muscular tissue, and with nerves as well as blood-vessels, so that it is possible to understand how, by the influence of nerve-centers, the various events of ovulation, menstruation, and those that follow when pregnancy takes place, form a related series, very regular in their succession, though little prominent in the consciousness of the individual animal when normal.

THE NUTRITION OF THE OVUM (OÖSPERM).

This will be best understood if it be remembered that the ovum is a cell, undifferentiated in most directions, and thus a sort of amoeboid organism. In the fowl it is known that the cells of the primitive germ devour, amoeba-like, the yelk-cells, while in the mammalian oviduct the ovum is surrounded by abundance of proteid, which is doubtless utilized in a somewhat similar fashion, as also in the uterus itself, until the embryonic membranes have formed. To speak of the ovum being nourished by diffusion, and especially by osmosis, is an unnecessary assumption, and, as we believe, at variance with fundamental principles; for we doubt much whether any vital process is one of pure osmosis. As soon as the yelk-sac and allantois have been formed, nutriment is derived in great part through

the vessel-walls, which, it will be remembered, are differentiated from the cells of the mesoblast, and, it may well be assumed, have not at this early stage entirely lost their amœboid character. The blood-vessels certainly have a respiratory function, and suffice, till the more complicated villi are formed. The latter structures are in the main similar in build to the villi of the alimentary tract, and are adapted to being surrounded by similar structures of maternal origin. Both the maternal crypts and the foetal villi are, though complementary in shape, all but identical in minute structure in most instances. In each case the blood-vessels are covered superficially by cells which we can not help thinking are essential in nutrition. The villi are both nutritive and respiratory. It is no more difficult to understand their function than that of the cells of the endoderm of a polyp, or the epithelial coverings of lungs or gills.

Experiment proves that there is a respiratory interchange of gases between the maternal and foetal blood which nowhere mingle physically. The same law holds in the respiration of the foetus as in the mammals. Oxygen passes to the region where there is least of it, and likewise carbonic anhydride. If the mother be asphyxiated so is the foetus, and indeed more rapidly than if its own umbilical vessels be tied, for the maternal blood in the first instance abstracts the oxygen from that of the foetus when the tension of this gas becomes lower in the maternal than in the foetal blood; the usual course of affairs is reversed, and the mother satisfies the oxygen hunger of her own blood and tissues by withdrawing that which she recently supplied to the foetus. It will be seen, then, that the embryo is from the first a parasite. This explains that exhaustion which pregnancy, and especially a series of gestations, entails. True, nature usually for the time meets the demand by an excess of nutritive energy: hence many persons are never so vigorous in appearance as when in this condition; often, however, to be followed by corresponding emaciation and senescence. The full and frequent respirations, the bounding pulse, are succeeded by reverse conditions; action and reaction are alike present in the animate and inanimate worlds. Moreover, it falls to the parent to eliminate not only the waste of its own organism but that of the foetus; and not infrequently in the human subject the overwrought excretory organs, especially the kidneys, fail, entailing disastrous consequences.

The digestive functions of the embryo are naturally inact-

ive, the blood being supplied with all its needful constituents through the placenta by a much shorter process; indeed, the placental nutritive functions, so far as the foetus is concerned, may be compared with the removal of already digested material from the alimentary canal, though of course only in a general way. During foetal life the digestive glands are developing, and at the time of birth all the digestive juices are secreted in an efficient condition, though only relatively so, necessitating a special liquid food (milk) in a form in which all the constituents of a normal diet are provided, easy of digestion.



FIG. 137.—Human germs or embryos from the second to the fifteenth week (natural size), seen from the left side, the arched back turned toward the right. (Principally after Ecker.) II, human embryo of 14 days; III, of 3 weeks; IV, of 4 weeks; V, of 5 weeks; VI, of 6 weeks; VII, of 7 weeks; VIII, of 8 weeks; XII, of 12 weeks; XV, of 15 weeks.

Bile, inspissated and mixed with the dead and cast-off epithelium of the alimentary tract, is abundant in the intestine at birth in the human subject; but bile is to be regarded perhaps rather in the light of an excretion than as a digestive fluid. The skin and kidneys, though not functionless, are rendered unnecessary in great part by the fact that waste can be and is withdrawn by the placenta, which proves to be a nutritive, re-

spiratory, and excretory organ; it is in itself a sort of abstract and brief chronicle of the whole physiological story in foetal life.

All of the foetal organs, especially the muscles, abound in an animal starch (glycogen), which in some way, not well understood, forms a reserve fund of nutritive energy which is pretty well used up in the earlier months of pregnancy. We may suppose that the amœboid cells—all the undifferentiated cells of the body—feed on it in primitive fashion; and it will not be forgotten that the older the cells become, the more do they depart from the simpler habits of their earlier, cruder existence; hence the disappearance of this substance in the later months of foetal life.

In one respect the foetus closely resembles the adult: it draws the pabulum for all its various tissues from blood which itself may be regarded as the first completed tissue. We are, accordingly, led to inquire how this river of life is distributed; in a word, into the nature of the foetal circulation.

Foetal Circulation.—The blood leaves the placenta by the umbilical vein, reaches the inferior vena cava, either directly (by the *ductus venosus*), or, after first passing to the liver (by the *venæ advehentes*, and returning by the *venæ revehentes*), and proceeds, mingled with the blood returning from the lower extremities, to the right auricle. This blood, though far from being as arterial in character as the blood after birth, is the best that reaches the heart or any part of the organism. After arriving at the right auricle, being dammed back by the Eustachian valve, it avoids the right ventricle, and shoots on into the left auricle, passing thence into the left ventricle, from which it is sent into the aorta, and is then carried by the great trunks of this arch to the head and upper extremities. The blood returning from these parts passes into the right auricle, then to the corresponding ventricle and thence into the pulmonary artery; but, finding the branches of this vessel unopened, it takes the line of least resistance through the *ductus arteriosus* into the aortic arch beyond the point where its great branches emerge. It will be seen that the blood going to the head and upper parts of the body is greatly more valuable as nutritive pabulum than the rest, especially in the quantity of oxygen it contains; that the blood of the foetus, at best, is relatively ill-supplied with this vital essential; and as a result we find the upper (anterior in quadrupeds) parts of the foetus best developed, and a decided resemblance between the mammalian foetus functionally and the adult forms of reptiles and kindred

groups of the lower vertebrates. But this condition is well enough adapted to the general ends to be attained at this pe-

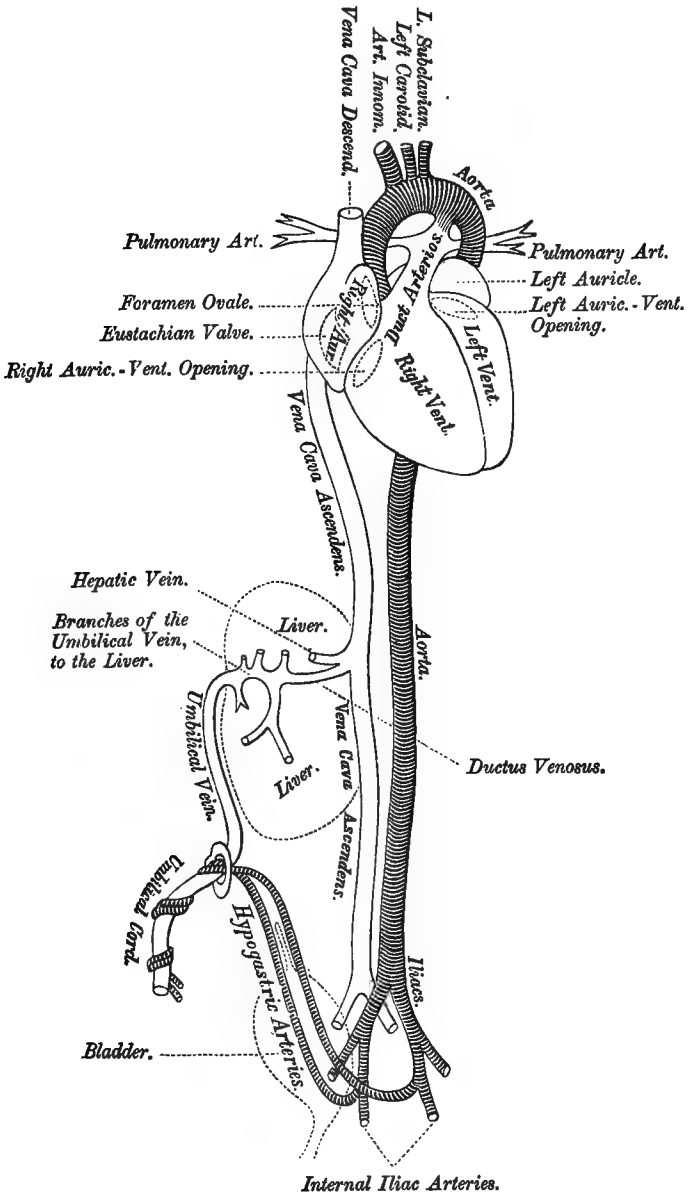

FIG. 188.—Diagram of the fetal circulation (Flint).

riod—the nourishment of structures on the way to a higher path of progress.

As embryonic maturity is being reached, preparation is made for a new form of existence; so it is found that the Eustachian valve is less prominent and the foramen ovale smaller.

PARTURITION.

All the efforts that have hitherto been made to determine the exact cause of the result of that series of events which make up parturition have failed. This has probably been owing to an attempt at too simple a solution. The foetus lies surrounded (protected) by fluid contained in the amniotic sac. For its expulsion there is required, on the one hand, a dilatation of the uterine opening (*os uteri*), and, on the other, a *vis a tergo*. The latter is furnished by the contractions of the uterus itself, aided by the simultaneous action of the abdominal muscles. Throughout the greater part of gestation the uterus experiences somewhat rhythmical contractions, feeble as compared with the final ones which lead to expulsion of the foetus, but to be regarded as of the same character. With the growth and functional development of other organs, the placenta becomes of less consequence, and a fatty degeneration sets in, most marked at the periphery, usually where it is thinnest and of least use. It does not seem rational to believe that the onset of labor is referable to any one cause, as has been so often taught; but rather that it is the final issue to a series of processes long existing and gradually, though at last rapidly, reaching that climax which seems like a vital storm. The law of rhythm affects the nervous system as others, and upon this depends the direction and co-ordination of those many activities which make up parturition. We have seen that throughout the whole of foetal life changes in one part are accompanied by corresponding changes in others; and in the final chapter of this history it is not to be expected that this connection should be severed, though it is not at present possible to give the evolution of this process with any more than a general approach to probable correctness.

CHANGES IN THE CIRCULATION AFTER BIRTH.

When the new-born mammal takes the first breath, effected by the harmonious action of the respiratory muscles, excited to action by stimuli reaching them from the nerve-center (or

centers) which preside over respiration, owing to its being roused into action by the lack of its accustomed supply of oxygen, the hitherto solid lungs are expanded; the pulmonary vessels are rendered permeable, hence the blood now takes the path of least resistance along them, as it formerly did through the *ductus arteriosus*. The latter, from lack of use, atrophies in most instances. The blood, returning to the left auricle of the heart from the lungs in increased volume, so raises the pressure in this chamber that the stream that formerly flowed through the foramen ovale from the right auricle is opposed by a force equal to its own, if not greater, and hence passes by an easier route into the right ventricle. The fold that tends to close the foramen ovale grows gradually over the latter, so that it usually ceases to exist in a few days after birth.

At birth, ligature of the umbilical cord cuts off the placental circulation; hence the *ductus venosus* atrophies and becomes a mere ligament.

The placenta, being now a foreign body in the uterus, is expelled, and this organ, by the contractions of its walls, closes the ruptured and gaping vessels, thus providing against hæmorrhage.

• COITUS BETWEEN THE SEXES.

In all the higher vertebrates congress of the sexes is essential to bring the male sexual product into contact with the ovum.

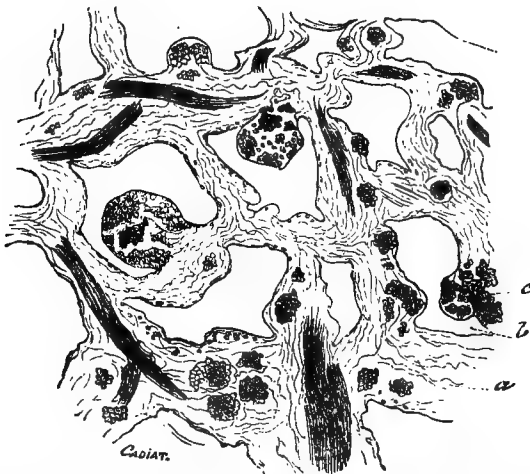

FIG. 139.—Section of erectile tissue (Cadiat). *a*, trabeculae of connective tissue, with elastic fibers, and bundles of plain muscular tissue (*c*); *b*, venous spaces (Schäfer).

Erection of the penis results from the conveyance of an excess of blood to the organ, owing to dilation of its arteries, and the retention of this blood within its caverns.

The structure of the penis is peculiar, and, for the details of the anatomy of both the male and female generative organs, the student is referred to works on this subject; suffice it to say that it consists of erectile tissue, the chief characteristic of which is the opening of the capillaries into cavernous venous spaces (*sinuses*) from which the veinlets arise; with such an arrangement the circulation must be very slow—the inflow being greatly in excess of the outflow—apart altogether from the compressive action of certain muscles connected with the organ. As previously explained, the spermatozoa originate in the seminal tubes, from which they find their way to the

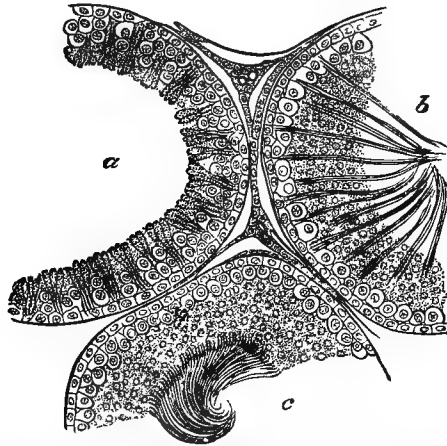

FIG. 140.—Section of parts of three seminiferous tubules of the rat (Schäfer). *a*, with the spermatozoa least advanced in development; *b*, more advanced; *c*, containing fully developed spermatozoa. Between the tubules are seen strands of interstitial cells, with blood-vessels and lymph-spaces.

seminal vesicles or receptacles for semen till required to be discharged. The spermatozoa as they mature are forced on by fresh additions from behind and by the action of the ciliated cells of the epididymis, together with the wave-like (peristaltic) action of the vas deferens. Discharge of semen during coitus is effected by more vigorous peristaltic action of the vas deferens and the seminal vesicles, followed by a similar rhythmical action of the bulbo-cavernosus and ischio-cavernosus muscles, by which the fluid is forcibly ejaculated.

Semen itself, though composed essentially of spermatozoa,

is mixed with the secretions of the vas deferens, of the seminal vesicles, of Cowper's glands, and of the prostate. Chemically it is neutral or alkaline in reaction, highly albuminous, and contains nuclein, lecithen, cholesterin, fats, and salts.

The movements of the male cell, owing to the action of the tail (cilium), suffice of themselves to convey them to the ovi-

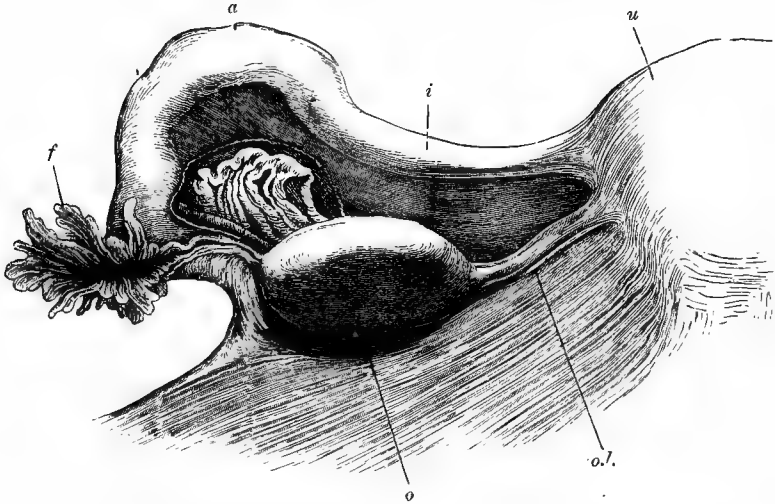

FIG. 141.—Left broad ligament, Fallopian tube, ovary, and parovarium in the human subject (Henle). *u*, uterus; *i*, isthmus of Fallopian tube; *a*, ampulla; *f*, fimbriated end of the tube, with the parovarium to its right; *o*, ovary; *o. l.*, ovarian ligament.

ducts; but there is little doubt that during or after sexual congress there is in the female, even in the human subject, at least

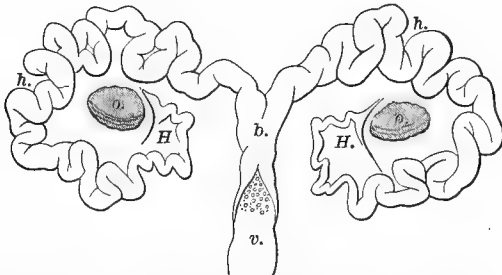

FIG. 142.—Uterus and ovaries of the sow, semi-diagrammatic (after Dalton). *o*, ovary; *H*, Fallopian tube; *h*, horn of the uterus; *b*, body of the uterus; *v*, vagina.

in many cases, a retrograde peristalsis of the uterus and ovi-ducts which would tend to overcome the results of the activity

of the ciliated cells lining the oviduct. It is known that the male cell can survive in the female organs of generation for several days, a fact not difficult to understand, from the method of nutrition of the female cell (ovum); for we may suppose that both elements are not a little alike, as they are both slightly modified amoeboid organisms.

Nervous Mechanism.—Incidental reference has been made to the directing influence of the nervous system over the events of reproduction; especially their subordination one to another to bring about the general result. These may now be considered in greater detail.

Most of the processes in which the nervous system takes part are of the nature of reflexes, or the result of the automaticity (independent action) of the nerve-centers, increased by some afferent (ingoing) impressions along a nerve-path. It is not always possible to estimate the exact share each factor takes, which must be highly variable. Certain experiments have assisted in making the matter clear. It has been found that, if in a female dog, the spinal cord be divided when the animal is still a puppy, menstruation and impregnation may occur. If the same experiment be performed on a male dog, erection of the penis and ejaculation of semen may be caused by stimulation of the penis. As the section of the cord has left the hinder part of the animal's body severed from the brain, the creature is, of course, unconscious of anything happening in all the parts below the section, of whatever nature. If the *nervi erigentes* (from the lower part of the spinal cord) be stimulated, the penis is erected; and if they be cut, this act becomes impossible, either reflexly by experiment or otherwise. Seminal emissions, it is well known, may occur during sleep, and may be associated, either as result or cause, with voluptuous dreams. Putting all these facts together, it seems reasonable to conclude that the lower part of the spinal cord contains the nervous machinery requisite to initiate those influences (impulses) which, passing along the nerves to the generative organs, excite and regulate the processes which take place in them. In these, vascular changes, as we have seen, always play a prominent part.

Usually we can recognize some afferent influence, either from the brain (psychical), from the surface—at all events from without that part of the nervous system (center) which functions directly in the various sexual processes. It is common to speak of a number of sexual centers—as the erection

center, the ejaculatory center, etc.—but we much doubt whether there is such sharp division of physiological labor as these terms imply, and they are liable to lead to misconception; accordingly, in the present state of our knowledge, we prefer to speak of the sexual center, using even that term in a somewhat broad sense.

The effects of stimulation of the sexual organs are not confined to the parts themselves, but the ingoing impulses set up radiating outgoing ones, which affect widely remote areas of the body, as is evident, especially in the vascular changes; the central current of nerve influence breaks up into many streams as a result of the rapid and extensive rise of the outflowing current, which breaks over ordinary barriers, and takes paths which are not properly its own. Bearing this fact in mind, the chemical composition of semen, so rich in proteid and other material valuable from a nutritive point of view, and considering how the sexual appetites may engross the mind, it is not difficult to understand that nothing so quickly disorganizes the whole man, physical, mental, and moral, as sexual excesses, whether by the use of the organs in a natural way, or from masturbation.

Nature has protected the lower animals by the strong barrier of instinct, so that habitual sexual excess is with them an impossibility, since the females do not permit of the approaches of the male except during the rutting period, which occurs only at stated, comparatively distant periods in most of the higher mammals. When man keeps his sexual functions in subjection to his higher nature, they likewise tend to advance his whole development.

Summary.—Certain changes, commencing with the ripening of ova, followed by their discharge and conveyance into the uterus, accompanied by simultaneous and subsequent modifications of the uterine mucous membrane, constitute, when pregnancy occurs, an unbroken chain of biological events, though usually described separately for the sake of convenience. When impregnation does not result, there is a retrogression in the uterus (menstruation) and a return to general quiescence in all the reproductive organs.

Parturition is to be regarded as the climax of a variety of rhythmic occurrences which have been gradually gathering head for a long period. The changes which take place in the placenta of a degenerative character fit it for being cast off, and may render this structure to some extent a foreign body before

it and the foetus are finally expelled, so that these changes may constitute one of a number of exciting causes of the increased uterine action of parturition. But it is important to regard the whole of the occurrences of pregnancy as a connected series of processes co-ordinated by the central nervous system so as to accomplish one great end, the development of a new individual.

The nutrition of the ovum in its earliest stages is effected by means in harmony with its nature as an amœboid organism; nutrition by the cells of blood-vessels is similar, while that by villi may be compared to what takes place through the agency of similar structures in the alimentary canal of the adult mammal.

The circulation of the foetus puts it on a par physiologically with the lower vertebrates. Before birth there is a gradual though somewhat rapid preparation, resulting in changes which speedily culminate after birth on the establishment of the permanent condition of the circulation of extra-uterine life.

The blood of the foetus (as in the adult) is the great storehouse of nutriment and the common receptacle of all waste products; these latter are in the main transferred to the mother's blood indirectly in the placenta; in a similar way nutriment is imported from the mother's blood to that of the foetus. The placenta takes the place of digestive, respiratory, and excretory organs.

Coitus is essential to bring the male and female elements together in the higher vertebrates. The erection of the penis is owing to vascular changes taking place in an organ composed of erectile tissue; ejaculation of semen is the result of the peristaltic action of the various parts of the sexual tract, aided by rhythmical action of certain striped muscles. The spermatozoa, which are unicellular, flagellated (ciliated) cells, make up the essential part of semen; though the latter is complicated by the addition of the secretions of several glands in connection with the seminal tract. Though competent by their own movements of reaching the ovum in the oviduct, it is probable that the uterus and oviduct experience peristaltic actions in a direction toward the ovary, at least in a number of mammals.

The lower part of the spinal cord is the seat in the higher mammals of a sexual center or collection of cells that receives afferent impulses and sends out efferent impulses to the sexual organs. This, like all the lower centers, is under the control of the higher centers in the brain, so that its action may be either initiated or inhibited by the cerebrum.

ORGANIC EVOLUTION RECONSIDERED.

The study of reproduction has prepared the student for the comprehension of certain views of the origin of the forms of life which could not be as profitably considered before.

While the great majority of biologists are convinced that there has been a gradual evolution of more complex organisms from simpler ones, and while most believe that Darwin's theory furnishes some of the elements of a solution of the problem as to how this has occurred, many still feel that the whole explanation was not furnished by that great naturalist.

Accordingly, we shall notice very briefly a few of the more important contributions to this subject since Darwin's views were published.

In America, under the influence of the writings of Cope and Hyatt, a school of evolutionists has been formed, holding doctrines that constitute a modification of those announced in cruder form by Lamarck, hence termed neo-Lamarckianism. These authors have imported *consciousness* into the list of factors of organic evolution and given it a prominent place. They regard consciousness as a fundamental property of protoplasm; it determines effort and the direction that activity shall take: thus hunger leads to migration, and brings the creature under a new set of conditions which influence its nature. A certain proportion of the changes an animal undergoes are attributed to the direct influence of surrounding conditions (environment), but the larger number are owing to efforts involving the greater use of some parts than others, which tends to become habitual. This is the explanation neo-Lamarckianism offers for the *origin* of variations. It is assumed that the results of use or disuse of parts is inherited, so that the gain or loss is not transient with the individual, but remains with the group.

This theory also refers the loss or preservation of certain structures to "acceleration" or "retardation" of growth; thus, if the growth of gills were greatly and progressively retarded during embryonic life, they might become only rudimentary, and this would furnish an explanation of the origin of rudimentary organs, though it is clear that use and effort could not directly explain such acceleration or retardation. It is further a fact, which this theory does not explain, that all variations of structure produced by use are not inherited.

Weismann, in fact, denies that peculiarities acquired during the lifetime of the adult are passed on to offspring. This writer believes that we must seek in *Amœba*, as the ancestral representative of the ovum, for the clew to the laws of heredity. The *Amœba* must divide or cease to exist as a group form—hence the segmentation of the ovum; this is but the inherited tendency to divide. What the individual becomes is determined entirely by the ovum, the whole of which does not develop into the new being, but a part is laid aside in reserve as the future ovum. Any variations that show themselves in future individuals are such as arise from the variations of the ovum itself.

According to this writer, it is as natural for the offspring to resemble the parent (heredity) in the higher groups of animals as that one *Amœba* should resemble another, and for the same reason.

Weismann has also attempted to explain the necessity and the significance of the extrusion of polar globules. The first polar globule is expelled from all ova, even those that can develop independent of a male cell (parthenogenetic). This represents that part of the original ovum which determines its peculiarities of form, etc. (ovogenetic idioplasm); while the second polar globule is one half of the nucleus of the mature ovum ready to enter upon development, if fertilized. When the latter takes place, it is joined by the corresponding nuclear substance of the male cell to form the segmentation nucleus. It is this substance (germ-plasma) which determines exactly what line of development, to the minutest details, the ovum shall follow. In the course of time the nucleus would thus come to represent many generations of united plasmas. There must be a limit to this, from the physical necessities of the case; hence the expulsion of a second polar globule, which also is a provision against parthenogenesis, for in some cases the plasma of the nucleus has the power, without the accession of any male plasma, to segment and develop the mature animal. But in any case there is a great advantage in the union of the two plasmas with their diverse experiences; hence sexual reproduction, though the most costly apparently, is in reality the most economical for Nature in the end, for higher results are reached, and it seems, in fact, that this lies at the very foundation of organic progress.

The theory of Brooks may be regarded as eclectic, being a combination of that of Weismann and Darwin more particularly, with entirely new additions by himself.

Darwin believed that every part of the body gave off "gem-mules," or very minute bodies, which were collected into the ovum, and thus the ovum came to be a sort of abstract of the whole body—hence the resemblance of offspring to parents, since the development of the ovum was but that of the gem-mules. Some of the gemmules might remain latent for generations, and then develop; hence that resemblance often seen to ancestors more remote than the parents (reversion). This is a very brief account of Darwin's hypothesis of *pangeneses*.

This writer, however, never accounted for variations. He spoke of variations as "spontaneous," meaning, not that they were supernatural, but that it was not possible to assign them to a definite cause. To account for variation has naturally been the aim of later writers. How neo-Lamarckianism does this has been already considered. We now give the views of Brooks on this and other points in connection with organic evolution.

This thinker, like Weismann, looks to the fertilized ovum for an explanation of the main facts; but Brooks refers the origin of variations to the influence of the male cell. This is, of course, a pure hypothesis, but it is in harmony with many facts which were in need of explanation. It had been noticed by Darwin that variations of all kinds were most apt to arise upon alteration in the conditions under which an animal lived. Brooks also believes in gemmules, but does not think they are given off from all parts equally or at all times, but that they are derived from those parts most affected by the change of surroundings; and since this would influence parts much when for the worse, variation would coincide with suffering or need; hence those very parts would vary, and so prepare for adaptation, just when this was most called for by the nature of the case. But the male sexual element, it has been shown, is more liable to variation than the ovum; hence the explanation of what Brooks believes to be a fact, that it is the sperm-cell that generally is responsible for variation, since it chiefly collects the gemmules.

The author of this theory points to parthenogenetic forms being less variable, as evidence of the truth of his view. To introduce a male cell is to impart vast numbers of new gem-mules, and thus induce variability. This hypothesis would explain why the female represents what is most fundamental and ancient in the history of psychological development, and the male what is associated with enterprise—in a word, the female preserves, the male originates, in the widest sense.

Vines has stated that the equivalent of parthenogenesis takes place in the male cell in plants. Though this may be an objection to the universality of application of Brooks's theory, it does not seem to us to be fatal to it as a whole.

As has been pointed out, in a previous chapter, Darwin held that the differences that caused ultimately the formation of new groups of living forms were the result of extremely slow accumulation of variations, at first very minute. He everywhere insists upon this. But, unquestionably, it is just here that the greatest difficulty is to be encountered in the Darwinian account of evolution. The chances against the loss of the variation by breeding with forms that did not possess it seem to be numerous, hence various theories have been proposed to lessen the difficulty.

Mivart introduced the doctrine of *extraordinary births*, believing that variations were often sudden and pronounced. That they were so occasionally Darwin himself admitted; but he considered a theory like that of Mivart as a surrender, a resort to an explanation that verged in its character on the introduction of the supernatural itself.

A view that has attracted much attention and caused a great deal of controversy, is that of Romanes, which was introduced in part to meet the difficulty just referred to; and to lessen the further one arising from the infertility of species with one another, as compared with the perfect fertility of varieties. It has often been noticed that, though the difference anatomically between varieties might be greater than between species, the above law as to fertility still held. Such a fact calls for explanation; hence Romanes has proposed his theory of "physiological selection" (segregation, isolation). If it be admitted that some change may take place in the sexual organs of two forms so that the members of one are fertile with each other while those of the other are not, it will at once appear that they are as much isolated physiologically as if separated by an ocean. That such does take place is an assumption based on the great tendency in the reproductive organs to change; and it is claimed that, if this assumption be granted, that the main difficulty of Darwin's theory will be removed, for the "swamping" action of intercrossing forms that vary slightly, or one of them not at all, in the given direction, will not occur. Romanes believes that forms that vary are fertile *inter se*, but not with the parent forms, which would meet the case fairly well. Certain it is that species are not generally fertile with one an-

other while varieties are so invariably; and it is this that, in the opinion of Romanes and many others, has never been adequately explained.

Admitting that the theories of Romanes, Brooks, and Weismann have advanced us on the way to more complete views of the mode of origin of the forms of the organic world, it must still be felt that all theories yet propounded fall short of being entirely satisfactory. It seems to us unfortunate that the subject has not received more attention from physiologists, as without doubt the final solution must come through that science which deals with the properties rather than the forms of protoplasm; or, in other words, the fundamental principles underlying organic evolution are physiological. But, in the unraveling of a subject of such extreme complexity, all sciences must probably contribute their quota to make up the truth, as many rays of different colors compounded form white light. As with other theories of the inductive sciences, none can be more than temporary; there must be constant modification to meet increasing knowledge. Conscious that any views we ourselves advance must sooner or later be modified as all others, even if acceptable now, we venture to lay before the reader the opinions we have formed upon this subject as the result of considerable thought.

All vital phenomena may be regarded as the resultant of the action of external conditions and internal tendencies. Amid the constant change which life involves we recognize two things: the tendency to retain old modes of behavior, and the tendency to modification or variation. Since those impulses originally bestowed on matter when it became living, must, in order to prevail against the forces from without, which tend to destroy it, have considerable potency, the tendency to modification is naturally and necessarily less than to permanence of form and function.

From these principles it follows that when an Amœba or kindred organism divides after a longer or shorter period, it is not in reality the same in all respects as when its existence began, though we may be quite unable to detect the changes; and when two infusorians conjugate, the one brings to the other protoplasm different in molecular behavior, of necessity, from having had different experiences. We attach great importance to these principles, as they seem to us to lie at the root of the whole matter. What has been said of these lower but inde-

pendent forms of life applies to the higher. All organisms are made up of cells or aggregations of cells and their products. For the present we may disregard the latter. When a muscle-cell by division gives rise to a new cell, the latter is not identically the same in every particular as the parent cell was originally. It is what its parent has become by virtue of those experiences it has had as a muscle-cell *per se*, and as a member of a populous biological community, of the complexities of which we can scarcely conceive.

Now, as a body at rest may remain so, or may move in a certain direction according as the forces acting upon it exactly counterbalance one another, or produce a resultant effect in the direction in which the body moves, so in the case of heredity, whether a certain quality in the parent appears in the offspring, depends on whether this quality is neutralized, augmented, or otherwise modified by any corresponding quality in the other parent, or by some opposite quality, taken in connection with the direct influence of the environment during development.

This assumption explains among other things why acquired peculiarities (the results of accident, habit, etc.) may or may not be inherited.

These are not usually inherited because, as is to be expected, those forces of the organism which have been gathering head for ages are naturally not easily turned aside. Again, we urge, heredity must be more pronounced than variation.

The ovum and sperm-cell, like all other cells of the body, are microcosms representing the whole to a certain extent in themselves—that is to say, cell A is what it is by reason of what all the other millions of its fellows in the biological republic are; so that it is possible to understand why sexual cells represent, embody, and repeat the whole biological story, though it is not yet possible to indicate exactly how they more than others have this power. This falls under the laws of specialization and the physiological division of labor; but along what paths they have reached this we can not determine.

Strong evidence is furnished for the above views by the history of disease. Scar-tissue, for example, continues to reproduce itself as such; like produces like, though in this instance the like is in the first instance a departure from the normal. Gout is well known to be a hereditary disease; not only so, but it arises in the offspring at about the same age as in the parent, which is equivalent to saying that in the rhythmical life of

certain cells a period is reached when they display the behavior, physiologically, of their parents. Yet gout is a disease that can be traced to peculiar habits of living and may be eventually escaped by radical changes in this respect—that is to say, the behavior of the cells leading to gout can be induced and can be altered; gout is hereditary, yet eradicable.

Just as gout may be set up by formation of certain modes of action of the cells of the body, so may a mode of behavior, in the nervous system, for example, become organized or fixed, become a habit, and so be transmitted to offspring. It will pass to the descendants or not according to the principles already noticed. If so fixed in the individual in which it arises as to predominate over more ancient methods of cell behavior, and not neutralized by the strength of the normal physiological action of the corresponding parts in the other parent, it will reappear. We can never determine whether this is so or not beforehand; hence the fact that it is impossible, especially in the case of man, whose vital processes are so modified by his psychic life, to predict whether acquired variations shall become hereditary; hence also the irregularity which characterizes heredity in such cases; they may reappear in offspring or they may not. In viewing heredity and modification it is impossible to get a true insight into the matter without taking into the account both original natural tendencies of living matter and the influence of environment. We only know of vital manifestations in *some* environment; and, so far as our experience goes, life is impossible apart from the influence of surroundings. With these general principles to guide us, we shall attempt a brief examination of the leading theories of organic evolution.

First of all, Spencer seems to be correct in regarding evolution as universal, and organic evolution but one part of a whole. No one who looks at the facts presented in every field of nature can doubt that struggle (opposition, action and reaction) is universal, and that in the organic world the fittest to a given environment survives. But Darwin has probably fixed his attention too closely on this principle and attempted to explain too much by it, as well as failed to see that there are other deeper facts underlying it. Variation, which this author scarcely attempted to explain, seems to us to be the natural result of the very conditions under which living things have an existence. Stable equilibrium is an idea incompatible with our fundamental conceptions of life. Altered function implies altered molecular action, which sometimes leads to appreciable

structural change. From our conceptions of the nature of living matter, it naturally follows that variation should be greatest, as has been observed, under the greatest alteration in the surroundings.

We are but very imperfectly acquainted as yet with the conditions under which life existed in the earlier epochs of the earth's history. Of late, deep-sea soundings and arctic explorations have brought surprising facts to light, showing that living matter can exist under a greater variety of conditions than was previously supposed. Thus it turns out that light is not an essential for life everywhere. We think these recent revelations of unexpected facts should make us cautious in assuming that life always manifested itself under conditions closely similar to those we know. Variation may at one period have been more sudden and marked than Darwin supposes; and there does seem to be room for such a conception as the "extraordinary births" of Mivart implies; though we would not have it understood that we think Darwin's view of slow modification inadequate to produce a new species; we simply venture to think that he was not justified in insisting so strongly that this was the only method of Nature; or, to put it more justly for the great author of the "Origin of Species," with the facts that have accumulated since his time he would scarcely be warranted in maintaining so rigidly his conviction that new forms arose almost exclusively by the slow process he has so ably described.

As there must be all degrees in consciousness, we do not deny that it may be logical to assume some dim spark of this quality in all protoplasm, as Cope insists; and that it plays a part in determining action and growth there seems to be no doubt. But is it not more philosophical to regard consciousness and all allied qualities as correlatives, and underlaid by a molecular constitution with which it is associated as other qualities? It is unduly exalted in the neo-Lamarckian philosophy.

We must allow a great deal to use and effort, doubtless, and they explain the origin of variations up to a certain point, but the solution is only partial. Variations must arise as we have attempted to explain, and use and disuse are only two of the factors amid many. Correlated growth, or the changes in one part induced by changes in another, is a principle which, though recognized by Darwin, Cope, and others, has not, we think, received the attention it deserves. To the mind of the physiologist, *all* changes must be correlated with others.

This principle has played a great part in the development of man, as we shall show later.

Weismann's theories have called attention to the ovum in a new and valuable way, though he seems to have given too exclusive attention to the nucleus (*germ-plasma*) in itself and out of relation to the influence of the countless cells that make up the body and must be constantly determining modifications of the generative organs and the sexual cells themselves; so that Brooks's explanation, by adding a new factor, or, at least, presenting a new aspect of the case, was called for and seems to be warranted on the general principle that advance in protoplasmic life is dependent on new experiences, and that the male cell represents a little world of the concentrated experiences gathered during the lifetime of the organism that produced it. But we must consider the whole doctrine of gemmules as a crude and entirely unnecessary hypothesis.

In what sense has the line that evolution has taken been predetermined? In the sense that all things in the universe are unstable, are undergoing change, leading to new forms and qualities of such a character that they result in a gradual progress toward what our minds can not but consider higher manifestations of being.

The secondary methods according to which this takes place constitute the laws of nature, and as we learn from the progress of science are very numerous. The unity of nature is a reality toward which our conceptions are constantly leading us. Evolution is a necessity of living matter (indeed, all matter) as we view it.

THE CHEMICAL CONSTITUTION OF THE ANIMAL BODY.

One visiting the ruins of a vast and elaborate building, which had been thoroughly pulled to pieces, would get an amount of information relative to the original structure and uses of the various parts of the edifice largely in proportion to his familiarity with architecture and the various trades which make that art a practical success. The study of the chemistry of the animal body is illustrated by such a case. Any attempt to determine the exact chemical composition of living matter must result in its destruction; and the amount of information conveyed by the examination of the chemical ruins, so to speak,

will depend a great deal on the knowledge already possessed of chemical and vital processes.

It is in all probability true that the nature of any vital process is at all events closely bound up with the chemical changes involved; but we must not go too far in this direction. We are not yet prepared to say that life is only the manifestation of certain chemical and physical processes, meaning thereby such chemistry and physics as are known to us; nor are we prepared to go the length of those who regard life as but the equivalent of some other force or forces; as electricity may be considered as the transformed representative of so much heat and *vice versa*. It may be so, but we do not consider that this view is warranted in the present state of our knowledge.

On the other hand, vital phenomena, when our investigations are pushed far enough, always seem to be closely associated with chemical action; hence the importance to the student of physiology of a sound knowledge of chemical principles. We think the most satisfactory method of studying the functions of an organ will be found to be that which takes into consideration the totality of the operations of which it is the seat, together with its structure and chemical composition; hence we shall treat chemical details in the chapters devoted to special physiology, and here give only such an outline as will bring before the view the chemical composition of the body in its main outlines; and even many of these will gather a significance, as the study of physiology progresses, that they can not possibly have at the present.

Fewer than one third of the chemical elements enter into the composition of the mammalian body; in fact, the great bulk of the organism is composed of carbon, hydrogen, nitrogen, and oxygen; sodium, potassium, magnesium, calcium, sulphur, phosphorus, chlorine, iron, fluorine, silicon, though occurring in very small quantity, seem to be indispensable to the living body; while certain others are evidently only present as foreign bodies or impurities to be thrown out sooner or later. It need scarcely be said that the elements do not occur as such in the living body, but in combination forming salts, which latter are usually united with albuminous compounds. As previously mentioned, the various parts which make up the entire body of an animal are composed of living matter in very different degrees; hence we find in such parts as the bones abundance of salts, relative to the proportion of proteid matter; a condition demanded by that rigidity without

which an internal skeleton would be useless, a defect well illustrated by that disease of the bones known as rickets, in which the lime-salts are insufficient. It is manifest that there may be a very great variety of classifications of the compounds found in the animal body according as we regard it from a chemical, physical, or physiological point of view, or combine many aspects in one whole. The latter is, of course, the most correct and profitable method, and as such is impossible at this stage of the student's progress; we shall simply present him with the following outline, which will be found both simple and comprehensive.* The subject of Animal Chemistry will be found treated in detail in the Appendix.

CHEMICAL CONSTITUTION OF THE BODY.

Such food as supplies energy directly must contain *carbon* compounds.

Living matter or protoplasm always contains *nitrogenous* carbon compounds.

In consequence, C, H, O, N, are the elements found in greatest abundance in the body.

The elements S and P are associated with the nitrogenous carbon compounds; they also form metallic sulphates and phosphates.

Cl and F form salts with the alkaline metals Na, K, and the earthy metals Ca and Mg.

Fe is found in *hæmoglobin* and its derivatives.

Protoplasm, when submitted to chemical examination, is killed. It is then found to consist of proteids, fats, carbohydrates, salines, and extractives.

It is probable that when living it has a very complex molecule consisting of C, H, O, N, S, and P chiefly.

PROXIMATE PRINCIPLES.

- | | | | |
|---------------|---|----------------------|-------------------------------|
| 1. Organic. | { | (a) Nitrogenous. | { Proteids. |
| | | | { Certain crystalline bodies. |
| | | (b) Non-nitrogenous. | { Carbohydrates. |
| | | | { Fats. |
| 2. Inorganic. | { | Mineral salts. | |
| | | Water. | |

SALTS.—In general, the salts of *sodium* are more characteristic of *animal* tissues and those of *potassium* of *vegetable* tissues.

* Taken from the author's "Outlines of Lectures on Physiology," W. Drysdale & Co., Montreal.

Na Cl is more abundant in the *fluids* of animals; K and phosphates more abundant in the *tissues*.

Earthy salts are most abundant in the harder tissues.

The salts are probably not much, if at all, changed in their passage through the body.

In some cases there is a change from acid to neutral or alkaline.

The salts are essential to preserve the balance of the nutritive processes. Their absence leads to disease, e. g., scurvy.

GENERAL CHARACTERISTICS OF PROTEIDS.

They are the chief constituents of most living tissues, including blood and lymph.

The molecule consists of a great number of atoms (complex constitution), and is formed of the elements C, H, N, O, S, and P.

All proteids are amorphous.

All are non-diffusible, the *peptones* excepted.

They are soluble in strong acids and alkalies, with change of properties or constitution.

In general, they are coagulated by alcohol, ether, and heating.

Coagulated proteids are soluble only in strong acids and alkalies.

Classification and Distinguishing Characters of Proteids.

1. *Native albumins*: Serum albumin; egg albumin; soluble in water.

2. *Derived albumins (albuminates)*: Acid and alkali albumin; casein; soluble in dilute acids and alkalies, insoluble in water. Not precipitated by boiling.

3. *Globulins*: Globulin (globin); paraglobulin; myosin; fibrinogen. Soluble in dilute saline solutions, and precipitated by stronger saline solutions.

4. *Peptones*: Soluble in water; diffusible through animal membranes; not precipitated by acids, alkalies, or heat. Derived from the digestion (peptic, pancreatic) of all proteids.

5. *Fibrin*: Insoluble in water and dilute saline solutions. Soluble, but not readily, in strong saline solutions and in dilute acids and alkalies.

CERTAIN NON-CRYSTALLINE BODIES.

The following bodies are allied to proteids, but are not the equivalents of the latter in the food.

They are all composed of C, H, N, O. Chondrin, gelatin, ceratin have, in addition, S.

Chondrin: The organic basis of cartilage. Its solutions set into a firm jelly on cooling.

Gelatin: The organic basis of bone, teeth, tendon, etc. Its solutions set (glue) on cooling.

Elastin: The basis of elastic tissue. Its solutions do not set jelly-like (gelatinize).

Mucin: From the secretion of mucous membranes; precipitated by acetic acid, and insoluble in excess.

Keratin: Derived from hair, nails, epidermis, horn, feathers. Highly insoluble.

Nuclein: Derived from the nuclei of cells. Not digested by pepsin; contains P but no S.

THE FATS.

The fats are hydrocarbons; are less oxidized than the carbohydrates; are inflammable; possess latent energy in a high degree.

Chemically, the neutral fats are glycerides or ethers of the fatty acids, i. e., the acid radicles of the fatty acids of the *oleic* and *acetic* series replace the exchangeable atoms of H in the triatomic alcohol glycerine, e. g.:

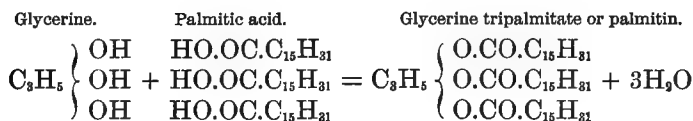

A *soap* is formed by the action of caustic alkalies on fats, e. g.:

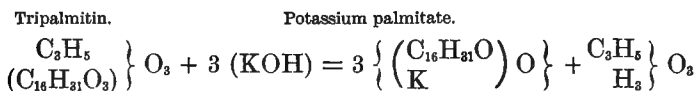

The soap may be decomposed by a strong acid into a fatty acid and glycerine, e. g.:

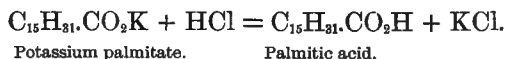

The *fats* are insoluble in water, but soluble in hot alcohol, ether, chloroform, etc.

The *alkaline* soaps are soluble in water.

Most animal fats are mixtures of several kinds in varying proportion; hence the melting-point for the fat of each species of animal is different.

PECULIAR FATS.

Lecithin, Protagon, Cerebrin:

They consist of C, H, N, O, and the first two of P in addition.

They occur in the *nervous* tissues.

CARBOHYDRATES.

General formula, $C_m (H_2O)_n$.

1. THE SUGARS: *Dextrose*, or grape-sugar, $C_6H_{12}O_6 + H_2O$ readily undergoes alcoholic fermentation; less readily lactic fermentation.

Lactose, milk-sugar, $C_{12}H_{22}O_{11} + H_2O$; susceptible of the lactic acid fermentation.

Inosit, or muscle-sugar, $C_6H_{12}O_6 + 2H_2O$; capable of the lactic fermentation.

Maltose, $C_{12}H_{22}O_{11} + H_2O$, capable of the alcoholic fermentation. The chief sugar of the digestive process.

All the above are much less sweet and soluble than ordinary cane-sugar.

2. THE STARCHES: *Glycogen*, $C_6H_{10}O_5$, convertible into dextrose. Occurs abundantly in many foetal tissues and in the liver, especially of the adult animal.

Dextrin, $C_6H_{10}O_5$, convertible into dextrose. Soluble in water; intermediate between starch and dextrose; a product of digestion.

Pathological: Grape-sugar occurs in the urine in *diabetes mellitus*.

Certain substances formed within the body may be regarded as chiefly waste-products, the result of metabolism or tissue-changes.

They are divisible into nitrogenous metabolites and non-nitrogenous metabolites.

Nitrogenous Metabolites.

1. Urea, uric acid and compounds, kreatinin, xanthin, hypoxanthin (sarkin), hippuric acid, all occurring in urine.

2. Leucin, tyrosin, taurocholic, and glycocholic acids, which occur in the digestive tract.

3. Kreatin, constantly found in muscle, and a few others of less constant occurrence.

The above consists of C, H, N, O. Taurocholic acid contains also S.

The molecule in most instances is complex.

Non-Nitrogenous Metabolites.

These occur in small quantity, and some of them are secreted in an altered form.

They include lactic and sarcolactic acid, oxalic acid, succinic acid, etc.

PHYSIOLOGICAL RESEARCH AND PHYSIOLOGICAL REASONING.

We propose in this chapter to examine into the methods employed in physiological investigation and teaching, and the character of conclusions arrived at by physiologists as dependent on a certain method of reasoning.

The first step toward a legitimate conclusion in any one of the *inductive* sciences to which physiology belongs is the collection of facts which are to constitute the foundation on which the inference is to be based. If there be any error in these, a correct conclusion can not be drawn by any reliable logical process. On the other hand, facts may abound in thousands and yet the correct conclusion never be reached, because the method of interpretation is faulty, which is equivalent to saying that the process of inference is either incomplete or incorrect. The conclusions of the ancients in regard to nature were usually faulty from errors in both these directions; they neither had the requisite facts, nor did they correctly interpret those with which they were conversant.

Let us first examine into the methods employed by modern physiologists, and determine in how far they are reliable. First, there is the method of *direct* observation, in which no apparatus whatever or only the simplest kind is employed; thus, the student may count his own respirations, feel his own heart-beats, count his pulse, and do a very great deal more that will be pointed out hereafter; or he may examine in like manner another fellow-being or one of the lower animals. This method is simple, easy of application, and is that usually employed by the physician even at the present day, especially in private

practice. The value of the results obviously depends on the reliability of the observer in two respects: First, as to the accuracy, extent, and delicacy of his perceptions; and, secondly, on the inferences based on these sense-observations. Much must depend on practice—that is to say, the education of the senses. The hand may become a most delicate instrument of observation; the eye may learn to see what it once could not; the ear to detect and discriminate what is quite beyond the uncultured hearing of the many. But it is one of the most convincing evidences of man's superiority that in every field of observation he has risen above the lower animals, some of which by their unaided senses naturally excel him. So in this science, instruments have opened up mines of facts that must have otherwise remained hidden; they have, as it were, provided man with additional senses, so much have the natural powers of those he already possessed been sharpened.

But the chief value of the results reached by instruments consists in the fact that the movements of the living body can be *registered*; i. e., the great characteristic of modern physiology is the extensive employment of the graphic method, which has been most largely developed by the distinguished French experimenter Marey. Usually the movements of the point of lever are impressed on a smoked surface, either of glazed paper or glass, and rendered permanent by a coating of some material applied in solution and drying quickly, as shellac in alcohol. The surface on which the tracing is written may be stationary, though this is rarely the case, as the object is to get a succession of records for comparison; hence the most used form of writing surface is a cylinder which may be raised or lowered, and which is moved around *regularly* by some sort of clock-work. It follows that the lever-point, which is moved by the physiological effect, describes curves of varying complexity. That tracings of this or any other character should be of any value for the purposes of physiology, they must be susceptible of relative measurement both for time and space. This can be accomplished only when there is a known base-line or abscissa from which the lever begins its rise, and a time record which is usually in seconds or portions of a second. The first is easily obtained by simply allowing the lever to write a straight line before the physiological effect proper is recorded. Time intervals are usually indicated by the interruptions of an electric current, or by the vibrations of a tuning-fork, a pen or writer

of some kind being in each instance attached to the apparatus so as to record its movements.

As levers, in proportion to their length, exaggerate all the movements imparted to them, a constant process of correction must be carried on in the mind in reading the records of the graphic method, as in interpreting the field of view presented by the microscope.

The student is especially warned to carry on this process, otherwise highly distorted views of the reality will become fixed in his own mind; and certainly a condition of ignorance is to be preferred to such false knowledge as this may become. But it is likewise apparent that movements that would without such mechanism be quite unrecognized may be rendered visible and utilized for inference. There is another source of possible misconception in the use of the graphic method. The lever is sometimes used to record the movements of a column of fluid (manometer, Fig. 207), as water or mercury, the inertia of which is considerable, so that the record is not that of the lever as affected by the physiological (tissue) movement, but that movement conveyed through a fluid of the kind indicated. Again, all points, however delicate, write with some friction, and the question always arises, In how far is that friction sufficient to be a source of inaccuracy in the record? When organs are directly connected with levers or apparatus in mechanical relation with them, one must be sure that the natural action of the organ under investigation is in no way modified by this connection.

From these remarks it will be obvious that in the graphic method physiologists possess a means of investigation at once valuable and liable to mislead. Already electricity has been extensively used in the researches of physiologists, and it is to this and the employment of photography that we look in the near future for methods that are less open to the objections we have noticed.

However important the methods of physiology, the results are vastly more so. We next notice, then, the progress from methods and observations to inferences, which we shall endeavor to make clear by certain cases of a hypothetical character. Proceeding from the brain and entering the substance of the heart, there is in vertebrates a nerve known as the *vagus*. Suppose that, on stimulating this nerve by electricity in a rabbit, the heart ceases to beat, what is the legitimate inference? Apparently that the effect has been due to the action of the

nerve on the heart, an action excited by the use of electricity. This does not, however, according to the principles of a rigid logic, follow. The heart may have ceased beating from some cause wholly unconnected with this experiment, or from the electric current escaping along the nerve and affecting some nervous mechanism within the heart, which is not a part of the vagus nerve; or it may have been due to the action of the current on the muscular tissue of the heart directly, or in some other way. But suppose that invariably, whenever this experiment is repeated, the one result (arrest of the beat) follows, then it is clear that the vagus nerve is in some way a factor in the causation. Now, if it could be ascertained that certain branches of the nerve were distributed to the heart-muscle directly, and that stimulation of these gave rise to arrest of the cardiac pulsation, then would it be highly probable, though not certain, that there was in the first instance no intermediate mechanism; while this inference would become still more probable if in hearts totally without any such nervous apparatus whatever, such a result followed on stimulation of the vagus. Suppose, further, that the application of some drug or poison to the heart provided with special nervous elements besides the vagus terminals prevented the effect before noticed on stimulating the vagus, while a like result followed under similar circumstances in those forms of heart unprovided with such nervous structures, there would be additional evidence in favor of the view that the result we are considering was due solely to some action of the vagus nerve; while, if arrest of the heart followed in the first case but not in the second, and this result were invariable, there would be roused the suspicion that the action of the vagus was not direct, but through the nervous structures within the heart other than vagus endings. And if, again, there were a portion of the rabbit's heart to which there were distributed this intrinsic nervous supply, which on stimulation directly was arrested in its pulsation, it would be still more probable that the effect in the first instance we have considered was due to these structures, and only indirectly to the vagus. But be it observed, in all these cases there is only probability. The conclusions of physiology never rise above probability, though this may be so strong as to be practically equal in value to absolute certainty. Would it be correct, from any or all the experiments we have supposed to have been made, to assert that the vagus was the arresting (inhibitory) nerve of the heart? All hearts thus far examined have much in common in structure

and function, and in so far is the above generalization probable. Such a statement would, however, be far from that degree of probability which is possible, and should therefore not be accepted till more evidence has been gathered. The mere resemblance in form and general function does not suffice to meet the demands of a critical logic. Such a statement as the above would not necessarily apply to the hearts of all vertebrates or even all rabbits, if the experiments had been conducted on one animal alone, for the result might be owing to a mere idiosyncrasy of the rabbit under observation. The further we depart from the group of animals to which the creature under experiment belongs, the less is the probability that our generalizations for the one class will apply to another. It will, therefore, be seen that wide generalizations can not be made with that amount of certainty which is attainable until experiments shall have become very numerous and widely extended. A really broad and sound physiology can only be constructed when this science has become much more *comparative*—that is, extended to many more groups and sub-groups of animals than at present.

To attempt to generalize for the heart, the kidney, the liver, etc., when only the dog, cat, rabbit, and frog, have been made as a rule the subjects of experiment, except for the groups of animals to which the above belong, is not only hazardous but positively illogical; while to denominate conclusions based on such experiments, even when supplemented by the teachings of disease, "human physiology" is, in the writer's opinion, a wholly unwarrantable proceeding.

It is this conviction which has had much to do with this book being written; to the introduction of the comparative element; and the separation so frequently in form as well as in reality of facts and inferences. A genuine human physiology, with the exact nature and value of the inferences clearly stated, is yet to be written; and it seems not only judicious, but demanded as a matter of candor and honesty, to state at the outset to the student what we feel able to teach confidently, and what must be presented as feebly probable or barely possible.

Human physiology proper must of necessity be accumulated slowly. Much may be, indeed must be, inferred from the experiments disease is making; still, certain forms of accident or surgical operation provide the opportunity to investigate the human body in health or in a moderately near approach to that condition. Close self-observation under a variety of condi-

tions, so precisely defined as to meet the demands of science, may be made by the intelligent student. Much of this might be verified in the case of other healthy persons. Some of it is in certain respects of more value than any experiments that can be made upon the lower animals, for the latter can not communicate to us their sensations; in their case all our information must be derived from the use of our own senses, mostly unaided by any reports of theirs.

It is not possible during any experiment, especially any one in which vivisection is employed, to observe the animal under conditions that are strictly normal, for, by the very nature of the case, we have rendered it abnormal. We must in all such instances draw conclusions with corresponding caution. It will be understood that the expression "conclusive experiment," as applied to such a case, is only approximately correct.

At the present time it is very common to experiment upon organs disconnected, either anatomically or physiologically (functionally), from the rest of the body to a greater or less extent. This is termed the isolated method. It has the advantage of being more simple, and permits of the study of certain points apart from others—one factor being considered independently of the rest in the physiological total. But, in drawing conclusions, it is very important in such a case not to forget the premises. There is manifest danger of making the generalization wider than the facts warrant. It is only when such experiments are supplemented by a great many others, and when judged in connection with the action of the organ under consideration, as it is influenced by other organs, that such results can be of great value in building up a normal physiology. To know, for example, that the isolated heart behaves in a certain manner is not useless information, but its value depends entirely on the conclusions drawn from it, especially as to what it is conceived as teaching of the functions of the heart as it beats within the body of an animal while it walks, or flies, or swims, in carrying out the purpose of its being.

We have incidentally alluded to the teaching of disease. "Disease" is but a name for disordered function. One viewing a piece of machinery for the first time in improper action might draw conclusions with comparative safety, provided he had a knowledge of the correct action of *similar* machines. Our experience gives us a certain knowledge of the functions of our own bodies. By ordinary observation and by experiment on other animals we get additional data, which, taken with the

disordered action resulting from gross or molecular injury (disease), gives a basis for certain conclusions as to the normal functions of the human body or those of lower animals. This information is especially valuable in the case of man, since he can report with a fair degree of reliability, in most diseased conditions, his own sensations.

It is hoped that this brief treatment of the methods and logic of physiology will suffice for the present. Throughout the work they will be illustrated in every chapter, though not always with distinct references to the nature of the intellectual process followed.

Summary.—There are two methods of physiological observation, the direct and the indirect. The first is the simplest, and is valuable in proportion to the accuracy and delicacy and range of the observer; the latter implies the use of apparatus, and is more complex, more extended, more delicate, and precise. It is usually employed with the graphic method, which has the advantage of recording and thus preserving movements which correspond with more or less exactness to the movements of tissues or organs. It is valuable, but liable to errors in recording and in interpretation.

The logic of physiology is that of the inductive sciences. It proceeds from the special to the general. The conclusions of physiology never pass beyond extreme probability, which, in some cases, is practically equal to certainty. It is especially important not to make generalizations that are too wide.

THE BLOOD.

It is a matter of common observation that the loss of the whole, or a very large part, of the blood of the body entails death; while an abundant hæmorrhage, or blood-disease in any of its forms, causes great general weakness.

The student of embryology is led to inquire as to the necessity for the very early appearance and the rapid development of the blood-vascular system so prominent in all vertebrates.

An examination of the means of transit of the blood, as already intimated, reveals a complicated system of tubes distributed to every organ and tissue of the body. These facts would lead one to suppose that the blood must have a transcendent importance in the economy, and such, upon the most minute investigation, proves to be the case. The blood has

been aptly compared to an internal world for the tissues, answering to the external world for the organism as a whole. This fluid is the great storehouse containing all that the most exacting cell can demand; and, further, is the temporary receptacle of all the waste that the most busy cell requires to discharge. Should such a life-stream cease to flow, the whole vital machinery must stop—death must ensue.

Comparative.—It will prove more scientific and generally satisfactory to regard the blood as a tissue having a fluid and flowing matrix, in which float cellular elements or corpuscles—a view of the subject that is less startling when it is remembered that the greater part of the protoplasm which makes up the other tissues of the body is of a semifluid consistence. In all animals possessing blood, the matrix is a clear, usually more or less colored fluid. Among invertebrates the color may be pronounced: thus, in cephalopods and some crustaceans it is blue, but in most groups of animals and all vertebrates the matrix is either colorless or more commonly of some slight tinge of yellow. Invertebrates with few exceptions possess only colorless corpuscles, but all vertebrates have colored cells which invariably outnumber the other variety, and display

forms and sizes which are sufficiently constant to be characteristic. In all groups below mammals the colored corpuscles are oval, mostly biconvex, and nucleated during all periods of the animal's existence; in mammals they are circular biconcave disks (except in the camel tribe, the corpuscles of which are oval), and in post-embryonic life without a nucleus; nor do they possess a cell-wall. The red cells vary in size in different groups and

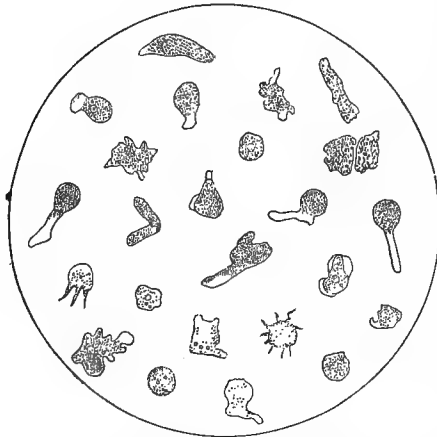

FIG. 143.—Leucocytes of human blood, showing amoeboid movements (Landois). These movements are not normally in the blood-vessels so marked as pictured here, so that the figure represents an extreme case.

sub-groups of animals, being smaller the higher the place the animal occupies, as a general rule: thus, they are very large in vertebrates below mammals, in some cases being almost

visible to the unaided eye, while in the whole class of mammals they are very minute; their numbers also in this group are vastly greater than in others lower in the scale.

The average size in man is $\frac{1}{3200}$ inch (.0077 mm.) and the number in a cubic millimetre of the blood about 5,000,000 for the male and 500,000 less for the female, which would furnish about 250,000,000,000 in a pound of blood. It will be understood that averages only are spoken of, as all kinds of variations occur, some of which will be referred to later, and their significance explained.

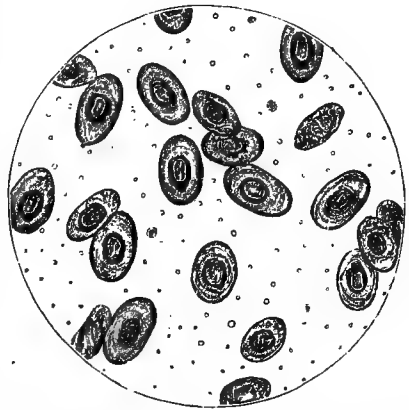

FIG. 144.—Photograph of colored corpuscles of frog. 1×370 . (After Flint.)

Under the microscope the blood of vertebrates is seen to owe its color to the cells chiefly, and, so far as the red goes, almost wholly. Corpuscles when seen singly are never of the deep red, however, of the blood as a whole, but rather a yellowish red, the tinge varying somewhat with the class of animals from which the specimen has been taken.

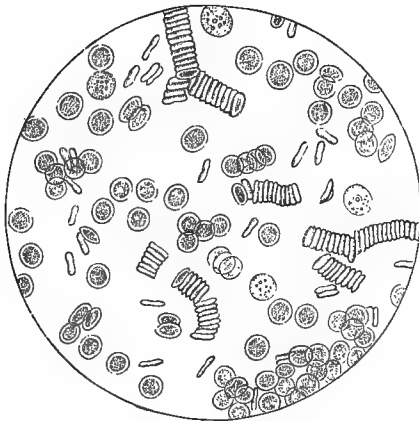

FIG. 145.—Corpuscles from human subject (Funke). A few colorless corpuscles are seen among the colored disks, which are many of them arranged in *rouleaux*.

Certain other *morphological* elements found in mammalian blood deserve brief mention, though their significance is as yet a matter of much dispute:

1. The blood - plates (*plaques*, *hæmatoblasts*, *third element*), very small, colorless, biconcave disks, which are deposited in great numbers on any thread or similar foreign body introduced into the circulation, and rapidly break up when blood is shed.

2. On a slide of blood that has been prepared for some little

time, aggregations of very minute granules (*elementary granules*) may be seen. These are supposed to represent the disintegrating protoplasm of the corpuscles.

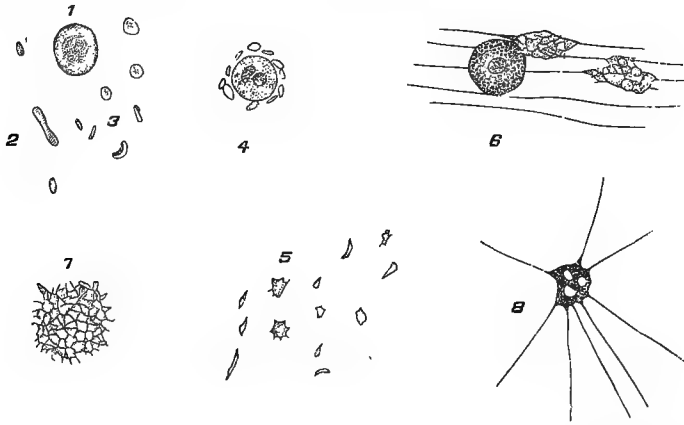

FIG. 146.—Blood-plaques and their derivatives (Landois, after Bizzozero and Laker). 1, red blood-corpuscles on the flat; 2, from the side; 3, unchanged blood-plaques; 4, lymph-corpuscle surrounded with blood-plaques; 5, blood-plaques variously altered; 6, lymph-corpuscle with two masses of fused blood-plaques and threads of fibrin; 7, group of blood-plaques fused or run together; 8, similar small mass of partially dissolved blood-plaques with fibrils of fibrin.

The pale or colorless corpuscles are very few in number in mammals compared with the red, there being on the average only about 1 in 400 to 600, though they become much more numerous after a meal. They are granular in appearance, and possess one or more nuclei, which are not, however, readily seen in all cases without the use of reagents. They are characterized by greater size, a globular form, the lack of pigment, and the tendency to amœboid movements, which latter may be exaggerated in disordered conditions of the blood, or when the blood is withdrawn and observed under artificial conditions. It will be understood that these cells (*leucocytes*) are not confined to the blood, but abound in lymph and other fluids. They are the representatives of the primitive cells of the embryo, as is shown by their tendency (like ova) to throw out processes, develop into higher forms, etc. In behavior they strongly suggest *Amœba* and kindred forms.

We may, then, say that in all invertebrates the blood, when it exists, consists of a plasma (*liquor sanguinis*), in which float the cellular elements which are colorless; and that in vertebrates in addition there are colored cells which are always nucleated at some period of their existence. The colorless cells

are globular masses of protoplasm, containing one or more nuclei, and with the general character of amœboid organisms.

THE HISTORY OF THE BLOOD-CELLS.

We have already seen that the blood and the vessels in which it flows have a common origin in the mesoblastic cells of the embryo chick; the same applies to mammals and lower groups. The main facts may be grouped under two headings: 1. Development of the blood-corpuses during embryonic life. 2. Development of the corpuscles in post-embryonic life.

In the bird and the mammal, cells of the mesoblast in the *area opaca* give off processes which unite; later they become hollowed out (*vacuolated*), and thus form capillaries. At the same time the nuclei of these cells multiply (*proliferate*), gather small portions of the protoplasm of the main cells about them, become colored, and thus form the nucleated corpuscles of the embryo. This, or a similar process, is known to occur in some animals (*rat*) after birth; but in the human fœtus there is a gradual decline in the number of nucleated cells found free in the blood, and at birth they are very rare, which is probably the case with most mammals.

While the origin of the red cells, as above described, may be regarded as the earliest and most general, it is not their exclusive source.

When the *liver* has been formed this organ seems to carry on a development begun in the *spleen*, for the nucleated but as yet colorless cells formed in the spleen seem to become pigmented in the liver.

There is also evidence that colored corpuscles may arise by endogenous formation in the lymphatic glands.

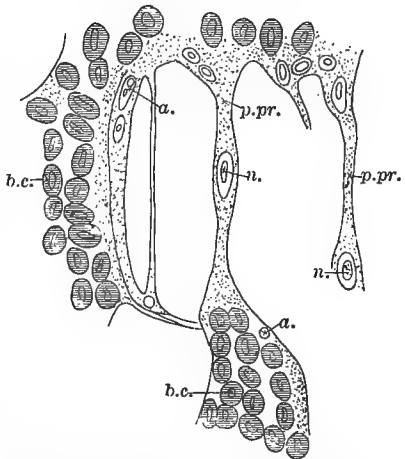

FIG. 147.—Surface view from below of a small portion of posterior end of pellucid area of a chick of thirty-six hours, 1×400 (Foster and Balfour). *b. c.* blood-corpuses; *a.* nuclei, which subsequently become nuclei of cells forming walls of blood-vessels; *p. pr.* protoplasmic processes, containing nuclei with large nucleoli, *n.*

There is no doubt that the greater number of the non-nucleated corpuscles are derived from the nucleated forms.

The post-embryonic development of colored corpuscles is naturally less understood from the greater difficulties attend-

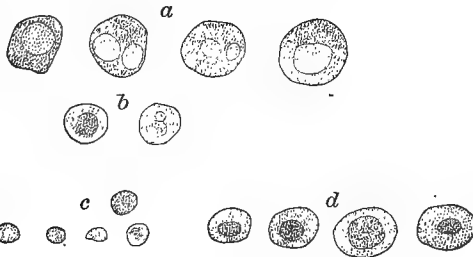

FIG. 148.

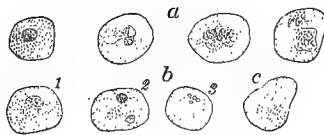

FIG. 149.



FIG. 150.

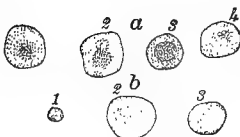

FIG. 151.

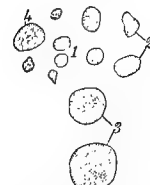

FIG. 152.

FIG. 148.—Cell elements of red marrow. *a*, large granular marrow cells; *b*, smaller, more vesicular cells; *c*, free nuclei, or small lymphoid cells, some of which may be even surrounded with a delicate rim of protoplasm; *d*, nucleated red corpuscles of the bone marrow.

FIG. 149.—Nucleated red cells of marrow, illustrating mode of development into the ordinary non-nucleated red corpuscles. *a*, common forms of the colored nucleated cells of red marrow; *b*, 1, 2, 3, gradual disappearance of the nucleus; *c*, large non-nucleated red corpuscle resembling 2 and 3 of *b*, in all respects save in the absence of any trace of nucleus.

FIG. 150.—Nucleated red corpuscles, illustrating the migration of the nucleus from the cell, a process not unfrequently seen in the red marrow.

FIG. 151.—Blood of embryo of four months. *a*, 1, 2, 3, 4, nucleated red corpuscles. In 4 the same granular disintegrated appearance of the nucleus as is noted in marrow cells. *b*, 1, microcyte; 2, megalocyte; 3, ordinary red corpuscle.

FIG. 152.—From spleen. 1, blood-plaques, colorless and varying a little in size; 2, two microcytes of a deep-red color; 3, two ordinary red corpuscles; 4, a solid, translucent, lymphoid cell or free nucleus. (Figs. 148-152, after Osler.)

ing its investigation. The following may be regarded as a summary of the chief facts or rather opinions on this subject:

1. From the colorless cells; though, whether the nucleus disappears, or remains to form the chief part of the cell and become pigmented, is undetermined.

2. From peculiar cells of the red marrow of the bones (head, trunk, etc.), though there is also some doubt as to whether the

nuclei of these cells remain or not; but as all grades of transition forms have been found in the bone-marrow; since anæmia occurs in disease of bones; since the bone-marrow has been found in an unusually active condition after hæmorrhage and under other circumstances demanding a rapid replacement of lost cells—there seems to be little room for doubt that in the adult the red marrow of the bones is the chief site of the development of red corpuscles. It is not, however, the only one, for under peculiar stress of need even the lymphatic glands produce red cells, and the latter have been seen to be budded off from the spleen in a young animal (*kid*).

The colorless cells of the blood first arise as migrated undifferentiated remnants of the early embryonic cell colonies. That they remain such is seen by their physiological behavior, to be considered a little later. Afterward they are chiefly produced from a peculiar form of connective tissue known as leucocytogenic, and which is gathered into organs, the chief function of which (lymphatic glands) is to produce these cells, though this tissue is rather widely distributed in the mammalian body in other forms than these.

Summary.—The student may, with considerable certainty, consider the colorless corpuscle of the blood as the most primitive; the red, derived either from the white or some form of more specialized cell; the nucleated, as the earlier and more youthful form of the colored corpuscle, which may in some groups of vertebrates be replaced by a more specialized (or degraded?) non-nucleated form mostly derived directly from the former; that in the first instance the blood-vessels and blood arise simultaneously in the mesoblastic embryonic tissue; that such an origin may exist after birth, either normally in some mammals or under unusual functional need; that the red marrow is the chief birthplace of colored cells in adult life; that the spleen, liver, lymphatic glands, and other tissues of similar structure contribute in a less degree to the development of the red corpuscles; and that the last mentioned organs are the chief producers of the colorless amœboid blood-cells.

Finally, it is well to remember that Nature's resources in this, as in many other cases, are numerous, and that her mode of procedure is not invariable; and that, if one road to an end is blocked, another is taken.

The Decline and Death of the Blood-Cells.—The blood-corpuscles, like other cells, have a limited duration, with the usual chapters in a biological history of rise, maturity, and decay. There is

reason to believe that the red cells do not live longer than a few weeks at most. The red cells, in various degrees of disorganization, have been seen within the white cells (*phagocytes*), and the related cells of the spleen, liver, bone-marrow, etc. In fact, these cells, by virtue of retained ancestral (*amœboid*) qualities, have devoured the weakened, dying red cells. It seems to be a case of survival of the fittest. It is further known that abundance of pigment containing iron is found in both spleen and liver; and there seems to be no good reason for doubting that the various pigments of the secretions of the body (*urine, bile, etc.*) are derived from the universal pigment of the blood. These coloring matters, then, are to be regarded as the excreta in the first instance of cells behaving like amœboids, and later as the elaborations of certain others in the kidney and elsewhere, the special function of which is to get rid of waste products. The birth-rate and the death-rate of the blood-cells must be in close relation to each other in health; and some of the gravest disturbances arise from decided changes in the normal proportions of the cells (*anæmia, leucocythemia*).

Both the red and white corpuscles show, like all other cells of the organism, alterations corresponding to changes in the surrounding conditions. The blood may be withdrawn and its cells more readily observed than those of most tissues; so that the study of the influence of temperature, feeding of the leucocytes, and the action of reagents in both classes of cells is both of practical importance and theoretic interest, and will well repay the student for the outlay in time and labor, if attention is directed chiefly to the results and the lessons they convey, and not, as too commonly happens, principally to the methods of manipulation.

The Chemical Composition of the Blood.—Blood has a decided but faint alkaline reaction, owing chiefly to the presence of sodium biphosphate (Na_2HPO_4), a saline taste, and a faint odor characteristic of the animal group to which it belongs, owing probably to volatile fatty acids. The specific gravity of blood varies between 1045 and 1075, with a mean of 1055; the specific gravity of the corpuscles being about 1105 and of the plasma 1027. This difference explains the sinking of the corpuscles in blood withdrawn from the vessels and kept quiet. Much the same difficulties are encountered in attempts at the exact determination of the chemical composition of the blood, as in the case of other living tissues. Plasma alters its phys-

ical and its chemical composition, to what extent is not exactly known, when removed from the body.

Composition of Serum.—The fluid remaining after coagulation of the blood can, of course, be examined chemically with considerable thoroughness and confidence.

By far the greater part of serum consists of water; thus, it has been estimated that of 100 parts the following statement will represent fairly well the proportional composition:

Water.....	90 parts;
Proteids.....	8 to 9 “
Salines, fats, and extractives (small in quantity and not readily obtained free).....	1 to 2 parts.

The *proteids* are made up of two substances which can be distinguished by solubility, temperature at which coagulation occurs, etc., known as *paraglobulin* and *serum-albumen*, and which may exist in equal amount.

It is not possible, of course, to say whether these substances exist as such in the living blood-plasma or not.

The *fats* are very variable in quantity in serum, depending on a corresponding variability in the plasma, in which they would be naturally found in greatest abundance after a meal. They exist as neutral stearin, palmitin, olein, and as soaps.

The principal *extractives* found are urea, creatin, and allied bodies, sugar, and lactic acid. Serum in most animals contains more of sodium salts than the corpuscles, while the latter in man and some other mammals contain a preponderating quantity of potassium compounds.

The principal *salts* of serum are sodium chloride, sodium bicarbonate, sodium sulphate, and phosphate in smaller quantity, as also of calcium and magnesium phosphate, with rather more of potassium chloride.

It is highly probable that this proportion also represents moderately well the composition of plasma, which is, of course, from a physiological point of view, the important matter.

The Composition of the Corpuscles.—Taken together, the different forms of blood-cells make up from one third to nearly one half the weight of the blood, and of this the red corpuscles may be considered as constituting nearly the whole.

The colorless cells are known to contain fats and glycogen, which, with salts, we may believe exist in the living cells, and, in addition to the proteids, into which protoplasm resolves it-

self upon the disorganization that constitutes its dying, lecithin, protagon, and other extractives.

The prominent chemical fact connected with the red corpuscles is their being composed in great part of a peculiar colored proteid compound containing iron.

This will be fully considered later; but, in the mean time, we may state that the hæmoglobin is itself infiltrated into the meshes or framework (*stroma*) of the corpuscle, which latter seems to be composed of a member of the globulin class, so well characterized by solubility in weak saline solutions.

The following tabular statement represents the relative proportions in 100 parts of the dried organic matter of the red corpuscles:

Hæmoglobin.....	90·54
Proteids.....	8·67
Lecithin.....	0·54
Cholesterin.....	0·25
	100·00

The quantity of salts is very small, less than one per cent (*inorganic*).

So much for the results of our analyses; but when we consider the part the blood plays in the economy of the body, it must appear that, since the life-work of every cell expresses itself through this fluid, both as to what it removes and what it adds, the blood can not for any two successive moments be of precisely the same composition; yet the departures from a normal standard must be kept within very narrow limits, otherwise derangement or possibly death results. We think that, before we have concluded the study of the various organs of the body, it will appear to the student, as it does to the writer, that it is highly probable that there are great numbers of compounds in the blood, either of a character unknown as yet to our chemistry, or in such small quantity that they elude detection by our methods; and we may add that we believe the same holds for all the fluids of the body. The complexity of vital processes is great beyond our comprehension.

It must be especially borne in mind that all the pabulum for every cell, however varied its needs, can be derived from the blood alone; or, as we shall show presently, strictly speaking from the lymph, a sort of middle-man between the blood and the tissues.

The Quantity and the Distribution of the Blood.—Any attempt

to estimate the total quantity of blood in the body of an animal by bleeding is highly fallacious for various reasons. It is impossible to withdraw all the blood from the vessels by merely opening even the largest of them, and, if it were, the original quantity would be augmented by fluid absorbed into them during the very act. No method has as yet been devised that is free from objection, hence the conclusions arrived at as to the total quantity of blood are not in accord; and in the nature of the case no accurate estimate can be made, but about one thirteenth to one fourteenth may be taken as a fair average; so that in a man of one hundred and forty pounds weight there should be about ten pounds of blood; but, of course, this will vary with every hour of the day and will be greatest after a meal.

As an example of the methods referred to, we give Welcker's, which is briefly as follows: The animal is bled to death from the carotid; a sample of the defibrinated blood (1 cc.) is saturated with carbon monoxide (CO), which gives a permanent red color; this diluted with 500 cc. of water furnishes a standard sample. The blood-vessels of the animal are washed out with a 6 per cent solution of common salt, but the out-flowing stream is colorless; to this is added the fluid obtained by chopping up the tissues of the animal, steeping, washing out, and pressing. The whole is diluted to give the color of the standard solution, from which the amount of blood in this mixture may be calculated, since every 500 cc. answers to 1 cc. of blood; the blood obtained by bleeding can, of course, be accurately measured.

It would be slightly more accurate to make the diluted blood of the animal operated upon the standard without treatment with carbon monoxide.

Such a method, though the best yet devised, is open to objection also, as will occur to most readers.

The relative quantities of blood in different parts of the body have been estimated to be as follows:

Liver.....	one fourth.
Skeletal muscles.....	“ “
Heart, lungs, large arteries, and veins.	“ “
Other structures.....	“ “

The significance of this distribution will appear later.

The Coagulation of the Blood.—When blood is removed from its accustomed channels, it undergoes a marked chemical and physical change, termed clotting or coagulation. In the case of most vertebrates, almost as soon as the blood leaves the ves-

sels it begins to thicken, and gradually acquires a consistence that may be compared to that of jelly, so that it can no longer be poured from the containing vessel. Though some have recognized different stages as distinct, and named them, we think that an unprejudiced observer might fail to see that there were any well-marked appearances occurring invariably at the same moment, or with resting stages in the process, as with the development of ova.

After coagulation has reduced the blood to a condition in which it is no longer diffuent, minute drops of a thin fluid gradually show themselves, exuding from the main mass, faintly colored, but never red, if the vessel in which the clot has formed has been kept quiet so that the red corpuscles have not been disturbed; and later it may be noticed that the main mass is beginning to sink in the center (*cupping*); and in the blood of certain animals, as the horse, which clots slowly, the upper part of the coagulum (*crassamentum*) appears of a lighter color, owing, as microscopic examination shows, to the relative fewness of red corpuscles. This is the buffy-coat, or, as it occurs in inflammatory conditions of the blood, was termed by older writers, the *crusta phlogistica*. It is to be distinguished from the lighter red of certain parts of a clot, often the result of greater exposure to the air and more complete oxidation in consequence. The white blood-cells, being lighter than the red, are also more abundant in the upper part of the clot (*buffy-coat*). If the coagulation of a drop of blood withdrawn from one's own finger be watched under the microscope, the red corpuscles may be seen to run into heaps, like rows of coins lying against each other (*rouleaux*, Fig. 145), and threads of the greatest fineness are observed to radiate throughout the mass, gradually increasing in number, and, at last, including the whole in a meshwork which slowly contracts. It is the formation of this *fibrin* which is the essential factor in clotting; the inclusion of the blood-cells and the extrusion of the serum naturally resulting from its formation and contraction.

The great mass of every clot consists, however, of corpuscles; the quantity of fibrin, though variable, not amounting to more usually than about '2 per cent in mammals. The formation of the clot does not occupy more than a few minutes (two to seven) in most mammals, including man, but its contraction lasts a very considerable time, so that serum may continue to exude from the clot for hours. It is thus seen that, instead of the plasma and corpuscles of the blood as it exists within the

living body, coagulation has resulted in the formation of two new products—serum and fibrin—differing both physically and chemically. These facts may be put in tabular form thus:

Blood as it flows in the vessels.	{	Liquor sanguinis (plasma). Corpuscles.
Blood after co- agulation.	{	Coagulum { Fibrin. Corpuscles. Serum.

As fibrin may be seen to arise in the form of threads, under the microscope, in coagulating blood, and since no trace of it in any form has been detected in the plasma, and the process can be accounted for otherwise, it seems unjustifiable to assume that fibrin exists preformed in the blood, or arises in any way prior to actual coagulation.

Fibrin belongs to the class of bodies known as proteids, and can be distinguished from the other subdivisions of this group of substances by certain chemical as well as physical characteristics. It is insoluble in water and in solutions of sodium chloride; insoluble in hydrochloric acid, though it swells in this menstruum.

It may be whipped out from the freshly shed blood by a bundle of twigs, wires, or other similar arrangement presenting a considerable extent of surface; and when washed free from red blood-cells presents itself as a white, stringy, tough substance, admirably adapted to retain anything entangled in its meshes. If fibrin does not exist in the plasma, or does not arise directly as such in the clot, it must have some antecedents already existing as its immediate factors in the plasma, either before or after it is shed.

We shall here present certain facts, and examine the conclusions drawn from them afterward:

1. Blood may be prevented from coagulating by receiving it in a solution of a neutral salt (*magnesium sulphate*, etc.), and upon certain chemical treatment precipitate a body which may be obtained by additional manipulation as a white, flaky substance, that may be shown not to be fibrin, but which will clot and so give rise to this body. Such is the *plasmine* of Denis.

2. By treatment of plasma with solid sodium chloride, two bodies with different coagulating points, but belonging to the same group of proteids (*globulins*, soluble in saline solutions), may be obtained, denominated *paraglobulin* and *fibrinogen* respectively.

3. Paraglobulin may be obtained from serum also, and fibrinogen from certain fluids occurring normally (*pericardial, pleural, etc.*) or abnormally (*hydrocele fluid*).

4. Serum added to these fluids sometimes induces coagulation.

5. Coagulation may occur spontaneously in the above-mentioned fluids when removed from the natural seat of their formation.

6. A preparation, made by extracting serum or the whipped (defibrinated) blood added to specimens of certain fluids when they do not coagulate spontaneously, as hydrocele fluid, often induces speedy clotting.

7. This extract (*fibrin-ferment*) loses its properties on boiling, and a very small quantity suffices in most cases to induce the result. For these and other reasons this agent has been classed among bodies known as *unorganized ferments*, which are distinguished by the following properties:

They exert their influence only under well-defined circumstances, among which is a certain narrow range of temperature, about blood-heat, being most favorable for their action. They do not seem to enter themselves into the resulting product, but act from without as it were (catalytic action), hence a very small quantity suffices to effect the result. In all cases they are destroyed by boiling, though they bear exposure for a limited period to a freezing temperature.

The conclusions drawn from the above statements are these: 1. Coagulation results from the action of a fibrin-ferment on fibrinogen and paraglobulin. 2. Coagulation results from the action of a fibrin-ferment on fibrinogen alone. 3. Denis plasmine is made up of fibrinogen and paraglobulin.

From observations, microscopic and other, it has been concluded that the corpuscles play an important part in coagulation by furnishing the fibrin-ferment; but the greatest diversity of opinion prevails as to which one of the morphological elements of the blood furnishes the ferment, for each one of them has been advocated as the exclusive source of this ferment by different observers.

The above conclusions do not seem to us to follow *necessarily* from the premises. It might be true that a solution of fibrinogen, on having fibrin-ferment added to it, would clot, and yet it would not follow that such was the process of coagulation in the blood itself. All specimens of hydrocele fluid, and similar ones not spontaneously coagulable, do not clot when

fibrin-ferment is added. Moreover, fibrin-ferment has not been isolated as an absolutely distinct chemical individual, free from all impurities.

Because fibrinogen and paraglobulin give rise, under certain circumstances (it is asserted), to fibrin, and since plasmine acts likewise, it does not follow that plasmine contains these bodies. Further, it is stated that in the blood of crustaceans the clot arises from the corpuscles chiefly, which run together and blend into a homogeneous mass. The fibrin so called in such a case differs not a little chemically, it could probably be shown, if our tests were delicate enough to discover it, from that which is denominated fibrin in other cases. "Fibrin-ferment" seems to have been used to cover much ignorance and unnecessary invention, as we shall endeavor to show later on; and we can not but regard the reasoning in regard to the coagulation of the blood as evidence of an erroneous interpretation of certain facts on the one hand, and a large oversight of additional facts on the other hand.

In the mean time we turn to certain well-known phenomena which bear a clear interpretation: 1. The blood remains fluid in the vessels for some time after the death of an animal; clots first in the larger vessels, and keeps fluid longest in the smaller veins. 2. The blood in the heart of a cold-blooded animal, as that of the frog or turtle, which will beat for days after the animal itself is dead, maintains its fluidity, but clots at once on removal. 3. The blood inclosed in a large vein removed between ligatures does not coagulate for many hours (twenty-four to forty-eight).

There are also facts of an opposite nature, thus: 1. When blood passes from a blood-vessel into one of the cavities of the body, it clots as if shed externally. 2. If a ligature be passed tightly around an artery so as to rupture the elastic coat, coagulation ensues at the site of the ligature. 3. A similar clotting results when the inner coat of a blood-vessel is diseased, as in the case of roughening of the valves of the heart from inflammation, or the changes that give rise to aneurism of an artery. 4. A wire, thread, or other like foreign body, introduced into a vein, is speedily covered with fibrin.

These facts, and others of like character, have been interpreted as indicating that the living tissues of the blood-vessel or heart in some way prevent coagulation, but as to details there is difference of opinion. Some believe that the fibrin-ferment (essential to coagulation, according to their view) is formed by

the corpuscles constantly, but in the above cases and during life is not effective because at once removed by the vessel walls; while others are of opinion that the living cells composing these walls prevent the formation of the ferment.

Even when injected into the blood-vessels, fibrin-ferment does not induce coagulation, nor does the constant death of the blood-cells, supposed thus to give rise to this substance, cause clotting.

But the truth is, there is no necessity for all these somewhat artificial views, which seem to us to smack more of the laboratory than of nature.

We would explain the whole matter somewhat thus: What the blood is in chemical composition and other properties from moment to moment is the result of the complicated interaction of all the various cells and tissues of the body. Any one of these, departing from its normal behavior, at once affects the blood; but health implies a constant effort toward a certain equilibrium, never actually reached but always being striven after by the whole organism. The blood can no more maintain its vital equilibrium, or exist as a living tissue out of its usual environment, than any other tissue. But the exact circumstances under which it may become disorganized, or die, are legion; hence, it is not likely that the blood always clots in the same way in all groups of animals, or even in the same group. The *normal* disorganization or death of the tissue results in clotting; but there may be death without clotting, as when the blood is frozen, in various diseases, etc.

To say that fibrin is formed during coagulation expresses in a crude way a certain fact, or rather the resultant of many facts. To explain: When gunpowder and certain other explosives are decomposed, the result is the production of certain gases. If we knew these gases and their mode of composition but in the vaguest way, we should be in much the same position as we are in regard to the coagulation of the blood.

There is no difficulty in understanding why the blood does not clot in the vessels after death so long as they live, nor why it does coagulate upon foreign bodies introduced into the bloodstream. So long as it exists under the very conditions under which it began its being, there is no reason why the blood should become disorganized (clot). It would be marvelous if it did clot, for then we could not understand how it could ever have been developed as a tissue at all. It is just as reasonable

to ask why does not a muscle-cell become rigid (clot) in the body during life.

Probably in no field in physiology has so much work been done with so little profit as in the one we are now discussing; and, as we venture to think, owing to a misconception of the real nature of the problem. We can understand the *practical* importance of determining what circumstances favor coagulation or retard it, both within the vessels and without them; but from a theoretical point of view the subject has been exalted out of all proportion to its importance; and we should not have dwelt so long upon it, or burdened the student with some of the theories we have stated, except in deference to the views held by so many physiologists.

It is not surprising that, looking at the subject with a distorted mental perspective, one theory should have replaced another with such rapidity. It is, however, of practical importance to the medical student to remember some of the factors that hasten or retard, as the case may be, the coagulation of the blood. Coagulation is favored by gentle movement, contact with foreign bodies, a temperature of about 38° to 40° C., addition of a small quantity of water, free access of oxygen, etc. The process is retarded by a low temperature, addition of abundance of neutral salts, extract of the mouth of the leech, peptone, much water, alkalies, and many other substances. The excess of carbonic anhydride and diminution of oxygen, seem to be the cause of the slower coagulation of venous blood, hence the blood long remains fluid in animals asphyxiated. A little reflection suffices to explain the action of most of the factors enumerated. Any cause which hastens the disintegration of the blood-cells must accelerate coagulation; chemical changes underlie the changes in this as in all other cases of vital action. Slowing of the blood-stream to any appreciable extent likewise favors clotting, hence the explanation of the success of the treatment of aneurisms by pressure. It is plain that in all such cases the normal relations between the blood and the tissues are disturbed, and, when this reaches a certain point, death (coagulation) ensues, as with any other tissue.

Clinical and Pathological.—The changes in the blood that characterize certain abnormal states are highly instructive. If blood from an animal be injected into the veins of one of another species, the death of the latter often results, owing to non-adaptation to the blood already in the vessels, and to the tissues of the creature generally. The corpuscles break up—the change

of conditions has been too great. Deficiency in the quantity of the blood as a whole (*oligæmia*) causes serious change in the functions of the body; but that a hæmorrhage of considerable extent can be so quickly recovered from by many persons, speaks much for the recuperative power of the blood-forming tissues. Various kinds of disturbances in these blood-forming organs result in either deficiency or excess of the blood-cells, and in some cases the appearance of unusual forms of corpuscles.

Anæmia may arise from a deficiency either in the numbers or the quality of the red cells; they may be too few, deficient

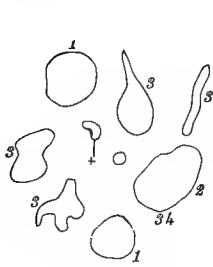

FIG. 153.

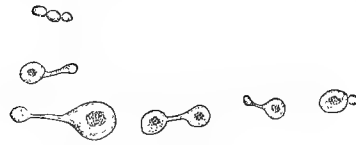

FIG. 154.



FIG. 155.

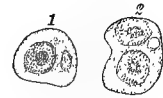

FIG. 156.

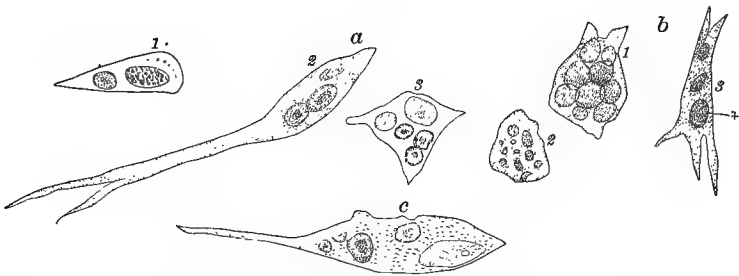

FIG. 157.

FIG. 153.—Outlines of red corpuscles in a case of profound anæmia. 1, 1, normal corpuscles; 2, large red corpuscle—megalocyte; 3, 3, very irregular forms—poikilocytes; 4, very small, deep-red corpuscles—microcytes.

FIG. 154.—Origin of microcytes from red corpuscles by process of budding and fission. Specimen from red marrow.

FIG. 155.—Nucleated red blood-corpuscles from blood in case of leukaemia.

FIG. 156.—Corpuscles containing red blood-corpuscles. 1, from blood of child at term; 2, from blood of a leukæmic patient.

FIG. 157.—a, 1, 2, 3, spleen-cells containing red blood-corpuscles. b, from marrow; 1, cell containing nine red corpuscles; 2, cell with reddish granular pigment; 3, fusiform cell containing a single red corpuscle. c, connective-tissue corpuscle from subcutaneous tissue of young rat, showing the intracellular development of red blood-corpuscles. (Figs. 153-157, after Osler.)

in size, or lacking in the normal quantity of hæmoglobin. In one form (*pernicious anæmia*), which often proves fatal, a variety of forms of the red blood-cells may appear in the blood-stream; some may be very small, some larger than usual, others

nucleated, etc. Again, the white cells may be so multiplied that the blood may bear in extreme cases a resemblance to milk.

In these cases there has been found associated an unusual condition of the bone-marrow, the lymphatic glands, the spleen, and, some have thought, of other parts.

The excessive action of these organs results in the production and discharge into the blood-current of cells that are immature and embryonic in character. This seems to us an example of a *reversion* to an earlier condition. It is instructive also in that the facts point to a possible seat of origin of the cells in the adult, and, taken in connection with other facts, we may say, to their normal source. These blood-producing organs, having too much to do in disease, do their work badly—it is incomplete.

Although the evidence, from experiment, to show that the nervous system in mammals, and especially in man, has an influence over the formation and fate of the blood generally, is scanty, there can be little doubt that such is the case, when we take into account instances that frequently fall under the notice of physicians. Certain forms of anæmia have followed so directly upon emotional shocks, excessive mental work and worry, as to leave no uncertainty of a connection between these and the changes in the blood; and the former must, of course, have acted chiefly if not solely through the nervous system.

It will thus be apparent that the facts of disease are in harmony with the views we have been enforcing in regard to the blood, which we may now briefly recapitulate.

Summary.—Blood may be regarded as a tissue, with a fluid matrix, in which float cell-contents. Like other tissues, it has its phases of development, including origin, maturity, and death. The colorless cells of the blood may be considered as original undifferentiated embryo cells, which retain their primitive character; the non-nucleated red cells of the adult are the mature form of nucleated cells that in the first instance are colorless, and arise from a variety of tissues, and which in certain diseases do not mature, but remain, as they originally were at first, nucleated. When the red cells are no longer fitted to discharge their functions, they are in some instances taken up by amœboid organisms (cells) of the spleen, liver, etc.

The chief function of the red corpuscles is to convey oxygen; of the white, to develop as required into some more differentiated form of tissue, act as porters of food-material, and

probably to take up the work of many other kinds of cells when the needs of the economy demand it. The fluid matrix or plasma furnishes the lymph by which the tissues are directly nourished, and serves as a means of transport for the cells of the blood.

The chemical composition of the blood is highly complex, in accordance with the function it discharges as the reservoir whence the varied needs of the tissues are supplied; and the immediate receptacle (together with the lymph) of the entire waste of the body; but the greater number of substances exist in very minute quantities. The blood must be maintained of a certain composition, varying only within narrow limits, in order that neither the other tissues nor itself may suffer.

The normal disorganization of the blood results in coagulation, by which a substance, proteid in nature, known as fibrin, is formed, the antecedents of which are probably very variable throughout the animal kingdom, and are likely so even in the same group of animals, under different circumstances; and a substance abounding in proteids (as does also plasma), known as serum, squeezed from the clot by the contracting fibrin. It represents the altered plasma.

Certain well-known inorganic salts enter into the composition of the blood—both plasma and corpuscles—but the principal constituent of the red corpuscles is a pigmented, ferruginous proteid capable of crystallization, termed hæmoglobin. It is respiratory in function.

THE CONTRACTILE TISSUES.

That contractility, which is a fundamental property in some degree of all protoplasm, becoming pronounced and definite, giving rise to movements the character of which can be predicted with certainty once the form of the tissue is known, finds its highest manifestation in muscular tissue.

Very briefly, this tissue is made up of cells which may be either elongated, fusiform, nucleated, finely striated lengthwise, but non-striated transversely, united by a homogeneous cement substance, the whole constituting non-striated or involuntary muscle; or, long nucleated fibers transversely striped, covered with an elastic sheath of extreme thinness, bound together into small bundles by a delicate connective tissue, these again into larger ones, till what is commonly known as a "muscle"

is formed. This, in the higher vertebrates, ends in tough, inelastic extremities suitable for attachment to the levers it may be required to move (*bones*).

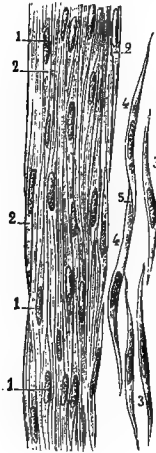

FIG. 158.

FIG. 158.—Muscular fibers from the urinary bladder of the human subject. 1×200 . (Sappey.) 1, 1, 1, nuclei; 2, 2, 2, borders of some of the fibers; 3, 3, isolated fibers; 4, 4, two fibers joined together at 5.

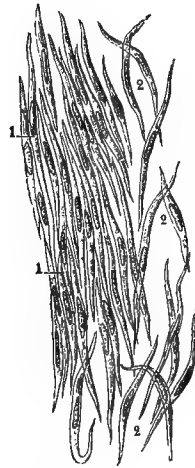

FIG. 159.

FIG. 159.—Muscular fibers from the aorta of the calf. 1×200 . (Sappey.) 1, 1, fibers joined with each other; 2, 2, 2, isolated fibers.

Comparative.—The lowest animal forms possess the power of movement, which, as we have seen in *Amœba*, is a result rather of a groping after food; and takes place in a direction it is impossible to predict, though no doubt regulated by laws definite enough, if our knowledge were equal to the task of defining them.

Those ciliary movements among the infusorians, connected with locomotion and the capture of food, are examples of a protoplasmic rhythm of wonderful beauty and simplicity.

Muscular tissue proper first appears in the *Cœlenterata*, but not as a wholly independent tissue in all cases. In many cœlenterates cells exist, the lower part of which alone forms a delicate muscular fiber, while the superficial portion (*myoblast*), composing the body of the cell, may be ciliated and is not contractile in any special



FIG. 160.—Myoblasts of a jelly-fish, the *Mediterranean Aurelia* (Claus).

sense. The non-striped muscle-cells are most abundant among the invertebrates, though found in the viscera and a few other parts of vertebrates. This form is plainly the simpler and more primitive. The voluntary muscles are of the striped variety in articulates and some other invertebrate groups and in all vertebrates; and there seems to be some relation between the size of the muscle-fiber and the functional power of the tissue—the finer they are and the better supplied with blood, two constant relations, the greater the contractility.

Whether a single smooth muscle-cell, a striped fiber (*cell*), or a collection of the latter (*muscle*) be observed, the invariable result of contraction is a change of shape which is perfectly definite, the long diameter of the cell or muscle becoming shorter, and the short diameter longer.

Ciliary Movements.—This subject has been already considered briefly in connection with some of the lower forms of life presented for study.

It is to be noted that there is a gradual replacement of this form of action by that of muscle as we ascend the animal scale; it is, however, retained even in the highest animals in the discharge of functions analogous to those it fulfills in the invertebrates.

Thus, in *Vorticella*, we saw that the ciliary movements of the peristome caused currents that carried in all sorts of particles, including food. In a creature so high in the scale as the frog we find the alimentary tract ciliated; and in man himself a portion of the respiratory tract is provided with ciliated cells concerned with assisting gaseous interchange, a matter of the highest importance to the well-being of the mammal. As before indicated, ciliated cells are found in the female generative organs, where they play a part already explained.

It is a matter of no little significance from an evolutionary point of view, that ciliated cells are more widely distributed in the foetus than in the adult human subject.

As would be expected, the movements of cilia are affected by a variety of circumstances and reagents: thus, they are quickened by bile, acids, alkalies, alcohol, elevation of temperature up to about 40° C., etc.; retarded by cold, carbonic anhydride, ether, chloroform, etc.

In some cases their action may be arrested and re-established by treatment with reagents, or it may recommence without such assistance. All this seems to point to ciliary action as falling under the laws governing the movements of protoplasm

in general. It is important to bear in mind that ciliary action may go on in the cells of a tissue completely isolated from the animal to which it belongs, and though influenced, as just explained, by the surroundings, that the movement is essentially automatic, that is, independent of any special stimulus, in which respect it differs a good deal from voluntary muscle, which usually, if not always, contracts only when stimulated.

The lines along which the *evolution* of the contractile tissues has proceeded from the indefinite outflowings and withdrawals of the substance of *Amœba* up to the highly specialized movements of a striped muscle-cell are not all clearly marked out; but even the few facts mentioned above suffice to show gradation, intermediate forms. A similar law is involved in the muscular contractility manifested by cells with other functions. The automatic (self-originated, independent largely of a stimulus) rhythm suggestive of ciliary movement, more manifest in the earlier developed smooth muscle than in the voluntary striped muscle of higher vertebrates, indicating further by the regularity with which certain organs act in which this smooth muscular tissue is predominant, a relationship to ciliary movement something in common as to origin—in a word, an evolution. And if this be borne in mind, we believe many facts will appear in a new light, and be invested with a breadth of meaning they would not otherwise possess.

The Irritability of Muscle and Nerve.—An animal, as a frog, deprived of its brain, will remain motionless till its tissues have died, unless the animal be in some way stimulated. If a muscle be isolated from the body with the nerve to which it belongs, it will also remain passive; but, if an electric current be passed into it, if it be pricked, pinched, touched with a hot body or with certain chemical reagents,

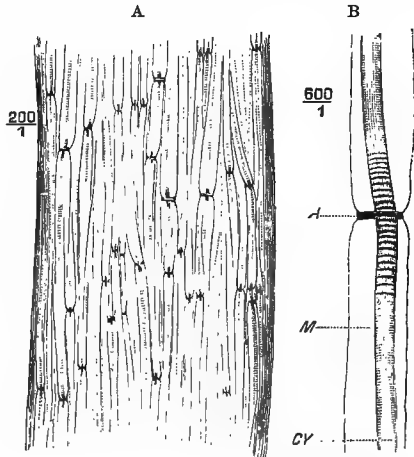

FIG. 161.—Nodes of Ranvier and lines of Fromann (Ranvier). A, Intercostal nerve of the mouse, treated with silver nitrate. B, Nerve-fiber from the sciatic nerve of a full-grown rabbit. A, node of Ranvier; M, medullary substance rendered transparent by the action of glycerine; CY, axis-cylinder presenting the lines of Fromann, which are very distinct near the node. The lines are less marked at a distance from the node.

contraction ensues; the same happening if the nerve be thus treated instead of the muscle. The changes in the muscle and the nerve will be seen later to have much in common; the muscle alone, however, *contracts*, undergoes a visible change of form.

Now, the agent causing this is a *stimulus*, and, as we have seen, may be mechanical, chemical, thermal, electrical, or nerv-

ous. As both nerve and muscle are capable of being functionally affected by a stimulus, they are said to be *irritable*; and, since muscle does not contract without a stimulus, it is said to be *non-automatic*.

Now, since muscle is supplied with nerves as well as blood-vessels, which end in a peculiar way beneath the muscle-covering (*sarcolemma*) in the very substance of the protoplasm (*end-plates*), it might be that when muscle seemed to be stimulated, as above indicated, the responsive contraction was really due to the excited nerve terminals; and thus has

arisen the question, Is muscle of itself really irritable?

What has been said as to the origin of muscular tissue

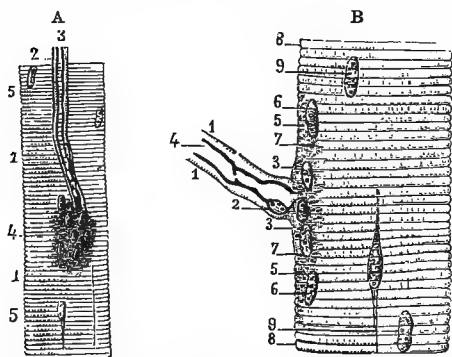

FIG. 162.—Mode of termination of the motor nerves (Flint, after Rouget). A. Primitiv fasciculus of the thyro-hyoid muscle of the human subject, and its nerve-tube: 1, 1, primitiv muscular fasciculus; 2, nerve-tube; 3, medullary substance of the tube, which is seen extending to the terminal plate, where it disappears; 4, terminal plate situated beneath the sarcolemma—that is to say, between it and the elementary fibrillæ; 5, 5, sarcolemma. B. Primitiv fasciculus of the intercostal muscle of the lizard, in which a nerve-tube terminates: 1, 1, sheath of the nerve-tube; 2, nucleus of the sheath; 3, 3, sarcolemma becoming continuous with the sheath; 4, medullary substance of the nerve-tube, ceasing abruptly at the site of the terminal plate; 5, 5, terminal plate; 6, 6, nuclei of the plate; 7, 7, granular substance which forms the principal element of the terminal plate and which is continuous with the axis-cylinder; 8, 8, undulations of the sarcolemma reproducing those of the fibrillæ; 9, 9, nuclei of the sarcolemma.

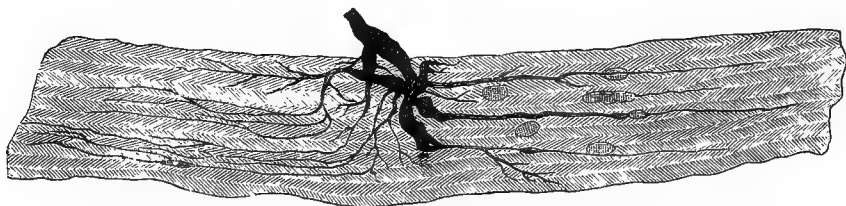

FIG. 163.—Intrafibrillar terminations of the motor nerve in striated muscle, stained with gold chloride (Landois).

points very strongly to an affirmative answer, though it does not follow that a property once possessed in the lower forms of

a tissue may not be lost in the higher; hence the resort to experiments which have long been thought to settle the matter:

1. The curare experiment may be thus performed: Lift up the sciatic nerve of a frog, and ligature the whole limb (exclusive of the nerve) so that no blood may reach the muscles; then inject curare, which paralyzes nerves but not muscles, into the general circulation through the posterior lymph-sac. On stimulating the sciatic nerve the muscles of the leg beneath the ligature contract, while no contraction of the muscles of the opposite leg follows from stimulation of its sciatic nerve. In the latter case the curare has reached the nerve terminals through the blood; in the former, these were left uninfluenced by the poison. If, now, the muscle itself be directly stimulated in the latter case, contraction follows, from which it is concluded that curare has destroyed the functional capacity of the nerve (*terminals*), but not of the muscle.

2. Stimulation of those parts of muscles in which no nervous terminations have been found, as the lower part of the sartorius muscle in the frog, is followed by contraction.

3. Certain substances (as ammonia), when applied directly to the muscle, cause contraction, but are not capable of producing this effect when applied to the nerve.

From these and various other facts it may be concluded that muscle possesses independent irritability.

APPLICATIONS OF THE GRAPHIC METHOD TO THE STUDY OF MUSCLE PHYSIOLOGY.

It is impossible to study the physiology of muscle to the best advantage without the employment of the graphic method; and, on the other hand, no tissue is so well adapted for investigation by the isolated method—i. e., apart from the animal to which it actually belongs—as muscle; hence the convenience of introducing at an early period our study of the physiology of contractile tissue and illustrations of the graphic method, the general principles of which have already been considered.

The descriptions in the text will be brief, and the student is recommended to examine the figures and accompanying explanations with some care.

Chronographs, Revolving Cylinders, etc.—Fig. 164 represents one of the earliest forms of apparatus for the measurement of brief intervals of time, consisting of a simple mechanism for pro-

ducing the movement of a cylinder, which may be covered with smoked paper, or otherwise prepared to receive impressions made upon it by a point and capable of being raised or lowered, and its movements regulated. The cylinder is ruled vertically into a certain number of spaces, so that, if its rate of revolution is known and is constant (very important), the length of time of any event recorded on the sensitive surface may be accurately known. This whole apparatus may be considered a chronograph in a rough form.

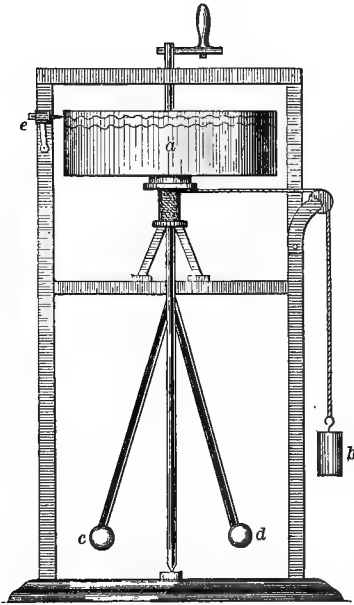

FIG. 164.—Original chronometer, devised by Thomas Young, for measuring minute portions of time (after McKendrick). *a*, cylinder revolving on vertical axis; *b*, weight acting as motive power; *c*, *d*, small balls for regulating the velocity of the cylinder; *e*, marker recording a line on cylinder.

But a tuning-fork is the most reliable form of chronograph, provided it can be kept in constant action so long as required; and is provided with a recording apparatus that does not cause enough friction to interfere with its vibrations.

Fig. 166 illustrates one arrangement that answers these conditions fairly well.

The marker, or chronograph, in the more limited sense, is kept in automatic action by the fork interrupting the current from a battery at a certain definite rate answering to its own proper note.

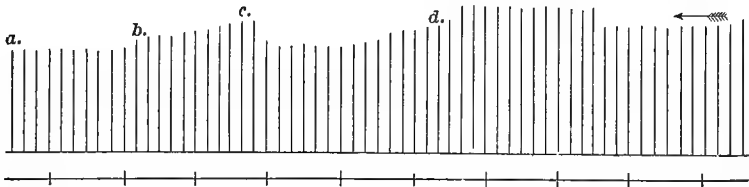

FIG. 165.—Myographic tracing, such as is obtained when the cylinder on which it is written does not revolve during the contraction of the muscle (after McKendrick).

Marey's chronograph, which is represented at *h* above, and in more detail below, in Fig. 167, consists of two electro-magnets armed with keepers, between which is the writer, which has a

little mass of steel attached to it, the whole working in unison with the tuning-fork, so that an interruption of the current

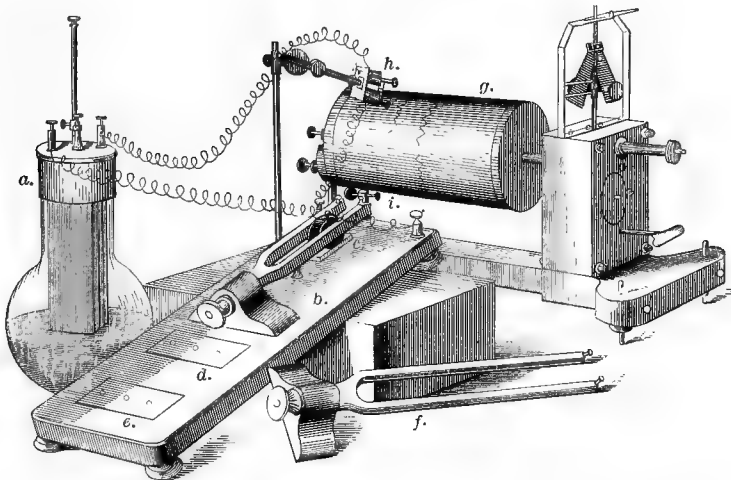

FIG. 166. —Marey's chronograph as applied to revolving cylinder (after McKendrick). *a*, galvanic element; *b*, wooden stand bearing tuning-fork (two hundred vibrations per second); *c*, electro-magnet between limbs of tuning-fork; *d, e*, positions for tuning-forks of one hundred and fifty vibrations per second; *f*, tuning-fork lying loose, which may be applied to *d*; *g*, revolving cylinder; *h*, electric chronograph kept in vibration synchronous with the tuning-fork interrupter. The current working the electro-magnet from *a* is interrupted at *i*. Foucault's regulator is seen over the clock-work of the cylinder, a little to the right of *g*.

implies a like change of position of the writing-style, which is always kept in contact with the recording surface.

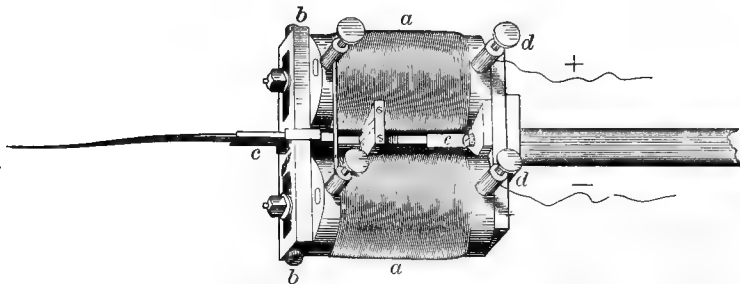

FIG. 167. —Side view of Marey's chronograph (after McKendrick). *a, a*, coils of wire; *b, b*, keepers of electro-magnets; *c*, vibrating style fixed to the steel plate *e*; *d*, binding screws for attachment of wires; + from interrupting tuning-fork; - to the battery.

Fig. 177 shows the arrangements for recording a single muscle contraction, and Fig. 178 the character of the tracing obtained.

A muscle-nerve preparation, which usually consists of the gastrocnemius of the frog with the sciatic nerve attached,

clamped by a portion of the femur cut off with the muscle, is made, on stimulation, to raise a weighted lever which is attached to a point writing on a cylinder moved by some sort of clock-work. In this case the cylinder is kept stationary during the contraction of the muscle; hence the records appear as straight vertical lines.

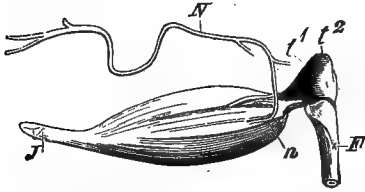

FIG. 168.—Muscle-nerve preparation, showing gastrocnemius muscle, sciatic nerve, and portion of femur of frog, for attachment to a vise (after Rosenthal).

For recording movements of great rapidity, so that the intervals between them may be apparent, such an apparatus as is figured below (Fig. 169) answers well, the vibrations of a tuning-fork being written on a

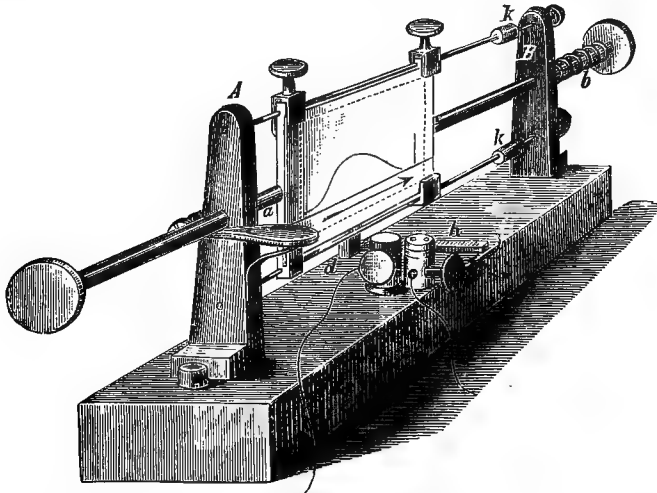

FIG. 169.—Spring myograph of Du Bois-Reymond (after Rosenthal). The arrangements for registering various details are similar to those for pendulum myograph (Fig. 177).

blackened glass plate, shot before a chronograph by releasing a spring.

Several records may be made successively by more complicated arrangements, as will be explained by another figure later.

THE APPARATUS USED FOR THE STIMULATION OF MUSCLE.

It is not only important that there should be accurate and delicate methods of recording muscular contractions, but that

there be equally exact methods of applying, regulating, and measuring the stimulus that induces the contraction.

Fig. 170 gives a representation of the inductorium of Du Bois-Reymond, by which either a single brief stimulation or a

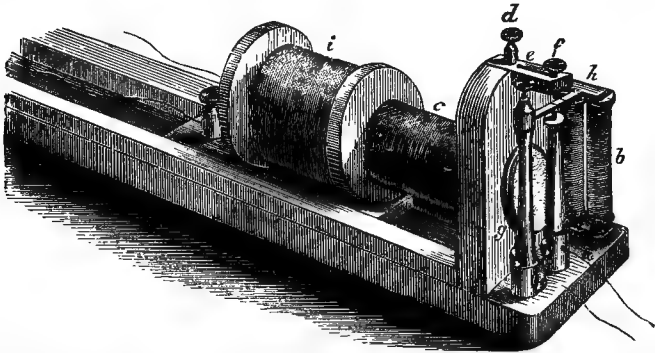

FIG. 170.—Du Bois-Reymond's inductorium (after Rosenthal). *i*, secondary coil; *c*, primary coil; *b*, electro-magnet; *h*, armature of hammer; *f*, small movable screw. The current from battery, ascending metal pillar, passes along hammer, and by screw gets into primary coil, thus inducing current in secondary coil. By connection between primary coil and wires around soft iron of *b*, iron becomes a magnet, hammer is attracted from screw *f*, and current thus broken; but when this occurs, soft iron ceases to be a magnet necessarily, and hammer springing back, the whole course of events is repeated. This may occur several hundred times in a second. The above may be clearer from diagram, Fig. 171. By sliding secondary coil up and down, strength of induced current can be graduated.

series of such repeated with great regularity and frequency may be effected. The apparatus consists essentially of a pri-

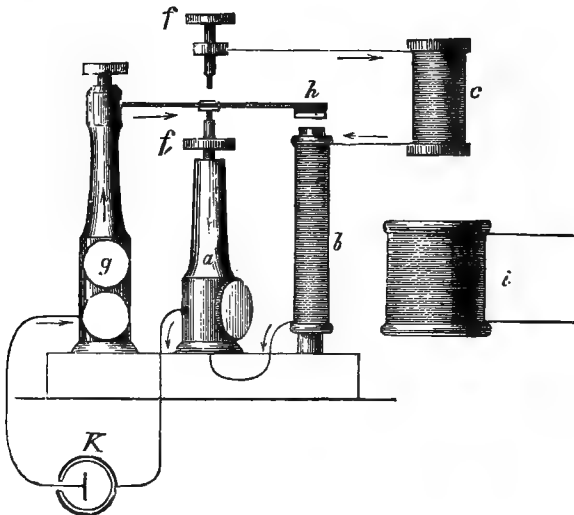

FIG. 171.—Diagrammatic representation of the working of Fig. 170 (after Rosenthal).

mary coil, secondary coil, magnetic interrupter, and a scale to determine the relative strength of the current employed. The instrument is put into action by one or more of the various well-known galvanic cells, of which Daniell's are suitable for most experiments.

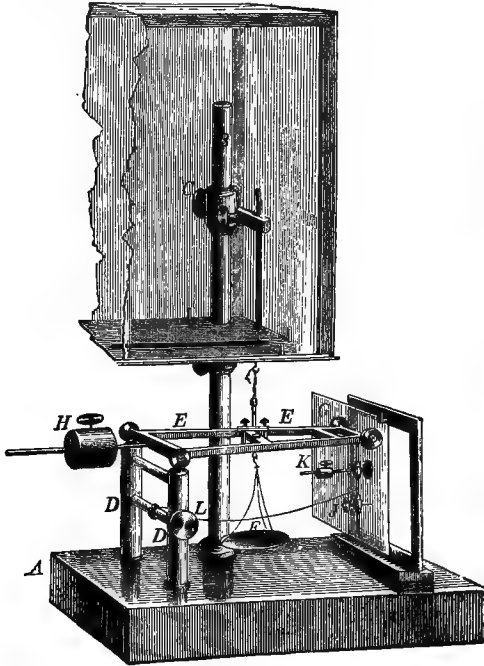

FIG. 172.

FIG. 172.—Pflüger's myograph. The muscle may be fixed to the vise *C* in the moist-chamber, the vise connecting with the lever *EE*, the point of which touches the plate of smoked glass *G*. The lever is held in equipoise by *H*. When weights are placed in scale-pan *F*, the lever writes the degree of extension effected (after Rosenthal).

FIG. 173.—Tetanizing key of Du Bois-Reymond (after Rosenthal). Wires may be attached at *b* and *c*. When *d* is down the current is "short-circuited," i. e., does not pass through the wires, but direct from *c* through *d* to *b*, or the reverse, since *b*, *c*, *d* are of metal, and, on account of their greater cross-section, conduct so much more readily than the wires. *a* is an insulating plate of ebonite. This form of key is adapted for attachment to a table, etc.

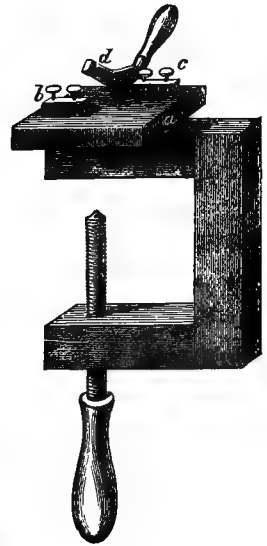

FIG. 173.

The access to, or exclusion of the current from, the inductorium is effected by some of the forms of keys, a specimen of which is illustrated in Fig. 173.

The moist chamber, or some other means of preventing the drying of the preparation, which would soon result in impaired action, followed by death, is essential. A moist chamber consists essentially of an inclosed cavity, in which is placed some wet blotting-paper, etc., and is usually made with glass sides. The air in such a chamber must remain saturated with moisture.

A good knowledge of the subject of electricity is especially valuable to the student of physiology. But there are a few elementary facts it is absolutely necessary to bear in mind: 1. An induced current exists only at the moment of making or breaking a primary (battery) current. 2. At the moment of making, the induced current is in the opposite direction to that of the primary current, and the reverse at breaking. 3. The strength of the induced current varies with the strength of the primary current. 4. The more removed the secondary coil from the primary the weaker the current (induced) becomes.

The clock-work mechanism and its associated parts, as seen in Fig. 174, on the right, is usually termed a myograph.

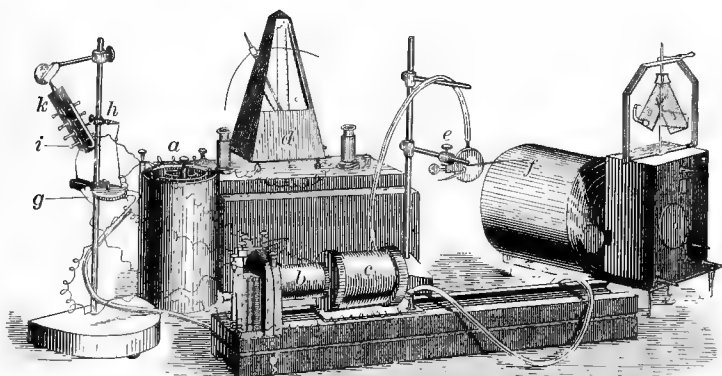

FIG. 174.—Arrangement of apparatus for transmission of muscular movement by tambours (after McKendrick). *a*, galvanic element; *b*, primary coil; *c*, secondary coil of inductorium; *d*, metronome for interrupting primary circuit when induction current is sent to electrodes *k*; *h*, forceps for femur; the muscle, which is not here represented, is attached to the receiving tambour *g*, by which movement is transmitted to recording tambour *e*, which writes on cylinder *f*.

Instead of muscular or other movements being communicated directly to levers, the contact may be through columns

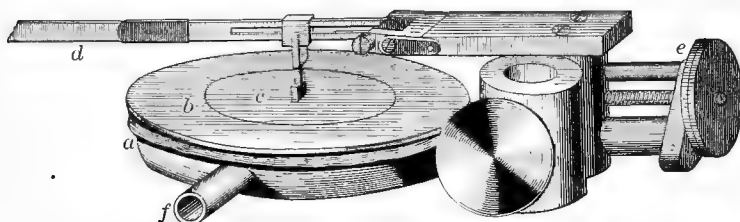

FIG. 175.—Tambour of Marey (after McKendrick). *a*, metallic case; *b*, thin India-rubber membrane; *c*, thin disk of aluminium supporting lever *d*, a small portion of which only is represented; *e*, screw for placing support of lever vertically over *c*; *f*, metallic tube communicating with cavity of tambour for attachment to an India-rubber tube.

of air, which, it will be apparent, must be capable of communicating very slight changes if the apparatus responds readily to the alterations in volume of the inclosed air.

Fig. 175 represents a Marey's tambour, which consists essentially of a rigid metallic case provided with an elastic top, to which a lever is attached, the whole being brought into communication with a column of air in an elastic tube. The working of such a mechanism will be evident from Figs. 174 and 176.

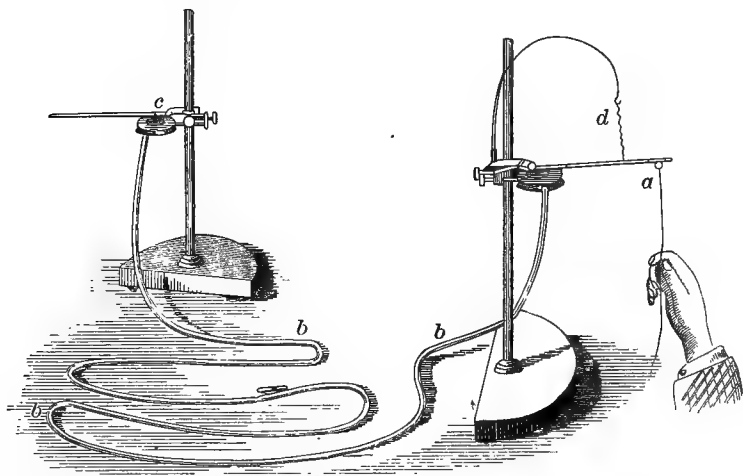

FIG. 176.—Tambours of Marey arranged for transmission of movement (after McKendrick). *a*, receiving tambour; *b*, india-rubber tube; *c*, registering tambour; *d*, spiral of wire, owing to elasticity of which, when tension is removed from *a*, the lever ascends.

The greatest danger in the use of such apparatus is not friction but oscillation, so that it is possible that the original movement may not be expressed alone or simply exaggerated, but also complicated by additions, for which the apparatus itself is responsible.

Apparatus of this kind is not usually employed much for experiments with muscle; such an arrangement is, however, shown in Fig. 174, in which all will be seen—a metronome, the pendulum of which, by dipping into cups containing mercury, makes the circuit. Such or a simple clock may be utilized for indicating the longer intervals of time, as seconds.

A SINGLE SIMPLE MUSCULAR CONTRACTION.

Experimental Facts.—The phases in a single twitch or muscular contraction may be studied by means of the pendulum

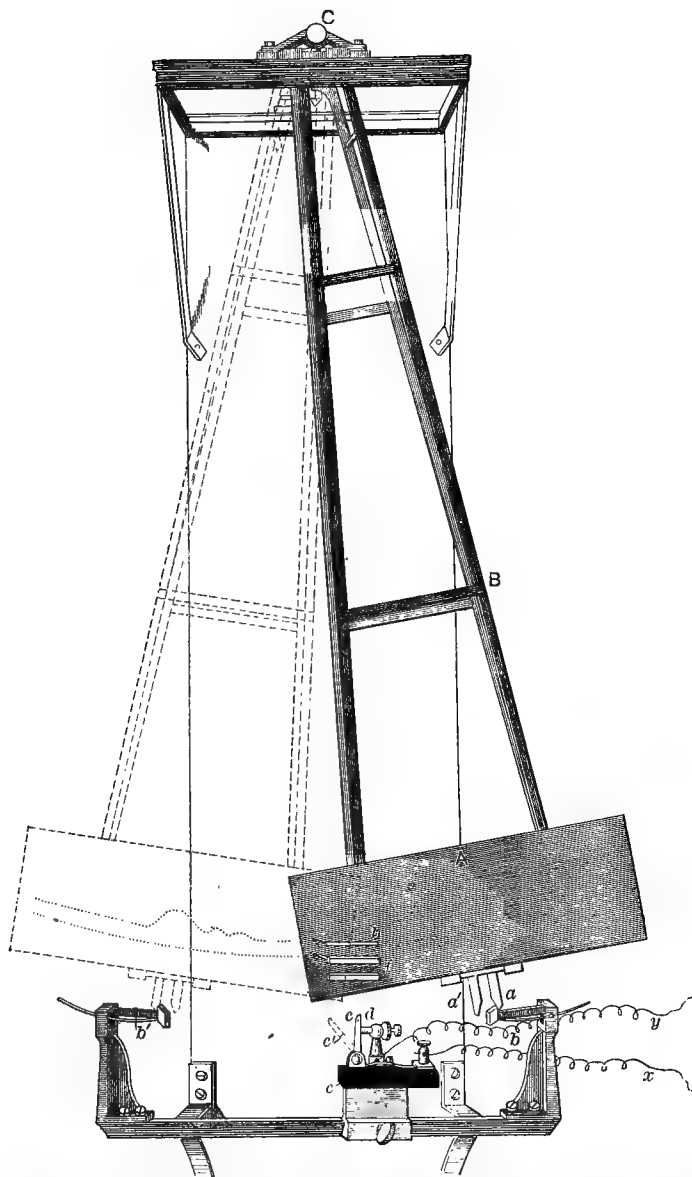

FIG. 177.—Diagrammatic representation of the pendulum myograph. The smoked-glass plate, *A*, swings with a pendulum, *B*. Before an experiment is commenced the pendulum is raised up to the right and kept in position by the tooth, *a*, catching on the spring-catch, *b*. On depressing the catch, *b*, the glass plate being set free swings into the new position indicated by the dotted lines, and is held there by the tooth, *a'*, meeting the catch, *b'*. In the course of its swing the tooth, *a*, coming into contact with the projecting steel rod, *c*, knocks it to one side, into the position indicated by the dotted line, *c'*. The rod, *c*, is in electric continuity with the wire, *x*, of the primary coil of an induction machine. In like manner

the screw, *d*, is in electric continuity with the wire, *y*, of the same primary coil. The screw, *d*, and the rod, *c*, are provided with platinum points, and both are insulated by means of the ebonite block, *e*. The circuit of the primary coil to which *x* and *y* belong is closed as long as *c* and *d* are in contact. When in its swing the tooth, *a'*, knocks *c* away from *d*, the circuit is immediately broken, and a "breaking" shock is sent through the electrodes connected with the secondary coil of the machine, and so through the nerve. The lever, *l*, the end only of which is shown in the figure, is brought to bear on the glass plate, and when at rest describes an arc of a circle of large radius. The tuning-fork, *f* (ends only seen), serves to mark the time (after Foster).

myograph (Fig. 177). It consists of a heavy pendulum, which swings from a position on the right to a corresponding one on the left, where it is secured by a catch. During the swing of the pendulum, which carries a smoked glass plate (by means of arrangements more minutely described below the figure), a tuning-fork writes its vibrations on the plate, on which is inscribed the marking indicating the exact moment of the breaking of an electric current, which gives rise to a muscle contraction that is also recorded on the plate.

The tracing on analysis presents: 1. The record of a tuning-fork making one hundred and eighty vibrations in a second. 2. The parallel marking of the lever attached to the muscle before it began to rise. 3. A curve, at first rising slowly, and then rapidly to a maximum. 4. A curve of descent similar in character, but somewhat more lengthened.

We may interpret this record somewhat thus: 1. A rise of the lever answering to the shortening of the muscle to which it

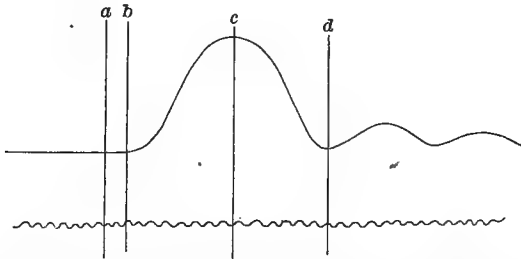

FIG. 178.—Muscle-curve obtained by the pendulum myograph (Foster). Read from left to right. The latent period is indicated by the space between *a* and *b*, the length of which is measured by the waves of a tuning-fork, making one hundred and eighty double vibrations in a second; and in like manner the duration of the other phases of the contraction may be estimated.

is attached following upon the momentary induction shock, as the entrance of the current into the nerve, the stimulation of which causes the contraction, may be called. 2. A period before the contraction begins, which, as shown by the time marking, occupies in this case $\frac{2\frac{1}{3}}{180}$, or about $\frac{1}{77}$ of a second. In the tracing the upward curve indicates that the contraction is at first rela-

tively slow, then more rapid, and again slower, till a brief stationary period is reached, when the muscle gradually but rapidly returns to its previous condition, passing through the same phases as during contraction proper. In other words, there is a period of rising and of falling energy, or of contraction, and relaxation. 4. A period during which invisible changes, as will be explained later, are going on, answering to those in the nerve that cause the molecular commotion in muscle which precedes the visible contraction—the latent period, or the period of latent stimulation.

The facts may be briefly stated as follows: The stimulation of a muscle either directly or through its nerve causes contraction, followed by relaxation, both of which are preceded by a latent period, during which no visible but highly important molecular changes are taking place. The whole chain of events is of the briefest duration, and is termed a muscle contraction. The tracing shows that the latent period occupied rather more than $\frac{1}{100}$ second, the period of contraction proper about $\frac{1}{100}$, and of relaxation $\frac{1}{100}$ second, so that the whole is usually begun and ended within $\frac{1}{10}$ second; yet, as will be learned later, many chemical and electrical phenomena, the concomitants of vital change, are to be observed.

In the case just considered it was assumed that the muscle was stimulated through its nerve. Precisely the same results would have followed had the muscle been caused to contract by the momentary application of a chemical, thermal, or mechanical stimulus.

If the length of nerve between the point of stimulation and the muscle was considerable, some difference would be observed

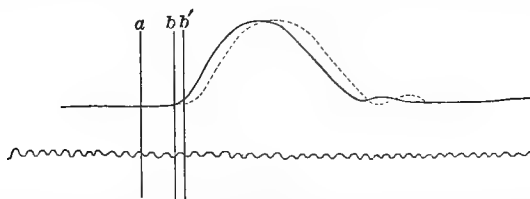

Fig. 179.—Diagrammatic representation of the measurement of velocity of nervous impulse (Foster). Tracing taken by pendulum myograph (Fig. 177). The nerve of same muscle-nerve preparation is stimulated in one case as far as possible from muscle, in the other as near to it as possible. Latent period is ab , ab' , respectively. Difference between ab and ab' indicates, of course, length of time occupied by nervous impulse in traveling along nerve from distant to near point.

in the latent period if in a second case the nerve were stimulated, say, close to the muscle. This is represented in Fig. 179,

in which it is seen that the latent period in the latter case is shortened by the distance from b' to b , which must be owing to the time required for those molecular changes which, occurring in a nerve, give rise to a contraction in the muscle to which it belongs; in fact, we have in this method a means of estimating the rate at which these changes pass along the nerve—in other words, we have a means of measuring the speed of the propagation of a nervous impulse. The estimated rate is for the frog twenty-eight metres per second, and for man about thirty-three metres. As the latter has been estimated for the nerve, with its muscle in position in the living body, it must be regarded rather as a close approximation than as exact as the other measurements referred to in this chapter.

It will be borne in mind that the numbers given as representing the relative duration of the events vary with the animal, the kind of muscle, and a variety of conditions affecting the same animal.

TETANIC CONTRACTION.

It is well known that a weight may be held by the outstretched arm with apparently perfect steadiness for a few seconds, but that presently the arm begins to tremble or vibrate, and soon the weight must be dropped. The arm was maintained in its position by the joint contraction of several muscles, the action of which might be described (traced) by a writer attached to the hand and recording on a moving surface. Such a record would indicate roughly what had happened; but the exact nature of a muscular contraction in such a case can best be learned by laying bare a single muscle, say in the thigh of a frog, and arranging the experiment so that a graphic record shall be made.

Using the apparatus previously described (Fig. 177), a second induction shock may be sent into the muscle before the effect

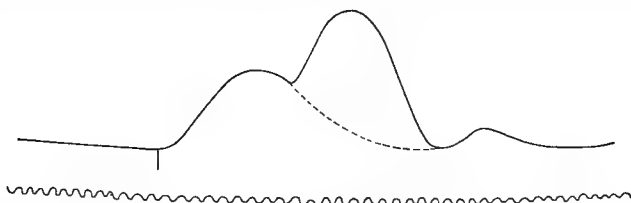

FIG. 180.—Tracing of a double muscular contraction (Foster). A second induction shock was sent into muscle when it had so far completed its contraction as is indicated by beginning of second rise. Dotted line indicates what the curve would have been but for this.

of the first has passed away, the result depending on the phase of the contraction, during which the stimulus acts on the muscle. Thus, if a second shock be applied during the latent period, no visible change in the nature of the muscle-curve can be seen; but if during one of the other phases of contraction, a result like that figured below (Fig. 180) follows. If a series of such shocks be sent into the muscle before its contraction period is over, a succession of curves may be superposed on one

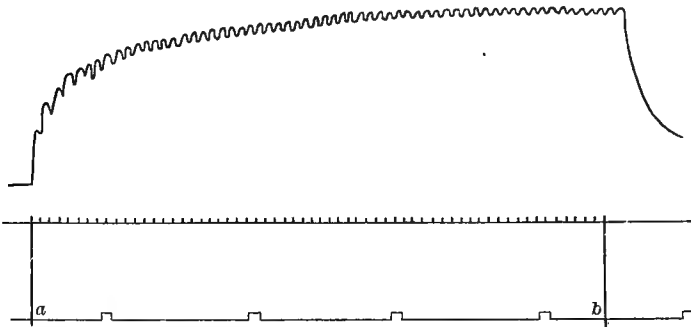

FIG. 181.—Curve of imperfect tetanic contraction (Foster). Uppermost tracing indicates contractions of muscle; intermediate, when the shocks were given; lower, time-markings of intervals of one second. Curve to be read, like others, from left to right, and illustrates at the end a "contraction remainder."

another, to the total height of which, however, there is a limit, no matter what the strength of the stimulus used.

If the stimuli follow each other with a certain rapidity, such a tracing as that represented in Fig. 181 is obtained; and if the rapidity of the stimulation exceeds a certain rate, the result is that seen in Fig. 182.



FIG. 182.—Curve of complete tetanic contraction (Foster).

It is possible to see in these tracings a genetic relation, the second figure being evidently derivable from the first, and the third from the second, by the fusion of all the curves into one straight line.

If a muscle, isolated as we have described, be watched during the period that it is writing the second and the third

tracing, it may be observed that, during that corresponding to the former, though it is shortened, it does not remain equally so throughout, while during the writing of the third tracing there is no variation in its condition appreciable by the eye. What has happened is this: The muscle during the condition figured in the second tracing has periods of alternating contraction and partial relaxation, but during the third case the latter phase has been apparently omitted—the muscle remains in continuous contraction. In reality this is not the case unless we are mistaken as to the meaning of the muscle-sound.

The Muscle Tone.—There are a number of experimental facts from which important conclusions have been drawn, to which attention is now directed:

1. It has been found that a sound may be heard in a still room when one brings the muscles of mastication into action by biting hard; or listens over a contracting biceps with a stethoscope, etc.

2. When the wires of a telephone (communicator) are connected with a muscle, a sound is heard during the contraction of the muscle.

From these facts it was concluded that a muscle when contracting gives rise to a sound; that *tetanus*, as the form of contraction we are describing is called, is essentially vibratory in character, which seems to answer to the graphic representations from a muscle when in tetanic contraction, and is in harmony with the case to which we called attention at the commencement of this subdivision of the subject. The note heard corresponded, in the case of an isolated muscle, to the number of stimulations per second; while for muscles made to contract by the will the note was always the same, answering to about forty vibrations per second; but as forty stimuli are not required within this period of time to induce tetanus, it was thought that this note was probably the harmonic of a lower one answering to twenty vibrations in a second.

It has been recently shown that a very much smaller number of vibrations of the muscle can give rise to an audible sound, so that the explanation it would seem must now be modified; and it is likely that some peculiarities of the ear itself must be taken into the account in the explanation. In making the observations referred to above (in 1), the student will find it very important to be on his guard against sources of error, especially with the use of a stethoscope.

We may safely conclude that, at all events, most of the mus-

cular contractions occurring within the living body are tetanic—i. e., the muscle is in a condition of shortening, with only very brief and slight phases of relaxation; and that a comparatively small number of individual contractions suffice for tetanus when caused by the action of the central nervous system; though, as proved by experiments on muscle removed from the body, they may be enormously increased. While a few stimulations per second suffice to cause tetanus, it will also persist though thousands be employed.

The Strength of the Stimulus.—We have assumed that in the cases of contraction thus far considered the stimulus was adequate to produce the full amount of contraction, or as much as could be obtained. Such a contraction and such a stimulus are spoken of as *maximal*; but the stimulus might fall a little short of this, and is then termed *sub-maximal*; or it may be regarded from the point of view of being the least that will cause a contraction, and is then the *minimal* stimulus.

It is important to note that any *sudden* change in an electric current will act as an excitant to muscular contraction, but that very considerable changes in the strength of the current if made gradually do not react on the muscle. It sometimes happens that a sudden onward push of the secondary coil of an induction-machine will produce either a tetanus (though the terminal wires or electrodes were arranged for a single induction shock) or what is known as a supermaximal contraction—i. e., one in excess of what could be obtained by more gradual advances, which have no effect usually after a certain maximum of contraction is reached. This, we think, a matter of considerable practical importance, and shall refer to its significance in a later chapter.

Since the opening or closing of a key which makes or breaks the current really implies a very great change in the strength of the current affected suddenly—that is in fact from 0 to some + quantity or the reverse—we find that usually the most marked contractions occur only at these times, and this holds, whether the current be slowly or rapidly made and broken (interrupted).

The nerve being the natural means of conveying a stimulus, it is easy to understand how the contraction happens to follow most perfectly and with less strength of stimulus when this structure is excited.

THE CHANGES IN A MUSCLE DURING CONTRACTION.

Though the change in form is very great during the contraction of a muscle, the change in bulk is almost inappreciable, amounting to a diminution of not more than about $\frac{1}{1000}$ of the volume. In fact, according to the latest investigator, there is no diminution whatever. A series of levers may be laid on a muscle or the columns of air in a series of Marey's tambours may be influenced by the contracting muscle, and from some such apparatus a graphic record like that seen in Fig. 183 may be obtained.

It is to be observed that the contraction passes along the muscle in the form of a wave, the size and speed of which are

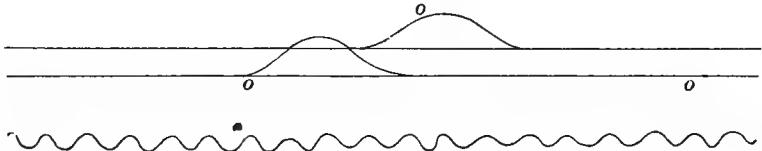

FIG. 183.—Tracing of the propagation of the muscular wave. Chronographic tracing, one hundred vibrations per second underneath (Marey).

susceptible of measurement. For the frog the wave-length is estimated at from 200 to 400 mm., and the velocity at about 3 to 4 metres per second.

It is probably rather greater in the muscles of mammals and greater under the more natural conditions of the muscle in the intact living body.

But since the fibers of striped muscle are of very limited length (30 to 40 mm.), it would seem that a contraction originating in one fiber must be capable of initiating a similar action in its neighbor; and, as the ends of the fibers lie in contact, it is easy to understand how the wave of contraction spreads. Normally, the contraction must pass from about the center of the muscle-cell where the nerve terminates in the end-plate.

The microscopic changes occurring in contracting muscle are not well understood. The living muscle of a beetle's thigh when placed under a microscope may be seen in contraction—a sight of the most striking nature, reminding one of a billowy, tempestuous sea, and by the use of reagents the waves of contraction may be fixed.

It may be stated that the parts distinct before remain so

during contraction, and that all parts of the muscle-substance seem to share in the changes of form involved.

THE ELASTICITY OF MUSCLE.

In proportion as bodies tend to resume their original form when altered by mechanical force are they elastic, and the extent to which they do this marks the limit of their elasticity.

If a muscle (best one with bundles of fibers of about equal length and parallel arrangement) be stretched by a weight attached to one end, it will, on removal of the extending force, return to its original length; and if a series of weights which differ by a common increment be applied in succession and the degrees of extensions compared, as may be done by the graphic method, it will be apparent that the increase in the extension does not exactly correspond with the increment in the weight, but is proportionally less. With an inorganic body, as a watch-spring, this is not the case.

Further, the recoil of the muscle after the removal of the weight is not perfect for all weights; but within certain narrow limits this is the case, i. e., the elasticity of muscle, though slight (for it is easily over-extended), is perfect. When once a muscle is over-extended, so weighted that it can not reach its original length almost at once, it is very slow to recover, which explains the well-known duration of the effects of sprains, no doubt owing to some profound molecular change associated with the stretching.

The tracings below show at a glance the difference between the elasticity of muscle and of ordinary bodies.

It is a curious fact that a muscle during the act of contraction is more extensible than when passive; a disadvantage from a purely physical point of view, but probably a real advantage as tending to obviate sprain by preventing too sudden an application of the extending force.

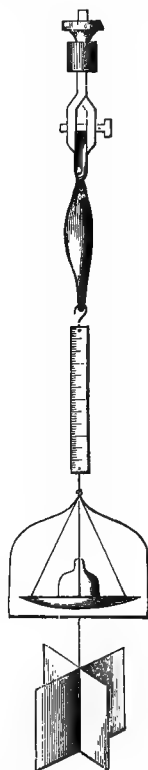

FIG. 184.—Du Bois-Reymond's apparatus for the study of elastic extension in muscle (after Rosenthal). The graduated rod attached to muscle is to be observed with a lens.

It will be borne in mind that the limbs are held together as by elastic bands slightly on the stretch, owing to the elasticity

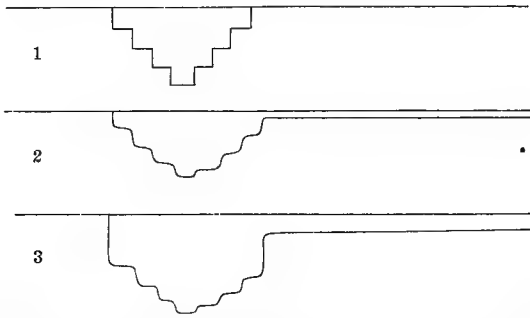

FIG. 185.—Illustrations of the difference in elasticity of inanimate and living matter (after Yeo). 1. Shows graphically behavior of a steel spring under equal increments of weight. 2. A similar tracing obtained from an India-rubber band. 3. The same from a frog's muscle. Note that the extension decreases with equal increments of weight, and that the muscle fails to return to the original position (abscissa) after removal of the weight.

of the muscles. Now, as seen in many tracings of muscular contraction, there is a tendency to imperfect relaxation after contraction—the *contraction remainder* or *elastic after-effect*, which can be overcome by gentle traction. In the living body, the weight of the limbs and the action of the stretched muscles on the side of the limb opposite to that on which the muscles in actual contraction are situated, combine to make the action of the muscle more perfect by overcoming this tendency to imperfect relaxation, which is probably less marked, independent of these considerations, in the living body. This elasticity of living muscles, which is completely lost on death, is a fair measure of their state of health or organic perfection. Hence that hard (elastic recoil) feeling of the muscles in young and vigorous persons, especially athletes, in whom muscle is brought to the highest degree of perfection.

This property is then essentially the outcome of vitality, which is in a word the foundation of the differences noted between the elasticity of inorganic and organic bodies. A muscle, the nutrition of which is suffering from whatever cause, whether deficient blood-supply, fatigue, or actual disease, is deficient in elasticity. We wish to emphasize these relations, for we consider it very important to avoid regarding vital phenomena in the light of physics merely, which the employment of the graphic method (and indeed all methods by which we remove living things out of their normal relations) fosters.

Electrical Phenomena of Muscle.—Certain pieces of apparatus

not as yet referred to are required to demonstrate the electrical condition of muscle. The *galvanometer* suitable for physiological experiments is one having very many coils of extremely fine wire, and so adapted to indicate the presence of currents of slight intensity.

In order that it may be ascertained definitely that the currents that deflect the galvanometer needle do not originate outside of the muscle itself, *non-polarizable electrodes* very carefully made must be used, for the contact of ordinary metallic electrodes with living tissues suffices of itself to generate an electric current, as may be simply illustrated to one's self by placing two coins, one silver and the other copper, in contact with the upper and under surfaces of the tongue respectively, and meeting in front; a peculiar taste results from the current excited.

The construction of the non-polarizable electrodes commonly employed, and as arranged for use, is diagrammatically represented below (Fig. 186).

Assuming the apparatus for the detection of electrical current in muscle to be in working order, a muscle from one of

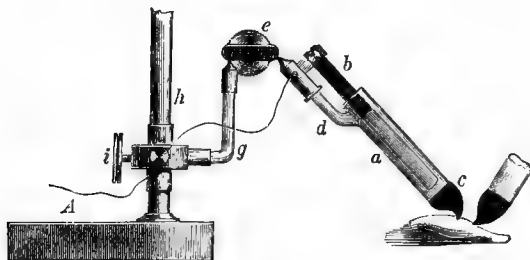

FIG. 186.—Non-polarizable electrodes of Du Bois-Reymond (after Rosenthal). At c, clay tip, moistened with saline solution, is laid on muscle. Glass cylinder a is filled with strong solution of zinc sulphate, a good conductor, by which current is conveyed to amalgamated zinc plate b, and thence to galvanometer.

the cold-blooded animals, prepared as rapidly and carefully as possible, avoiding all contact with foreign bodies, is cut across the ends transversely, and placed on pads of bibulous paper moistened with physiological (60-75 per cent) saline solution. The non-polarizable electrodes connected with the galvanometer are brought in contact with the muscle. What results depends on the parts of the muscle that touch the electrodes, and is represented diagrammatically in Fig. 187.

It will be observed that the diagram indicates that between no current and the strongest obtainable there are all shades of

strength, according to the parts of the muscle connected by the electrodes. The strongest is that resulting when the superfi-

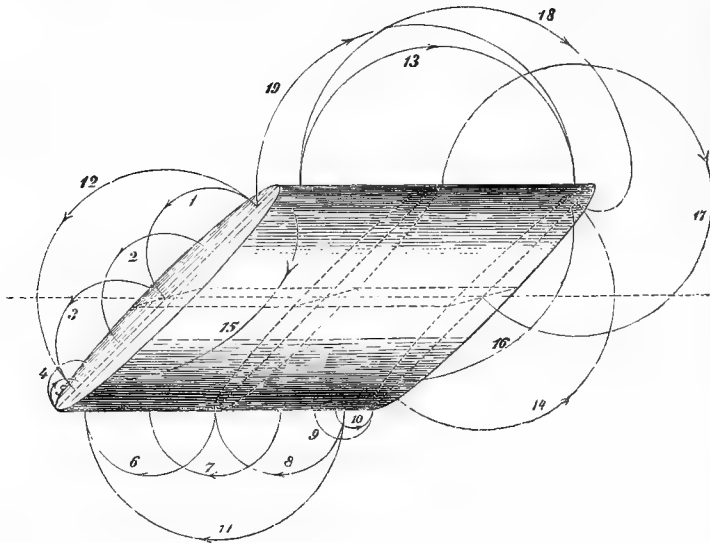

FIG. 187.—Representation of electrical currents in a muscle-rhombus (after Rosenthal).

cial equator and the transverse center are connected; and it is found that the nearer these points are approached the stronger the current becomes, as is indicated by the greater extent of swing of the galvanometer needle. In connection with these surprising phenomena, one naturally inquires whether such a muscle-current, for such it must be, is natural or artificial. Does such exist in a living muscle in its position in the body, or has the injury done to a muscle in its preparation by section, removal from the usual conditions of nutrition, and such like changes, been the cause of the current?

After much investigation, by some of the ablest physiologists of the day, different answers are returned to these queries.

Du Bois-Reymond maintains that such currents are natural, and may be obtained from muscle contracting *in situ*; while Hermann and others believe that such a current is owing to the injury done by the section, and that the current from the equator to the poles of the section is due to the fact that the injured part is negative to the uninjured region.

It is a fact that if the current be led off from an exposed muscle prior to section, it is relatively very weak. Further, the electrodes placed on the uninjured ventricle of an animal's

heart convey no current to the galvanometer; but after section, as in the case of a skeletal muscle, the usual result follows. All observers, however, are agreed that a current is produced during contraction. Those not believing in that just referred to above ("current of rest"), term this one the "current of action"; while the other school names it the *negative variation* of the current of rest, inasmuch as the galvanometer needle swings in the opposite direction indicating, as they say, a diminution in the original current.

The presence of this undisputed current can be made evident by a simple experiment, without the use of any of the elaborate apparatus noticed above. Let two frog's limbs, with the

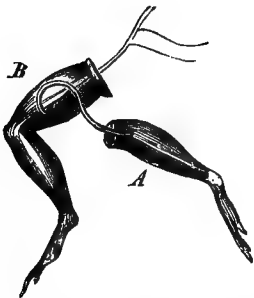

FIG. 188.—Arrangement of parts to show secondary contraction in muscle (after Rosenthal).

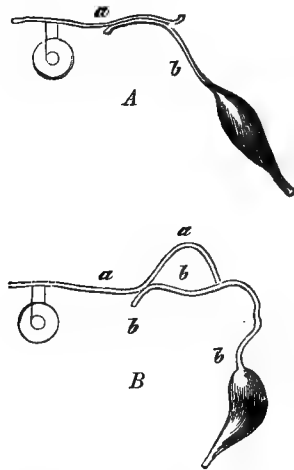

FIG. 189.—The same when the primary cause is in nerve (after Rosenthal).

nerves belonging to them, be prepared in good condition and arranged as in Fig. 188, so that the nerve of A rests along the thigh of B. On stimulating the nerve of B, the muscular effect in this limb is answered by a similar one in A. That this is not necessarily due to escape of the current upon the nerve of A, may be shown by putting a ligature around the nerve of B below the point of application of the current and moistening it so as to allow of the free passage of the current. In such case stimulation of the nerve of B gives wholly negative results, because the ligature has destroyed physiological (molecular) continuity, though it does not prevent the passage of the current. More-

over, the result may be obtained by other than electrical stimuli.

The explanation of these phenomena of the "rheoscopic frog" (physiological rheoscope) is simply that the electrical condition of B has been *suddenly* changed by the passage of the current into the nerve, and that this difference of electrical condition (potential) between the muscle of B and A's nerve suffices to stimulate the muscle of A (one is in fact + and the other -); hence the stimulus and the contraction, the nature of which in A is the same as that in B—i. e., a single twitch in B gives rise to the same in A, and a tetanic contraction to a tetanic contraction. Plainly the contraction of A must be due to a current in B, hence the proof that a current actually exists during the contraction of a muscle. It may be noted that a mere prick of B will arouse in it a contraction which is followed by the same result as before in A, so that in this we can exclude the original stimulating current altogether as a possible source of fallacy, as stated above. But one of the most striking proofs that there is a current of action (or negative variation), is obtained by placing the nerve of such a preparation as that represented in B on a contracting mammalian heart; with each systole there is a spasm of the frog's leg.

It is important to note that the electric current of muscle, however viewed, is an event of the latent period. It is associated with the chemical and all the other molecular changes of which the actual contraction is but the outward and visible sign; and since the currents of rest have an appreciable duration, wane with the vitality of the tissue, and wholly disappear at death, they must be associated with the fundamental facts of organic life; for it is to be remembered that electrical currents are not confined to muscle, but have been detected in the developing embryo, and even in vegetable protoplasm. Though the evidence is not yet complete, it seems likely that electrical phenomena may prove to be associated with (we designedly avoid any more definite expression) all vital phenomena.

Chemical Changes in Muscle.—In an animal, at a variable period after death, the muscles become rigid, producing that stiffness (*rigor mortis*) so characteristic of a recent cadaver.

The subject can be studied in some of its aspects to great advantage in an isolated individual muscle.

Three changes in a muscle that has passed into death rigor are constant and pronounced. The living muscle, either alkaline or neutral in reaction, has become decidedly acid; an

abundance of carbonic anhydride is suddenly given off; and *myosin*, a specific protéid, has been formed. That these phenomena have some indissoluble connection with each other so far as the first two at least are concerned, while not absolutely certain, seems probable, as will be learned shortly.

It will be borne in mind that muscle-fibers are tubes containing semifluid protoplasm, and that a coagulation of the latter must give rise to general rigor. This protoplasmic substance can be extracted at a low temperature from the muscles of the frog, and, as the temperature rises coagulates like blood, giving rise to a clot (*myosin*) and muscle-serum, a fluid not very unlike the serum of blood.

This *myosin* can also be extracted from dead rigid muscles by ammonium choride, etc. It resembles the globulins generally, but is less soluble in saline solutions than the globulin of blood (*paraglobulin*); is less tough than fibrin; has a very low coagulating point (55° to 60° C.); and is somewhat jelly-like in appearance. The clotting of blood and of muscle is thus analogous, *myosin* answering to fibrin, and there being a serum in each case, both processes marking the permanent disorganization of the tissue. The reaction seems to be due to the formation of a kind of lactic acid, probably sarolactic; though whether due to excessive production of this acid, on the death of the muscle, which for some reason does not remain free in the living muscle, or whether sarcolactic acid arises as a new product, is uncertain. It is certain that the acid reaction of dead muscle is not owing to carbonic acid, for the reddened litmus does not change color on drying.

That a muscle in action does use up oxygen and give off carbonic anhydride can be definitely proved; though it is equally clear that the life of a muscle is not dependent on a *constant* supply of oxygen as is that of the individual, for a muscle can live, even contract long and vigorously, in an atmosphere free from this gas, as in nitrogen.

From the suddenness of the increase of carbonic anhydride, the onset of death and *rigor mortis* has been compared to an explosion.

After this the muscle becomes greatly changed physically: its elasticity and translucency are lost; there is absence of muscle-currents; it is wholly unirritable, is less extensible—it is, as before stated, firmer—it is dead.

But these fundamental phenomena, the increase of carbonic anhydride and the acid reaction, are observable after prolonged

tetanus. It was, therefore—putting all the facts together that we now refer to and others, not forgetting that a muscle is always respiring, inhaling oxygen, and exhaling carbonic anhydride—not unreasonable to conclude that normal tetanus and *rigor mortis* were but exaggerated conditions of a natural state. The coagulation of the muscle protoplasm (*plasma*), giving rise to myosin, was, however, a serious obstacle to the adoption of this view. But it has very recently been urged with great plausibility that an old view is correct, viz., that *rigor mortis* (contracture) is the last act of muscle-life; it is, in fact, a prolonged tetanus or contracture, ending in most cases, though not all, in coagulation of the myosin. This state can be induced and recovered from in favorable cases by cutting off the blood from a part by ligature, and later readmitting it to the starving region. It has been suggested that the products of the muscle-waste, usually washed away by the blood-stream, in such an experiment and after death, collect and act as a stimulant to the muscle, causing it to remain in permanent contraction.

The other constituents of *dead* muscle and their relative properties may be learned from the following table (Von Bibra):

Water.....	744.5
Solids: Myosin, elastic substance, etc., in- soluble in water.....	155.4
Soluble proteids.....	19.3
Gelatin.....	20.7
Extractives and salts.....	37.1
Fats.....	23.0
	255.5—255.5
Total.....	1,000

Among the *extractives* of muscle very important is creatin (2 to 3 per cent), a nitrogenous crystalline body. Certain allied forms, as xanthin, hypoxanthin (sarkin), karnin, taurin and uric acid, are also found.

Glycogen (animal starch), very abundant in all the tissues, including the muscles of the embryo, is found in small quantity in the muscles of the adult; and in the heart-muscle a peculiar sugar (*inosit*) is present.

It is, of course, very difficult to say to what extent the bodies known as extractives exist in living muscle, though that glycogen, fats, and certain salts are normally present admits of little doubt.

There is a coloring matter in muscle, more abundant in the red muscles of certain animals than the pale, allied to hæmoglobin, if not identical with that body.

It may be stated as a fact, the exact significance of which is unknown, that during contraction the extractives soluble in water decrease, while those soluble in alcohol increase.

It will, however, be very plain, from what has been stated in this section, that life processes and chemical changes are closely associated, and to realize this is worth much to the student of Nature.

THERMAL CHANGES IN THE CONTRACTING MUSCLE.

Since very marked chemical changes accompany muscular contraction, it might be expected that there would be some modification in temperature, and probably in the direction of elevation. Experiment proves this to be the case. If a thermometer finely graduated be kept among the muscles of the limb of a mammal during the contractions that follow the stimulation of the main nerve, a decided rise of temperature may be noted during the prolonged tetanus that may be thus originated. True, during the contraction of a set of muscles under such circumstances, there is a possible fallacy, from the excess of blood going to the parts owing to dilatation of the blood-vessels, which it would be necessary to exclude—i. e., we must either ascertain that such does not take place, or take it into account as a factor in the causation of the rise of temperature. However, by using a delicate thermopyle, a muscle to which no blood passes may be shown to grow warmer during contraction.

But why should a muscle when at rest, as may be shown, maintain a certain temperature, unless chemical changes are constantly taking place? As already stated, such is the case, and the rise on passing into tetanus is simply an expression of increased chemical action.

What is the nature of the combustion originating this heat? Are certain crude materials withdrawn from the blood and burned up directly in the muscle-substance; or is the muscle itself continuously building up and tearing down its own substance, all of which implies oxidation?

All attempts to explain the facts apart from the latter view have been unsuccessful, and we are forced to conclude that such is the synoptical statement of the life-history of muscle.

No machine known to us resembles muscle except superficially. The steam-engine changes fuel into heat and mechanical motion, but there the resemblance ends. Muscle changes its food, or fuel, not directly into either heat or motion, but into itself; yet as a machine it is more effective than the steam-engine, for more work and less heat are the outcome of its activity than is the case with the steam-engine.

THE PHYSIOLOGY OF NERVE.

Muscle and nerve are constantly associated functionally, and have so much in common that it becomes desirable to study them together. Much that has been established for muscle holds equally well for nerve; and the latter, though apparently wholly different in structure at first sight, is really not so. Nerve has its protoplasmic part (axis-cylinder), which is the essential structure, its protective sheaths, and its nuclei (nerve-corpuscles)

As already indicated, a nerve possesses irritability, and, since a muscle does not respond to an electric current sent through a nerve except when there is a sudden change in the strength of the current, it becomes interesting to learn why this should be the case.

Experimental.—In Fig. 190 are shown diagrammatically two muscle-nerve preparations, and the apparatus necessary for applying a constant current and a (momentary) induced current by single shocks to the nerve.

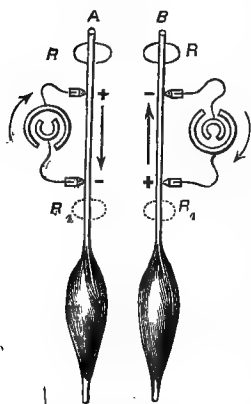

FIG. 190.—Diagrammatic representation of the method of testing the excitability of the nerve in electrotonus (Landois). Positive poles marked +, negative, -; the course of current indicated by arrows. R , R_1 , R_2 , are points at which excitability of the nerve is especially altered.

A strength of current sufficient to cause a (sub-maximal) contraction by an induction shock is determined, and the inductorium left at this graduation. A constant current of moderate strength is allowed to pass into the nerves of the preparation. It is found that, in the one case, the muscle contraction is increased, and in the other diminished or absent, when the same strength of induction shock is sent into the nerve at the points

below the entrance of the constant current—that is to say, the irritability of the nerve has been increased or diminished.

It is found that when the constant (polarizing) current is passing from above downward—that is, when the cathode (negative pole) is on the side toward the muscle—the irritability of the nerve is increased, and the reverse when the opposite conditions prevail.

This altered condition is known as *electrotonus*. Unfortunately this term is used somewhat loosely, sometimes being employed in the sense now explained; sometimes to denote a change of electro-motive force that accompanies the alteration of irritability; and again to cover all the conditions implied in the experiment. It is a fact that during the passage of a constant current the natural nerve-current is affected, being increased or diminished according to the direction of the polarizing current. There is, however, so much difference of opinion in regard to this subject that it is very doubtful whether it should be more than noticed in passing.

But to return to electrotonus, which is both interesting and important, it has been found as a result of many experiments that profound modifications of the irritability of a nerve do take place during the passage of a constant current. These are diagrammatically represented in Fig. 191.

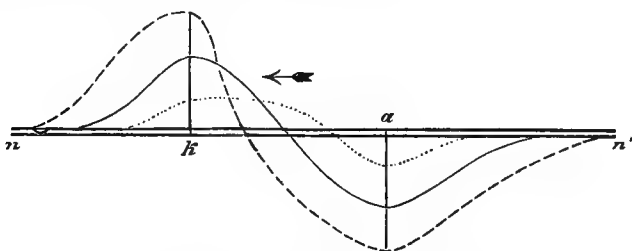

FIG. 191.—Diagrammatic representation of variations in electrotonus according to strength of current employed (after Pflüger). $n n'$, a section of nerve; a , anode (+ pole); k , kathode (— pole). Curves above the horizontal denote *catelectrotonus*; below, the opposite.

Briefly stated, they are these: 1. The nature of the change depends on the direction of the polarizing (constant) current; hence, if the current is descending, there is an increase of irritability (*catelectrotonus*) in the portion of the nerve nearest the muscle, and *vice versa*. 2. The extent of the change of irritability is dependent on the strength of the polarizing current. 3. This change is most marked close to the electrodes, spreads to a considerable extent beyond this point without the electrodes (extra-polar regions), and also exists within the region of contact of the electrodes (intra-polar regions). 4. It follows

that there must be a point at which it is not experienced (indifferent point or neutral point).

Now, it is possible to understand why a sudden change in the current should cause a muscular contraction. An equally sudden change, a profound molecular effect, has been caused, and this we must believe essential to the causation of a muscular contraction through the influence of a nerve.

To use an illustration which may serve a good purpose if not taken too literally, it is a well-known experience that one sitting in a room in which a clock is ticking soon fails to notice this regular sound; but should the clock stop suddenly or as suddenly commence to tick very rapidly, the attention is aroused, while a very gradual slowing to cessation or the reverse would have escaped notice. The explanation of such facts takes us down to the very foundations of biology; but just now we wish only to elucidate by our own experience how it is possible to conceive of a muscle being stimulated by the molecular movements of nerve, or rather a change in these.

There are important practical aspects to this question. One may understand why it is that electricity proves so ready a stimulus, and is so valuable a therapeutic agent. It seems, in fact, as will be learned later, to be capable of taking the place to some extent of that constant nerve influence which we believe is being exerted in the higher animals toward the maintenance of the regularity of their cell-life (metabolism).

Pathological and Clinical.—It is believed that in the nerves of man, within his living body, the electrotonic condition can be induced as in an isolated piece of nerve. Hence, the value of the constant current in diminishing nerve irritability in neuralgia and allied conditions. Apparatus of great nicety of construction and capable of generating, accurately measuring, and conveniently applying electrical currents of different kinds, now adds to the resources of the physician. But we are probably as yet only on the threshold of electro-therapeutics.

Law of Contraction (Stimulation).—A given piece of nerve is stimulated only by the appearance of catelectrotonus, and the disappearance of anelectrotonus; but the disappearance of catelectrotonus and the appearance of anelectrotonus are without effect (Pflüger). This so-called law is supposed to explain the following facts, which may be thus expressed in tabular form (after Landois):

STRENGTH OF CURRENT.	ASCENDING.		DESCENDING.	
	On closing.	On opening.	On closing.	On opening.
Weak	C	R	C	R
Medium.....	C	C	C	C
Strong	R	C	C	R

R = rest; C = contraction.

Electrical Organs.—Electrical properties can be manifested by a large number of fishes; and the subject is of special theoretical interest. It is now established that the development of electrical organs points to their being specially modified muscles—tissues, in fact, in which the contractile substance has disappeared and the nervous elements become predominant and peculiar. No work is done, but the whole of the chemical energy is represented by electricity. Functionally an electric organ (which usually is some form of cell, on the walls of which nerves are distributed, inclosing a gelatinous substance, the whole being very suggestive of a galvanic battery) closely resembles a muscle-nerve preparation or its equivalent in the normal body. The electric organs experience fatigue; have a latent period; their discharge is tetanic (interrupted); is excited by mechanical, thermal, or electrical stimuli; and the effectiveness of the organs is heightened by elevation of temperature, and the reverse by cooling, etc.

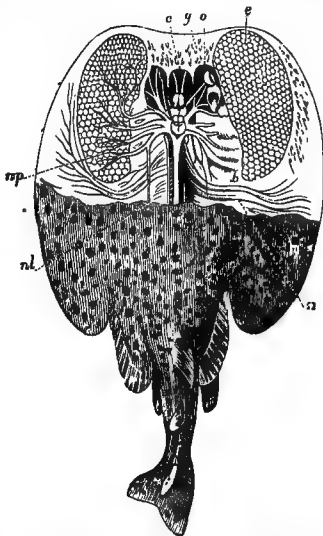

FIG. 192.—The electric fish torpedo, dissected to show electric apparatus (Huxley). *b*, branchiæ; *c*, brain; *e*, electric organ; *g*, cranium; *me*, spinal cord; *n*, nerves to pectoral fins; *nl*, nervi laterales; *np*, branches of pneumogastric nerves to electric organs; *o*, eye.

MUSCULAR WORK.

If during a given period one of two persons raises a weight through the same height but twice as frequently as the other, it is plain that he does twice the work; from such a case we may deduce the rule for calculating work, viz., to multiply the weight and height together.

The effectiveness of a given muscle must, of course, depend on the degree to which it shortens, which is from one half to three fifths of its length; and the number of fibers it contains—i. e., upon its length and the area of its cross-section, taking into account in connection with the first factor the arrangement of the fibers; those muscles in which the fibers run longitudinally being capable of the greatest total shortening.

There is, as shown by actual experimental trial, a relation between the work done and the load to be lifted. With double the weight the contraction may be as great as at first, or even greater; but a limit is soon reached beyond which contraction is impossible. This principle may be stated thus: *The contraction is a function of the stimulus*, and is illustrated by the diagram below (Fig. 193).



FIG. 193.—Diagram of muscular contractions with same stimulus and increasing weights. The numbers represent grammes (McKendrick).

It has been shown experimentally that the chemical interchanges in a muscle, acting against a considerable resistance, are increased—i. e., the metabolism and the working tension are related.

These experimental facts harmonize with our experience of a sense of satisfaction and effectiveness in the use of the muscles when weights are held in the hands; and it must be a matter of practical importance that each person should, in taking systematic exercise, keep to that kind which does not either overweight or underweight the muscles.

CIRCUMSTANCES INFLUENCING THE CHARACTER OF MUSCULAR AND NERVOUS ACTIVITY.

The Influence of Blood-Supply. Fatigue.—Fig. 194 shows at a glance differences in the curves made by a contracting muscle suffering from increasing fatigue.

Suppose that in such a case the blood had been withheld from the muscle, and that it is now admitted, an almost immediate effect is seen in the nature of the contractions; but even if only saline solution had been sent through the vessels of the muscle, a similar change would have been noticeable. We may fairly conclude that the blood and saline removed something which had been exercising a depressing effect on the

vitality of the muscle. In a working muscle, like all living tissues, there are products of vital action (metabolism) that are

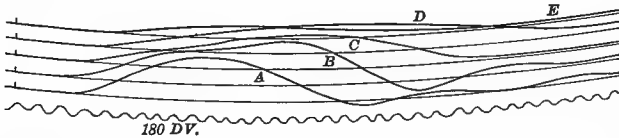

FIG. 194.—Curves of a muscle contraction in different stages of fatigue (after Yeo). *A*, curve when muscle was fresh; *B*, *C*, *D*, *E*, each just after muscle had already contracted two hundred times. The alteration in length of latent period is not well brought out in these tracings.

poisonous. We have already learned that a working muscle generates an excess of carbonic anhydride, and something which gives it an acid reaction; and that it uses up oxygen as well as other matters derivable from blood.

Fatigue will occur, it is well known, if the muscles are used for an indefinitely long period, no matter how favorable the blood-supply—another evidence that there is, in all probability, some chemical product, the result of their own activity, depressing them; and this is rendered all the more likely when it is learned that the injection of lactic acid, to take one example, produces effects like ordinary fatigue.

It is also a matter of common experience that exercise, while beneficial to the whole body, the muscles included, as shown by their enlargement under it, becomes injurious when carried to the point of fatigue.

Why the use of the muscles is conducive to their welfare is but a part of a larger question, Why does the use of any tissue improve it?

When the nerve which supplies a muscle is stimulated its blood-vessels dilate, and it has been assumed that the same happens when a muscle contracts normally in the body; and when muscular action is increased there is a corresponding augmentation in the quantity of blood driven through the muscles in a given period, even if there be no actual increase in the caliber of the blood-vessels, for the heart-beat is greatly accelerated.

But repose is as necessary as exercise for the greatest effectiveness of the muscles, as the experience of all, and especially athletes, proves.

That the nervous system plays a great part in the nutrition of muscles is evident from the fact, among countless others, that it is not possible to use the brain to its greatest capacity and the muscles to their fullest at the same time; the individual

engaged in physical "training" must forego severe mental application. Nervous energy is required for the muscles, and all questions of blood-supply are, though important, subordinate. But it would be premature to enter into a full discussion of this interesting topic now.

The sense of fatigue experienced after prolonged muscular action is complex, though there can be no doubt that the nerve-centers must be taken into account, since any muscular work that, from being unusual, requires closer attention and a more direct influence of the will, is well known to be more fatiguing. On the other hand, the accumulation of products of fatigue doubtless reports itself through the local nervous mechanism.

Separation of Muscle from the Central Nervous System.—When the nerve belonging to a muscle is divided, certain histological changes ensue, which may be briefly described as fatty degeneration, followed by absorption; and when regeneration of the nerve-fibers takes place on apposition of the cut ends, a more or less complete restoration of the functions of the nerve follows, but the exact nature of the process of repair is not yet fully agreed upon; it seems, in fact, to vary in different cases as to details, though it is likely that, in instances in which there is a complete return to the normal functionally, the axis-cylinders, at all events, are reproduced.

The degeneration downward is complete; upward, only to the first node of Ranvier.

Immediately after the section the irritability of the nerve is increased, but rapidly disappears, from the center toward the periphery (Ritter-Valli law).

In the mean time the muscle has been suffering. Its irritability at first diminishes, then becomes greater than usual to shocks from the make or break of the constant current; but finally all irritability is lost, and fatty degeneration and disappearance of true muscular structure complete the history. It is theoretically interesting, as well as of practical importance, that degeneration may be delayed by the use of the constant current, the significance of which we have already endeavored to explain.

The Influence of Temperature.—If a decapitated frog be placed in water of the ordinary temperature, and heat be gradually applied, the animal does not move (proving that the spinal cord alone is not conscious), but the muscles, when 43° to 50° C. is reached, contract and become rigid, a condition known as "heat-rigor."

There are some advantages in investigating changes in temperature by the graphic method. Curves from a muscle-nerve preparation show that elevation of temperature shortens the latent period and the curve of contraction. Lowering the temperature has an effect exactly opposite, as might be supposed, and these changes take place in the muscles of both cold-blooded and warm-blooded animals, though more marked in the latter.

The modifications evident to the eye are accompanied by others, chemical in nature, and a comparison of these shows that the rapidity and force of the muscular contraction run parallel with the rapidity and extent of the chemical changes.

Certain drugs also modify the form of the muscle-curve very greatly, so that it appears that the molecular action which underlies all the phenomena of muscle and nerve (for what has been said of muscle applies also to nerve, if we substitute nervous impulse for contraction) can go on only within those narrow bounds which, one realizes more and more in the study of physiology, are set to the activities of living things.

What is the Intimate Nature of Muscular and Nervous Action?—

The answers to these questions, to which some allusion has been already made, are by no means certain. Some believe that, since the nitrogeous waste of the body, if judged by the urea of the urine, is not augmented, some carbohydrate breaks up, which would be in accord with the fact that the gaseous interchange of the body generally is increased during exercise, especially the excretion of carbonic anhydride.

Upon the whole, however, such a view does not harmonize well with the behavior of protoplasm generally, and it is possible to conceive of other processes which would give rise to carbonic anhydride and additional waste products.

It seems to be likely that the muscle protoplasm builds up and breaks down as a whole; that this is constantly going on; and that the oxygen which is stored away (intra-molecular) suffices for immediate use; but that when a contraction takes place all the chemical processes are heightened, so that we may conceive most naturally of the various aspects of muscular life as phases of a whole, the parts of which are closely linked together.

Another unsettled point is the explanation of the fact that a nerve, when stimulated nearer the nerve-center, gives rise to a more marked contraction, with the same stimulus than when excited nearer the muscle.

Some suppose that the change that in a nerve constitutes an

impulse gathers force as it proceeds—the avalanche theory of Pflüger; but it would seem more natural to refer this effect to the greater irritability of the nerve nearer the centers.

The chemistry of dead nerves throws extremely little light on the nature of nervous processes. The latter seem, in fact, to be accompanied by chemical changes which almost entirely elude our methods of detection and estimation. Relatively to the chemical the electrical phenomena are predominant; but nerve-force is not electrical force, nor are we prepared yet to teach that it is the equivalent of that or any other force known to us.

The fact that a nerve maintained in a condition approximately normal may be stimulated for hours without exhaustion, has led some to adopt the tempting conclusion that there are no invariable chemical accompaniments of nervous excitation. But in this and all other instances we think that general principles must not be readily set aside by special cases, and we should ourselves hesitate to adopt any opinion so contrary to *all* that is known of organic processes as this theory implies, except on the amplest and clearest evidence; and we lay the more stress on this, because we think it is a sample of the sort of reasoning that is apt to become over-potent with those that derive their conclusions wholly or chiefly from laboratory experiments, to the neglect of wider observations, which put the more limited, and possibly more accurate, ones derived from the former source, in a truer light, and enable us to establish juster relations.

UNSTRIPED MUSCLE.

This form of muscular tissue is characterized by its long latent period, its slow wave of contraction, its not passing into tetanus, and the progress of the contraction being in either a transverse or longitudinal direction, a wave of contraction in one cell being capable of setting up a corresponding wave in adjoining cells even when no nerve-fibers are distributed to them. It is excited, though less readily, by all the kinds of stimuli that act upon striped muscle. In the higher groups of animals this tissue is chiefly confined to the viscera of the chest and abdomen, constituting in the case of some of them the greater part of the whole organ.

The slow but powerful and rhythmical contraction of this form of muscle adapts it well to the part such organs play in

the economy. There are variations, however, in the rapidity, force, regularity, and other qualities of the contraction in different parts: thus, it is comparatively rapid in the iris, and extremely powerful and regular in the uterus, serving to produce that prolonged yet intermittent pressure essential under the circumstances (expulsion of the fœtus).

Comparative.—Muscular contraction is relatively sluggish and prolonged among the invertebrates, to which, however, the movement of the wings of insects is a marked exception, some of them having been shown by the graphic method to vibrate some hundreds of times in a second.

The slow movements of the snail are proverbial. As a rule, the strength of the muscles of the invertebrates is incomparably greater than that of vertebrates, as witness the powerful grasp of a crab's claw or a beetle's jaws.

These facts are in harmony with the generally slow metabolism of most invertebrates and the lower vertebrates.

The muscles of the tortoise contract tardily but with great power, resist fatigue well, retain their vitality under unfavorable conditions, and after death for a very long period (days).

Without resorting to elaborate experiments, the student may convince himself of the truth of most of the above statements by observing the movements of a water-snail attached to a glass vessel; the note made by the buzzing of an insect, and comparing it with one approaching it in pitch sounded by some instrument of music; the force necessary to withdraw the foot or tail of a tortoise; the peristaltic movements of the intestine and other organs in a freshly killed animal; or the action of a bee, wasp, or wood-boring beetle on the cork of a bottle in which one of them may be inclosed.

SPECIAL CONSIDERATIONS.

In the case of weakly (phthisical) persons a sharp tap on the chest will often produce a contraction of the muscles thus stimulated; but, in addition, a local contraction lasting some little time, known as a *wheal* or *idio-muscular* contraction, follows. This phenomenon seems to be the result of a special irritability in such muscles.

Cramp may arise under a great variety of circumstances, but it seems to be in all cases either a complete prolonged tetanus, in which there is unusual muscular shortening in severe cases, at least, or the persistence of a contraction remainder.

The great differences known to exist between individuals of the same species in strength, endurance, fleetness, and other particulars in which the muscles are concerned, raise numerous interesting inquiries. The build of the greyhound or race-horse suggests in itself part of the explanation on mechanical principles, lung capacity, etc. But when it is found that one dog, horse, deer, or man excels another of the same race in swiftness or endurance, and there is nothing in the form to furnish a solution, we are prompted to ask whether the muscles may not contract more energetically, experience a shortening of the latent period, or other phase of contraction; or whether they produce less of waste-products or get rid of them more rapidly. The whole subject is extremely complicated, and we may say here that there is some evidence to show that in races of dogs and other animals which surpass their fellows, the nerve regulating the heart and lungs (*vagus*) has greater power; but, leaving this and much more out of the account, it is likely there are individual differences in the functional nature of the muscle. Of equal or more importance is the energizing influence of the nervous system, which probably under great excitement (public boat-races, etc.) acts to produce in man those supermaximal contractions which seem to leave the muscle long the worse of its unusual action. The nerve-centers, it is likely, suffer still more from excessive discharge of nerve-force (as we may speak of it for the present) necessary to originate the muscular work. Hence the importance of training to minimize the non-effective expenditure, ascertain the capacity possessed, learn the direction in which weaknesses lie; and equally important the much-neglected period of rest before actual contests—if such are to be undertaken at all—so that all the activities of the body may gather head, and thus be prepared to meet the unusual demand upon them.

The law of rhythm in organic nature is beautifully illustrated by the behavior of nerve and especially muscle; at least it is more obvious in the case of muscle, at this stage of our progress.

The regularity with which one phase succeeds another in a single contraction; the essentially rhythmic (vibratory) character of tetanus, fatigue and recovery; the recurrence of increase and decrease in the muscle and nerve currents—in fact, the whole history of muscle is an admirable commentary on the truth of the law of rhythm, into which in further detail space will not permit us to enter.

It is a remarkable fact that the endurance of man, especially civilized man, seems to be greater than that of any other mammal. It may be hazardous to express a dogmatic opinion as to the reason of this, but the influence of the mind over the body is unquestionably greater in man than in any other animal; and, if we are correct in assigning so much importance to the influence of the *nervous* system in maintaining the proper molecular balance which is at the foundation of the highest good of an organism, we certainly think that it is in this direction we must look for the explanation of the above-mentioned fact, and much more that would otherwise be obscure in man's functional life.

Functional Variations.—We have endeavored, in treating this subject of muscle, to point out how the phenomena vary with the animal, the kind of muscle, and the circumstances under which they are manifested. It may be shown that every one of the qualities which a muscle possesses, varies with the temperature, the blood-supply, the duration of its action, the character of the stimulus, and other modifying agents. Not only are there great variations for different groups of animals, but lesser ones for individuals; though the latter are made more evident indirectly than when tested by the usual laboratory methods; but they must be taken account of if we would understand animals as they are. Some of these will be referred to later.

If a muscle-cell be regarded in the aspect that we are now emphasizing, its study will tend to impress those fundamental biological laws, the comprehension of which is of more importance than the acquisition of any number of facts, which, however interesting, can, when isolated, profit little.

Experiment has not done much directly, and it seems can not at present, for the physiology of man, though more may be accomplished as regards muscle and nerve than some other tissues. It is, of course, possible to measure the rapidity of the passage of a nervous impulse and to study electrical phenomena generally to some extent. Putting all that is known together, it would appear that, without referring to minor differences which unquestionably exist, the muscle and nerve physiology of man corresponds pretty closely with that of one of the highest mammals, and, as compared with the lower vertebrates, his muscles and nerves possess an irritability of a very exalted type, with, however, a corresponding loss or difference in other directions.

Summary of the Physiology of Muscle and Nerve.—The movements of a muscle are distinguished from those of other forms of protoplasm by their marked definiteness and limitation.

The contraction of a muscle-fiber (cell) results in an increase in its short transverse diameter, and a diminution of its long diameter, without appreciable change in its total bulk.

Muscle and nerve are not automatic, but are irritable. Though muscle normally receives its stimulus through a nerve, it possesses independent irritability.

Stimuli may be mechanical, chemical, thermal, electrical, and in the case of muscle, nervous; and to be effective they must be applied suddenly and last for a brief but appreciable time.

Electrical stimulation, especially, is only effective when there is a sudden change in the force or direction of the currents. This applies to both muscle and nerve.

A muscular contraction consists of three phases: the latent period, the period of rising, and the period of falling energy, or of contraction and relaxation.

When the phase of relaxation is minimal and that of contraction approaches continuity, a tetanus results. The contractions of the muscles *in situ* are tetanic, and are accompanied by a low sound, evidence in itself of their vibratory character.

The prolonged contraction of a muscle leads to fatigue; owing in part, at least, to the accumulation of waste-products within the muscle which depress its energies.

This is a necessary consequence of the fact that all protoplasmic activity is accompanied by chemical change, and that some of these processes result in the formation of products which are hurtful and are usually rapidly expelled.

Muscular contraction is accompanied by chemical changes, in which the formation of carbon dioxide, and some substance that causes an acid reaction to take the place of an alkaline or neutral one. Since free oxygen is not required for the act of contraction, but is still used up by a contracting muscle, it may be assumed that the oxygen that plays a part in actual contraction is intra-molecular.

Chemical changes are inseparable from the vital processes of all protoplasm, and the phenomena of muscle show that they are constantly in operation, but exalted during ordinary contraction and that tetanic condition which precedes and may end in coagulation of muscle plasma and the formation of myosin. The latter is a result of the disorganization of muscle, and has points of resemblance to the coagulation of the blood.

The contraction of a muscle, and the passage of a nervous impulse, are accompanied by electrical changes. Whether currents exist in uninjured muscle and nerve is a matter of controversy. All physiologists agree that they exist in muscle (and nerve) during functional activity. This electrical condition is termed the "negative variation" by those believing in currents of rest, and the "current of action" by those holding opposite opinions. The current is of momentary duration, and is manifested during the latent period of muscle, in which also the chemical changes take place; so that a muscular contraction must be regarded as the outcome of the events of the latent period, which is, therefore, though the shortest, the most important of the phases of a muscular contraction.

During the passage of a constant (polarizing) current from a battery through a nerve, it undergoes a change in its irritability and shows a variation in the electro-motive force of the ordinary nerve-current (electrotonus). This fact is of therapeutic importance. The electrical phenomena of nerve are altogether more prominent than the chemical, the reverse of which is true of muscle. The activity of a muscle (and nerve probably) is accompanied by the generation of heat, an exaltation of which takes place during muscular contraction.

Rigor mortis causes an increase in temperature and the chemical interchanges which accompany the other phenomena. A muscle may also become rigid by passing into *rigor caloris*. Living muscle is translucent, alkaline or neutral in reaction, and elastic; dead muscle, opaque, acid in reaction, and devoid of elasticity, but firmer than living muscle, owing to coagulation of the muscle-plasma. Dead nerve undergoes similar changes.

The elasticity of muscle is restricted but perfect within its own limits. It differs from that of inorganic bodies in that the increments of extension are not directly proportional to the increments of the weight. When overstretched, muscle does not return to its original length (loss of elasticity), hence the serious nature of sprains.

It is important to regard muscular elasticity as an expression of vital properties.

The work done by a muscle is ascertained by multiplying the load lifted by the height; and the capacity of an individual muscle will vary with its length, the arrangement of its fibers; and the area of its cross-section (i. e., on the number of fibers).

The work done may be regarded as a function of the resist-

ance (load), as the contraction is also a function of the stimulus. The separation of a muscle from its nerve by section of the latter leads to certain changes, most rapid in the nerve, which show that the two are so related that prolonged independent vitality of the muscle is impossible, and make it highly probable that muscle is *constantly* receiving some beneficial stimulus from nerve, which is exalted and manifest when contraction takes place.

The study of the development of the electrical cells of certain fishes shows that they are greatly modified muscles in which contractility, etc., has been exchanged for a very decided exaltation of electrical properties. It is likely, though not demonstrated, that all forms of protoplasm undergo electrical changes—that these, in fact, like chemical phenomena, are vital constants.

The phases of the contraction of smooth muscular tissue are all of longer duration; the contraction-wave passes in different directions, and may spread into cells devoid of nerves, which we think not unlikely also to be the case, though less so, for all forms of muscle.

The smooth muscle-cell must be regarded as a more primitive, less specialized, form of tissue. Variations in all the phenomena of muscle with the animal and the circumstances are clear and impressive. Finally, muscle illustrates an evolution of structure and function, and the law of rhythm.

THE NERVOUS SYSTEM.—GENERAL CONSIDERATIONS.

Since in the higher vertebrates the nervous system is dominant, regulating apparently every process in the organism, it will be well before proceeding further to treat of some of its functions in a general way to a greater extent than we have yet done.

Manifestly it must be highly important that an animal shall be able to place itself so in relation to its surroundings that it may adapt itself to them. Prominent among these adaptations are certain movements by which food is secured and dangers avoided. The movements having a central origin, a peripheral mechanism of some kind must exist so as to place the centers in connection with the outer world. Passing by the evolution of the nervous system for the present, it is found that in vertebrates generally there is externally a modification of the epi-

thelial covering of the body (*end-organ*) in which a nerve terminates, which latter may be traced to a cell or cells removed from the surface (*center*), and from which in most cases other nerves proceed.

The nervous system, we may remind the student, consists in vertebrates of centers in which nerve-cells abound, united by nerve-fibers and by the most delicate form of connective tissue known, in connection with which there are incased strands of protoplasm or nerves as outgrowths. The main centers are, of course, aggregated in the brain and spinal cord.

It is possible to conceive of the work of a nervous system carried on by a single cell and an afferent and efferent nerve; but inasmuch as such an arrangement would imply that the central cell should act the part of both receiving and originating impulses (except it were a mere conductor, in which case there would be no advantage whatever in the existence of a cell at all), according to the principle of the physiological division of labor, we might expect that there would be at least two central cells—one to receive and the other to transmit impulses—or at least that there should be some specialization among the central cells; and we shall have good reason later to believe that this has reached a surprising degree in the highest animals.

Moreover, it would be a great advantage if the termination of the ingoing (afferent) nerve should not lie exposed on the surface, but be protected by some form of cell that had also the power to transmit to it the impressions received from without, in a form suitable to the nature of the nerve and the needs of the organism.

So that a complete mechanism in its simplest form would furnish: 1. A peripheral cell or nerve end-organ. 2. An afferent or sensory nerve. 3. Two or more central cells. 4. An efferent nerve, usually connected with—5. A muscle or other form of cell, the action of which may be modified by the outgoing nerve, or, as we should prefer to say, by the central nervous cells through the efferent nerve. The advantages of the principal cells being within and protected are obvious.

When, then, an impression made on the peripheral cell is carried inward, there modified, and results in an outgoing nervous impulse answering to the afferent one, giving rise to a muscular contraction or other effect not confined to the recipient cells, the process is termed *reflex action*.

The great size, the multiplicity of forms, the distinct out-

line and large nuclei of nerve-cells, suggest the probability that they play a very important part, and such is found to be the case. Indeed, in some sense the rest of the nervous system may be said to exist for them.

Probably nerve-cells do sometimes act as mere conductors of nervous impulses originating elsewhere, but such is their lowest function. Accordingly, it is found that the nature of any reflex action depends most of all on the behavior of the central cells.

It can not be too well borne in mind that nerves are conductors and such only. They *never* originate impulses.

The properties considered in the last chapter are common to all kinds of nerves known; and though we must conceive that there are some differences in the form of impulses, these are to be traced, not to the nerve primarily, but to the organ in which it ends peripherally or to the central cells.

To return to reflex action, it is found that the muscular response to a peripheral irritation varies with the point stimulated, the intensity of the stimulus, etc., but is, above all, determined by the central cells.

Nerve influence may be considered as following lines of least resistance, and there is much evidence to show that an impulse having once taken a certain path, it is easier for it to pass in this direction a second time, so that we have the foundation of the laws of habit and a host of interesting phenomena in this simple principle.

It is found that, in a frog deprived of its brain and suspended by the under jaw, there is no movement unless some stimulus be applied; but if this be done under suitable conditions, instructive results follow, which we now proceed to indicate briefly. The experiments are of a simple character, which any student may carry out for himself.

Experimental.—Preparing a frog by cutting off the whole of the upper jaw and brain-case after momentary anæsthesia, suspend the animal by the lower jaw and wait till it is perfectly quiet. Add to water in a beaker sulphuric acid till it tastes distinctly but not strongly sour, to be used as a stimulus. 1. Apply a small piece of bibulous paper, moistened with the acid, to the inner part of the thigh of the animal. The leg will be drawn up and the paper probably removed. Remove the paper and cleanse the spot. 2. Apply a similar piece of paper to the middle of the abdomen; one or both legs will probably be drawn up, and wipe off the offending body. 3. Let the foot of

the frog hang in the liquid; after a few moments it will be withdrawn. 4. Repeat, holding the leg; probably the other leg will be drawn up. 5. Apply stronger acid to the inside of the right thigh; the whole frog may be convulsed, or the left leg may be put in action after the right. Even if the stimulating paper be applied near the anus, it will be removed by the hind-legs. 6. Beneath the skin of the back (posterior lymph-sac) inject a few drops of liquor strychniæ of the pharmacopœia; after a few minutes apply the same sort of stimulus to the thigh as before. The effects follow more quickly and are

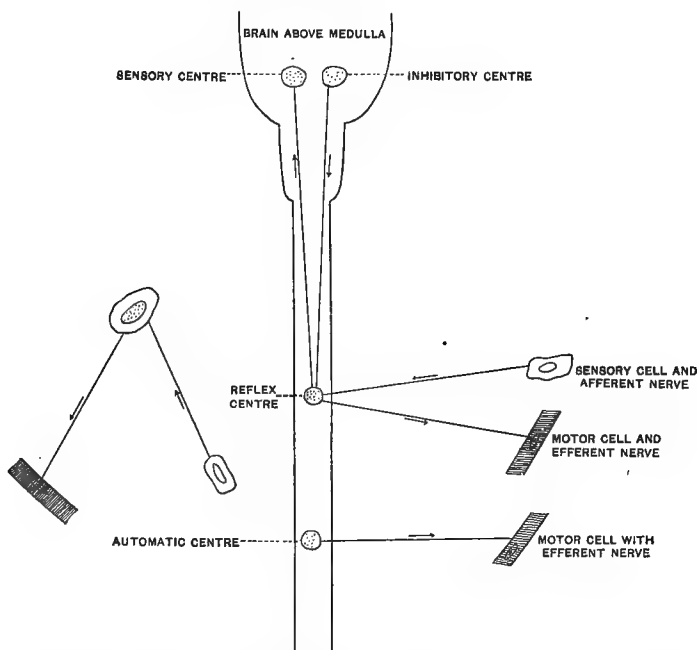

FIG. 195.—Diagram intended to illustrate nervous mechanism of—1, automatism; 2, reflex action; and 3, how nervous impulses in the latter case may pass into the higher parts of brain and become part of consciousness, or be wholly inhibited. A reflex or automatic center may for the sake of simplicity be reduced to a single cell, as above on the left.

much more marked—the animal, it may be, passing into a general tetanic spasm.

These experiments may be varied, but suffice to establish the following conclusions: 1. The stimulus is not immediately effective, but requires to act for a certain variable period, depending chiefly on the condition of the central nervous system. 2. The movements of the muscles harmonize (are co-ordinated), and tend to accomplish some end—are purposive. If

the nerve alone and not the skin be stimulated, there may be a spasm only and not adaptive movement. 3. Nervous impulses, when very abundant, may pass along unaccustomed or less accustomed paths (experiments 4 and 5). This is sometimes spoken of as the radiation of nervous impulses.

The sixth experiment is very important, for it shows that the result varies far more with the condition of the nervous centers (cells) than the stimulus, the part excited, or any other factor.

Automatism.—But, seeing that these central cells have such independence and controlling power, the question arises, Are these, or are there any such cells, capable of originating impulses in nerves wholly independent of any stimulus from without? In other words, have the nerve-centers any true automatism? Apparently this quality is manifested by unicellular organisms of the rank of *Amœba*. Has it been lost, or has it become a special characteristic developed to a high degree in nerve-cells?

We shall present the facts and the opinions based on them as held by the majority of physiologists, reserving our own criticisms for another occasion: 1. The medulla oblongata is supposed to be the seat of numerous small groups of cells, to a large extent independent of each other, that are constantly sending out nervous impulses which, proceeding to certain sets of muscles, maintain them in rhythmical action. One of the best known of these centers is the respiratory. 2. The posterior lymph hearts of the frog are supplied by nerves (tenth pair), which are connected, of course, with the spinal cord. When these nerves are cut, the hearts for a time cease to beat, but later resume their action. 3. The heart beats after all its nerves are cut, and it is removed from the body, for many hours, in cold-blooded animals. 4. The contractions of the intestine take place in the absence of food, and in an isolated piece of the gut. The intestine, it will be remembered, is abundantly supplied with nerve-elements. 5. In a portion of the ureters, from which it is believed nerve-cells are absent, rhythmical action takes place.

Conclusions.—1. Whether the action of the respiratory and similar centers could continue in the absence of all stimuli can not be considered as determined. 2. That there are regular rhythmical discharges from the spinal nerve-cells along the nerves to the lymph hearts seems also doubtful. 3. Later investigations render the automaticity of the heart more uncer-

tain than ever, so that the result stated above (3) must not be interpreted too rigidly.

Similar doubts hang about the other cases of apparent automatism.

As regards the various comparatively isolated collections of cells known as ganglia, the evidence, so far as it goes, is against their possessing either automatic or reflex action; and new views of their nature will be presented in due course.

Nervous Inhibition. — If the pneumogastric nerve passing from the medulla to the heart of vertebrates be divided and the lower (peripheral) end stimulated, a decided change in the action of the heart follows, which may be in the direction of weakening or slowing, or positive arrest of its action.

Assuming, for the present, that the cells (center) of the medulla have the power to bring about the same result, it is seen that such nervous influence is preventive or inhibitory of the normal cardiac beat, so that the vagus is termed an inhibitory nerve. Such inhibition plays a very important part in the economy of the higher animals, as will become more and more evident as we proceed. The nature of the influences that produce such remarkable results will be discussed when we treat of the heart.

An illustration will probably serve in the mean time to make the meaning of what has been presented in this chapter more clear and readily grasped.

In the management of railroads a very great variety of complicated results are brought about, owing to system and orderly arrangement, by which the wishes of the chief manager are carried out.

Telegraphing is of necessity extensively employed. Suppose a message to be conveyed from one office to another, this may (1) simply pass through an intermediate office, without special cognizance from the operator in charge; (2) the operator may receive and transmit it unaltered; (3) he may be required to send a message that shall vary from the one he receives in a greater or less degree; or (4) he may arrest the command altogether, owing to the facts which he alone knows and upon which he is empowered always to act according to his best discretion.

In the first instance, we have an analogy with the passage of a nervous impulse through central fibers, or, at all events, unaffected by cells; in the second, the resemblance is to cells acting as conductors merely; in the third, to the usual behavior

of the cells in reflex action; and, in the fourth, we have an instance of inhibition. The latter may also be rendered clear by the case of a horse and its rider. The horse is controlled by the rider, who may be compared to the center, through the reins answering to the nerves, though it is not possible for either rider or reins to originate the movements of the animal, except as they may be stimuli, which latter are only effective when there are suitable conditions—when, in fact, the subject is irritable in the physiological sense.

THE CIRCULATION OF THE BLOOD.

Every tissue, every cell, requiring constant nourishment, some means must necessarily have been provided for the conveyance of the blood to all parts of the organism. We now enter upon the consideration of the mechanisms by which this is accomplished and the method of their regulation.

Let us consider possible mechanisms, and then inquire into their defects and the extent to which they are found embodied in nature.

That there must be a central pump of some kind is evident. Assume that it is one-chambered, and with an outflow-pipe which is continued to form an inflow-pipe. This might be provided with valves at the openings, by which energy would be saved by the prevention of regurgitation. In such a system things must go from bad to worse, as the tissues, by constantly using up the prepared material of the blood, and adding to it their waste products, would effect their own gradual starvation and poisoning.

It might be conceived, however, that waste at all events was got rid of by the blood being conducted through some eliminating organs; and assume that one such at least is set aside for respiratory work. If the blood in its course anywhere passed through such organs, the end would be attained in some degree; but if the division of labor were considerable, we should suppose that, gaseous interchange being so very important as we have been led to see from the study of the chapters on general biology, and on muscle, organs to accomplish this work might receive the blood in due course and return it to the central pump in a condition eminently fit from a respiratory point of view.

Such, however, would necessarily be associated with a more

complicated pump; and, if this were so constructed as to prevent the mixture of blood of different degrees of functional value, higher ends would be attained.

Turning to the channels themselves in which the blood flows, a little consideration will convince one that rigid tubes are wholly unfit for the purpose. Somewhere in the course of the circulation the blood must flow sufficiently slowly, and through vessels thin enough to permit of that interchange between the blood and the tissues, through the medium of the lymph, which is essential from every point of view. The main vessels must have a strength sufficient to resist the force with which the blood is driven into them.

Now, it is possible to conceive of this being accomplished with an intermittent flow; but manifestly it would be a great advantage, from a nutritive aspect, that the flow and therefore the supply of tissue pabulum be constant. With a pump regularly intermittent in action, provided with valves, elastic tubes having a resistance in them somewhere sufficient to keep them constantly over-distended, and a collection of small vessels with walls of extreme thinness, in which the blood-current is greatly slackened, a steady blood-flow would be maintained, as the student may readily convince himself, by a few experiments of a very simple kind:

1. To show the difference between rigid tubes and elastic ones, let a piece of glass rod, drawn out at one end to a small diameter, have attached to the other end a Higginson's (two-bulb) syringe, communicating with a vessel containing water. Every time the bulb is squeezed, water flows from the end of the glass rod, but the outflow is perfectly intermittent.

2. On the other hand, with a long elastic tube of India-rubber, ending in a piece of glass rod drawn out to a point as before, if the action of the pump (bulb) be rapid the outflow will be continuous. An apparatus that every practitioner of medicine requires to use answers perhaps still better to illustrate these and other principles of the circulation, such as the pulse, the influence of the force and frequency of the heart-beat on the blood-pressure, etc. We refer to a two-bulb atomizer, the bulb nearer the outflow serving to maintain a constant air-pressure.

We may now examine the most perfect form of heart known, that of the mammal, in order to ascertain how far it and its adjunct tubes answer to *a priori* expectations.

The Mammalian Heart.—In order that the student may gain a correct and thorough knowledge of the anatomy of the heart

and the working of its various parts, we recommend him to pursue some such course as the following :

1. To consult a number of plates, such as are usually furnished in works on anatomy, in order to ascertain in a general way the relations of the heart to other organs, and to the chest wall, as well as to become familiar with its own structure.

2. To supplement this with reading the anatomical descriptions, without too great attention to details at first, but with the object of getting his ideas clear so far as they go.

3. Then, with plates and descriptions before him, to examine several dead specimens of the heart of the sheep, ox, pig, or other mammal, first somewhat generally, then systematically, with the purpose of getting a more exact knowledge of the

various structures and their anatomical as well as physiological relations.

We would not have the student confine his attention to any single form of heart, for each shows some one structure better than the others; and the additional advantages of comparison are very great. The heart of the ox, from its size, is excellent for the study of valvular action, and the framework with which the muscles, valves, and vessels are connected; while the heart of the pig (and dog) resemble the human organ more closely than most others that can be obtained.

It will be found very helpful to perform some of the dissections under water, and by the use of this or some other fluid the action of the valves may be learned as it can



FIG. 196.—The left auricle and ventricle opened and part of their walls removed to show their cavities (Allen Thomson). 1, right pulmonary vein cut short; 1', cavity of left auricle; 3, thick wall of left ventricle; 4, portion of the same with papillary muscle attached; 5, 5', the other papillary muscles; 6, one segment of the mitral valve; 7, in aorta is placed over the semilunar valves.

in no other way. By a little manipulation the heart may be so held that water may be poured into the orifices, prepared by a removal of a portion of the blood-vessels or the auricles, when the valves may be seen closing together, and thus revealing their action in a way which no verbal or pictorial representations can do at all adequately.

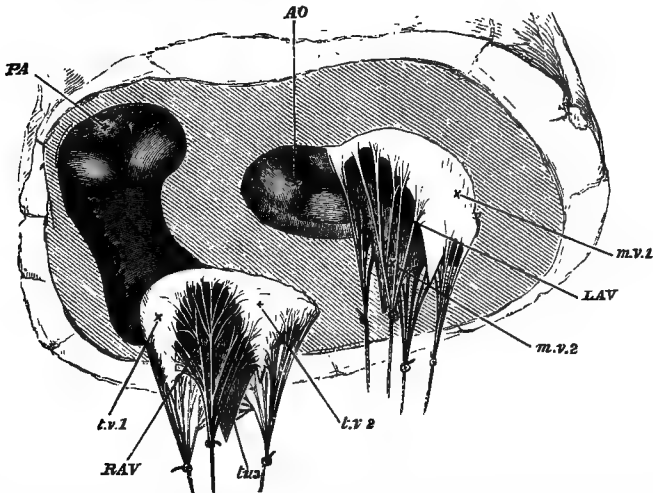

FIG. 197.—View of the orifices of the heart from below, the whole of the ventricles having been cut away (after Huxley). RAV, right auriculo-ventricular orifice, surrounded by the three flaps, *t. v. 1*, *t. v. 2*, *t. v. 3*, of the tricuspid valve, which are stretched by weights attached to the *chordæ tendineæ*. LAV, left auriculo-ventricular orifice, etc. PA, orifice of the pulmonary artery, the semilunar valves represented as having met and closed together. AO, orifice of the aorta.

A heart thoroughly boiled and allowed to get cold shows, on being pulled somewhat apart, the course, attachment, and other features of the fibers very well, as also the skeleton of the organ, which may be readily separated.

When this has all been done, the half is not yet accomplished. A visit to an abattoir will now repay amply for the time spent. Animals are there killed and eviscerated so rapidly that an observer may not only gain a good practical acquaintance with the relations of the heart to other parts, but may often see the organ still living and exemplifying that action peculiar to it as it gradually approaches quiescence and death—a matter of the utmost importance.

If the student will then compare what he has learned of the mammalian heart in this way with the behavior of the heart of a frog, snake, fish, turtle, or other animal that may be killed after brief ether narcosis, without cessation of the heart's ac-

tion, he will have a broader basis for his cardiac physiology than is usual; and we think we may promise the medical student, who will in this and other ways that may occur to him supplement the usual work on the human cadaver, a pleasure and profit in the study of heart-disease which come in no other way.

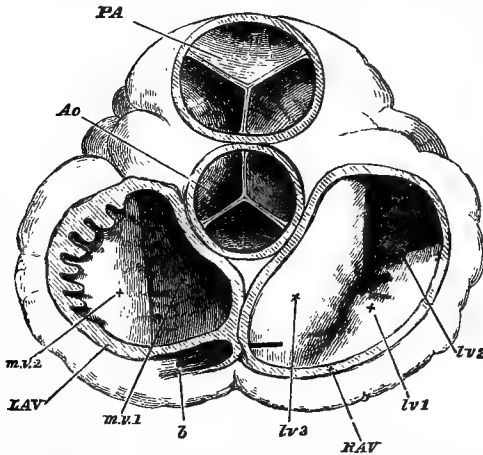

FIG. 198.—Orifices of the heart seen from above, after the auricles and great vessels had been cut away (after Huxley). PA, pulmonary artery, with its semilunar valves. Ao, aorta in a similar condition. RAV, right auriculo-ventricular orifice, with *m. v. 1* and *2* flaps of mitral valve; *b*, style passed into coronary vein. On the left part of LAV the section of the auricle is carried through the auricular appendage, hence the toothed appearance due to the portions in relief cut across.

work for the attachment of valves, vessels, and muscle-fibers; the great complexity of the arrangement of the latter; the various lengths, mode of attachment, and the strength of the inelastic chordæ tendineæ; the papillary muscles which doubtless act at the moment the valves flap back, thus preventing the latter being carried too far toward the auricles, the pocketing action of the semilunar valves, with their strong margin and meeting nodules (*corpora aurantii*); the relative thickness of auricles and ventricles, and the much greater thickness of the walls of the left than of the right ventricle—differences which are related to the work these parts perform.

The latter may be well seen by making transverse sections of the heart of an animal, especially one that has been bled to death, which specimen also shows how the contraction of the heart obliterates the ventricular cavity.

It will also be well worth while to follow up the course of the coronary arteries, noting especially their point of origin.

The examination of the valves of the smaller hearts of cold-blooded animals is a matter of greater difficulty and is facili-

tated by dissection under water with the help of a lens or dissecting microscope; but even without these instruments much may be learned, and certainly that the valves are relatively to those of the mammalian heart imperfectly developed, will become very clear.

CIRCULATION OF THE BLOOD IN THE MAMMAL.

It is highly important and quite possible in studying the circulation to form a series of mental pictures of what is transpiring. It will be borne in mind that there is a set of elastic tubes of relatively thick walls, standing open when cut across, dividing into smaller and smaller branches, and finally ending in vessels of more than cobweb fineness, and opening out into others, that become larger and larger and fewer and fewer, till they are gathered up into two of great size which form the right auricle. The larger pipes consist everywhere of elastic tissue proper, muscular tissue (itself elastic), fibrous tissue, and a flat epithelial lining, so smooth that the friction therefrom must be minimal as the blood flows over it.

The return tubes or veins are like the arteries, but so thin that their walls fall together when cut across. They are different from all the other blood-tubes in that they possess valves opening toward the heart throughout their course. The veins are at least twice as numerous as the arteries, and their capacity many times greater. The small vessels or capillaries are so abundant and wide-spread that, as is well known, the smallest cut anywhere gives rise to a flow of blood, owing to section of some of these tubes, which, it will be remembered, are not visible to the unaided eye. It is estimated that their united area is several hundred (500 to 800) times that of the arteries.

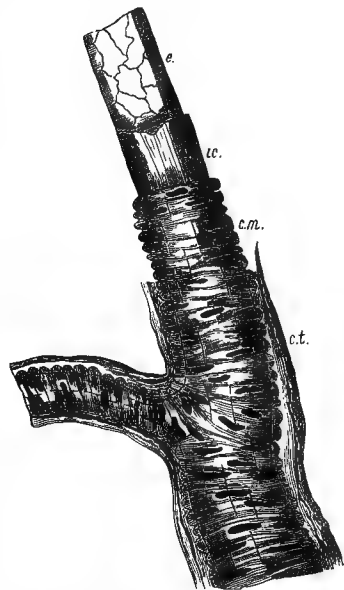

FIG. 199.—Various layers of the walls of a small artery (Landois). *e.*, endothellum; *i. e.*, internal elastic lamina; *c. m.*, circular muscular fibers of the middle coat; *c. t.*, connective tissue of the outer coat, or T. adventitia.

If we suppose the epithelial lining pushed out of a small artery we have, so far as structure alone goes, a good idea of a capillary—i. e., its walls are but one cell thick, and these cells

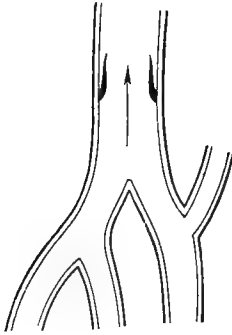

FIG. 200.

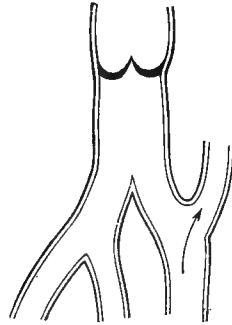

FIG. 201.

FIG. 200.—Vein with valves lying open (Dalton).

FIG. 201.—Vein with valves closed, the blood passing on by a lateral branch below (Dalton).

though long are extremely thin, so that it is quite easy to understand how it is that the amoeboid corpuscles can, under cer-

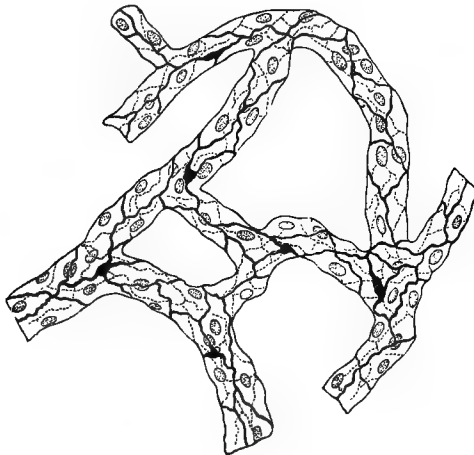

FIG. 202.—Capillary blood-vessels (Landois). The cement-substance between the endothelium has been rendered dark by silver nitrate, and the nuclei made prominent by staining.

tain circumstances, push their way through its probably semi-fluid walls.

From what has been said, it will be seen that the whole collection of vascular tubes may be compared to two inverted fun-

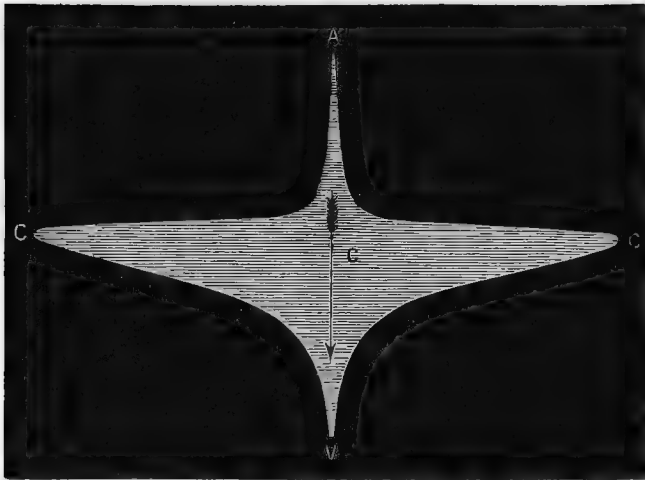

FIG. 203.—Diagram to illustrate the relative proportions of the aggregate sectional area of the different parts of the vascular system (after Yeo). A, aorta; C, capillaries; V, veins.

nels or cones with the smaller end toward the heart and the widest portions representing the capillaries.

THE ACTION OF THE MAMMALIAN HEART.

Very briefly what takes place may be thus stated: The right auricle contracting squeezes the blood through the auriculo-ventricular opening into the right ventricle, never quite emptying itself probably; immediately after the right ventricle contracts, by which its valves are brought into sudden tension and apposition, thus preventing reflux into the auricle; while the blood within it takes the path of least resistance, and the only one open to it into the pulmonary artery, and by its branches is conveyed to the capillaries of the lungs, from which it is returned freed from much of its carbonic anhydride and replenished with oxygen, to the left auricle, whence it proceeds in a similar manner into the great arterial main, the aorta, for general distribution throughout the smaller arteries and the capillaries to the most remote as well as the nearest parts, from which it is gathered up by the veins and returned laden with many impurities, and robbed of a large proportion of its useful matters, to the right side of the heart.

It will be remembered that corresponding subdivisions of each side of the heart act simultaneously, and that any decided

departure from this harmony of rhythm would lead to serious disturbance.

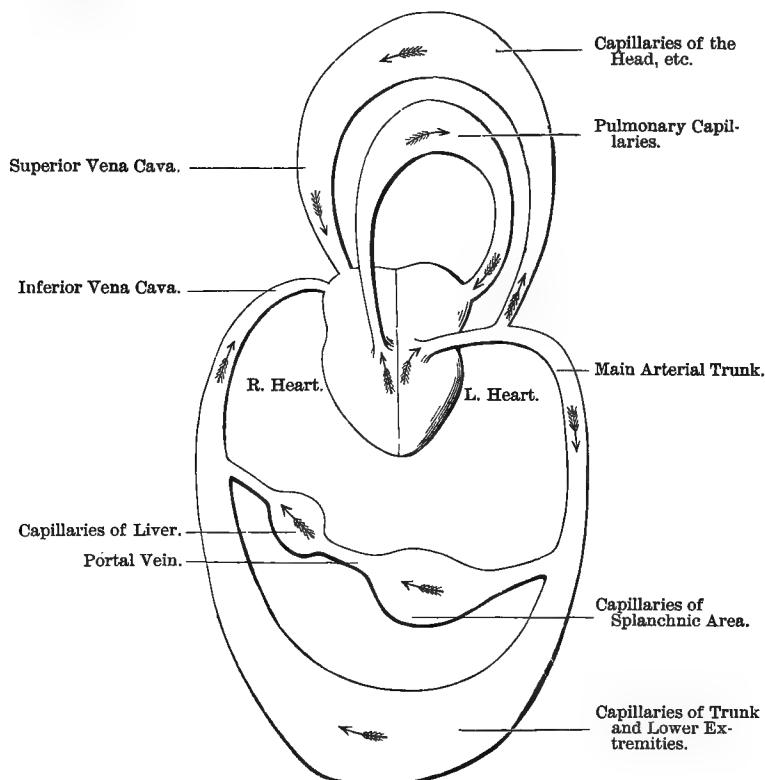

FIG. 204.—Diagram of the circulation. The arrows indicate the course of the blood. Though the pulmonary and the upper and the lower parts of the systemic circulation are represented so as to show the distinctness of each, it will be also apparent that they are not independent. Relative size of different parts of the system is only very generally indicated.

THE VELOCITY OF THE BLOOD AND BLOOD-PRESSURE.

If the relative capacity and arrangement of the various parts of the circulatory system be as has been represented, it follows that we may predict with some confidence, apart from experiment, what the speed of the flow and the vascular tension must be in different parts of the course of the circulation.

We should suppose that, in the nature of the case, the velocity would be greatest in the large arteries, gradually diminish to the capillaries, in which it would be much the slowest, and, getting by degrees faster, would reach a speed in the largest veins approaching that of the corresponding arteries.

The methods of determining the velocity of the blood-stream have not entirely surmounted the difficulties, but they do give results in harmony with the above-noted anticipations.

The area of the great aortic trunk being so much less than that of the capillaries, the flow in that vessel we should expect to be very much swifter than in the arterioles or the capillaries. Moreover, there must be a great difference in the velocity during cardiac systole and diastole, and according as the beat of the heart is forcible or otherwise. But, apart from these more obvious differences, there are variations depending on complex changes in the peripheral circulation, owing to the frequent variations in the diameter of the arterioles in different parts, as well as differences in the resistance offered by the capillaries, the causes of which are but ill understood, though less obscure, we think, than they are often represented to be. Since, for the maintenance of the circulation, the quantity of blood entering and leaving the heart must be equal, in consequence of the sectional area of the great veins that enter the heart being greater than that of the aorta, it follows that the venous flow even at its quickest is necessarily slower than the arterial.

Comparative.—There must be great variations in velocity in different animals, as such measurements as have been made demonstrate. Thus, in the carotid of the horse, the speed of the blood-current is calculated as about 306 mm., in the dog at from 205 to 357 mm. These results can not be considered as more than fair approximations.

Highly important is it to note that the rate of flow in the capillaries of all animals is very slow indeed, not being as much as 1 mm. in a second in the larger mammals. The time occupied by the circulation is also, of course, variable, being as a rule shorter the smaller the animal. As the result of a number of calculations, though by methods that are more or less faulty, the following law may be laid down as meeting approximately the facts so far as warm-blooded animals are concerned:

The circulation is effected by 27 heart-beats; thus, for a man with a pulse of 81, the time occupied in the completion of the course of the blood from and to the heart would be $\frac{81}{27} = 3$; i. e., the circulation is completed three times in one minute, or its period is twenty seconds; and it is to be well borne in mind that by far the greater part of this time is occupied in traversing the capillaries.

THE CIRCULATION UNDER THE MICROSCOPE.

There are few pictures more instructive and impressive than a view of the circulation of the blood under the microscope. It is well to have similar preparations, one under a low power and another under a magnification of 300 to 500 diameters. With the former a view of arterioles, veins, and capillaries may be

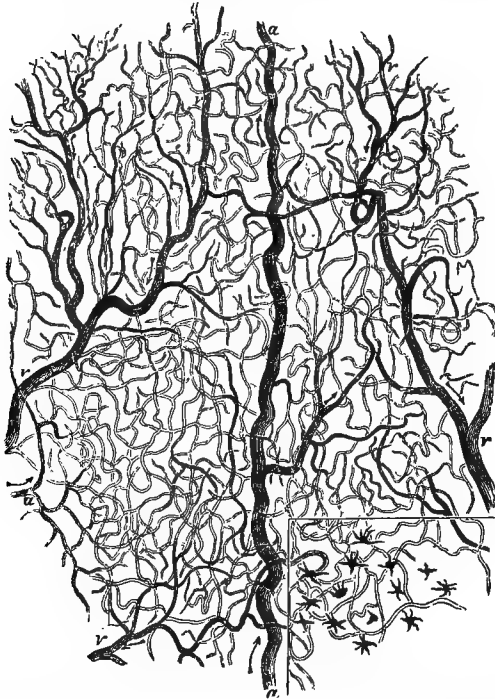

FIG. 205.—Portion of the web of a frog's foot as seen under a low magnifying power, showing the blood-vessels, and in one corner the pigment-spots (after Huxley). *a*, small arteries (arterioles); *v*, small veins. The smaller vessels are the capillaries. The course of the blood is indicated by arrows.

obtained at once. Many different parts of animals may be used, as the web of the frog's foot, its tongue, lung, or mesentery; the gill or tail of a small fish, tadpole, etc.

The relative size of the vessels; the speed of the blood-flow; the greater velocity of the central part of the stream; the aggregation of colorless corpuscles at the sides of the vessels, and the occasional passage of one through a capillary wall, when the exposure has lasted some time; the crowding of the red cells; their plasticity; the small size of some of the capillaries, barely

allowing the corpuscles to be squeezed through; the changes in the velocity of the current, especially in the capillaries; its possible arrest or retrocession; the velocity in one so much greater than in its neighbor, without very obvious cause—all this and much more forms, as we have said, a remarkable lesson for the thinking student. This, like all microscopic views, especially if motion is represented, has its fallacies. It is to be remem-

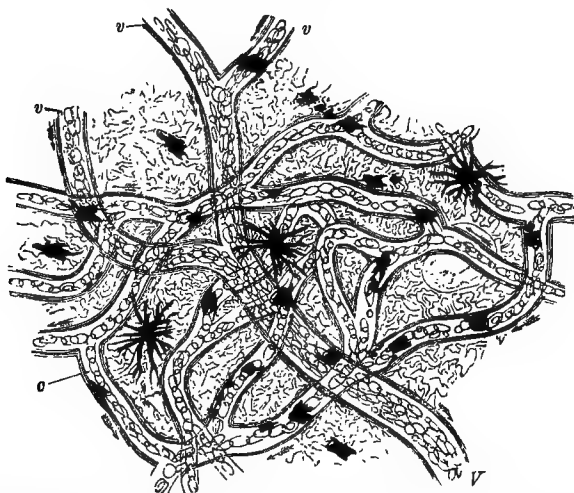

FIG. 206.—Circulation in the web of the frog's foot (Wagner). *V*, venous trunk composed of the three principal branches (*v, v, v*), covered with a plexus of smaller vessels. The whole is dotted over with pigment masses.

bered that the movements are all magnified, or else one is apt to suppose the capillary circulation extremely rapid, whereas it is like that of the most sluggish part of a stream, and very irregular.

THE CHARACTERS OF THE BLOOD-FLOW.

If an artery be opened, the blood is seen to flow from it in a constant stream, with periodic exaggerations, which, it is found, answer to the heart-beats; in the case of veins and capillaries the flow is also constant, but shows none of the spurting of the arterial stream, nor has the cardiac beat apparently an equal modifying effect upon it.

We have already explained why the flow should be constant, though it would be well to be clearer as to the peripheral resistance. The amount of friction from linings so smooth as

those of the blood-vessels can not be considerable. Whence, then, arises that friction which keeps the arterial vessels always distended by its backward influence? The microscopic study of the circulation helps to answer this question. The plasticity of the corpuscles and of the vessel walls themselves must be taken into account, in consequence of which a dragging influence is exerted whenever the corpuscles touch the wall, which must constantly happen with vast numbers of them in the smallest vessels and especially in the capillaries. The arrangement of capillaries into a mesh-work, must also, in consequence of so many angles, be a source of much friction.

The action of the corpuscles on one another may be compared to a crowd of people hurrying along a narrow passage—the obstruction comes from interaction of a variety of forces, owing to the crowd itself rather than the nature of the thoroughfare. We must set down a great deal to the influence of the corpuscles on one another, as they are carried along, according to mechanical principles; but, as we shall see later, other and more subtle factors play a part in the capillary circulation. Owing to the peripheral resistance and the pumping force of the heart, the arteries become distended, so that, during cardiac diastole, their recoil, owing to the closure of the semilunar valves, forces on the blood in a steady stream. It follows, then, that the main force of the heart is spent in distending the arteries, and that the immediate propelling force of the circulation is the elasticity of the arteries in which the heart stores up the energy of its systole for the moment.

BLOOD-PRESSURE.

Keeping in mind our schematic representation of the circulation, we should expect that the blood must exercise a certain pressure everywhere throughout the vascular system; that this blood-pressure would be highest in the heart itself; considerable in the whole arterial system, though gradually diminishing toward the capillaries, in which it would be feeble; lower still in the smaller veins; and at its minimum where the great veins enter the heart. Actual experiments confirm the truth of these views; and, as the subject is one of considerable importance, we shall direct attention to the methods of estimating and recording an animal's blood-pressure.

First of all, the well-known fact that, when an artery is cut, the issuing stream spurts a certain distance, as when a water-

main, fed from an elevated reservoir, bursts, or a hydrant is opened, is itself a proof of the existence of blood-pressure, and is a crude measure of the amount of the pressure.

One of the simplest and most impressive ways of demonstrating blood-pressure is to connect the carotid, femoral, or other large artery of an animal by means of a small glass tube (drawn out in a peculiar manner to favor insertion and retention by ligature in the vessel), known as a cannula, by rubber tubing, with a long glass rod of bore approaching that of the artery opened, into which the blood is allowed to flow through the above-mentioned connections, while it is maintained in a vertical position.

To prevent the rapid coagulation of the blood in such experiments, it is customary to fill the cannula and other tubes to a certain extent, at least, with a solution of some salt that tends to retard coagulation, such as sodium carbonate or bicarbonate, magnesium sulphate, etc. If other connections are made in a similar way with smaller arteries and veins, it may be seen that the height of the respective columns, representing the blood-pressure, varies in each and in accordance with expectations.

While all the essential facts of blood-pressure and many others may be illustrated by the above simple methods, it is inadequate when exact measurements are to be made or the results to be recorded for permanent preservation; hence apparatus of a somewhat elaborate kind has been devised to accomplish these purposes.

The graphic methods are substantially those already explained in connection with the physiology of muscle; but, since it is often desirable to maintain blood-pressure experiments for a considerable time, instead of a single cylinder, a series so connected as to provide a practically endless roll of paper (Fig. 208) is employed.

When, in the sort of experiments referred to above, the height of the fluid used in the glass tube to prevent coagulation just suffices to prevent outflow from the artery into the connections, we have, of course, in this a measure of the blood-pressure; however, it is convenient in most instances to use mercury, contained in a glass tube bent in the form of a U, for a measure, as shown in the subjoined illustration. It is also desirable, in order to prevent outflow of the blood into the apparatus, to get up a pressure in the U-tube or manometer as near as may be equal to that of the animal to be employed in

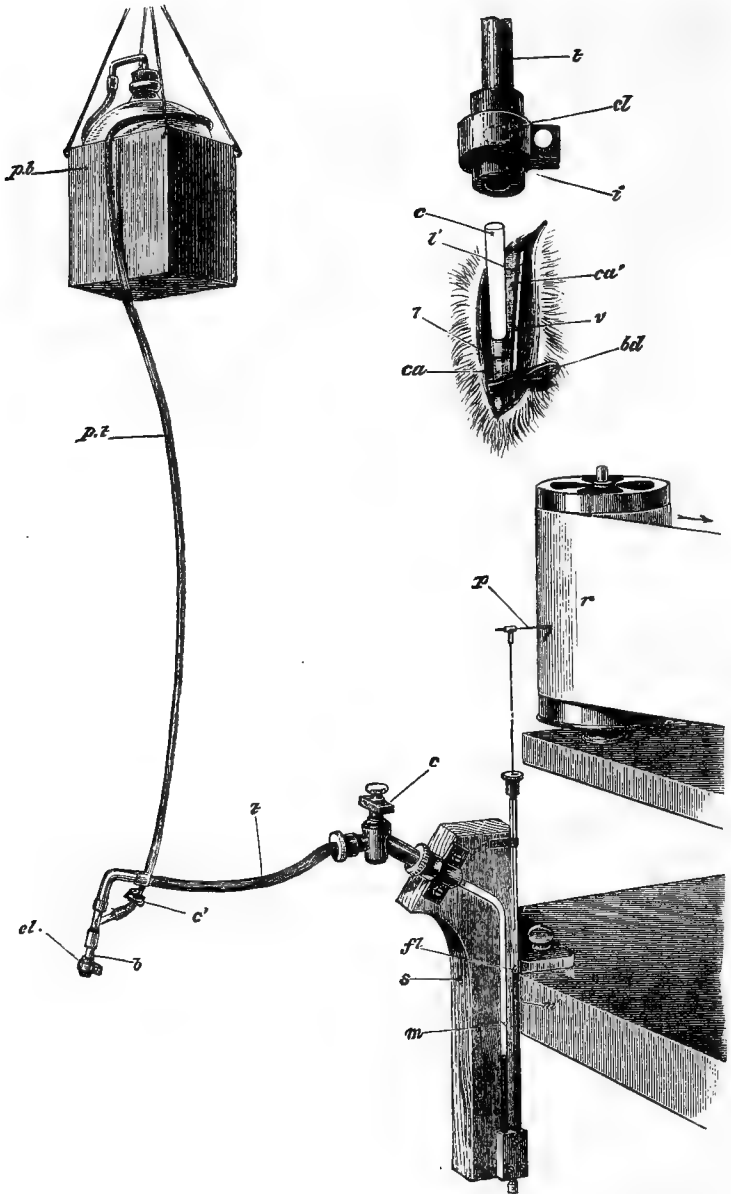

FIG. 207.—Apparatus used in making a blood-pressure experiment (after Foster). *pb*, pressure-bottle, elevated so as to raise the pressure several inches of mercury, as seen in the manometer (*m*) below. It contains a saturated solution of sodium carbonate; *rt*, rubber tube connecting the *pb* with the leaden tube; *lt*, tube made of lead, so as to be pliable, yet have rigid walls; *sc*, a stop-cock, the top of which is removable, to allow escape of bubbles of air; *p*, the pen, writing on the roll of paper, *r*. The former floats on the mercury; *m*, the manometer, the shaded portion of the bent tube denoting the mercury; the rest is filled with a fluid unfavorable to the coagulation of the blood, and derived from the pressure-

bottle; *ca*, the carotid, in which is placed the canula, and below the latter a forceps, which may be removed when the blood-pressure is to be actually measured. The registration of the height, variation, etc., of blood-pressure, is best made on a continuous roll of paper, as seen in Fig. 208.

the experiment. This may be effected in a variety of ways, one of the most convenient of which is by means of a vessel containing some saturated sodium carbonate or similar solution in connection with the manometer.

It is important that the pressure should express itself as directly and truthfully on the mercury of the manometer as possible, hence the employment of a tube with rigid walls, yet capable of being bent readily in different directions for the sake of convenience.

Mercury, on account of its inertia, is not free from objection; and when very delicate variations in the blood-pressure—e. g., feeble pulse-beats—are to be indicated, it fails to express them, in which case other fluids may be employed.

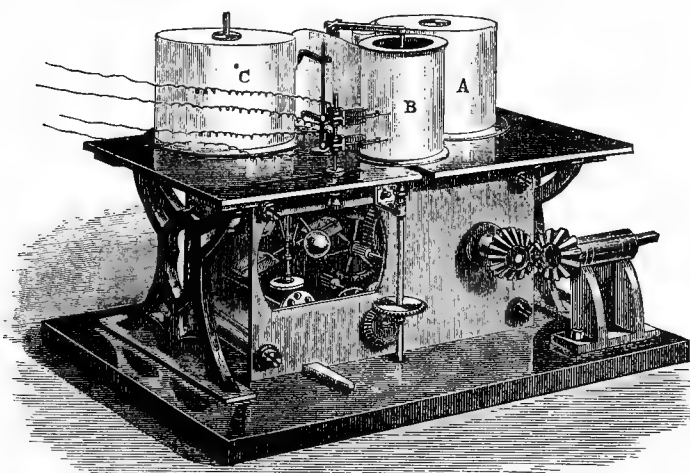

FIG. 208.—Large kymograph, with continuous roll of paper (Foster). The clock-work machinery unrolls the paper from the roll C, carries it smoothly over the cylinder B, and then winds it up into the roll A. Two electro-magnetic markers are seen in position recording intervals of time on the moving roll of paper. A manometer may be fixed in any convenient position.

It will be noted that when an ordinary cannula is used, inserted as it is lengthwise into the blood-vessel, the pressure recorded is not that on the side of the vessel into which it is inserted as when a \rightarrow -piece is used, but of the vessel, of which the one in question is a branch. The blood-pressure, in the main arterial trunk for example, must depend largely on the force of the heart-beat; consequently it would be expected, and it

is actually found, that the pressure varies for different animals, size having, of course, in most instances a relation to the result. It has been estimated that in the carotid of the horse the arterial pressure is 150 to 200 mm. of mercury, of the dog 100 to 175, of the rabbit 50 to 90. Man's blood-pressure is not known, but is probably high, we may suppose not less than 150 to 200 mm.

After the fact that there is a certain considerable blood-pressure, the other most important one to notice is that this blood-pressure is constantly varying during the experiment, and, as we shall give reason to believe, in the normal animal; and to these variations and their causes we shall presently turn our attention.

THE HEART.

The heart, being one of the great centers of life, to speak figuratively, it demands an unusually close study.

THE CARDIAC MOVEMENTS.

There is no special difficulty in ascertaining the outlines of the heart by means of percussion on either the dead or the living subject. Quite otherwise is it with the changes in form which accompany cardiac action. Attempts have been made to ascertain the alterations in position of the heart with respect to other parts, and especially its own alterations in shape during a systole, the chest being unopened, by the use of needles thrust into its substance through the thoracic walls; but the results have proved fallacious. Again, casts have been made of the heart after death, in a condition of moderate extension, prior to *rigor mortis*; and also when contracted by a hardening fluid. These methods, like all others as yet employed, are open to serious objections.

Following the rapidly beating heart of the mammal with the eye produces uncertainty and confusion of mind. We look to instantaneous photography to furnish a possible way out of the difficulty.

It may be very confidently said that the mode of contraction of the hearts of different groups of vertebrates is variable, though it seems highly probable that the divergences for mammals are slight. The most that can be certainly affirmed of the mammalian heart is, that during contraction of the ventricles they become more conical; that the long diameter is not appreciably altered; that the antero-posterior diameter is

lengthened; and that the left ventricle at least turns on its own axis from left to right. This latter may be distinctly made out by the eye in watching the heart in the opened chest.

THE IMPULSE OF THE HEART.

When one places his hand over the region of the heart in man and other mammals, he experiences a sense of pressure varying with the part touched, and from moment to moment. Instruments constructed to convey this movement to recording levers also teach that certain movements of the chest wall correspond with the propagation of the pulse, and therefore to the systole of the heart. It can be recognized, whether the hand or an instrument be used, that all parts of the chest wall over the heart are not equally raised at the one instant. If the beating heart be held in the hand, it will be noticed that during systole there is a sudden hardening. The relation of the apex to the chest wall is variable for different mammals, and with different positions of the body in man.

As a result of the investigation which this subject has received, it may be inferred that the sudden tension of the heart, owing to the ventricle contracting over its fluid contents, causes in those cases in which during diastole the ventricle lies against the chest wall, a sense of pressure beneath the hand, which is usually accompanied by a visible movement upward in some part of the thoracic wall, and downward in adjacent parts. The exact characters of the cardiac impulse are very variable with different human subjects. The term "apex-beat" is frequently employed instead of cardiac impulse, on the assumption that the apex of the heart is brought into sudden contact with the thoracic walls from which it is supposed to recede during diastole. But, in some positions of the body at all events in a certain proportion of cases, the apex of the heart lies against the chest wall during diastole, so that in these instances certainly such a view would not be wholly correct. But we would not deny that in some subjects there may be a genuine knock of the apex against the walls of the chest during the ventricular systole.

It will not be forgotten that the heart lies in a pericardial sac, moistened with a small quantity of albuminous fluid; and that by this sac the organ is tethered to the walls of the chest by its mediastinal fastenings; so that in receding from the chest wall the latter may be drawn after it; though this might

also follow from the intercostal muscles being simply unsupported when the heart recedes.

INVESTIGATION OF THE HEART-BEAT FROM WITHIN.

By the use of apparatus introduced within the heart of the mammal and reporting those changes susceptible of graphic record, certain tracings have been obtained about the details of



FIG. 209.—Marey's cardiac sound which may be used to explore the chambers of the heart (after Foster). *a*, is made of rubber stretched over a wire framework, with metallic supports above and below; *b*, is a long tube.

which there are uncertainty and disagreement, though they seem to establish the nature of the main features of the cardiac beat clearly enough. An interpretation of such tracings in the

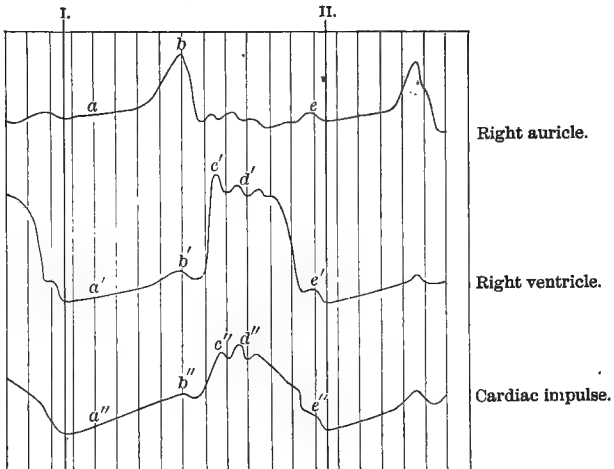

FIG. 210.—Simultaneous tracings from the interior of the right auricle, from the interior of the right ventricle, and of the cardiac impulse, in the horse (after Chauveau and Marey). Tracings to be read from left to right, and the references above are in the order from top to bottom. A complete cardiac cycle is included between the thick vertical lines I and II. The thin vertical lines indicate tenths of a second. The gradual rise of pressure within the ventricle (middle tracing) during diastole, the sudden rise with the systole, its maintenance with oscillations for an appreciable time, its sudden fall, etc., are all well shown. There is disagreement as to the exact meaning of the minor curves in the larger ones.

light of our general and special knowledge warrants the following statement.

1. Both auricular and ventricular systole are sudden, but the latter is of very much greater duration.

2. While the chest wall feels the ventricular systole, the auriculo-ventricular valves shield the auricle from its shock.

3. During diastole in both chambers the pressure rises gradually from the inflow of blood; and the auricular contraction produces a brief, decided, though but slight rise of pressure in the ventricles.

4. The onset of the ventricular systole is rapid, its maximum pressure suddenly reached, and its duration considerable.

The relations of these various events, their duration, and the corresponding movements of the chest wall, may be learned by a study of the above tracing which the student will find worthy of his close attention.

THE CARDIAC SOUNDS.

Two sounds, differing in pitch, duration, and intensity, may be heard over the heart, when the chest is opened and the heart listened to by means of a stethoscope. These sounds may also be heard, and present the same characters when the heart is auscultated through the chest wall; hence the cardiac impulse can take no essential part in their production.

The sounds are thought to be fairly well represented, so far as the human heart is concerned, by the syllables *lub*, *dub*; the first sound being longer, louder, lower-pitched, and "booming" in quality; the second short, sharp, and high-pitched.

In the exposed heart, the first sound is heard most distinctly over the base of the organ or a little below it; while the second is communicated most distinctly over the roots of the great vessels—that is to say, both sounds are heard best over the auriculo-ventricular and semilunar valves respectively. When the chest wall intervenes between the heart and the ear, it is found that the second sound is usually heard most distinctly over the second costal cartilage on the right; and the first in the fifth costal interspace where the heart's impulse is also often most distinct. In these situations the arch of the aorta in the one case, and the ventricular walls in the other, are close to the situations referred to during the cardiac systole; hence it is inferred that, though the sounds do not originate directly beneath these spots, they are best propagated to the chest wall at these points.

There are, however, individual differences, owing to a va-

riety of causes, which it is not always possible to explain fully in each case, but owing doubtless in great part to variations in the anatomical relations.

The Causes of the Sounds of the Heart.—There is general agreement in the view that the *second* sound is owing to the closure of the semilunar valves of the aortic and pulmonary vessels; the former, owing to their greater tension in consequence of the higher blood-pressure in the aorta, taking much the larger share in the production of the sound, as may be ascertained by listening over these vessels in the exposed heart. When these valves are hooked back, the second sound disappears, so that there can be no doubt that they bear some important relation to the causation of the sound.

In regard to the *first* sound of the heart the greatest diversity of opinion has prevailed and still continues to exist. The following among other views have been advocated by physiologists:

1. The first sound is caused by the tension and vibration of the auriculo-ventricular valves.
2. The first sound is owing to the contractions of the large mass of muscle composing the ventricles.
3. The sound is directly traceable to eddies in the blood.

In favor of the first view it was argued that by agreement the second sound was valvular, and why not the first?—And again that malformations of the valves gave rise to “murmurs” (“*bruits*”), which either obscured or replaced the true sound.

The second opinion was supported by the fact that the larger the heart the more powerful the sound; that when the blood was cut off from the heart by ligature of the vessels successively, the sound could still be heard; that with fatty degeneration of the muscle-fibers of the heart, it had been found that the sound was weak—and similar arguments.

Recently it has been contended very strongly that the first sound may be heard by a double stethoscope placed over an excised, bloodless, mammalian heart, or even ventricle, while it still beats.

The third opinion was less vigorously upheld, but certain experiments and physical phenomena were pointed to in support of it.

Against the arguments adduced above it may be stated that the first sound may be conceived as overpowered by a *bruit* without being replaced by it in the proper sense of the word. It is well known that the cardiac muscle is peculiar, occupying

in structure a position intermediate between the striped voluntary fibers and the smooth muscle-cells. Numerous investigations have shown that the heart is not susceptible of true

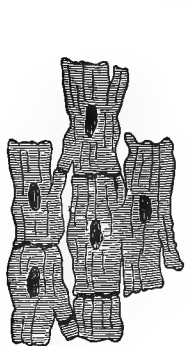

FIG. 211.

FIG. 211.—Microscopic appearances of fibers from the heart. The cross-striae, divisions (branching), and junctures are visible (Landois).



FIG. 212.

FIG. 212.—Muscular fiber-cells from the heart. (1×425 .) *a*, line of juncture between two cells; *b*, *c*, branching cells.

tetanic contraction, certainly not the heart of the mammal; so that it is customary to term the cardiac contraction peristaltic. If this view be correct, how could there be a sound produced by muscular contraction alone? To this it has been replied that the sudden tension of the ventricular wall when tightened over the blood may give rise to vibrations that account for the sound; and recent investigations have shown that the vibrations that give rise to the sound emitted by a contracting skeletal muscle may be fewer than was once supposed. The statement that a sound may be heard from the excised ventricle under the circumstances above mentioned has not been denied; but its source has been traced to the action of the heart wall against the stethoscope—i. e., some believe the sound to be, in this case, of extrinsic origin. Most physicians would be very loath to abandon the view that the valves are always to be taken into serious account as a factor in the causation of the sound.

But, looking at the whole question broadly, is it not unreasonable to explain the sound resulting from such a complex act as the contraction of the heart and what it implies in the light of any single factor? That such narrow and exclusive views should have been propagated, even by eminent physiologists, should admonish the student to receive with great caution ex-

planations of the working of complex organs, based on a single experiment, observation, or argument of any kind.

The view we recommend the student to adopt in the light of our present knowledge is, that the first sound is the result of several causative factors, prominent among which are the sudden tension of the auriculo-ventricular valves, and the contraction of the cardiac muscle, not leaving out of the account the possible and probable influence of the blood itself through eddies or otherwise; nor would we ridicule the idea that in some cases, at all events, the sound may be modified in quality and intensity by the shock given to the chest wall during systole.

ENDO-CARDIAC PRESSURES.

Bearing in mind the relative extent of the pulmonary and systemic portions of the circulation, we should suppose that the resistance to be overcome in opening the aortic valves and lifting the column of blood that keeps them pressed together, would be much greater in the left ventricle than in the right; or, in other words, that the intra-ventricular pressure of the left side of the heart would greatly exceed that of the right, and this is confirmed by actual experiment.

By means of an instrument known as the maximum and minimum manometer, the highest and lowest pressure within any chamber of the heart may be learned approximately. As a specimen measurement it may be stated that it has been found that in a dog the greatest pressure was 140 mm. of mercury for the left ventricle, for the right only 60, and for the right auricle 20. But it is also found—a matter not quite so obvious—that a minimum pressure proportionate to the maximum may exist in all the chambers of the heart; and the pressure may fall below that of the atmosphere, or be *negative*. By the same method it was found that in a dog the negative pressure varied between -52 and -20 mm. of mercury for the left ventricle and -17 to -16 mm. for the right, with -12 to -7 mm. for the right auricle. As will be shown later, part of this diminished pressure is due to the effect of the respiratory movements; and, indeed, more recent experiments seem to show that ordinarily, with the heart beating with its usual rate and force, the negative pressure or suck from its own action is comparatively slight. The discussion of the cause of this negative pressure, like the related subject of the cause of the heart's diastole, has given rise to much difference of opinion.

Some find it difficult to understand how the heart after systole may regain its original form apart from the assistance of diastolic muscles, which are assumed to act so as to antagonize those causing systole.

Others think the elasticity of the heart's muscle sufficient of itself to account for the organ's return to its original form.

But there is surely a misconception involved in both of these views.

If small portions of the heart of the frog, tortoise, or other cold-blooded animal, just removed from the body, be observed under a microscope it will be seen that they alternately contract and relax. Now, it is only necessary to suppose that the relaxation of the heart is complete after each systole, to understand how even an empty heart regains its diastolic form.

That there should be a negative pressure in, say, the left ventricle, follows naturally enough from the fact that not only are the contents of the ventricle expelled with great suddenness, but that its walls remain (see Figs. 210 and 214) pressed together for a considerable portion of the time occupied by the whole systole; so that in relaxation it follows that there must

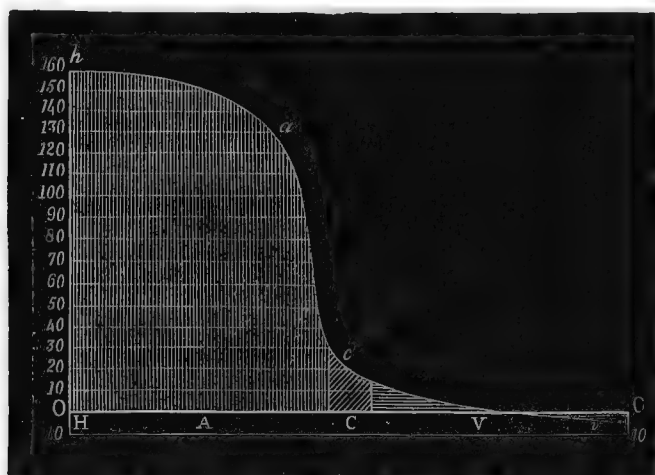

FIG. 213.—Diagram showing the relative height of the blood-pressure in different parts of the vascular system (after Yeo). *h*, heart; *a*, arterioles; *v*, small veins; *A*, arteries; *c*, capillaries; *V*, large veins: *H. V.* representing the zero-line, i. e., atmospheric pressure; the blood-pressure is indicated by the height of the curve. The numbers on the left give the pressure, approximately, in mm. of mercury.

be an empty cavity to fill, or that there must be an aspiratory effect toward the ventricle; hence also one factor in the closure of the semilunar valves.

It thus appears that the heart is not only a force-pump but also to some extent a suction-pump; and, if so, the aspirating effect must express itself on the great veins, lacking valves as they do, at their entrance into the heart; hence, with each diastole the blood would be sucked on into the auricles, a result that is intensified by the respiratory movements of the thorax.

Relative Time occupied by the Various Phases of the Cardiac Cycle.

—The old and valuable diagram reproduced below is meant to convey through the eye the relations of the main events in a complete beat of the heart or cardiac cycle. The relative

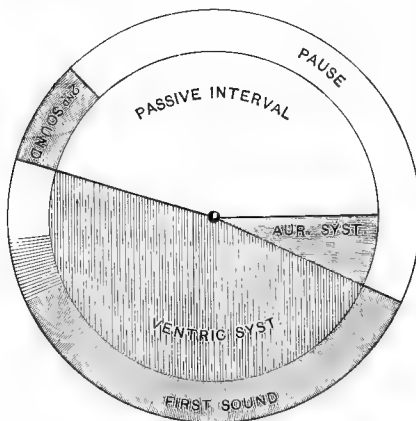

FIG. 214. — Diagram representing the movements and sounds of the heart during a cardiac cycle (after Sharpey).

length of the sounds; the long period occupied by the pause; the duration of the ventricular systole, which it is to be observed is in excess of that of the first sound, are among the chief facts to be noted.

The tracings of Chauveau and Marey, obtained from the heart of the horse, which has a very slow rhythm, show that of the whole period, the auricular systole occupies $\frac{1}{6}$ or $\frac{2}{10}$ of a second; the ventricular systole, $\frac{2}{6}$ or $\frac{4}{10}$ of a second;

and the diastole, $\frac{3}{6}$ or $\frac{6}{10}$ of a second.

With the more rapid beat in man (70 to 80 per minute), the duration of the cardiac cycle may be estimated at about $\frac{6}{10}$ of a second, and the probable proportions for each event are about these: The auricular systole, $\frac{1}{10}$ of a second; the ventricular systole, $\frac{3}{10}$ of a second; and the pause, $\frac{2}{10}$ of a second.

It will be noted that the pause of the heart is equal in duration to the other events put together; and even assuming that there is some expenditure of energy in the return (relaxation) of the heart to its passive form, there still remains a considerable interval for rest, so that this organ, the very type of ceaseless activity, has its periods of complete repose.

THE WORK OF THE HEART.

Since the pressure against which the heart works must, as we shall see, vary from moment to moment, and sometimes very considerably, the work of the heart must also vary within wide limits, even making allowance for large adaptability to the burden to be lifted; for it will be borne in mind that the degree to which the heart empties its chambers is also variable.

If one knew the quantity of blood ejected by the left ventricle, and the rate of the beat, the calculation of the work done would be an easy matter, since the former multiplied by the latter would represent, as in the case of a skeletal muscle, the work of the muscles of the left ventricle; from which the work of the other chambers might be approximately calculated.

The work of the auricles must be slight, considering that the filling of the ventricles is not dependent solely upon their contraction, that they empty themselves very imperfectly, and that the tracing on Marey's curves (Fig. 210), representing the effect of their contraction on the intraventricular pressure is but small. Notwithstanding, as they largely determine by their contraction and the quantity they throw into the ventricles how full the latter shall be in a given instance, they really have a very large share in determining the total work of the ventricles and the whole heart.

The right ventricle, it is estimated does from one fourth to one third the work of the left; not, of course, because it throws out less blood, for if this were the case the left side of the heart must soon become empty, not to mention other disturbances of the vascular equilibrium, but because of the relatively less resistance offered by the pulmonary vessels.

All attempts to estimate exactly the quantity ejected by the left ventricle seem to show that this varies very greatly, after due allowance is made for the imperfection of the methods and the great discrepancies in the results of different observers. Perhaps six ounces, or about 180 grammes, may be taken as an average for the left ventricle of man. Assuming that his aortic blood-pressure is, say 200 mm. of mercury or 3.21 metres of blood, the work of this chamber for each beat would be 180×3.21 , or 578 gramme-metres. If the heart beats seventy times per minute, the work for the day would be $578 \times 70 \times 60 \times 24 = 58,262,400$ gramme-metres. Or, upon the same basis, and assuming that the blood makes up about the one thirteenth of the weight of the individual, in a man of 143 pounds, the whole of the

blood would pass through the heart in about thirty beats, or in less than half a minute.

When we calculate the work done by the heart for certain intervals, as the day, the week, month, year, and especially for a moderate lifetime, and compare this with that of any machine it is within the highest modern skill to construct, the great superiority of the vital pump in endurance and working capacity will be very apparent; not to take into the account at all its wonderful adaptations to the countless vicissitudes of life, without which it would be absolutely useless, even destructive to the organism.

Some of these variations in the working of the heart we may now to advantage consider.

VARIATIONS IN THE CARDIAC PULSATION.

These may be ascertained either by the investigation of the arteries or of the heart, for every considerable alteration in the working of the heart expresses itself also through the arterial system. In speaking of the pulse, the reference is principally to the arteries, but in each case we may equally well think of the heart primarily as acting upon the arteries.

1. The *frequency* of the heart-beat varies, as might be supposed, with a great multitude of conditions, the principal of which are: *age*, being most frequent at birth, when it may be 140 per minute, gradually slowing to old age, when it may fall to 60. In feeble old age the heart-beat may, like many other of the functions of the body, approximate the infantile condition, being very frequent, small, feeble, and easily disturbed in its rhythm.

It is a matter of no small importance to the medical student to be aware of the normal rate for different periods of life, hence we give below a pretty full statement of the variations with age. It will be understood that the numbers are only approximative, and that large allowance must be made for individual deviations:

At birth, 130-140	At 4 years, 96-94	At 20 years, 78-72
1 year, 120-130	5 " 94-90	30 " 75-70
2 years, 100-110	10 " 90-85	50 " 70-65
3 " 100-96	15 " 80-75	

Sex.—The cardiac beat is more frequent in females; *stature*, more frequent in the short; *posture*, most rapid in the standing position, slower when sitting, and slowest in the recumbent

posture; *season*, more frequent in summer; *period of the day*, more frequent in the afternoon and evening; *elevation of temperature*, the *inspiratory act*, *emotions* and *mental activity*, *eating*, *muscular exercise*, etc., render the heart-beats more frequent.

2. *The length of the systole*, though variable, is more constant than that of the diastole. The estimated limits of the systole may be stated as '327 to '301 second.

3. *The force of the pulsation* varies very greatly and exercises an important influence on the blood-pressure, and the velocity of the blood-stream. As a rule, when the heart beats rapidly, especially for any considerable length of time, the force of the individual pulsations is diminished.

4. The heart-beat may vary much and in ways it is quite possible to estimate, both directly by the hand placed over the organ on the chest, by the modifications of the cardiac sounds, and by the use of instruments. It is wonderful how much information may be conveyed, without the employment of any instruments, through palpation and auscultation, to one who has long investigated the heart and the arteries with an intelligent, inquiring mind; and we strongly recommend the student to commence personal observations early and to maintain them persistently.

Physicians recognize the pulse (and heart) as "slow" as distinguished from "infrequent," "slapping," "heaving," "thrilling," "bounding," etc.

Now, if with these terms there arise in the mind corresponding mental pictures of the action of the heart under the circumstances, well; if not, there is a very undesirable blank. How the student may be helped to a knowledge of the actual behavior of the heart under a variety of conditions we shall endeavor to explain later.

Apart from all the above peculiarities, the heart may cease its action at regular intervals, or at intervals which seem to possess no definite relations to each other—that is, the heart may be irregular in its action, which may be made evident either to the hand or the ear.

There are certain deviations from the quicker rhythm which occur with such regularity and are so dependent on events that takes place in other parts of the body that they may be considered normal. Reference will shortly be made to these and the causes of the variations enumerated in this section.

Comparative.—The following table gives the mean number of cardiac pulsations per minute (after Gamgee):

SPECIES.	Adult.	Youth.	Old age.
Horse.....	36- 40	60- 72	32- 38
Ass and mule.....	46- 50	65- 75	55- 60
Ox.....	45- 50	60- 70	40- 45
Sheep and goat.....	70- 80	85- 95	55- 60
Pig.....	70- 80	100-110	55- 60
Dog.....	90-100	110-120	60- 70
Cat.....	120-140	120-140	100-120

The variations with age, for the horse and the ox, are as follows, according to Kreutzer:

<i>Horse.</i>		<i>Ox.</i>	
At birth.....	100-120	At birth.....	92-132
When 14 days old.....	80- 96	When 4-5 days old.....	100-120
When 3 months old.....	68- 76	When 14 days old.....	68
When 6 months old.....	64- 72	When 4-6 weeks old.....	64
When 1 year old.....	48- 56	When 6-12 months old.....	56- 68
When 2 years old.....	40- 48	For the young cow.....	46
When 3 years old.....	38- 48	For the four-year-old ox.....	40
When 4 years old.....	38- 50		
When aged.....	32- 40		

THE PULSE.

Naturally the intermittent action of the heart gives rise to corresponding phenomena in the elastic tubes into which it may be said to be continued, for it is very desirable to keep in mind the complete continuity of the vascular system.

The following phenomena are easy of observation: When a finger-tip is laid on any artery, an interrupted pressure is felt; if the vessel be laid bare (or observed in an old man), it may be seen to be moved in its bed forward and upward; the pressure is less the farther the artery from the heart; if the vessel be opened, blood flows from it continuously, but in spurts; if one finger be laid on the carotid and another on a distant vessel, as one of the arteries of the foot, it may be observed (though it is not easy, from difficulty in attending to two events happening so very close together) that the beat in the nearer vessel precedes by a slight interval that in the more distant.

Investigating the latter phenomenon with instruments, it is found that an appreciable interval, depending on the distance apart of the points observed, intervenes.

What is the explanation of these facts?

The student may get at this by a few additional observations that can be easily made.

If water be sent through a long elastic tube (so coiled that points near and remote may be felt at the same time) by a bulb syringe, imitating the heart, and against a resistance made by drawing out a glass tube to a fine point and inserting it into the terminal end of the rubber tube, an intermittent pressure like that occurring in the artery may be observed; and further

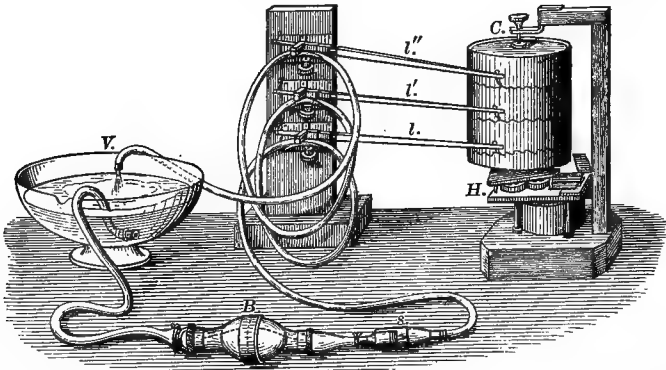

FIG. 215.—Marey's apparatus for showing the mode in which the pulse is propagated in the arteries. *B*, a rubber pump, with valves to prevent regurgitation. The working of the apparatus will be apparent from the inspection of the figure.

that it does not occur at precisely the same moment at the two points tested.

Information more exact, though possibly open to error, may be obtained by the use of more elaborate apparatus, and the graphic method.

Fig. 216 gives an idea of the main features of the pulse-tracings of an arterial scheme or arrangement of tubes in supposed imitation of the conditions existing in the vascular system of the mammalian body. Attention is especially directed to the abrupt ascent, the more gradual descent, and the secondary waves, which are either waves of oscillation or reflex waves.

It may also be noticed that the rise is later as the part of the tube at which it occurs is more distant from the pump; also that it gets gradually less in height and at the same time that all the secondary waves are diminished or totally disappear; and with the exception of the latter these results hold good of the pulse in the arteries of a living animal.

By measurement it has been ascertained that in man the pulse-wave travels at the rate of from five to ten metres per second, being of course very variable in velocity. It would seem that the more rigid the arteries the more rapid the rate, for in

children with their more elastic arteries the speed is slower; and the same principle is supposed to explain the higher veloci-

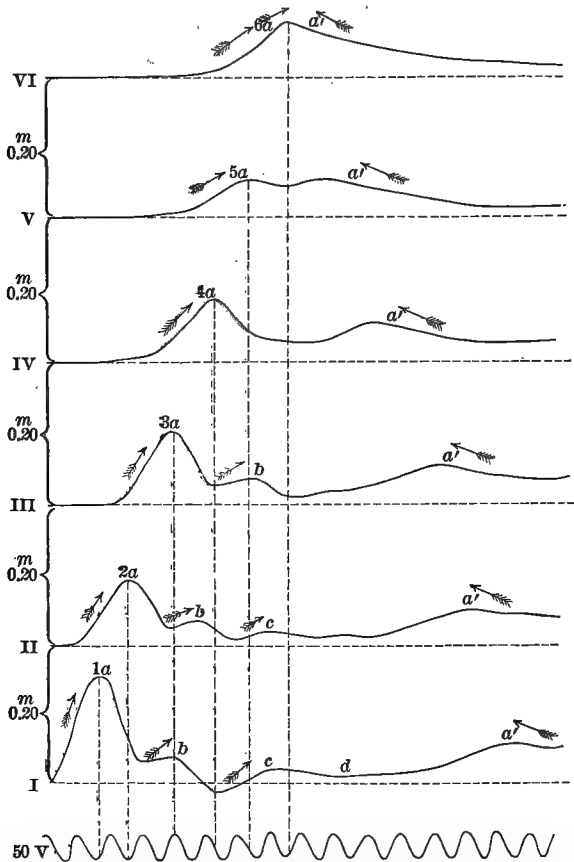

FIG. 216.—Pulse-curves described by a series of sphygmographic levers placed 20 cm. apart along an elastic tube into which fluid is forced by the sudden stroke of a pump. The arrows indicate the onward and the reflected waves. The gradual flattening and total or partial extinction of the waves are noteworthy (after Marey).

ty noticed in the arteries of the lower extremities. But with such a speed as even five metres a second it is evident that with a systole of moderate duration (say .3 second) the most distant arteriole will have been reached by the pulse-wave before that systole is completed.

It is known that the blood-current at its swiftest has no such speed as this, never perhaps exceeding in man half a metre per second, so that the pulse and the blood-current must be two totally distinct things.

The student may very simply illustrate this matter for himself. By tapping sharply against a pipe through which a stream is flowing slowly and quietly, a wave may be seen to arise and pass with considerable velocity along the moving water, and with a speed far in excess of the rapidity of the main current. When the left ventricle throws its six ounces of blood into vessels already full to distention, there must be considerable concussion in consequence of the rapid and forcible nature of the cardiac systole, and this gives rise to a wave in the blood which, as it passes along its surface, causes each part of every artery in succession to respond by an elevation above the general level, and it is this which the finger feels when laid upon an artery.

That there is considerable distention of the arterial system with each pulse may be realized in various ways, as by watching and feeling an artery laid bare in its course, or in very thin or very old people, and by noticing the jerking of one leg crossed over the other, by which method in fact the pulse-rate may be ascertained. And that not only the whole body but the entire room in which a person sits is thrown into vibration by the heart's beat, may be learned by the use of a telescope to observe objects in the room, which may thus be seen to be in motion.

Features of an Arterial Pulse-Tracing.—In order to judge of the nature of arterial tracings, it is important that the circumstances under which they are obtained should be known.

The movements of the vessel wall in most mammals suit-

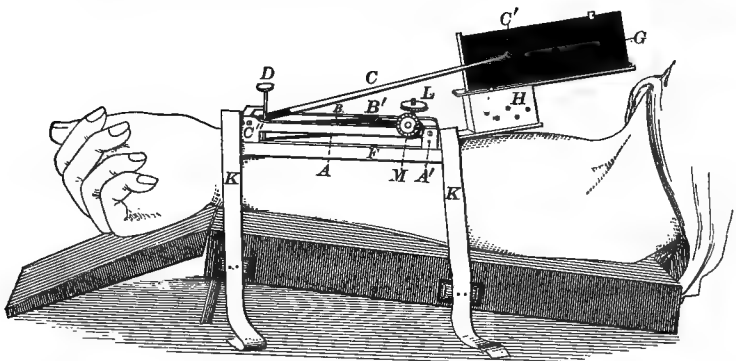

FIG. 217.—Marey's improved sphygmograph arranged for taking a tracing. *A*, steel spring; *B*, first lever; *C*, writing-lever; *C'*, its free writing end; *D*, screw for bringing *B* in contact with *G*; *G*, slide with smoked paper; *H*, clock-work; *L*, screw for increasing the pressure; *M*, dial indicating the amount of pressure; *K, K*, straps for fixing the instrument to the arm, and the latter to the double-inclined plane or support (Byrom Bramwell).

able for experiment and in man is so slight that it becomes necessary to exaggerate them in the tracing, hence long levers are used to accomplish this.

The sphygmograph is the usual form of instrument employed for the purpose. It consists, essentially, of a clock-work for moving a smoked surface (mica plate commonly) on which the movements of a lever-tip, answering to those of a button placed on the artery, are recorded.

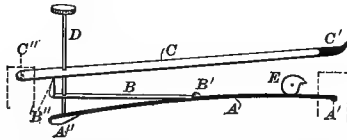

FIG. 218.—Diagrammatic schema showing the essential part of the instrument when in working order. The knife-edge, B' , of the short lever is in contact with the writing-lever, C . Every movement of the steel spring at A' , communicated by the arteries, will be imparted to the writing-lever (Byrom Bramwell).

Considering the nature of the pulse and the apparatus employed to write its characters, it will be seen that the possible sources of error are numerous.

Different observers have, as a matter of fact, even with the same sort of instrument obtained tracings differing not a little in character. As the subjoined figures show, the pressure exerted upon a vessel may so alter the result that entire features of the tracing may actually disappear. The sphygmograph, even in the most skillful hands, has proved somewhat disappointing as a physiological and especially as a clinical instrument, though it is not without a certain value.

We shall do well to inquire whether there are any features in common in tracings obtained in various ways, and which have therefore in all probability a real foundation in nature.

An inspection of a large number of pulse-tracings, taken under diverse conditions, seems to show that in all of them there occurs, more or less marked, the following: 1. An upward curve. 2. A downward curve, rendered irregular by the occurrence of peaks or crests and notches. The first of these are termed the predicrotic notch and crest, and the succeeding ones the dicrotic notch and crest. The latter seem to be the more constant.

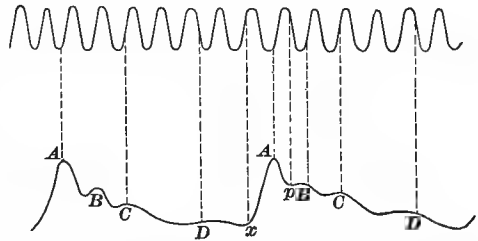

FIG. 219.—Pulse-tracing from carotid artery of healthy man (after Moens). x , commencement of expansion of artery; A , summit of first rise; C , dicrotic secondary wave; B , predicrotic secondary wave; p , notch preceding this; D , succeeding secondary wave. Curve above is that made by a tuning-fork with ten double vibrations in a second.

That these are genuine, answer of real and corresponding elevations of the arterial wall and of the blood-current itself, seems probable from the study of a *hæmautogram*. The latter may be obtained by allowing the blood from a cut artery to spurt against a piece of paper drawn in front of the blood-stream. It is also asserted that by a telephonic connection with an artery both the primary pulse-wave and the dicrotic wave may be heard. More rarely there are interruptions in the first upward curve, termed *anacrotic* curves, as distinguished from those in the downward curve known as *katacrotic*.

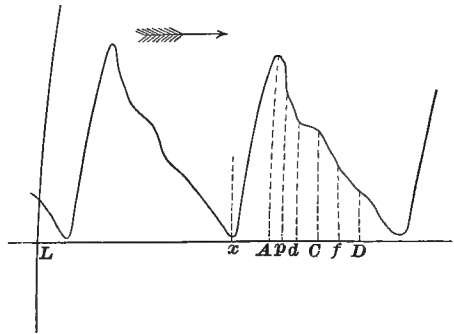

Fig. 220.—Pulse-curve from radial of man. Taken with an extra-vascular pressure of 70 mm. of mercury. The curved interrupted lines show the distance from one another in time of the chief phases of the pulse-wave. *x*, the commencement, and *A*, the close of expansion of artery; *p*, predicrotic notch; *d*, dicrotic notch; *C*, dicrotic crest; *D*, post-dicrotic crest; *f*, the post-dicrotic notch.

It has been generally admitted that the first marked upward curve is due to the systolic shock.



FIG. 221.—Anacrotic pulse-tracing from carotid of rabbit.

The following are, in brief, some of the views that have been entertained

in regard to the minor features of the tracings:

- (a.) That the predicrotic wave-crest is owing to the sudden arrest of the flow from the ventricle.
- (b.) That the dicrotic wave is a wave of oscillation.

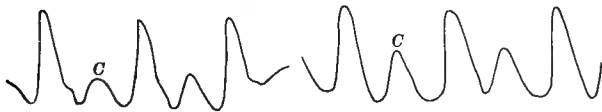

FIG. 222.—Two grades of marked dicrotism in radial pulse of man (typhoid fever).

- (c.) That it is a wave of reflection from the periphery.
- (d.) That it is caused by the sudden closure of the aortic valves.

It appears to be now pretty well agreed that the theory of reflection is untenable on physical principles; that a high blood-pressure tends to render the katacrotic markings less

distinct, and the reverse when the pressure is low, as after hæmorrhages. These features are especially marked in the

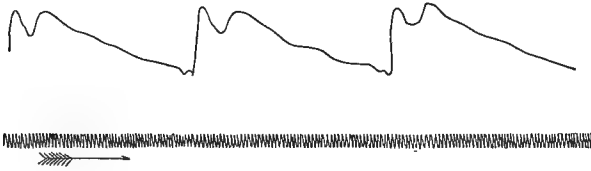

FIG. 223.—Normal pulse-curve in the aorta from the dog.

dicrotic pulse of fever, etc., when the blood-pressure is low and may be recognized even by the hand. The anacrotic crests and notches are abnormal, and probably due to excessive rigidity of the arteries.

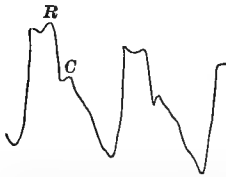

FIG. 224.—Anacrotic sphygmograph tracing from the ascending aorta in a case of aneurism.

Certain it is that, without any change in the heart-beat, changes in the tracings may arise, owing to modifications in the periphery of the vascular system. We do not propose to discuss the above-mentioned views of the causation of the minor features of the tracings in detail, about which the greatest differences of opinion if all the characteristics of an arterial

still prevail. Even tracing could be obtained from an artificial schema, it would not follow that the conditions in each case were the same; in fact, as we view the matter, it would be all but impossible that such should be the case.

Rubber tubes are not comparable to arteries; and especially not to arterioles and capillaries. Bearing in mind the

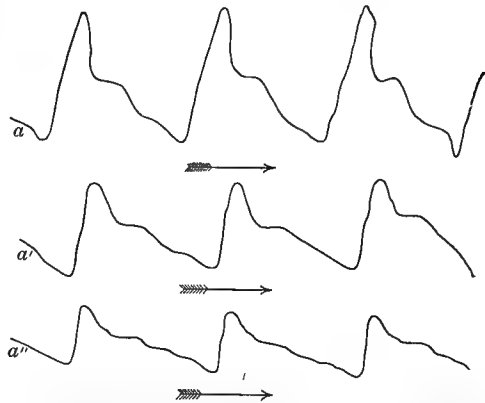

FIG. 225.—Influence of changes in the pressure applied to the exterior of the vessel (extra-vascular) on the form of the curve. *a*, from the radial of a man of twenty-seven years, with an extra-arterial pressure of, in *a*, 70 mm., in *a'*, to 50 mm., and in *a''*, to 80 mm. mercury.

peculiar nature of the blood-corpuscles; their relation to the walls of the vessels in which they flow; the relation of the

blood to the nutrition of the tissues; the fact that all the tubes that compose the vascular system are made up of living cells; that some of these cells (in arterioles and capillaries) are in a semi-fluid condition—in a word, that the conditions of the circulation as a whole are *sui generis*, because of their vitality—it seems to us amaz-

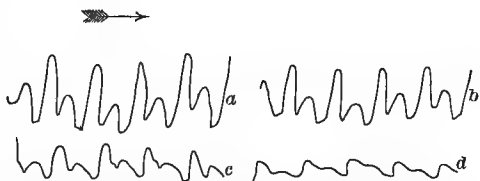

FIG. 226.—Dicrotic pulse-curve due to hæmorrhage. From carotid of rabbit, with extra-vascular pressure of, in a, 50 mm., b, of 40 mm., c, of 20 mm., and d, of 10 mm. mercury. (This and the preceding six tracings from Foster.)

ing that purely physical explanations, such as would answer for a pump and set of rubber tubes, should ever have been deemed satisfactory. The whole subject seems to be involved in a gross misconception, and should be regarded, we must think, from an entirely new standpoint.

Venous Pulse.—Apart from the variations in the caliber of the great veins near the heart, constituting a sort of pulse, though due to variations in intra-cardiac pressure, a venous pulse proper is rare as a normal feature. One of the best-known examples of such occurs in the salivary gland. When, during secretion, the arterioles are greatly dilated, a pulse may be witnessed in the veins into which the capillaries open out, owing to diminution in the resistance which usually is sufficiently great to obliterate the pulse-wave.

Pathological.—In severe cases of heart-disease, owing to cardiac dilatation or other conditions, giving rise to incompetency of the tricuspid valves, there may be with each ventricular systole a back-flow, visible in the veins of the neck.

A venous pulse is a phenomenon, it will be evident, that always demands special investigation. It means that the usual bounds of nature are for some good reason being over-stepped.

Comparative.—Before entering on the consideration of phenomena that all are agreed are purely vital, we call attention to the circulation in forms lower than the mammal, in order to give breadth to the student's views and prepare him for the special investigations, which must be referred to in subsequent chapters; and which, owing to the previous narrow limits (researches upon the frog and a few well-known mammals) having at last been overleaped, have opened up entirely new aspects of cardiac physiology—one might almost say revolutionized the subject.

Owing to the limitations of our space, the references to lower forms must be brief.

We recommend the student, however, to push the subject further, and especially to carry out some of the experiments to which attention will be directed very shortly.

In the lowest organisms (*Infusorians*) represented by *Amœba*, *Vorticella*, etc., there are, of course, no circulatory organs, unless the pulsating vacuoles of some forms mark the crude beginnings of a heart. It will be borne in mind, however, that there is a constant streaming of the protoplasm itself within the organism.

Among *Cœlenterates* (Figs. 254, 255) the digestive system, as yet but imperfectly developed, seems to embody in itself a sort of combination of the functions of the preparation and distribution of elaborated food; and it is worth while to note that even in the highest animals the digestive tract remains in close connection with the circulatory system.

The heart is first represented, as in worms, by a pulsatile tube, which may, as in the earth-worm, extend throughout the greater part of the length of the animal, and has usually dorsal and ventral and transverse connections.

The dilatations of the transverse portions in one division (*metamere*) of the animal seem to foreshadow the appearance of auricles.

The pulsation of the dorsal vessel in a large earth-worm is easy of observation.

In the mollusks the heart consists of a ventricle and one or more auricles, and these chambers give off and receive large vessels (Fig. 227).

These hearts may be observed pulsating with the naked eye or a lens in the clam, oyster, or snail, and are to be looked for in the first two on the side of the animal toward the hinge of the shell.

It is worthy of note that in cephalopod mollusks (*Cuttlefish*, *Poulpe*) there are branchial hearts, which may be regarded in the light of pulsatile venous expansions, a remnant, perhaps, of conditions found in lower forms, in which we have seen that the rhythmically contracting tube plays a prominent rôle.

In *amphioxus*, which is often instanced as the lowest vertebrate, the blood-vessels, including the portal vein, are pulsatile, while there is no distinct and separate heart; but, in connection with the above observations in cephalopods, it is to be re-

marked that in this creature there are contractile dilatations at the bases of the branchial arteries.

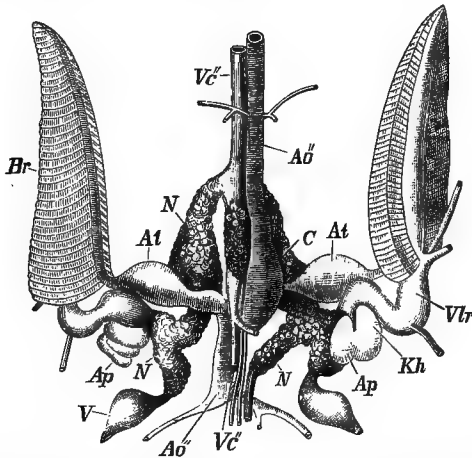

FIG. 227.—Circulatory and excretory organs of the cuttle-fish (*Sepia officinalis*), viewed from the dorsal side (after Hunter). *Br*, gills; *C*, ventricle; *Ao* and *Ao'*, anterior and posterior aorta; *V*, lateral vein; *Vc'*, anterior vena cava; *Vc''*, posterior vena cava; *N*, renal appendages of the veins; *Vlr*, advent branchial vessels (branchial arteries); *Kh*, branchial heart; *Ap*, appendage of the same; *At*, *At'*, auricles receiving the revehent branchial vessels (branchial veins).

In some *Ascidians* the heart is of a somewhat crescentic form, and has the remarkable property of beating for a time in one direction, then stopping and reversing its rhythm. In a transparent specimen, under the microscope, this can be seen admirably.

In the *crab* the heart lies within a pericardium, loosely attached, the main vessels being connected with the pericardium and not directly with the heart. The heart sucks its blood from the pericardial cavity through four valvular openings.

In such a creature as the *scorpion* there is a chambered heart, with a division for each principal segment of the animal's body (Fig. 308).

While in mollusks, crustaceans, and other groups, the vascular system does not form a connected whole, the scorpion is exceptionally advanced in this respect, being provided with capillaries, or tubes closely representing them. Among most of the invertebrates the blood, after leaving the arteries, passes into rather wide, irregular spaces among the various tissues, from which it is taken up by the veins without the intervention of an intermediate set of vessels.

The circulatory system of an insect or crustacean may be

viewed microscopically in aquatic forms, which are often quite transparent, especially in the larval condition.

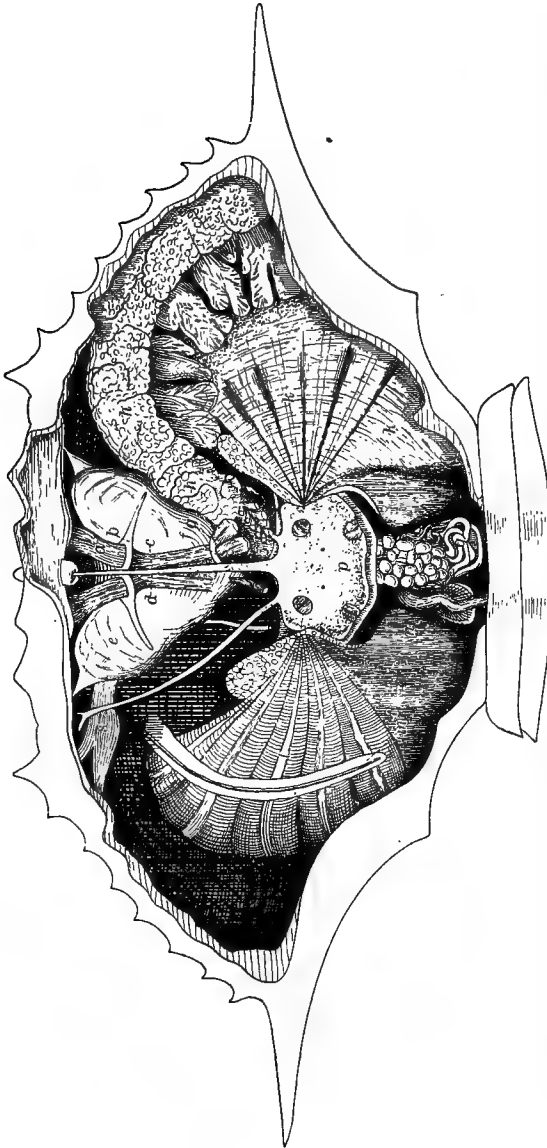

FIG. 238.—Female specimen of the crab (*Callinectes hastatus*) with carapace removed, showing the viscera in place on the right side and partially dissected out on the left (Brooks). *a*, anterior gastric muscles; *b*, pyrocardiac ossicle; *c*, middle gastric muscles; *d*, pyloric ossicle; *e*, posterior gastric muscles; *f*, liver; *g*, stomach; *h*, ovary; *i*, liver; *k*, branchial chamber; *j*, gills; *m*, flabellum; *n*, flanges; *l*, external mandibular muscles; *p*, heart, surrounded by the pericardium, and showing the four openings, through which the blood enters from the pericardium.

Although the respiratory system will be treated from the comparative point of view, the student will do well to note now

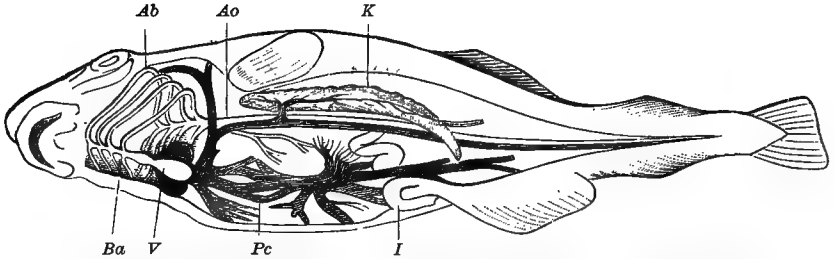

FIG. 229.—Diagram of the circulation of a Teleostean fish (Claus). *V*, ventricle; *Ba*, bulbus arteriosus, with the arterial arches which carry the blood to the gills; *Ab*, arterial arches; *Ao*, aorta descendens, into which the epibranchial arteries passing out from the gills unite; *K*, kidneys; *I*, intestine; *Pc*, portal circulation.

(in the figures) the close relation between the organs for distributing and aërating the blood.

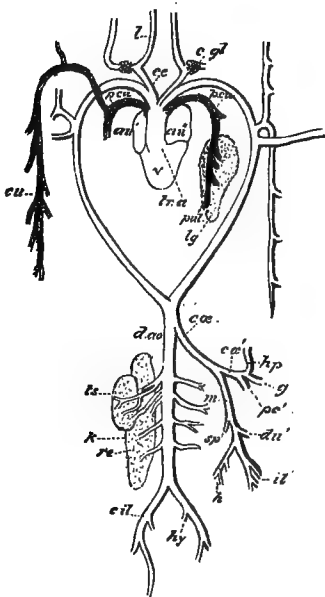

FIG. 230.

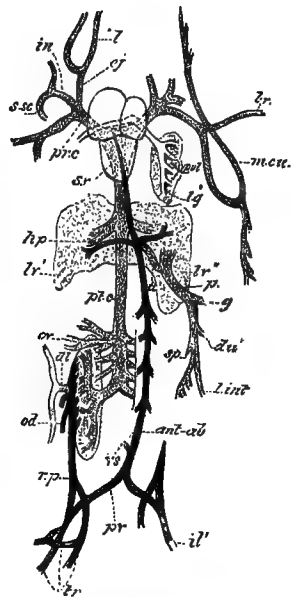

FIG. 231.

FIG. 230.—The arterial trunks and their main branches in the frog (*Rana esculenta*). $1 \times 1\frac{1}{2}$. (Howes.) *l*, lingual vessel; *c. c.*, common-carotid artery; *p. cu.*, pulmo-cutaneous artery; *c. gl.*, carotid gland; *au'*, right auricle; *au''*, left auricle; *v*, ventricle; *tr. a.*, truncus arteriosus; *pul.*, pulmonary; *lg''*, left lung; *ao''*, left aortic arch; *br.*, brachial; *cu.*, cutaneous; *d. ao.*, dorsal aorta; *cœ.*, coeliaco-mesenteric; *cœ.*, coeliac; *hp.*, hepatic vessels; *g.*, gastric; *pc.*, pancreas; *m.*, mesenteric; *sp.*, splenic; *du.*, duodenal; *h.*, hæmorrhoidal; *il'*, ileal; *hy.*, hypogastric; *c. il.*, common-iliac; *re.*, renal; *k.*, kidney; *ts.*, spermatic.

FIG. 231.—Venous trunks and their main branches in the frog (*Rana esculenta*). $1 \times 1\frac{1}{2}$. (Howes.) *l*, lingual vein; *e. j.*, external jugular; *in.*, innominate; *i. j.*, internal jugular; *s. sc.*, subscapular; *pr. c.*, vena cava superior; *s. v.*, sinus venosus; *hp.*, hepatic; *lv'*, right lobe of liver; *lv''*, left lobe of liver; *pt. c.*, vena cava inferior; *ov.*, ovarian; *d. l.*, dorso-lumbar; *od.*, oviducal; *r. p.*, renal-portal; *fm.*, femoral; *sc.*, sciatic; *a.*, femoro-sciatic anastomosis; *pv'*, right pelvic; *vs.*, vesical; *ant. ab.*, anterior abdominal; *a'*, abdominal-portal anastomosis; *il'*, ileal; *sp.*, splenic; *du.*, duodenal; *l. int.*, lieno-intestinal; *g.*, gastric; *p.*, portal; *lg''*, left lung; *pul.*, pulmonary; *m. cu.*, musculo-cutaneous; *br.*, brachial.

Passing on to the vertebrates, in the lowest group, the fishes, the heart consists of two chambers, an auricle and a ventricle, the latter being supplemented by an extension (*bulbus arteriosus*) pulsatile in certain species; and an examination of the course of the circulation will show that the heart is throughout venous, the blood being oxidized in the gills after leaving the former.

Among the amphibians, represented by the frog, there are two auricles separated by an almost complete septum, and one

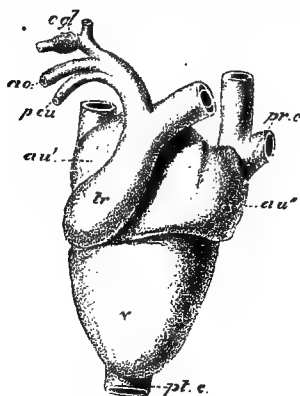

FIG. 232.

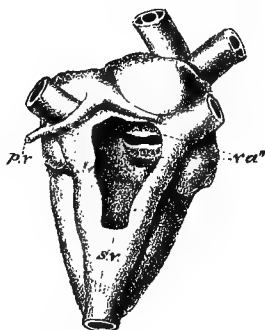

FIG. 233.

FIG. 232.—The frog's heart, seen from the front, the aortic arches of the left side having been removed. (1×4 .) *ca*, carotid; *c. gl.*, carotid gland; *ao*, aorta; *au'*, right auricle; *au''*, left auricle; *pr. c.*, vena cava superior; *pt. c.*, vena cava inferior; *p. cu.*, pulmo-cutaneous trunk; *tr*, truncus arteriosus; *v.*, ventricle (Howes).

FIG. 233.—The same, seen from behind, the sinus venosus having been opened up to show the sinu-auricular valves. (1×4 .) *p. v.*, pulmonary vein; *s. v.*, sinus venosus; *va'*, sinu-auricular valve. Other lettering as in Fig. 232 (Howes).

ventricle characterized by a spongy arrangement of the muscle-fibers of its walls.

In the reptiles the division between the auricles is complete, and there is one ventricle which shows imperfect subdivisions.

In the crocodile, however, the heart consists of four perfectly divided chambers. Of the two aortic arches, one arises together with the pulmonary artery from the right ventricle, and, as it crosses over, the left communicates with it by a small opening, so that, although the arterial and the venous blood are completely separated in the heart, they intermingle outside of this organ.

In birds the circulatory system is substantially the same as in mammals; but in all vertebrate forms below birds the blood distributed to the tissues is imperfectly oxidized or is partially venous.

As an example of the influence of valves and of blood-pressure on the distribution of the blood we may take the case of the turtle, in which the subject has been most carefully studied.

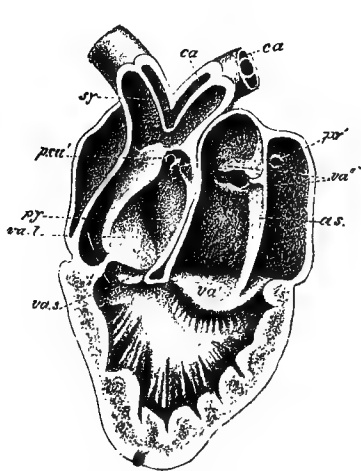

FIG. 234.

FIG. 234.—The heart, dissected from the front, the ventral wall and one of the auriculo-ventricular valves having been removed. (1×6 .) The rod, passing from the ventricle into the pylangium, shows the course taken by the blood flowing into the carotid and aortic trunks. *sy*, syngangium; *p. v.*, aperture of entry of pulmonary vein; *va''*, sinu-auricular valve; *a. s.*, inter-auricular septum; *va'*, auriculo-ventricular valve; *va. s.*, semi-lunar valves; *py*, pylangium; *va. l.*, longitudinal valve (septum) of pylangium; *p. cu'*, point of origin of pulmo-cutaneous trunk (Howes.)

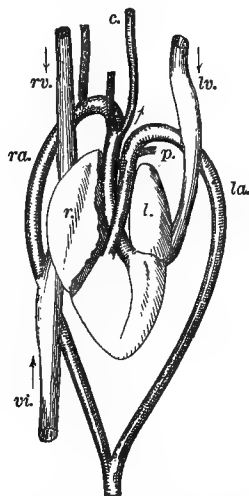

FIG. 235.

FIG. 235.—Heart and arteries of a reptile (boa). *r*, right, and *l*, left auricle; *c*, carotid artery; *ra*, right aortic arch; *la*, left aortic arch; *p*, pulmonary artery; *rv*, right vena cava; *lv*, left vena cava superior; *vi*, vena cava inferior. The arrows indicate the course of the circulation (after Gegenbaur).

The structure of the heart and the relations of its main vessels, etc., will probably be sufficiently clear upon an examination of the accompanying figures and the descriptions beneath them.

The right and left auricles pour their blood, kept somewhat apart by valves, into the *cavum venosum*.

Two arterial arches arise from the right-hand part of this region, while the pulmonary artery is a branch carrying off blood to the lungs from the *cavum pulmone*. No vessels arise from the *cavum arteriosum*.

Since the blood flows in the direction of least resistance when the ventricle contracts, the venous blood of the *cavum venosum* passes on into the pulmonary artery in which the pressure is, of course, lower than in the aortic arches, but, as the systole continues, the arterial blood of the *cavum arterio-*

sum crowds on the venous blood and passes itself with some of the darker blood into the aortic vessels, in which the arrange-

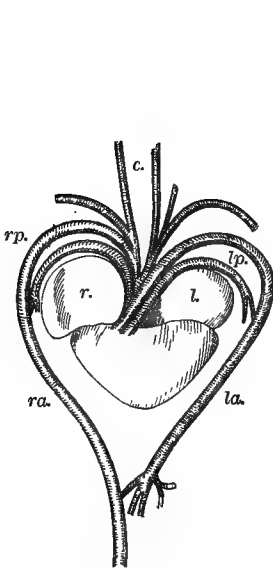

FIG. 236.

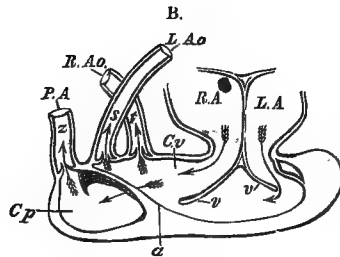
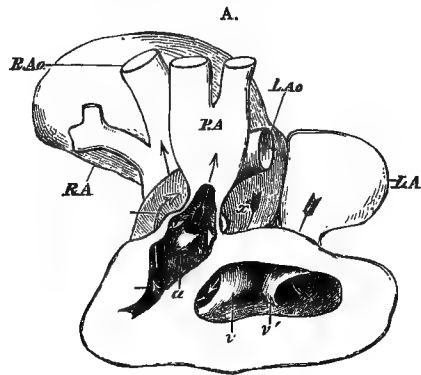

FIG. 237.

FIG. 236.—Heart and arteries of a turtle (*Chelydra*). *rp.* right pulmonary, and *lp.* left pulmonary artery; other letters the same signification as in the previous figure (after Gegenbaur).

FIG. 237.—Heart of a turtle (*Chelone midas*). A. Drawing from nature, the ventral face of the ventricle being laid open. B. Diagram explanatory of the circulation. Everywhere the arrows indicate the course the blood takes. *R. A.*, *L. A.*, right and left auricles. *v.* the right, *v'* the left median auriculo-ventricular valves. *C. v.* *cavum venosum*. *C. p.* *cavum pulmonale*. *a.* the incomplete septum which divides the *cavum pulmonale* from the rest of the cavity of the ventricle. *P. A.* pulmonary artery. *R. Ao.* *L. Ao.* right and left aortæ (after Huxley).

ment of the valves assists materially. Note that, as the systole advances, the imperfect septum between the *cavum pulmonum* and *cavum venosum* approaches the back of the heart wall, and thus tends to shut off the *cavum pulmone* from the purer blood.

As a result of the entire arrangement, the least oxidized blood passes to the lungs, and the most aerated to the head and anterior parts of the animal.

In the frog and other creatures, with three imperfectly separated heart cavities, a similar result is attained.

The resemblances in such cases to the foetal conditions in mammals, including man, will be apparent, and it is especially

to be observed that in the case of the foetus and these lower groups of vertebrates the brain and anterior parts—that is, the most important portions of the animal functionally, the parts on which the rest depend for their well-being (since the brain is the seat of all the main directive centers)—are fed with the best blood the organism possesses, a fact which probably explains in part the relatively large size of these portions of the body early in foetal life and throughout its duration.

We now urge upon the student the importance of making some observations for himself upon the heart of the frog, turtle, snake, fish, or other of the cold-blooded animals. Attention should be given chiefly to the functions of the heart, though to do this intelligently it must be preceded by some study of the anatomy of the organ. It will be understood that any directions we may give for the manipulative part of the work will be of the simplest kind, and rather suggestive of the general method of procedure than intended to illustrate the best methods.

In reality, it is better for exact investigation of the heart that no anæsthetic be given, and an animal may be rendered insensible by a sudden blow upon the head, which, as we shall show later, may be painless. However, it will be, upon the whole, perhaps, best that the animal be given a few whiffs of ether beneath some (glass) vessel, and as soon as it becomes insensible, to withdraw the anæsthetic, remove or crush the head (brain), so that throughout the investigation there may be neither interference with the heart from this organ nor any doubt about the animal's insensibility.

It is well to open the abdomen a little below the heart, so that the latter may be exposed, with its pericardium intact, when the relations of the heart to the surrounding parts may be noticed.

What strikes every observer is the sluggish action of the hearts of these animals—a great advantage in attempting to estimate roughly the relative time occupied by the systole and diastole of the different chambers; the peculiar vermiform nature of the contraction; the changes of color dependent on the degree to which any chamber is filled with blood; and many of those minor details important in making up a total general impression, but not readily expressed in words.

After the animal has been bled, the heart's action may still be profitably studied; and, finally, it may be learned that the

heart will pulsate when removed, either entire or after being divided into sections.

In another specimen it would be desirable to allow the heart, to be kept bathed in serum or physiological saline solution, to beat as long as it will, and to note the various phases of irregularity, weakening, and cessation of action in its different parts.

It is also highly instructive to observe the effect of ligating off certain of the chambers from the rest of the organ.

Any one who makes a few such observations will be prepared to comprehend readily any of the experiments on the hearts of the cold-blooded animals, and will be able, especially if he has followed out earlier recommendations as to the study of the heart of the mammal, to form a mental picture of what is transpiring within his own breast, which is one of the most desirable accomplishments—in fact, the best test of real knowledge.

Whatever ground for differences of opinion there may be as to the extent to which the phenomena we have as yet been describing are mechanical in their nature, all are agreed that such explanations are insufficient when applied to the facts with which we have yet to deal. They, at all events, can be regarded only as the result of vitality.

When one reflects upon the vicissitudes through which an animal must pass daily and hourly, necessitating either that they be met by modified action of the organs of the body or that the destruction of the organism ensue, it becomes clear that the varying nutritive needs of each part must be met by changes in the circulatory system. These changes may affect any part of the entire arrangement, and it rarely happens, as will appear, that one part is modified without a corresponding one, very frequently of a different kind, taking place in some other. What these various correlated modifications are, and how they are brought about, we shall now attempt to describe, and it will greatly assist in the comprehension of the whole if the student will endeavor to keep a clear mental picture of the parts before his mind throughout, using the figures and verbal descriptions only to assist in the construction of such a mental image. We shall begin with the vital pump—the heart.

THE BEAT OF THE HEART AND ITS MODIFICATIONS.

As has been already noted, the cardiac muscle has features peculiar to itself, and occupies histologically an intermediate place between the plain and the striped muscle-cells, and that the contraction of the heart is also intermediate in character, and is best seen in those forms of the organ which are somewhat tubular and beat slowly. But the contraction, though peristaltic, is more rapid than is usually the case in other organs with the smooth form of muscle-fiber.

The heart behaves under a stimulus in a peculiar manner. The effect of a single induction shock depends on the phase of contraction in which the heart is at the moment of its application. Thus at the commencement of a systole there is no visible effect, while beats of unusual character result at other times. But tetanus can not be induced by any form or method of stimulation. The latent period of cardiac muscle is long.

In a heart at rest a single stimulus (as the prick of a needle) usually calls forth but one contraction.

THE NERVOUS SYSTEM IN RELATION TO THE HEART.

The attempts to determine just why the heart beats at all, and especially the share taken by the nervous system, if any direct one, are beset with great difficulty; though, as we shall attempt to show later, this subject also has been cramped within too narrow limits, and hence regarded in a false light.

Till comparatively recently the frog's heart alone received much attention, if we except those of certain well-known mammals. In the heart of the frog there are ganglion-cells in various parts, especially numerous in the sinus venosus (or expansion of the great veins where they meet the auricles); also in the auricles, more especially in the septum (ganglia of Remak), while they are absent from the greater part of the ventricle, though found in the auriculo-ventricular groove (ganglia of Bidder).

Recently it has been found that ganglion-cells occur in the ventricles of warm-blood animals. In the hearts of the dog, calf, sheep, and pig, which are those lately subjected to investigation, it is found that the nerve-cells do not occur near the apex of the ventricles, but mainly in the middle and basal portions, being most abundant in the anterior and posterior inter-ventricular furrows and in the left ventricle. But there are

differences for each group of animals; thus, these ganglion-cells are most abundant, so far as the mammals as yet investigated are concerned, in the ventricles of the pig, and least so in those of the dog. In the cat they are also scanty. Ganglion-cells occur in the auricles, and are especially abundant near the terminations of the great veins.

It has long been known that the heart of a frog removed from the body will pulsate for hours, especially if fed with serum, blood, or similar fluids; and that it may be divided in almost any conceivable way, even when teased up into minute particles, and still continue to beat. The apex, however, when separated does not beat. Yet even this quiescent apex may be set pulsating if tied upon the end of a tube, through which it may be fed under pressure.

We may here point out that the whole heart or a part of it may be made to describe its action by the graphic method in various ways, the principles underlying which are either that the heart pulls upon a recording lever (lifts it) acts against the fluid of a manometer; or, inclosed in a vessel containing oil or similar fluid, moves a piston in a cylinder.

It has also long been known that a ligature drawn around the sinus venosus (in the frog) at its junction with the auricles stopped the heart for a certain period, and this experiment (of Stannius) was thought to demonstrate that the heart was arrested because the nervous impulses proceeding to the ganglion-cells along the cardiac nerves or ganglia of this region were cut off by the ligature; in other words, the heart ceased to beat because the outside machinery on which the action of the inner depended was suddenly disconnected. Other explanations have been offered of this fact.

Within the last few years great light has been thrown upon the whole subject of cardiac physiology in consequence of investigators having studied the hearts of various cold-blooded animals and of several invertebrates. The hearts of the *Chelonians* (tortoises, turtles) have received special attention, and their investigation has been fruitful of results, to the general outcome of which, as well as those accruing from recent comparative studies as a whole, we can alone refer.

Very briefly, the following are some of the main facts:

1. In all cold-blooded animals the order in which the subdivisions of the heart cease to pulsate when kept under the same conditions is invariable, viz., ventricle, auricles, sinus.
2. The sinus and auricles, when separated by section, liga-

ture, or otherwise, either together or singly, continue to beat, whether amply provided with or surrounded by blood.

3. The ventricle thus separated displays less tendency to beat independent of some stimulus (as feeding under pressure), though a very weak one usually suffices—i. e., its tendency to spontaneous rhythm is less marked than is the case with the other parts of the heart. These remarks apply to the hearts of *Chelonians*—fishes, snakes, and some other cold-blooded animals.

4. In certain fishes (skate, ray, shark) the beat may be reversed by stimulation, as a prick of the ventricle. This is accomplished with more difficulty in other cold-blooded animals, and still more so in the mammal.

5. In certain invertebrates, notably the *Poulpe* (Octopus), a careful search has revealed no nerve-cells, yet their hearts continue to beat when their nerves are severed, on section of parts of the organ, etc.

6. A strip of the muscle from the ventricle of the tortoise, when placed in a moist chamber and a current of electricity passed through it for some hours, will commence to pulsate and continue to do so after the current has been withdrawn; and this holds when the strip is wholly free from nerve-cells.

From the above facts certain inferences have been drawn: 1. It has been concluded that the sinus is the originator and director of the movements of the rest of the heart. 2. That this is owing to the ganglia in its walls. While all recognize the importance of the sinus, some physiologists hold to the ganglionic influence as essential to the heart-beat, still; while others, influenced by the facts mentioned above, are disposed to regard them as of very doubtful importance—at all events, as originators of the movements of the heart.

The tendency now seems to be to attach undue importance to the spontaneous contractility of the heart-muscle; for it by no means follows logically that, because a muscle treated by electricity, when cut off from the usual nerve influence that we believe is being constantly exerted on the heart like other organs, will contract and continue to do so in the absence of the stimulus, it does so normally; or, because some hearts beat in the absence of nerve-cells, that therefore nerve-cells are of no account in any case. Such views, when pressed to the extreme, lead to as narrow conceptions as those they are intended to replace.

Taking into account the facts mentioned and others we have

not space to enumerate, we submit the following as a safe view to entertain of the beat of the heart in the light of our present knowledge:

Recent investigations show clearly that there are great differences in the hearts of animals of diverse groups, so that it is not possible to speak of "the heart" as though our remarks applied equally to this organ in all groups of animals.

It must be admitted that our understanding of the hearts of the cold-blood animals is greater than of the mammalian heart; while, so far as exact or experimental knowledge is concerned, the human heart is the least understood of all, though there is evidence of a pathological and clinical kind and subjective experience on which to base conclusions possessing a certain value; but it is clear to those who have devoted attention to comparative physiology that the more this subject is extended the better prepared we shall be for taking a broad and sound view of the physiology of the human heart and man's other organs.

Whatever may be said of the invertebrates, among which greater simplicity of mechanism doubtless prevails, there can be no doubt that the execution of a cardiac cycle of the heart in all vertebrates, and especially in the higher, is a very complex process from the number of the factors involved, their interaction, and their normal variation with circumstances; and we must therefore be suspicious of any theory of excessive simplicity in this as well as other parts of physiology.

We submit, then, the following as a safe provisional view of the causation of the heart-beat:

1. The factors entering into the causation of the heart-beat of all vertebrates as yet examined are: (a) A tendency to spontaneous contraction of the muscle-cells composing the organ; (b) intra-cardiac blood-pressure; (c) condition of nutrition as determined directly by the nervous supply of the organ and indirectly by the blood.

2. The tendency to spontaneous contraction of muscle-cells is most marked in the oldest parts of the heart (e. g., sinus), ancestrally (phylogenetically) considered.

3. Intra-cardiac pressure exercises an influence in determining the origin of pulsation in probably all hearts, though like other factors its influence varies with the animal group. In the mollusk (and allied forms) and in the fish it seems to be the controlling factor.

4. We must recognize the power one cell has to excite when

in action neighboring heart-cells to contraction. The ability that one protoplasmic cell-mass has to initiate in others, under certain circumstances, like conditions with its own, is worthy of more serious consideration in health and disease than it has yet received.

5. The influence of the cardiac nerves becomes more pronounced as we ascend the animal scale. Their share in the heart's beat will be considered later.

6. Apparently in all hearts there is a functional connection leading to a regular sequence of beat in the different parts, in which the sinus or its representatives (the terminations of great veins in the heart) always takes the initiative. One part having contracted, the others must necessarily follow; hence the rapid onset of the ventricular after the auricular contraction in the mammal, and the long wave of contraction that seems to pass evenly over the whole organ in cold-blooded animals.

The basis of all these factors is to be sought finally in the *natural contractility of protoplasm*. A heart in its most developed form still retains, so to speak, the inherited but modified *Amœba* in its every cell.

Whether the intrinsic nerve-cells of the heart take any share *directly* in the cardiac beat must be considered as yet undetermined. Possibly they do modify motor impulses from nerves, while again it may be that they have an influence over nutritive processes only. The subject requires further study, both anatomical and physiological.

INFLUENCE OF THE VAGUS NERVE UPON THE HEART.

The principal facts in this connection may be stated as follows, and apply to all the animals thus far examined:

1. In all cases the action of the heart is modified by stimulation of the medulla oblongata or the vagus nerve.

2. The modification may consist in prompt arrest of the heart, in slowing, in enfeeblement of the beat, or a combination of the two latter effects.

3. After the application of the stimulation there is a latent period before the effect is manifest, and the latter may outlast the stimulation by a considerable period.

4. In most animals the sinus venosus and auricles are affected before the ventricles, and the vagus may influence these parts when it is powerless over the ventricle.

5. After vagus inhibition, the action of the heart is (almost

unexceptionally) different, the precise result being variable, but generally the beat is both accelerated and increased in force.

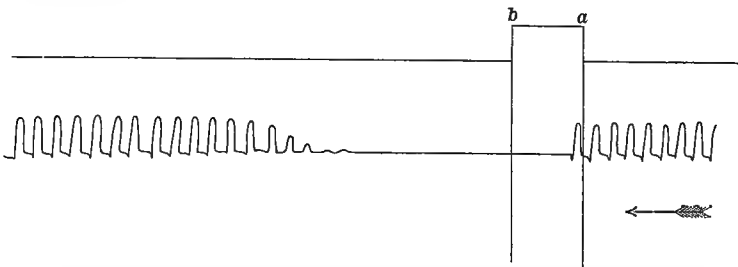

FIG. 238.—Inhibition of frog's heart by stimulation of the vagus nerve. To be read from right to left. The contractions of the ventricle are registered by a simple lever resting on it. The interrupted current was thrown in at *a*. Note that one beat occurred before arrest (latent period), and that when standstill of the heart did take place it lasted for a considerable period (Foster).

We may say that the working capacity of the heart is temporarily increased.

6. The improvement in the efficiency of the heart is in proportion to its previous working power, and in cases when the

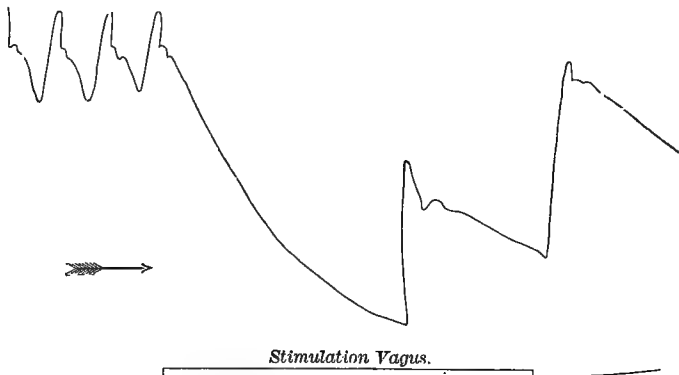

FIG. 239.—Effects of vagus stimulation, illustrated by a form of sphygmographic curve derived from the carotid of a rabbit (Foster).

action is feeble and irregular (abnormal) it might be said to be in proportion to its needs. This is a very important law that deserves to receive a general recognition.

7. Section of both vagi nerves results in histological alterations in the heart's structure, chiefly fatty degeneration, which must, of course, impair its working capacity and expose it to rupture or other accidents under the frequently recurring strains of life.

8. In the cold-blooded animals the heart may be kept at a standstill by vagus stimulation till it dies, a period of hours (one case of six hours reported for the sea-turtle).

9. Certain drugs (as atropine), applied directly to the heart, or injected into the blood, prevent the usual action of the vagus.

10. During vagus arrest the heart substance undergoes a change, resulting in an unusual dilatation of the organ. This may be witnessed whether the heart contains blood or not.

11. The heart may be arrested by direct stimulation, especially of the sinus, and at the points at which the electrodes are applied there is apparently a temporary paralysis. The same alteration in the beat may be noticed, as when the main trunk of the vagus is stimulated.

12. The heart may be inhibited through stimulation of various parts of the body, both of the surface and internal organs (reflex inhibition).

13. One vagus being divided, stimulation of its upper end may cause arrest of the heart.

14. Stimulation of a small part of the medulla oblongata will produce the same result, provided one or both vagi be intact.

15. Section of both vagi in some animals (the dog notably) increases the rate of the cardiac beat. The result of section of one pneumogastric nerve is variable. The heart's rhythm is usually to some extent quickened.

16. During vagus inhibition from any cause in mammals and many other animals, the heart responds to a single stimulus, as the prick of a needle, by at least one beat. An observer studying for himself the behavior of the heart in several groups of animals with an open mind, for the purpose of observing all he can rather than proving or disproving some one point, becomes strongly impressed with the variety in unity that runs through cardiac physiology, including the influence of nerve-cells (centers) through nerves; for it will not be forgotten that normally nerves originate nothing, being conductors only, so that when the vagus is stimulated by us we are at the most but imitating in a rough way the work of central nerve-cells. We can only mention a few points to illustrate this.

In the frog a succession of light taps, or a single sharp one ("Klopfversuch" of Goltz), will usually arrest the heart reflexly; though sometimes it is very difficult to accomplish. But in the fish the ease with which the heart may be reflexly

inhibited by gentle stimulation of almost any portion of the animal is wonderful. Again, in some animals the vagus arrests

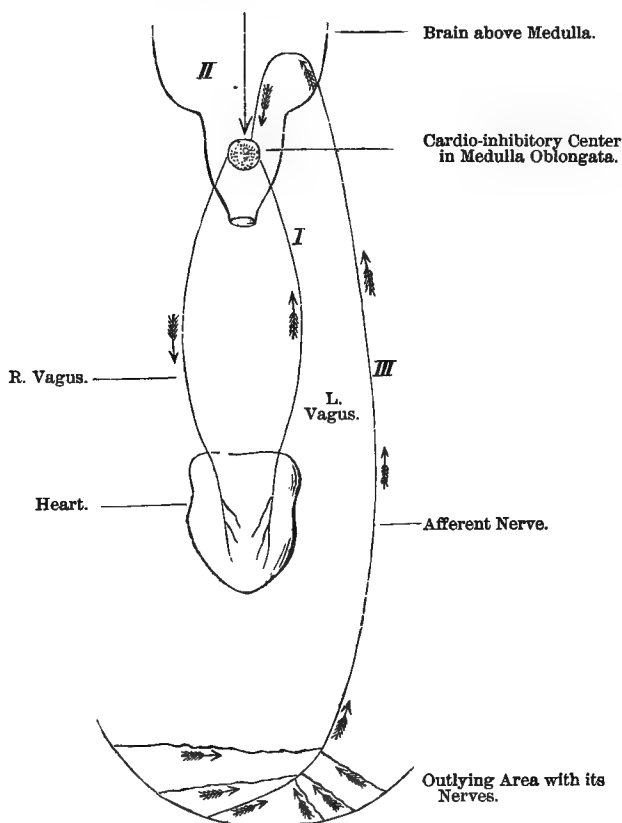

FIG. 240.—Diagram of the inhibitory mechanism of the heart. The arrows indicate in all cases the path the nervous impulses take. I. Path of afferent impulses from the heart itself. II. Path from parts of the brain above (or anterior to) the vaso-motor center. A similar one might, of course, be mapped out along the spinal cord. III. Path from some peripheral region. The downward arrows indicate the course of efferent impulses, which probably usually pass by both vagi.

the heart for only a brief period, when it breaks away into its usual (but increased) action.

In the fish, menobranchus, and probably other animals, the irritability of some subdivision of the heart is lost during the vagus inhibition—i. e., it does not respond to a mechanical stimulus.

There is usually a certain order in which the heart recommences after inhibition (viz., sinus, auricles, ventricles); but there are variations in this, also, for different animals. It is

also a fact that in most of the cold-blooded animals the right vagus is more efficient than the left, owing, we think, not to the nerves themselves so much as to their manner of distribution in the heart—the greater portion of the driving part of the organ, so to speak, being supplied by the right nerve; for, when even a small part of the heart is arrested, it may be overcome by the action of a larger portion of the same, or a more dominant region (the sinus mostly).

Conclusions.—The inferences from the facts stated in the above paragraphs are these: 1. There is in the medulla a collection of cells (center) which can generate impulses that reach the heart by the vagi nerves and influence its muscular tissue, though whether directly or through the intermediation of nerve-cells in its substance is uncertain. It may possibly be in both ways. 2. This center (cardio-inhibitory) may be influenced reflexly by influences ascending by a variety of nerves from the periphery, including paths in the brain itself, as shown by the influence of emotions or the behavior of the heart. 3. The cardio-inhibitory center is the agent, in part, through which the rhythm of the heart is adapted to the needs of the body. 4. The arrest, on direct stimulation of the heart, is owing to the effect produced on the terminal fibers of the vagi, as shown by the dilation, etc., corresponding to what takes place when the trunk of the nerve or the center is stimulated. 5. The quickening of the heart, following section of the vagi, seems to show that in some animals the inhibitory center exercises a constant regulative influence over the rhythm of the heart. 6. The irritability and dilatibility of the cardiac tissue may be greatly modified during vagus inhibition. Sometimes this is evident before the rhythm itself is appreciably altered. 7. The heart-muscle has a latent period, like other kinds of muscle; and cardiac effects, when initiated, last a variable period.

There are many other obvious conclusions, which the student will draw for himself.

But a question arises in regard to the significance of the cardiac arrest under these circumstances, and the altered action that follows. The fact that, when the heart is severed from the central nervous system by section of its nerves, profound changes in the minute structure of its cells ensue, points unmistakably to some nutritive influence that must have operated through the vagi nerves. That stimulation of the vagus restores regularity of rhythm and strengthens the beat of the

failing heart, is also very suggestive. That many disorders of the heart are coincident with periods of mental anguish or worry, and that in certain cases of severe mental application the heart's rhythm has become very slow, also point to influences of a central origin as greatly affecting the life-processes of this organ.

It has been shown that the vagus nerve in some cold-blooded animals, as is probable also in the higher vertebrates, *consists of two sets of fibers—those which are inhibitory proper and those which are not, but belong to the sympathetic system.*

Separate stimulation of the former favors nutritive processes, is preservative; of the latter, destructive. This has been expressed by saying that the former favors constructive (anabolic) metabolism; the latter destructive (katabolic) metabolism. It is assumed that all the metabolism of the body may be represented as made up of katabolic following anabolic processes.

Whether such a view of metabolism expresses any more than a sort of general tendency of the chemistry of the body is doubtful. It is a very simple representation of what in all probability is extremely complex; and if it be implied that throughout the body certain steps are always taken upward in construction to be always afterwards followed by certain downward destructive changes, we must reject it as too rigid and artificial a representation of natural processes.

We think, however, that, upon all the evidence, pathological and clinical as well as physiological, the student may believe that the vagus nerve, like the other nerves of the body, according to our own theory, exercises a constant beneficial, guiding—let us say determining—influence over the metabolism of the organ it supplies; and we here suggest that, if this view were applied to the origin and course of cardiac disease, it would result in a gain to the science and art of medicine.

THE ACCELERATOR (AUGMENTOR) NERVES OF THE HEART.

It has been known for many years that in the dog, cat, rabbit, and some other mammals, there were nerves proceeding from certain of the ganglia of the sympathetic chain high up, stimulation of which led to an acceleration of the heart-beat. Very recently these nerves have been traced in a number of cold-blooded animals, and the whole subject placed on a broader and sounder basis.

There are variations in the distribution of these nerves for different groups of animals, but it will suffice if we indicate their course in a general way, without special reference to the variations for each animal group: 1. These nerves emerge from the spinal cord (upper dorsal region), and proceed upward before being distributed to the heart. 2. They may leave for their cardiac destination either at (a) the first thoracic (or basal cardiac ganglion, as it might be named in this case), (b) the inferior cervical ganglion, (c) the annulus of Vieussens, or (d) the middle cervical ganglion.

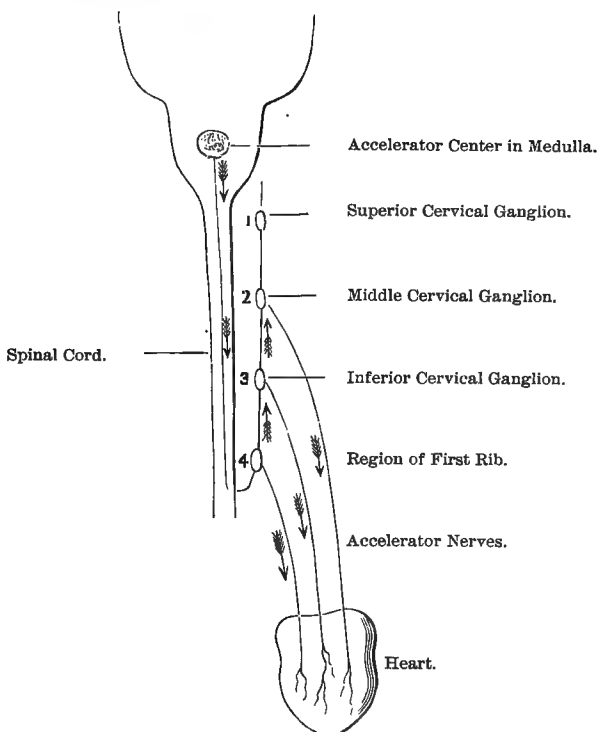

FIG. 241.—Diagram to illustrate the origin, course, etc., of accelerator impulses. It will be understood that this is intended to indicate the general plan, and not precisely what takes place in any one animal. Thus, while the accelerator nerves may arise in this way, it is not meant to be implied that the heart is actually supplied by *three* nerves of such origin in any case. The arrows, as before, indicate the path of the impulses.

Their course has been traced by physiological methods; thus it has been found that, in all animals examined, stimulation of the spinal cord or the various parts mentioned above, or nerve branches from them, gave rise either to acceleration of

the cardiac beat or augmentation of its force, or to both, as is commonly the case. In every instance the work of the heart is increased, so that they may be called more appropriately *augmentor* nerves; and their effect may be more evident on one part of the heart, as regards increase of the force of the beat, than on another.

They require for their fullest effect a rather strong and continuous stimulation (interrupted current), and the augmentation outlasts the stimulus a considerable period. The same law applies to them as to the vagus nerve, viz., that the result is inversely proportional to the rhythm of the heart at the period of stimulation; a slow-beating heart will be more augmented proportionally than a rapidly-pulsating organ.

It is noticeable that after one or more experiments the heart often falls into an irregular or weakened action quite the reverse of what ensues when the vagus is stimulated. But it has also been observed that certain of the vagus fibers on stimulation give rise to a like result.

Further, it is found that the electrical condition of the heart is different, according as the inhibitory or other fibers of the heart are stimulated. The latter fact seemed to point strongly to a fundamental difference in their effect on cardiac metabolism; hence it is proposed to speak of the vagus as a vago-sympathetic nerve, containing inhibitory fibers proper and sympathetic or motor fibers to be classed with the nerves that were formerly known as "accelerators," and to be compared in their action to the ordinary motor nerves of voluntary muscles.

Indeed, these conceptions will probably give rise to a broader view of the whole nervous system, especially as regards the relations of the nerves themselves.

Certainly the augmentor nerves to which we are now referring exhaust the heart, lead it to expend its nutritive capital, and leave it worse than before. One can understand the advantage in the heart having a double supply of nerve-fibers with opposite action; and it is worthy of special note in this connection that, when the vagus (vago-sympathetic) is stimulated at the same time as the augmentors, the inhibitory effect, preservative of nutritive resources, prevails.

It will be seen that the heart may be made to do increased work in three ways: Firstly, the relaxation of a normal inhibitory control through the vagus nerve by the cardio-inhibitory center; secondly, through the sympathetic (motor) fibers in

the vagus itself; and, finally, through fibers with similar action in the sympathetic system, usually so called.

The share taken by these factors is certainly variable in different species of animals, and it is likely that this is true of the same animals on different occasions. It is also conceivable, and indeed probable, that they act together at times, the inhibitory action being diminished and the augmentor influence increased.

Human Physiology.—Of the three cardiac nerves—superior, middle, and inferior—the strongest, which is the middle one, passes from the inferior cervical ganglion to the middle, from which it proceeds to the heart, and the inferior, may be regarded as the chief augmentor cardiac nerves.

That man's pneumogastric contains inhibitory fibers is evident from the experiment of Czermak, who, by pressing a bony tumor in his neck against his vagus nerve, could arrest his heart. Another individual could arrest his heart-beat at will, and if not through the vagus, how?

We are probably all aware of alterations in the rhythm of the heart from emotions. During a period of intense, brief, sympathetic anxiety, as in watching two competitors during a severe struggle for supremacy, a change in the rhythm of the heart, amounting, it may be, to momentary arrest, may be observed.

Enough has been said, we trust, to show that the nerves of the heart can no longer be regarded merely as the reins for bridling the cardiac steed; but that all the phenomena of acceleration, slowing, or other changes of rhythm, are only the outward evidences of profound vital changes accompanied by corresponding chemical and electrical effects. If these views be correct, nervous influence must play no small part in the causation and modification of disordered conditions; and we would extend such a view to all the organs of the body, and especially in the case of man. The heart's rhythm can, however, be modified in other ways than we have as yet described.

Though an isolated heart, fed by serum or some artificial nutritive fluid, may beat well for a time, it is liable to periodic interruptions, which are probably owing to its imperfect nutrition.

Many drugs greatly modify the heart-beat; but, in attempting to explain how the result is accomplished, the difficulty is in unraveling the part each anatomical element plays in the total result. Does the drug act on the muscular tissue, the

nerve terminals, or the ganglia; or does it affect the heart through the central nervous system?

Resort to comparative physiology is important in such cases, if only to foster caution and avoid narrow views.

THE HEART IN RELATION TO BLOOD-PRESSURE.

It is plain that all the other conditions throughout the circulatory system remaining the same, an increase in either the force or the frequency of the heart-beat must raise the blood-pressure. But, if the pressure were generally raised when the heart beats rapidly, it would fare ill with the aged, the elasticity of their arteries being usually greatly impaired. As a matter of fact any marked rise of pressure that would thus occur is prevented as a rule, and in different ways, as will be seen; but, so far as the heart is concerned, its beat is usually the weaker the more rapid it is, so that the cardiac rhythm and the blood-pressure are in inverse proportion to each other.

By what method is the heart's action tempered to the conditions prevailing at the time in the other parts of the vascular system?

The matter is complex. It is possible to conceive that there is a local nervous apparatus which regulates the beat of the heart according to the intra-cardiac pressure, which latter again will depend on conditions outside of the heart itself—the arterial pressure, in fact. It is possible to understand that, apart from any nervous elements at all, the cardiac cells regulate their own action in obedience to the impressions made upon them.

But, inasmuch as the heart is not regulated perfectly in the mammal according to the blood-pressure, when the vagi nerves are cut, and considering the dominance of the central nervous system, it does not seem likely that it should resign the control of so important a matter. Experiment bears this out. There is some evidence for believing that not only may the vagus itself act as an afferent sensory nerve, but that the depressor nerve, to be shortly referred to more particularly, is also such a sensory nerve.

However, such a view does not exclude previously mentioned factors, and there can be little doubt that in forms below mammals the muscular tissue is to some degree self-regulative; and it is not likely that this quality is wholly lost even in the highest mammals.

The effect of *vagus stimulation* on the blood-pressure is always very marked, as would be supposed. To examine an extreme case, suppose the heart arrested for a few seconds, the elastic recoil of the arteries continues to maintain for a time the blood-pressure, though there is, of course, an immediate and pronounced fall. And it may be remarked, by-the-way, that in cases of fainting, when the heart ceases to beat, or beats in the feeblest manner, the importance of this arterial elasticity as a force, maintaining the circulation for several seconds at least, is of great importance.

As seen in the tracing, the beats, when the heart commences its action again, tell on the comparatively slack walls of the

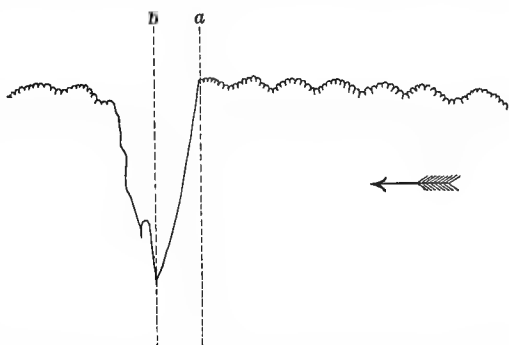

FIG. 242.—Tracing from a rabbit, showing the influence of cardiac inhibition on blood-pressure. The fall in this case was very rapid, owing to sudden cessation of the heart-beat. The relative emptiness of the vessels accounts for the peculiar character of the curve of rising blood-pressure (Foster).

arteries, distending them greatly, and this may be made evident by the sphygmograph as well as the manometer; indeed, may be evident to the finger, the pulse resembling in some features that following excessive loss of blood.

If the heart has been merely slowed, or its pulsation weakened, the effects will of course be less marked.

The Quantity of Blood.—The blood-pressure may also be augmented, the cardiac frequency remaining the same, by the *quantity* of blood ejected from the ventricles, which again depends on the quantity entering them, a factor determined by the condition of the vessels, and to this we shall presently turn.

In consequence of changes in different parts of the system by way of compensation, results follow in an animal which might not have been anticipated.

Thus, bleeding, unless to a dangerous extreme, does not lower the blood-pressure except temporarily. It is estimated that the body can adapt itself to a loss of as much as 3 per cent of the body-weight.

The adaptation is probably not through absorption chiefly,

but through constriction of the vessels by the vaso-motor nerves.

Again, an injection of fluid into the blood does not cause an appreciable rise of blood-pressure, so long as the nervous system is intact; but, if by section of the spinal cord the vaso-motor influences are cut off, then a rise may take place to the extent of 2 to 3 per cent of the body-weight, the extra quantity of fluid seeming to be accommodated in the capillaries and smaller veins. These facts are highly significant in illustrating the adaptive power of the circulatory system (protective in its nature), and are of practical importance in the treatment of disease.

We think the benefit that sometimes follows bleeding has not as yet received an adequate explanation, but we shall not attempt to tackle the problem now. Changes in the circulation depend on variations in the size of the blood-vessels.

It is important in considering this subject to have clear notions of the structure of the blood-vessels. It will be borne in mind that, while muscular elements are perhaps not wholly lacking in any of the arteries, they are most abundant in the smallest, the arterioles, which by their variations in size are best fitted to determine the quantity of blood reaching any organ. It is well known that nerves derived chiefly from the sympathetic system pass to blood-vessels, though their exact mode of termination is obscure.

We may now examine into the nature of certain facts, which may be stated briefly thus:

1. In certain vascular areas of some vertebrates, as in the vessels of the ear of the rabbit and this animal's saphena artery, rhythmical variations in the size of the small arteries may be observed; also in the *veins* of the bat's wing and of the fins of certain fishes (e. g., caudal vein of the eel), as well as in certain arteries of some groups of the cold-blooded animals.

2. Under the microscope the arterioles of various parts of the frog, including those of the muscles, may be seen to vary apparently spontaneously, and may through stimulation be made to depart widely from their usual size.

3. Section of a large number of nerves is followed by reddening of the parts to which they are distributed. This is well seen when the cervical sympathetic of the rabbit is divided; the ear becomes redder, owing to obvious dilatation of its blood-vessels; and warmer, owing to the increased quantity of blood in it, etc. It has also been noticed in cases of paralysis, and

especially in gunshot and other wounds involving nerves, that vaso-motor effects have followed.

4. Section of certain nerves, as the *nervi erigentes* of the penis, is not followed by dilatation; but these nerves and the *chorda tympani* supplying the salivary gland are examples of so-called *vaso-dilators*, inasmuch as their stimulation gives rise to enlargement of the caliber of the arterioles in their area of distribution.

5. On the other hand, such a nerve as the cervical sympathetic, as may be readily shown in the rabbit, when its peripheral end is stimulated, gives rise to constriction, and hence is termed a *vaso-constrictor*.

6. When, however, the divided sciatic nerve is stimulated peripherally, the result may be either constriction or dilatation.

7. When the spinal cord of an animal is divided across, there is vascular dilatation of all the parts below the section (loss of arterial tone); but in time the vessels return to their usual size (restoration of arterial tone).

8. On destruction of a certain minute portion of the medulla oblongata, there is a *general* loss of arterial tone. This area (center) extends in the rabbit from a short distance below the corpora quadrigemina (1 to 2 mm.) to within 4 to 5 of the calamus scriptorius, as ascertained by the effects on the vessels of cutting away the medulla in thin transverse sections. At the spot indicated there is a collection of large multipolar nerve-cells (antero-lateral nucleus of Clarke).

Conclusions.—1. There are *vaso-motor* nerves of two kinds—*vaso-constrictors* and *vaso-dilators*—which may exist in nerve-trunks either alone or mingled.

Examples of the former are found in the cervical sympathetic, splanchnic, etc., of the latter in the *chorda tympani*, nerves of the muscles and *nervi erigentes* (from the first, second, and third sacral nerves), while the sciatic seems to contain both. 2. Impulses are constantly passing from the medullary vaso-motor center along the nerves to the blood-vessels, hence their dilatation after section of the nerves.

The nerves are traceable to the spinal cord, and in some part of their course run, as a rule, in the sympathetic system. 3. Impulses pass at intervals to the areas of distribution of vaso-dilators along these nerves, the effect of which is to dilate the vessels through their influence, as in other cases, on the muscular coat.

It is stated that in course of time the vessels of the rabbit's ear regain their tone, notwithstanding that the influence of the

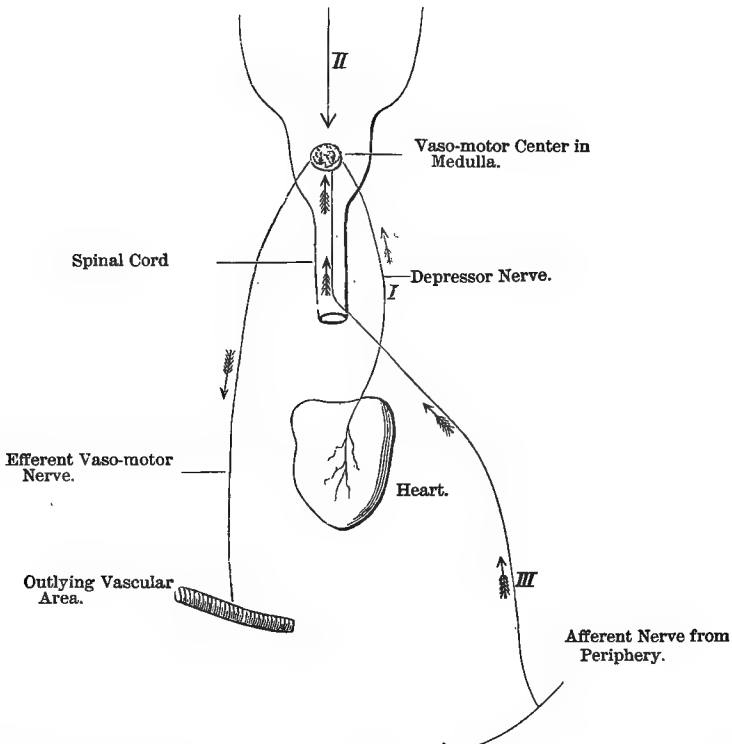

FIG. 243.—Diagram of nervous vaso-motor mechanism. I. Course of afferent impulses from the heart itself along the depressor nerve. II. Course from some other part of the brain. III. Course from some peripheral region along a nerve joining the spinal cord. The efferent impulses are represented as passing to a vascular area, reduced for the sake of simplicity to a single arteriole.

central nervous system has been cut off by section of the vaso-motor nerves.

To explain this result, a *local* nervous mechanism has been assumed to exist, though not demonstrated either anatomically or physiologically. Interesting experiments have lately shown that both in mammals and cold-blooded animals the effect on the blood-vessels varies with the intensity and character of the stimulus, and not only with the group of animals tested, but even with the same individuals at different periods during the experiment; and we take the opportunity to renew our expression of opinion with this fresh evidence that the laws of physiology can not be laid down in the rigid way that has prevailed

to so large an extent up to the present time; but that our widening experience shows (what ought to have been expected) that the greatest allowance must be made for group if not individual variations everywhere. There is also evidence to show that the mode of stimulation in experimental cases causes the result to vary. From such facts as are stated in paragraph seven, it is inferred that there are vaso-motor centers in the spinal cord which are usually subordinated to the main center in the medulla, but which in the absence of the control of the chief center in the medulla assume an independent regulating influence.

A local vaso-motor mechanism does not seem to us necessary to explain the changes which the blood-vessels undergo, and should not be adopted as an article of physiological faith till demonstrated to exist. If we assume that the independent contractility of muscle-cells is retained in the blood-vessels, and that, when freed from the influence of the central nervous system, which becomes more and more dominant as we ascend the animal scale, there is a *reversion* to an ancestral condition, a new light is thrown upon the facts. It is a case of old habits gaining sway when the check-rein of nervous influence is removed; and, as we shall show from time to time, this law applies to every organ of the body. Moreover, not to go beyond the vascular system, this independent rhythmic activity is seen in the isolated sections of the pulsatile veins of the bat's wing, devoid, so far as we know, of nervous cells. Such facts lend some color to the view that, after distention of the vessels by the cardiac systole, the return to their previous size is aided by rhythmical contractions of the muscle-cells.

Let us now consider certain other well-known experimental facts:

1. There is a nerve with variable origin, course, etc., in different mammals, but in the rabbit given off from either the vagus, the superior laryngeal, or by a branch from each, which, running near the sympathetic nerve and the carotid artery, reaches the heart, to which it is distributed. This is known as the *depressor* nerve.

2. The vagi nerves having been divided, stimulation of the central end of the cut depressor nerve is followed by a fall in blood-pressure, which may not be accompanied by any alteration in the cardiac rhythm.

3. This effect may in great part be prevented if the splanchnic nerves be divided previous to stimulation of the depressor.

4. If the splanchnic area (region of the main abdominal

viscera) be inspected during the fall in blood-pressure, it may be noticed that there is vascular fullness under these circumstances.

These results are interpreted as being due to afferent impulses ascending the depressor, acting on the vaso-motor center,

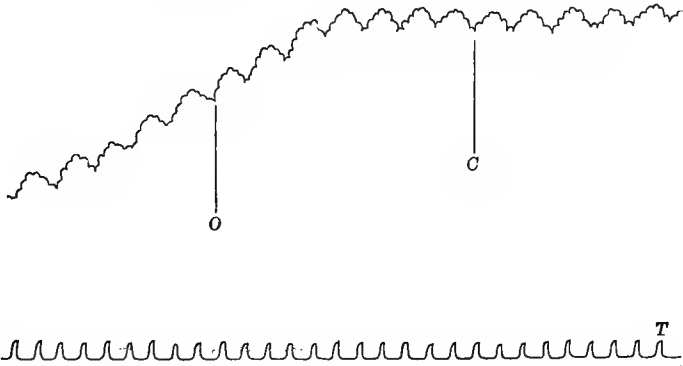

FIG. 244.—Curve of blood-pressure resulting from stimulation of the central end of the depressor nerve. To be read from right to left. *T* indicates the rate at which the recording surface moved, the intervals denoting seconds. At *C* the current was thrown into the nerve, and shut off at *O*. The result appears after a period of latency, and outlasts the stimulus (Foster).

and interfering with (inhibiting) the outflow of efferent, constrictive, or tonic impulses, which start from the vaso-motor center, descend the cord, and find their way to the organs of the region in question, in consequence of which the muscular coats of the arterioles relax, more blood flows to this area which is very large, and the general blood-pressure is lowered.

Again, if the central end of one of the main nerves—e. g., sciatic—be stimulated, a marked change in the blood-pressure results, but whether in the direction of rise or fall seems to depend upon the condition of the central nervous system, for, with the animal under the influence of chloral, there is a fall; if under urari, a rise.

It is not to be supposed that the change in any of these cases is confined to any one vascular area invariably, but that it is this or that, according to the nerve stimulated, the condition of the centers, and a number of other circumstances. Moreover, it is important to bear in mind that with a fall of blood-pressure in one region there may be a corresponding rise in another. With these considerations in mind, it will be apparent that the changes in the vascular system during the

course of a single hour are of the most complex and variable character.

Though special attention has been drawn to such rhythmical variations as may be witnessed in the rabbit's ear, bat's wing, etc., there can be little doubt that changes as marked, though possibly less distinctly rhythmical, are constantly taking place in the vertebrate body, and especially in that of man, with his complex emotional nature and the many vicissitudes of modern civilized life. The frequent changes in color in the faces of certain people are in this connection suggestive, though we hope we have made it clear that these vascular modifications are dependent chiefly on centripetal influences from every quarter, though actually brought about by centrifugal impulses. Whether there is a rhythm obscured by minor rhythms, owing to an independent or automatic action of the vaso-motor center, though not improbable, must be regarded as undetermined as yet.

The question of the distribution of vaso-motor nerves to veins is also one to which a definite answer can not be given.

THE CAPILLARIES.

The cells of which the capillaries are composed have a contractility of their own, and hence the caliber of the capillaries is not determined merely by the arterial pressure or any similar mechanical effect.

Certain abnormal conditions, induced in these vessels by the application of irritants, cause changes in the blood-flow, which can not be explained apart from the vitality of the vessels themselves.

Watched through the microscope under such circumstances, the blood-corpuscles no longer pursue their usual course in the mid-stream, but seem to be generally distributed and to hug the walls, one result of which is a slowing of the stream, wholly independent of events taking place in other vessels. It is thus seen that in this condition (*stasis*) the capillaries have an independent influence essentially vital. We say independent, for it is still an open question whether nerves are distributed to capillaries or not. That inflammation, in which also the walls undergo such serious changes that white and even red blood-cells may pass through them (*diapedesis*), is not uninfluenced by the nervous system, possibly induced through it in certain cases, if not all, seems more than probable.

But when we consider the lymphatic system new light will, it is hoped, be thrown upon the subject of the nature and the influences which modify the capillaries. One thing will be clear from what has been said, that even normally the capillaries must exert an influence of the nature of a resistance, owing to their peculiar vital properties; and, as we have already intimated, such considerations should not be excluded from any conclusions we may draw in regard to tubes that are made up of living cells, whether arteries, veins, or capillaries, though manifestly the applicability to capillaries with their less modified or more primitive structure is stronger.

It has now become clear that the circulation may be modified either centrally or peripherally; that a change is never purely local, but is correlated with other changes; that the whole is, in the higher animals, directly under the dominion of the central nervous system; and that it is through this part chiefly that harmony in the vascular as in other systems and with other systems is established. To have adequately grasped this conception is worth more than a knowledge of all the details.

SPECIAL CONSIDERATIONS.

Pathological.—Changes may take place either in the substance of the cardiac muscles, in the valves, or in the blood-vessels, of a nature unfavorable to the welfare of the body. Some of these have been incidentally referred to already.

Hypertrophy, or an increase in the tissue of the heart, is generally dependent on increased resistance, either within or without the heart, in the region of the arterioles or capillaries. Imperfections of the aortic valves may permit of regurgitation of blood, entailing an extra effort if it is to be expelled in addition to the usual quantity, which again leads to hypertrophy; but this is often succeeded by dilatation of the chambers of the heart one after the other, and a host of evils growing out of this, largely dependent on imperfect venous circulation, and increased venous pressure. And it may be here noticed that arterial and venous pressures are, as a general rule, in inverse proportion to each other.

If the quantity of blood in the ventricle, in consequence of regurgitation, should prove to be greater than it can lift (eject), the heart ceases to beat in diastole; hence some of the sudden deaths from disease of the aortic valves.

As a result of fatty, or other forms of degeneration, the heart may suddenly rupture under strains.

Actual experiment on the arteries of animals recently dead, including men, shows that the elasticity of the arteries of even adult mammals is as perfect as that of the vessels of the child, so that man ranks lower than other animals in this respect.

After middle life the loss of arterial elasticity is considerable and progressive. The arteries may undergo a degeneration from fatty changes or deposit of lime; such vessels are, of course, liable to rupture; hence one of the frequent modes of death among old persons is from paralysis traceable to rupture of vessels in the brain.

These and other changes also cause the heart more work, and may lead to hypertrophy. Even in young persons the strain of a prolonged athletic career may entail hypertrophy or some other form of heart-disease.

We mention such facts as these to show the more clearly how important is balance and the power of ready adaptation in all parts of the circulation to the maintenance of a healthy condition of body.

The heart is itself nourished through the coronary arteries; so that morbid alterations in these vessels cause, if not sudden and painful death, at least nutritive changes in the heart-substance, which may lead to a dramatic end or to a slow impairment of cardiac power, etc.

Personal Observation.—The circulation is one of those departments of physiology in which the student may verify much upon his own person. The cardiac impulse, the heart's sounds (with a double stethoscope), the pulse—its nature and changes with circumstances, the venous circulation, and many other subjects, are all easy of observation, and after a little practice without liability of causing those aberrations due to the attention being drawn to one's self.

The observations need not, of course, be confined to the student's own person; it is, however, very important that the normal should be known before the observer is introduced to cases of disease. Frequent comparison of the natural and the diseased condition renders physiology, pathology, and clinical medicine much good service. We again urge upon the student to try to form increasingly vivid and correct mental pictures of the circulation under its many changes.

Comparative.—An interesting arrangement of blood-vessels, known as a *rete mirabile*, occurs in every main group of verte-

brates. An artery breaks up into a great number of vessels of nearly the same size, which terminate, abruptly and without capillaries, in another arterial trunk.

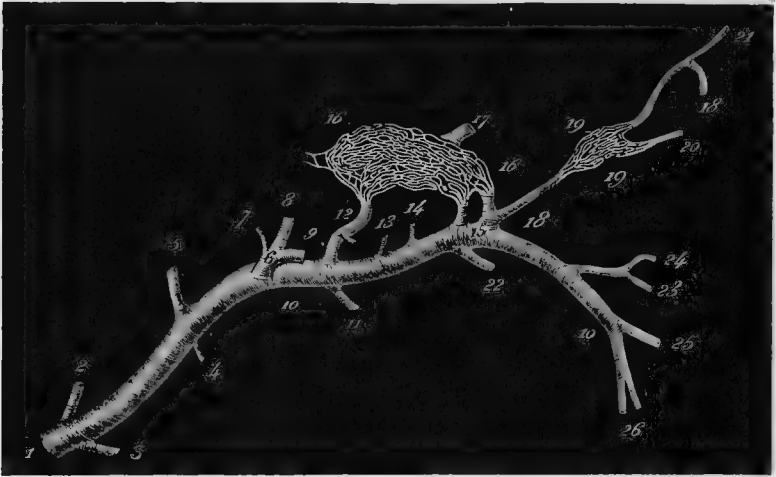

FIG. 245.—*Rete mirabile* of sheep, seen in profile (after Chauveau). The larger *rete* is in connection with the encephalic arteries; the smaller, the ophthalmic. The large artery is the carotid.

They are found in a variety of situations, as on the carotid and vertebrate arteries of animals that naturally feed from the ground for long periods together, as the ruminants; in the

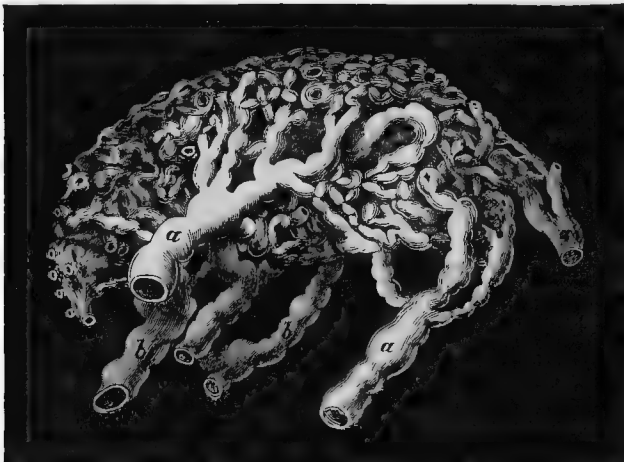

FIG. 246.—Section of a lymphatic *rete mirabile*, from the popliteal space (after Chauveau). *a, a*, afferent vessels; *b, b*, efferent vessels. The whole very strongly suggests a crude form of lymphatic gland.

sloth, that hangs from trees; in the legs of swans, geese, etc.; in the horse's foot, in which the arteries break up into many small divisions. It has been suggested that these arrangements permit of a supply of arterial blood being maintained without congestion of the parts. Very marked tortuosity of vessels, as in the seal, the carotid of which is said to be forty times as long as the space it traverses, in all probability serves the same purpose.

Evolution. — The comparative sketch we have given of the vascular system will doubtless suggest a gradual evolution. We observe throughout a dependence and resemblance which we think can not be otherwise explained. The similarity of the foetal circulation in the mammal to the permanent circulation of lower groups has much meaning. Even in the highest form of heart the original pulsatile tube is not lost. The great veins still contract in the mammal; the sinus venosus is probably the result of blending and expansion. The later differentiations of the parts of the heart are clearly related to the adaptation to altered surroundings. Such is seen in the foetal heart and circulation, and has probably been the determining cause of the forms which the circulatory organs have assumed.

It is a fact that the part of the heart that survives the longest under adverse conditions is that which bears the stamp of greatest ancestral antiquity. It (the sinus venosus) may not be less under nervous control, but it certainly is least dependent on the nervous system, and has the greatest automaticity.

It is surely fortunate for man that this part of the reptilian heart is represented in his own. In cases of fainting, partial drowning, or other instances of impending death, this part, with



FIG. 247.—Veins of the foot of the horse (after Chauveau).

the auricles it may be, continues to beat when the ventricles have ceased; and we have learned that so long as these parts are functionally active there is a greater probability that the quiescent regions may recommence. Activity begets activity, in cardiac muscle-cells at least. How are these facts to be explained apart from evolution?

The law of rhythm in organic nature finds some of its most evident exemplifications in the circulation. Most of the rhythms are compound, one being blended with or superimposed on another. Even the apparent irregularities of the normal heart are rhythmical, such as the very marked slowing and other changes accompanying expiration, especially in some animals.

We trust we have made it evident that the greatest allowance must be made for the animal group, and some even for the individual, in estimating any one of the factors of the circulation. We know a good deal at present of cardiac physiology, but we do not know a physiology of "the heart" in the sense in which we understand that term to have been used till recently—i. e., we are not in a position to state the laws that apply to all forms of heart.

Summary of the Physiology of the Circulation.—In the mammal the circulatory apparatus forms a closed system consisting of a central pump or heart, arteries, capillaries, and veins. All the parts of the vascular system are elastic, but this property is most developed in the arteries.

Since the tissue-lymph is prepared from the blood in the capillaries, it may be said that the whole circulatory system exists for these vessels.

As a result of the action of an intermittent pump on elastic vessels against peripheral resistance, in consequence of which the arteries are always kept more than full (distended), the flow through the capillaries and veins is constant—a very great advantage, enabling the capillaries to accomplish their work of feeding the ever-hungry tissues. While physical forces play a very prominent part in the circulation of the blood, vital ones must not be ignored. They lie at the foundation of the whole, here as elsewhere, and must be taken into the account in every explanation.

As a consequence of the anatomical, physical, and vital characters of the circulatory system, it follows that the velocity of the blood is greatest in the arteries, least in the capillaries, and intermediate in the veins.

The veins with their valves, their superficial position and thinner walls, make up a set of conditions favoring the onflow of the blood, especially under muscular exercise.

In the mammal the circulatory system, by reason of its connections with the digestive, respiratory, and lymphatic systems, and in a lesser degree with all parts of the body, especially the glandular organs, maintains at once the usefulness and the fitness of the blood.

The arterioles, by virtue of their highly developed muscular coat, are enabled to *regulate* the blood-supply to every part, in obedience to the nervous system.

The blood exercises a certain pressure on the walls of all parts of the vascular system, which is greatest in the heart itself, high in the arteries, lower in the capillaries, and lowest in the veins, in the largest of which it may be less than the atmospheric pressure, or negative. The heart in the mammal consists of four perfectly separated chambers, each upper and each lower pair working synchronously, intermixture of arterial and venous blood being prevented by septa and interference in working by valves. The heart is a force-pump chiefly, but, to some extent, a suction-pump also, though its power as such purely from its own action and independent of the respiratory movements of the chest is slight under ordinary circumstances. In consequence of the lesser resistance in the pulmonary division of the circulation, the blood-pressure within the heart is much less in the right than in the left ventricle—a fact in harmony with and causative of the greater thickness of the walls of the latter; for in the foetus, in which the conditions are different, this distinction does not hold.

The ventricles usually completely empty themselves of blood and maintain their systolic contraction even after this has been effected. The contraction of the heart, which really begins in the great veins near their junction with the auricles (that do not fully empty themselves), is at once followed up by the auricular and ventricular contraction, the whole constituting one long peristaltic wave. Then follows the cardiac pause, which is of longer duration than the entire systole.

When the heart contracts it hardens, owing to closing on a non-compressible fluid dammed back within its walls by resistance *a fronte*. At the same time the hand placed on the chest-walls over the heart is sensible of the cardiac impulse, owing to what has just been mentioned. The systole of the chambers of the heart gives rise to a first and a second sound, so called,

caused by several events combined, in which, however, the tension of the valves must take a prominent share. The work of the heart is dependent on the quantity of blood it ejects and the pressure against which it acts. The pulse is an elevation of the arterial wall, occurring with each heart-beat, in consequence of the passage of a wave over the general blood-stream. There is a distention of the entire arterial system in every direction. The pulse travels with extreme velocity as compared with the blood-current. The heart-beat varies in force, frequency, duration, etc., and with age, sex, posture, and numerous other circumstances.

The whole of the circulatory system is regulated by the central nervous system through nerves. There is in the medulla oblongata a small collection of nerve-cells making up the cardio-inhibitory center. This center, with varying degrees of constancy, depending on the group of animals and the needs of the organism, sends forth impulses (which modify the beat of the heart in force and frequency) through the vagi nerves. There are nerves of the sympathetic system with a center in the cervical spinal cord, and possibly another in the medulla, which are capable of originating either an acceleration of the heart-rhythm or an increase of the force of the beat, or both together, known as accelerators or augmentors. In the vertebrates thus far examined the vagus is in reality a vago-sympathetic nerve, containing inhibitory fibers proper, and sympathetic, accelerator, or motor fibers.

The inhibitory fibers can arrest, slow, or weaken the cardiac beat; the sympathetic accelerate it or augment its force. When both are stimulated together, the inhibitory prevail.

These nerves, as also the accelerators, exercise a profound influence upon the nutrition of the heart, and effect its electrical condition when stimulated, and we may believe when influenced by their own centers.

The inhibitory fibers tend to preserve and restore cardiac energy; the sympathetic, whether in the vagus or as the augmentors, the reverse. The vagus nerve (and probably the depressor) acts as an afferent, cardiac sensory nerve reporting on the intra-cardiac pressure, etc., and so enabling the vaso-motor and cardio-inhibitory centers, which are, it would seem, capable of related and harmonious action to act for the general good.

The arterioles must be conceived as undergoing very frequent changes of caliber. They are governed by the vaso-

motor center, situated in the medulla, and possibly certain subordinate centers in the spinal cord, through vaso-motor nerves. These are (*a*) vaso-constrictors, which maintain a constant but variable degree of contraction of the muscle-cells of the vessels; (*b*) vaso-dilators, which are not in constant functional activity; and (*c*) mixed nerves, with both kinds. An inherited tendency to rhythmical contraction throughout the entire vascular system, including the vessels, must be taken into account.

The depressor nerve acts by lessening the tonic contraction of (dilating) the vessels of the splanchnic area especially.

It is important to remember that all the changes of the vascular system, so long as the nervous system is intact—i. e., so long as an animal is normal—are correlated; and that the action of such nerves as the depressor is to be taken rather as an example of how some of these changes are brought about, mere chapters in an incomplete but voluminous history, if we could but write it all. The changes in blood-pressure, by the addition or removal of a considerable quantity of blood, are slight, owing to the sort of adaptation referred to above, effected through the nervous system. Finally, the capillary circulation, when studied microscopically, and especially in disordered conditions, shows clearly that the *vital* properties of these vessels have an important share in determining the character of the circulation in themselves directly and elsewhere indirectly.

The study of the circulation in other groups shows that below birds the arterial and venous blood undergoes mixture somewhere, usually in the heart, but that in all the vertebrates the best blood is invariably that which passes to the head and upper regions of the body. The deficiencies in the heart, owing to the imperfections of valves, septa, etc., are in part counteracted in some groups by pressure relations, the blood always flowing in the direction of least resistance, so that the above-mentioned result is achieved.

Capillaries are wanting in most of the invertebrates, the blood flowing from the arteries into spaces (sinuses) in the tissues. It is to be noted that a modified blood (lymph) is also found in the interspaces of the cells of organs. Indeed, the circulatory system of lower forms is in many respects analogous to the lymphatic system of higher ones.

DIGESTION OF FOOD.

The processes of digestion may be considered as having for their end the preparation of food for entrance into the blood.

This is in part attained when the insoluble parts have been rendered soluble. At this stage it becomes necessary to inquire as to what constitutes *food* or a food.

Inasmuch as animals, unlike plants, derive none of their food from the atmosphere, it is manifest that what they take in by the mouth must contain every chemical element, in some form, that enters into the composition of the body.

But actual experience demonstrates that the food of animals must, if we except certain salts, be in organized form—i. e., it must approximate to the condition of the tissues of the body in a large degree. Plants, in fact, are necessary to animals in working up the elements of the earth and air into form suitable for them.

Foodstuffs are divisible into :

I. Organic.

1. Nitrogenous.

(a.) Albumins.

(b.) Albuminoids (as gelatine).

2. Non-nitrogenous.

(a.) Carbohydrates (sugars, starches).

(b.) Fats.

II. Inorganic.

1. Water.

2. Salts.

Animals may derive the whole of their food from the bodies of other animals (*carnivora*); from vegetable matter exclusively (*herbivora*); or from a mixture of the animal and vegetable, as in the case of the pig, bear, and man himself (*omnivora*).

It has been found by feeding experiments, carried out mostly on dogs, that animals die when they lack any one of the constituents of food, though they live longer on the nitrogenous than any other kind. In some instances, as when fed on gelatine and water, or sugar and water, the animals died almost as soon as if they had been wholly deprived of food. But it has also been observed that some animals will all but starve rather than eat certain kinds of food, though chemically sufficient.

We must thus recognize something more in an animal than merely the mechanical and chemical processes which suffice to accomplish digestion in the laboratory. A food must be not only sufficient from the chemical and physical point of view, but be capable of being acted on by the digestive juices, and of such a nature as to suit the particular animal that eats it.

To illustrate, bones may be masticated and readily digested by a hyena, but not by an ox or by man, though they meet the conditions of a food in containing all the requisite constituents. Further, the food that one man digests readily is scarcely digestible at all by another; and it is within the experience of every one that a frequent change of diet is absolutely necessary.

Since all mammals, for a considerable period of their existence, feed upon milk exclusively, this must represent a perfect or typical food. It will be worth while to examine the composition of milk. The various substances composing it, and their relative proportions for different animals, may be seen from the following table, which is based on a total of 1,000 parts:

CONSTITUENTS.	Human.	Cow.	Goat.	Ass.
Water.....	889.08	857.05	863.58	910.24
Casein	39.24	48.28	33.60	20.18
Albumin.....		5.76	12.99	
Butter.....	26.66	43.05	43.57	12.56
Milk-sugar	43.64	40.37	40.04	57.02
Salts.....	1.38	5.48	6.22	
Total solids.....	110.92	142.95	136.42	89.76

The fact that human milk is poorer in proteids and fats especially is of practical importance, for, when cow's milk is substituted in the feeding of infants, it should be diluted, and sugar and cream added if the normal proportions of mother's milk are to be retained.

1. The *proteids* of milk are:

(a.) An albumin very like serum-albumin.

(b.) Casein, normally in suspension, in the form of extremely minute particles, which contributes to the opacity of milk.

It can be removed by filtration through porcelain; and precipitated or coagulated by acids and by rennet, an extract of the mucous membrane of the calf's stomach. After this coagulation, whey, a fluid more or less clear, separates, which contains the salts and sugar of milk and most of the water. Much of the fat is entangled with the casein.

Casein, with some fat, makes up the greater part of cheese.

2. *Fats*.—Milk is an emulsion—i. e., contains fat suspended in a fine state of division. The globules, which vary greatly in size, are surrounded by an envelope of proteid matter. This covering is broken up by churning, allowing the fatty globules to run together and form butter.

Butter consists chiefly of olein, palmitin, and stearin, but contains in smaller quantity a variety of other fats. The rancidity of butter is due to the presence of free fatty acids, especially butyric.

The fat of milk usually rises to the surface as cream when milk is allowed to stand.

3. *Milk-sugar*, which is converted into lactic acid, probably by the agency of some form of micro-organism, thus furnishing acid sufficient to cause the precipitation or coagulation of the casein.

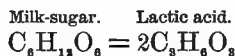

Milk, when fresh, should be neutral or faintly alkaline.

4. *Salts* (and other extractives), consisting of phosphates of calcium, potassium, and magnesium, potassium chloride, with traces of iron and other substances.

It can be readily understood why children fed on milk rarely suffer from that deficiency of calcium salts in the bones leading to rickets, so common in ill-fed children. It thus appears that milk contains all the constituents requisite for the building up of the healthy mammalian body; and experiments prove that these exist in proper proportions and in a readily digestible form. The author has found that a large number of animals, into the usual food of which, in the adult form, milk does not enter, like most of our wild mammals, as well as most birds, will not only take milk but soon learn to like it, and thrive well upon it. Since the embryo chick lives upon the egg, it might have been supposed that eggs would form excellent food for adult animals, and common experience proves this to be the case; while chemical analysis shows that they, like milk, contain all the necessary food constituents. *Meat* (muscle, with fat chiefly) is also, of course, a valuable food, abounding in proteids. *Cereals* contain starch in large proportion, but also a mixture of proteids. *Green vegetables* contain little actual nutritive material, but are useful in furnishing salts and special substances, as certain compounds of sulphur which, in some ill-understood way, act beneficially on the metabolism of the body.

They also seem to stimulate the flow of healthy digestive fluids. *Condiments* act chiefly, perhaps, in the latter way. Tea, coffee, etc., contain alkaloids, which it is likely have a conservative effect on tissue waste, but we really know very little as to how it is that they prove so beneficial. Though they are recognized to have a powerful effect on the nervous system as stimulants, nevertheless it would be erroneous to suppose that their action was confined to this alone.

Animal Foods.

Explanation of the signs.

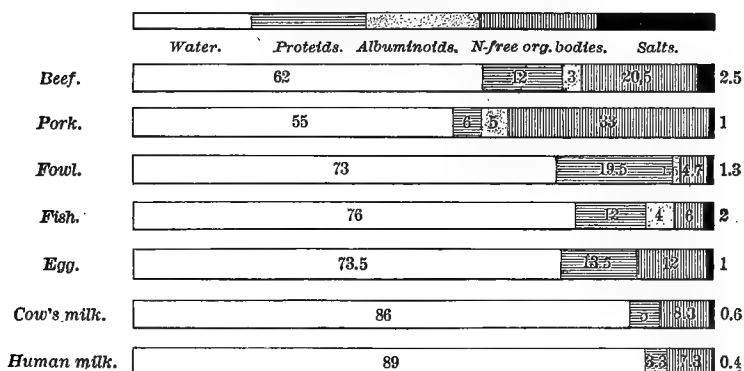

Vegetable Foods.

Explanation of the signs.

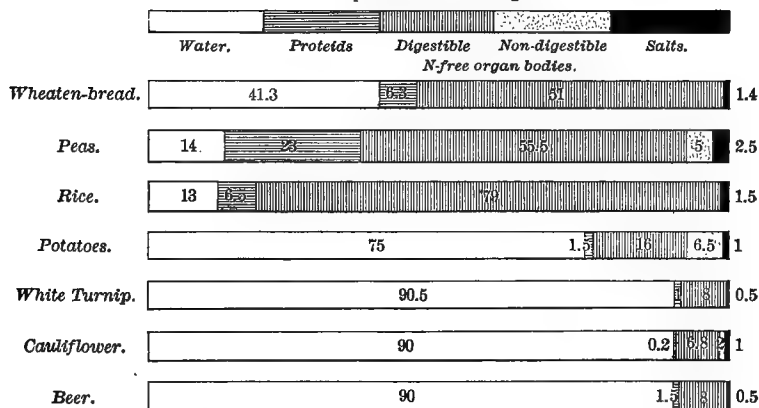

FIG. 248 (Landois).

The accompanying diagrams will serve to represent to the eye the relative proportions of the food-essentials in various kinds of articles of diet.

It is plain that if, in the digestive tract, foods are changed in solubility and actual chemical constitution, this must have

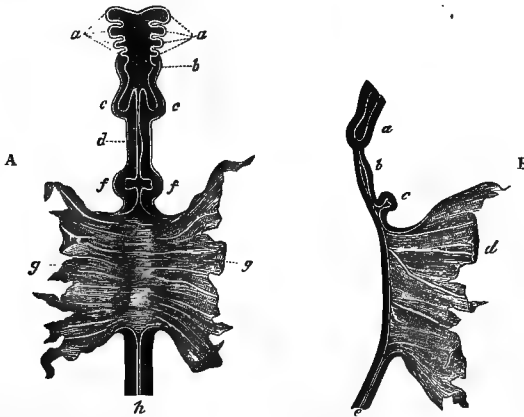

FIG. 249.—Alimentary canal of embryo while the rudimentary mid-gut is still in continuity with yolk-sac (Kölliker, after Bischoff). A. View from before. *a*, pharyngeal plates; *b*, pharynx; *c, c*, diverticula forming the lungs; *d*, stomach; *f*, diverticula of liver; *g*, membrane torn from yolk-sac; *h*, hind-gut. B. Longitudinal section. *a*, diverticulum of a lung; *b*, stomach; *c*, liver; *d*, yolk-sac.

been brought about by chemical agencies. That food is broken up at the very commencement of the alimentary tract is a matter of common observation; and that there should be a gradual movement of the food from one part of the canal to

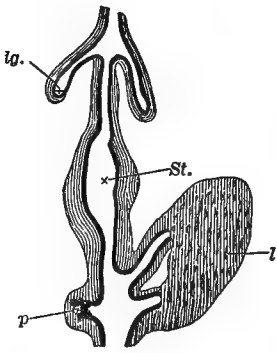

FIG. 250.

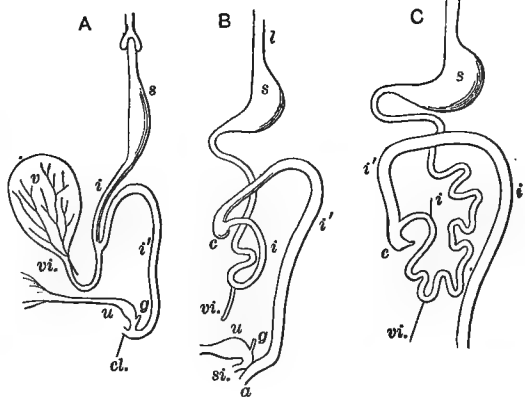

FIG. 251.

FIG. 250.—Diagram of alimentary canal of chick at fourth day (Foster and Balfour, after Götte). *ig*, diverticulum of one lung; *St*, stomach; *l*, liver; *p*, pancreas.
 FIG. 251.—Position of various parts of alimentary canal at different stages. A. Embryo of five weeks. B. Of eight weeks. C. Of ten weeks (Allen Thompson). *l*, pharynx with the lungs; *s*, stomach; *i*, small intestine; *i'*, large intestine; *g*, genital duct; *u*, bladder; *cl*, cloaca; *c*, cæcum; *vi*, ductus vitello-intestinalis; *si*, urogenital sinus; *v*, yolk-sac.

another, where a different fluid is secreted, would be expected. As a matter of fact, mechanical and chemical forces play a large part in the actual preparation of the food for absorption. Behind these lie, of course, the vital properties of the glands, which prepare the active fluids from the blood, so that a study of digestion naturally divides itself into the consideration of—

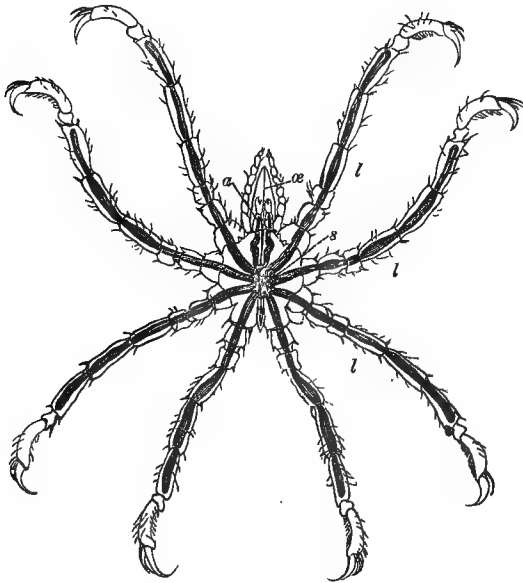

FIG. 252.—*Ammothea pycnogonides*, a marine animal (after Quatrefages). *a*, œsophagus; *a*, antennæ; *s*, stomach, with prolongations into antennæ and limbs (*l*).

1. The digestive juices; 2. The secretory processes; and, 3. The muscular and nervous mechanism by which the food is carried from one part of the digestive tract to another, and the waste matter finally expelled.

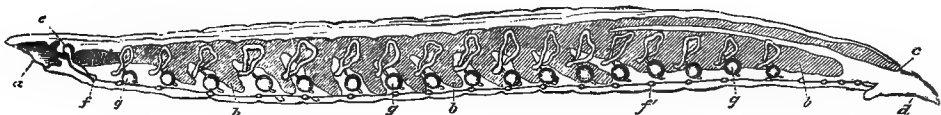

FIG. 253.—Longitudinal vertical section of body of leech, *Hirudo medicinalis* (after Leuckart). *a*, mouth; *b, b*, sacculations of alimentary canal; *c*, anus; *d*, terminal sucker; *e*, cerebral ganglia; *f, f'*, chain of post-œsophageal ganglia; *g, g*, segmental organs.

Embryological.—The alimentary tract, as we have seen, is formed by an infolding of the splanchnopleure, and, according as the growth is more or less marked, does the canal become

tortuous or remain somewhat straight. The alimentary tract of a mammal passes through stages of development which correspond with the permanent form of other groups of vertebrates, according to a general law of evolution. Inasmuch as the embryonic gut is formed of mesoblast and hypoblast, it is easy to understand why the developed tract should so invariably consist of glandular structures and muscular tissue disposed in a certain regular arrangement. The fact that all the

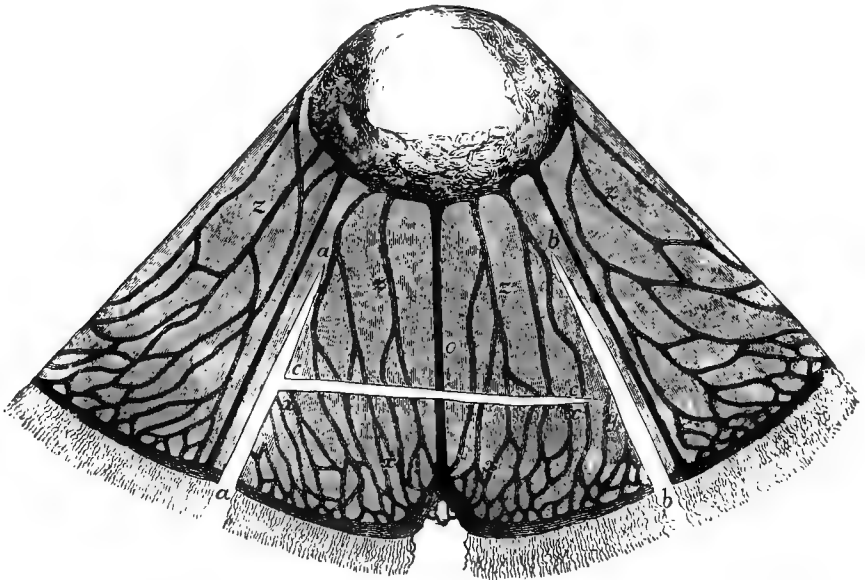

FIG. 254.—Portion of a jelly-fish, the *Medusa Aurelia*, showing gastro-vascular canals radiating from central stomach and terminating in a circular marginal canal (after Romanes). All these are shaded very dark; the light spaces indicate artificial sections. Inasmuch as these canals as well as the stomach must contain some sea-water, and since their contents represent the whole of the nutritive fluid (answering to the blood, lymph, and chyle of higher forms), we have both anatomically and physiologically a very crude or undifferentiated condition in such animals, and one of great interest from an evolutionary point of view.

organs that pour digestive juices into the alimentary tract are outgrowths from it serves to explain why there should remain a physiological connection with an anatomical isolation. The general resemblance of the epithelium throughout, even in parts widely separated, also becomes clear, as well as many other points we can not now refer to in detail, to one who realizes the significance of the laws of descent (evolution).

Comparative.—Amœba ingests and digests apparently by every part of its body; though exact studies have shown that it neither accepts nor retains without considerable power of

discrimination; and it is also possible that some sort of digestive fluid may be secreted from the part of the body with which the food-particles come in contact. It has been shown, too, that there are differences in the digestive capacity of closely allied forms among Infusorians.

The ciliated Infusorians have a permanent mouth, which may also serve as an anus; or, there may be an anus, though usually less distinct from the rest of the body than the mouth.

Among the Cœlenterates *intra-cellular* digestion is found. Certain cells of the endoderm (as in *Hydra*) take up food-parti-

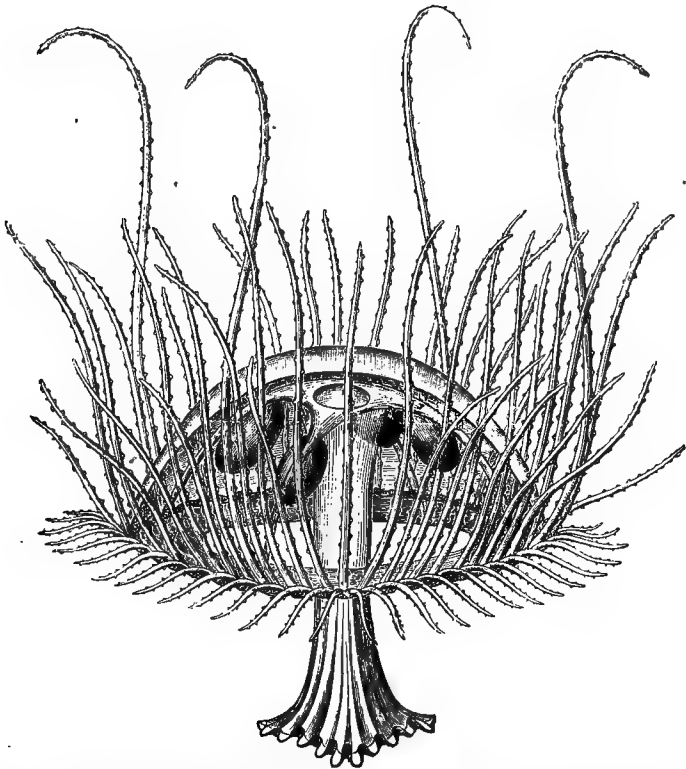

FIG. 255.—A jelly-fish, the *Medusa Limnocodium* (after Allman). Note the long proboscis (mouth) leading up to the stomach, from which radiate the gastro-vascular canals. A portion of the bell has been removed, showing the generative arranged around the digestive organs. Most of the tentacles are turned up.

cles Amœba-like, digest them, and thus provide material for other cells as well as themselves, in a form suitable for assimilation. This is a beginning of that differentiation of function

which is carried so far among the higher vertebrates. But, as recent investigations have shown, such intra-cellular digestion exists to some extent in the alimentary canal of the highest members of the vertebrate group (see page 345).

The means for grasping and triturating food among invertebrates are very complicated and varied, as are also those adapted for sucking the juices of prey. Examples to hand are to be found in the crab, crayfish, spider, grasshopper, beetle,

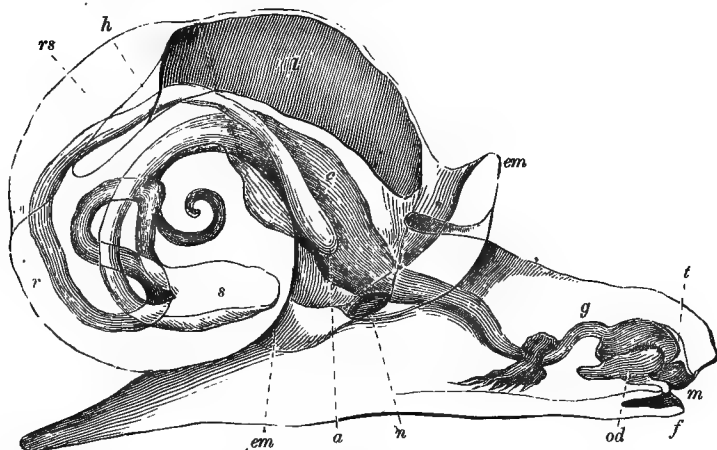

FIG. 256.—Diagram illustrating arrangement of intestine, nervous system, etc., in common snail, *Helix* (after Huxley). *m*, mouth; *t*, tooth; *od*, odontophore; *g*, gullet; *c*, crop; *s*, stomach; *r*, rectum; *a*, anus; *r. s.*, renal sac; *h*, heart; *l*, lung (modified pallial chamber); *n*, its external aperture; *em*, thick edge of mantle united with sides of body; *f*, foot; *cp, p, sp*, cerebral, pedal, and parieto-splanchnic ganglia aggregated round gullet.

etc., on the one hand, and the butterfly, house-fly, leech, etc., on the other.

The digestive system of the earth-worm has been studied with some care. It illustrates a sort of extra-corporeal digestion, in that it secretes a fluid from the mouth which seems to act both chemically and mechanically on the starch-grains of the leaves on which it feeds. It is provided with an organ in which, as with birds, small stones are found, so that the imperfections of its mouth are compensated for by this gizzard which triturates the food. Its calciferous glands supply the alkaline fluids necessary to neutralize the humus acids of decaying leaves, for intestinal digestion only proceeds in an alkaline medium.

The gastric mill of a crab (Fig. 228) is a provision of obvious value in so voracious a creature.

Before passing on to higher groups, it will be well to bear in mind that the digestive organs are to be regarded as the out-

come both of heredity and adaptation to circumstances. We find parts of the intestine, e. g., retained in some animals in whose economy they seem to serve little if any good purpose, as the vermiform appendix of man. Adaptation has been illustrated in the lifetime of a single individual in a remarkable manner; thus, a seagull, by being fed on grain, has had its stomach, naturally thin and soft-walled, converted into a muscular gizzard.

Since digestion is a process in which the mechanical and chemical are both involved, and the food of animals differs

so widely, great variety in the alimentary tract, both anatomical and physiological, must be expected. Vegetable food must usually be eaten in much larger bulk to furnish the needed elements; hence the great length of intestine habitually

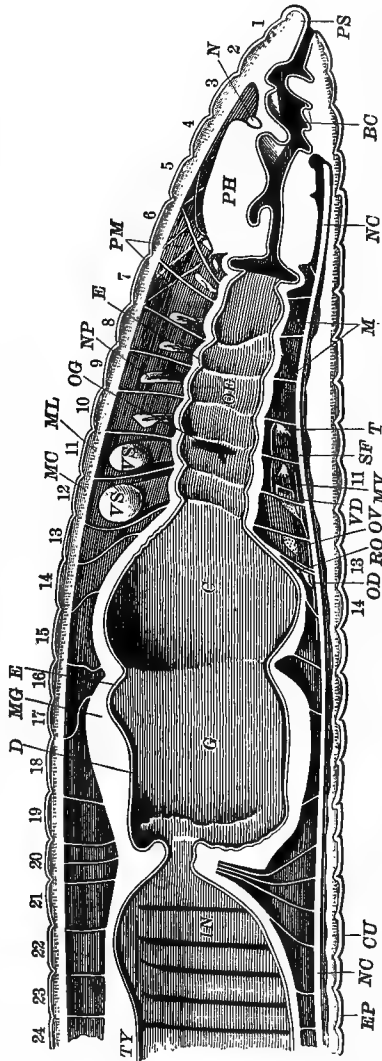

FIG. 257. — *Lumbricus terrestris* (common earthworm). Longitudinal vertical section through anterior portion of animal (after Marshall and Hurst). BC, buccal cavity; C, crop; GU, cuticle; D, thickened cuticle of gizzard; E, epithelium of alimentary canal; EP, epidermis; G, gizzard; IN, intestine; M, retrociliary muscles of anterior part of cesophagus; MC, circular muscular wall of body-wall; MG, muscular wall of gizzard; ML, longitudinal muscles of body-wall; N, dorsal portion of nerve-coll, cut across; NC, ventral nerve-chain; NP, neupridium; OD, oviduct; OE, cesophagus; OG, aperture of calciferous gland; the passage is forward as indicated by the arrow; O, ovary; PH, pharynx; PM, retractor muscles of pharynx; PS, prostomium; RD, receptaculum ovarium; SF, seminal funnel, the expanded mouth of vas efferens; T, anterior testis; TX, typhlosole; VD, vas detereus; VS, posterior appendages of the median vesiculæ seminales; 1-24, first twenty-four segments.

found in herbivorous animals, associated often with a capacious and chambered stomach, furnishing a larger laboratory in



FIG. 258.—The viscera of a rabbit as seen upon simply opening the cavities of the thorax and abdomen without any further dissection. *A*, cavity of the thorax, pleural cavity on either side; *B*, diaphragm; *C*, ventricles of the heart; *D*, auricles; *E*, pulmonary artery; *F*, aorta; *G*, lungs collapsed, and occupying only back part of chest; *H*, lateral portions of pleural membranes; *I*, cartilage at the end of sternum (ensiform cartilage); *K*, portion of the wall of body left between thorax and abdomen; *a*, cut ends of the ribs; *L*, the liver, in this case lying more to the left than to the right of the body; *M*, the stomach, a large part of the greater curvature being shown; *N*, duodenum; *O*, small intestine; *P*, the caecum, so largely developed in this and other herbivorous animals; *Q*, the large intestine. (Huxley.)

which Nature may carry on her processes. To illustrate, the stomach of the ruminants consists of four parts (*rumen*, *reticulum*, *omasum* (*psalterium*), *abomasum*). The food when cropped is immediately swallowed; so that the paunch (*rumen*) is a mere storehouse in which it is softened, though but little changed otherwise; and it would seem that real gastric di-

gestion is almost confined to the last division, which may be compared to the simple stomach of the *Carnivora* or of man; and, before the food reaches this region, it has been thoroughly masticated and mixed with saliva.

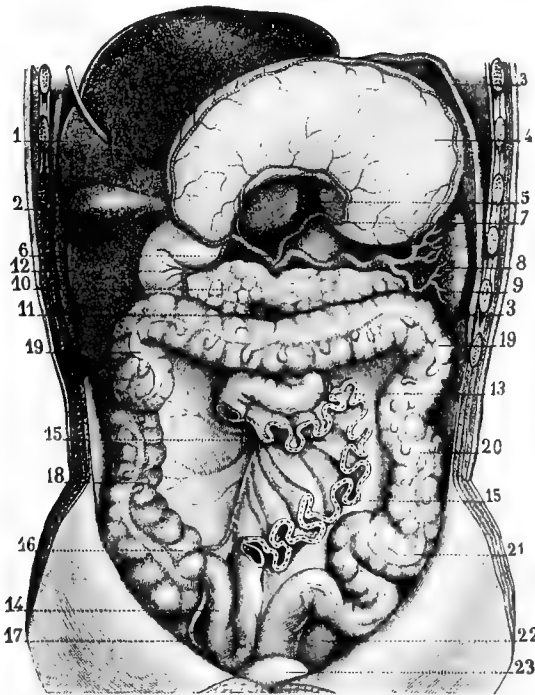

FIG. 259.—Stomach, pancreas, large intestine, etc. (after Sappey). 1, anterior surface of liver; 2, gall-bladder; 3, 3, section of diaphragm; 4, posterior surface of stomach; 5, lobus Spigelii of liver; 6, coeliac axis; 7, coronary artery of stomach; 8, splenic artery; 9, spleen; 10, pancreas; 11, superior mesenteric vessels; 12, duodenum; 13, upper extremity of small intestine; 14, lower end of ileum; 15, 15, mesentery; 16, caecum; 17, appendix vermiformis; 18, ascending colon; 19, 19, transverse colon; 20, descending colon; 21, sigmoid flexure of colon; 22, rectum; 23, urinary bladder.

The reticulum is especially adapted for holding water, which may serve a good purpose in moistening and thinning the contents of the stomach. In the camels and llamas a portion of the stomach is made up of pouches, which can be closed with sphincter muscles, and thus shut off the water-supply in separate tanks, as it were.

The stomach of the horse is small, though the intestine, especially the large gut, is capacious.

The stomach is divisible into a cardiac region, of a light color internally, and lined with epithelium, like that of the

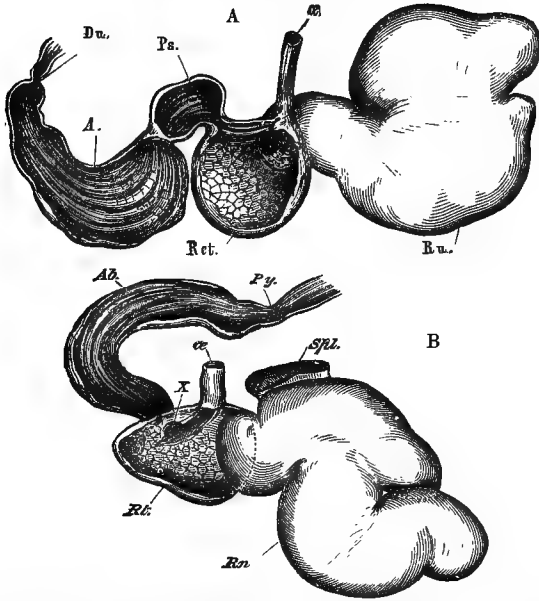

FIG. 260.—A. Stomach of sheep. B. Stomach of musk-deer. α , oesophagus; *Rn.*, rumen; *Ret.*, reticulum; *Ps.*, psalterium; *A.*, *Ab.*, abomasum; *Du.*, duodenum; *Py.*, pylorus (Huxley).

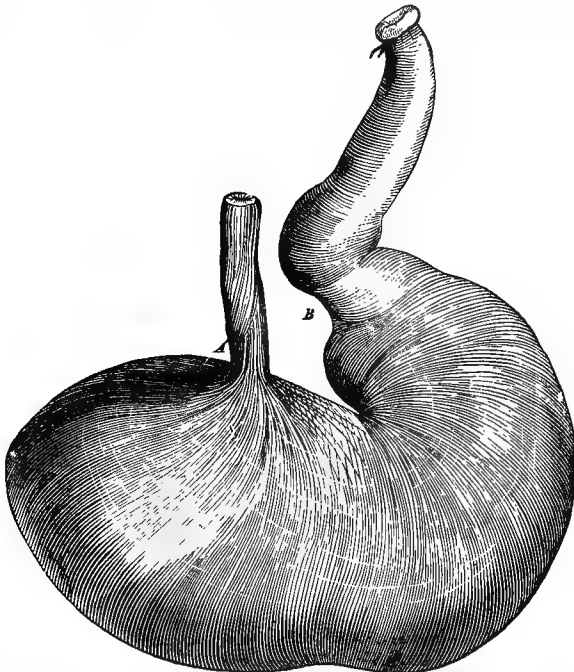

FIG. 261.—Stomach of horse (after Chauveau). *A.*, cardiac extremity of oesophagus; *B.*, pyloric ring.

œsophagus, and a redder pyloric area, in which the greater part of the digestive process goes on.

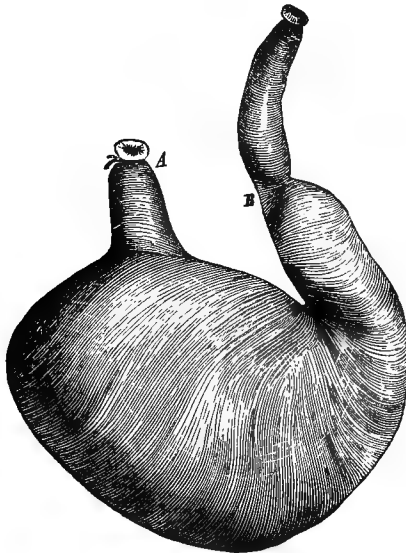

FIG. 262.—Stomach of dog (after Chauveau). A, œsophagus ; B, pylorus.

The mouth parts, even in some of the higher vertebrates, as the *Carnivora*, serve a prehensile rather than a digestive purpose. This is well seen in the dog, that bolts his food; but in this and allied groups of mammals gastric digestion is very active.

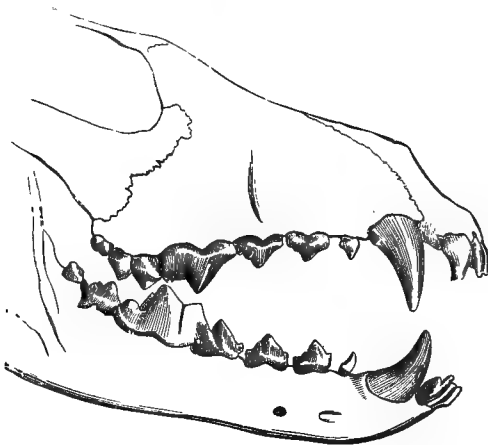

FIG. 263.—General and lateral view of dog's teeth (after Chauveau).

The teeth as triturating organs find their highest development in ruminants, the combined side-to-side and forward-and-backward motion of the jaws rendering them very effective.

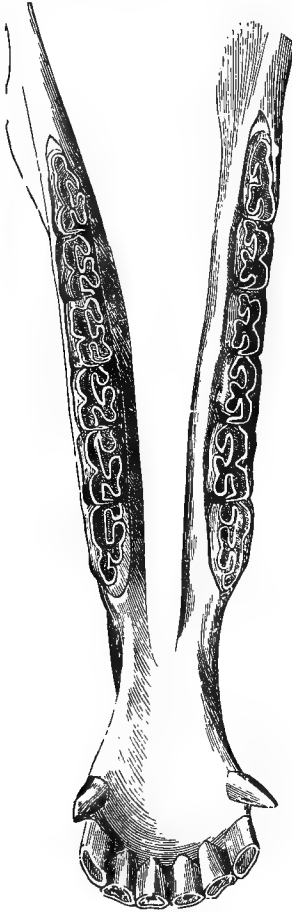

FIG. 264.

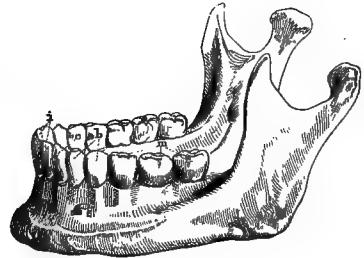

FIG. 265.

FIG. 264.—Dentition of inferior jaw of horse (after Chauveau).

FIG. 265.—Inferior maxilla of man (after Sappey). Alveolar border; *i*, incisor teeth; *c*, canine teeth; *b*, bicuspid teeth; *m*, molars.

In *Carnivora* the teeth serve for grasping and tearing, while in the *Insectivora* the tongue, as also in certain birds (woodpeckers), is an important organ for securing food.

It is to be noted, too, that, while the horse crops grass by biting it off, the ox uses the tongue, as well as the teeth and lips, to secure the mouthful.

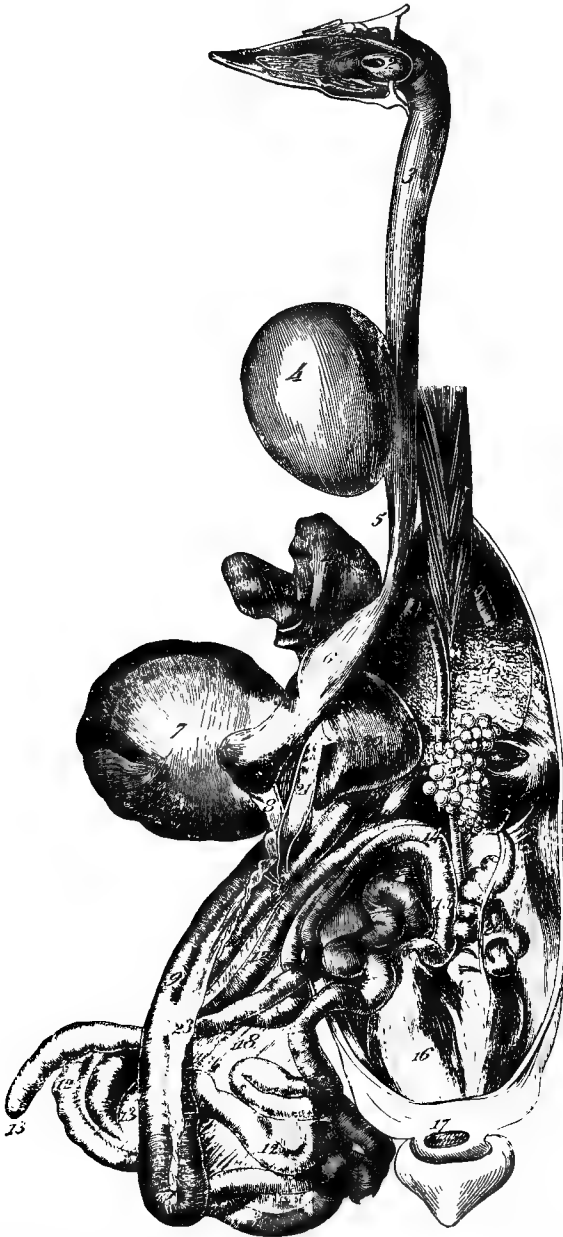

FIG. 266.—General view of digestive apparatus of fowl (after Chauveau). 1, tongue; 2, pharynx; 3, first portion of œsophagus; 4, crop; 5, second portion of œsophagus; 6, succentric ventricle (proventriculus); 7, gizzard; 8, origin of duodenum; 9, first branch

of duodenal flexure; 10, second branch of same; 11, origin of floating portion of small intestine; 12, small intestine; 12', terminal portion of this intestine, flanked on each side by the two cæca (regarded as the analogue of colon of mammals); 13, 13, free extremities of cæcums; 14, insertion of these two *cæca-de-sac* into intestinal tube; 15, rectum; 16, cloaca; 17, anus; 18, mesentery; 19, left lobe of liver; 20, right lobe; 21, gall-bladder; 22, insertion of pancreatic and biliary ducts; the two pancreatic ducts are the most anterior, the choledic or hepatic is in the middle, and the cystic duct is posterior; 23, pancreas; 24, diaphragmatic aspect of lung; 25, ovary (in a state of atrophy); 26, oviduct.

Man's teeth are somewhat intermediate in form between the carnivorous and the herbivorous type. Birds lack teeth, but the strong muscular gizzard suffices to grind the food against the small pebbles that are habitually swallowed.

The crop, well developed in granivorous birds, is a dilatation of the œsophagus, serving to store and soften the food.

In the pigeon a glandular epithelium in the crop secretes a milky-looking substance, that is regurgitated into the mouth of the young one, which is inserted within that of the parent bird.

The proventriculus—an enlargement just above the gizzard—is relatively to the latter very thin-walled, but provides the true gastric juices.

Certain plants digest proteid matter, like animals; thus the sun-dew (*Drosera*), by the closure of its leaves, captures insects, which are digested and the products absorbed. The digestive fluid consists of a pepsin-containing secretion, together with formic acid.

THE DIGESTIVE JUICES.

Saliva.—The saliva as found in the mouth is a mixture of the secretion of three pairs of glands, alkaline in reaction, of a specific gravity of 1002 to 1006, with a small percentage of solids (2 per cent), consisting of salts and organic bodies (mucin, proteids).

Saliva serves mechanical functions in articulation, in moistening the food, and dissolving out some of its salts. But its principal use in digestion is in reducing starchy matters to a soluble form, as sugar. So far as known, the other constituents of the food are not changed chemically in the mouth.

The Amylolytic Action of Saliva.—Starch exists in grains, surrounded by a *cellulose* covering, which saliva does not digest; hence its action on raw starch is slow.

It is found that if a specimen of boiled starch not too thick be exposed to a small quantity of saliva at the temperature of the body or thereabout (37° to 40° C.), it will speedily undergo certain changes:

1. After a very short time sugar may be detected by Feh-

ling's solution (copper sulphate in an excess of sodium hydrate, the sugar reducing the cupric hydrate to cuprous oxide on boiling).

2. At this early stage starch may still be detected by the blue color it gives with iodine; but later, instead of a blue, a purple or red may appear, indicating the presence of *dextrin*, which may be regarded as a product intermediate between starch and sugar.

3. The longer the process continues, the more sugar and the less starch or dextrin to be detected; but, inasmuch as the quantity of sugar at the end of the process does not exactly correspond with the original quantity of starch, even when no starch or dextrin is to be found, it is believed that other bodies are formed. One of these is achroodextrin, which does not give a color reaction with iodine.

The sugars formed are: (a) Dextrose. (b) Maltose, which has less reducing power over solutions of copper salts, a more pronounced rotatory action on light, etc.

It is found that the digestive action of saliva, as in the above-described experiment, will be retarded or arrested if the sugar is allowed to accumulate in large quantity. That digestion in the mouth is substantially the same as that just described can be easily shown by holding a solution of starch in the mouth for a few seconds, and then testing it for sugar, when it will be invariably found.

While salivary digestion is not impossible in a neutral medium, it is arrested in an acid one even of no great strength (less than one per cent), and goes on best in a feebly alkaline medium, which is the condition normally in the mouth. Though a temperature about equal to that of the body is best adapted for salivary digestion, it will proceed, we have ourselves found, at a higher temperature than digestion by any other of the juices, so far as man is concerned—a fact to be connected, in all probability, with his habit for ages of taking very warm fluids into the mouth.

∨ The active principle of saliva is *ptyalin*, a nitrogenous body which is assumed to exist, for it has never been perfectly isolated. It belongs to the class of unorganized ferments, the properties of which have been already referred to before (page 160).

Characteristics of the Secretion of the Different Glands.—Parotid saliva is in man not a viscid fluid, but clear and limpid, containing very little mucin. Submaxillary saliva in most animals

and in man is viscid, while the secretion of the sublingual gland is still more viscid.

Comparative.—Saliva differs greatly in activity in different animals; thus saliva in the dog is almost inert, that of the parotid gland quite so; in the cat it is but little more effective; and in the horse, ox, and sheep, it is known to be of very feeble digestive power.

In man, the Guinea-pig, the rat, the hog, both parotid and submaxillary saliva are active; while in the rabbit the submaxillary saliva, the reverse of the preceding, is almost inactive, and the parotid secretion very powerful.

An aqueous or glycerine extract of the salivary glands has digestive properties. The secretion of the different glands may be collected by passing tubes or cannulas into their ducts.

Pathological.—Potassium sulphocyanate (which gives a red color with salts of iron) is sometimes present normally, but is said to be in excess in certain diseases, as rheumatism.

The saliva, normally neutral or only faintly acid, may become very much so in the intervals of digestion. The rapid decay of the teeth occurring during and after pregnancy seems in certain cases to be referable in part to an abnormal condition of the saliva, and in part to the drain on the lime salts in the construction of the bones of the foetus.

The *tartar* which collects on the teeth consists largely of earthy phosphates.

Gastric Juice.—Gastric juice may be obtained from a fistulous opening into the stomach. Such may be made artificially by an incision over the organ in the middle line, catching it up and stitching it to the edges of the wound, incising and inserting a special form of cannula, which may be closed or opened at will.

Digestion in a few cases of accidental gastric fistulæ has been made the subject of careful study. The most instructive case is that of Alexis St. Martin, a French Canadian, into whose stomach a considerable opening was made by a gunshot-wound.

Gastric juice in his case and in the lower animals with artificial openings in the stomach, has been obtained by irritating the mucous lining mechanically with a foreign body, as a feather.

The great difficulty in all such cases arises from the impossibility of being certain that such fluid is normal; for the conditions which call forth secretion are certainly such as the stomach never experiences in the ordinary course of events,

and we have seen how saliva varies, according as the animal is fasting or feeding, etc.

Bearing in mind, then, that our knowledge is possibly only approximately correct, we may state what is known of the secretions of the stomach.

The gastric secretion is clear, colorless, of low specific gravity (1001 to 1010), the solids being in great part made up of pep-

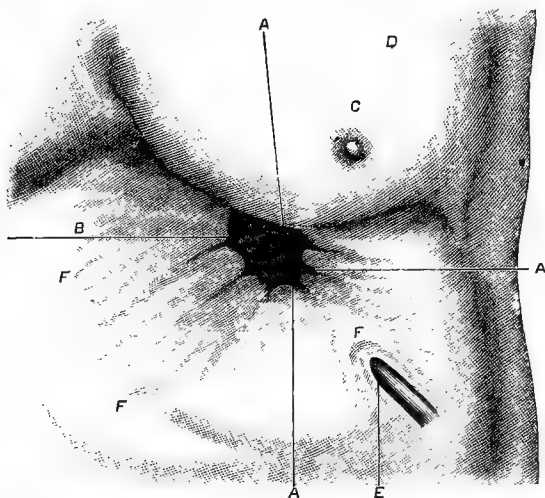

FIG. 267.—Gastric fistula in case of St. Martin (after Beaumont). *A, A, A, B*, borders of opening into stomach; *C*, left nipple; *D*, chest; *E*, cicatrices from wound made for removal of a piece of cartilage; *F, F, F*, cicatrices of original wound.

sin with a small quantity of mucus, which may become excessive in disordered conditions. There has been a good deal of dispute as to the acid found in the stomach during digestion. It is now generally agreed that during the greater part of the digestive process there is free hydrochloric acid to the extent of about 2 per cent. It is maintained that lactic acid exists normally in the early stages of digestion, and it is conceded that lactic, butyric, acetic, and other acids may be present in certain forms of disordered digestion.

It is also generally acknowledged that in mammals the work of the stomach is limited, so far as actual chemical changes go, to the conversion of the proteid constituents of food into peptone. Fats may be released from their proteid coverings (cells), but neither they nor starches are in the least altered chemically. Some have thought that in the dog there is a slight digestion of fats in the stomach. The solvent

power of the gastric juice is greater than can be accounted for by the presence of the acid it contains merely, and it has a marked antiseptic action.

Digestive processes may be conducted out of the body in a very simple manner, which the student may carry out for himself. To illustrate by the case of gastric digestion: The mucous membrane is to be removed from a pig's stomach after its surface has been washed clean, but not too thoroughly, chopped up fine, and divided into two parts. On one half pour water that shall contain .2 per cent hydrochloric acid (made by adding 4 to 6 cc. commercial acid to 1,000 cc. water). This will extract the pepsin, and may be used as the menstruum in which the substance to be digested is placed. The best is fresh fibrin whipped from blood recently shed.

Since the fluid thus prepared will contain traces of peptone from the digestion of the mucous membrane, it is in some respects better to use a glycerine extract of the same. This is made by adding some of the best glycerine to the chopped-up mucous membrane of the stomach of a pig, etc., well dried with bibulous paper, letting the whole stand for eight to ten days, filtering through cotton, and then through coarse filter-paper. It will be nearly colorless, clear, and powerful, a few drops sufficing for the work of digesting a little fibrin when added to some two per cent hydrochloric acid.

Digestion goes on best at about 40° C., but will proceed in the cold if the tube in which the materials have been placed is frequently shaken. It is best to place the test-tube containing them in a beaker of water kept at about blood-heat. Soon the fibrin begins to swell and also to melt away.

After fifteen to twenty minutes, if a little of the fluid in the tube be removed and filtered, and to the filtrate added carefully to neutralization dilute alkali, a precipitate, insoluble in water but soluble in excess of alkali (or acid), is thrown down. This is in most respects like acid-albumen, but has been called para-peptone. The longer digestion proceeds, the less is there of this and the more of another substance, peptone, so that the former is to be regarded as an intermediate product. Peptone is distinguished from albuminous bodies or proteids by—1. Not being coagulable from its aqueous solutions on boiling. 2. Diffusing more readily through animal membranes. 3. Not being precipitated by a number of reagents that usually act on proteids.

In artificial digestion it is noticeable that much more fibrin

or other proteid matter will be dissolved if it be finely divided and frequently shaken up, so that a greater surface is exposed to the digestive fluid.

The exact nature of the process by which proteid is changed to peptone is not certainly known.

Since starch on the addition of water becomes sugar ($C_6H_{10}O_5 + H_2O = C_6H_{12}O_6$), and since peptones have been formed through the action of dilute acid at a high temperature or by superheated water alone, it is possible that the digestion of both starch and proteids may be a *hydration*; but we do not know that it is such.

As already explained, milk is curdled by an extract of the stomach (rennet); and this can take place in the absence of all acids or anything else that might be suspected except the real cause; there seems to be no doubt that there is a distinct ferment which produces the coagulation of milk which results from the precipitation of its casein.

The activity of the gastric juice, and all extracts of the mucous membrane of the stomach, on proteids, is due to *pepsin*, a nitrogenous body, but not a proteid.

Like other ferments, the conditions under which it is effective are well defined. It will not act in an alkaline medium at all, and if kept long in such it is destroyed. In a neutral medium its power is suspended but not destroyed. Digestion will go on, though less perfectly, in the presence of certain other acids than hydrochloric. As with all digestive ferments, the activity of pepsin is wholly destroyed by boiling.

When a large quantity of cane-sugar is taken into the stomach, an excess of mucus is poured out which converts it, presumably by means of a special ferment, into dextrose.

Bile.—The composition of human bile is stated in the following table:

Water.....	82-90 per cent.
Bile-salts.....	6.11 “ “
Fats and soaps.....	2 “ “
Cholesterin.....	0.4 “ “
Lecithin.....	1.5 “ “
Mucin.....	1.3 “ “
Ash.....	0.61 “ “

The color of the bile of man is a rich golden yellow. When it contains much mucus, as is the case when it remains long in the gall-bladder, it is ropy, though usually clear. Bile may contain small quantities of iron, manganese, and copper, the

latter two especially being absent from all other fluids of the body. Sodium chloride is the most abundant salt. Bile must be regarded as an excretion as well as a secretion; the pigments, copper, manganese, and perhaps the iron and the cholesterin being of little or no use in the digestive processes, so far as known.

The *bile-salts* are the essential constituents of bile as a digestive fluid. In man and many other animals, they consist of taurocholate and glycocholate of sodium, and may be obtained in bundles of needle-shaped crystals radiating from a common center. These salts are soluble in water and alcohol, with an alkaline reaction, but insoluble in ether.

Glycocholic acid may be resolved into cholalic (cholic) acid and glycin (glycocoll); and taurocholic acid into cholalic acid and taurin. Thus:

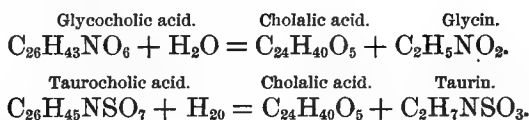

Glycocoll (glycin) is amido-acetic acid—

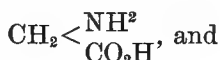

Taurin, amido-isethionic acid,

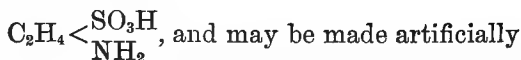

from isethionic acid.

It is to be noted that the bile acids both contain nitrogen, but that cholalic acid does not. The decomposition of the bile acids takes place in the alimentary canal, and the glycin and taurin are restored to the blood, and are possibly used afresh in the construction of the bile acids, though this is not definitely known.

Bile-Pigments.—The yellowish-red color of the bile is owing to *Bilirubin* ($\text{C}_{18}\text{H}_{18}\text{N}_2\text{O}_8$), which may be separated either as an amorphous yellow powder or in tablets and prisms. It is soluble in chloroform, insoluble in water, and but partially soluble in alcohol and ether. It makes up a large part of gall-stones, which contain, besides cholesterin, earthy salts in abundance.

It may be oxidized to *Biliverdin* ($\text{C}_{16}\text{H}_{16}\text{N}_2\text{O}_4$), the natural green pigment of the bile of the herbivora. When a drop of nitric acid, containing nitrous acid, is added to bile, it under-

goes a series of color changes in a certain tolerably constant order, becoming green, greenish-blue, blue, violet, a brick red, and finally yellow; though the green is the most characteristic and permanent. Each one of these represents a distinct stage of the oxidation of bilirubin, the green answering to biliverdin. Such is Gmelin's test for bile-pigments, by which they may be detected in urine or other fluids. The absence of proteids in bile is to be noted.

The Digestive Action of Bile.—1. So far as known, its action on proteids is *nil*. When bile is added to the products of an artificial gastric digestion, bile-salts, peptone, pepsin, and para-peptone are precipitated and redissolved by excess. 2. It is slightly solvent of fats, though an emulsion made with bile is very feeble. But it is likely helpful to pancreatic juice, or more efficient itself when the latter is present. With free fatty acids it forms soaps, which themselves help in emulsifying fat. 3. Membranes wet with bile allow fats to pass more readily; hence it is inferred that bile assists in absorption. 4. When bile is not poured out into the alimentary canal the fæces become clay-colored and ill-smelling, foul gases being secreted in abundance, so that it would seem that bile exercises an anti-septic influence. It may limit the quantity of *indol* formed. It is to be understood that these various properties of bile are to be traced almost entirely to its salts; though its alkaline reaction is favorable to digestion in the intestines, apart from its helpfulness in soap-forming, etc. 5. It is thought by some that the bile acts as a stimulant to the intestinal tract, giving rise to peristaltic movements, and also, mechanically, as a lubricant of the fæces. In the opinion of many, an excess of bile naturally poured out causes diarrhœa, and it is well known that bile given by the mouth acts as a purgative. However, we must distinguish between the action of an excess and that of the quantity secreted by a healthy individual. The acid of the stomach has probably no effect allied to that produced by giving acids medicinally, which warns us that too much must not be made out of the argument from bilious diarrhœa. 6. As before intimated, a great part of the bile must be regarded as excrementitious. It looks as though much of the effete hæmoglobin of the blood and of the cholesterin, which represents possibly some of the waste of nervous metabolism, were expelled from the body by the bile. The cholalic acid of the fæces is derived from the decomposition of the bile acids. Part of their mucus must also be referred to the bile, the quantity originally

present in this fluid depending much on the length of its stay in the gall-bladder, which secretes this substance. 7. There is throughout the entire alimentary tract a secretion of mucus which must altogether amount to a large quantity, and it has been suggested that this has other than lubricating or such like functions. It appears that mucus may be resolved into a proteid and an animal gum, which latter, it is maintained, like vegetable gums, assists emulsification of fats. If this be true, and the bile is, as has been asserted, possessed of the power to break up this mucus (mucin), its emulsifying effect in the intestine may indirectly be considerable. Bile certainly seems to intensify the emulsifying power of the pancreatic juice.

There does not seem to be any ferment in bile, unless the power to change starch into sugar, peculiar to this secretion in some animals, is owing to such.

Comparative.—The bile of the carnivora and omnivora is yellowish-red in color; that of herbivora green. The former contains taurocholate salts almost exclusively; in herbivorous animals and man there is a mixture of the salts of both acids, though the glycocholate predominates.

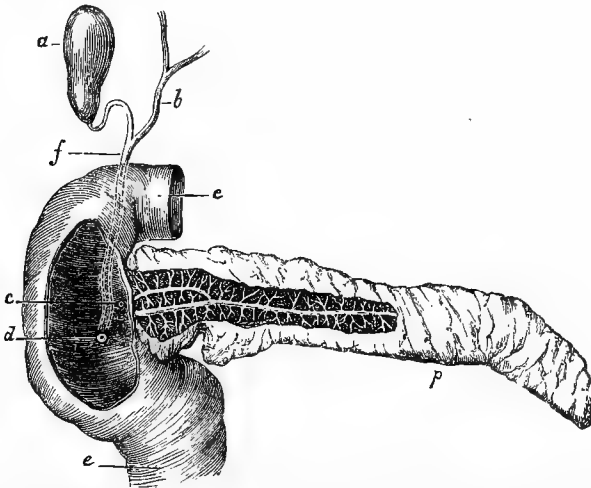

FIG. 268.—Gall-bladder, ductus choledochus and pancreas (after Le Bon). *a*, gall-bladder; *b*, hepatic duct; *c*, opening of second duct of pancreas; *d*, opening of main pancreatic duct and bile-duct; *e*, *e*, duodenum; *f*, ductus choledochus; *p*, pancreas.

Pancreatic Juice.—This fluid is found to vary a good deal quantitatively, according as it is obtained from a temporary (freshly made) or permanent fistula—a fact which emphasizes

the necessity for caution in drawing conclusions about the digestive juices as obtained by our present methods.

The freshest juice obtainable through a recent fistulous opening in the pancreatic duct is clear, colorless, viscid, alkaline in reaction, and with a very variable quantity of solids (two to ten per cent), less than one per cent being inorganic matter.

Among the organic constituents the principal are albumin, alkali-albumin, peptone, leucin, tyrosin, fats, and soaps in small amount. The alkalinity of the juice is owing chiefly to sodium

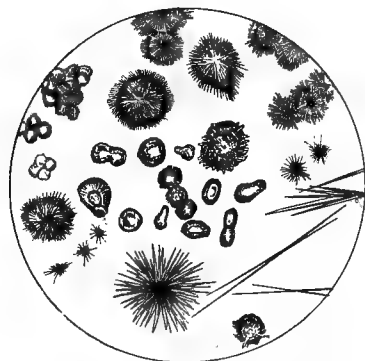

FIG. 269.—Crystals of leucin (Funke).

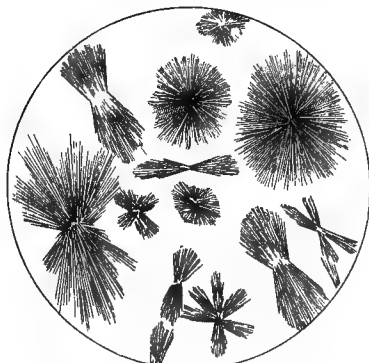

FIG. 270.—Crystals of tyrosin (Funke).

carbonates, which seem to be associated with some proteid body. There is little doubt that leucin, tyrosin, and peptone arise from digestion of the proteids of the juice by its own action.

Experimental.—If the pancreatic gland be mostly freed from adhering fat, cut up, and washed so as to get rid of blood; then minced as fine as possible, and allowed to stand in one-per-cent sodium-carbonate solution at a temperature of 40° C., the following results may be noted: 1. After a variable time the reaction may change to acid, owing to free fatty acid from the decomposition (digestion) of neutral fats. 2. Alkali-albumin, or a body closely resembling it, may be detected and separated by neutralization. 3. *Peptone* may be detected by the use of a trace of copper sulphate added to a few drops of caustic alkali, which becomes red if this body be present. 4. After a few hours the smell becomes fæcal, owing in part to *indol*, which gives a violet color with chlorine-water; while under the microscope the digesting mass may be seen to be swarming

with bacteria. 5. When digestion has proceeded for some time, *leucin* and *tyrosin* may be shown to be present, though their satisfactory separation in crystalline form involves somewhat elaborate details. These changes are owing to self-digestion of the gland.

All the properties of this secretion may be demonstrated more satisfactorily by making an aqueous or, better, glycerine extract of the pancreas of an ox, pig, etc., and carrying on artificial digestion, as in the case of a peptic digestion, with fibrin. In the case of the digestion of fat, the emulsifying power of a watery extract of the gland may be shown by shaking up a little melted hog's lard, olive-oil (each quite fresh, so as to show no acid reaction), or soap. Kept under proper conditions, free acid, the result of decomposition of the neutral fats or soap into free acid, etc., may be easily shown. The emulsion, though allowed to stand long, persists, a fact which is availed of to produce more palatable and easily assimilated preparations of cod-liver oil, etc., for medicinal use.

Starch is also converted into sugar with great ease. In short, the digestive juice of the pancreas is the most complex and complete in its action of the whole series. It is amyolytic, proteolytic, and steaptic, and these powers have been attributed to three distinct ferments—*amyllopsin*, *trypsin*, and *steapsin*.

Proteid digestion is carried further than by the gastric juice, and the quantity of crystalline nitrogenous products formed is in inverse proportion to the amount of peptone, from which it seems just to infer that part of the original peptone has been converted into these bodies, which are found to be abundant or not in an artificial digestion, according to the length of time it has lasted—the longer it has been under way the more leucin and tyrosin present. Leucin is another compound into which the amido (NH_2) group enters to make amido-caproic acid—one of the fatty series—while tyrosin is a very complex member of the aromatic series of compounds. Thus complicated are the chemical effects of the digestive juices; and it seems highly probable that these are only some of the compounds into which the proteid is broken up.

These crystalline bodies may be made artificially by the long-continued action under heat of acids and alkalies, in proteid or gelatinous matter, though it can not be said that these facts have as yet thrown much light upon their formation in the digestive organs.

Though putrefactive changes with formation of *indol*, etc.,

occur in pancreatic digestion, both within and without the body, they are to be regarded as accidental, for by proper precautions digestion may be carried on in the laboratory without their occurrence, and they vary in degree with the animal, the individual, the food, and other conditions. It is not, however,



FIG. 271.—Micro-organisms of large intestine (after Landois). 1, bacterium coli commune; 2, bacterium lactis aërogenes; 3, 4, large bacilli of Bienstock, with partial endogenous spore-formation; 5, various stages of development of bacillus which causes fermentation of albumen.

to be inferred that micro-organisms serve no useful purpose in the alimentary canal; the subject, in fact, requires further investigation.

Succus Entericus.—The difficulties of collecting the secretions of Lieberkühn's, Brünner's, and other intestinal glands will be at once apparent. But by dividing the intestine in two places, so as to isolate a loop of the gut, joining the sundered ends by ligatures, thus making the continuity of the main gut as complete as before, closing one end of the isolated loop, and bringing the other to the exterior, as a fistulous opening, the secretions could be collected, food introduced, etc.

But it seems highly improbable that information approximately correct at best, and possibly highly misleading, could be obtained in such manner. Moreover, the greatest diversity of opinion prevails as to the facts themselves, so that it seems scarcely worth while to state the contradictory conclusions arrived at.

It is, however, on the face of it, probable that the intestine—even the large intestine—does secrete juices, that in herbivora, at all events, play no unimportant part in the digestion of their bulky food; and it is also probable, as in so many other instances, that, when the other parts of the digestive tract fail, when the usual secretions are not prepared or do not act on the food, glands that normally play a possibly insignificant part may function excessively—we may almost say vicariously—and that such glands must be sought in the small intestine. There are facts in clinical medicine that seem to

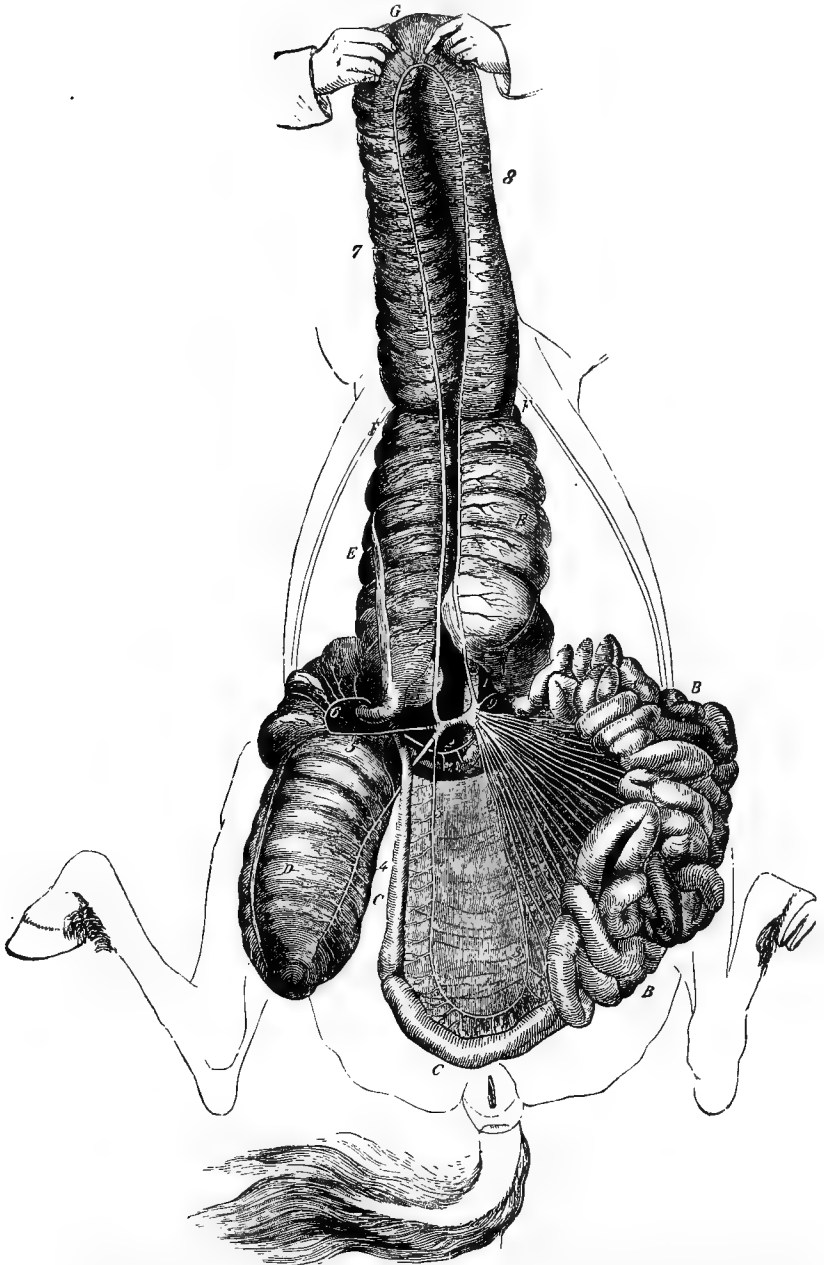

FIG. 272.—General view of horse's intestines; animal is placed on its back, and intestinal mass spread out (after Chauveau). *A*, duodenum as it passes behind great mesenteric artery; *B*, free portion of small intestine; *C*, ileocæcal portion; *D*, cæcum; *E*, *F*, *G*, loop formed by large colon; *G*, pelvic flexure; *F*, *F*, point where colic loop is doubled to constitute suprasternal and diaphragmatic flexures.

point strongly in this direction, though the subject has not yet been reduced to scientific form.

Comparative.—Within the last few years the study of vegetable assimilation from the comparative aspect has been fruitful in results which, together with many other facts of vegetable metabolism, show that even plants ranking high in the organic plane are not in many of their functions so different from animals as has been supposed. It has been known for a longer period that certain plants are carnivorous; but it was somewhat of a surprise to find, as has been done within the past few years, that digestive ferments are widely distributed in the vegetable kingdom and are found in many different parts of plants. What purpose they may serve in the vegetable economy is as yet not well known. At present it would seem as though, from their presence in so many cases in the seed, they might have something to do with changing the cruder forms of nutriment into such as are better adapted for the nourishment of the embryo.

Thus far, then, not only diastase but pepsin, a body with action similar to trypsin, and a rennet ferment, rank among the vegetable ferments best known.

A ferment has been extracted from the stem, leaves, and unripe fruit of *Carica papaya*, found in the East and West Indies and elsewhere, which has a marked proteolytic action.

It is effective in a neutral, most so in an alkaline medium; and, though its action is suspended in a feeble acid menstruum, it does not appear to be destroyed under such circumstances, as is trypsin. This body is attracting a good deal of attention, and its use has been recently introduced into medical practice.

Very lately also a vegetable rennet has been found in several species of plants. The subject is highly promising and suggestive.

SECRETION AS A PHYSIOLOGICAL PROCESS.

Secretion of the Salivary Glands.—We shall treat this subject at more length because of the light it throws on the nervous phenomena of vital process; and, since the salivary glands have been studied more thoroughly and successfully than any other, they will receive greater attention.

The main facts, ascertained experimentally and otherwise, are the following:

Assuming that the student is familiar with the general ana-

tomical relations of the salivary glands in some mammal, we would further remind him that the submaxillary gland has a double nervous supply: 1. From the cervical sympathetic by branches passing to the gland along its arteries. 2. From the chorda tympani nerve, which after leaving the facial makes connection with the lingual, whence it proceeds to its destination.

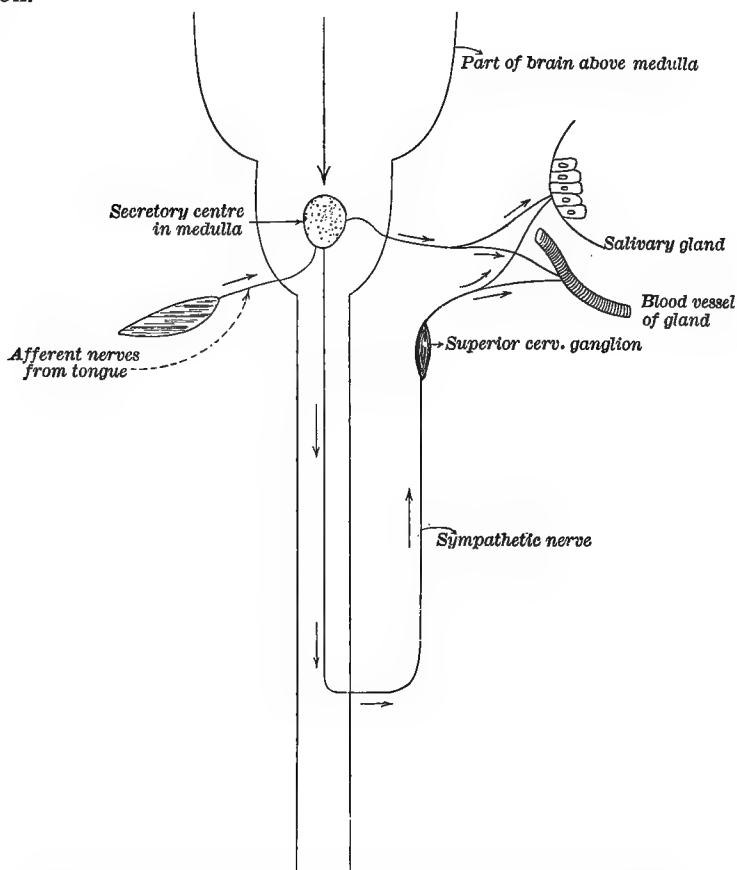

FIG. 273.—Diagram intended to indicate the nervous mechanism of salivary secretion.

The following facts are of importance as a basis for conclusions: 1. It is a matter of common observation that a flow of saliva may be excited by the smell, taste, sight, or even thought of food. 2. It is also a matter of experience that emotions, as fear, anxiety, etc., may parch the mouth—i. e., arrest the flow of saliva. The excited speaker thus suffers in his early efforts.

3. If a glass tube be placed in the duct of the gland and any substance that naturally causes a flow of saliva be placed on the tongue, saliva may be seen to rise rapidly in the tube. 4. The same may be observed if the lingual nerve, the glossopharyngeal, and many other nerves be stimulated; also if food be introduced into the stomach through a fistula. 5. If the peripheral end of the chorda tympani be stimulated, two results follow: (a) There is an abundant flow of saliva, and (b) the arterioles of the gland become dilated; the blood may pass through with such rapidity that the venous blood may be bright red in color and there may be a venous pulse. 7. Stimulation of the medulla oblongata gives rise to a flow of saliva, which is not possible when the nerves of the gland, especially the chorda tympani, are divided; nor can a flow be then excited by any sort of nervous stimulation, excepting that of the terminal branches of the nerves of the gland itself. 8. If the sympathetic nerves of the gland be divided, there is no immediate flow of saliva, though there may be some dilatation of its vessels. 9. Stimulation of the terminal ends of the sympathetic and chorda nerves causes a flow of saliva, differing as to total quantity and the amount of contained solids; but the nerve that produces the more abundant watery secretion, or the reverse, varies with the animal, e. g., in the cat chorda saliva is more viscid, in the dog less so; though in all animals as yet examined it seems that the secretion as a result of stimulation of the chorda tympani nerve is the more abundant; and in the case of stimulation of the chorda the vessels of the gland are dilated, while in the case of the sympathetic they are constricted. 10. If atropin be injected into the blood, it is impossible to induce salivary secretion by any form of stimulation, though excitation of the chorda nerve still causes arterial dilatation.

Conclusions.—1. There is a center in the medulla presiding over salivary secretion. 2. The influence of this center is rendered effective through the chorda tympani nerve at all events, if not also by the sympathetic. 3. The chorda tympani nerve contains both secretory and vaso-dilator fibers; the sympathetic secretory and vaso-constrictor fibers. 4. Arterial change is not essential to secretion, though doubtless it usually accompanies it. Secretion may be induced in the glands of an animal after decapitation by stimulation of its chorda tympani nerve, analogous to the secretion of sweat in the foot of a recently dead animal, under stimulation of the sciatic

nerve. 5. The character of the saliva secreted varies with the nerve stimulated, so that it seems likely that the nervous centers normally in the intact animal regulate the quality of the saliva through the degree to which one or the other kind of nerves is called into action. 6. Secretion of saliva may be induced reflexly by experiment, and such is probably the normal course of events. 7. The action of the medullary center may be inhibited by the cerebrum (emotions).

Some have located a center in the cerebral cortex (taste center), to which it is assumed impulses first travel from the tongue and which then rouses the proper secreting centers in the medulla into activity. It seems more likely that the cortical center, if there be one, completes the physiological processes by which taste sensations are elaborated.

From the influence of drugs (atropin and its antagonist pilocarpin) it is plain that the gland can be affected through the blood, though whether wholly by direct action on the center, on any local nervous mechanism or directly on the cells, is as yet undetermined. It is found that pilocarpin can act long after section of the nerves. This does not, however, prove that in the intact animal such is the usual *modus operandi* of this or other drugs, any more than the so-called paralytic secretion after the section of nerves proves that the latter are not concerned in secretion.

We look upon paralytic secretion as the work of the cells when gone wrong—passed from under the dominion of the nerve-centers. Secretion is a part of the natural life-processes of gland-cells—we may say a series in the long chain of processes which are indispensable for the health of these cells. They must be either secreting cells, or have no place in the natural order of things. It is to be especially noted that the secretion of saliva continues when the pressure in the ducts of the gland is greater than that of the blood in its vessels or even of the carotid; so that it seems possible that over-importance has been attached to blood-pressure in secretory processes generally.

It may, then, be safely assumed that formation of saliva results in consequence of the natural activity of certain cells, the processes of which are correlated and harmonized by the nervous system; their activity being accompanied by an abundant supply of blood. The actual outpouring of saliva depends usually on the establishment of a nervous reflex arc. The other glands have been less carefully studied, but the parotid is

known to have a double nervous supply from the cerebro-spinal and the sympathetic systems.

It would appear that, as the vaso-motor changes run parallel with the secretory ones, the vaso-motor and the proper secretory centers act in concert, as we have seen holds of the former and the respiratory center. But it is to our own mind very doubtful whether the doctrine of so sharp a demarkation of independent centers, prominently recognized in the physiology of the day, will be that ultimately accepted.

Secretion by the Stomach.—The mucous membrane of St. Martin's stomach was observed to be pale in the intervals of digestion, but flushed when secreting, which resembled sweating, so far as the flow of the fluid is concerned. When the man was irritated, the gastric membrane became pale, and secretion was lessened or arrested, and it is a common experience that emotions may help, hinder, or even render aberrant the digestive processes.

While the evidence is thus clear that gastric secretion is regulated by the nervous system, the way in which this is accomplished is very obscure. We know little of either the centers or nerves concerned, and what we do know helps but doubtfully to an understanding of the matter, if, indeed, it does not actually confuse and puzzle.

Digestion can proceed in a fashion after section of the nerves going to the stomach, though this has little force as an argument against nerve influence. We may conclude the subject by stating that, while the influence of the nervous system over gastric secretion is undoubted as a fact, the method is not understood; and the same remark applies to the secreting activity of the liver and pancreas.

The Secretion of Bile and Pancreatic Juice.—When the contents of the stomach have reached the orifice of the discharging bile-duct, a large flow of the biliary secretion takes place, probably as the result of the emptying of the gall-bladder by the contraction of its walls and those of its ducts. This is probably a reflex act, and the augmented flow of bile when digestion is proceeding is also to be traced chiefly to nervous influences reaching the gland, though by what nerves or under the government of what part of the nervous centers is unknown. Very similar statements apply to the secretion of the pancreatic glands, though this is not constant, as in the case of bile—at all events, in most animals.

It is known that after food has been taken there is a sudden

increase in the quantity of bile secreted, followed by a sudden diminution, then a more gradual rise, with a subsequent fall. Almost the same holds for the pancreas.

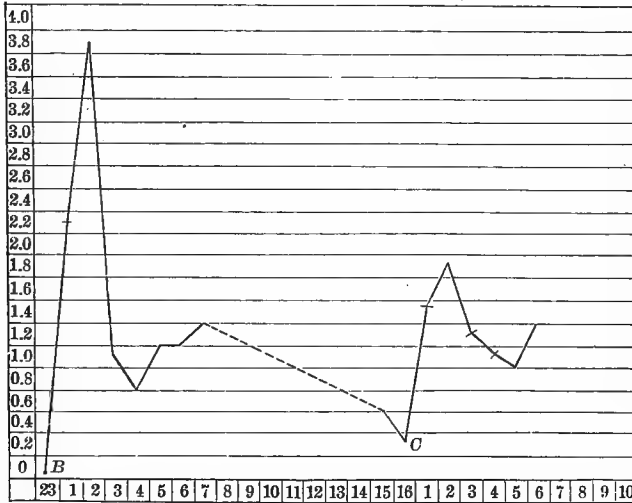

FIG. 274.—Diagram to show influence of food in secretion of pancreatic juice (after N. O. Bernstein). The abscissæ represent hours after taking food; ordinates amount in cubic centigrammes of secretion in ten minutes. Food was taken at B and C. This diagram very nearly also represents the secretion of bile.

It seems impossible to explain these facts, especially the first rapid discharge of fluid apart from the direct influence of the nervous system.

Upon the whole, the evidence seems to show that the pressure in the bile-ducts is greater than in the veins that unite to make up the portal system; but there are difficulties in the investigation of such and kindred subjects as regards the liver, owing to its peculiar vascular supply. It will be borne in mind that the liver in mammals consists of a mass of blood-vessels, between the meshes of which are packed innumerable cells, and that around the latter meander the bile capillaries; that the portal vein breaks up into the interlobular, from which capillaries arise, that terminate in the central intralobular veins, which make up the hepatic veinlets or terminate in these vessels. But the structure is complicated by the branches of the hepatic artery, which, as arterioles and capillaries, enters to some extent into the formation of the lobular vessels. It is remarkable that the cells of the liver are so similar, considering the complicated functions they appear to discharge.

A question of interest, though difficult to answer, is the extent to which the various constituents of bile are manufactured in the liver. Taurin, for example, is present in some of

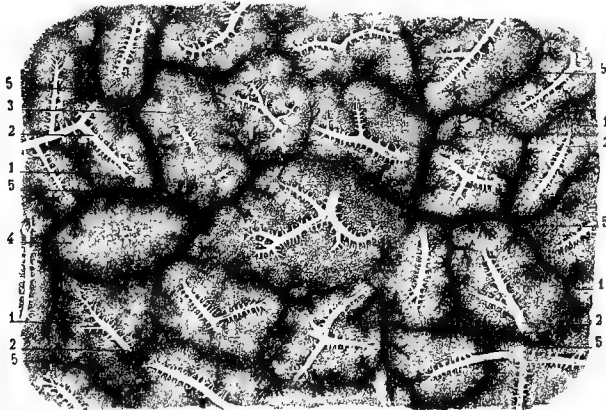

FIG. 275.—Lobules of liver, interlobular vessels, and intralobular veins (Sappey). 1, 1, 1, 1, 3, 4, lobules; 2, 2, 2, 2, intralobular veins injected with white; 5, 5, 5, 5, 5, intralobular vessels filled with a dark injection.

the tissues, but whether this is used in the manufacture of taurocholic acid or whether the latter is made entirely anew, and possibly by a method in which taurin never appears as such, is an open question. It is highly probable that a portion of the bile poured into the intestine is absorbed either as such or after partial decomposition, the products to be used in some way in the economy and presumably in the construction of bile by the liver. There are many facts, including some pathological phenomena, that point clearly to the formation of the pigments of bile from hæmoglobin in some of its stages of degeneration.

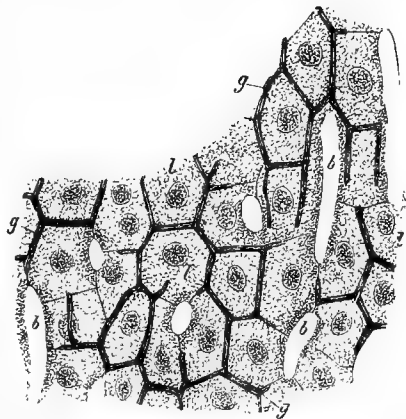

FIG. 276.—Portion of transverse section of hepatic lobule of rabbit; magnified 400 diameters (Kölliker). *b, b, b*, capillary blood-vessels; *g, g, g*, capillary bile-ducts; *l, l, l*, liver-cells.

Pathological.—When the liver fails to act either from de-

rangement of its cells primarily or owing to obstruction to the outflow of bile leading to reabsorption by the liver, bile acids and bile pigments appear in the urine or may stain the tissues, indicating their presence in excess in the blood.

This action of one gland (kidneys) for another is highly suggestive, and especially important to bear in mind in medical practice, both in treatment and prognosis. The chances of recovery when only one excreting gland is diseased are much greater evidently than when several are involved. Such facts as we have cited show, moreover, that there are certain common fundamental principles underlying secretion everywhere—a statement which will be soon more fully illustrated.

THE NATURE OF THE ACT OF SECRETION.

We are now about to consider some investigations, more particularly their results, which are of extraordinary interest.

The secreting cells of the salivary, the pancreatic glands, and the stomach have been studied by a combination of histological and, more strictly, physiological methods, to which we shall now refer. Specimens of these glands, both before and after prolonged secretion, under stimulation of these nerves, were hardened, stained, and sections prepared. As was to be expected, the results were not entirely satisfactory under these methods; however, the pancreas of a living rabbit has been viewed with the microscope in its natural condition; and by this plan, especially when supplemented by the more involved and artificial method first referred to, results have been reached

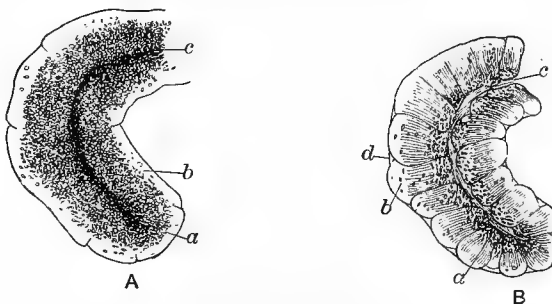

FIG. 277.—Portion of pancreas of rabbit (after Kühne and Lea). A represents gland at rest; B, during secretion.

which may be ranked among the greatest triumphs of modern physiology.

Some of these we now proceed to state briefly. To begin with the pancreas, it has been shown that, when the gland is not secreting—i. e., not discharging its prepared fluid—or during the so-called resting stage, the appearances are strikingly different from what they are during activity. The cell presents during rest an inner granular zone and an outer clearer zone, which stains more readily, and is relatively small in size. The lumen of the alveolus is almost obliterated, and the individual cells very indistinct. After a period of secreting activity, the lumen is easily perceived, the granules have disappeared in great part, the cells as a whole are smaller, and have a clear appearance throughout. Coincident with the changes in the gland's cells it is to be noticed that more blood passes through it, owing to dilatation of the arterioles.

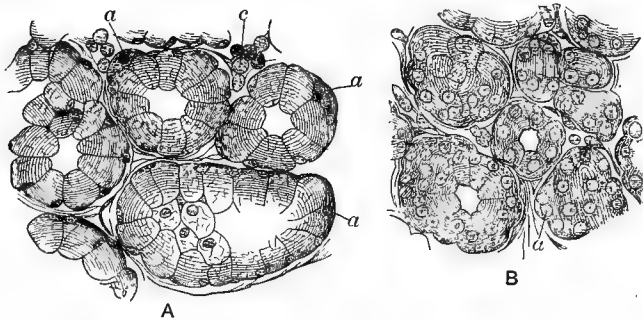

FIG. 278.—Section of mucous gland (after Lavdowsky). In A, gland at rest; in B, after secreting for some time.

Again, the course of the changes in the salivary glands, whether of the mucous or serous variety, is very similar. In the mucous gland in the resting stage the cells are large, and hold much clear matter in the interspaces of the cell network; and, as this does not stain readily, it can not be ordinary protoplasm. This, when the gland is stimulated through its nerves, disappears, leaving the containing cells smaller. It has become *mucin*, and may itself be called *mucinogen*.

It is to be noted that, as the cells become more protoplasmic, less burdened with the products of their activity, the nucleus becomes more prominent, suggestive of its having a probable directive influence over these manufacturing processes.

Substantially the same chain of events has been established for the serous salivary glands and the stomach, so that we may safely generalize upon these well-established facts.

It seems clear that a series of changes constructive and, from one point of view, destructive, following the former are con-

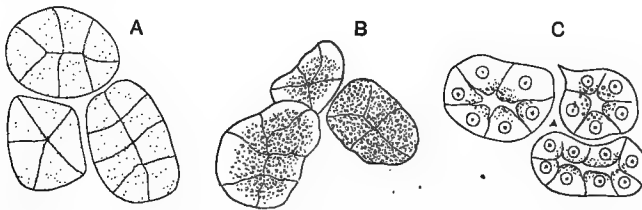

FIG. 279.—Changes in parotid (serous) gland during secretion (after Langley). A, during rest; B, after moderate, C, after prolonged stimulation. Figures partly diagrammatic.

stantly going on in the glands of the digestive organs. Protoplasm under nerve influence constructs a certain substance, which is an antecedent of the final product, which we term a ferment. It is now customary to speak of these changes as constructive (anabolic) and destructive (katabolic), though we have already pointed out (page 270) that this view is, at best, only one way of looking at the matter, and we doubt if it may not be cramping and misleading.

We must also urge caution in regard to the conception to be associated with the use of the terms “resting” and “active” stage. It is not to be forgotten that strictly in living cells there is no absolute rest—such means death; but, if these terms be understood as denoting but degrees of activity, they need not mislead. It is also more than probable that in certain of the glands, or in some animals, the processes go on simultaneously: the protoplasm being renewed, the *zymogen*, or mother-ferment, being formed, and the latter converted into actual ferment, all at the same time.

It has been pointed out that *chorda saliva* is usually more watery than that secreted under stimulation of the sympathetic. When atropine is injected there is no discharge whatever, notwithstanding that the usual vascular dilatation follows, from which it is clear that the water is actually secreted.

The nature of secretion is now tolerably clear as a whole; though it is to be remembered that this account is but general, and that there are many minor differences for each gland and variations that can scarcely be denominated minor for different animals. Evidently no theory of filtration, no process depending solely on blood-pressure, will apply here. And if in this, the best-studied case, mechanical theories of vital processes utterly fail, why attempt to fasten them upon other glands, as

the kidneys and the lungs, or, indeed, apply such crude conceptions to the subtle processes of living protoplasm anywhere or in any form?

It is somewhat remarkable that an extract of a perfectly fresh pancreas is not proteolytic; yet the gland yields such an extract when it has stood some hours or been treated with a weak acid. These facts, together with the microscopic appearances, suggested that there is formed a forerunner to the actual ferment—a *zymogen*, or mother-ferment, which at the moment of discharge of the completed secretion is converted into the actual ferment. We might, therefore, speak of a pepsinogen, typsinogen, etc., and, though there may be a cessation in the series of processes, and no doubt there is in some animals, this may not be the case in all or in all glands.

Secretion by the Stomach.—The glands of the stomach differ in most animals in the cardiac and pyloric regions. In those of the former zone, both central, columnar, and parietal (ovoid) cells are to be recognized. It was thought that possibly the latter were concerned in the secretion of the acid of the stomach, but this is by no means certain. Possibly these, like the demilune cells of the pancreas, may be the progenitors of the central (chief) cells. The latter certainly secrete pepsin, and probably also rennet. Mucus is secreted by the cells lining the neck of glands and covering the mucous membrane intervening between their mouths. The production of hydrochloric acid by any act of secretion is not believed in by all writers, some holding that it is derived from decomposition of sodium chloride, possibly by lactic acid. So simple an origin is not probable, not being in keeping with what we know of chemical processes within the animal body.

Self-Digestion of the Digestive Organs.—It has been found, both in man and other mammals, that when death follows in a healthy subject while gastric digestion is in active progress and the body is kept warm, a part of the stomach itself and often adjacent organs are digested, and the question is constantly being raised, Why does not the stomach digest itself during life? To this it has been answered that the gastric juice is constantly being neutralized by the alkaline blood; and, again, that the very vitality of a tissue gives it the necessary resisting powers, a view contradicted by an experiment which is conclusive. If the legs of a living frog be allowed to hang against the inner walls of the stomach of a mammal when gastric digestion is going on, they will be digested.

The first view (the alkalinity of the blood) would not suffice to explain why the pancreas, the secretion of which acts best in an alkaline medium, should not be digested.

It seems to us there is a good deal of misconception about the facts of the case. Observation on St. Martin shows that the secretion of gastric juice runs parallel with the need of it, as dependent on the introduction of food, its quantity, quality, etc. Now, there can be little doubt that, if the stomach were abundantly bathed when empty with a large quantity of its own acid secretion, it would suffer to some extent at least. But this is never the case; the juice is carried off and mixed with the food. This food is in constant motion and doubtless the inner portions of the cells, which may be regarded as the discharging region, while the outer (next the blood capillaries, the chief manufacturing region of the digestive ferment) are frequently renewed.

Such considerations, though they seem to have been somewhat left out of the case, do not go to the bottom of the matter. Amœba and kindred organisms do not digest themselves. Some believe that the little pulsatile vacuoles of the Infusorians are a sort of temporary digestive cavities.

But, to one who sees in the light of evolution, it must be clear that a structure could not have been evolved that would be self-destructive.

The difficulty here is that which lies at the very basis of all life. We might ask, Why do living things live, since they are constantly threatened with destruction from within as from without? Why do not the liver, kidney, and other glands that secrete noxious substances, poison themselves? We can not in detail explain these things; but we wish to make it clear that the difficulty as regards the stomach is not peculiar to that gland, and that even from the ordinary point of view it has been exaggerated.

Comparative.—More careful examination of the stomachs of some mammals has revealed the fact that in several animals, in which the stomach appears to be simple, it is in reality compound. There are different grades, however, which may be regarded as transition forms between the true simple stomach and that highly compound form of the organ met with in the ruminants.

It has been shown recently that the stomach of the hog has an œsophageal dilatation; and that the entire organ may be divided into several zones with different kinds of glandular

epithelium, etc. These portions differ in digestive power, in the characteristics of the fluid secreted, and other details beyond those which a superficial examination of this organ would lead one to suspect.

The stomach of the horse represents a more advanced form of compound stomach than that of the hog, which is not evident, however, until its glandular structure is examined closely. The entire left portion of the stomach represents an oesophageal dilatation lined with an epithelium that closely resembles that of the oesophagus, and with little if any digestive function. It thus appears that the stomach of the horse is in reality smaller, as a true digestive gland, than it seems, so that a great part of the work of digestion must be done in the intestine; though in this animal, if the food be retained long as it is in the hog, which is not, however, the general opinion as regards the stomach of the horse, salivary digestion may continue for a considerable period after the food has left the mouth. The secretion of mucus by the stomach in herbivora is abundant.

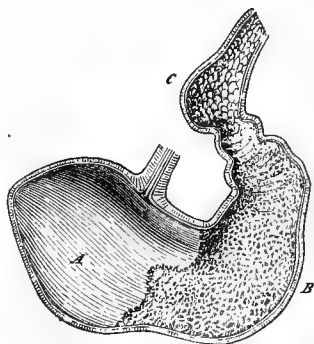

FIG. 280.—Interior of horse's stomach (after Chauveau). *A*, left sac; *B*, right sac; *C*, duodenal dilatation.

THE MOVEMENTS OF THE DIGESTIVE ORGANS.

As with other parts of the body, so in the alimentary tract, the slower kind of movement is carried out by plain muscular fibers; and the movements, as a whole, belong to the class known as peristaltic; in fact, it is only at the beginning of the digestive tract that voluntary (striped) muscle is to be found and to a limited extent in the part next to this—i. e., in the oesophagus.

Teeth in the highly organized mammal are remarkable in being to the least degree living structures of any in the entire animal, thus being in marked contrast to other organs. The enamel covering their exposed surfaces is the hardest of all the tissues and is necessarily of low vitality. We have already alluded to the difference in the teeth of different animals, and their relation to customary food and digestive functions. In fact, it is clear that the teeth and all the parts of the digestive

system are correlated to one another. The compound stomach of the ruminants, with its slow digestion of a bulky mass of food, which must be softened and thoroughly masticated before the digestive juices can attack it successfully, harmonizes with the powerful jaws, strong muscles of mastication, and grinding teeth; and all these in marked contrast with the teeth of a carnivorous animal with its simple but highly effective stomach. Compare figures in earlier pages.

Mastication in man is of that intermediate character befitting an omnivorous animal. The jaws have a lateral and forward-and-backward movement, as well as a vertical one, though the latter is predominant. The upper jaw is like a fixed millstone, against which the lower jaw works as a nether millstone. The elevation of the jaw is effected by the masseter, temporal, and internal pterygoid muscles; depressed by the mylohyoid and geniohyoid, though principally by the digastric. The jaw is advanced by the external pterygoids; unilateral contraction of these muscles also produces lateral movement of the inferior maxilla, which is retracted by the more horizontal fibers of the temporal.

The cheeks and tongue likewise take part in preparing the food for the work of the stomach, nor must the lips be overlooked even in man. The importance of these parts is well illustrated by the imperfect mastication, etc., when there is paralysis of the muscles of which they are formed. Even when there is loss of sensation only, the work of the mouth is done in a clumsy way, showing the importance of common sensation, as well as the muscular sense.

Nervous Supply.—The muscles of the tongue are governed by the hypoglossal nerve; the other muscles of mastication chiefly by the fifth. The afferent nerves are branches of the fifth and glosso-pharyngeal. It is, of course, important that the food should be rolled about and thoroughly mixed with saliva (insalivation).

Deglutition.—The transportation of the food from the mouth to the stomach involves a series of co-ordinated muscular acts of a complicated character, by which difficulties are overcome with marvelous success.

It will be remembered that the respiratory and digestive tracts are both developed from a common simple tube—a fact which makes the close anatomical relation between these two physiologically distinct systems intelligible; but it also involves difficulties and dangers. It is well known that a small quantity

of food or drink entering the windpipe produces a perfect storm of excitement in the respiratory system. The food, there-

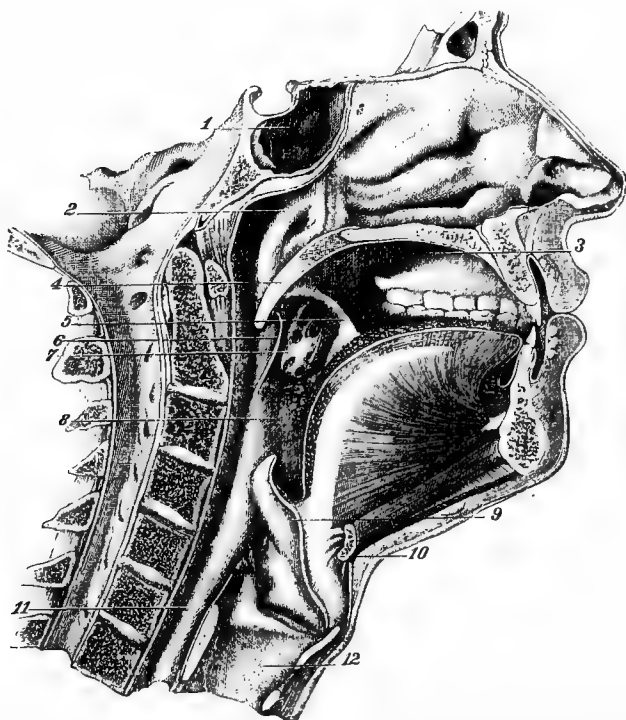

FIG. 281.—Cavities of mouth and pharynx, etc. (after Sappey). Section, in median line, of face and superior portion of neck, designed to show the mouth in its relations to the nasal fossæ, pharynx, and larynx: 1, sphenoidal sinuses; 2, internal orifice of Eustachian tube; 3, palatine arch; 4, velum pendulum palati; 5, anterior pillar of soft palate; 6, posterior pillar of soft palate; 7, tonsil; 8, lingual portion of cavity of pharynx; 9, epiglottis; 10, section of hyoid bone; 11, laryngeal portion of cavity of pharynx; 12, cavity of larynx.

fore, when it reaches the œsophagus, must be kept, on the one hand, from entering the nasal, and, on the other, the laryngeal openings. This is accomplished as follows: When the food has been gathered into a bolus on the back of the tongue, the tip of this organ is pressed against the hard palate, by which the mass is prevented from passing forward, and, at the same time, forced back into the pharynx, the soft palate being raised and the edges of the pillars of the fauces made to approach the uvula, which fills up the gap remaining, so that the posterior nares are closed and an inclined plane provided, over which the morsel glides. The after-result is said to depend on the size of the bolus. When considerable, the constrictors of the

pharynx seize it and press it on into the gullet; when the morsel is small or liquid is swallowed, it is rapidly propelled onward by the tongue, the œsophagus and pharynx being largely passive at the time, though contracting slowly afterward; at the same time the larynx as a whole is raised, the epiglottis pressed down, chiefly by the meeting of the tongue and itself, while its cushion lies over the *rima glottidis*, which is closed or all but closed by the action of the sphincter muscles of the larynx, so that the food passes over and by this avenue of life, not only closed but covered by the glottic lid. The latter is not so essential as might be supposed, for persons in whom it was absent have been known to swallow fairly well. The ascent of the larynx any one may feel for himself; and the behavior of the pharynx and larynx, especially the latter, may be viewed by the laryngoscope. The grip of the pharyngeal muscles and the œsophagus may be made clear by attaching a piece of food (meat) to a string and allowing it to be partially swallowed.

The upward movement of food under the action of the constrictors of the pharynx is anticipated by the closure of the passage by the palato-glossi of the anterior pillars of the fauces.

The circular muscular fibers of the gullet are probably the most important in squeezing on the food by a peristaltic movement, passing progressively over the whole tube, though the longitudinal also take part in swallowing, perhaps, by steadying the organ.

Swallowing will take place in an animal so long as the medulla oblongata remains intact; and the center seems to lie higher than that for respiration, as the latter act is possible when, from slicing away the medulla, the former is not. An-encephalous monsters lacking the cerebrum can swallow, suck, and breathe.

Food placed in the pharynx of animals when unconscious is swallowed, proving that volition is not essential to the act; but our own consciousness declares that the first stage, or the removal of the food from the mouth to the pharynx, is voluntary.

When we seem to swallow voluntarily there is in reality a stimulus applied to the fauces, in the absence of food and drink, either by the back of the tongue or by a little saliva.

It thus appears that deglutition is an act in the main reflex, though initiated by volition. The afferent nerves concerned are usually the glosso-pharyngeal, some branches of the fifth,

and of the vagus. The efferent nerves are those of the numerous muscles concerned.

When food has reached the gullet, it is, of course, no longer under the control of the will.

Section of the vagus or stimulation of this nerve modifies the action of the œsophagus, though it is known that contractions may be excited in the excised organ; but no doubt normally the movements of the gullet arise in response to natural nerve stimulation.

Comparative.—That swallowing is independent of gravity is evident from the fact that long-necked animals (horse, giraffe) can and do usually swallow with the head and neck down, so that the fluid is rolled up an inclined plane. The peristaltic nature of the contractions of the gullet can also be well seen in such animals. In the frog the gullet, as well as the mouth, is lined with ciliated epithelium, so that in a recently killed animal one may watch a slice of moistened cork disappear from the mouth, to be found shortly afterward in the stomach. The rate of the descent is surprising—in fact, the movement is plainly visible to the unaided eye.

The Movements of the Stomach.—The stomach of mammals, including man, is provided with three layers of muscular fibers: 1. External longitudinal, a continuation of those of the œsophagus. 2. Middle circular. 3. Internal oblique. The latter are

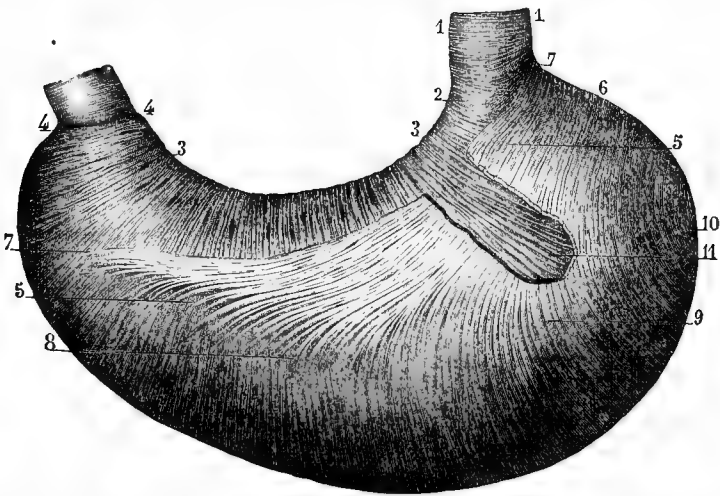

FIG. 282.—Human stomach (after Sappey). 1, œsophagus; 2, circular fibers at œsophageal opening; 3, 3, circular fibers at lesser curvature; 4, 4, circular fibers at the pylorus; 5, 5, 6, 7, 8, oblique fibers; 9, 10, fibers of this layer covering the greater pouch; 11, portion of stomach from which these fibers have been removed to show the subjacent circular fibers.

the least perfect, viewed as an investing coat. The pyloric end of the stomach is best supplied with muscles; where also there is a thick muscular ring or sphincter, as compared with which the cardiac sphincter is weak and ill-developed.

The movements of the stomach begin shortly after a meal has been taken, and, as shown by observations on St. Martin, continue for hours, not constantly, but periodically. The effect of the conjoint action of the different sets of muscular fibers is to move the food from the cardiac toward the pyloric end of the stomach, along the greater curvature and back by the lesser curvature, while there is also, probably, a series of in-and-out currents to and from the center of the food-mass. The quantity of food is constantly being lessened by the removal of digested portions, either by the blood-vessels of the organ or by its passing through the pyloric sphincter. The empty stomach is quiescent and contracted, its mucous membrane being thrown into folds.

The movements of the stomach may be regarded as reflex, the presence of food being an exciting cause, though probably not the only one; and so largely automatic is the central mechanism concerned, that but a feeble stimulus suffices to arouse them, especially at the accustomed time.

Of the paths of the impulses, either afferent or efferent, little is known. Certain effects follow section or stimulation of the vagi or splanchnics, but these can not be predicted with certainty, or the exact relation of events indicated.

It is said that the movements of the stomach cease, even when it is full, during sleep, from which it is argued that gastric movements do normally depend on the influence of the nervous system. However, the subject is too obscure at present for further discussion.

Comparative.—Recent investigations on the stomach of the pig indicate that in this animal the contents of the two ends of the stomach may long remain but little mingled; and such is certainly the case in this organ among ruminants.

Pathological.—Distention of the stomach, either from excess of food or gas arising from fermentative changes, or by secretion from the blood, may cause, by upward pressure on the diaphragm, etc., uneasiness from hampered respiration, and irregularity of the heart, possibly, also, in part traceable to the physical interference with its movements. After great and prolonged distention there may be weakened digestion for a considerable interval. It seems not improbable that this is to

be explained, not alone by the impaired elasticity (vitality) of the muscular tissue, but also by defective secreting power. It is not necessary to impress the lesson such facts convey.

The Intestinal Movements.—The circular fibers play a much more important part than the longitudinal, being, in fact, much more developed. It is also to be remembered that nerves in the form of plexuses (of Auerbach and Meissner) abound in its walls.

Normally the movement, slowly progressive, with occasional haltings, is from above downward, stopping at the ileo-cæcal valve; the movements of the large gut being apparently mostly independent.

Movements may be excited by external or internal stimulation, and may be regarded as reflex; in which, however, the tendency for the central cells to discharge themselves is so great (automatic) that only a feeble stimulus is required, the normal one being the presence of food.

It is noticeable in a recently killed animal, or in one in the last stages of asphyxia, that the intestines contract vigorously. Whether this is due to the action of blood overcharged with carbonic anhydride and deficient in oxygen on the centers presiding over the movements, on the nerves in the intestinal walls, or on the muscle-cells directly, is not wholly clear, but it is probable that all of these may enter into the result. The vagus nerve, when stimulated, gives rise to movements of the intestines, while the splanchnic seems to have the reverse effect; but the cerebrum itself has an influence over the movements of the gut, as is plain from the diarrhœa traceable to unusual fear or anxiety. There is little to add in regard to the movements of the large intestine. They are, no doubt, of considerable importance in animals in which it is extensive. Normally they begin at the ileo-cæcal valve.

Defecation.—The removal of the waste matter from the alimentary tract is a complicated process, in which both smooth and striped muscle, the spinal cord, and the brain take part.

Defecation may take place during the unconsciousness of sleep or of disease, and so be wholly independent of the will; but, as we well know, this is not usually the case. Against accidental discharge of fæces there is a provision in the sphincter ani, the tone of which is lost when the lower part of the spinal cord is destroyed. We are conscious of being able, by an effort of will, to prevent the relaxation of the sphincter or to increase its holding power, though the latter is probably almost

wholly due to the action of extrinsic muscles; at all events any one may convince himself that the latter may be made to take a great part in preventing fæcal discharge, though whether the tone of the sphincter can be increased or not by volition it is difficult to say.

What happens during an ordinary act of defecation is about as follows: After a long inspiration the glottis is closed; the diaphragm, which has descended, remains low, affording, with the obstructed laryngeal outlet, a firm basis of support for the action of the abdominal muscles, which, bearing on the intestine, forces on their contents, which, before the act has been called for, have been lodged mostly in the large intestine; at the same time the sphincter ani is relaxed and peristaltic movements accompany and in some instances precede the action of the abdominal muscles. The latter may contract vigorously on a full gut without success in the absence of the intestinal peristalsis, as too many cases of obstinate constipation bear witness.

Like deglutition, and unlike vomiting, there is usually both a voluntary and involuntary part to the act.

Though the will, through the cerebrum, can inhibit defecation, it is likely that it does so through the influence of the cerebrum on some center in the cord; for in a dog, the lumbar cord of which has been divided from the dorsal, the act is, like micturition, erection of the penis, and others which are under the control of the will, still possible, though, of course, performed entirely unconsciously.

Vomiting.—If we consult our own consciousness and observe to the best of our ability, supplementing information thus gained by observations on others and on the lower animals, it will become apparent that vomiting implies a series of co-ordinated movements, into which volition does not enter either necessarily or habitually. There is usually a preceding nausea, with a temporary flow of saliva to excess. The act is initiated by a deep inspiration, followed by closure of the glottis. Whether the glottis is closed during or prior to the entrance of air is a matter of disagreement. At all events, the diaphragm descends and remains fixed, the lower ribs being retracted. The abdominal muscles then acting against this support, force out the contents of the stomach, in which they are assisted by the essential relaxation of the cardiac sphincter, the shortening of the œsophagus by its longitudinal fibers, and the extension and straightening of the neck, together with the opening of the mouth.

As the expulsive effort takes place, it is accompanied by an expiratory act which tends to keep the egesta out of the larynx and carry them onward, though it may also contribute to overcome the resistance of the elevated soft palate, which serves to protect the nasal passages. The stomach and œsophagus are not wholly passive, though their part is not so important in the adult as might be inferred from observing vomiting in infants, the peristalsis of these organs apparently sufficing in them to empty the stomach.

Retching may be very violent and yet ineffectual when the cardiac sphincter is not fully relaxed. The pyloric outlet is usually closed, though in severe and long-continued vomiting bile is often ejected, which must have reached the stomach through the pylorus.

Comparative.—The ease with which some animals vomit in comparison with others is extraordinary, as in carnivora like our dogs and cats; a matter of importance to an animal accustomed in the wild state to eat entire carcasses of animals—hair, bones, etc., included.

The readiness with which an animal vomits depends in great part on the conformation and relations of the parts of its digestive tract.

The horse vomits with difficulty—its stomach and its cardiac opening being small and peculiar in shape (Figs. 261 and 280), while its œsophagus is long. The stomach of the human being during infantile life is less pouched than in the adult, which in part explains the ease with which infants vomit.

But the matter is complex; much depends on the proper co-ordinations being made, and, this being well or ill accomplished, accounts for the variations in the ease with which different persons vomit.

Pathological.—Vomiting may arise from the presence of renal or biliary calculi (reflex action); from disease of the cerebrum or the medulla; from obstruction in the pyloric region or in the intestines; from emotions; from revived unpleasant mental associations; from nauseous tastes, etc. It may be questionable whether some of these are properly termed “pathological.”

Pyrosis is due to the anti-peristaltic action of the stomach and œsophagus alone, so that it is a sort of partial vomiting and allied to the regurgitation of special secretions, as from the crops of pigeons, or of food from the stomachs of ruminants. We have known cases in which anti-peristalsis was confined to

the pharynx alone. Some persons seem to have acquired the power of regurgitating food and masticating it afresh.

The excessive vomiting following obstruction of the bowels is comparable to the unusual action of the heart, ureter, bladder, etc., when there is hindrance to the outflow. As we have already explained for the heart, we regard this as the resumption of a power of independent action seen in ancestral forms and marked when the nervous system is no longer exercising its usual control and direction. Not that this or similar behavior may not result from excessive stimulation, leading to unusual central nervous discharge, but it certainly does happen independently of the nervous system, and may be witnessed in the hearts of cold-blooded animals when all their nerves are divided.

Similarly, the habit of regurgitating the food is intelligible in the light of evolution. The fact that mammals are descended from lower forms in which unstriped muscle-cells go to form organs that have a rhythmically contractile function, renders it clear why this function may become, as in ruminants, specialized in certain parts of the digestive tract; why carnivora should vomit readily, and why human subjects should learn to regurgitate food. There is, so to speak, a latent inherited capacity which may be developed into actual function. Apart from this it is difficult to understand such cases at all.

The vomiting center is usually located in the medulla, and is represented as working in concert with the respiratory center. But when we consider that there is usually an increased flow of saliva and other phenomena involving additional central nervous influence, we see reason to believe in co-ordinated action implying the use of parts of the central nervous system not so closely connected anatomically as the respiratory and vomiting centers are assumed to be.

Indeed, as we before indicated, it does not seem probable that the doctrine of centers in its present form, especially with such precise limitations, both anatomically and physiologically, will continue to be maintained. We seem to have been overlooking the connection of parts while occupied with defining their limits. It is not, however, yet possible to substitute other explanations that shall be wholly satisfactory; and we make these remarks to keep the student expectant of progress, for, as a distinguished exponent of science has said, "When Science adopts a [rigid] creed, she commits suicide."

We do not know the part taken, if any, by the splanchnic

or other nerves of the sympathetic system; but, from the fact that discharge of the gastric contents is impossible when the vagi are cut, it is likely that the efferent impulses, determining the relaxation of the cardiac sphincter, descend by these nerves, while the chorda tympani is concerned, of course, in the secretion of saliva. But it will be clear, from the facts of the case, that many nerves, both afferent and efferent, are concerned; and it is more than likely that our explanations of the entire process are quite inadequate to unravel its real complexity.

Therapeutics.—The evidence from the use of drugs seems to emphasize the last statement. At all events, emetics act in a variety of ways, and differently in different animals.

THE REMOVAL OF DIGESTED PRODUCTS FROM THE ALIMENTARY CANAL.

The glands of the stomach are simply secretive, and all absorption from this organ is either by blood-vessels directly or by lymphatics; at least, such is the ordinary view of the subject—whether it is not too narrow a one remains to be seen.

It is important to remember that the intestinal mucous membrane is supplied not only with secreting glands but lymphatic tissue, in the form of the solitary and agminated glands (Peyer's patches) and thickly studded with villi, giving the small gut that velvety appearance appreciable even by the naked eye.

It will not be forgotten that the capillaries of the digestive organs terminate in the veins of the portal system, and that the blood from these parts is conducted through the liver before it reaches the general circulation.

The lymphatics of these organs form a part of the general lymphatic system of the body; but the peculiar way in which absorption is effected by villi, and the fact that the lymphatics of the intestine, etc., at one time (fasting) contain ordinary lymph and at another (after meals) the products of digestion, imparts to them a physiological character of their own.

Absorption will be the better understood if we treat now of lymph and chyle and the lymph vascular system, which were purposely postponed till the present; though its connection with the vascular system is as close and important as with the digestive organs.

The lymphatic system, as a whole, more closely resembles the venous than the arterial vessels. We may speak of lym-



FIG. 283.—Valves of lymphatics (Sappey).

phatic capillaries, which are, in essential points of structure, like the arterial capillaries; while the larger vessels may be compared to veins, though thinner, being provided with valves and having very numerous anastomoses. These lymphatic capillaries begin in spaces between the tissue-cells, from which they take up the effete lymph. It is interesting to note that there are also perivascular lymphatics, the existence of which again shows how close is the relation between the blood vascular and lymphatic systems, and as we would suppose, and as is actually found to be the case, between the contents of each.

Lymph and Chyle.—If one compares the mesentery in a kitten, when fasting, with the same part in an animal that was killed some hours after a full meal of milk, it may be seen that the formerly clear lines indicating the course of the lymphatics and ending in glands have in the latter case become whitish (hence their name, *lacteals*), owing to the absorption of the emulsified fat of the milk.

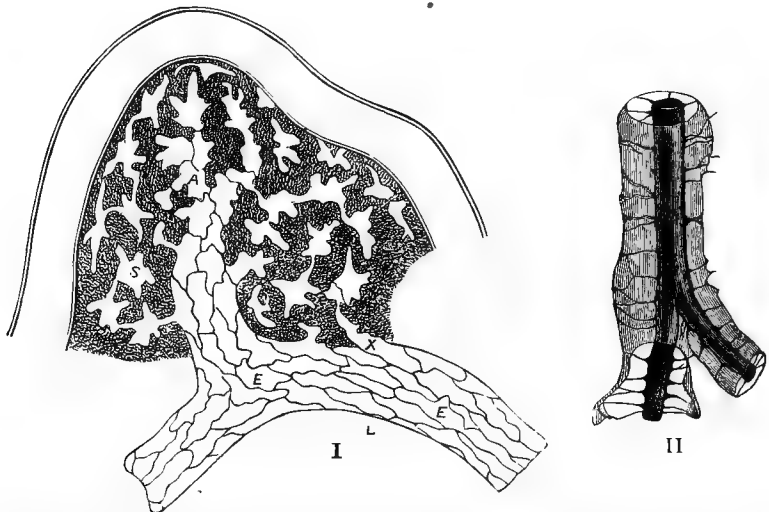

FIG. 284.—Origin of lymphatics (after Landois). I. From central tendon of diaphragm of rabbit (semi-diagrammatic); *s*, lymph-canals communicating by *X* with lymphatic vessel *L*; *A*, origin of lymphatic by union of lymph-canals; *E, E*, endothelium. II. Perivascular canal.

Microscopic examination shows the chyle to contain (when coagulated) fibrin, many leucocytes, a few developing red corpuscles, an abundance of fat in the form both of very minute oil-globules and particles smaller still.

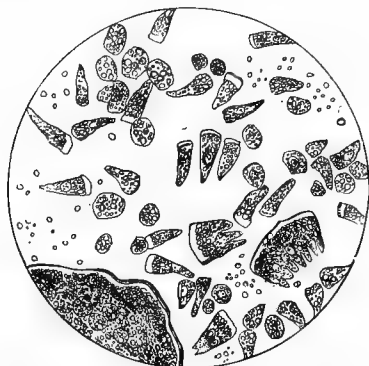

FIG. 285.—Epithelium from duodenum of rabbit, two hours after having been fed with melted butter (Funke).



FIG. 286.—Villi filled with fat, from small intestine of an executed criminal, one hour after death (Funke).

There are also present fatty acids, soaps small in quantity as compared with the neutral fats, also a little cholesterin and lecithin. But chyle varies very widely even in the same animal at different times. To the above must be added proteids (fibrin, serum-albumin, and globulin); extractives (sugar, urea, leucin); and salts in which sodium chloride is abundant.

The composition of lymph is so similar to that of chyle, and both to blood, that lymph might, with a fair degree of accuracy, be regarded as blood without its red corpuscles, and chyle as lymph with much neutral fat in a very fine state of division.

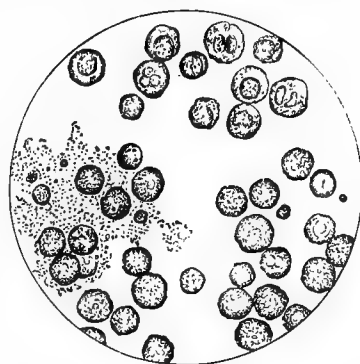

FIG. 287.—Chyle taken from the lacteals and thoracic duct of a criminal executed during digestion (Funke). Shows leucocytes and excessively fine granules of fatty emulsion.

The Movements of the Lymph—comparative.—In some fishes, some birds, and amphibians, there are lymph hearts.

In the frog there are two *axillary* and two *sacral* lymph hearts. The latter are, especially, easily seen, and there is no doubt that they are under the control of the nervous system.

In the mammals no such special helps for the propulsion of lymph exist.

There is little doubt that the blood-pressure is always higher than the lymph-pressure, and when the blood-vessels

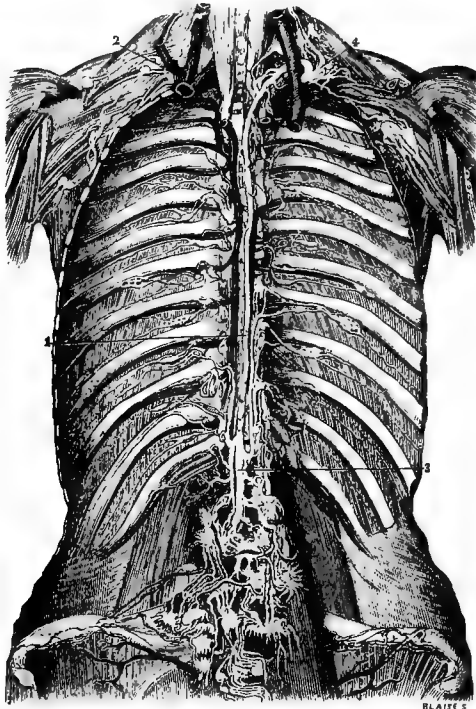

FIG. 288.—Thoracic duct (Mascagni). 1, thoracic duct; 2, great lymphatic duct; 3, receptaculum chyli; 4, curve of thoracic duct just before it empties into the venous system.

are dilated the fluid within the perivascular lymph-channels is likely compressed; muscular exercise must act on the lymph-channels as on veins, both being provided with valves, though themselves readily compressible; the inspiratory efforts, especially when forcible, assist in two ways: by the compressing effect of the respiratory muscles, and by the aspirating effect of the negative pressure within the thorax, producing a similar aspirating effect within the great veins, into which the large lymphatic trunks empty. The latter are provided at this point with valves, so that there is no back-flow; and, with the positive pressure within the large lymphatic trunks (thoracic duct, etc.), the physical conditions are favorable to the outflow of lymph or chyle.

Our knowledge of the nature of the passage of the chyle from the intestines into the blood is now clearer than it was till recently, though still incomplete.

The exact structure of a villus is to be carefully considered. If we assume that the muscular cells in its structure have a rhythmically contractile function, the blind terminal portion of the lacteal inclosed within the villus must, after being emptied, act as a suction-pump to some extent; at all events, the conditions as to pressure would be favorable to inflow of any material, especially fluid without the lacteal. The great difficulty hitherto was to understand how the fat found its

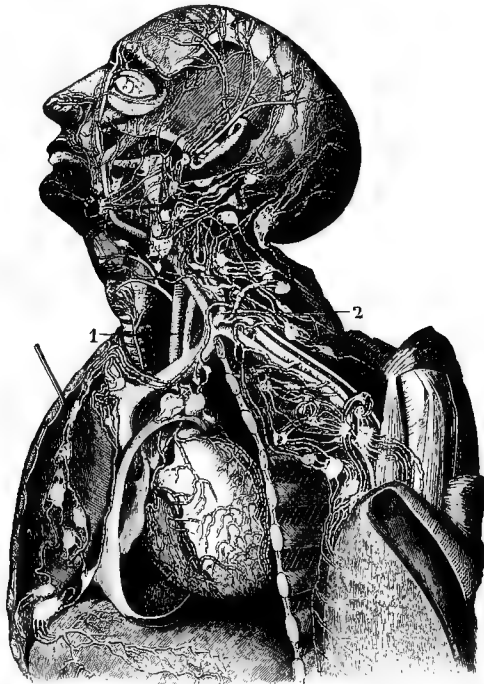

FIG. 289.—Lymphatic vessels and glands (Sappey). 1, upper extremity of thoracic duct, passing behind the internal jugular vein; 2, opening of thoracic duct into internal jugular and left subclavian vein. Lymphatic glands are seen in course of vessels.

way through the villus into the blood, for, that most of it passes in this direction there is little doubt.

It is now known that leucocytes (amœboids, phagocytes) migrate from within the villus outward, and may even reach its surface; that they take up (eat) fat-particles from the

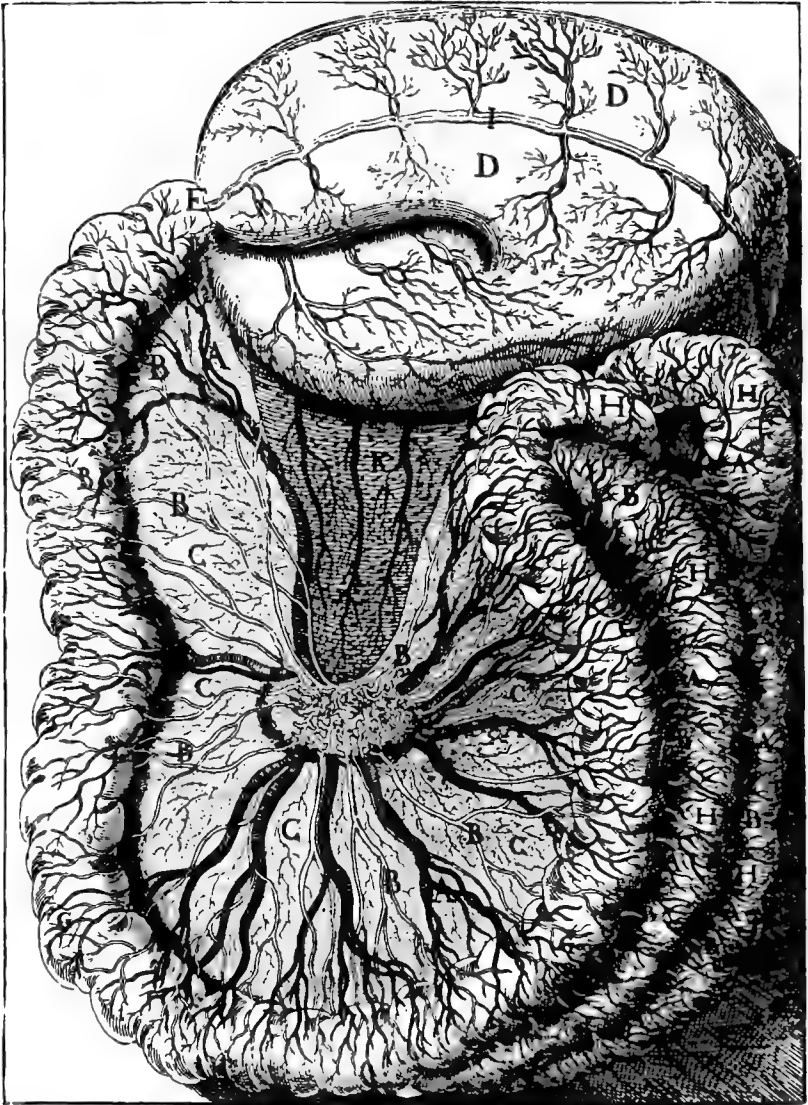

FIG. 290.—Stomach, intestine, and mesentery, with mesenteric blood-vessels and lacteals (slightly reduced from a figure in the original work of Asellius, published in 1628) (after Flint). *A, A, A, A, A*, mesenteric arteries and veins; *B, B, B, B, B, B, B, B, B, B, B, B*, lacteals; *C, C, C, C, C*, mesentery; *D, D, D*, stomach; *E*, pyloric portion of stomach; *F*, duodenum; *G, G, G, G*, jejunum; *H, H, H, H, H, H, H, H*, ileum; *I*, artery and vein on fundus of stomach; *K*, portion of omentum.

epithelium of the villus, and, independently themselves, carry them inward, reach the central lacteal and break up, thus releasing the fat. How the fat gets into the covering epithelium is

not yet so fully known—possibly by a similar inceptive process; nor is it ascertained what constructive or other chemical processes they may perform; though it is not at all likely that the work of the amoeboid cells is confined to the transport of fat alone, but that other matters are also thus removed inward to the lacteal.

Experimental.—If two frogs under the influence of urari, to remove the effect of muscular movements, be placed under observation, the one having its brain and spinal cord destroyed, the other intact, in both the aorta divided across, and normal saline solution injected into the posterior lymph-sac (beneath the skin of the back), it will be found, on suspending the two by the lower jaw, that, in the frog with the nerve-centers uninjured, abundance of saline fluid is taken up from the dorsal sac and expelled through the aorta, but in the other case none, the heart remaining all but empty.

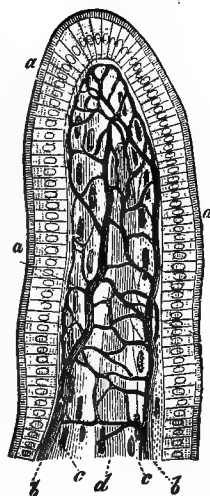

FIG. 291.—Intestinal villus (after Leydig). *a, a, a*, epithelial covering; *b, b*, capillary network; *c, c*, longitudinal muscular fibers; *d*, lacteal.



FIG. 292.—A. Villi of man, showing blood-vessels and lacteals; B. Villus of sheep (after Chauveau).

Different interpretations have been put upon this experiment. Some point to it as clear proof of the influence of the

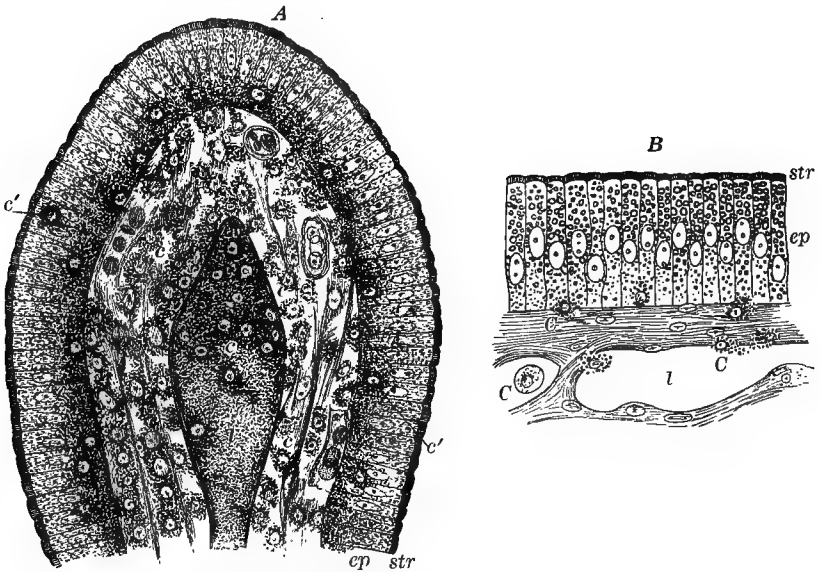

FIG. 293.—A. Section of villus of rat killed during fat absorption (Schäfer). *ep*, epithelium; *str*, striated border; *c*, lymph-cells; *c'*, lymph-cells in epithelium; *l*, central lacteal containing disintegrating corpuscles. B. Mucous membrane of frog's intestine during fat absorption (Schäfer). *ep*, epithelium; *str*, striated border; *C*, lymph-corporcules; *l*, lacteal.

nervous system directly; to others it seems that the failure of absorption is owing to the greatly dilated condition of the blood-vessels, consequent upon the loss of arterial tone, the blood remaining in the veins, and the circulation being, in fact, practically arrested. It certainly can not be claimed that the first conclusion necessarily follows from the experiment; the second may be a partial explanation of the failure of absorption; but, when a multitude of other facts are taken into account, there seems little reason to doubt that so important a process as absorption can not fail to be regulated by the nervous centers. The danger of founding any important conclusion on a single experiment is very great.

Again, if the leg of a frog, exclusive of the nerves, be ligatured, the limb will be found to swell rapidly if placed in water, which is not true of a dead limb. This is adduced as evidence for the independence of the absorptive process and the circulation; and, since section of the sciatic nerve is said to arrest absorption, such an experiment, taken together with the two

previous ones, points in the direction of the control of this process by the nervous system. But if the views we hold of the absolute dependence, especially in the higher animals, of all vital processes on the nervous system are correct, it follows, as a matter of course, that absorption in living tissues, which we do not regard as wholly explicable by any physical process, but as bound up with all the functions of cell-life, must be dependent on that connection we are endeavoring to emphasize between one tissue and another, and especially the dominating tissue, the nervous system.

There are two points that are very far from being determined: the one the fate of the products of digestion; the other the exact limit to which digestion is carried. How much—e. g., of proteid matter—does actually undergo conversion into peptone; how much is converted into leucin and tyrosin; or, again, what proportion of the albuminous matters are dealt with as such by the intestine without conversion into peptone at all, either as soluble proteid or in the form of solid particles?

1. It is generally believed that soluble sugars are absorbed, usually after conversion into maltose or glucose, by the capillaries of the stomach and intestine.

2. There is some positive evidence of the presence of fats, soaps, and sugars in unusual amount after a meal in the portal vein, which implies removal from the intestinal contents by the capillaries, though, so far as experiment goes, the fat is chiefly in the form of soaps.

Certain experiments have been made by ligating the pyloric end of the stomach, by introducing a cannula into the thoracic duct, so as to continually remove its contents, etc. But we are surprised that serious conclusions should have been drawn under such circumstances, seeing that the natural conditions are so altered. What we wish to get at in physiology is the normal function of parts, and not the possible results after our interference. Under such circumstances the phenomena may have a suggestive but certainly can not have a conclusive value.

It is a very striking fact that little peptone (none, according to some observers) can be detected even in the portal blood. True it is, the circulation is rapid and constant, and a small quantity might escape detection, yet a considerable amount be removed from the intestine in the space of a few hours by the capillaries alone. Peptone is not found in the contents of the thoracic duct.

Recent investigations have thrown a new light on peptone.

It is now known that there are several kinds of peptones, a disclosure for which we were not unprepared, considering our imperfect knowledge of proteids in general; but there have been other developments which, on the supposition that the peptone of the alimentary canal is freely absorbed as such, are startling enough. It has been shown that these peptones, at least as prepared by artificial digestion, have three effects when injected in quantity into the blood of an animal: They produce narcosis; they retard or prevent coagulation of the blood; they lower blood-pressure. The first effect may be dependent in whole or in part on the third.

But, inasmuch as the venom of poisonous reptiles, according to recent investigations, is essentially proteid in nature, it is plain that we must exercise great caution in drawing conclusions in regard to the physiological effects of proteid bodies, so long as our knowledge of their exact chemical composition is so imperfect. That the chemist can make out no great difference between peptones prepared in the laboratory and the digestive tract, or even between these and snake-venom, though they have such different effects when injected into the blood, is clear proof of how much we have yet to learn of these bodies.

But we introduce these considerations here rather to show that it is by no means likely that any great quantity of peptones passes into the blood as such at any one time. It has been recently suggested that peptone is converted into globulin in the liver. But what proof is there of this? And already we have credited the liver with a large share of work.

For a considerable period it has been customary to use the terms endosmosis and diffusion in connection with the functions of the alimentary canal, and especially the intestinal tract, as if this thin-walled but complicated organ, or rather collection of organs, were little more, so far as absorption is concerned, than a moist membrane, leaving the process of the removal of digested food products to be explained almost wholly on physical principles.

From such views we dissent. We believe they are opposed to what we know of living tissue everywhere, and are not supported by the special facts of digestion. When certain foreign bodies (as purgatives) are introduced into the blood or the alimentary canal, that diffusion takes place, according to physical laws, may indicate the manner in which the intestine can act; but even admitting that under such circumstances physical

principles actually do explain the whole, which we do not grant, it would by no means follow that such was the natural behavior of this organ in the discharge of its ordinary functions.

When we consider that the blood tends to maintain an equilibrium, it must be evident that the removal of substances from the alimentary canal, unless there is to be excessive activity of the excretory organs and waste of energy both by them and the digestive tract, must in some degree depend on the demand for the products of digestion by the tissues. That there is to some extent a corrective action of the excretory organs always going on is no doubt true, and that it may in cases of emergency be great is also true; but that this is minimized in ways too complex for us to follow in every detail is equally true. Digestion waits on appetite, and the latter is an expression of the needs of the tissues. We believe it is literally true that in a healthy organism the rate and character of digestion and of the removal of prepared products are largely dependent on the condition of the tissues of the body.

Why is digestion more perfect in overfed individuals after a short fast? The whole matter is very complex, but we think it is infinitely better to admit ignorance than attempt to explain by principles that do violence to our fundamental conceptions of life processes. To introduce "ferments" to explain so many obscure points in physiology, as the conversion of peptone in the blood, for example, is taking refuge in a way that does no credit to science.

Without denying that endosmosis, etc., may play a part in the vital processes we are considering, we believe a truer view of the whole matter will be ultimately reached. In the mean time we think it best to express our belief that we are ignorant of the real nature of absorption in great part; but we think that, if the alimentary tract were regarded as doing for the digested food (chyle, etc.) some such work as certain other glands do for the blood, we would be on the way to a truer conception of the real nature of the processes.

It would then be possible to understand that proteids either in the form of soluble or insoluble substances, including peptone, might be taken in hand and converted by a true vital process into the constituents of the blood.

If we were to regard the kidney as manufacturing useful instead of harmful products, the resemblance in behavior would in many points be parallel. We have seen that mechanical explanations of the functions of the kidney have failed, and

that it must be regarded even in those parts that eliminate most water as a genuine secreting mechanism.

We wish to present a somewhat truer conception of the lymph that is separated from the capillaries and bathes the tissues.

We would regard its separation as a true secretion, and not a mere diffusion dependent wholly on blood-pressure. The mere ligature of a vein does not suffice to cause an excess of diffusion, but the vaso-motor nerves have been shown to be concerned. The effusions that result from pathological processes do not correspond with the lymph—that is, the nutrient material—provided by the capillaries for the tissues. These vessels are more than mere carriers; they are secretors—in a sense they are glands. We have seen that in the foetus they function both as respiratory and nutrient organs in the allantois and yolk-sac, and, in our opinion, they never wholly lose this function.

The kind of lymph that bathes a tissue, we believe, depends on its nature and its condition at the time, so that, as we view tissue-lymph, it is not a mere effusion with which the tissues, for which it is provided, have nothing to do. The differences may be beyond our chemistry to determine, but to assume that all lymph poured out is alike is too crude a conception to meet the facts of the case. Glands, too, it will be remembered, derive their materials, like all other tissues, not directly from the blood, but from the lymph. We believe that the cells of the capillaries, like all others, are influenced by the nervous system, notwithstanding that nerves have not been traced terminating in them.

It is to be borne in mind that the lymph, like the blood, receives tissue waste-products—in fact, it is very important to realize that the lymph is, in the first instance, a sort of better blood—an improved, selected material, so far as any tissue is concerned, which becomes gradually deteriorated (see Fig. 329).

We have not the space to give all the reasons on which the opinions expressed above are founded; but, if the student has become imbued with the principles that pervade this work thus far, he will be prepared for the attitude we have taken, and sympathize with our departures from the mechanical (physical) physiology.

We think it would be a great gain for physiology if the use of the term “absorption,” as applied to the alimentary tract, were given up altogether, as it is sure to lead to the substitu-

tion of the gross conceptions of physical processes instead of the subtle though at present rather indefinite ideas of vital processes. We prefer ignorance to narrow, artificial, and erroneous views.

Pathological.—Under certain circumstances, of which one is obstruction to the venous circulation or the lymphatics, fluid may be poured out or effused into the neighboring tissues or the serous cavities. This is of very variable composition, but always contains enough salts and proteids to remind one of the blood.

Such fluids are often spoken of as "lymph," though the resemblance to normal tissue-lymph is but of the crudest kind; and the condition of the vessels when it is secreted, if such a term is here appropriate, is not to be compared to the natural separation of the normal lymph—in fact, were this not so, it would be like the latter, which it is not. When such effusions take place they are in themselves evidence of altered (and not merely increased) function.

The Fæces.—The fæces may be regarded in at least a three-fold aspect. They contain undigested and indigestible remnants, the ferments and certain decomposition products of the digestive fluids, and true excretory matters.

In carnivorous and omnivorous animals, including man, the undigested materials are those that have escaped the action of the secretions—such as starch and fats—together with those substances that the digestive juices are powerless to attack, as horny matter, hairs, elastic tissue, etc.

In vegetable feeders a larger proportion of chlorophyl, cellulose, and starch will, of course, be found.

These, naturally, are variable with the individual, the species, and the vigor of the digestive organs at the time.

Besides the above, certain products are to be detected in the fæces plainly traceable to the digestive fluids, and showing that they have undergone chemical decomposition in the alimentary tract, such as cholalic acid, altered coloring-matters like urobilin, derivable probably from bilirubin; also cholesterine, fatty acids, insoluble soaps (calcium, magnesium), together with ferments, having the properties of pepsin and amylopsin. Mucus is also abundant in the fæces.

We know little of the excretory products proper, as they probably normally exist in small quantity, and it is not impossible that some of the products of the decomposition of the digestive juices may be reabsorbed and worked over or excreted by the kidneys, etc.

There is, however, a recognized non-nitrogenous crystalline body known as *excretin*, which contains sulphur, salts, and pigments, and that may rank perhaps as a true excretion of the intestine.

It is well known that bacteria abound in the alimentary tract, though their number is dependent on a variety of circumstances, including the kind of food and the condition in which it is eaten. These minute organisms feed, of course, and to get their food produce chemical decompositions. *Skatol* and *indol* are possibly thus produced, and give the fæcal odor to the contents of the intestine. But as yet our ignorance of these matters is greater than our knowledge—a remark which applies to the excretory functions of the alimentary tract generally.

Pathological.—The facts revealed by clinical and pathological study leave no doubt in the mind that the intestine at all events may, when other glands, like the kidney, are at fault, undertake an unusual share of excretory work, probably even to the length of discharging urea.

Obscure as the subject is, and long as it may be before we know exactly what and how matter is thus excreted, we think that it will greatly advance us toward a true conception of the vital processes of the mammalian body if we regard the alimentary tract as a collection of organs with both a secreting and excreting function; that what we have been terming absorption is in the main, at least, essentially secretion or an allied process; and that the parts of this long train of organs are mutually dependent and work in concert, so that, when one is lacking in vigor or resting to a greater or less degree, the others make up for its diminished activity; and that the whole must work in harmony with the various excretory organs, as an excretor itself, and in unison with the general state of the economy. We are convinced that even as an excretory mechanism one part may act (vicariously) for another.

Of course, in disease the condition of the fæces is an indication of the state of the digestive organs; thus color, consistence, the presence of food in lumps, the odor, and many other points tell a plain story of work left undone, ill-done, or disordered by influences operating from within or from without the tract. The intelligent physician acts the part of a qualified inspector, surveying the output of a great factory, and drawing conclusions in regard to the kind of work which the operatives have performed.

THE CHANGES PRODUCED IN THE FOOD IN THE ALIMENTARY CANAL.

We have now considered the method of secretion, the secretions themselves, and the movements of the various parts of the digestive tract, so that a brief statement of the results of all this mechanism, as represented by changes in the food, will be appropriate. We shall assume for the present that the effects of the digestive juices are substantially the same in the body as in artificial digestion.

Among mammals food is, in the mouth, comminuted (except in the case of the carnivora, that bolt it almost whole, and the ruminants, that simply swallow it to be regurgitated for fresh and complete mastication), insalivated, and, in most species, chemically changed, but only in so far as starch is concerned.

Deglutition is the result of the co-ordinated action of many muscular mechanisms, and is reflex in nature. The œsophagus secretes mucus, which lubricates its walls, and aids mechanically in the transport of the food from the mouth to the stomach. In the stomach, by the action of the gastric juice, food is further broken up, the proteid covering of fat-cells is digested, and the structure of muscle, etc., disappears. Proteid matters

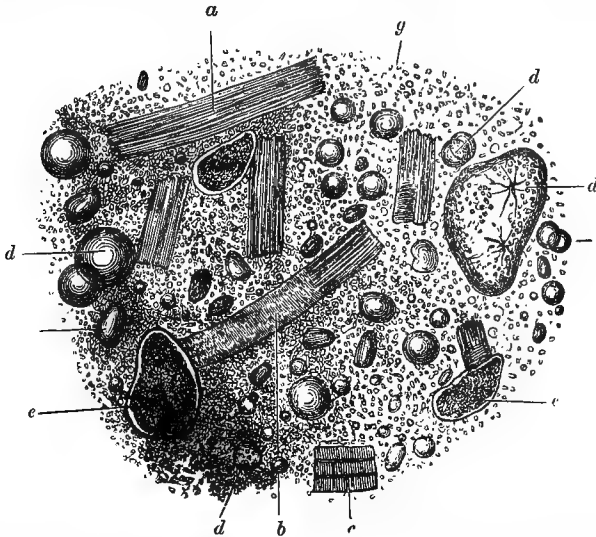

Fig. 294.—Matters taken from pyloric portion of stomach of dog during digestion of mixed food (after Bernard). *a*, disintegrated muscular fibers, striæ having disappeared; *b*, *c*, muscular fibers in which striæ have partly disappeared; *d*, *d'*, *d''*, globules of fat; *e*, *e'*, *e''*, starch; *g*, molecular granules.

become peptone, and in some animals fat is split up into free fatty acid and glycerine; but the digestion of fat in the stomach is very limited at best, and probably does not go on to emulsification or saponification. The digestion of starch continues in the stomach until the reaction of the food-mass becomes acid. This in the hog may not be far from one to two hours, and the amylolytic ferment acts with great rapidity even without the body. The food is moved about to a certain extent, so as to expose every part freely to the mucous membrane and its secretions. It is likely that the sugar resulting from the digestion of starch, the peptones, and, to some extent, the fat formed (if any), is received into the blood from the stomach.

As the partially digested mass (chyme) is passed on into the intestine as a result of the action of the alkaline bile, the para-peptone, pepsin, and bile-salts are deposited. Certain of the constituents of digestion are thus delayed, a portion of the pepsin is probably absorbed, either altered or unaltered, and pepsin is thus got rid of, making the way clear, so to speak, for the action of trypsin. At all events, digestion in one part of the tract is antagonized by digestion in another, but we must also add supplemented.

The fat, which had been but little altered, is emulsified by the joint action of the bile and pancreatic secretion; a portion is saponified, which again helps in emulsification, while an additional part, in form but little changed, is probably dealt with by the absorbents.

Proteid digestion is continued, and, besides peptones, nitrogenous crystalline bodies are formed (leucin and tyrosin), but under what conditions or to what extent is not known; though the quantity is likely very variable, both with the species of animal and the circumstances, such as quantity and quality of food; and it is likely also dependent not a little on the rate of absorption. It seems altogether probable that in those that use an excess of nitrogenous food more of these bodies are formed, and thus give an additional work to the excreting organs, including the liver. But the absence of albumin from healthy fæces points to the complete digestion of proteids in the alimentary canal. Plainly the chief work of intestinal digestion is begun and carried on in the upper part of the tract, where the ducts of the main glands are to be found.

The contents of the intestine swarm with bacteria, though

these are probably kept under control to some extent by the bile, the functions of which as an antiseptic we have already considered.

The removal of fats by the villi will be shortly considered. The other products of digestion probably find their way into the general circulation by the portal blood, passing through the liver, which organ modifies some of them in ways to be examined later.

The *valvulae conniventes* greatly increase the surface of the intestine, and retard the movements of the partially digested mass, both of which are favorable. The peristaltic movements of the small gut serve the obvious purpose of moving on the digesting mass, thus making way for fresh additions of chyme from the stomach, and carrying on the more elaborated contents to points where they can receive fresh attention, both digestive and absorptive.

Comparative.—In man, the carnivora, and some other groups, it is likely that digestion in the large intestine is slight, the work being mostly completed—at all events, so far as the action of the secretions is concerned—before this division of the tract is reached, though doubtless absorption goes on there also. The muscular strength of this gut is important in the act of defecation.

But the great size of the large intestine in ruminants—in the horse, etc.—together with the bulky character of the food of such animals, points to the existence of possibly extensive processes of which we are ignorant. It is generally believed that food remains but a short time in the stomach of the horse, and that the cæcum is a sort of reservoir in which digestive processes are in progress, and also for water.

Fermentations go on in the intestine, and probably among ruminants they are numerous and essential, though our actual knowledge of the subject is very limited.

The gases found in the human stomach are atmospheric air (swallowed) and carbon dioxide, derived from the blood. Those of the intestine are nitrogen, hydrogen, carbonic anhydride, sulphureted hydrogen, and marsh-gas, the quantity varying considerably with the diet.

Pathological.—In subjects of a highly neurotic temperament and unstable nervous system it sometimes happens that immense quantities of gas are belched from an empty stomach or distend the intestines.

It is known that the oxygen swallowed is absorbed into the

blood, and the carbonic anhydride found in the stomach derived from that fluid.

It will thus be seen that the alimentary tract has not lost its respiratory functions even in man, and that these may in certain instances be inordinately developed (*reversion*).

SPECIAL CONSIDERATIONS.

It is a matter well recognized by those of much experience in breeding and keeping animals with restricted freedom and under other conditions differing widely from the natural ones—i. e., those under which the animals exist in a wild state—that the nature of the food must vary from that which the untamed ancestors of our domestic animals used. Food may often with advantage be cooked for the tame and confined animal. The digestive and the assimilative powers have varied with other changes in the organism brought about by the new surroundings. So much is this the case, that it is necessary to resort to common experience and to more exact experiments to ascertain the best methods of feeding animals for fattening, for work, or for breeding. Inferences drawn from the feeding habits of wild animals allied to the tame to be valuable must always, before being applied to the latter, be subjected to correction by the results of experience.

To a still greater degree does this apply to man himself. The greater his advances in civilization, the more he departs from primitive habits in other respects, the more must he depart in his feeding. With the progressive development of man's cerebrum, the keener struggle for place and power, the more his nervous energies are diverted from the lower functions of digestion and assimilation of food; hence the greater need that food shall be more carefully selected, and more thoroughly and scientifically prepared. Not only so, but, with our increasing refinement, the progress of digestion to successful issues demands that the senses of man be ministered to in order that there be no interferences in the central nervous system, on the one hand, and every encouragement to the latter to furnish the necessary nervous impulses to the digestive organs and the tissues in every part of the organism: for it is not enough that food be digested in the ordinary sense; it must also be built up into the tissues, a process depending, as we shall endeavor to show later, on the nervous system.

The "gastronomic art" has, therefore, become of great im-

portance. It is as yet more of an art than a science; the cook has outstripped the physiologist, if not the chemist also, in this direction.

We can not explain fully why food prepared by certain methods and served in courses of a certain established order is so suited to refined man. A part is known, but a great deal remains to be discovered. We may, however, notice a few points of importance in regard to the preparation of food.

It is now well established by experience that animals kept in confinement must have, in order to escape disease and attain the best results on the whole, a diet which not only imitates that of the corresponding wild forms generally, but even in details, with, it may be, altered proportions or added constituents, in consequence of the difference in the environment. To illustrate: poultry can not be kept healthy confined in a shed without sand, gravel, old mortar, or some similar preparation; and for the best results they must have green food also, as lettuce, cabbage, chopped green clover, grass, etc. They must not be provided with as much food as if they had the exercise afforded by running hither and thither over a large field. We have chosen this case because it is not commonly recognized that our domesticated birds have been so modified that special study must be made of the environment in all cases if they are not to degenerate. The facts in regard to horned cattle, horses, and dogs are perhaps better known.

But all these instances are simple as compared with man. The lower mammals can live and flourish with comparatively little change of diet; not so man. He demands diet not only dissimilar in its actual grosser nature, but differently prepared. In a word, for the efferent nervous impulses, on which the digestive processes depend to be properly supplied, it has become necessary that a variety of afferent impulses (through eye, ear, nose, palate) reach the nervous centers, attuning them to harmony, so that they shall act, yet not interfere with one another.

Cooking greatly alters the chemical composition, the mechanical condition, and, in consequence, the flavor, the digestibility, and the nutritive value of foods. To illustrate: meat in its raw condition would present mechanical difficulties, the digestive fluids permeating it less completely; an obstacle, however, of far greater magnitude in the case of most vegetable foods. By cooking, certain chemical compounds are replaced by others, while some may be wholly removed. As a rule,

boiling is not a good form of preparing meat, because it withdraws not only salts of importance, but proteids and the extractives—nitrogenous and other. Beef-tea is valuable chiefly because of these extractives, though it also contains a little gelatine, albumin, and fats. Salt meat furnishes less nutriment, a large part having been removed by the brine; notwithstanding, all persons at times, and some frequently, find such food highly beneficial, the effect being doubtless not confined to the alimentary tract.

Meat, according to the heat employed, may be so cooked as to retain the greater part of its juices within it or the reverse. With a high temperature (65° to 70° C.) the outside in roasting may be so quickly hardened as to retain the juices.

In feeding dogs it is both physiological and economical to give the animal the broth as well as the meat itself. The poor man may get excellent food cheaply by using not alone the meat of the shank of beef, but the extractives derived from it. There is much waste not only by the consumption of more food than is necessary, but by the purchase of kinds in which that important class of bodies, the proteids, comes at too high a price.

It is remarkable in the highest degree that man's appetite, or the instinctive choice of food, has proved wiser than our science. It would be impossible even yet to match, by calculations based on any data we can obtain, a diet for each man equal upon the whole to what his instincts prompt. With the lower mammals we can prescribe with greater success. At the same time chemical and physiological science can lay down general principles based on actual experience, which may serve to correct some artificialities acquired by perseverance in habits that were not based on the true instincts of a sound body and a healthy mental and moral nature; for the influence of the latter can not be safely ignored even in such discussions as the present. These remarks, however, are meant to be suggestive rather than exhaustive.

We may with advantage inquire into the nature of hunger and thirst. These, as we know, are safe guides usually in eating and drinking.

After a long walk on a warm day one feels thirsty, the mouth is usually dry; at all events, moistening the mouth, especially the back of it (pharynx), will of itself partially relieve thirst. But if we remain quiet for a little time the thirst grows less, even if no fluid be taken. The dryness has been

relieved by the natural secretions. If, however, fluid be introduced into the blood either directly or through the alimentary canal, the thirst is also relieved speedily. The fact that we know when to stop drinking water shows of itself that there must be local sensations that guide us, for it is not possible to believe that the whole of the fluid taken can at once have entered the blood.

Again, in the case of hunger, the introduction of innutritious matters, as earth or sawdust, will somewhat relieve the urgent sensations in extreme cases; as will also the use of tobacco by smokers, or much mental occupation, though the latter is rather illustrative of the lessening of the consciousness of the ingoing impulses by diverting the attention from them. But hunger, like thirst, may be mitigated by injections into the intestines or the blood. It is, therefore, clear that, while in the case of hunger and thirst there is a local expression of a need, a peculiar sensation, more pronounced in certain parts (the fauces in the case of thirst, the stomach in that of hunger), yet these may be appeased from within through the medium of the blood, as well as from without by the contact of food or water, as the case may be.

Up to the present we have assumed that the changes wrought in the food in the alimentary tract were identical with those produced by the digestive ferments as obtained by extracts of the organs naturally producing them. But for many reasons it seems probable that artificial digestion can not be regarded as parallel with the natural processes except in a very general way. When we take into account the absence of muscular movements, regulated according to no rigid principles, but varying with innumerable circumstances in all probability; the absence of the influence of the nervous system determining the variations in the quantity and composition of the outflow of the secretions; the changes in the rate of so-called absorption, which doubtless influences also the act of the secretion of the juices—by these and a host of other considerations we are led to hesitate before we commit ourselves too unreservedly to the belief that the processes of natural digestion can be exactly imitated in the laboratory.

What is it which enables one man to digest habitually what may be almost a poison to another? How is it that each one can dispose readily of a food at one time that at another is quite indigestible? To reply that, in the one case, the digestive fluids are poured out and in the other not, is to go little below

the surface, for one asks the reason of this, if it be a fact, as it no doubt is. When we look further into the peculiarities of digestion, etc., we recognize the influence of race as such, and in the race and the individual that obtrusive though ill-understood fact—the force of *habit*, operative here as elsewhere. And there can be little doubt that the habits of a people, as to food eaten and digestive peculiarities established, become organized, fixed, and transmitted to posterity.

It is probably in this way that, in the course of the evolution of the various groups of animals, they have come to vary so much in their choice of diet and in their digestive processes, did we but know them thoroughly as they are; for to assume that even the digestion of mammals can be summed up in the simple way now prevalent seems to us too broad an assumption. The field is very wide, and as yet but little explored.

Human Physiology.—The study of Alexis St. Martin has furnished probably the best example of genuine human physiology to be found, and has yielded a harvest rich in results.

We suggest to the student that self-observation, without interfering with the natural processes, may lead to valuable knowledge; for, though it may lack some of the precision of laboratory experiments, it will prove in many respects more instructive, suggestive, and impressive, and have a bearing on medical practice that will make it telling. Not that we would be understood now or at any time as depreciating laboratory experiments; but we wish to point out from time to time how much may be learned in ways that are simple, inexpensive, and consume but little time.

The law of rhythm is illustrated, both in health and disease, in striking ways in the digestive tract. An individual long accustomed to eat at a certain hour of the day will experience at that time not only hunger, but other sensations, probably referable to secretion of a certain quantity of the digestive juices and to the movements that usually accompany the presence of food in the alimentary tract. Some persons find their digestion disordered by a change in the hours of meals.

It is well known that defecation at periods fixed, even within a few minutes, has become an established habit with hosts of people; and the same is to a degree true of dogs, etc., kept in confinement, that are taught cleanly habits, and encouraged therein by regular attention to their needs.

Now and then a case of what is very similar to regurgitation of food in ruminants is to be found among human beings.

This is traceable to habit, which is bound up with the law of rhythm or periodic increased and diminished activity.

Indeed, every one sufficiently observant may notice in himself instances of the application of this law in the economy of his own digestive organs.

This tendency is important in preserving energy for higher ends, for such is the result of the operation of this law everywhere.

The law of correlation, or mutual dependence, is well illustrated in the series of organs composing the alimentary tract.

The condition of the stomach has its counterpart in the rest of the tract: thus, when St. Martin had a disordered stomach, the epithelium of his tongue showed corresponding changes.

We have already referred to the fact that one part may do extra work to make up for the deficiencies of another.

It is confidently asserted of late that, in the case of persons long unable to take food by the mouth, nutritive substances given by enemata find their way up to the duodenum by anti-peristalsis. Here, then, is an example of an acquired adaptive arrangement under the stress of circumstances.

It can not be too much impressed on the mind that in the complicated body of the mammal the work of any one organ is constantly varying with the changes elsewhere. It is this mutual dependence and adaptation—an old doctrine, too much left out of sight in modern physiology—which makes the attempt to *completely* unravel vital processes well-nigh hopeless; though each accumulating true observation gives a better insight into this kaleidoscopic mechanism.

We have not attempted to make any statements as to the quantity of the various secretions discharged. This is large, doubtless, but much is probably reabsorbed, either altered or unaltered, and used over again. In the case of *fistulæ* the conditions are so unnatural that any conclusions as to the normal quantity from the data they afford must be highly unsatisfactory. Moreover, the quantity must be very variable, according to the law we are now considering. It is well known that dry food provokes a more abundant discharge of saliva, and this is doubtless but one example of many other relations between the character of the food and the quantity of secretion provided.

Evolution.—We have from time to time either distinctly pointed out or hinted at the evolutionary implications of the facts of this department of physiology. The structure of the

digestive organs, plainly indicating a rising scale of complexity with greater and greater differentiation of function, is, beyond question, an evidence of evolution.

The law of natural selection and the law of adaptation, giving rise to new forms, have both operated, we may believe, from what can be observed going on around us and in ourselves. The occurrence of transitional forms, as in the epithelium of the digestive tract of the frog, is also in harmony with the conception of a progressive evolution of structure and function. But the limits of space will not permit of the enumeration of details.

Summary.—A very brief *résumé* of the subject of digestion will probably suffice.

Food is either organic or inorganic and comprises proteids, fats, carbohydrates, salts, and water; and each of these must enter into the diet of all known animals. They must also be in a form that is digestible. Digestion is the reduction of food to a form such that it may be further dealt with by the alimentary tract prior to being introduced into the blood (absorption). This is effected in different parts of the tract, the various constituents of food being differently modified, according to the secretions there provided, etc. The digestive juices contain essentially ferments which act only under definite conditions of chemical reaction, temperature, etc.

The changes wrought in the food are the following: starches are converted into sugars, proteids into peptones, and fats into fatty acids, soaps, and emulsion; which alterations are effected by ptyalin and amylopsin, pepsin and trypsin, and bile and pancreatic steapsin, respectively.

Outside the mucous membrane containing the glands are muscular coats, serving to bring about the movements of the food along the digestive tract and to expel the fæces, the circular fibers being the more important. These movements and the processes of secretion and so-called absorption are under the control of the nervous system.

The preparation of the digestive secretions involves a series of changes in the epithelial cells concerned, which can be distinctly traced, and take place in response to nervous stimulation.

These we regard as inseparably bound up with the healthy life of the cell. To be natural, it must secrete.

The blood-vessels of the stomach and intestine and the villi of the latter receive the digested food for further elaboration

(absorption). The undigested remnant of food and the excretions of the intestine make up the fæces, the latter being expelled by a series of co-ordinated muscular movements essentially reflex in origin.

THE RESPIRATORY SYSTEM.

In the mammal the breathing organs are lodged in a closed cavity, separated by a muscular partition from that in which the digestive and certain other organs are contained. This

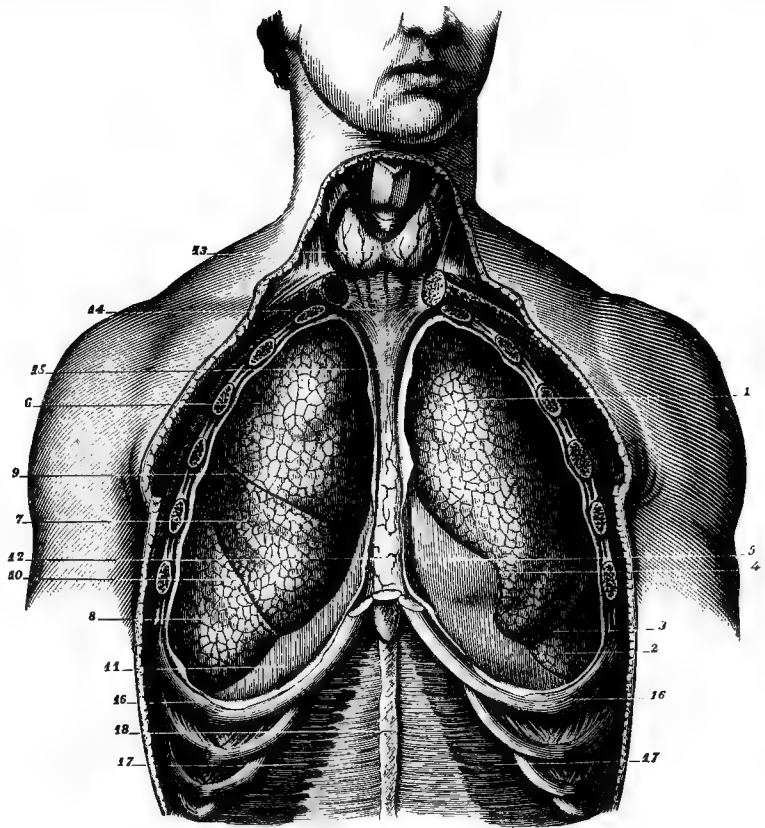

FIG. 295.—Lungs, anterior view (Sappey). 1, upper lobe of left lung; 2, lower lobe; 3, fissure; 4, notch corresponding to apex of heart; 5, pericardium; 6, upper lobe of right lung; 7, middle lobe; 8, lower lobe; 9, fissure; 10, fissure; 11, diaphragm; 12, anterior mediastinum; 13, thyroid gland; 14, middle cervical aponeurosis; 15, process of attachment of mediastinum to pericardium; 16, 16, seventh ribs; 17, 17, transversales muscles; 18, linea alba.

thoracic chamber may be said to be reserved for circulatory and respiratory organs which, we again point out, are so related that they really form parts of one system.

The mammal's blood requires so much aëration (ventilation) that the lungs are very large and the respiratory system has become greatly specialized. We no longer find the skin or alimentary canal taking any large share in the process; and the lungs and the mechanisms by which they are made to move the gases with which the blood and tissues are concerned become very complicated.

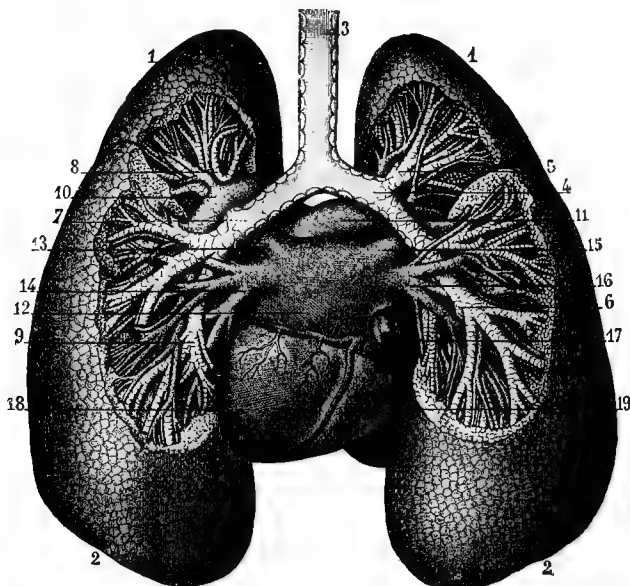

FIG. 296.—Bronchia and lungs, posterior view (Sappey). 1, 1, summit of lungs; 2, 2, base of lungs; 3, trachea; 4, right bronchus; 5, division to upper lobe of lung; 6, division to lower lobe; 7, left bronchus; 8, division to upper lobe; 9, division to lower lobe; 10, left branch of pulmonary artery; 11, right branch; 12, left auricle of heart; 13, left superior pulmonary vein; 14, left inferior pulmonary vein; 15, right superior pulmonary vein; 16, right inferior pulmonary vein; 17, inferior vena cava; 18, left ventricle of heart; 19, right ventricle.

Our studies of muscle physiology should have made clear the fact that tissue-life implies the constant consumption of oxygen and discharge of carbonic anhydride, and that the processes which give rise to this are going on at a rapid rate; so that the demands of the animal for oxygen constantly may be readily understood if one assumes, what can be shown, though less readily than in the case of muscle, that all the tissues are constantly craving, as it were, for this essential oxygen—well called “vital air.”

Respiration may, then, be regarded from a physical and chemical point of view, though in this as in other instances we

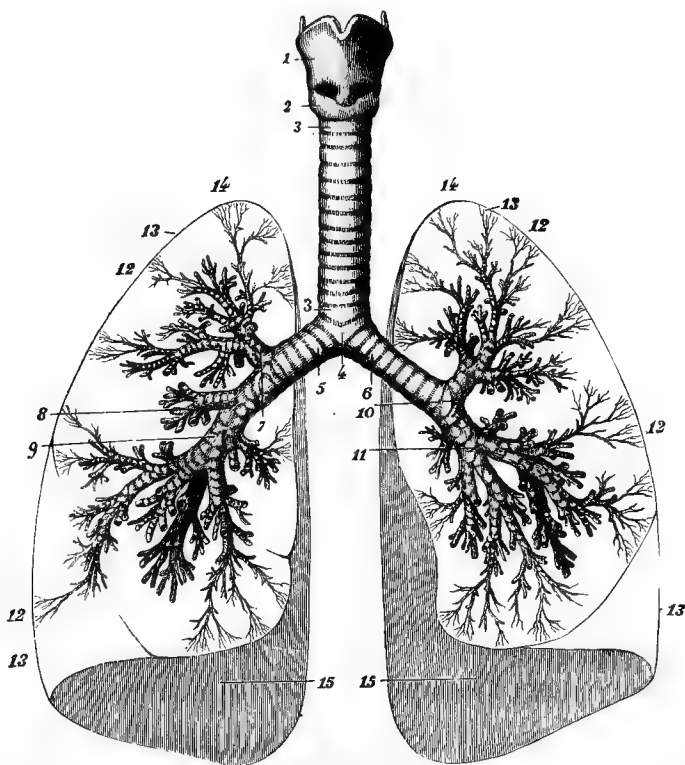

FIG. 297.—Trachea and bronchial tubes (Sappey). 1, 2, larynx; 3, 3, trachea; 4, bifurcation of trachea; 5, right bronchus; 6, left bronchus; 7, bronchial division to upper lobe of right lung; 8, division to middle lobe; 9, division to lower lobe of left lung; 10, division to upper lobe of left lung; 11, division to lower lobe; 12, 12, 12, 12, ultimate ramifications of bronchia; 13, 13, 13, 13, lungs, represented in contour; 14, 14, summit of lungs; 15, 15, base of lungs.

must be on our guard against regarding physiological processes as ever purely physical or purely chemical. The respiratory process in the mammal, unlike the frog, consists of an active and a (largely) passive phase. The air is not pumped into the lungs, but sucked in. So great is the complexity of the lungs in the mammal, that the frog's lung (which may be readily understood by blowing it up by inserting a small pipe in the glottic opening of the animal and then ligaturing the distended organ) may be compared to a single infundibulum of the mammalian lung.

Assuming that the student is somewhat conversant with the

coarse and fine anatomy of the respiratory organs, we call attention to the physiological aspects of some points. The lungs represent a membranous expansion of great extent, lined with flattened cells and supporting innumerable capillary blood-vessels. The air is admitted to the complicated foldings of this membrane by tubes which remain, throughout the greater part of their extent, open, being composed of cartilaginous rings, completed by soft tissues, of which plain muscle-cells form an

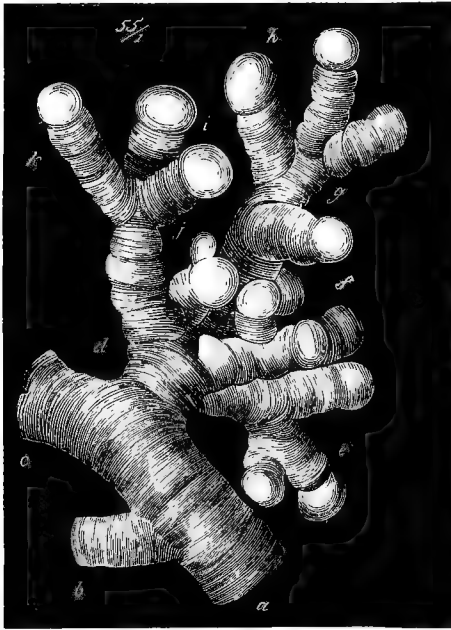

FIG. 298.—Mold of a terminal bronchus and a group of air-cells moderately distended by injection, from the human subject (Robin).

important part, serving to maintain a tonic resistance against pulmonary and bronchial pressure, as well as serving to aid in the act of coughing, etc., so important in expelling foreign bodies or preventing their ingress.

The bronchial tubes are lined with a mucous membrane, kept moist by the secretions of its glands, and covered with ciliated epithelium, as are also the nasal passages, which by the outward currents they create, favor diffusion of gases, and removal of excess of mucus. The thoracic walls and the lungs themselves are covered with a tough but thin membrane lined with flattened cells, which secrete a small quantity of fluid,

that serves to maintain the surrounding parts in a moist condition, thus lessening friction. The importance of this ar-

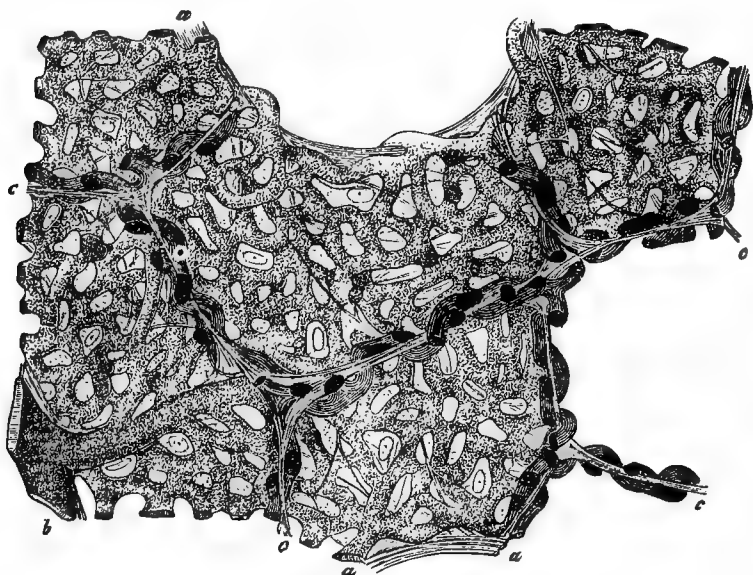

FIG. 299.—Section of the parenchyma of the human lung, injected through the pulmonary artery (Schulze). *a, a, c, c*, walls of the air-cells; *b*, small arterial branch.

rangement is well seen when, in consequence of inflammation of this pleura, it becomes dry, giving rise during each respiratory movement to a friction-sound and a painful sensation. It will not be forgotten that this membrane extends over the diaphragm, and that, in consequence of the lungs completely filling all the space (not occupied by other organs) during every position of the chest-walls, the costal and pulmonary pleural surfaces are in constant contact. By far the greater part of the lung-substance consists of elastic tissue, thus adapting the principal respiratory organs to that amount of distention and recoil to which they are ceaselessly subjected during the entire lifetime of the animal.

THE ENTRANCE AND EXIT OF AIR.

Since the lungs fill up so completely the thoracic cavity, manifestly any change in the size of the latter must lead to an increase or diminution in the quantity of air they contain. Since the air within the respiratory organs is being constantly

robbed of its oxygen, and rendered impure by the addition of carbonic dioxide, the former must be renewed and the latter expelled ; and, as mere diffusion takes place too slowly to accomplish this in the mammal, this process is assisted by the nervous system setting certain muscles at work to alter the size of the chest cavity.

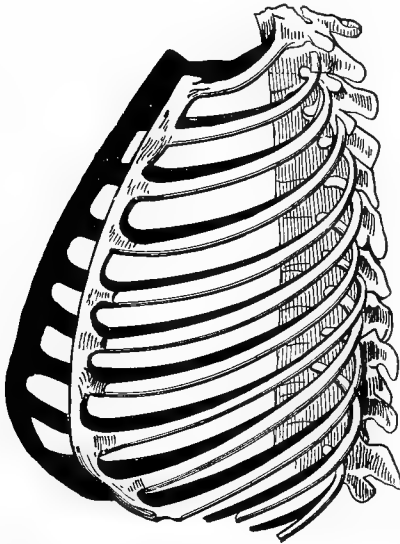

FIG. 300.—Diagram illustrating elevation of ribs in inspiration (Béclard). The dark lines represent the ribs, sternum, and costal cartilages in inspiration.

Because of the ribs being placed obliquely, it follows that their elevation will result in the enlargement of the thoracic cavity in the antero-posterior diameter ; and, as the chest, in consequence, gets wider from above downward, also in the transverse diameter ; which is moreover assisted by the eversion of the lower borders of the ribs ; and, if the convexity of the diaphragm were diminished by its contraction and

consequent descent, it would follow that the chest would be increased in the vertical diameter also. All these events, favorable to the entrance of air, actually take place through agencies we must now consider. The student is recommended to look into the insertion, etc., of the muscles concerned, to which we can only briefly refer.

The act of inspiration commences by the fixation of the uppermost ribs, beginning with the first two, by means of the *scaleni* muscles, this act being followed up by the contraction of the external intercostals, leading to the elevation of the other ribs ; at the same time, the arch of the diaphragm descends in consequence of the contraction of its various muscular bundles. Under these circumstances, the air from without must rush in, or a vacuum be formed in the thoracic cavity ; and, since there is free access for the air through the glottic opening, the lungs are of necessity expanded. This ingoing air has had to overcome the elastic resistance of the lungs, which amounts to about 5 millimetres of mercury in man, as ascertained by tying a manometer in the windpipe of

a dead subject, and then opening the thorax to equalize the inside and outside pressures, when the lungs at once collapse and the manometer shows a rise of the mercury to the extent indicated above. To this we must add the influence of the tonic contraction of the bronchial muscles before referred to, though this is probably not very great.

That there are variations of intrapulmonary pressure may be ascertained by connecting a manometer with one nostril—the other being closed—or with the windpipe. The mercury shows a negative pressure with each inspiratory, and a positive with each expiratory act. This may amount to from 30 to 70 millimetres with strong inspiration, and 60 to 100 in forcible expiration.

When inspiration ceases, the elastic recoil of the rib cartilages and the ribs themselves, and of the sternum, the weight

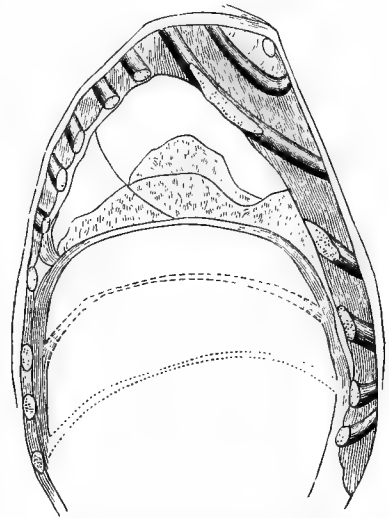

FIG. 301.—Diagrammatic representation of action of diaphragm in inspiration (Hermann). Vertical section through second rib on right side. The broken and dotted lines show the amount of the descent of the diaphragm in ordinary and in deep inspiration.

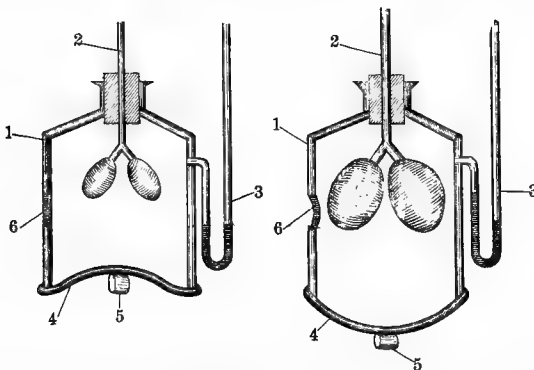

FIG. 302.—Apparatus to illustrate relations of intra-thoracic and external pressures (after Beaunis). A glass bell-jar is provided with a light stopper, through which passes a branching glass tube fitted with a pair of elastic bags representing lungs. The bottom of the jar is closed by rubber membrane representing diaphragm. A mercury manometer indicates the difference in pressure within and without the bell-jar. In left-hand figure it will be seen that these pressures are equal; in right (inspiration), the external pressure is considerably greater. At one part (6) an elastic membrane fills a hole in jar, representing an intercostal space.

of these parts and that of the attached muscles, etc., assists in the return of the chest to its original position, entirely independently of the action of muscles.

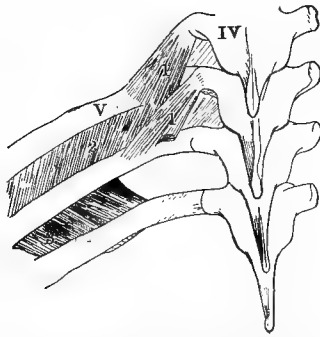

FIG. 303.—Dorsal view of four vertebrae and three attached ribs, showing attachment of elevator muscles of ribs and intercostals (after Allen Thomson). 1, long and short elevators; 2, external intercostal; 3, internal intercostal.

Moreover, with the descent of the diaphragm the abdominal viscera have been thrust down and compressed together with their included gases; when this muscle relaxes, they naturally exert an upward pressure. Putting these events together, it is not difficult to understand why the air should be squeezed out of the lungs, the elasticity of which latter is, as we have shown, an important factor in itself.

The Muscles of Respiration.—The *diaphragm* may be considered the most important single respiratory muscle, and can of itself maintain

respiration. The *scaleni* are important as fixators of the ribs; the *levator costarum*, and *external intercostals*, as normal elevators. The *quadratus lumborum* assists the diaphragm by fixing the last rib. These, with the *serratus porticus superior*, may be regarded as the principal muscles called into action in an ordinary inspiration. The muscles used in an ordinary expiratory act are the *internal intercostals*, the *triangularis sterni*, and *serratus posticus inferior*. In forced inspiration the lower ribs are drawn down and retracted, giving support in their fixed position to the diaphragm. The *scaleni*, *pectorales*, *serratus magnus*, *latissimus dorsi*, and others are called into action; but when dyspnoea becomes extreme, as in one with a fit of asthma, nearly all the muscles of the body may be called into play, even the muscles of the face, which are not normally active at all or but very slightly in natural breathing.

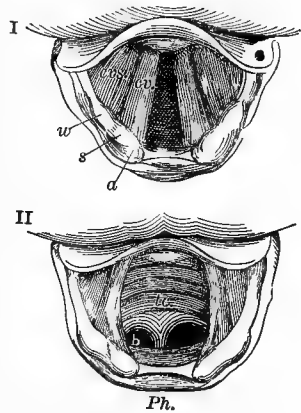

FIG. 304.—Laryngoscopic views of the glottis, etc. (after Quain and Czernak). I, Larynx in quiet breathing. II, During a deep inspiration. In this case the rings of the trachea and commencement of bronchi are visible. Such a condition is persistent in many forms of disease in which respiration is attended with difficulty.

Facial and laryngeal respiration is best seen in such animals as the rabbit, and it is this condition which is approximated in disordered states in man—in fact, when from any cause inspiration is very labored (asthma, diphtheria, etc.).

In man and most mammals, unlike the frog, the glottic opening is never entirely closed during any part of the respiratory act, though it undergoes a rhythmical change of size, widening during inspiration and narrowing during expiration, in accordance with the action of the muscles attached to the arytenoid cartilages, the action of which may be studied in man by means of the laryngoscope.

The abdominal muscles have a powerful rhythmical action during forced respiration, though whether they function during ordinary quiet breathing is undetermined; if at all, probably but slightly. Though the removal of the external intercostals in the dog and some other animals reveals the fact that the internal intercostals contract alternately with the diaphragm, it must not be regarded as absolutely certain that such is their action when their companion muscles are present, for Nature has more ways than one of accomplishing the same purpose—a fact that seems often to be forgotten in reasoning from experiments. This result, however, carries some weight with it.

Types of Respiration.—There are among mammals two principal types of breathing recognizable—the costal (thoracic) and abdominal—according as the movements of the chest or the abdomen are the more pronounced.

In the civilized white woman, even in the female child, the upper thorax takes a larger share in respiration than in the male sex. This has been explained, on the one hand, as being due to artificial influences, modes of dress, and their inherited effects; and on the other to natural ones, the crowding of the respiratory organs, owing to the contents of the pelvic and abdominal cavities encroaching on the thorax, in consequence of the enlargement of the uterus during pregnancy. It has, however, been maintained recently that an examination of pure-blooded Indian girls does not show the features of respiration just noticed as characteristic of the breathing of white females, the inference from which is obvious. But, again, it is to be remembered that the Indian and other women retaining primitive habits possess a power of adaptation to the demands of the pregnant condition no longer shown by white women. Thoracic breathing in females is probably the result of several co-operating causes, of which usage in dress is one.

Personal Observation.—The student would do well at this stage to test the statements we have made in regard to the respiratory movements on the human subject especially. This he can very well do in his own person when stripped to the waist before a mirror. Many of the abnormalities of the forced respiration of disease may be imitated—in fact, this is one of the departments of physiology in which the human aspects may be examined into by a species of experiment on one's self that is as simple as it is valuable.

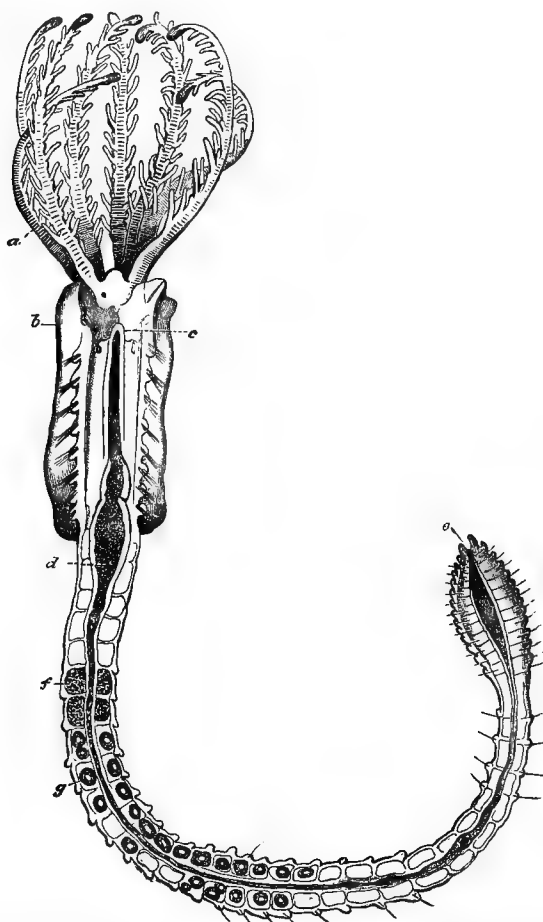

FIG. 305.—*Protula dysteri*, a marine annelid living in a calcareous tube constructed by itself (after Huxley). The cut represents the sexually mature animal (hermaphrodite) extracted from its calcareous tube. *a*, branchial (respiratory) plumes, abundantly vascular; *b*, hood-like expansion of anterior end of body; *c*, mouth; *d*, stomach; *e*, anus; *f*, testes; *g*, ova.

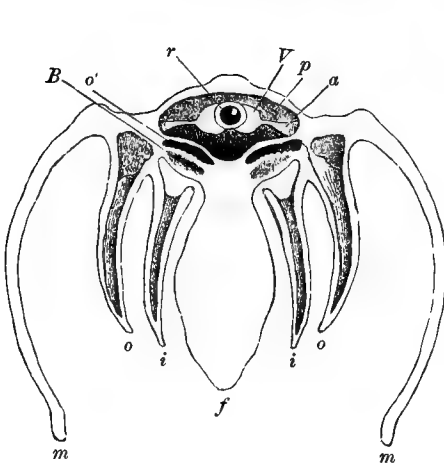

FIG. 306.

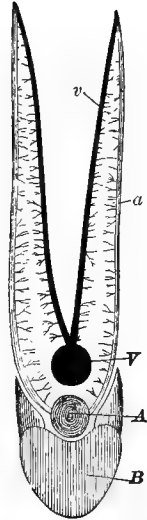

FIG. 307.

FIG. 306.—Vertical transverse section of fresh-water mussel (*Anodon*) through heart (after Huxley). *V*, ventricle; *a*, auricles; *r*, rectum; *p*, pericardium; *i*, inner, *o*, outer gill; *o'*, vestibule of organ of Bojanus, *B*, *f*, foot; *m*, *m*, mantle lobes.

FIG. 307.—Gill of fish (perch), to illustrate relations of different blood-vessels, etc., concerned in respiration (after Bell). *A*, branchial artery; *B*, branchial arch seen in cross-section; *V*, branchial vein; *a*, *v*, branches of artery and vein respectively.

Comparative.—It is hoped that the various figures accompanied by descriptions, introduced in this and other chapters, will make the relations of the circulation and respiration in the va-

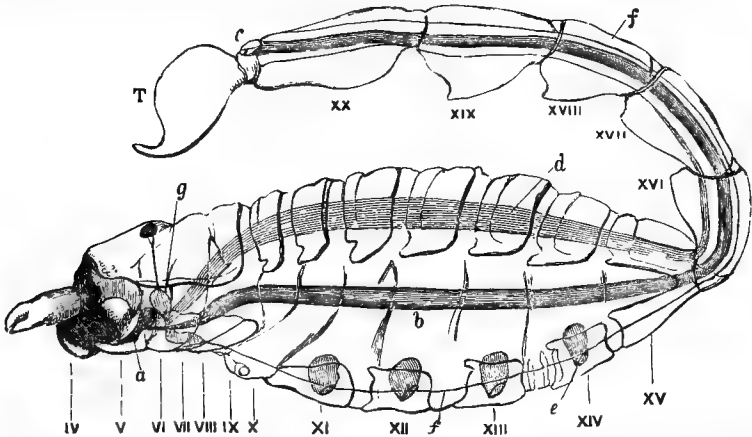

FIG. 308.—Diagram of scorpion, most of the appendages having been removed (after Huxley). *a*, mouth; *b*, alimentary tract; *c*, anus; *d*, heart; *e*, pulmonary sac; *f*, position of ventral ganglionated cord; *g*, cerebral ganglia; *T*, telson. VII—XX, seventh to twentieth somite. IV, V, VI, basal joints of pedipalpi and two following pairs of limbs.

rious classes of animals, whether terrestrial or aquatic, evident without extended treatment of the subject in the text. What

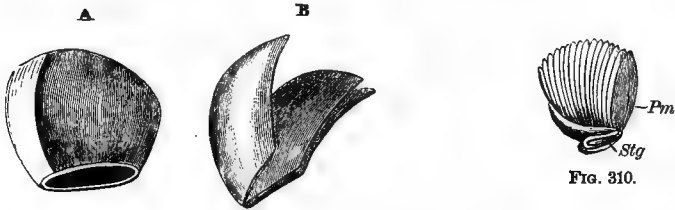

FIG. 309.

FIG. 310.—Left pulmonary sac, viewed from dorsal aspect, of a spider (after Dugès). *pm*, pulmonary lamellæ; *stg*, stigma, or opening to former.

we are desirous of impressing is that throughout the entire animal kingdom respiration is essentially the same process; that

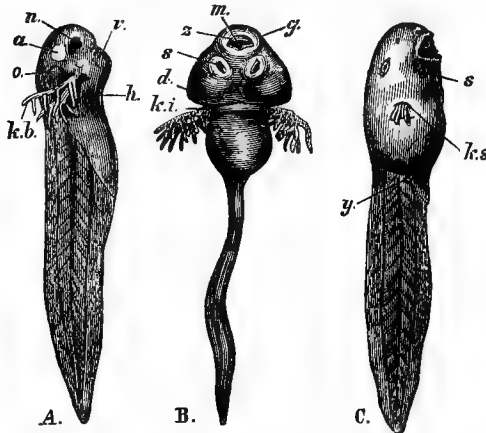

FIG. 311.—A. B. Tadpoles with external branchiæ (after Huxley). *n*, nasal sacs; *a*, eye; *o*, ear; *k. b.* branchiæ; *m*, mouth; *z*, horny jaws; *s*, suckers; *d*, opercular (or gill) fold. C. More advanced frog's larva. *y*, rudiment of hind-limb; *k. s.* single branchial aperture. Owing to figure not having been reversed, this aperture seems to lie on right instead of left side.

finally it resolves itself into tissue-breathing: the appropriation of oxygen and the excretion of carbon dioxide. Since the manner in which oxygen is introduced into the lungs and foul gases expelled from them in some reptiles and amphibians, is largely different from the method of respiration in the mammal, we call attention to this process in an animal readily watched—the common frog. This creature, by depressing the floor of the mouth, enlarges his air-space in this region and consequently the air freely enters through the nostrils; whereupon the latter are closed by a sort of valve, the glottis opened

and the air forced into the lungs by the elevation of the floor of the mouth. By a series of flank movements the elasticity of the lungs is aided in expelling the air through the now open nostrils. The respiration of the turtle and some other reptiles is somewhat similar. In the case of aquatic animals, both in-

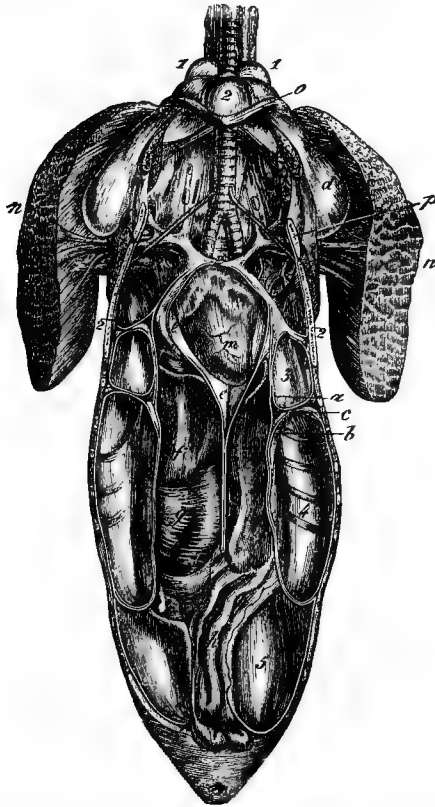

FIG. 312.—General view of air-reservoirs of duck, opened inferiorly: also their relations with principal viscera of trunk (after Sappey). 1, 1, anterior extremity of cervical reservoirs; 2, thoracic reservoir; 3, anterior diaphragmatic reservoir; 4, posterior ditto; 5, abdominal reservoir; *a*, membrane forming anterior diaphragmatic reservoir; *b*, membrane forming posterior ditto; *c*, section of thoraco-abdominal diaphragm; *d*, subpectoral prolongation of thoracic reservoir; *e*, pericardium; *f*, *f*, liver; *g*, gizzard; *h*, intestines; *m*, heart; *n*, *n*, section of great pectoral muscle above its insertion into the humerus; *o*, anterior clavicle; *p*, posterior clavicle of right side cut and turned outward.

vertebrate and vertebrate, excepting mammals, the blood is freely exposed in the gills to oxygen dissolved in the water as it is to the same gas mixed with nitrogen in terrestrial animals. In the land-snail, land-crab, etc., we have a sort of intermediate condition, the gills being kept moist. It is not to be for-

gotten, however, that normally the respiratory tract of mammals is never other than slightly moist.

THE QUANTITY OF AIR RESPIRED.

We distinguish between the quantity of air that usually is moved by the thorax, and that which may be respired under special effort, which, of course, can never exceed the capacity of the respiratory organs.

Accordingly, we recognize: 1. *Tidal air*, or that which passes in and out of the respiratory passages in ordinary quiet breathing, amounting to about 500 cc., or thirty cubic inches. 2. *Complemental air*, which may be voluntarily inhaled by a forced inspiration in addition to the tidal air, amounting to 1,500 cc., or about 100 cubic inches. 3. *Supplemental (reserve) air*, which may be expelled at the end of a normal respiration—i. e., after the expulsion of the tidal air, and which represents the quantity usually left in the lungs after a normal quiet expiration, amounting to 1,500 cc. 4. *Residual air*, which can not be voluntarily expelled at all, amounting to about 2,000 cc., or 120 cubic inches.

The *vital capacity* is estimated by the quantity of air that may be expired after the most forcible inspiration. This will, of course, vary with the age, which determines largely the elasticity of the thorax, together with sex, position, height, and a variety of other circumstances. But, inasmuch as the result may be greatly modified by practice, like the power to expand the chest, the vital capacity is not so valuable an indication as might at first be supposed.

It is important to bear in mind that the tidal air is scarcely more than sufficient to fill the upper air-passages and larger bronchi, so that it requires from five to ten respirations to remove a quantity of air inspired by an ordinary act. Very much must, therefore, depend on diffusion, the quantity of air remaining in the lungs after each breath being the sum of the residual and reserve air, or about 3,500 cc. (220 cubic inches). Considering the creeping slowness of the capillary circulation, it would not be supposed that the respiratory process in its essential parts should be the rapid one that a greater movement of the air would imply.

THE RESPIRATORY RHYTHM.

In man, and most of our domestic mammals, a definite relation between the cardiac and respiratory movements obtains, there being about four to five heart-beats to one respiration, which would make the rate of breathing in man about sixteen to eighteen per minute. Usually, of course, the largest animals have the slower pulse and respiration; and this is an invariable rule for the varieties of a species, as observable in the canine race, to mention a well-known instance.

The rate of the respiratory movements is to some extent a measure of the rapidity of the oxidative processes in the body, as witness the slow and intermittent breathing of cold-blooded animals as compared with the more rapid respiration of birds and mammals (Fig. 313).

Pathological.—Any condition that lessens the amount of respiratory surface, or diminishes the mobility of the chest-walls is usually accompanied by accelerated movements, but beneath this is the demand for oxygen, part of the avenues by which this gas usually enters, having been closed or obstructed by the disease. So that it is not surprising that, in consequence of the effusion of fluid into the thoracic cavity, leading to the compression of the lung, the opposite one should be called into more frequent use, and even enlarge to meet the demand. These facts show how urgent is the need for constant ventilation of the blood, and at the same time how great is the power of adaptation to meet the emergency.

The difference between the inspiratory and the expiratory rhythm may be gathered by watching the movements of the bared chest, or more accurately from a graphic record. It is usually considered that expiration is only slightly longer than inspiration, and that any marked deviation from this relation should arouse suspicion of disease. Normally the respiratory pause is very slight, so that inspiration seems to follow directly on expiration; though the latter act reminds us of the prolongation of the ventricular systole after the blood is expelled.

If, in the tracing, the small waves on the upper part of the expiratory curve really represent the effect of the heart-beat, it makes it easier to understand how such might assist in ventilating the blood when the respirations occur only once in a considerable interval and very feebly then, as in hibernating animals or individuals that have fainted; though it must be

remembered that diffusion is a ceaseless process in all living vertebrates.

It is scarcely necessary to point out that the respiratory

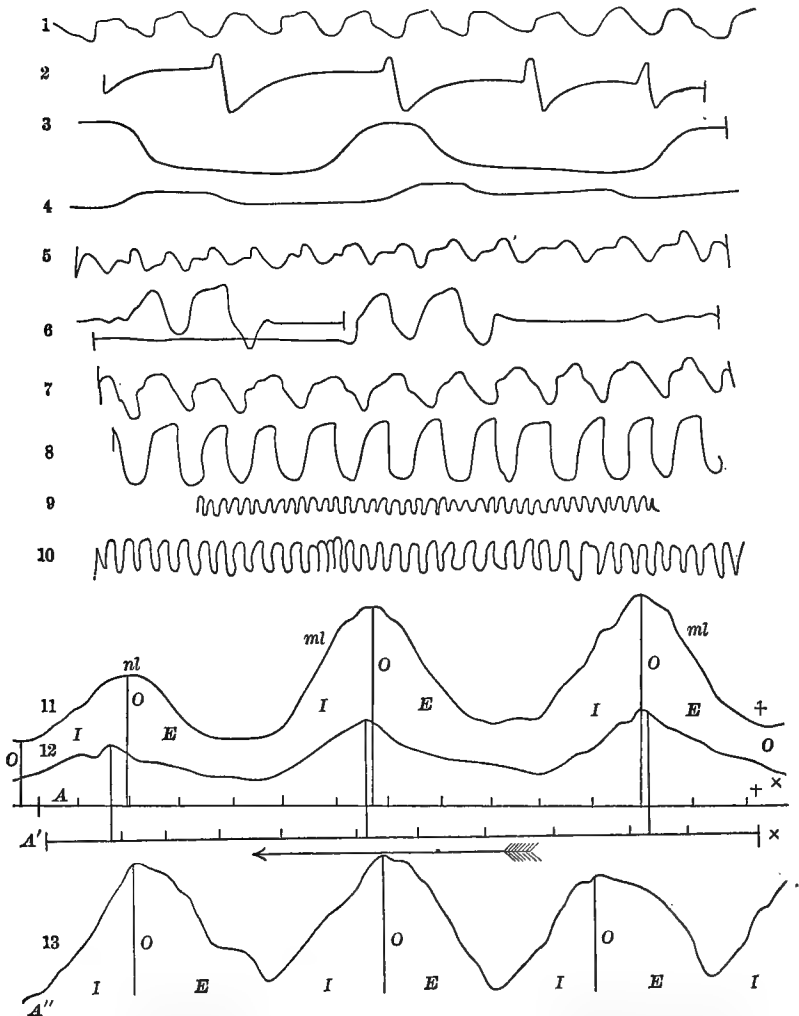

FIG. 313.—Tracings of respiratory movements of individuals belonging to different groups of the animal kingdom (after Thanoffer). Differences in depth, frequency, and especially regularity, are very noticeable. 1, fish; 2, tortoise; 3, adder (in winter); 4, boa-constrictor (in summer); 5, frog; 6, alligator; 7, lizard; 8, canary-bird; 9, adult dog; 10, rabbit; 11, man; 12, dog; 13, horse. Compare these, and note that in *ml* respiration is shallow, and in *ml* deep.

movements are increased by exercise, emotions, position, season, hour of the day, taking meals, etc.

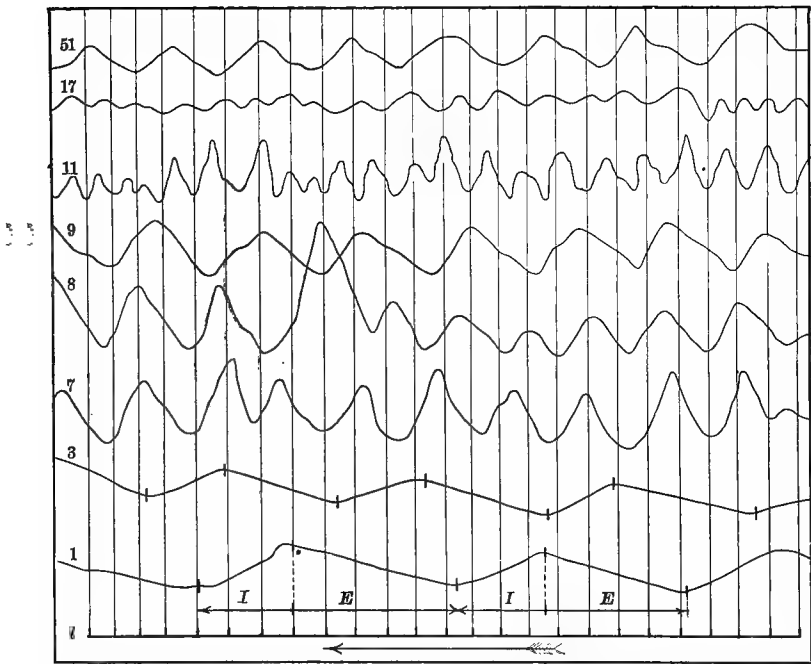

FIG. 314.—Tracings of respiration of horse when at rest and after exercise (after Thanoffer). *I*, inspiration; *E*, expiration. Spaces between vertical lines indicate time periods of one second each. 1, animal standing at rest; 3, after walk of few minutes; 7 and 8, after trotting; 9, after a brief rest; 11, after trotting and running for some minutes; 17, after resting from last for a short time; 51, tracing at end of experiment.

Respiratory Sounds.—The entrance and exit of air are accompanied by certain sounds, which vary with each part of the respiratory tract. To these sounds names have been given, but as they are somewhat inconstant in their application, or at least have several synonyms, we pass them by, recommending the student to actually learn the nature of the respiratory murmurs by listening to the normal chest in both man and the lower animals. With the use of a double stethoscope he may practice upon himself, though not so advantageously as in the case of the heart.

The sounds are caused in part by the friction of the air, though they are probably complex, several factors entering into their causation.

COMPARISON OF THE INSPIRED AND EXPIRED AIR.

The changes that take place in the air respired may be briefly stated as follows:

1. Whatever the condition of the inspired air, that expired is about saturated with aqueous vapor—i. e., it contains all that it is capable of holding at the existing temperature.

2. The temperature of the expired air is about that of the blood itself, so that if the air is very cold when breathed, the body loses a great deal of its heat in warming it. The expired air of the nasal passages is slightly warmer than that of the mouth.

3. Experiment shows that the expired air is really diminished in volume to the extent of from one fortieth to one fiftieth of the whole. Since two volumes of carbonic anhydride require for their composition two volumes of oxygen, if the amount of the former gas expired be not equal to the amount of oxygen inspired, some of the latter must have been used to form other combinations. $\frac{\text{CO}_2}{\text{O}}$, amounting to rather less than 1, is called the respiratory coefficient.

4. The difference between inspired and expired air may be gathered from the following:

	Oxygen.	Nitrogen.	Carbonic dioxide.
Inspired air.....	20·810	79·150	0·040
Expired air.....	16·033	79·587	4·380

From which the most important conclusions to be drawn are, that the expired air is poorer in oxygen to the extent of 4 to 5 per cent, and richer in carbonic anhydride to somewhat less than this amount.

From experiment it has been ascertained that the amount of carbonic dioxide is for the average man 800 grammes (406 litres, equivalent to 218·1 grammes carbon) daily, the oxygen actually used for the same period being 700 grammes. But the variations in such cases are very great, so that these numbers must not be interpreted too rigidly. Experience proves that, while chemists often work in laboratories in which the percentage of carbonic anhydride (from chemical decompositions) reaches 5 per cent, an ordinary room in which the amount of this gas reaches 1 per cent is entirely unfit for occupation. This is not because of the amount of the carbon dioxide present, but of other impurities which seem to be excreted in proportion to the amount of this gas, so that the latter may be taken as a measure of these poisons.

What these are is as yet almost entirely unknown, but that they are poisons is beyond doubt. Small effete particles of

once-living protoplasm are carried out with the breath, but these other substances are got rid of from the blood by a vital process of secretion (excretion), we must believe; which shows that the lungs to some degree play the part of glands, and that their whole action is not to be explained as if they were merely moistened bladders acting in accordance with ordinary physical laws.

An estimation of the amount of atmospheric air required may be calculated from data already given.

Thus, assuming that a man gives up at each breath 4 per cent of carbon dioxide to the 500 cc. of tidal air he expires, and breathes, say, seventeen times a minute, we get for the amount of air thus charged in one hour to the extent of 1 per cent:

$$500 \times 4 \times 17 \times 60 = 2,040,000 \text{ cc., or } 2,040 \text{ litres.}$$

But if the air is to be contaminated to the extent of only $\frac{1}{10}$ per cent of carbonic anhydride, the amount should equal at least $2,040 \times 10$ hourly.

RESPIRATION IN THE BLOOD.

It may be noticed that arterial blood kept in a confined space grows gradually darker in color, and that the original bright scarlet hue may be restored by shaking it up with air. When the blood has passed through the capillaries and reached the veins, the color has changed to a sort of purple, characteristic of venous blood. Putting these two facts together, we are led to suspect that the change has been caused in some way by oxygen. Exact experiments with an appropriate form of blood-pump show that from one hundred volumes of blood, whether arterial or venous, about sixty volumes of gas may be obtained; that this gas consists chiefly of oxygen and carbonic anhydride, but that the proportions of each present depends upon whether the blood is arterial or venous.

The following table will make this clear:

	Oxygen.	Carbonic anhydride.	Nitrogen.
Arterial blood.....	20	40	1-2
Venous blood.....	8-12	46	1-2

from 100 volumes of blood at 0° C. and 760 millimetre pressure.

Arterial blood, then, contains 8 to 12 per cent more oxygen and about 6 per cent more carbonic dioxide than venous blood. It is not, of course, true, as is sometimes supposed, that arterial

blood is "pure blood" in the sense that it contains no carbonic anhydride, as in reality it always carries a large percentage of this gas.

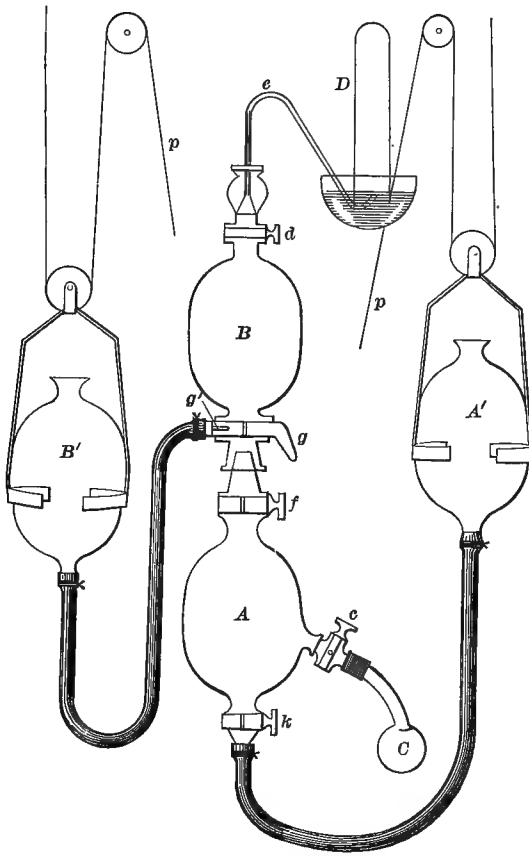

FIG. 315.—Diagrammatic illustration of Ludwig's mercurial gas-pump. *A* and *B* are two glass globes, connected by strong India-rubber tubes, with two similar glass globes, *A'* and *B'*. *A* is further connected by means of the stop-cock *c* with the receiver *C*, containing the blood (or other fluid) to be analyzed; and *B*, by means of the stop-cock *d* and tube *e* with the receiver *D*, for receiving the gases. *A* and *B* are also connected with each other by means of the stop-cocks *f* and *g*, the latter being so arranged that *B* also communicates with *B'* by the passage *g'*. *A'* and *B'* being full of mercury, and the cocks *k*, *f*, *g* and *d* being open, but *c* and *g'* closed, on raising *A'* by means of the pulley *p* the mercury of *A'* fills *A*, driving out the air contained in it into *B*, and so out through *e*. When the mercury has risen above *g*, *f* is closed; and *g'* being opened, *B'* is in turn raised till *B* is completely filled with mercury, all the air previously in it being driven out through *e*. Upon closing *d* and lowering *B'*, the whole of the mercury in *B* falls into *B'*, and a vacuum consequently is established in *B*. On closing *g'* but opening *g*, *f*, and *k*, and lowering *A'*, a vacuum is similarly established in *A* and in the junction between *A* and *B*. If the cock *c* be now opened, the gases of the blood in *C* escape into the vacuum of *A* and *B*. By raising *A'* after the closure of *c* and opening of *d*, the gases so set free are driven from *A* into *B*, and by the raising of *B'* from *B* through *e* into the receiver *D*, standing over mercury. (After Foster.)

The Conditions under which the Gases exist in the Blood.—If a fluid, as water, be exposed to a mixture of gases which it can

absorb under pressure, it is found that the amount taken up depends on the quantity of the particular gas present independent of the presence or quantity of the others; thus, if water be exposed to a mixture of oxygen and nitrogen, the quantity of oxygen absorbed will be the same as if no nitrogen were present—i. e., the absorption of a gas varies with the *partial pressure* of that gas in the atmosphere to which it is exposed. But whether blood, deprived of its gases, be thus exposed to oxygen under pressure, or whether the attempt be made to remove this gas from arterial blood, it is found that the above-stated law does not apply.

When blood is placed under the exhaustion-pump, at first very little oxygen is given off; then, when the pressure is considerably reduced, the gas is suddenly liberated in large quantity, and after this comparatively little. A precisely analogous course of events takes place when blood deprived of its oxygen is submitted to this gas under pressure. On the other hand, if these experiments be made with *serum*, absorption follows according to the law of pressures. Evidently, then, if the oxygen is merely dissolved in the blood, such solution is peculiar, and we shall presently see that this supposition is neither necessary nor reasonable.

HÆMOGLOBIN AND ITS DERIVATIVES.

Hæmoglobin constitutes about $\frac{1}{10}$ of the corpuscles, and, though amorphous in the living blood-cells, may be obtained in crystals, the form of which varies with the animal; indeed, in many animals this substance crystallizes spontaneously on the death of the red cells. It is unique among albuminous compounds in being the only one found in the animal body that is susceptible of crystallization. Its estimated composition is:

Carbon	53·85
Hydrogen	7·32
Nitrogen.....	16·17
Oxygen.....	21·84
Iron.....	·43
Sulphur	·39

together with 3 to 4 per cent of water of crystallization.

The formula assigned is: $C_{600}H_{960}O_{170}N_{154}FeS_8$. The molecular constitution is not known, and the above formula is merely an approximation, which will, however, serve to convey an idea

of the great complexity of this compound. The presence of iron seems to be of great importance. If not the essential respiratory constituent, certainly the administration of this metal in some form proves very valuable when the blood is deficient in hæmoglobin.

This substance can be recognized most certainly by the spectroscope. The appearances vary with the strength of the solution, and, as this test for blood (hæmoglobin) is of much practical importance, it will be necessary to dwell a little upon the subject; though, after a student has once recognized clearly the differences of the spectrum appearances, he has a sort of knowledge that no verbal description can convey. This is easily acquired. One only needs a small, flat-sided bottle and a pocket-spectroscope. Filling the bottle

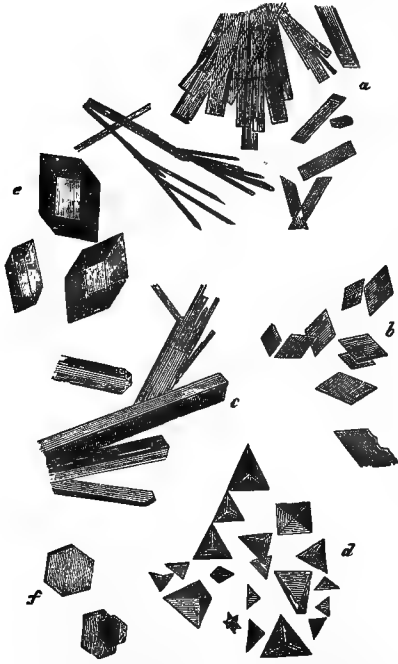

FIG. 316. — Crystallized hæmoglobin (Gautier). *a, b*, crystals from venous blood of man; *c*, from blood of cat; *d*, of Guinea-pig; *e*, of marmot; *f*, of squirrel.

half-full of water, and getting the spectroscope so focused that the Fraunhofer lines appear distinctly, blood, blood-stained serum, a solution of hæmoglobin-crystals, or the essential substance in any form of dilute solution, may be added drop by drop till changes in the spectrum in the form of dark bands appear. By gradually increasing the quantity, appearances like those figured below may be observed, though, of course, much will depend on the thickness of the layer of fluid as to the quantity to be added before a particular band comes into view.

When wishing to be precise, we speak of the most highly oxidized form of hæmoglobin as oxy-hæmoglobin (O-H), and the reduced form as hæmoglobin simply, or reduced hæmoglobin (H).

By a comparison of the spectra it will be seen that the bands

of oxy-hæmoglobin lie between the *D* and *E* lines; that the left band near *D* is always the most definite in outline and the

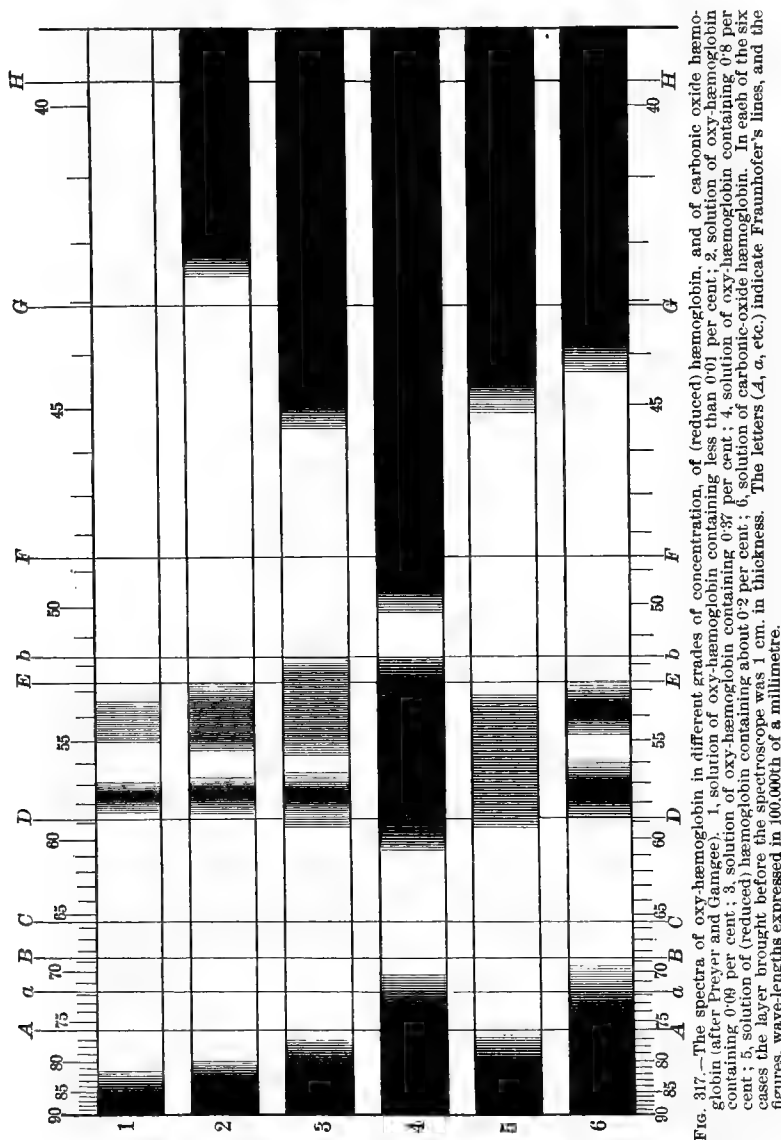

most pronounced in every respect except breadth; that it is in weak solutions the first to appear, and the last to disappear on

reduction; that there are two instances in which there may be a single band from hæmoglobin—in the one case when the solution is very dilute and when it is very concentrated. These need never be mistaken for each other nor for the band of reduced hæmoglobin. The latter is a hazy broad band with comparatively indistinct outlines, and darkest in the middle.

It will be further noticed that in all these instances, apart from the bands, the spectrum is otherwise modified at each end, so that the darker the more centrally placed characteristic bands, the more is the light at the same time cut off at each end of the spectrum.

If, now, to a specimen showing the two bands of oxy-hæmoglobin distinctly a few drops of ammonium sulphide or other reducing agent be added, a change in the color of the solution will result, and the single hazy band characteristic of hæmoglobin will appear.

It is not to be supposed, however, that venous blood gives this spectrum. Even after asphyxia it will be difficult to see this band, for usually some of the oxy-hæmoglobin remains reduced; but it is worthy of note, as showing that the appearances are normal, that the blood, viewed through thin tissues when actually circulating, whether arterial or venous, gives the spectrum of oxy-hæmoglobin. At the same time there can be no doubt that the changes in color which the blood undergoes in passing through the capillaries is due chiefly to loss of oxygen, as evidenced by the experiments before referred to; and the reason that the two bands are always to be seen in venous blood is simply that enough oxy-hæmoglobin remains to give the two-band spectrum which prevails over that of (reduced) hæmoglobin. We are thus led by many paths to the important conclusion that the red corpuscles are oxygen-carriers, and, though this may not be and probably is not their only function, it is without doubt their principal one. Of their oxygen they are being constantly relieved by the tissues; hence the necessity of a circulation of the blood from a respiratory point of view.

There are other gases that can replace oxygen and form compounds with hæmoglobin; hence we have CO-hæmoglobin and NO-hæmoglobin, which in turn are replaced by oxygen with no little difficulty—a fact which explains why carbonic oxide is so fatal when respired, and, as it is a constituent of illuminating gas, the cause of the death of those inhaling the latter is often not far to seek. Blood may, in fact, be saturated with

carbonic oxide by allowing illuminating gas to pass through it, when a change of color to a cherry red may be observed, and which will remain in spite of prolonged shaking up with air or attempts at reduction with the usual reagents. Hæmoglobin may be resolved into a proteid (globin) not well understood, and *hæmatin*. This happens when the blood is boiled (perhaps also in certain cases of lightning-stroke), and when strong acids are added. Hæmatin is soluble in dilute acids and alkalies, and has then characteristic spectra. Alkaline hæmatin may be reduced; and, as the iron can be separated, resulting in a change of color to brownish red, after which there are no longer any reducing effects, it would seem that the oxygen-carrying power and iron are associated. This iron-free hæmatin is named *hæmatoporphyrin* or *hæmatoin*.

Hæmin is hydrochlorate of hæmatin (Teichmann's crystals), and may be formed by adding glacial acetic acid and common salt to blood, dried blood-clot, etc., and heating to boiling. This is one of the best tests for blood, valuable in medico-legal and other cases.

When oxy-hæmoglobin stands exposed to the air, or when diffused in urine, it changes color and becomes, in fact, another substance—*methæmoglobin*, irreducible by other gases (CO, etc.), and not surrendering its oxygen *in vacuo*, though giving it up to ammonium sulphide, becoming again oxy-hæmoglobin, when shaken up with atmospheric air. Its spectrum differs from that of oxy-hæmoglobin in that it has a band in the red end of the spectrum between the *C* and *D* lines. *Hæmatoidin* is sometimes found in the body as a remnant of old blood-clots. It is probably closely allied to if not identical with the *bilirubin* of bile.

Comparative.—While hæmoglobin is the respiratory agent in all the groups of vertebrates, this is not true of the invertebrates. Red blood-cells have as yet been found in but a few species, though hæmoglobin does exist in the blood plasma of several groups, to one of which the earth-worm and several other annelids belong. It is interesting to note that the respiratory compound in certain families of crustaceans, as the common crab, horseshoe-crab (*limulus*), etc., is blue, and that in this substance copper seems to take the place of iron.

The Nitrogen and the Carbon Dioxide of the Blood.—The little nitrogen which is found in about equal quantity in venous and arterial blood, seems to be simply dissolved. The relations of carbonic anhydride are much more complex and obscure. The

main facts known are that—1. The quantity of this gas is as great in serum as in blood, or, at all events, the quantity in serum is very large. 2. The greater part may be extracted by an exhaustion-pump; but a small percentage (2 to 5 volumes per cent) does not yield to this method, but is given off when an acid is added to the serum. 3. If the entire blood be subjected to a vacuum, the whole of the CO_2 is given off.

From these facts it has been concluded that the greater part of the CO_2 exists in the plasma, associated probably with sodium salts, as sodium bicarbonate, but that the corpuscles in some way determine its relations of association and disassociation. Some think a good deal of this gas is actually united with the red corpuscles.

We may now inquire into the more intimate nature of respiration in the blood. From the facts we have stated it is obvious that respiration can not be wholly explained by the Henry-Dalton law of pressures or any other physical law. It is also plain that any explanation which leaves out the principle of pressure must be incomplete.

While there is in oxy-hæmoglobin a certain quantity of oxygen, which is intra-molecular and incapable of removal by reduction of pressure, there is also a portion which is subject to this law, though in a peculiar way; nor is the question of temperature to be excluded, for experiment shows that less oxygen is taken up by blood at a high than at a low temperature.

We have learned that, in ordinary respiration, the proportion of carbonic dioxide and oxygen in different parts of the respiratory tract must vary greatly; the air of necessity being much less pure in the alveoli than in the larger bronchi.

From experiments on blood, venous and arterial, to determine the conditions of pressure, temperature, etc., under which the injurious gas is got rid of and the necessary one absorbed, it has been found that the partial pressure of oxygen in the lungs is sufficient to bring about that surrender of oxygen to the blood necessary to keep it all but saturated with this gas as it is believed to be; and that, so far as carbonic anhydride is concerned, the same law holds—i. e., the partial pressure in the blood is ordinarily greater than in the alveoli.

By means of an apparatus by which one of the smaller bronchi may be occluded for a certain period, and also allow of withdrawal of samples of the air in the occluded portion of lung from time to time, to ascertain its composition, attempts

have been made to determine the pressure relations within an alveolus. It is maintained that while the partial pressure of the carbonic anhydride rises and of the oxygen sinks, still that they remain such as to favor respiration. It is also found that, in the asphyxia following occlusion of the trachea, the tension of oxygen is always greater, and of carbonic anhydride less, in the alveoli than in the blood. On the other hand it is stated that oxy-hæmoglobin is found in the blood when every trace of oxygen is removed from a chamber in which an asphyxiating animal is breathing, so that it is argued that partial pressures alone can not explain the facts of respiration, and that this function is fundamentally a chemical process; and it is customary to speak of the oxygen of oxy-hæmoglobin as being in a state of "loose chemical combination."

The entire truth seems to lie in neither view, though both are partially correct.

The view expressed by some physiologists, to the effect that diffusion explains the whole matter, so far, at least, as carbonic anhydride is concerned, and that the epithelial cells of the lung have no share in the respiratory process, does not seem to be in harmony either with the facts of respiration or with the laws of biology in general. Why not say at once that the facts of respiration show that, here as in other parts of the economy, while physical and chemical laws, *as we know them*, stand related to the vital processes, yet, by reason of being vital processes, we can not explain them according to the theories of either physics or chemistry? Surely this very subject shows that neither chemistry nor physics is at present adequate to explain such processes. It is, of course, of value to know the circumstances of tension, temperature, etc., under which respiration takes place. We, however, maintain that these are conditions only—essential no doubt, but, though important, that they do not make up the process of respiration. But, because we do not know the real explanation, let us not exalt a few facts or theories of chemistry or physics into a solution of a complex problem. Besides, some of the experiments on which the conclusions have been based are questionable, inasmuch as they seem to induce artificial conditions in the animals operated upon; and we have already insisted on the blood being regarded as a living tissue, behaving differently in the body and when isolated from it, so that even in so-called blood-gas experiments there may be sources of fallacy inherent in the nature of the case.

Foreign Gases and Respiration.—These are divided into:

1. *Indifferent gases*, as N, H, CH₄, which, though not in themselves injurious, are entirely useless to the economy.

2. *Poisonous gases*, fatal, no matter how abundant the normal respiratory food may be. They are divisible into: (a) those that kill by displacing oxygen, as NO, CO, HCN; (b) *narcotic gases*, as CO₂, N₂O, producing asphyxia when present in large quantities; (c) *reducing gases*, as H₂S, (NH₄)₂S, PH₃, AsH₃, C₂N₂, which rob the hæmoglobin of its oxygen.

There are probably a number of poisonous products, some of them possibly gases, produced by the tissues themselves and eliminated normally by the respiratory tract; and these are doubtless greatly augmented, either in number or quantity, or both, when other excreting organs are disordered.

RESPIRATION IN THE TISSUES.

We first direct attention to certain striking facts:

1. An isolated (frog's) muscle will continue to contract for a considerable period and to exhale carbon dioxide in the total absence of oxygen, as in an atmosphere of hydrogen; though, of course, there is a limit to this, and a muscle to which either no blood flows, or only venous blood, soon shows signs of fatigue. 2. In a frog, in which physiological saline solution has been substituted for blood, the metabolism will continue, carbonic anhydride being exhaled as usual. 3. Substances, which are readily oxidized, when introduced into the blood of a living animal or into that blood when withdrawn undergo but little oxidative change. 4. An entire frog will respire carbonic dioxide for hours in an atmosphere of nitrogen.

Such facts as these seem to teach certain lessons clearly. It is evident, first of all, that the oxidative processes that give rise to carbon dioxide occur chiefly in the *tissues* and not in the blood; that in the case of muscle the oxygen that is used is first laid by, banked as it were against a time of need, in the form of intra-molecular oxygen, which is again set free in the form of carbon dioxide, but by what series of changes we are quite unable to say. Though our knowledge of the respiratory processes of muscle is greater than for any other tissue, there seems to be no reason to believe that they are essentially different elsewhere. The advantages of this banking of oxygen are, of course, obvious; were it otherwise, the life of every cell must be at the mercy of the slightest interruption of the flow of blood, the

entrance of air, etc. Even as it is, the need of a *constant* supply of oxygen in warm-blooded animals is much greater than in cold-blooded creatures, which can long endure almost entire cessation of both respiration and circulation, owing to the comparatively slow rate of speed of the vital machinery.

If one were to rely on mere appearances he might suppose that in the more active condition of certain organs there was less chemical interchange (respiration) between the blood and the tissues than in the resting stage, or, properly speaking, more tranquil stage, for it must be borne in mind that a living cell is never wholly at rest; its molecular changes are ceaseless. It happens, e. g., that when certain glands (salivary) are secreting actively, the blood flowing from them is less venous in appearance than when not functionally active. This is not because less oxygen is used or less abstracted from the blood, but because of the greatly increased speed of the blood-flow, so that the total supply to draw from is so much larger that, though more oxygen is actually used, it is not so much missed, nor do the greater additions of carbon dioxide so rapidly pollute this rapid stream.

It is thus seen that throughout the animal kingdom respiration is fundamentally the same process. It is in every case finally a consumption of oxygen and production of carbonic anhydride by the individual cell, whether that be an *Amœba* or an element of man's brain. These are, however, but the beginning and end of a very complicated biological history of by far the greater part of which nothing is yet known; and it must be admitted that diffusion or any physical explanation carries us but a little way on toward the understanding of it.

THE NERVOUS SYSTEM IN RELATION TO RESPIRATION.

We have considered the muscular movements by which the air is made to enter and leave the lungs in consequence of changes in the diameters of the air-inclosing case, the thorax. It remains to examine into the means by which these muscles were set into harmonious action so as to accomplish the purpose. The nerves supplying the muscles of respiration are derived from the spinal cord, so that they must be under the dominion of central nerve-cells situated either in the cord or the brain. Is the influence that proceeds outward generated within the cells independently of any afferent impulses, or is it dependent on such causes? Let us appeal to facts.

1. If the phrenics, an intercostal nerve, etc., be cut, there is a corresponding paralysis of the muscle supplied. 2. If the spinal cord be divided below the medulla oblongata, there is a cessation of all respiratory movements except those of the larynx and face, which also disappear if the facial and recurrent laryngeal nerves be divided. 3. So long as the medulla remains, respiration may continue; but if even a small part of this region, situated below the vaso-motor center between this and the *calamus scriptorius* (respiratory center, *nœud vital*), be injured, death ensues rapidly. Plainly, then, there are central cells which originate the impulses that energize the muscles.

It remains to inquire still whether they are independent (automatic) centers, or are influenced by impulses reaching them from without. Is the government absolute, or subject to the will of the multitudinous cells of the organic commonwealth?

Again let us appeal to facts: 1. If one vagus nerve be cut, a change is observable in the respiratory rhythm, which is much more pronounced if both nerves be divided. Respiration becomes slower, and the pause between inspiration and expiration greatly lengthened, though the gaseous interchange remains much as before. 2. If one suddenly step into a cold bath, he naturally draws a long breath. Again, the respiration is very greatly altered in consequence of emotional changes; indeed, there is probably no rhythm in the body more subject to frequent obvious alteration than that of respiration. 3. Stimulation of the central end of such a nerve as the sciatic causes marked change in the rhythm of breathing. 4. Stimulation of the central end of the vagus usually quickens respiration, while stimulation of the central end of the superior laryngeal has the opposite effect. If the current be strong, respiration may be arrested in each instance, though in a different manner. In the case of vagus stimulation the result is inspiratory spasm, and of the superior laryngeal expiratory spasm.

These and a host of additional facts, experimental and other, show that the central impulses are modified by afferent impulses reaching the center through appropriate nerves. Moreover, drugs seem to act directly on the center through the blood.

The vagus is without doubt *the* afferent respiratory nerve, though how it is affected, whether by the mechanical movement

of the lungs merely, by the condition of the blood as regards its contained gases, or, as seems most likely, by a combination of circumstances into which these enter and are probably the

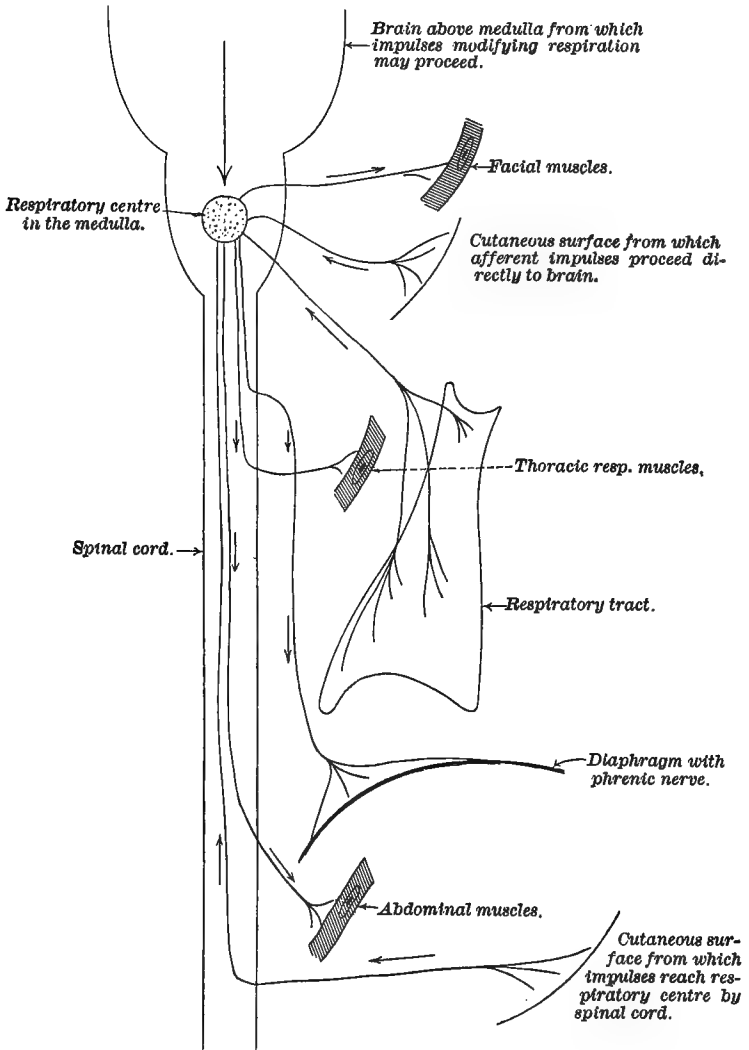

FIG. 318.—Diagram intended to illustrate nervous mechanism of respiration. Arrows indicate course of impulses.

principal, is not demonstrably clear. When others function as afferent nerves, capable of modifying the action of the respira-

tory center, they are probably influenced by the respiratory condition of the blood, though not necessarily exclusively.

But when all the principal afferent impulses are cut off by division of the nerves reaching the respiratory center directly or indirectly, respiration will still continue, provided the motor nerves and the medulla remain intact.

The center, then, is not, mainly at least, a reflex but an automatic one, though its action is modified by afferent impulses reaching it from every quarter. Since respiration continues when the medulla is divided in the middle line, yet is modified unilaterally when one vagus is divided, it is inferred that the respiratory center is double, that each half usually works in harmony with the other, but that each can act independently. Though it seems clear enough that the respiratory center is automatic, and that its action is modified according to the condition of the organism generally, as communicated to it by the various afferent nerves and the blood itself, yet the exact manner of its action—why inspiration follows up expiration—has not been clearly explained. Some assume that during expiration inspiratory impulses are gathering head and finally check expiration by originating inspiration, while these are opposed by another process which at length gives rise to enough resistance to check inspiration, and originate expiration; and this theory becomes more complete if an expiratory as well as inspiratory center be assumed.

We have hitherto spoken only of a single respiratory center in the medulla, but certain experimental facts throw additional light on the subject.

In young mammals—e. g., kittens—it is found that, in the absence of the medulla, respiratory movements may be induced by stimulating (pinching) the surface, especially if the action of the spinal cord be augmented by the administration of strychnia. From this it has been inferred that there are respiratory centers in the spinal cord, subordinate to the main center in the medulla. Considering the imperfect nature of the respiratory act as thus induced, and the circumstances of the case, the conclusion has the appearance of being a little strained. But quite recently it has been shown that in the adult dog when the cord is severed below the medulla, and artificial respiration maintained for some time, on ceasing this, breathing begins spontaneously and continues for a considerable period; and the expiratory phase of respiration in this case is the most marked. It has been argued from this experiment that there

are both inspiratory and expiratory centers in the spinal cord. But, as we have pointed out, on more than one occasion, we must always be on our guard in interpreting the behavior of one part when another is out of gear. There is so much latent resource, so great a power to resume functions normally laid aside, if not wholly in great part, that we should hesitate before inferring that the spinal cord usually takes a prominent share in *originating* the impulses which govern respiration. Notwithstanding the suggestiveness of such experiments, we do not think they make the medulla appear in a less important light as the part of the nervous system dominant in respiration; though there may be nervous machinery in the cord usually in feeble action, susceptible of assuming a more exalted functional *rôle* when occasion urgently demands and when encouraged, so to speak, to do so, as in the experiments referred to above; indeed such, upon our own theory of physiological reversion, would naturally be the case. We must, however, draw the line between what is and what may be in function.

The Influence of the Condition of the Blood in Respiration.—If for any reason the tissues are not receiving a due supply of oxygen, they manifest their disapproval, to speak figuratively, by reports to the responsible center in the medulla, and if the medulla is a sharer in the lack, as it naturally would be, it takes action independently. One of the most obvious instances in which there is oxygen starvation is when there is hindrance to the entrance of air, owing to obstruction in the respiratory tract.

At first the breathing is merely accelerated, with perhaps some increase in the depth of the inspirations (*hyperpnœa*), a stage which is soon succeeded by labored breathing (*dyspnœa*), which, after the medulla has called all the muscles usually employed in respiration into violent action, passes into convulsions, in which every muscle may take part.

In other words, the respiratory impulses not only pass along their usual paths as energetically as possible, but radiate into unusual ones and pass by nerves not commonly thus set into functional activity.

It would be more correct, perhaps to assume that the various parts of the nervous system are so linked together that excessive activity of one set of connections acts like a stimulus to rouse another set into action, the order in which this happens depending on the law of habit—habit personal and especially ancestral. An opposite condition to that described, known as

apnœa, may be induced by pumping air into an animal's chest very rapidly by a bellows; or in one's self by a succession of rapid, deep respirations.

After ceasing, the breathing may be entirely interrupted for a brief interval, then commence very quietly, gradually increasing to the normal.

Apnœa has been interpreted in two ways. Some think that it is due to fatigue of the muscles of respiration or the respiratory center; others that the blood has under these circumstances an excess of oxygen, which so influences the respiratory center that it is quieted (inhibited) for a time.

The latter view is that usually adopted; but, considering that *apnœa* results from the sobbing of children following a prolonged fit of crying, also in Cheyne-Stokes and other abnormal forms of breathing, and that the blood is normally almost saturated with oxygen, it will be agreed that there is a good deal to be said for the first view, especially that part of it which represents the cessation of breathing as owing to excessive activity and exhaustion of the respiratory center. We find such a calm in asphyxia after the convulsive storm.

Is it, then, the excessive accumulation of carbon dioxide or the deficiency of oxygen that induces dyspnœa? Considering that the former gas acts as a narcotic, and does not induce convulsions, even when it constitutes a large percentage of the atmosphere breathed, and that the need of oxygen for the tissues is constant, it certainly seems most reasonable to conclude that the phenomena of dyspnœa are owing to the lack of oxygen chiefly, at least; though the presence of an excess of carbonic anhydride may take some share in arousing that vigorous effort on the part of the nervous system, to restore the functional equilibrium, so evident under the circumstances.

The Cheyne-Stokes Respiration (Phenomenon).—There is a form of breathing occurring under a variety of abnormal circumstances, in which the respirations gradually reach a maximum (dyspnœa), and then as gradually decline to absolute cessation (*apnœa*). The pause may last a surprising length of time (one half to three quarters of a minute), when this form of breathing again repeats itself. It has been compared to the periodic grouping of heart-beats (Luciani groups), occurring when the organ is suffering. There is abundant cause usually for exhaustion of the center, on account of disordered blood or an insufficient supply to the brain. This phenomenon and *apnœa* bring out clearly the rhythmic character of those processes,

like respiration, which in the nature of the case must be in the higher groups of vertebrates ceaseless, and it is not surprising that, like a lame dog, which prefers progression by three legs to none at all, the ever-active center will keep up its rhythm as long as it can—perfectly, if possible, and, if not perfectly, as well as it can. We mean to imply that its action must be rhythmic, or cease entirely.

THE EFFECTS OF VARIATIONS IN THE ATMOSPHERIC PRESSURE.

These depend in great part upon the suddenness with which the change is made. When an individual ascends a high mountain or rises in a balloon, parts in contact with the air become reddened and swollen, owing to the distention of the small vessels, which may result in hæmorrhages. There is difficulty in breathing, the respirations become more rapid, as also the pulse. If the lowering of pressure amounts to from one third to one half, the quantity of oxygen in the blood is diminished, and the carbon dioxide imperfectly excreted. Owing to the excess of blood in the superficial parts, the internal organs become anæmic, and there is consequently diminished secretion of urine and a variety of other disturbances, with general weakness. The blood-pressure is also altered.

Sudden diminution of pressure gives rise to a liberation of gas—chiefly nitrogen—within the blood-vessels, which causes death by blocking the circulation in the small vessels (hence also the danger from section of a large vein in surgical operations about the neck, the air being liable to be sucked in, owing to the negative pressure).

Increase in the atmospheric pressure when not very great gives rise to symptoms akin to those of narcotic poisoning; but when the increase amounts to twenty atmospheres, animals die, as if asphyxiated, with convulsions. Neither the assumption of oxygen nor the separation of carbon dioxide takes place to the usual extent; and it is interesting to note that micro-organisms are killed under similar circumstances.

With considerable diminution of pressure, though not sufficient to lead to a fatal result, symptoms the opposite of those described above occur. Thus, there is paleness of the surface, respiration is easy, the capacity of the lungs is increased, owing, it is thought, to the greater descent of the diaphragm, in consequence of the compression of the gases of the intestines.

Urine is secreted in excess, there is more muscular energy, and the metabolism of the body generally is accelerated. Air under altered pressure has been employed as a therapeutic agent, but a little reflection will make it clear that it is a remedy to be used with the greatest care, especially when there is disease of the heart, blood-vessels, etc.

THE INFLUENCE OF RESPIRATION ON THE CIRCULATION.

An examination of tracings of the intra-thoracic and blood-pressure, taken simultaneously, shows (1) that during inspiration the blood-pressure rises and the intra-thoracic pressure falls; (2) that during expiration the reverse is true; and (3) that the heart-beat is slowed, and has a decided effect on the form of the pulse. But it also appears that the period of highest blood-pressure is just after expiration has begun.

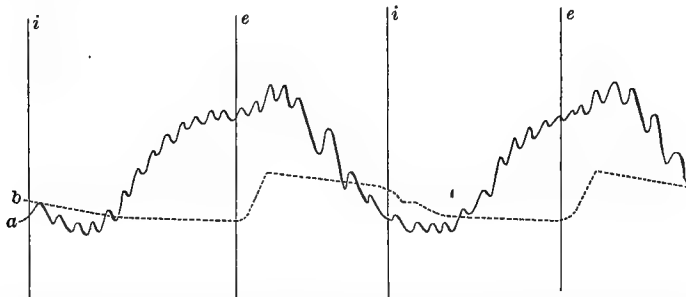

FIG. 319.—Tracings of blood-pressure and intrathoracic pressure (after Foster). *a*, blood-pressure tracing showing irregularities due to respiration and pulse; *b*, curve of intrathoracic pressure; *i*, beginning of inspiration; *e*, of expiration. Intrathoracic pressure is seen to rise rapidly after inspiration ceases, and then slowly sinks as the expiratory blast continues, to become a rapid fall when inspiration begins.

We must now attempt to explain how these changes are brought about. By intra-thoracic pressure is meant the pressure the lungs exert on the costal pleura or any organ within the chest, which must differ from intra-pulmonary pressure and the pressure of the atmosphere, because of the resistance of the lungs by virtue of their own elasticity.

It has been noted that even in death the lungs remain partially distended; and that when the thorax is opened the pulmonary collapse which follows demonstrates that their elasticity amounts to about five millimetres of mercury, which must, of course, represent but a small portion of that elasticity which may be brought into play when these organs are greatly distended, so that they never press on the costal walls, heart,

etc., with a pressure equal to that of the atmosphere. It follows that the deeper the inspiration the greater the difference between the intra-thoracic and the atmospheric pressure. Even in expiration, except when forced, the intra-thoracic pressure remains less, for the same reason.

These conditions must have an influence on the heart and blood-vessels. Bearing in mind that the pressure without is practically constant and always greater than that within the thorax, the conditions are favorable to the flow of blood toward the heart. As in inspiration, the pressure on the great veins and the heart is diminished, and, as these organs are not rigid, they tend to expand within the thorax, thus favoring an onward flow. But the opposite effect would follow as regards the large arteries. Their expansion must tend to withdraw blood. During expiration the conditions are reversed. The effects on the great veins can be observed by laying them bare in the neck of an animal, when it may be seen that during inspiration they become partially collapsed, and refilled during expiration. In consequence of the marked thickness of the coats of the great arteries, the effect of changes in intra-thoracic pressure must be slight. The comparatively thin-walled auricles act somewhat as the veins, and it is likely that the increase of pressure during expiration must favor, so far as it goes, the cardiac systole.

More blood, then, entering the right side of the heart during inspiration, more will be thrown into the systemic circulation, unless it be retained in the lungs, and, unless the effect be counteracted, the arterial pressure will rise, and, as all the conditions are reversed during expiration, we look for and find exactly opposite results. The lungs themselves, however, must be taken into the account. During inspiration room is provided for an increased quantity of blood, the resistance to its flow is lessened, hence more blood reaches the left side of the heart. The *immediate* effect would be, notwithstanding, some diminution in the quantity flowing to the left heart, in consequence of the sudden widening of the pulmonary vessels, the reverse of which would follow during expiration; hence the period of highest intra-thoracic pressure is after the onset of the expiratory act. During inspiration the descent of the diaphragm compressing the abdominal organs is thought to force on blood from the abdominal veins into the thoracic vena cava.

That the respiratory movements do exert in some way a pronounced effect on the circulation the student may demon-

strate to himself in the following ways: 1. After a full inspiration, close the glottis and attempt to expire forcibly, keeping the fingers on the radial artery. It may be noticed that the pulse is modified or possibly for a moment disappears. 2. Reverse the experiment by trying to inspire forcibly with closed glottis after a strong expiration, when the pulse will again be found to vary. In the first instance, the heart is comparatively empty and hampered in its action, intra-thoracic pressure being so great as to prevent the entrance of venous blood by compression of the heart and veins, while that already within the organ and returning to it from the lungs soon passes on into the general system, hence the pulseless condition. The explanation is to be reversed for the second case. The heart's beat is modified, probably reflexly, through the cardio-inhibitory center, for the changes in the pulse-rate do not occur when the vagi nerves are cut, at least not to nearly the same extent.

Comparative.—It may be stated that the cardiac phenomena referred to in this section are much more marked in some animals than in others. Very little change may be observed in the pulse-rate in man, while in the dog it is so decided that one observing it for the first time might suppose that such pronounced irregularity of the heart was the result of disease; though even in this animal there are variations in this respect with the breed, age, etc.

We must now direct attention to certain facts which have been very differently interpreted.

During artificial respiration, when air is pumped into the chest by a bellows, it follows, of course, that all the usual pressure conditions are reversed—e. g., the inspiratory pressure is greater than the expiratory.

If artificial respiration, in an animal under experiment, be stopped, it may be noticed that there is at first a steady rise of blood-pressure; but presently certain undulations in the respiratory tracings may be observed, known as Traube-Hering curves; and these will appear even when the vagi nerves are cut, and disappear only with the fall of blood-pressure that ensues with the exhaustion of the animal.

If the spinal cord has been divided, the tracings may still be obtained, though the effect is not so marked. These are the phenomena, but there is much divergence of opinion as to their cause. Some maintain that mechanical effects suffice to explain them, though the majority are not of this opinion, but believe them due to rhythmical variations in the caliber of the arteri-

oles affected through vaso-motor nerves in obedience to the medullary center which operates by their agency; and that

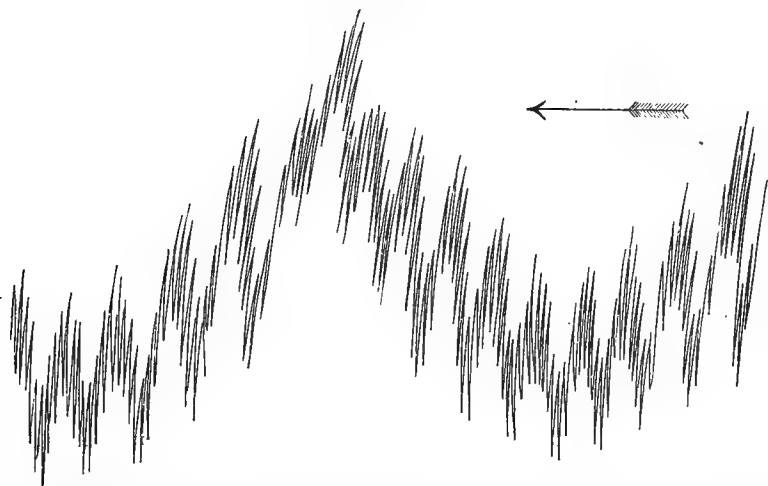

FIG. 320.—Tracings of blood-pressure in rabbit to show Traube-Hering curves (after Foster). The widest undulations indicate Traube Hering curves; those next in size, effects of respiration; and the smallest, of the pulse.

when this center is disabled its subordinates in the spinal cord take upon them the task. It has also been suggested that there may be a local vaso-motor mechanism acted upon by the venous blood or that the muscle-cells themselves may be influenced by the unnatural condition of the blood in asphyxia.

These curves, however, also appear during respiration that deviates but little from the normal.

It is to be borne in mind that the tracings on which we have based our reasoning do not represent what takes place in every mode of breathing. The subject is one of great complexity. Doubtless mechanical explanations go a long way here, but they are so mixed up with factors that play a part more or less prominent, though difficult to isolate in individual instances, and in no wise to be explained as other than vital effects, that one must exercise the usual caution; the more so as it is found upon actual experiment that the outcome, as regards blood-pressure, is not always quite what would have been expected, reasoning from the principles of physics alone.

That there are rhythms within rhythms in the vascular and respiratory system, rendering the subject complex beyond the power of experiments fully unravel, is a conviction that we think will deepen in the minds of physiologists.

The Respiration and Circulation in Asphyxia.—A most instructive experiment may be arranged thus:

Let an anæsthetized rabbit, cat, or such-like animal, have the carotid of one side connected with a glass tube as before described (page 229), by which the blood-pressure and its changes may be indicated, and, when the normal respiratory acts have been carefully observed, proceed to notice the effects on the blood-pressure, etc., of pumping air into the chest by a bellows, of hindering the ingress of air to a moderate degree, and of struggling. With a small animal it will be difficult to observe the respiratory effects on the blood-pressure by simply watching the oscillations of the fluid in the glass tube, but this is readily enough made out if more elaborate arrangements be made, so that a graphic tracing may be obtained.

But the main events of asphyxia may be well (perhaps best) studied in this manner:

Let the trachea be occluded (ligatured). At once the blood-pressure will be seen to rise and remain elevated for some time, then gradually fall to zero. These changes are contemporaneous with a series of remarkable manifestations of disturbance in the respiratory system as it at first appears, but in reality due to wide-spread and profound nutritive disturbance. So far as the breathing is concerned, it may be seen to become more rapid, deeper, and labored, in which the expiratory phase becomes more than proportionably marked (dyspnœa); this is followed by the gradual action of other muscles than those usually employed in respiration, until the whole body passes into a terrible convulsion—a muscle-storm in consequence of a nerve-storm. When this has lasted a variable time, but usually about one minute, there follows a period of exhaustion, during which the subject of the experiment is in a motionless condition, interrupted by an occasional respiration, in which inspiration is more pronounced than expiration; and, finally, the animal quietly stretches every limb, the sphincters are relaxed, there may be a discharge of urine or fæces from peristaltic movements of the bladder or intestines, and death ends a striking scene. These events may be classified in three stages, though the first and second especially merge into one another: 1. Stage of dyspnœa. 2. Stage of convulsions. 3. Stage of exhaustion.

It is during the first two stages that the blood-pressure rises, and during the third that it sinks, due in the first instance chiefly to excessive activity of the vaso-motor center, and in

the second to its exhaustion and the weakening of the heart-beat.

These violent movements are owing, we repeat, to the action of blood deficient in oxygen on the respiratory center (or centers), leading to inordinate action followed by exhaustion.

The duration of the stages of asphyxia varies with the animal, but rarely exceeds five minutes. In this connection it may be noted that newly-born animals (kittens, puppies) bear immersion in water for as much as from thirty to fifty minutes, while an adult dog dies within four or five minutes. This is to be explained by the feeble metabolism of new-born mammals, which so slowly uses up the vital air (oxygen).

If the chest of an animal be opened, though the respiratory muscles contract as usual there is, of course, no ventilation of the lungs, which lie collapsed in the chest; and the animal dies about as quickly as if its trachea were occluded. It passes through all the phases of asphyxia as in the former case; but additional information may be gained. The heart is seen to beat at first more quickly and forcibly, later vigorously though slower, and finally both feebly and irregularly, till the ventricles, then the left auricle, and finally the right auricle cease to beat at all or only at long intervals. The terminations of the great veins (representing the *sinus venosus*) beat last of all.

At death the heart and great veins are much distended with blood, the arteries comparatively empty. Even after *rigor mortis* has set in, the right heart is still much engorged.

These phenomena are the result of the operation of several causes. The increasingly venous blood at first stimulates the heart probably directly, in part at least, but later has the contrary effect. The nutrition of the organ suffers from the degraded blood, from which it must needs derive its supplies. The cardio-inhibitory center probably has a large share in the slowing of the heart, if not also in quickening it. Whether the accelerator fibers of the vagus or sympathetic play any part is uncertain. The increase of peripheral resistance caused by the action of the vaso-motor center makes it more difficult for the heart to empty its left side and thus receive the venous blood as it pours on. At the same time the deep inspirations (when the chest is unopened) favor the onflow of venous blood; and in any case the whole venous system, including the right heart, tends to become engorged from these several causes acting together. The heart gives up the struggle, unable to maintain it, but not so long as it can beat in any part.

The share which the elasticity of the arteries takes in forcing on the blood when the heart ceases, and the contraction of the muscular coat of these vessels, especially the smaller, must not be left out of the account in explaining the phenomena of asphyxia and the *post-mortem* appearances.

Pathological.—The importance of being practically as well as theoretically acquainted with the facts of asphyxia is very great.

The appearance of the heart and venous system gives unequivocal evidence as to the mode of death in any case of asphyxia; and the contrast between the heart of an animal bled to death, or that has died of a lingering disease, and one drowned, hanged, or otherwise asphyxiated, is extreme.

We strongly recommend the student to asphyxiate some small mammal placed under the influence of an anæsthetic, and to note the phenomena, preferably with the chest opened; and to follow up these observations by others after the onset of *rigor mortis*.

PECULIAR RESPIRATORY MOVEMENTS.

Though at first sight these seem so different, and are so as regards acts of expression, yet from the respiratory point of view they resemble each other closely; they are all reflex, and, of course, involuntary. Many of them have a common purpose, either the better to ventilate the lungs, to clear them of foreign bodies, or to prevent their ingress.

Coughing, in which such a purpose is evident, is made up of several expiratory efforts preceded by an inspiratory act. The afferent nerve is usually the vagus or laryngeal, but may be one or more of several others.

The glottis presents characteristic appearances, being closed and then opened suddenly, the mouth being kept open.

Coughing is often induced in attempting to examine the ear with instruments. (Reflex act.)

Laughing is very similar to the last, so far as the behavior of the glottis is concerned, though it usually acts more rapidly, of course. Several expirations follow a deep inspiration.

Crying is essentially the same as laughing, but the facial expression is different, and the lachrymal gland functions excessively, though with some persons this occurs during laughter also.

Sobbing is made up of a series of inspirations, in which the glottis is partially closed, followed by a deep expiration.

Yawning involves a deep-drawn, slow inspiration, followed by a more sudden expiration, with a well-known depression of the lower jaw and usually stretching movements.

Sighing is much like the preceding, though the mouth is not opened widely if at all, nor do the stretching movements commonly occur.

Hiccough is produced by a sudden inspiratory effort, though fruitless, inasmuch as the glottis is suddenly closed. It is spoken of as spasm of the diaphragm, and when long continued is very exhaustive.

Sneezing is the result of a powerful and sudden expiratory act following a deep inspiration, the mouth being usually closed by the anterior pillars of the fauces against the outgoing current of air, which then makes its exit through the nose, while the glottis is forcibly opened after sudden closure. It will be noticed that in most of these acts the glottis is momentarily closed, which is never the case in mammals during quiet respiration.

This temporary occlusion of the respiratory passages permits of a higher intrapulmonary pressure, which is very effective in clearing the passages of excess of mucus, etc., when the glottis is suddenly opened. Though the acts described are all involuntary, they may most of them be imitated and thus studied deliberately by the student. It will also appear, considering the many ways in which some if not all of them may be brought about, that if the medullary center is responsible for the initiation of them, it must be accessible by numberless paths.

Comparative.—Few of the lower animals cough with the same facility as man, while laughing is all but unknown, crying and sobbing rare, though the whining of dogs is allied to the crying of human beings.

Sneezing seems to be voluntary in some animals, as squirrels, when engaged in toilet operations, etc.

Barking is voluntary, and in mechanism resembles coughing, the vocal cords being, however, more definitely employed, as also in growling.

Bawling, neighing, braying, etc., are made up of long expiratory acts, preceded by one or more inspirations. The vocal cords are also rendered tense.

SPECIAL CONSIDERATIONS.

Pathological and Clinical.—The number of diseases that lessen the amount of available pulmonary tissue, or hamper the movements of the chest, are many, and only the briefest reference can be made to a few of them.

Inflammation of the lungs may render a greater or less portion of one or both lungs solid; inflammation of the *pleura* (pleuritis, pleurisy) by the dryness, pain, etc., may restrict the thoracic movements; *phthisis* may solidify or excavate the lungs, or by pleuritic inflammation glue the costal and pulmonary pleural surfaces together; *bronchitis* clog the tubes and other air-passages with altered secretions; *emphysema* (distention of air-cells) may destroy elasticity of parts of the lung; *pneumothorax* from rupture of the lung-tissue and consequent accumulation of gases in the pleural cavity, or pleurisy with effusion, render one lung all but useless from pressure. In all such cases Nature attempts to make up what is lost in amplitude by increase in rapidity of the respiratory movements. It is interesting to note too how the other lung, in diseased conditions, if it remain unaffected, enlarges to compensate for the loss on the opposite side. When the muscles are weak, especially if there be hindrance to the entrance of air while the thoracic movements are marked, there may be bulging inward of the intercostal spaces.

Normally, this would also occur, as the intra-thoracic pressure is less than the atmospheric, were it not for the fact that the intercostal muscles when contracting have a certain resisting power.

The imperfect respiration of the moribund, permitting the accumulation of carbonic anhydride with its soporific effects, smooths the descent into the valley of the shadow of death; so that there may be to the uninitiated the appearance of a suffering which does not exist, consciousness itself being either wholly or partially absent. The dyspnoea of anæmic persons, whether from sudden loss of blood or from imperfect renewal of the hæmoglobin, shows that this substance has a respiratory function; while in forms of cardiac disease with regurgitation, etc., the blood may be imperfectly oxidized, giving rise to labored respiration.

Personal Observation.—As hinted from time to time during the treatment of this subject, there is a large number of facts the student may verify for himself.

A simple way of proving that CO_2 is exhaled is to breathe (blow) into a vessel containing some clear solution of quicklime (CaO), the turbidity showing that an insoluble salt of lime (CaCO_3) has been formed by the addition of this gas.

The functions of most of the respiratory muscles, the phenomena of dyspnoea, apnoea (by a series of long breaths), partial asphyxia by holding the breath, and many other experiments, simple but *convincing*, will occur to the student who is willing to learn in this way.

The observation of respiration in a dreaming animal (dog) will show how mental occurrences affect the respiratory center in the absence of all the usual outward influences. The respiration of the domestic animals, of the frog, turtle, snake, and fish are easily watched if these cold-blooded animals be placed for observation beneath a glass vessel. Their study will teach how manifold are the ways by which the one end is attained. Compare the tracings of Fig. 313.

Evolution.—A study of embryology shows that the respiratory and circulatory systems develop together; that the vascular system functions largely as a respiratory system also in certain stages, and remains such, from a physiological point of view, throughout embryonic life.

The changes that take place in the vascular system—the heart, especially—of the mammal when the lungs have become functionally active at birth, show how one set of organs modifies the other.

When one considers, in addition to these facts, that the digestive as well as the vascular and respiratory organs are represented in one group of structures in a jelly-fish, and that the lungs of the mammal are derived from the same mesoblast as gives rise to the digestive and circulatory organs, many of the relations of these systems in the highest groups of animals become intelligible; but unless there be descent with modification, these facts, clear enough from an evolutionary standpoint, are isolated and out of joint, bound together by no common principle that satisfies a philosophical biology.

It has been found that in hunting-dogs and wild rabbits the vagus is more efficient than in other races of dogs and in rabbits kept in confinement; and possibly this may in part account for the greater speed and especially the endurance of the former. The very conformation of some animals, as the greyhound, with his deep chest and capacious lungs, indicates an unusual respiratory capacity.

The *law of habit* is well illustrated in the case of divers, who can bear deprivation of air longer than those unaccustomed to such submersion in water. Greater toleration on the part of the respiratory center has probably much to do with the case, though doubtless many other departures from the normal occur, either independently or correlated to the changes in the respiratory center.

Summary of the Physiology of Respiration.—The purpose of respiration in all animals is to furnish oxygen for the tissues and remove the carbonic anhydride they produce, which in all vertebrates is accomplished by the exposure of the blood in capillaries to the atmospheric air, either free or dissolved in water. A membrane lined with cells always intervenes between the capillaries and the air.

The air may be pumped in and out, or sucked in and forced out.

Respiration in the Mammal.—The air enters the lungs, owing to the enlargement of the chest in three directions by the action of certain muscles. It leaves the lungs because of their own elastic recoil and that of the chest-wall chiefly. Inspiration is active, expiration chiefly passive.

The diaphragm is the principal muscle of respiration. In some animals there is a well-marked facial and laryngeal as well as thoracic respiration. Respiration is rhythmical, consisting of inspiration, succeeded without appreciable pause by expiration, the latter being in health of only slightly longer duration. There is also a definite relation between the number of respirations and of heart-beats. According as respiration is normal, hurried, labored, or interrupted, we describe it as *eupnœa*, *hyperpnœa*, *dyspnœa*, and *apnœa*. The intra-thoracic pressure is never equal to the atmospheric—i. e., it is always negative—except in forced expiration; and the lungs are never collapsed so long as the chest is unopened. The expired air differs from that inspired in being of the temperature of the body, saturated with moisture, and containing about 4 to 5 per cent less oxygen and 4 per cent more carbonic anhydride, besides certain indifferently known bodies, the result of tissue metabolism, excreted by the lungs.

The quantity of air actually moved by a respiratory act, as compared with the total capacity of the respiratory organs, is small; hence a great part must be played by diffusion. The portion of air that can not be removed from the lungs by any respiratory effort is relatively large.

It is customary to distinguish tidal, complementary, supplementary, and residual air.

The vital capacity is estimated by the quantity of air the respiratory organs can move, and is very variable.

The blood is *the* respiratory tissue, through the mediation of its red cells, by the hæmoglobin they contain. This substance is a ferruginous proteid, capable of crystallization, and assuming under chemical treatment many modifications. When it contains all the oxygen it can retain, it is said to be saturated, and is called oxy-hæmoglobin, in which form it exists (with some reduced hæmoglobin) in arterial blood, and to a lesser extent in venous blood, which differs from arterial in the relative proportions of hæmoglobin (reduced) it contains, as viewed from the respiratory standpoint.

Oxy-hæmoglobin does not assume or part with its oxygen, according to the Henry-Dalton law of pressures, nor is this gas in a state of ordinary chemical combination. It is found that the oxygen tension of the blood is lower and that of carbonic anhydride higher than in the air of the alveoli of the lungs, while the same may be said of the tissues and the blood respectively. This has been, however, recently again denied.

Respiration is a vital process, though certain physical conditions (temperature and pressure) must be rigidly maintained in order that the gaseous interchanges shall take place. Respiration is always fundamentally bound up with the metabolism of the tissues themselves. All animal cells, whether they exist as unicellular animals (*Amœba*) or as the components of complex organs, use up oxygen and produce carbonic dioxide. Respiratory organs, usually so called, and the respiratory tissue *par excellence* (the blood) are only supplementary mechanisms to facilitate tissue respiration. Carbonic anhydride exists in blood probably in combination with sodium salts, though the whole matter is very obscure.

Respiration, like all the other functions of the body, is controlled by the central nervous system through nerves. The medulla oblongata is chiefly concerned, and especially one small part of it known as the respiratory center. It is possible, even probable, that there are subordinate centers in the cord, which, under peculiar circumstances, assume importance; but how far they act in concert with the medullary center, or whether they act at all when normal conditions prevail, is an open question.

The vagus is the principal afferent respiratory nerve. The

efferent nerves are the phrenics, intercostals, and others supplying the various muscles used in moving the chest-walls, etc.

The respiratory center is automatic, but its action is susceptible of modification through afferent influences taking a variety of paths. The respiratory, vaso-motor, and cardio-inhibitory centers seem to act somewhat in concert.

Blood-pressure is being constantly modified by the respiratory act, rising with inspiration and sinking with expiration. In some animals the heart-beat also varies with these phases of respiration, becoming slow and irregular during expiration. Into the causation of these changes both mechanical and nervous factors enter, and make a very complex mesh, which we can at present but imperfectly unravel. When the access of air to the tissues is prevented, a series of stages of respiratory activity and decline, accompanied by pronounced changes in the vascular system, are passed through, known as asphyxia.

Three stages are distinguishable: one of dyspnoea, one of convulsions, and one of exhaustion—while at the same time there is a rise of blood-pressure during the first two, and a decline during the third, accompanied by marked alterations in the cardiac rhythm.

PROTECTIVE AND EXCRETORY FUNCTIONS OF THE SKIN.

As has been intimated from time to time, thus far, as a result of the metabolism of the tissues, certain products require constant removal from the blood to prevent poisonous effects. These substances are in all probability much more numerous than physiological chemistry has as yet distinctly recognized or, at all events, isolated. Quantitatively considered, the most important are carbonic anhydride, water, urea, and, of less importance, perhaps, certain salts.

In many invertebrates and in all vertebrates several organs take part in this work of elimination of waste products or purification of the blood, one set of which—the respiratory—we have just studied; and we now continue the consideration of the subject of excretion, this term being reserved for the process of separating harmful products from the blood and discharging them from the body.

We strongly recommend the student to make the study of excretion comparative in the sense of noting how one organ engaged in the process supplements another. A clear under-

standing of this relation even to details makes the practice of medicine more scientific and practically effective, and gives physiology greater breadth.

The skin has a triple function: it is protective, excretory, sensory, and, we may add, nutritive (absorptive) and respiratory, especially in some groups of animals.

As a sensory organ, the skin will receive attention later.

Protective Function of the Skin.—Comparative.—Among many groups of invertebrates the principal use of the exterior covering of the body is manifestly protection. Among these forms, an internal skeleton being absent, the exo-skeleton is developed externally, and serves not only for protection, but for the attachment of muscles, as seen in crustaceans and insects. But this part of the subject is too large for detailed treatment in such a work as this. Turning to the vertebrates, we see scales, bony plates, feathers, spines, hair, etc., most of them to be regarded as modifications of the epidermis, always useful, and frequently also ornamental.

Primitive man was probably much more hirsute than his mod-

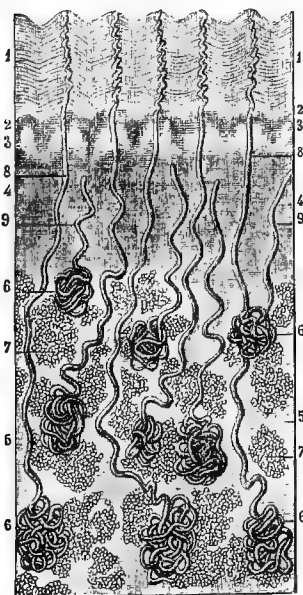

FIG. 321.

FIG. 321.—Sudoriparous glands. 1 × 20 (After Sappey.) 1, 1, epidermis; 2, 2, mucous layer; 3, 3, papillæ; 4, 4, derma; 5, 5, subcutaneous areolar tissue; 6, 6, 6, 6, sudoriparous glands; 7, 7, adipose vesicles; 8, 8, excretory ducts in derma; 9, 9, excretory ducts divided.

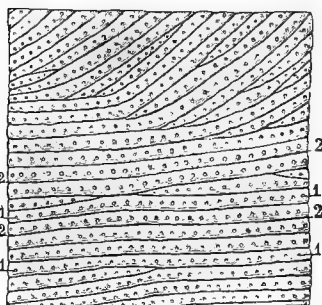

FIG. 322.

ern representative; and, though the human subject is at present provided with a skin in which protective functions are at their lowest, still the epidermis does serve such a purpose, as

all have some time realized when it has been accidentally removed by blistering, etc.

Taking the structure of the skin of man as representing that of mammals generally, certain points claim attention from the physiologist. Its elasticity, the failure of which in old age accounts for wrinkles; its epidermal covering, made up of numerous layers of cells; its coiled and spirally twisted sudoriferous glands, permitting of movements of the skin without harm to these structures; its hair-follicles and associated sebaceous glands, the fatty secretion of which keeps the hair and the skin generally soft and pliable.

The muscles of the skin, which either move it as a whole or erect individual hairs, play an important part in modifying expression, well seen in the whole canine tribe and many others.

There are several modifications of the sebaceous glands that furnish highly odoriferous secretions, as in the civet cat, the skunk, the musk-deer, and many lower vertebrates. In some, these are protective (skunk); in others, though they may not be agreeable to

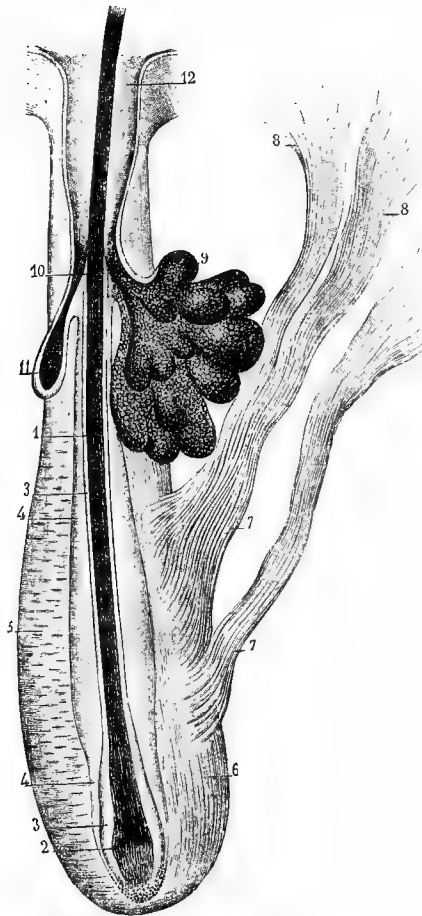

FIG. 323.—Hair and hair-follicle (after Sappey). 1, root of hair; 2, bulb of hair; 3, internal root-sheath; 5, membrane of hair-follicle; 6, external membrane of follicle; 7, 7, muscular bands attached to follicle; 8, 8, extremities of bands passing to skin; 9, compound sebaceous gland, with duct (10) opening into upper third of follicle; 11, simple sebaceous gland; 12, opening of hair-follicle.

the senses of man, they are doubtless attractive to the females of the same tribe, and are to be regarded as important in "sexual selection," being often confined to the males alone.

Ear-wax and the Meibomian secretion are the work of modified sebaceous glands; as also the oil-glands so highly developed in birds, especially aquatic forms, of which these creatures make great use in preserving their feathers from wetting.

THE EXCRETORY FUNCTION OF THE SKIN.

Sweating in man has been studied by inclosing the greater part of the body or a single limb in a caoutchouc or other form of impermeable covering and exposing the subject to various degrees of heat; but, apart from errors in collecting, weighing, etc., such sweating must be regarded as somewhat abnormal.

It is clear, however, that the quantity of matter discharged through the skin is large—greater than by the lungs (about as 7 to 11), though the amount is very variable, depending on the degree of activity of other related excreting organs, as the lungs and kidneys, and largely upon the temperature as a physical condition.

When the watery vapor is carried off, before it can condense, the perspiration is said to be *insensible*; when small droplets become visible, *sensible*. As to whether the one or the other is predominant will, of course, depend on the rapidity of renewal of the air, its humidity, and its temperature. Apart from the temperature, the amount of sweat is influenced by the quality and quantity of food and, especially, of drink taken, the amount of exercise, and psychic conditions; not to speak of the effect of drugs, poisons, or disease.

Perspiration in man is a clear fluid, mostly colorless, with a characteristic odor, devoid of morphological elements (except epidermal scales), and alkaline in reaction. It may be acid from the admixture of the secretion of the sebaceous glands.

Its solids (less than 2 per cent) consist of sodium salts, mostly chlorides, cholesterin, neutral fats, and traces of urea. The acids of the sweat belong to the fatty series (acetic, butyric, formic, propionic, caprylic, caproic, etc.).

Pathological.—The sweat may contain blood, proteids, abundance of urea (in cholera), uric acid, oxalates, sugar, lactic acid, bile, indigo and other pigments. Many medicines are eliminated in part through the skin.

Respiration by the Skin.—**Comparative.**—In reptiles and batrachians, with smooth, moist skin, the respiratory functions of this organ are of great importance; hence these animals can live long under water.

It is estimated that in the frog the greater part of the carbonic anhydride of the body-waste is eliminated by the skin. Certainly frogs can live for days immersed in a tank supplied with running water; and it is a significant fact that in this animal the vessel that gives rise to the pulmonary artery supplies also a cutaneous branch.

The respiratory capacity of the skin in man and most mammals is comparatively small under *ordinary* circumstances. The amount of carbonic anhydride thus eliminated in twenty-four hours in man is estimated at not more than 10 grammes. It varies greatly, however, with temperature, exercise, etc.

The skin is highly vascular in mammals, and its importance as a heat regulator is thus very great.

When an animal is varnished over, its temperature rapidly falls, though heat production is in excess. From the fact that life may be prolonged by diminishing loss of heat through wrapping up the animal in cotton-wool, it is inferred that depression of the temperature is, at all events, one of the causes of death. Though the subject is obscure, it is likely that the retention of poisonous products so acts as to derange metabolism, as well as poison directly, which might thus lead to the disorganization of the machinery of life to the point of disruption or death. It is also possible that the reduction of the temperature from dilatation of the cutaneous vessels may be so great that the animal is cooled below that point at which the vital functions can continue.

THE EXCRETION OF PERSPIRATION.

In secretion in the wider sense we find usually certain nervous and vascular effects associated. The vessels supplying the gland are dilated during the most active phase, and at the same time nervous impulses are conveyed to the secreting cells which stimulate them to action. There is a certain proportion of water given off by transpiration; but the sweat, as a whole, even the major part of the water, is a genuine secretion, the result of the metabolism of the cells.

Certain experimental facts deserve consideration in this connection: 1. If, in the cat, the sciatic nerve be divided and its distal end stimulated, even when the vessels of the leg are ligatured, the corresponding foot sweats. 2. The vessels being untouched and atropin injected into the blood, no sweating occurs on stimulation of the nerve, though the vessels of the foot

dilate. 3. If a kitten with divided sciatic, and as a consequence dilated blood-vessels in the corresponding limb, be placed in a warm oven, the other feet will sweat, while the one the nerves going to which have been divided remains dry. 4. Perspiration will take place in a cat that has just died under the circumstances mentioned in 1. From these experiments it is clear that nervous influences alone, in the absence of any vascular changes, or in the total deprivation of blood, suffice to induce the secretion of perspiration.

If the central stump of the divided sciatic be stimulated, sweating of the other limbs follows, showing that perspiration may be a reflex act. It is found that stimulation of the peripheral end of the divided cervical sympathetic leads to sweating on the corresponding side of the face.

Human Physiology.—Certain nerves (e. g., the cervical sympathetic) have been stimulated with results similar to those obtained in other animals. We think these experiments and certain pathological phenomena, to be presently mentioned, of importance beyond their immediate application. They seem to show the influence of nerves over vital processes in the clearest way, and render it probable that this is the essential element in the highest vertebrates, and not the blood-supply, which, though important, is subsidiary. The path of the sweat-nerves is somewhat similar to that of the vaso-motor fibers, running mostly in the sympathetic in some part of their course. Whether there is a dominant center in the medulla and subordinate ones in the cord is a matter of uncertainty; though, that the cerebrum can exercise a powerful influence over the sudorific glands is evident from the effect of emotions.

Certain drugs seem to act on the centers through the blood; others on either the nerve terminals or the gland-cells themselves. It is true that some of these will induce sweating after the nerves have been divided, though conclusions as to the *normal* action of a part from such experiments must be drawn with the greatest caution. In our opinion they are rather suggestive than demonstrative in themselves, and the views we entertain of normal function should be formed from a consideration of all the evidence rather than that from a single experiment, however striking in itself.

Sweating during dyspnoea and from fear, when the cutaneous surfaces are pale, as well as in the moribund, shows also the independent influence over the sudorific glands of the nervous system. Heat induces sweating by acting both reflexly and

directly on the sweat-centers we may suppose. Unilateral sweating is known as a pathological as well as experimental phenomenon. Perspiration may be either increased or diminished in paralyzed limbs, according to circumstances. It is possible that there is a paralytic secretion of sweat as of saliva. The subject is very intricate and will be referred to again on account of the light it throws on metabolic processes generally.

Absorption by the skin in man and other mammals is, under natural conditions probably very slight, as would be expected when it is borne in mind that the true skin is covered by several layers of cells, the outer of which are hardened.

Ointments may unquestionably be forced in by rubbing; and perhaps absorption may take place when an animal's tissues are starving, and food can not be made available through the usual channels. It is certain that abraded surfaces are a source of danger, from affording a means of entrance for disease-producing substances or for germs.

Comparative.—It is usually stated in works on physiology that the horse sweats profusely, the ox less so; the pig in the snout; and the dog, cat, rabbit, rat, and mouse, either not at all or in the feet (between the toes) only. That a closer observation of these animals will convince any one that the latter statements are incorrect, we have no doubt. These animals, it is true, do not perspire *sensibly* to any great extent; but to maintain that their skin has no excretory function is an error.

Summary.—The skin of the mammal has protective, sensory, respiratory, and excretory functions. The respiratory are insignificant under ordinary circumstances in this group, though well marked in reptiles and especially in batrachians (frog, menobranchus). Sweating is probably dependent on the action of centers situated in the brain and spinal cord, through nerves that run generally in sympathetic tracts during some part of their course. While the function of sweating may go on independently of abundant blood-supply, it is usually associated with increased vascularity.

Sweat contains a very small quantity of solids, is alkaline in reaction when pure, but liable to be acid from the admixture of sebaceous matter that has undergone decomposition. Sebum consists chiefly of olein, palmitin, soaps, cholesterin, and extractives of little known composition. The salty taste of the perspiration is due chiefly to sodium chloride, and its smell to volatile fatty acids; especially is this so of the sweat of certain parts of the body of man and other mammals.

The functional activity of the skin varies with the temperature, moisture, etc., of the air and certain internal conditions; especially is it important to remember that it is one of a series of excretory organs which act in harmony to eliminate the waste of the body, so that when one functions more the other may and usually does function less.

The protective function of the skin and its modified epithelium (hair, horns, nails, feathers, etc.) is in man slight, but very important in many other vertebrates, among which provision against undue loss of temperature is one of the most constantly operative, and enables a vast number of groups of animals to adapt successfully to their varying surroundings.

EXCRETION BY THE KIDNEY.

The kidney in man and other mammals may be described as a very complex arrangement of tubes lined with many different forms of secreting cells, surrounded by a great mesh-work of capillaries, bound together by connective tissue, the quantity varying with the animal, and the whole inclosed in a capsule. The organ is well supplied with lymphatics and nerves. Though the tubes are so complex, the kidney may be divided into zones which contain mostly but one kind of tubule.

Comparative.—Among the lowest forms, the *Infusorians* and *Celenterates*, excretory organs have not been definitely traced. In the *Vermes*, organs known as *nephridia* (segmental organs, see Figs. 253, 257) are supposed to act the part of the kidney in some fashion. These are long, often coiled

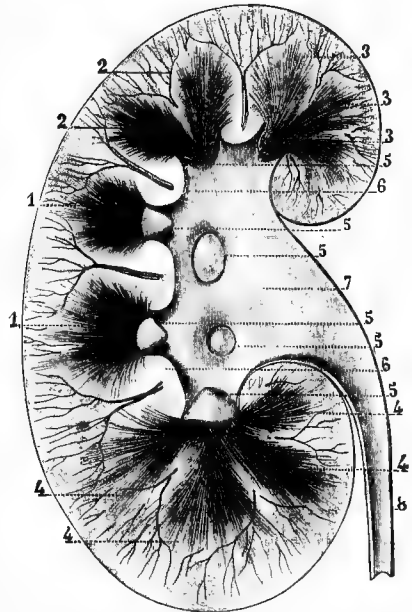

FIG. 324.—Vertical section of kidney (after Sappey). 1, 1, 2, 2, 3, 3, 3, 4, 4, 4, 4, 4, 4, pyramids of Malpighi; 5, 5, 5, 5, 5, 5, apices of pyramids, surrounded by calices; 6, 6, columns of Bertin; 7, pelvis of kidney; 8, upper extremity of ureter.

taceans as the crayfish the green gland is supposed to represent a kidney. It does not open into the body cavity like the preceding and the following form of the organ. It is well supplied with capillaries. The organ of Bojanus (Fig. 306) is the

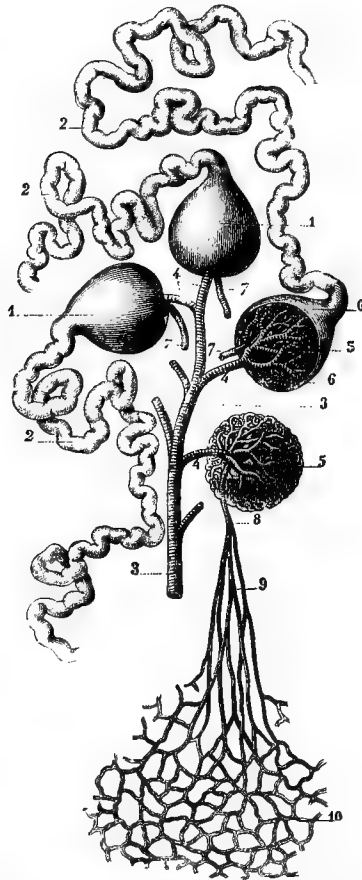

FIG. 326.—Blood-vessels of Malpighian bodies and convoluted tubes of kidney (after Sappey).
 1, 1, Malpighian bodies surrounded by capsules; 2, 2, 2, convoluted tubes connected with Malpighian bodies; 3, artery branching to go to Malpighian bodies; 4, 4, 4, branches of artery; 5, 5, 5, Malpighian bodies from which a portion of capsules has been removed; 6, 6, 6, Malpighian bodies from which a portion of capsules has been removed; 7, 7, 7, vessels passing out of Malpighian bodies; 8, vessel, branches of which (9) pass to capillary plexus (10).

main excretory channel in many groups of mollusks. In insects the long, coiled Malpighian tubules, which open into the intestine, are believed to secrete both bile and uric acid.

Among vertebrates, till the reptiles are reached, the kidney is a persistent Wolffian body, hence its more simple form.

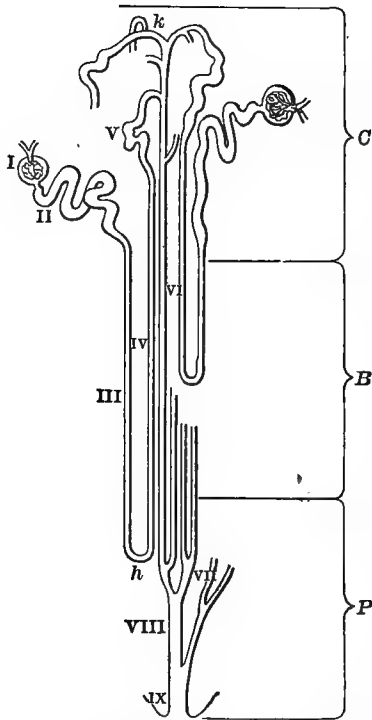

FIG. 327.—Diagrammatic representation of distribution of tubules of kidney (after Huxley). C, cortical region; B, boundary zone, containing large part of Henle's loops; P, papillary zone, in which are the main outflow tubules.

In most fishes the kidney is a very elongated organ, though in the lowest it consists of little more than tubules, coiling but slightly, ending by one extremity in a glomerulus and by the other opening into a long common efferent tube or duct. The glomerulus is, however, peculiar to the vertebrate kidney. The graded complexity in arrangement, etc., of the tubes is represented well in the figure below. It is a significant fact that the kidney of the human subject is lobulated in the embryo, which condition is persistent in some mammals (ruminants, etc.).

As the lungs are the organs employed especially for the elimination of carbonic anhydride, so the kidneys are above all others the excretors of the nitrogenous waste products of the body chiefly in the form of uric acid or urea. Before treating of secretion by the kidney

it will be well to examine into the physical and chemical properties of urine with some detail, especially on account of its great importance in the diagnosis of disease.

URINE CONSIDERED PHYSICALLY AND CHEMICALLY.

Urine is naturally a fluid of very variable composition, especially regarded quantitatively—a fact to be borne in mind in considering all statements of the constitution of this fluid.

Specific Gravity.—Urine must needs be heavier than water, on account of the large variety of solids it contains. The average specific gravity of the urine for the twenty-four hours is 1015 to 1020. It is lowest in the morning and varies greatly with the quantity and kind of food eaten, the activity of the lungs and especially of the skin, with emotions, etc.

Color.—A light straw color, which is also very variable, being increased in depth either by the presence of an excess of pigment or a diminution of water. There are probably several pigments, among which occur *urobilin*, derived probably from bile pigment; *urochrome*, becoming red on oxidation; and *indican*, which may be oxidized to indigo.

The reaction of human urine is acid, owing to acid salts, especially acid sodium phosphate (NaH_2PO_4). There is usually but a trifling quantity, if any, of free acid in the urine when secreted. The acidity diminishes after meals, and the urine may be neutral or alkaline when the food is wholly vegetable, or unduly acid when the diet is entirely fleshy.

Quantity.—Usually about 1,500 c.c. or from 50 to 52 ounces (two pints) in twenty-four hours. This is, of course, like the specific gravity, highly variable, and frequently they run parallel with each other.

The following tabular statement will prove useful for reference:

Quantitative Estimation of the Constituents of the Urine for Twenty-four Hours (after Parkes).

	By an average man of 65 kilos.	Per 1 kilo of body weight.
	Grammes.	Grammes.
Water.....	1500.000	23.000
Total solids.....	72.000	1.1000
Urea.....	33.180	.5000
Uric acid.....	.555	.0084
Hippuric acid.....	.400	.0060
Creatinin.....	.910	.0140
Pigment, etc....	10.000	.1510
Sulphuric acid.....	2.012	.0305
Phosphoric acid.....	3.164	.0480
Chlorine.....	7.000	.1260
Ammonia.....	.770	
Potassium.....	2.500	
Sodium.....	11.090	
Calcium.....	.260	
Magnesium.....	.207	

Attention is directed more particularly to the preponderance among the solids of urea, and sodium chloride, for the latter is the form in which a large part of the sodium reappears. We may say that in round numbers about 35 grammes or 500 grains (2 to 3 per cent) of urea are excreted daily.

Nitrogenous Crystalline Bodies.—These are the derivatives of the metabolism of the body, and not in any appreciable degree drawn from the food itself. Besides urea, and of much less

importance, occurring in small quantities, are bodies that may be regarded as less oxidized forms of nitrogenous metabolism, such as creatinin, xanthin, hypoxanthin (sarkin), hippuric acid, ammonium oxalurate, and urea, $\text{CO} \left\{ \begin{array}{l} \text{NH}_2 \\ \text{NH}_2 \end{array} \right.$. The latter was first prepared artificially from ammonium cyanate, $\left. \begin{array}{l} \text{CN} \\ \text{NH}_4 \end{array} \right\} \text{O}$, with which it is isomeric.

When air has free access to urine for some time in a warm room, the urea becomes ammonium carbonate by hydration, probably owing to the influence of micro-organisms, thus: $\text{CO} (\text{NH}_2)_2 + 2 \text{H}_2\text{O} = (\text{NH}_4)_2 \text{CO}_3$; hence the strong ammonical smell of old urine, urinals, etc.

Uric acid ($\text{C}_5\text{H}_4\text{N}_4\text{O}_3$) occurs sparingly (see table), combined with sodium and ammonium chiefly as acid salts. Since these salts are not so soluble in cold as in warm water, they often fall as a sediment in the vessel in which the urine stands, and present a brick-red or fawn color.

Uric acid is itself rather insoluble in cold water or hydrochloric acid, though soluble in alkalis; hence it may be obtained by adding hydrochloric acid to the urine in the cold. When it is in excess it may separate out on standing, forming characteristic *colored* (dark-red) crystals, adhering to the sides of the vessel, floating on the top of the urine, or as a sediment at the bottom (like red-pepper grains).

Non-nitrogenous Organic Bodies.—Whether traces of sugar are normal in urine is as yet undetermined. Certain acids occur, at least frequently, in small quantities, and combined mostly with bases. Among these are lactic, formic, oxalic, succinic, etc. A series of well-known aromatic bodies occurs in urine, especially in that of the horse, cow, etc. These are phenol, cresol, pyrocatechin, which occur not free, but united with sulphuric acid.

Inorganic Salts.—These are mostly in simple solution, in urine; and not, as in some other fluids of the body, united with proteid bodies. The salts are chlorides, phosphates, sulphates, nitrates, and carbonates, the first three being the most abundant; the bases being sodium, potassium, calcium, magnesium. Since the earthy salts can not remain in solution in an alkaline fluid, they are usually found as a sediment when the urine loses its acid reaction. The phosphates are to be traced to the food, to the phosphorus of proteids, and to phosphorized fats (lecithin). The sulphates are derived from those of the food and from the sulphur of the proteids of the body. So much of the

carbonates as is not derived directly from a corresponding supply in the food may be traced to the oxidation of certain organic salts, as citrates, tartrates, etc.

Doubtless many bodies appear either regularly or occasionally in urine that have so far escaped detection, which are, like the poisonous exhalations of the lungs, not the less important because unknown to science.

Abnormal Urine.—There is not a substance in the urine that does not vary under disease, while the possible additions actually known are legion. These may be derived either from the blood or from the kidneys and other parts of the urinary tract. The kidneys seem to take upon themselves more readily than any other organ the duty of eliminating foreign matters from the body. But this aspect of the subject is too wide for detailed consideration in this work.

The student of medicine should be thoroughly familiar with the urine in its normal condition before he enters upon the examination of the variations produced by disease. This is not difficult, and much of it may be carried out with but a meager supply of apparatus. For this purpose, however, we recommend some work devoted to the chemical and microscopic study of the urine.

It greatly assists to remember a few points in regard to solubilities. From a physiological point of view, the urine and its variations, as the result of changes in the organism, may be observed with advantage in one's own person—e. g., the influence of food and drink, temperature, emotions, etc.

Comparative.—The urine of most vertebrates is of higher specific gravity than that of man. In fishes, reptiles, and birds, uric acid replaces urea, and is very abundant. In these animals most of this substance is white. The urine is passed with the fæces. Among mammals the urine of the carnivora is strongly acid, perhaps owing in great part to the flesh on which they feed; and abounds in phosphates and, in some instances, sulphates. The urine is so concentrated in some cases that we have known urea nitrate to crystallize out on the addition of nitric acid without requiring condensation.

The urine of the herbivora is alkaline, and abounds in salts of calcium, especially carbonates. It is also of high specific gravity, and grows rapidly dark in color when passed, owing probably to the presence of the aromatic compounds referred to above, derived from the food. In certain groups of invertebrates uric acid seems to be a normal excretion.

THE SECRETION OF URINE.

Among experimental facts from which important conclusions have been drawn are the following (when blood-pressure within the kidney is referred to, it will be understood that the glomeruli are meant): 1. Section of the spinal cord, which greatly lowers the general blood-pressure, is followed by diminution or total arrest of the secretion of urine. 2. Section of the renal nerves, and to a less extent of the splanchnics decreases the flow of urine. 3. Stimulation of the spinal cord after section of the above nerves (which raises the blood-pressure in the kidney by elevating the general blood-pressure) increases the flow of urine. 4. Certain diuretics increase the blood-pressure, either generally or in the kidney, while others act on the renal epithelium, apparently independently of blood-pressure.

By means of apparatus adapted to register the changes of volume the kidney undergoes, it is found that the kidney not only responds to every general change in blood-pressure, but

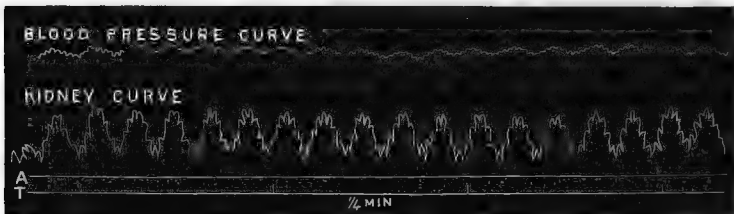

FIG. 328.—BP, blood-pressure curve; K, curve of the volume of the kidney; T, time-curve, intervals indicate a quarter of a minute; A, abscissa (Stirling, after Roy).

to each heart-beat—that is, its volume varies momentarily. This shows how sensitive it is to variations in blood-pressure.

From the above and other experiments it has been concluded that the secretion of urine is largely dependent on blood-pressure. Until very recently certain experiments (of Nussbaum) were considered as favoring the view that the activity of the glomeruli was of a wholly or greatly different character from that of the tubules. In the amphibia (frog, newt, etc.) there is a double renal blood-supply. The glomeruli derive their blood from the renal artery, and the tubules from the renal-portal system. The vein returning the blood from the lower extremity divides (Fig. 231) at the upper part of the thigh into two branches, one of which, entering the kidney, breaks up into

capillaries around the tubules, which inosculate to some extent with the vessels emerging from the glomeruli. It was found that when certain substances were injected into the blood they no longer appeared in the urine after the renal artery had been tied, from which it was concluded that they were secreted only by the glomeruli, and that the blood of the renal-portal vein did not find access to the glomeruli. This conclusion was a pretty bold leap, but there was some show of reason for it. More recently, however, these experiments have been demonstrated to be, to a certain extent, unreliable, and that the passage of blood from the venous capillaries backward can really take place, to some extent, after a time.

Theories regarding the secretion of urine may be divided into those that are almost wholly mechanical, partly mechanical, and purely secretory: 1. To the first class belongs that of Ludwig, which teaches that very dilute urine is separated from the blood in the glomeruli, and by a process of endosmosis and absorption of water by the tubular capillaries is gradually concentrated to the normal. 2. As an example of the second class is that of Bowman, who maintained that the greater part of the water and some of the more soluble and diffusible salts are separated by the glomeruli but the characteristic constituents of the urine by the epithelium of the renal tubules. 3. As an example of the third is the theory of Heidenhain, who attributed little to blood-pressure in itself, and much, if not the whole, to the secreting activity of the epithelium of the tubules more particularly. This physiologist showed that while ligature of a vein raised the blood-pressure within a glomerulus, it was not followed by any increase in the quantity of the secretion, but by its actual arrest. He also showed that injection of a colored substance (sodium sulphindigodate) into the blood, after the pressure had been greatly lowered by section of the spinal cord, led to its appearance in the urine; and microscopic examination showed that it had passed through the epithelial cells of the tubules, not of the glomeruli.

It is found, however, that after the removal of a ligature applied to the renal artery the urine is albuminous, showing that the cells have been plainly injured by the operation; hence Heidenhain's experiment described above is not valid against the blood-pressure theory. Moreover, too much must not be inferred from the action of foreign substances under the abnormal conditions of such an experiment. While some physiologists claim that the glomeruli are filtering mechanisms, they

explain that filtration is not to be understood in its ordinary laboratory acceptation, but that the glomeruli discriminate as to what they allow to pass, yet they in no way explain how this is done. They make the whole process depend on blood-pressure, and attribute little special action to the flat epithelium of the Malpighian capsules.

Though we can not admit the full force of Heidenhain's experiments as he interprets them, we still believe that his views are most in harmony with the general laws of biology and the special facts of renal secretion. Recently, after a repetition of Nussbaum's experiments, and the institution of others, it has been rendered clear that the mechanical theory of the work of the kidney can not hold, even of the glomeruli, which are shown to be, as we should have expected, true secreting organs. Now, there can be no doubt that blood-pressure is a most important determining condition here as in other secreting processes, in the mammal at all events; but whether of itself or because of the influence it has on the rapidity of blood-flow, it is difficult to determine; or rather whether solely to the latter, for that the constant supply of fresh blood is a regular condition of normal secretion there can be no doubt. Further, it seems probable that blood-pressure has more to do with the secretion of water than any other constituent of urine. But we maintain that it should be called a genuine secretion, and that nothing is gained by using the term "filtration"—on the contrary, that it is misleading, and tends to divert attention from the real though often hidden nature of vital processes. The facts of disease and the evidence of therapeutics, we think, all favor such a view of the work of the kidneys.

Nerves having an influence over the secretion of urine similar to those acting on the digestive glands have not yet been determined. The powerful influence of emotion, especially in those of unstable nervous system, over the secretion of urine shows that there must be nervous channels through which the nerve-centers act on the kidneys; though whether the results are not wholly dependent upon vaso-motor effects may be considered as an open question by many. We think such a view improbable in the highest degree. The most recent investigations would seem to show that the vaso-motor fibers run in the dorsal nerves, especially the eleventh, twelfth, and thirteenth, and that of these the vaso-constrictors are the best developed.

Pathological.—When the kidneys are excised, the ureters ligatured, or when the former are so diseased as to be inca-

pable of performing their functions, death is the result, being preceded by marked depression of the brain-centers passing into coma. Exactly which of the retained products brings about these results is not known. They are likely due to several, and it impresses on the mind the importance of those processes by which the constantly accumulating waste is eliminated. Uric acid when not removed from the blood and tissues is supposed to be the exciting cause of gout. An excess in the form of urates retained or deposited in certain parts, especially the joints, is frequently at all events an accompaniment of this disease.

THE EXPULSION OF URINE.

We now present in concise form certain facts on which to base opinions as to the nature of the processes by which the bladder is emptied.

It will be borne in mind that the secretion of urine is constant, though of course very variable; that the urine is conveyed in minute quantities by rhythmically contractile tubes (ureters) which open into the bladder obliquely; and that the bladder itself is highly muscular, the cells being arranged both circularly and obliquely, with a special accumulation of the circular fibers around the neck of the organ to form the *sphincter vesicæ*.

1. It is found that the pressure which the sphincter of the bladder can withstand in the dead is much less (about one third) than in the living subject.
2. We are conscious of being able to empty the bladder, whether it contains much or little fluid.
3. We are equally conscious of an urgency to evacuation of the vesical contents, according to the fullness of the organ, the quality of the urine, and a variety of other conditions.
4. Emotions may either retard or render micturition urgent.
5. In a dog, in which the cord has been divided in the dorsal region some months previously, micturition may be induced reflexly, as by sponging the anus.
6. In the paralyzed there may be retention or dribbling of urine.
7. In cases of urethral obstruction from a calculus, stricture, etc., there may be excessive activity of the muscular tissue of the bladder-walls.
8. Evacuation of the bladder may occur in the absence of consciousness (sleep).

The most obvious conclusions from these facts are that—1. The urine finds its way to the bladder partly through muscular (peristaltic) contractions of the ureters, partly through gravity,

in man at all events, and partly from the pressure within the tubules of the kidneys themselves. 2. The evacuation of urine *may* take place independently of the will (see 8), and is a reflex (5) act. 3. Micturition may be initiated by the will, which is usually the case, when by the action of the abdominal muscles a little urine is squeezed into the urethra, upon which afferent impulses set up contractions of the bladder by acting on the detrusor center of the cord and at the same time inhibit the center presiding over the sphincter (if such there be), permitting of its relaxation. 4. Emotions seem to interfere with the ordinary control of the brain-centers over those in the spinal cord. 5. It may be assumed that the normal tone of the sphincter of the bladder is maintained reflexly by the spinal cord. The unwonted muscular contraction associated with an obstruction to the outflow of urine may be in part of nervous origin, but is also, in all probability, owing in some degree to the muscle-cells resuming an independent contractility, due to what we recognize as the principle of reversion. The same is seen in the heart, ureters, and similar structures.

Pathological.—There may be incontinence of urine from paralysis, the cerebral centers being unable to control those in the spinal cord. Dribbling of urine may be due to retention in the first instance, the tone of the sphincter being finally overcome, owing to increase of pressure within the bladder. Overdistention of the bladder may arise in consequence of lack of tone in the muscular walls, though this is rare. *Strangury* is due to excessive action of the walls of the bladder and the sphincter, brought about reflexly, when the organ is unduly irritable, as in inflammation, after, the abuse of certain drugs (cantharides), etc.

Comparative.—In man the last drops of urine are expelled by the action of the bulbo-cavernosus muscle and perhaps some others. In the dog and many other animals the regulated and voluntary use of this muscle, marked in a high degree, produces that interrupted flow so characteristic of the micturition of these animals.

Summary.—Urine is in man a fluid of specific gravity 1015 to 1020, acid in reaction, pale yellow in color, and containing certain salts, pigments, and nitrogenous bodies. The chief of the latter is urea, which is excreted daily to the extent of about one ounce (500 grains).

The kidneys and skin especially supplement one another, and normally great activity of the one implies lessened ac-

tivity of the other. This is availed of in the treatment of disease.

Both the Malpighian capsules and the renal tubules have a true secretory function, though the larger part of the water of urine is secreted by the former. Blood-pressure is an important condition of secretion, though it is likely that this is so chiefly because it favors a rapid renewal of the blood circulating through the organ. Whether there are nerves that influence secretion directly, as in the case of the skin, is not determined.

Suppression of the renal functions leads to symptoms in which the nervous system is recognized as suffering to the extent often of coma, ending in death. The urine of most other animals is more concentrated than that of man; this secretion in carnivora being acid, and in herbivora alkaline in reaction when passed a short time.

Our information in regard to the kidneys has been derived experimentally chiefly from the study of the frog and a few of the domesticated mammals, especially the dog; and as regards some points of interest, so far as urine is concerned, from the bird (guano), and the horse, ox (aromatic compounds), etc. Man's urine has been thoroughly studied; but the nature of the act of renal secretion is in his case a matter of inference from the facts of pathology, clinical medicine, therapeutics, etc.

THE METABOLISM OF THE BODY.

In the widest sense the term *metabolism* may be conveniently applied to all the numerous changes of a chemical kind, resulting from the activity of the protoplasm of any tissue or organ. In a more restricted meaning it is confined to changes undergone by the food from the time it enters till it leaves the body, in so far as these are not the result of obvious mechanical causes. The sense in which it is employed in the present chapter will be plain from the context, though usually we shall be concerned with those changes effected in the as yet comparatively unprepared products of digestion, by which they are elevated to a higher rank and brought some steps nearer to the final goal toward which they have been tending from the first. As yet our attempts to trace out these steps have been little better than the fruitless efforts of a lost traveler to find a road, the general direction of which he knows, but the ways by which it is reached only the subject of plausible conjecture. But

any theories that, like a scaffolding, allow of or help to additional investigation, and in any way lead out into a clearer light, are not without value; and on this principle we shall treat the subject, spending but little time in barren fields except as they have an interest from the suggestiveness of the results, even though negative.

THE METABOLISM OF THE LIVER.

This organ has two well-recognized functions: 1. The formation of bile. 2. The formation of glycogen.

We have already considered the first, and ascertained how little is positively known. Let us now examine the second.

Glycogen may be obtained from the liver of mammals, such as the rabbit, by rapidly killing the animal, excising the warm still living organ, cutting into fine pieces, throwing them into boiling water, removing after a few minutes and grinding in a mortar and reimmersing in the boiling water; on now passing the latter through a coarse filter a turbid, whitish fluid is obtained containing the extracted glycogen as proved by giving a red color with solution of iodine. The substance may be obtained as a whitish amorphous powder, having the chemical composition of starch, and has in fact been termed animal starch.

By appropriate treatment it may be converted into sugar by a process of hydration ($C_6H_{10}O_5 + H_2O = C_6H_{12}O_6$).

If, after the death of an animal, the liver be kept at body temperature for, say, an hour, very little glycogen can be recovered from it, but instead abundance of sugar. These facts suggest that the sugar present represents the original glycogen, and that the conversion has been effected by some ferment, which does not act during life, though why not is one of the problems ranking with the non-digestion of the stomach by its own ferments, etc.

We have already expressed our doubts as to the justifiability of resorting to so many "ferments" to explain the facts of physiology, and in the present case there is another possible view of the matter. It is conceivable that the conversion, under these circumstances, of the glycogen into sugar, may be an act of the dying protoplasm of the liver-cells; and there are experimental results which tend to strengthen such a view.

The principal facts as to the storage of glycogen in the liver may be briefly stated thus:

1. Glycogen has been found in the liver of a large number

of groups of animals including some invertebrates. 2. Among mammals it is most abundant when the animal feeds largely on carbohydrates. 3. It is found in the liver of the carnivora, and in those of omnivora, when feeding exclusively on flesh. 4. When an animal starves (does not feed), the glycogen gradually disappears. 5. A fat-diet does not give rise to glycogen. 6. During early foetal life glycogen is found in all the tissues, but later it is restricted more and more to the liver, though even in adults it is to be found in various tissues, especially the muscles, from which it is almost never absent.

From the facts the inference is plain that glycogen is formed from carbohydrate materials; or, to be rather more cautious, that the formation of this substance is dependent on the presence of such material in the food. Inasmuch as glycogen occurs in muscle, it does not follow, from the fact of its presence in the liver of carnivorous animals, that it is manufactured from proteid substances, though this is not more difficult to understand chemically than the formation of fat from this source which is well established.

Starch, it is well known, occurs abundantly in plants, and there is no doubt that the sugar often present in abundance has starch as its antecedent, and *vice versa*. Analogy, then, points to such a relation between carbohydrate food and glycogen formation on the one hand, and reconversion of glycogen into sugar on the other. And recent investigations tend to show that plant metabolism bears a greater resemblance to that of animals than was till recently supposed, thus giving greater force to the argument from analogy, though this is recognized as generally a dangerous one.

Assuming this relation between food-stuffs and glycogen to hold, the question arises, How is the substance formed by the liver? There are three conceivable methods: 1. The liver-cells may, we know not how, simply dehydrate the sugar of digestion as carried to them in the portal blood. 2. The cells may manufacture glycogen from their own protoplasm, in which process the portal sugar is in some way used. 3. The liver-cells may always be engaged in the construction of glycogen as the gastric cells of pepsinogen, but the accumulation or removal of the substance depends on the character of the food especially; thus, if the latter abounds in carbohydrates, the blood will be well supplied with sugar, so that the glycogen need not undergo its usual conversion into that substance. None of these views has been definitely proved to be the correct one.

The Uses of Glycogen.—Whether the blood of the hepatic vein contains more sugar than that of the portal vein has long been a subject of controversy. If the affirmative could be established, it would be pretty clear that glycogen stored in the liver-cells was transformed into sugar, possibly by a process of hydration. But, considering the rapidity of the blood-stream, it is easy to understand that a large amount of sugar might be conveyed

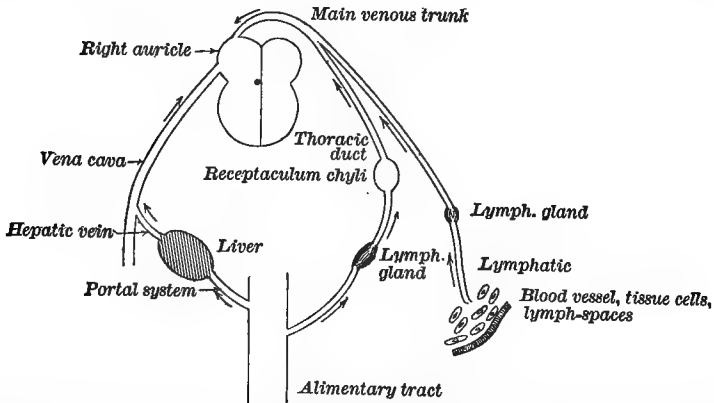

FIG. 329.—Diagram intended to illustrate the general relations of blood and lymph to metabolism (nutrition); and the method by which the portal, lymphatic, and general venous systems are related to the alimentary tract.

into the general circulation, and yet the blood, whether of the hepatic vein or of other parts, contain but a small quantity at any one time. The blood is kept of a certain fairly constant composition, both by the action of the excreting organs and by the withdrawal from it of supplies for the tissues. Moreover, that correlation of functional work on which we have already insisted, is not to be forgotten. One must not conceive of the liver-cells or any others doing their work independently of the condition of their fellow cell-units in the organic commonwealth. We mean to say that the amount of glycogen transformed to sugar will depend on a great many circumstances outside of the liver itself. Such aspects of the case have been rather overlooked. According to another theory, glycogen is an intermediate product between sugar and fat, but of this there is very little evidence indeed; and, besides, fat formation is otherwise well enough accounted for, though, of course, too much stress must not be laid upon such an argument.

What is the fate of the transformed glycogen? What becomes of the sugar? We can answer, negatively, that it is not

used up in the blood, it is not oxidized there; but by what tissues it is used or how it is made available in the economy is a subject on which we are profoundly ignorant. The presence of so much glycogen in the partially developed tissues of the fœtus points to its importance, and suggests its being a crude material which is laid up to be further elaborated, as in vegetables, by the growing protoplasm.

Glycogen being so generally present in muscle, its diminution running parallel, to some extent at least, with the functional activity of the tissue, it is clear that there is some important purpose served; but here again we inquire, What?

Pathological.—If a point in the medulla oblongata of a rabbit, corresponding nearly or completely with the vaso-motor center, be punctured, the urine will in a few hours be found augmented in quantity and containing sugar.

It is further found that the quantity of the latter bears some relation to the diet of the animal, one well fed on carbohydrates having more sugar in the urine than a fasting animal. From these facts it has been concluded that the nervous system has lost a customary normal influence over the glycogenic function, either directly through the action of the nerves on the liver-cells or through the loss of tone arising from injury to the vaso-motor center. Poisoning by carbonic oxide and the administration of certain drugs also causes sugar to appear in the urine.

The symptoms resulting from puncture of the medulla, etc., have been spoken of as “artificial diabetes”—a very objectionable term for which artificial glycosuria should be substituted. There is a grave and often fatal disease known as diabetes mellitus, *one* of the symptoms of which is the appearance often of enormous quantities of grape-sugar in the urine. But all attempts to fathom the depths of obscurity which surround this malady have been in vain. It would seem that attention has been directed too exclusively to the liver. Cases of the disease occur in which at the *post-mortem* examination the liver may be perfectly normal in appearance, or either hyperæmic or anæmic.

It seems to us that it is likely that the disease will be shown to be of diverse origins, or certainly not referable to one organ solely in most cases. The conclusion that the nervous system is greatly concerned, both in directing the glycogenic functions of the liver and in the disease in question, seems to be undoubted; vaso-motor effects, when present, being probably of

secondary importance. We doubt, however, if the results of the above-mentioned experiment warrants any inferences as to the normal glycolytic functions.

The instructive part about the disease diabetes is the manner in which the course of events emphasize the importance of co-ordination among the vital processes, and the constant necessity for regulation of them all by the nervous system. Diabetes seems to imply that these processes have escaped this normal control and are running riot.

METABOLISM OF THE SPLEEN.

The physiological significance of the peculiar structure of this organ, though not yet fully understood, is much plainer

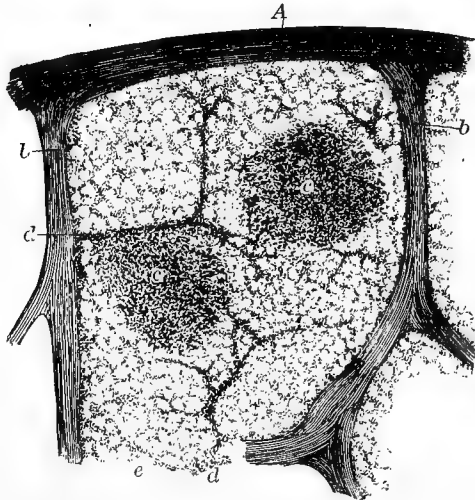

FIG. 330.—Vertical section of a small superficial portion of human spleen, seen with low power (Schäfer). *A*, peritoneal and fibrous covering; *b*, trabeculae; *c*, *c*, Malpighian corpuscles, in one of which an artery is seen cut transversely, in the other, longitudinally; *d*, injected arterial twigs; *e*, spleen-pulp.

than it was till recently. The student is recommended to look carefully into the histology of the spleen, especially the distribution of its muscular tissue and the peculiarities of its blood-vascular system. It has already been pointed out that there is little doubt that leucocytes are manufactured here even in the adult, possibly also red cells; and that the latter are disintegrated, and the resulting substances worked over, possibly by this organ itself. This view is rendered probable, not only by microscopic study of the organ, but by a chemical examina-

tion of the splenic pulp; for a ferruginous proteid, and numerous pigments, of a character such as harmonizes with this conception, are found.

The fact that the spleen-pulp does not agree in composition with either blood or serum; that it abounds in extractives such

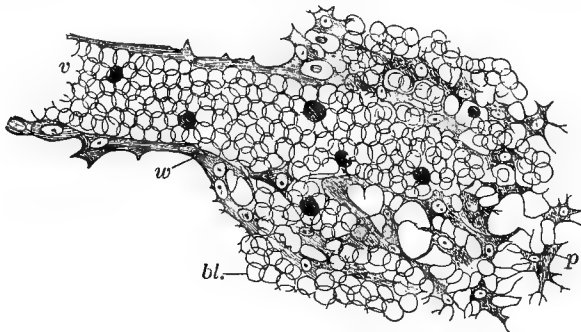

FIG. 331.—Thin section of spleen-pulp, highly magnified, showing mode of origin of a small vein in the interstices of pulp (Schäfer). *v*, vein filled with blood-corpuscles, which are in continuity with others, *bl.*, filling up interstices of retiform tissue of pulp; *w*, wall of vein. The shaded bodies among red corpuscles are pale corpuscles.

as lactic, butyric, formic, and acetic acids, together with inosit, xanthin, hypoxanthin, leucin and uric acid—points to its being

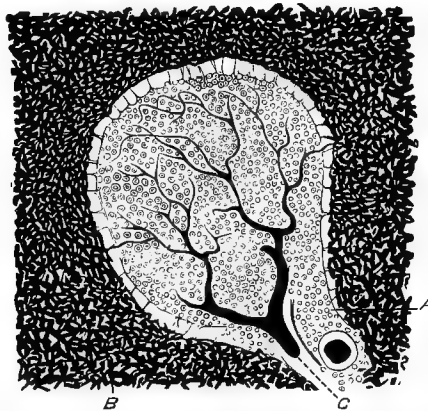

FIG. 332.—Portion of spleen of cat, showing Malpighian (lymphatic) corpuscle (after Cadiat). *A*, artery around which corpuscle is placed; *B*, meshes of spleen-pulp, injected; *C*, artery of corpuscle ramifying in lymphatic tissue. The clear space around corpuscle represents a lymphatic sinus.

the seat of a complex metabolism, though neither the changes themselves nor their purpose are well understood.

Nevertheless, it must be admitted that to recognize this was a great advance upon the view that the spleen had no impor-

tant function, and that this was shown by the removal of the organ without change in the animal's economy.

But to believe that there are no such changes, and to have clear proof of it, are two different things. As a matter of fact, closer study does show that in some animals there are alterations in the lymphatic glands and bone-marrow, which organs are undoubtedly manufacturers of blood-cells.

These changes are unquestionably compensatory, and that other similar ones corresponding to comparatively unknown functions of the spleen have not as yet been discovered is owing likely to our failures rather than their real absence. We dwell for a moment on this, because it illustrates the danger of the sort of reasoning that has been applied in the case of this and other organs; and it shows the importance of recognizing the force of the general principles of biology, and also the desirability of refraining from drawing conclusions that are too wide for the premises. In every department of physiology it must be more and more recognized that what is true of one group of animals is not necessarily true of another, or even of other individuals, though the differences in the latter case are of course usually less marked. We have referred to this before, and shall do so again, for it is as yet but too little considered.

Examinations of the spleen, carried out by means of the oncograph, as in the case of the kidney, reveal the following facts: 1. The spleen undergoes slight changes in volume, corresponding to the respiratory undulations of blood-pressure, but not, as with the kidney, to each heart-beat. 2. The spleen experiences rhythmic variations in size, independent of the general blood-pressure. It will be borne in mind that the splenic arteries end in capillaries, but that some of the arterial blood finds its way possibly from the capillaries into the splenic pulp, from which it is taken up by veins beginning in this tissue.

It is highly probable, then, that these movements serve to propel the blood that has found its way into the pulp-tissue onward into the veins; and it is not to be forgotten that among large groups of invertebrates, in which capillaries are wanting, a not very unlike method of carrying on the general circulation is found; at the same time, we may suppose that such an arrangement of blood-supply and removal would not be unfavorable to splenic metabolism.

There is one fact in the metabolism of the spleen that deserves special notice, though we can not indicate all its bear-

ings. Uric acid is found in the spleen, even of herbivorous animals, though not in their urine.

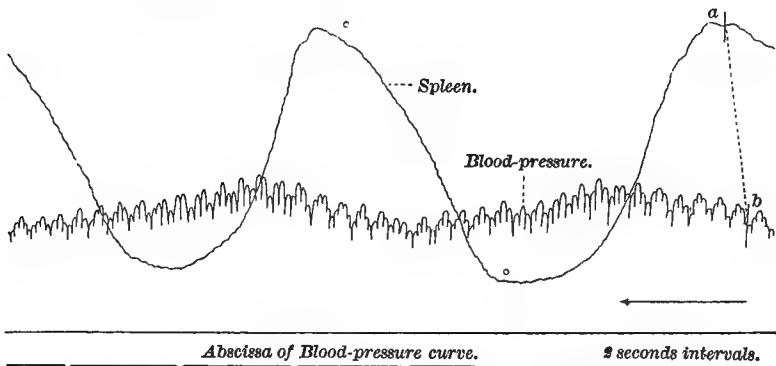

FIG. 333.—Tracing of splenic variations in size, taken with the oncograph (after Roy). The increase in volume is indicated in upper curve by the ascent and the diminution by the descent. The tracing below is of the blood-pressure as taken in carotid artery of dog. The lower line indicates time markings.

It is known that this constituent of the urine is increased in intermittent fever (ague), in which disease the spleen is often greatly enlarged. The vascular engorgement and the heightened metabolism of the spleen seem to be associated; and the fact that the uric-acid diathesis is often intensified if not originated by overfeeding, suggests a connection between the spleen and the digestive system at all events. Much as there is that remains obscure, we think it can not be doubted, on the evidence furnished, that the spleen must serve some very important purpose in the economy, apart from its relations to the blood, noticed in an earlier chapter.

The dominion of the nervous system over the spleen is evident from various facts. The spleen may be diminished in size either generally by the stimulation of the vagus or splanchnic nerves directly, or reflexly through stimulation of one of the afferent nerves; and, locally, by direct application of the electrodes to the surface of the organ. Stimulation of the medulla itself also leads to contraction of the organ. It would seem that not only the arteries but the organ as a whole is maintained in a state of tonic contraction to a certain extent by the agency of the nervous system. Not only so, but, if we may judge from the analogy of other organs, we may believe that its metabolism is directly controlled by the nervous system.

THE CONSTRUCTION OF FAT.

It is a well-known fact that, speaking generally, a diet rich in carbohydrates favors fat formation, both in man and other animals; though it is not to be forgotten that many persons seem to be unable to digest such food, or, at all events, to assimilate it so as to form fat to any great extent. Persons given to excessive fat production are as frequently as not sparing users of fat itself.

It is possible in man and probable in ruminants that fermentations may occur in the intestines giving rise to fatty acids which are possibly converted into fats by the cells of the villi or elsewhere. Certain feeding experiments favor the view that carbohydrates may be converted into fat or in some way give rise to an increase in this substance; for it is to be borne in mind that fat may arise from a certain diet in various ways other than its direct transformation into this substance itself.

There are certain facts that make it clear that fat can be formed from proteids: 1. A cow will produce more butter than can be accounted for by the fat in her food alone. 2. A bitch which had been fed on meat produced more fat in her milk than could have been derived directly from her food, and this, when the animal was gaining in weight, which is usually to be traced to the addition of fat; so that the fat of the milk was not, in all probability, derived from that of the dog's body; and, as will be seen presently, can be accounted for without such a supposition. 3. It has been shown by analysis that 472 parts of fat were deposited in the body of a pig for every 100 in its food.

These facts of themselves suffice to show that fat can be formed from proteid, or at least that proteid food can of itself give rise to a metabolism, resulting in fat formation; and the latter is probably the better way to state the case in the present condition of knowledge.

An examination of the percentage composition of proteid and urea renders a possible construction of fat from proteid conceivable and in harmony with other better known physiological facts.

	Carbon.	Hydrogen.	Nitrogen.	Oxygen.	Sulphur.
Proteid.....	53.00	7.30	15.53	23.04	1.13
Urea.....	20.00	6.66	46.67	26.67	

It will be seen that, if we assume that the urea discharged represents the whole of the nitrogen that passes through the

body, there would remain for disposal otherwise a large amount of carbon, for there is nearly three times as much of this element in proteid as in urea; so that it is possible, from a chemical point of view, to understand the origin of fat from the proteid food; but too much importance must not be attached to such speculations.

That fat is a real formation, dependent for its composition on the work of living tissues, is clear from the well-known fact that the fat of one animal differs from that of another, and that it preserves its identity, no matter what the food may be, or in what form fat itself may be provided. Certain constituents of the animal's fat may be wholly absent from the fat of its food, yet they appear just the same in the fat produced under such diet. Even bees can construct their wax from proteid, or use unlike substances, as sealing-wax.

But histological examination of forming adipose tissue itself throws much light upon the subject. Fat-cells are those in which the protoplasm has been largely replaced by fat. The latter is seen to arise in the former as very small globules

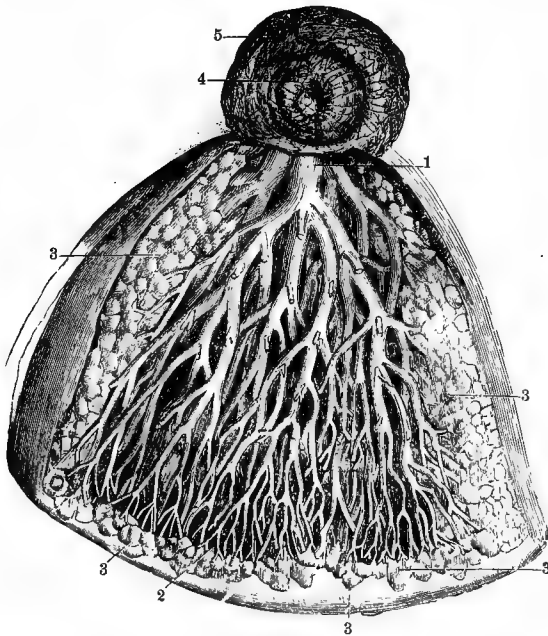

FIG. 334.—Mammary gland of human female (after Liégeois). 1, sinus, or dilatation of one of lactiferous ducts; 2, extremities of the ducts; 3, lobules of gland; 4, nipple, retracted in center; 5, areola.

which run together more and more till they may wholly replace the original protoplasm.

The history of the mammary gland is, perhaps, still more instructive. In this case, the appearance of the cells during lactation and at other periods is entirely different. Fat may

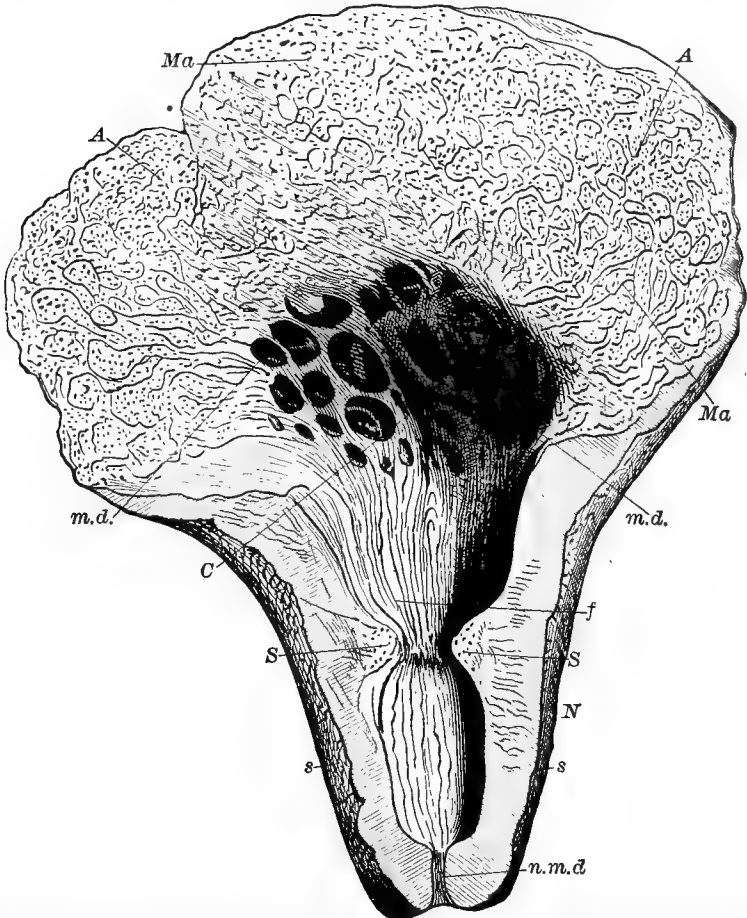

FIG. 335.—Section of mammary gland (udder and nipple) of cow (after Thanoffer). *Ma*, substance of gland; *N*, nipple; *A*, acini of gland; *m. d.*, milk-ducts; *C*, milk-cisterns; *f*, folds in wide milk-ducts; *S*, section of sphincter muscle; *s*, external skin; *n. m. d.*, narrow milk-duct in nipple.

be seen to arise within these cells and be extruded, perhaps in the same way as an Amœba gets rid of the waste of its food. So far as the animal is concerned, milk is an excretion in a limited sense

It is, in the nature of the case, impossible to follow with the eye the formation and separation of milk-sugar, casein, etc.

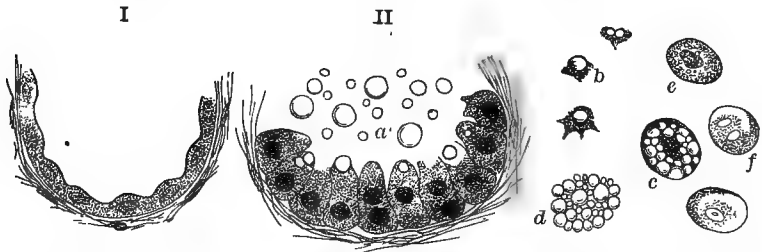

FIG. 336.—I. Acinus from mamma of a bitch when inactive (after Heidenhain). II. During secretion of milk. *a, b*, milk-globules; *c, d, e*, colostrum-corpuses; *f*, pale cells.

But the whole process is plainly the work of the cells, and in no mechanical sense a mere deposition of fat, etc., from the blood; and the same view applies to the construction of fat by connective (adipose) tissue.

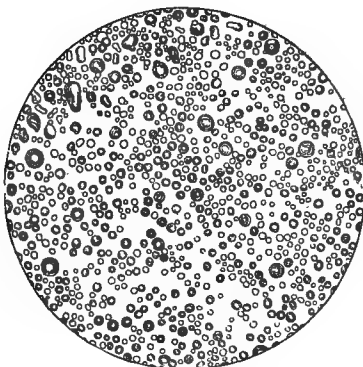

FIG. 337.

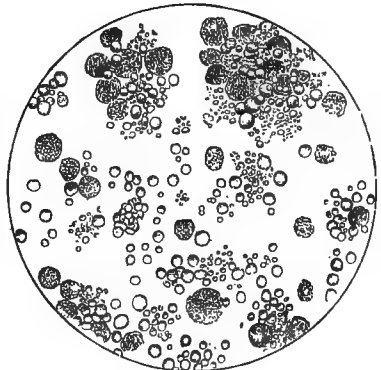

FIG. 338.

FIG. 337.—Human milk-globules, from a healthy lying-in woman, eight days after delivery (Funke).

FIG. 338.—Colostrum, from a healthy lying-in woman, twelve hours after delivery (Funke). The colostrum-corpuses are large and granular; they gradually disappear from the secretion.

Whether fat, as such, or fatty acid, is dealt with without being built up into the protoplasm of the cell, is not known; but, taking all the facts into the account, and considering the behavior of cells generally, it seems most natural to regard the construction of fat as a sort of secretion or excretion. To suppose that a living cell acts upon material in the blood as a workman in a factory on his raw material, or even as a chemist

does in the laboratory, seems to be too crude a conception of vital processes. Until it can be rendered very much clearer

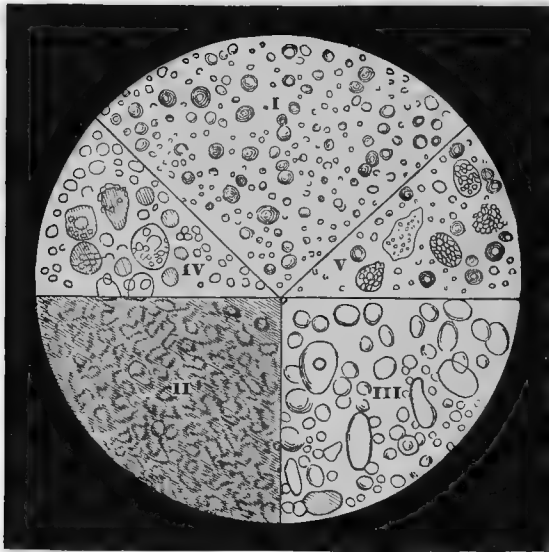

FIG. 339.—Microscopic appearances of—I, milk; II, cream; III, butter; IV, colostrum of mare; V, colostrum of cow (after Thanhofer).

than at present, it is not safe to assume that their chemistry is our chemistry, or their methods our methods. It may be so; but let us not, in our desire for simple explanations or undue haste to get some sort of theory that apparently fits into our own knowledge, assume it gratuitously, in the absence of the clearest proofs, especially when our failures on this supposition are so numerous.

We may say, then, that fat is not merely selected from the blood, but formed in the animal tissues; that fat formation may take place when the food consists largely of carbohydrates, when it is chiefly proteid, or when proteid and fatty. In other words, fat results from the metabolism of certain cells, which is facilitated by the consumption of carbohydrate and fatty food, but is possible when the food is chiefly nitrogenous. We must, however, recognize differences both of the species and the individual in this respect, as to the extent to which one kind of food or the other most favors fat formation (excretion). The use of the adipose tissue as a packing to prevent undue escape of heat is evident; but more important

purposes are probably served, as will appear from later considerations.

Pathological.—Corpulence, or excessive fat formation, leading to the hampering of respiration, the action of the muscles, and, to a certain extent, many other functions of the body, does not arise usually till after middle life, when the organism has seen its best days. It seems to indicate, if we judge by the frequency of fatty degeneration after disease, that the protoplasm stops short of its best metabolism, and becomes degraded to a lower rank; for certainly adipose tissue does not occupy a high place in the histological scale. Many persons given to excessive fat formation are fond of saccharine and amylaceous foods; but the fact that, under the strictest diet, the abnormality can be but moderately controlled, shows that the main point is the existence of the habit of certain cells naturally to form fat, which, in disease, becomes exaggerated, or is taken up by others that normally have little share in such work. Such pathological facts throw a good deal of light upon the general nature of fat excretion, as it would be better to term it, perhaps, and seem to warrant the view that we have presented of the metabolic processes.

Although the nerves governing the secretion of milk have not been traced, there can be no doubt that the nervous system controls this gland also. The influence of the emotions on both the quantity and quality of the milk in the human subject and in lower animals is well known. There seems to be no doubt that milk of an injurious if not absolutely poisonous character may be formed under the influence of depressing or unusually exciting emotions, as grief, rage, etc. We know less about the influence of the nervous system in fat formation elsewhere, though it is well enough established that persons grow thin under worry as well as excessive mental and physical exertion. In the latter case, it is not improbable that the overworked muscles may draw, in some way, on the stored fat. At the same time, fat formation may be interfered with, and be an expression of the unnatural conditions generally that have been established. Such cases are too complex to permit of being completely unraveled.

Comparative.—While breeders recognize certain foods as tending to fat formation and others to milk production, it is interesting to note that their experience shows that race and individuality, even on the male side, tell. The same conditions being in all respects observed, one breed of cows gives more

and better milk than another, and the bull is himself able to transmit this peculiarity; for, when crossed with other breeds, he improves the milking qualities of the latter. Individual differences are also well known.

THE METABOLIC PROCESSES CONCERNED IN THE FORMATION OF UREA, URIC ACID, HIPPURIC ACID, AND ALLIED BODIES.

Creatin is represented by the formula $C_4H_9N_3O_2$, and creatinin by $C_4H_7N_3O$ —that is, the latter may be regarded as the firmer dehydrated. Creatinin occurs, as we have seen, in urine, and the question arises, Is the creatin of muscle the antecedent of the creatinin of urine? Creatin when injected into the blood reappears as creatinin in the urine; but the latter substance is not increased by exercise, though the creatin of the muscles is, while, like urea, creatin is augmented by a proteid (flesh) diet. It is not clear, then, that the creatin of muscle has any definite relation to the creatinin of urine. But creatin occurs not only in muscle, but in a variety of other tissues, including the nervous; in fact, it may be regarded as one of the products of proteid metabolism. Putting these facts along with the absence of urea itself from muscle and many other tissues, there is some probability in the view that creatin is one of the antecedents of urea; possibly it is one of the products which the kidneys directly convert into urea.

There are several facts which point to the liver as being the seat of urea formation: 1. Leucin, when taken in large quantities, reappears in the urine as urea, or, at all events, is followed by an increase in the excretion of urea by the kidneys. 2. In certain diseases of the liver (acute atrophy) urea is largely replaced in the urine by leucin and tyrosin. Now, since the consumption of much proteid matter is soon followed by an excess of urea in the urine, and since in such cases it is likely that a good deal of leucin and its companion, tyrosin, are formed in the digestive tract, which we may suppose are carried directly by the portal blood to the liver, the conclusion has been drawn from this and the facts just mentioned, as well as others, that the liver is a former of urea.

Urea may be prepared artificially, as represented by the following equations:

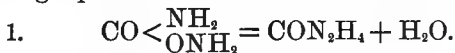

Ammonium
carbamate. Urea.

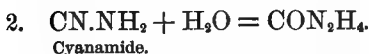

Cyanamide.



Ammonium
cyanate.

Leucin is amido-caproic acid ($\text{CH}_2\text{CH}_2\text{CH}_2\text{CH}_2\text{CH}(\text{NH}_2)\text{CO}_2\text{H}$).

Another amido-acid, glycin—

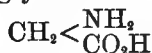

Amido-acetic acid,

when introduced into the digestive tract, gives rise to an increase of the urea of the urine.

It will be seen that ammonia compounds, both in the laboratory and apparently in the body, have a formative relation to urea; but beyond this we can not go very far in furnishing a chemical explanation of the formation of urea as a part of a series of metabolic processes. Do the kidneys merely pick out from the blood and pass on into the urinary tubules the already formed urea—i. e., eat, so to speak, and then discharge it, Amœba-like—or do they manufacture it from bodies that have gone on the way a certain distance toward urea before they reach the kidneys; or, again, do they form urea in some such way as the mammary gland constructs fat?

If the ureters be tied, the renal arteries ligatured, or the kidneys extirpated, urea accumulates in the blood and tissues. This might be explained on the supposition that urea formed elsewhere was not eliminated; or that some body related to urea, and the usual transformations of which are completed in the kidneys, under these unwonted circumstances becomes urea, either in the tissues in which it arose or elsewhere.

We can not pronounce with certainty in favor of any one or all of these conceivable methods. We may perhaps assume that creatin and possibly other allied bodies are antecedents of urea; that the leucin and perhaps the tyrosin of digestion in some way give rise to urea; and that the liver and possibly the spleen are organs in which a portion of the urea is formed; that a part of the urea of urine is simply withdrawn from the blood by the kidneys; but, as to whether any part is made by

the latter in either of the senses to which we have alluded above, is a matter on which there is very little evidence. It is perhaps best to assume, at least, the possibility of the truth of both of them.

Uric Acid.—This substance can be oxidized in the laboratory to urea, thus:

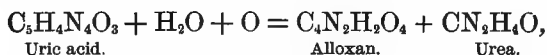

so that it has been assumed that uric acid in the body is a stage short of urea, and this seemed the more plausible, since it replaces the latter in the cold-blooded animals. But this is not entirely the case, for in the frog urea is found in the urine, and our knowledge of this secretion in most of them is very incomplete; moreover, in the birds, representing the very greatest degree of activity and the highest oxidative capacity, uric acid is the principal nitrogenous body of the urine, and not urea.

Pathological.—When there is excessive indulgence by man in proteid foods, etc., the uric acid, normally small in quantity, is increased greatly, and may give rise to depositions of urates about the joints.

It seems best to regard uric acid as the result of proteid metabolism when of a certain type, and urea as the outcome of the vital processes of animals of a distinct physiological type.

Evolution.—There is a good deal of paleontological evidence which points to a phylogenetic (ancestral) relation between birds and reptiles; hence the many points of functional resemblance between these groups of creatures now so different in form and, in some respects, in functions. The excessive production of uric acid (uric-acid diathesis) can be understood in the light of physiological reversion. It is well known that this diathesis is hereditary—that is to say, the metabolic habit of excessive production of uric acid may be imparted to offspring.

Hippuric Acid.—Among the herbivora hippuric acid may be said to replace uric acid. In the laboratory this acid may be made from benzoic acid and glycol (glycin), thus:

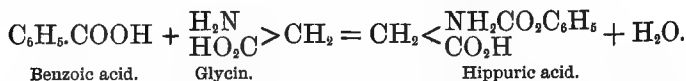

It is interesting to note that, when benzoic acid is swallowed by man, hippuric acid appears in the urine; and it is said that

when blood containing benzoic acid is mixed with fresh minced kidney it is transformed to hippuric acid. Hay contains a benzoic compound, so that it is not difficult to find a starting-point for the hippuric acid of the herbivora. In these instances it is assumed that glycin is added in the kidneys; but, as a matter of fact, this substance has not as yet been found anywhere in the body, though it is possible to conceive that, like peptone, it might be formed and disappear (be used) as fast as generated.

The above is one of the clearest cases favoring the view that the chemical processes of the body do really very much resemble those of the laboratory. But, considering the difficulty as to glycin, and that the liver also can form hippuric acid under similar circumstances (those mentioned above), and that there are several laboratory methods for the synthesis of hippuric acid, it behooves us to be cautious even in this case, the chain of facts being by no means complete.

Of the origin of the allied bodies—xanthin, etc.—or their fate and purpose, we know very little. Their resemblance chemically to certain alkaloids in tea, coffee, etc., is suggestive. Are they natural stimulants?

THE STUDY OF THE METABOLIC PROCESSES BY OTHER METHODS.

It will be abundantly evident that our attempts to follow the changes which the food undergoes from the time of its introduction into the blood until it is removed in altered form from the body has not been as yet attended with great success. It is possible to establish relations between the ingesta and the egesta, or the income and output which have a certain value. It is important, however, to remember that, when quantitative estimations have to be made, a small error in the data becomes a large error in the final estimate; one untrue assumption may vitiate completely all the conclusions.

In discussing the subject we shall introduce a number of tables, but it will be remembered that the results obtained by one investigator differ from those obtained by another; and that in all of them there are some deviations from strict accuracy, so that the results must be regarded as only approximately correct. It is, however, we think, better to examine such statistical tables of analyses, etc., than to rely on the mere verbal statement of certain results, as it leaves more

room for individual judgment and the assimilation of such ideas as they may suggest outside of the subject in hand.

The subject of diet is a very large one; but it will be evident on reflection that, before an average diet can be prescribed on any scientific grounds, the composition of the body and the nature of those processes on which nutrition generally depends must be known. Not a little may be learned by an examination of the behavior of the body in the absence of all diet, when it may be said to feed on itself, one tissue supplying another. All starving animals are in the nature of the case carnivorous.

Composition of the Mammalian Body.

	Adult man.	New-born child.
Skeleton.....	15.9	17.7
Muscles.	41.8	22.9
Thoracic viscera.	1.7	3.0
Abdominal viscera.	7.2	11.5
Fat.	18.2	} 20.0
Skin.	6.9	
Brain.	1.9	15.8

For the cat an analysis has yielded the following:

Muscle and tendons.	45.0 per cent.
Bones.	14.7 "
Skin	12.0 "
Mesentery and adipose tissue.	3.8 "
Liver	4.8 "
Blood (escaping at death).	6.0 "
Other organs and tissues.	13.7 "

The large proportional weight of the muscles, the similarly large amount of blood they receive; which is striking in the case of the liver, also suggest that the metabolism of these structures is very active, and we should expect that they would lose greatly during a starvation period. It is a matter of common observation that animals do lose weight and grow thin under such circumstances, which means that they must lose in the muscles and the adipose tissue. Attempts have been made to determine exactly the extent to which the various tissues do suffer during complete abstinence from food, and this may be gathered from the table given below.

Starvation.—A cat weighing 2,464 grammes lost before death on the eighteenth day 1,197 grammes in weight. Of this about

204 grammes (17 per cent) was in albuminous matter; 132 grammes (11 per cent) loss of fat; 863 grammes loss of water, 71 per cent of the total body weight.

It will not be forgotten that about three fourths of the body is made up of water, so that the loss of so large an amount of the latter during starvation is not wholly inexplicable.

In the case of another cat during a starvation period of thirteen days 734 grammes of solids were lost, of which 248 grammes were fat and 118 muscle—i. e., about one half of the total loss was referable to these two tissues alone.

The other tissues lost as follows, estimated as *dry* solids:

Adipose tissue	97.0	per cent.
Spleen	63.1	“
Liver	56.6	“
Muscles	30.2	“
Blood	17.6	“
Brain and spinal cord	0.0	“

It will be observed (*a*) that the loss of the fatty tissue was greatest, nearly all disappearing; (*b*) that the glandular structures were next in order the greatest sufferers; (*c*) that after them come the skeletal muscles.

Now, it has been already seen that these tissues all engage in an active metabolism with the exception of adipose tissue.

The small loss on the part of the heart, which is still less for the nervous system, is especially noteworthy. Two explanations are possible. On the one hand, we may suppose that their metabolism is active, but that they feed in some sense on the other tissues, and thus preserve themselves from loss of substance. But, again, we have seen that the functional activity of the nervous system is not accompanied by any very marked chemical phenomena that we have succeeded in detecting, at all events; and little is known of the metabolism of the heart itself. Do its pulsations from long habit go on with little expenditure of energy, as is the case with the automatic workman engaged in a narrow round of duty? Has the nervous system in the course of its evolution acquired the power of accomplishing much, like persons with special aptitudes, with little loss of energy? It is not possible to decide exactly what share these several factors may take; though that they all and others as yet unrecognized do share in the general result seems probable. The loss of adipose tissue is so striking

that we must regard it as an especially valuable storehouse of energy, available as required.

When we turn to the urine for information, it is found that in the above case 27 grammes of nitrogen were excreted and almost entirely, of course, in the form of urea; and since the loss of nitrogen from the muscles amounted to 15 grammes, it will appear that more than one half of the nitrogenous excreta is traceable to the metabolism of muscular tissue. It has been customary to account for the urea in two ways: first, as derived from the metabolism of the tissues as such, and continuously throughout the whole starvation period; and, secondly, from a stored surplus of proteid which was assumed to be used up rapidly during the early days of the fasting, and was the *luxus consumption* of certain investigators.

Comparative.—Experiment has shown that the length of time during which different groups of animals can endure complete withdrawal of food is very variable, and this applies to individuals as well as species. That such differences hold for the human subject is well illustrated by the history of the survivors of wrecks. Making great allowances for such deviations from any such results as can be established by a limited number of experiments, it may be stated that the human being succumbs in from twenty-one to twenty-four days; dogs in good condition at the outset in from twenty-eight to thirty days; small mammals and birds in nine days, and frogs in nine months. Very much depends on whether water is allowed or not—life lasting much longer in the former case. The very young and the very old yield sooner than persons of middle age. It has been estimated that strong adults die when they lose $\frac{1}{6}$ of the body weight. Well-fed animals lose weight more rapidly at first than afterward.

Diet.—All experiments and observations tend to show that an animal can not remain in health for any considerable period without having in its food proteids, fats, carbohydrates, and salts; indeed, sooner or later deprivation of any one of these will result in death.

Estimates based on many observations have been made of the proportion in which these substances should enter into a normal diet. In the nature of the case, for a creature like man especially, whose adaptive power is so great that he can learn to live under a greater variety of conditions than any other animal, any figures on this subject must be interpreted as being but a very general statement of the case.

We give another series of tables, founded on experiments by different investigators from which a number of conclusions may be drawn :

The Requirements of an Adult Man for Twenty-four Hours.

FOOD IN GRAMMES.	At rest. (Playfair.)	Moderate work. (Moleschott.)	Laborious work.	
			(Playfair.)	(V. Pettenkofer and V. Voil.)
Proteids.....	70·87	130	155·92	137
Fats.....	28·35	84	70·87	117
Carbohydrates.....	310·20	404	567·50	352

Ingesta of an Adult working moderately (Vierordt):

	C	H	N	O
120 grammes albumin, containing.....	64·18	8·60	18·88	28·34.
90 grammes fats, containing.....	70·20	10·26	9·54
330 grammes starch, containing.....	146·82	20·33	162·85
Total	281·20	39·19	18·88	200·73

It has further been estimated that 744 grammes of oxygen are respired, 2,818 grammes water drunk, and 32 grammes of salts consumed.

The total ingesta have been estimated at $\frac{1}{20}$ of the body weight; and the daily metabolism of the body is calculated as leading to the transformation of 6 per cent of the water, 6 per cent of the fat, 1 per cent of the proteids, and 4 per cent of the salts of the body.

The Egesta of an Adult working moderately.

	H ₂ O	C	H	N	O
By respiration.....	330	248·8	?	651·15
By transpiration.....	660	2·0	7·2
By urine.....	1,700	9·8	3·3	15·8	11·1
By fæces.....	128	20·0	3·0	3·0	12·0
Total.....	2,818	281·2	6·3	18·8	681·45

If we lay down the rule as has been done, that the nitrogenous should bear the proportion of 1 to $3\frac{1}{2}$ — $4\frac{1}{2}$ of non-nitrogenous, an inspection of the following analytical table will show how these various food-stuffs conform to such an estimate.

For the herbivora from 1 to 8-9 (some claim 1 to 5½) is the estimated ratio of nitrogenous to non-nitrogenous foods :

	Nitro.	Non-nitro.		Nitro.	Non-nitro.
Veal.....	10	1	Human milk	10	37
Hare's flesh.....	10	2	Wheaten-flour.....	10	46
Beef.....	10	17	Oatmeal.....	10	50
Lentils.....	10	21	Rye-meal.....	10	57
Beans.....	10	22	Barley-meal.....	10	57
Peas.....	10	23	White potatoes.....	10	86
Mutton.....	10	27	Blue potatoes.....	10	115
Pork.....	10	30	Rice.....	10	123
Cow's milk.....	10	30	Buckwheat-meal.....	10	130

One investigator estimates that in order to get the one hundred and thirty grammes of proteids required by an adult man engaged at moderate labor, the following proportions of different kinds of foods must be eaten :

	Grammes.		Grammes.
Cheese.....	388	Wheaten bread.....	1,444
Lentils.....	491	Rice.....	2,562
Peas.....	582	Rye-bread.....	2,875
Beef.....	614	Potatoes.....	10,000
Eggs.....	968		

One conclusion that is most obvious from the above is that, in order to obtain the amount of proteids needed from certain kinds of food, enormous quantities must be eaten and digested ; and as there would be in such cases an excess of carbohydrates, fats, etc., unnecessary work is entailed upon the organism in order to dispose of this.

FEEDING EXPERIMENTS (*Ingesta and Egesta*).

If all that enters the body in any form be known, and all that leaves it be equally well known, conclusions may be drawn in regard to the metabolism the food has undergone. The possible sources of fallacy will appear as we proceed.

The ingesta, in the widest sense, include the respired air as well as the food ; though from the latter must be subtracted the waste (undigested) matters that appear in the fæces. The ingesta when analyzed include carbon, hydrogen, oxygen, nitrogen, sulphur, phosphorus, water, and salts, their source being the atmosphere and the food-stuffs.

The egesta the same, and chiefly in the form of carbonic anhydride, of water from the lungs, skin, alimentary canal, and

kidneys, of salts and water from the skin and kidneys, and of nitrogen, chiefly as urea almost wholly from the kidneys. Usually in experimental determinations the total quantity of the nitrogen of the urine is estimated. If free nitrogen plays any part in the metabolic processes it is unknown.

A large number of feeding experiments have been made by different investigators, chiefly, though not exclusively, on the lower animals. Some such method as the following has usually been pursued: 1. The food used is carefully weighed and a sample of it analyzed, so that more exact data may be obtained. 2. The amount of oxygen used and carbonic anhydride exhaled, as well as the amount of water given off in any form, is estimated. 3. The amount of the nitrogenous excreta is calculated, chiefly from an analysis of the urine, though any loss by hair, etc., is also to be taken into account.

It has been generally assumed that the nitrogen of the excreta represents practically the whole of that element entering the body. This has been denied by some investigators.

The respiratory products have been estimated in various ways. One consists in measuring the quantity of oxygen supplied to the chamber in which the animal under observation is inclosed, and analyzing from time to time samples of the air as it is drawn through the chamber; and on these results the total estimates are based.

It will appear that even errors in calculating the composition of the food—and this is very variable in different samples, e. g., of flesh; or any errors in the analysis of the urine, or in the more difficult task of estimating the respiratory products, may, when multiplying to get the totals, amount to serious departures from accuracy in the end; so that all conclusions in such a complicated case must be drawn with the greatest caution. But it can not be doubted that such investigations have proved of much practical and some scientific value. The labor they entail is enormous.

Proteid Metabolism.—If we conceive of a structural unit or cell as made up of a genuine protoplasm constituting its meshwork and holding in the interstices certain substances that are not part of itself, strictly speaking, the question arises, Are these latter used up in the metabolic process as such, or do they become a part of the true protoplasm before they undergo the changes referred to above? Some writers speak of “organ albumin” and “circulating albumin,” and they believe that the latter, by which is meant the proteid material found every-

where in the fluids of the body, as opposed to the former as constituting organized tissues, undergoes changes of a retrograde kind without ever becoming organ albumin, while the term *luxus consumption* was applied to the metabolism of proteids in the blood. The latter is not now believed to occur. But whether a portion of the urea that represents, in the main, the results of proteid metabolism is not derived from the metabolism of the material in the interspaces of the tissues (circulating proteids on which the cells are supposed to act and in which they effect changes without making these proteids a part of themselves), is uncertain.

Nitrogenous Equilibrium.—It is possible to so feed an animal, say a dog, that the total nitrogen of the ingesta and egesta shall be equal; and this may be accomplished without the animal losing or gaining weight appreciably or again while he is gaining. If there be a gain, it can usually be traced to the formation of fat, so that the proteid, we may suppose, has been split up into a part that is constructed into fat and a part which is represented by the urea, the fat being either used up or stored in the body. Moreover, an analysis of a pig that had been fed on a fixed diet, and a comparison made with one of the same litter killed at the commencement of the experiment, showed that of the dry nitrogenous food only about seven per cent in this animal and four per cent in the sheep had been laid away as dry proteid. It is perfectly plain, then, that proteid diet does not involve only proteid construction within the body.

Comparative.—The amount of flesh which a dog, being a carnivorous animal, can digest and use for the maintenance of his metabolic processes is enormous; though it has been learned that ill-nourished dogs can not even at the outset of a feeding experiment of this kind maintain the equilibrium of their body weight on a purely flesh diet (fat being excluded). They at once commence to lose weight—i. e., they draw upon their own limited store of fat.

The digestion of herbivora being essentially adapted to a vegetable diet, they can not live at all upon flesh, while a dog can consume for a time without manifest harm $\frac{1}{5}$ to $\frac{1}{6}$ of its body-weight of this food.

Man, when fed exclusively on meat soon shows failure, he being unable to digest enough to supply the needed carbohydrates, etc. But the large amount of urea in the urine of carnivorous animals generally, and the excess found in the urine

of man when feeding largely on a flesh diet, show that the proteid metabolism is under such circumstances very active.

It is also a well-known observation that carnivorous animals (dogs) are more active and display to a greater extent their latent ferocity, evidence of their descent from wild carnivorous progenitors, when like them they feed very largely on flesh. The evidence seems to point pretty clearly to the conclusion that a nitrogenous (flesh) diet increases the activity of the vital processes of the body, and especially the proteid metabolism.

Some have explained this result on the assumption that such diet led to an increase in the red corpuscles of the blood, and hence in the oxygen-supply; but mere abundance of supply will never of itself explain results in a living organism. It may be and probably is true that such a diet augments the activity of the oxidative processes, but the reason of this lies deeper, we think, than the explanations as yet offered assume. That an excess of proteids may be stored, as it seems, is true of fats and carbohydrates, to be used in the hour of need, seems not improbable, though this has not as yet been shown to be the case. But in all these considerations it must be borne in mind that the metabolic processes go on in the tissues and not in the blood, and probably not in the lymph. Not that these fluids (tissues) are without their own metabolic processes for and by themselves; but what is meant to be conveyed is that the metabolic processes of the body generally do not take place in the blood.

The Effects of Gelatine in the Diet.—Actual experiment shows that this substance can not take the place of proteid, though it also makes it evident that less of the latter suffices when mixed with a certain proportion of gelatine; and it has been suggested that it is split up into a fatty portion and urea, and that it thus, by aiding in the formation of fat, preserves some of the proteid for other uses than fat construction. This theory, however, is not well substantiated. It will be borne in mind that ordinary flesh contains, as we find it naturally in the carcass, not only some fat, but a good deal of fibrous tissue, which can be converted by heating into gelatine.

Fats and Carbohydrates.—It is a matter of common observation and of more exact experiment that even a carnivorous animal thrives better on a diet of fat and lean meat than on lean flesh alone. Thus, it has been found that nitrogenous equilibrium was as readily established by a due mixture of fat and

lean as upon twice the quantity of lean flesh alone. It is plain, then, that the metabolism is actually slowed by a fatty diet. When an animal is given but little fat, none whatever is laid up, but all the carbon of the fat can be accounted for in the excreta, chiefly as carbonic anhydride. Again, the fatty portion remaining constant, it has been found that increasing the proteid leads not to a storage of the carbon of the proteid excess, but to an increased consumption of this element. It is then possible to understand how excessive consumption of proteids may lead, as seems to be the case, to the disappearance of fat and loss of weight, so that a proteid diet increases not only nitrogenous but non-nitrogenous metabolism. That carbohydrates mixed with a due proportion of the other constituents of a diet do increase fat formation is well established; though there is no equally well-grounded explanation of how this is accomplished. Upon the whole, it seems most likely that fat can be directly formed from carbohydrates, or, at all events, that they directly give rise to fat if they are not converted themselves into that substance.

Comparative.—It is found that there are relations between the food used and the quantity of carbonic dioxide expelled which are instructive. The formula following show the amount of oxygen necessary to convert a starch and a fat into carbonic anhydride and water:

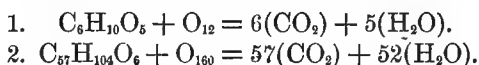

It will be observed that in the first case the oxygen used to oxidize the starch has all reappeared as CO_2 , while in the second only 114 parts out of 160 so reappear. As a matter of fact, more of the oxygen used does in herbivora reappear as CO_2 , and less as water, while the reverse holds for the carnivora, the proportion being, it is estimated, as from 90 to 60 per cent. This is to be explained by the character of the food in each instance, for this relation no longer holds during fasting, when the herbivorous animal becomes carnivorous in the sense that it consumes its own tissues.

To most persons the carbohydrates are more digestible than fats, though they have less potential energy, as will shortly be seen.

The Effects of Salts, Water, etc., in the Diet.—We have already considered how salts in the form of condiments may beneficially influence the digestion; but, when we come to inquire as to the

part they play when introduced into the blood, we soon find that our knowledge is very limited.

Sulphur, and especially phosphorus, seem to have some important use which quite eludes detection. It is important to remember that certain salts are combined with proteids in the body, possibly to a greater extent than we can learn from the mere analysis of dead tissues.

Pathological.—The withdrawal of any of the important salts of the body soon leads to disease, clear evidence in itself of their great importance. This is notably the case in scurvy, in which disease the blood seems to be so disordered and the nutrition of the vessel-walls so altered that the former (even some of the blood-cells) passes through the latter.

Water.—The use of water certainly has a great influence over the metabolic processes of the body. The temporary addition or withdrawal of even a few ounces of water from the regular supply of a dog in the course of a feeding experiment greatly modifies the results obtained for the time. It is well known that increase of water in the diet leads to a corresponding increase in the amount of urea excreted. It is likely that even yet we fail to appreciate the great part which water plays in the animal economy.

THE ENERGY OF THE ANIMAL BODY.

As already explained, we distinguish between potential or latent and actual energy. All the energy of the body is to be traced to the influence of the tissues upon the food. Energy may be estimated as mechanical work or as heat, and the one may be converted into the other. All the processes of the organism involve chemical changes, and a large proportion of these are of the nature of oxidations; so that, speaking broadly, the oxidations of the animal body are the sources of its energy; and in estimating the quantity of energy, either as heat or work, that a given food-stuff will produce, one must consider whether the oxidative processes are complete or partial. Thus, in the case of proteid food, if we suppose that the urea excreted represents the form in which the oxidative processes end or are arrested, we must, in estimating the actual energy of the proteid, subtract the amount of energy that would be produced were the urea itself completely oxidized (burned).

If the amount of heat that a body will produce in its com-

bustion be known, then by the law of the conversion and equivalence of energy the mechanical equivalent can be estimated in that particular case.

The heat-producing power of different substances can be directly learned by ascertaining the extent to which, when fully burned (to water and carbonic anhydride), they elevate the temperature of a given volume of water; and this can at once be translated into its mechanical equivalent of work, so that we may say that one gramme of dry proteid would give rise to a certain number of gramme-degrees of heat or kilogramme-metres of work. A few figures will now show the relative values of certain food-stuffs :

	Gram.-deg.	Kilomet.
1 gramme proteid.....	5,103	2,161
1 gramme urea.....	785	311
Available energy of the proteid.....	4,368	1,850

The reason of the subtraction has been explained above.

Taking another diet in regard to which the estimates differ somewhat from those given previously, but convenient now as showing how equal weights of substances produce very different amounts of energy, we find that—

	Gram.-deg.	Kilomet.
100 grammes proteid yield.....	436,800	185,000
100 grammes fat yield.....	906,900	384,100
240 grammes starch yield.....	938,880	397,680
Total.....	2,281,580	966,780

In other words, nearly a million kilogramme-metres of energy are available from the above diet for one day, provided it be all oxidized in the body.

Food-stuffs, then, with the oxygen of the air, are the body's sources of energy. What are the forms in which its expenditure appears? We may answer at once, heat and mechanical work; for it is assumed that internal movements, as those of the viscera, and all the friction of the body, all its molecular motion, all secretive processes, are to be regarded as finally augmenting the heat of the body. Heat is lost by the skin, lungs, urine, and fæces.

The amount of work which a man or other animal can do on a given diet may be estimated without the same sources of fallacy as attend the calculation of the heat expenditure; for, when an animal is confined in a calorimetric chamber, the conditions of the normal metabolism are not observed.

THE SOURCES OF MUSCULAR ENERGY.

Experimental.—Two physiologists (Fick and Wislicenus) ascended a mountain, noting the conditions under which their metabolism was performed, and drew certain conclusions in regard to the question now being considered. They lived exclusively on a non-nitrogenous diet while the work was being done, and estimated the amount of urea excreted at the same time. Assuming that the urea does represent the proteid metabolism (oxidation) which bore, of course, a definite relation to the energy available, it was found that in the case of each of them this was only about half enough to account for the work done. Even making large allowances for error in the estimates, if this experiment is to be trusted at all, it is plain that the energy of the muscles of the body is not derivable from their proteid metabolism; and there are other facts which point in the same direction.

It is found, when an isolated muscle is studied, that its continued contraction does not produce nitrogenous bodies, but very different ones, such as carbonic anhydride. The quantity of the latter may be augmented many times by work. But it is no longer believed that the severest labor appreciably increases the secretion of urea.

The division of foods into heat-producers and tissue-builders is unjustifiable, as will appear from what has just been stated, as well as from such facts as the production of fat from proteid food, thus showing that the latter is indirectly a producer of carbonic anhydride, assuming that fat is oxidized into that substance.

ANIMAL HEAT.

Though a large part of the heat generated within the body is traceable to oxidations taking place in the tissues, it is better to speak of the heat as being the outcome of all the chemical processes of the organism; and though heat may be rendered latent in certain organs for a time, in the end it must reappear. While all the tissues are heat-producers (thermogenic), the ex-

tent to which they are such would depend, we should suppose, upon the degree to which they were the seat of metabolic processes; and actual tests establish this fact. Thus, among glands the liver is the greatest heat-producer; hence the blood from this organ is the warmest of the whole body. The muscles also are especially the thermogenic tissue.

The temperature of the blood in the hepatic vein is warmer than that in the portal, a clear evidence that the metabolism of this organ has elevated the temperature of the blood flowing through it.

The temperature of the blood (its own metabolism being slight) is a pretty fair indication of the resultant effect of the production and the loss of heat.

For obvious reasons, the temperature of different parts of the body of man and other animals varies.

The statements of observers in regard to the temperature of various animals and of different parts of the body disagree in a way that would be puzzling, were it not known how difficult it is to procure perfectly accurate thermometers, not to mention individual differences. The axillary temperature is about 37.5° C.; that of the mouth a little higher, and of the rectum or vagina slightly more elevated. The mean temperature of the blood is placed at 39° C.

It is a very striking fact, however, that the different parts of the body ordinarily accessible by a thermometer vary so little—not more perhaps than a degree or a degree and a half. The temperature of the hepatic vein has been put down as 39.7° , and it contains the warmest blood of the body.

Comparative.—The temperature of various groups of animals has been stated to be as follows: Gull, 37.8° ; swallow, 44.03° ; dolphin, 35.5° ; mouse, 41.1° ; snakes, 10° to 12° , but higher in large specimens (python). Cold-blooded animals have a temperature a little higher (less than 1° C. usually) than the surrounding air. During the swarming of bees the hive temperature may rise from 32° to 40° . All cold-blooded animals have probably a higher temperature in the breeding-season. In our domestic mammals the normal temperature is not widely different from that of man.

Variations in the average temperature are dependent on numerous causes which may affect either the heat production or heat loss: 1. Change of climate has a very slight but real influence, the temperature being elevated a fraction of a degree when an individual travels from the poles toward

the equator, and the same may be said of the effect of the temperature of a warm summer day as compared with a cold winter one. The wonder is that, considering the external temperature, the variation is so light. 2. Starvation lowers the temperature, and the ingestion of food raises it slightly, the latter increasing, the former decreasing, the rate of the metabolic processes. 3. Age has its influence, the very young and the very old, in whom metabolism (oxidation) is feeble, having a lower temperature. This especially applies to the newly-born, both among mankind and the lower mammals; and, as might be supposed, the temperature falls during sleep, when all the vital activities are diminished. The same remark applies with greater force to the hibernating state of animals. 4. Very interesting are the fluctuations of temperature occurring daily, as shown by the curves of Fig.

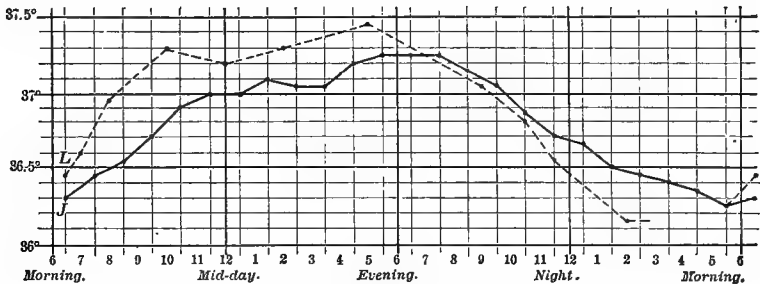

FIG. 340.—Variations of the daily temperature in health during 24 hours: L., after Liebermeister; J., after Jürgenson (from Landois).

340. It will be noticed that the period of greatest bodily warmth is between about four and seven o'clock in the afternoon and the minimum temperature between two and five in the morning.

It will be inferred, from the facts and figures already cited, that different kinds of food have considerably different capacity for heat production. The following estimates will still further tend to illustrate this:

Animal diet produces.....	2,779,524	heat-units
Food free from nitrogen.....	2,059,500	“ “
Mixed diet.....	2,200,200	“ “
Absence of food, the heat amounts to..	2,012,816	“ “

It is well known that a man when working not only feels warmer, but actually produces more heat. The following figures will give (approximately) some definite in-

formation on this subject, the numbers denoting the heat-units produced :

RESTING DAY.		WORKING DAY.		
Rest, 16 hours.	Sleep, 8 hours.	Rest, 8 hrs.	Work, 8 hrs.	Sleep, 8 hrs.
2470.4	320	1235.2	216.99	320
Total,	2790.4	Total,	3724.8	

It appears from a multitude of considerations that the body is like a steam-engine, producing heat and doing work ; but it is found that while a very good steam-engine, as a result of the chemical processes going on within it, converts $\frac{1}{3}$ of the potential energy of its supplies into mechanical work, the other $\frac{2}{3}$ appearing as heat, the body produces $\frac{1}{3}$ as work and $\frac{2}{3}$ as heat, from its income of food and oxygen.

While it is perfectly clear that it is in the metabolic processes of the body that we must seek for the final cause of the heat produced, it is incumbent on the physiologist to explain the remarkable fact that the mammalian body maintains, under a changing external temperature and other climatic conditions, and with a varying diet, during rest and labor, a temperature varying within, usually, no more than a fraction of a degree centigrade. This we shall now endeavor to explain in part.

The Regulation of Temperature.—It is manifest from the facts adduced that so long as life lasts heat is being of necessity constantly produced. If there were no provision for getting rid of a portion of this heat, it is plain that the body would soon be consumed as effectually as if it were placed in a furnace. We observe, however, that heat is being constantly lost by the breath, by perspiration (insensible), by conduction and radiation from the surface of the body, and periodically by the urine and fæces. We have seen that, while heat is being produced in all the tissues and organs of the body, some are especially thermogenic, as the glands and muscles. The skin presents an extensive surface, abundantly supplied with blood-vessels, which when dilated may receive a large quantity of blood, and when contracted may necessitate a much larger internal supply, in the splanchnic region especially. It is a matter of common observation that, when an individual exercises, the skin becomes flushed, and so with the increased production of heat, especially in the muscles (see page 195), there is a provision for unusual escape of the surplus ; at the same time sweat breaks out visibly, or if not, the insensible perspiration

is generally increased; and this accounts for an additional increment of loss; while the lungs do extra work and exhale an increased quantity of aqueous vapor, so that in these various ways the body is cooled. Manifestly there is some sort of co-ordination between the processes of heat production and heat expenditure. The vaso-motor, secretory, and respiratory functions are modified. Even if an individual do no work at all, as when in a Turkish bath, it becomes evident, to one submitting to the experiment (for such it is or may become), that the pulse and respirations are quickened and that there is copious secretion of sweat following on reddening of the skin, owing to vascular dilatation. Exact quantitative estimation of the heat produced, as seen above, and of the oxygen used, the carbonic anhydride and watery vapor exhaled, shows that the organs of which we are speaking are not only apparently but actually doing more work. It is usual to quote the case of Drs. Fordyce and Blagden, who learned to endure without injury a heat of 127° C. (260° F.), to illustrate the great adaptability of our own organism in this respect. We may suppose that the various co-ordinations effected, chiefly at all events through the central nervous system, and not by the direct action of the heat upon local nervous mechanisms, or the tissues themselves directly, are reflexes.

The production of heat, however, seems to be equally under the influence of the nervous system, though we know less about the details of the matter.

A cold-blooded animal differs from a warm-blooded one in that its temperature varies with the surrounding medium more; hence the terms *poikilothermer* and *homiothermer* for cold-blooded and warm-blooded, would be appropriate.

Such an animal, as a frog or turtle, may have its chemical processes slowed or quickened, almost like those going on in a test-tube or crucible, by altering the temperature. Very different is it, as we have seen, in the normal state of the animal with any mammal. Hence hibernation or an allied state has become a necessary protection for poikilothermers, otherwise they would perish outright, and the groups become extinct in northern latitudes. Now, when a mammal is poisoned with curare, it becomes like a poikilothermer. Like the latter, under increase of temperature, it too uses more oxygen and produces more carbonic anhydride. When certain parts of the brain are divided or punctured, a fall, similar to that observable when curare is given, is observable.

It is plain that vaso-motor changes alone can not explain these effects; and, though possibly a part of the rise of temperature, following exposure of the naked body in a cool air, may be accounted for by the increased metabolism of internal organs, accompanying the influx of blood caused by constriction of the cutaneous capillaries, it is probable that in this as in so many other instances the blood and circulation have been credited with too much, and the direct influence of the nervous system on nutrition and heat production overlooked or underestimated. The thermogenic center has not yet been definitely located, though some recent investigations seem to favor a spot in or near the corpus striatum for certain mammals. Some investigators also recognize a cortical heat-center. It has been suggested that we may to advantage speak of a *thermotoxic* (regulative of loss) and a *thermogenic* mechanism (regulative of production), and even a *thermolytic* or discharging mechanism. It has been further suggested that different nerve-fibers may be concerned in the actual work of conveying the different impulses of these respective mechanisms to the tissues; and the whole theory has been framed in accordance with the prevalent conception of metabolism as consisting of anabolism and catabolism, or constructive and destructive processes. But these theories have not yet been confirmed by experiments on animals, though they are, in the opinion of their authors, in harmony with the facts of fever. Certainly, any theory that will imply that vital processes are more under the control of the nervous system than has hitherto been taught, will, we think, advance physiology, as will shortly appear from our own discussion of the influence of the nervous system on the various metabolic processes generally.

The phenomena observable in an animal gradually freezing to death point strongly to the direct influence of the nervous system on the production as well as the regulation of heat. The circulation must of course be largely concerned, but it appears as though the nervous system refused to act when the temperature falls below a certain point. A low temperature favors hibernation, in which we believe the nervous system plays the chief part, though the temperature in itself is not the determining cause, as we have ourselves proved. The fact that the whole metabolism of a hibernating animal is lowered, that with this there is loss of consciousness much more profound than in ordinary sleep, of itself seems to indicate that the nervous system is at the bottom of the whole matter.

Pathological.—It is found that many drugs and poisons lower temperature, acting in a variety of ways. In certain diseases, as cholera, the temperature may sink to 23° C. in extreme cases before death supervenes. When the temperature of the blood is raised 6° C. (as in sunstroke, etc.), death occurs; and it is well known that prolonged high temperature leads to fatty degeneration of the tissues generally. All the evidence goes to show that in fever both the heat production and the heat expenditure are interfered with; or, at least, if not always, that there may be in certain cases such a double disturbance. In fever excessive consumption of oxygen and production of carbon dioxide occur, the metabolism is quickened, hence its wasting (consuming) effects; the rapid respiration tends to increase the thirst, from the extra amount of aqueous vapor exhaled. The body is actually warmest during the “cold stage” of ague, when the vessels of the skin are constricted and the patient feels cold, because the internal metabolism is heightened; while the “sweating stage” is marked by a natural fall of temperature. The fact that the skin may be dry and pale in fever shows that the thermotoxic nervous mechanism is at fault; but the chemical facts cited above (excess of CO₂, etc.) indicate that the thermogenic mechanism is also deranged.

SPECIAL CONSIDERATIONS.

If the student will now read afresh what has been written under the above heading in relation to the subject of digestion, it will probably appear in a new light. We endeavored to show that, according to that general principle of correlation which holds throughout the entire organism, and in harmony with certain facts, we were bound to believe that digestion and assimilation, or, to speak in other terms, the metabolic processes of the various tissues, in a somewhat restricted sense, were closely related. Beneath the common observation that “digestion waits on appetite” lies the deeper truth that food is not prepared in the alimentary canal (digested) without some relation to the needs of the system generally. In other words, the voice of the tissues elsewhere is heard in the councils of the digestive track, and is regarded; and this is effected chiefly through the nervous system. Gluttony may lead to vomiting or diarrhoea—plain ways of getting rid of what can not be digested. But how is it that a hungry man who has been without food for twenty-four hours can digest with ease a quantity

of food, taken at one meal, that would otherwise lead to the above-noted attempts at its removal? It is a mistake to explain the result with reference to the alimentary tract alone. The entire metabolism of the body has a voice in the matter. From this point of view, the benefit of abstinence from specific articles of diet, partial or complete, of taking at times very light meals, and much more that experience warrants, receives an explanation. Too little attention seems to have been given to this aspect of the subject that we are now endeavoring to present briefly.

Until the nature of metabolism is more completely understood, it will be impossible to treat the subject of diet, either in health or disease, with such confidence as to enable us to prescribe upon scientific principles alone. Very much must still be empirical, the outcome of trial and result, which is, however, after all, experiment in a crude form; and individual peculiarities that are inscrutable in their nature will always be encountered. Notwithstanding, if physicians will avail themselves of the best that is known in the realm of physiological dietetics, and then contribute the results of their observations in accurate form, substantial progress will be made in due time.

Evolution.—We have already alluded to some of those modifications in the form of the digestive organs that indicate an unexpected plasticity, and impress the fact of the close relation of form and function. The conversion of a sea-gull into a graminivorous bird, with a corresponding alteration in the nature of the form of the stomach (it becoming a gizzard), with doubtless modifications in the digestive processes, when regarded more closely, implies coadaptations of a very varied kind. These are as yet but imperfectly known or understood, and the subject is a wide and inviting field for the physiologist. Darwin and others have indicated, though but imperfectly, some of the changes that are to be regarded in animals as correlations; but in physiology the subject has received but little attention as yet. We have in several parts of this work called attention to it; but the limits of space prevent us doing little more than attempting to widen the student's field of vision by introducing such considerations. The influence of climate on metabolism, an undoubted fact, has many implications.

Any one who keeps a few wild animals in confinement under close observation, and endeavors to ascertain how their

natural, self-chosen diet may be varied when confined, will be astonished at the plasticity of their instincts, usually considered as so rigid in regard to feeding. These facts help one to understand how by the law of habit and heredity each group of animals has come to prefer and flourish best upon a certain diet. But habit itself implies an original deviation some time, in which is involved, again, plasticity of nature and power to adapt as well as to organize. Without this, evolution of function is incomprehensible; but with this principle, and the tendency for what has once been done to be easier of repetition; and, finally, to become organized, a flood of light is thrown upon the subject of diet, digestion, and metabolism generally. On these principles it is possible to understand those race differences, even individual differences, which as facts must be patent to all observers. Every individual's own history will teach him that he can learn to digest and assimilate what was once all but a poison to his organism; so that it becomes comprehensible how a Chinaman, for example, can, not only remain in health, but do a large amount of work daily on a diet on which the ordinary Englishman might well-nigh starve before he could adapt himself to it.

It is also a well-established fact that whole families crave and seem to require certain articles of diet in excess, as compared with the majority—e. g., a meat diet. In some instances, at all events, this can be traced to pathological excess in the ancestors. It is important to recognize, however, that while such a diet upon the whole may be the best that can be appropriated *at the time*, it is associated with certain aberrations of function which it is desirable to correct; hence the wisdom of withholding from such people, even children, to a certain extent, the meat which they so much crave. The habit of the metabolism may be modified. The rapid rate of speed of the metabolic processes, which an excess of such a diet is apt to beget, leads to various bad results, such as great irritability of the nervous system, and a general lack of stability and equipoise in the vital machine.

The principle of natural selection has clearly played a great part in determining the diet of a species; the surviving emigrants to a new district must be those that can adapt to the local environment best, including the food which the region supplies. The greater capability of resisting hunger and thirst in some individuals of a species implies great differences in the meta-

bolic processes, though these are mostly unknown to us; and the same remark applies to heat and cold.

It seems clear that hibernation is an acquired habit of the whole metabolism, with great changes in the functional condition of the nervous system *recurring periodically*, and, in fact, dependent on these, by which certain large divisions, as the reptiles, amphibians, and certain mammals among vertebrates, are enabled to escape individual death and extinction as groups. We may suppose that, for example, among invertebrates, by a process of natural selection, those survived that could thus adapt themselves to the environment; while, among mammals, hibernation may be considered as a process of reversion, perhaps, for the homoiothermer becomes very much a poikilothermer during hibernation, the latter again reverting to a condition existing in lower forms, and not wholly unlike that of plants in winter. This can be understood on the principle of the origin of higher from lower forms; otherwise it is difficult to understand why similar states of the metabolism should prevail in groups widely separated in form and function. If all higher groups bear a derivative relation to the lower, what is common in their nature, as we usually find them, as well as the peculiar resemblances of the metabolism of higher to lower forms in sleep, hibernation, etc., can be understood in the light of physiological reversion.

The origin of a homoiothermic (warm-blooded) condition itself is to be sought for in the principle of natural selection. It was open to certain organisms, we may assume, either to adapt to a temperature much below that of their blood, or to hibernate; failing to make either adaptation would result in death; and gradually, no doubt, involving the death of numberless individuals or species, the resisting power attained the marvelous degree that we are constantly witnessing in all homoiothermers.

The daily variations of the bodily temperature in homoiothermers is a beautiful example of the law of rhythm evident in the metabolism. Hibernation is another such. While these are clear cases, it is without doubt true that, did we but know more of the subject, a host of examples of the operation of this law might be instanced.

We can but touch on these subjects enough to show that they deserve an attention not as yet bestowed on them; and to the thoughtful it will be evident that their influence on practical life might be made very great were they but rightly ap-

prehended. In that preventive medicine of the future to which we fondly look to advance the welfare of mankind, such considerations must largely enter.

THE INFLUENCE OF THE NERVOUS SYSTEM ON METABOLISM (NUTRITION).

This subject is of the utmost importance, and has not received the attention hitherto, in works on physiology, to which we believe it is entitled, so that we must discuss it at some length.

We may first mention a number of facts on which to base conclusions: 1. Section of the nerves of bones is said to be followed by a diminution of their constituents, indicating an alteration in their metabolism. 2. Section of the nerves supplying a cock's comb interferes with the growth of that appendage. 3. Section of the spermatic nerves is followed by degeneration of the testicle. 4. After injury to a nerve or its center in the brain or spinal cord, certain affections of the skin may appear in regions corresponding to the distribution of that nerve: thus, *herpes zoster* is an eruption that follows frequently the distribution of the intercostal nerve. 5. When the motor cells of the anterior horn of the spinal cord or certain cells in the pons, medulla, or crus cerebri are disordered, there is a form of muscular atrophy which has been termed "active," inasmuch as the muscle does not waste merely, but the dwindling is accompanied by proliferation of the muscle nuclei. 6. In *acute decubitus* bed-sores form within a few hours or days of the appearance of the cerebral or spinal lesion, and this with every precaution to prevent pressure or the other conditions that favor the formation of such sores. 7. After section of both vagi, death results after a period, varying in time, as do also the symptoms, with the animal. In some animals pneumonia seems to account for death, since it is found that, if this disease be prevented, life may, at all events, be greatly prolonged. The pneumonia has been attributed to paralysis of the muscles of the larynx, together with loss of sensibility of the larynx, trachea, bronchi, and the lungs, so that the glottis is not closed during deglutition, and the food, finding its way into the lungs, has excited the disease by irritation. The possibility of vaso-motor changes is not to be overlooked. In birds, death may be subsequent to pneumonia or to inanition from paralysis of the œsophagus, food not being

swallowed. It is noticed that in these creatures there is fatty (and sometimes other) degeneration of the *heart*, liver, stomach, and muscles. 8. Section of the trigeminus nerve within the skull has led to disease of the corresponding eye. This operation renders the whole eye insensible, so that the presence of offending bodies is not recognized; and it has been both asserted and denied that protection of the eye from these prevents the destructive inflammation. With the loss of sensibility there is also vaso-motor paralysis, the intra-ocular tension is diminished, and the relations of the nutritive lymph to the ocular tissues are altered. But all disturbances of the eye in which there are vaso-motor alterations are not followed by degenerative changes. 9. Degeneration of the salivary glands follows section of their nerves. 10. After suture of long-divided nerves, indolent ulcers have been known to heal with great rapidity. This last fact especially calls for explanation. It will be observed, when one comes to examine nearly all such instances as those referred to above, that they are complex. Undoubtedly, in such a case as the trigeminus or the vagi, many factors contribute to the destructive issue; but the fact that many symptoms and lesions are concomitants does not, of itself, negative the view that there may be lesions directly dependent on the absence of the functional influence of nerve-fibers. We prefer, however, to discuss the subject on a broader basis, and to found opinions on a wider survey of the facts of physiology.

After a little time (a few hours), when the nerves of the sub-maxillary gland have been divided, a flow of saliva begins and is continuous till the secreting cells become altered in a way visible by the microscope. Now, we have learned that protoplasm can discharge all its functions in the lowest forms of animals and in plants independently of nerves altogether. What, then, is the explanation of this so-called "paralytic secretion" of saliva? The evidence that the various functions of the body as a whole are discharged as individual acts or series of acts correlated to other functions has been abundantly shown; and, looking at the matter closely, it must seem unreasonable to suppose that this would be the case if there was not a close supervision by the nervous system over even the details of the processes. We should ask that the contrary be proved, rather than that the burden of proof should rest on the other side. Let us assume that such is the case; that the entire behavior of every cell of the body is directly or indirectly con-

trolled by the nervous system in the higher animals, especially mammals, and ask, What facts, if any, are opposed to such a view? We must suppose that a secretory cell is one that has been, in the course of evolution, specialized for this end. Whatever may have been the case with protoplasm in its unspecialized form, it has been shown that gland-cells can secrete independently of blood-supply (pages 321, 416) when the nerves going to the gland are stimulated. Now, if these nerves have learned, in the course of evolution, to secrete, then in order that they shall remain natural (not degenerate) they must of necessity secrete; which means that they must be the subject of a chain of metabolic processes, of which the final link only is the expulsion of formed products. Too much attention was at one time directed to the latter. It was forgotten, or rather perhaps unknown, that the so-called secretion was only the last of a long series of acts of the cell. True, when the cells are left to themselves, when no influences reach them from the stimulating nervous centers, their metabolism does not at once cease. As we view it, they *revert* to an original ancestral state when they performed their work, lived their peculiar individual life as less specialized forms wholly or partially independent of a nervous system. But such divorced cells fail; they do not produce normal saliva, their molecular condition goes wrong at once, and this is soon followed by departures visible by means of the microscope. But just as secretion is usually accompanied by excess of blood, so most functional conditions, if not all, demand an unusual supply of pabulum. This is, however, no more a cause of the functional condition than food is a cause of a man's working. It may hamper, if not digested and assimilated. It becomes, then, apparent that the essential for metabolism is a vital connection with the dominant nervous system.

It has been objected that the nervous system has a metabolism of its own independent of other regulative influences; but in this objection it seems to be forgotten that the nervous system is itself made up of parts which are related as higher and lower, or at all events which intercommunicate and energize one another. We have learned that one muscle-cell has power to rouse another to activity when an impulse has reached it from a nervous center. Doubtless this phenomenon has many parallels in the body, and explains how remotely a nervous center may exert its power. It enables one to understand to some extent many of those wonderful co-ordinations (obscure in detail) that are constantly taking place in the body. We

think the facts as they accumulate will more and more show, as has been already urged, that the influence of blood-pressure on the metabolic (nutritive) processes has been much over-estimated. They are not essential but concomitant in the highest animals. Turning to the case of muscle we find that when a skeletal muscle is tetanized the essential chemical and electrical phenomena are to be regarded as changes differing in degree only from those of the so-called resting state. There is more oxygen used, more carbonic anhydride excreted, etc. The change in form seems to be the least important from a physiological point of view. Now, while all this can go on in the absence of blood or even of oxygen, it can not take place without nerve influence or something simulating it. Cut the nerve of a muscle, and it undergoes fatty degeneration, and atrophies. True, this may be deferred, but not indefinitely, by the application of electricity, acting somewhat like a nerve itself, and inducing the approximately normal series of metabolic changes. If, then, the condition when not in contraction (rest) differs from the latter in all the essential metabolic changes in rate or degree only; and if the functional condition or accelerated metabolism is dependent on nerve influence, it seems reasonable to believe that in the resting condition the latter is not withheld.

Certain forms of paralysis (e. g., hysterical) are not followed by atrophy. Why? Because in this form the nerve influence is still exerted.

The recent investigations on the heart make such views as we are urging clearer still. It is known that section of the vagi leads to degeneration of the cardiac structure. We now know that this nerve contains fibers which have a diverse action on the metabolism of the heart, and that, according as the one or the other set is stimulated, so does the electrical condition vary; and everywhere, so far as known, a difference in electrical conditions seems to be associated with a difference in metabolism, which may be one of degree only, perhaps, in many instances—still a difference. The facts as brought to light by experimental stimulation harmonize with the facts of degeneration of the cardiac tissue on section of the vagi; but this is only clear on the view we are now presenting, that the action of the nervous system is not only universal, but that it is *constant*; that function is not an isolated and independent condition of an organ or tissue, but a part of a long series of metabolic changes. It is true that one or more

of such changes may be arrested, just as all of them may go on at a less rate, if this actual outpouring of pancreatic secretion is not constant; but secretion is not summed up in discharge merely; and, on the other hand, it would seem that in some animals the granules of the digestive glands are being renewed while they are being used up, in secreting cells. The processes may be simultaneous or successive. Nor do we wish to imply that the nervous system merely holds in check or in a very general sense co-ordinates processes that go on unoriginated by it. We think the facts warrant the view that they are in the highest mammals either directly (mostly) or indirectly originated by it, that they would not take place in the absence of this constant nervous influence. The facts of common observation, as well as the facts of disease, point in the strongest way to such a conclusion. Every one has experienced the influence, on not one but many functions of the body, we might say the entire metabolism, of depressing or exalting emotions. The failure of appetite and loss of flesh and mental power under the influence of grief or worry, tell a plain story. Such broad facts are of infinitely more value in settling such a question as that now discussed than any *single* experiment. The best test of any theory is the extent to which it will explain the whole round of facts. Take another instance of the influence over metabolism of the nervous system.

Every athlete knows that he may overtrain—i. e., he may use his muscles so much as to disturb the balance of his powers somewhere—very frequently his digestion; but often there seems to be a general break—the whole metabolism of the body seems to be out of gear. If we assume a constant nervous influence over the metabolic processes, this is comprehensible. The centers can produce only so much of what we may call nervous force, using the term in the sense of directive power; and if this be unduly diverted to the muscles, other parts must suffer. The same holds of excessive mental application.

On this view also the value of rest or change of occupation becomes clear. The nervous centers are not without some resemblance to a battery; at most, the latter can generate only a definite quantity of electricity, and, if a portion of this be diverted along one conductor, less must remain to pass by any other.

It is of practical importance to recognize that under great excitement unusual discharges from a nerve-center may lead to unwonted functional activity: thus, under the stimulus of

the occasion a man may in a boat-race originate muscular contractions that he could not by the strongest efforts of his will call forth under other circumstances. Such are always dangerous. We might speak of a reserve or residual nerve force, the expenditure of which results in serious disability. It also applies to mental and emotional effects as well as muscular, and seems to us to throw light upon many of the failures and successes (so called) of life.

It seems that our past views of secretion and nutrition have been partial rather than erroneous in themselves, and it is a question whether it would not be well to substitute some other terms for them, or at least to recognize them more clearly as phases of a universal metabolism. We appear to be warranted in making a wider generalization. To regard processes concerned in building up a tissue as apart from those that are recognized as constituting its function, seems, with the knowledge we at present possess, to be illogical and unwise. Whether, in the course of evolution, certain nerves, or, as seems more likely, certain nerve-fibers in the body of nerve-trunks, have become the medium of impulses that are restricted to regulating certain phases of metabolism—as, e. g., expulsion of formed products in gland-cells—is not, from a general point of view, improbable, and is a fitting subject for further investigation. But it will be seen that we should regard all nerves as “trophic” in the wider sense. What is most needed, apparently, is a more just estimation of the relative parts played by blood and blood-pressure, and the direct influence of the nervous system on the life-work of the cell. These views are greatly strengthened by the facts, well known to every observer of disease in the human subject. The preponderating development of the cerebrum in man must be taken into account in the working of every organ. To have a healthy stomach, liver, kidneys, etc., is not enough; for real health, all the parts of that great complex of organs we call the brain must not only work, but work in concert.

We must regard the nervous centers as the source of ceaseless pulses that operate upon all parts, originating and controlling the entire metabolism, of which what we term functions are but certain phases, parts of a whole, but essential for the health or normal condition of the tissues. Against such a view we know no facts, either of the healthy or disordered organism.

Summary of Metabolism.—Very briefly, and somewhat incom-

pletely, we may sum up the chief results of our present knowledge (and ignorance) as follows:

Glycogen is found in the livers of all vertebrate and some invertebrate animals. The quantity varies with the diet, being greatest with an excess of carbohydrates.

It seems likely that glycogen is manufactured from the protoplasm of the liver-cells, though it is possible that the latter may act on substances contained in the lymph, and convert them into glycogen which they store up. The phenomena of *diabetes mellitus* seem to indicate that vaso-motor effects in the liver are not essential to the formation of the excess of sugar in that disease, which excess is only one symptom, there being frequently also a largely increased secretion of urea; but inasmuch as the nervous system is greatly deranged in this malady, the symptoms, etc., of the disease as a whole may be rather regarded as showing how important is the due influence of the nervous system.

Glycogen may be regarded as stored material to be converted into sugar, as required by the organism; though the exact use of the sugar and the method of its disposal are unknown.

Fat is not stored up in the body as the result of being merely picked out from the blood ready made; but is a genuine product of the metabolism of the tissues, and may be formed from fatty, carbohydrate, or proteid food. This becomes especially clear when the difference in the fat of animals from that on which they feed is considered, as well as the direct results of feeding experiments, and the nature of the secretion of milk.

The liver seems to be engaged in a very varied round of metabolic processes: the manufacture of bile, of glycogen, of urea, and probably of many other substances, some known and others unknown, as chemical individuals. Urea is in great part probably only appropriated by the kidney-cells (Amœba-like) from the blood in which it is found ready-made; though it may be that a part is formed in these cells, either from bodies some steps on the way toward urea, or out of their protoplasm, as fat seems to be by the cells of the mammary gland.

The leucin (and tyrosin?) of the digestive canal sustains some relation to the manufacture of urea by the liver, and possibly by the spleen and other organs; for an animal diet increases these products, and also the urea excreted. Creatin, one of the products of proteid metabolism, and possibly allied bodies, may be considered as in a certain sense antecedents of

urea: uric acid, however, does not seem to be such, nor is it to be regarded as a body that has some of it escaped complete oxidation, but rather as a result of a distinct departure of the metabolism; and there are facts which seem to indicate that the uric-acid metabolism is the older, from an evolutionary point of view, and that in mammals, and especially in man, as the results of certain errors there may be a physiological (or pathological) reversion. Hippuric acid, as replacing uric acid in the herbivora, may be regarded in a similar light.

Our knowledge of the metabolism of the spleen, beyond its relations to the formation of blood-cells and their disintegration, is in the suggestive rather than the positive stage. It seems highly probable that this organ plays a very important part, the exact nature of which is as yet unknown.

When an animal starves, it may be considered as feeding on its own tissues, the more active and important utilizing the others. Notwithstanding, organs with a very active metabolism, as the muscles and glands, lose weight to a large extent. The presence of urea to an amount not very greatly below the average in health, shows that there is an active proteid metabolism then as at all times in progress.

General experience and exact experiments prove that, while an animal's diet may be supplied with special regard to fattening, to increase working power, or simply to maintain it in health, as evidenced by breeding capacity, form, etc., in all cases there must be at least a certain minimum quantity of each of the food-stuffs. No one food can be said to be exclusively fattening, heat-forming, or muscle-forming.

A carbohydrate diet tends to production of fat; flesh, and other proteid food to supply muscular energy, but the latter also produces fat, and a diet of flesh mixed with fat or gelatin will serve the purposes of the economy better than one containing a very much larger quantity of proteid alone. Muscular energy, as is to be inferred from the excreta, is not the result of nitrogenous metabolism alone; and in arranging any diet for man or beast the race and the individual must be considered. Animals can not be treated as machines, like engines using similar quantities of fuel; though this holds far more of man than the lower animals—i. e., the results may be predicted from the diet with far less certainty in the case of man than of other mammals.

Food is related to excreta in a definite way, so that all that enters as food must sooner or later appear as urea, salts, car-

bonic anhydride, water, etc. These are individually to be regarded as the final links in a long chain of metabolic processes or rather a series of these. Fats and carbohydrates are represented finally as carbonic anhydride and water principally, proteids as urea.

Nitrogenous foods may be regarded as accelerating the metabolic processes generally and proteid metabolism in particular, while fats have the reverse effect; hence fat in the diet renders a less quantity of proteid sufficient. Gelatine seems to act when mixed with proteid food either like an additional quantity of proteid, or possibly like fat, at all events under such circumstances less proteid suffices.

These facts have a bearing not only on health but on economy, in the expenditure for food.

Salts hold a very important place in every diet, though their exact influence is in great part unknown. The heat of the body is the resultant of all the metabolic processes of the organism, especially the oxidative ones. Certain food-stuffs have greater potential capacity for heat formation than others; but, finally, the result depends on whether the organism can best utilize one or the other.

A certain body temperature, varying only within narrow limits, is maintained, partly by regulation of the supply and partly by the regulation of the loss.

Both these are, in health, under the direction of the nervous system, and both are co-ordinated by the same. Loss is chiefly through the skin and lungs; gain chiefly through the organs of most active metabolism, as the muscles and glands.

Vaso-motor effects play a great part in the escape of heat.

Animals may be divided into poikilothermers and homoiothermers, or cold-blooded and warm-blooded animals, according as their body heat varies with or is independent of the external changes of temperature. All the facts go to show that in mammals the processes of the body (metabolism) can continue only within a slight range of variations in temperature, though the upward limit is narrower than the downward.

Upon the whole, the evidence justifies the conclusion that the nervous system is concerned in all the metabolic processes of the body in mammals including man, and that, as we descend the scale, the dominion of the nervous system becomes less till we reach a point when protoplasm goes through the whole cycle of its changes by virtue of its own properties uninfluenced by any modification of itself in the form of a nervous system.

THE SPINAL CORD.—GENERAL.

Among the higher vertebrates the spinal cord is found to consist of nerve-cells, nerve-fibres, and a delicate connective tissue binding them together; while these different structures are arranged in definite forms, so that a cross-section anywhere presents a characteristic appearance, the more important ganglionic nerve-cells being internal and forming a large part of .



FIG. 341.—General view of nervous system of man (after Mivart). 1, cerebrum; 2, cerebellum; 3, upper part of spinal cord.

the gray matter of the cord. All the various regions of this organ or series of organs are connected with one another, white with white and gray matter, as well as white with gray sub-

stance. The cord may be regarded either as an instrument for the reception and generation of impulses independent of the

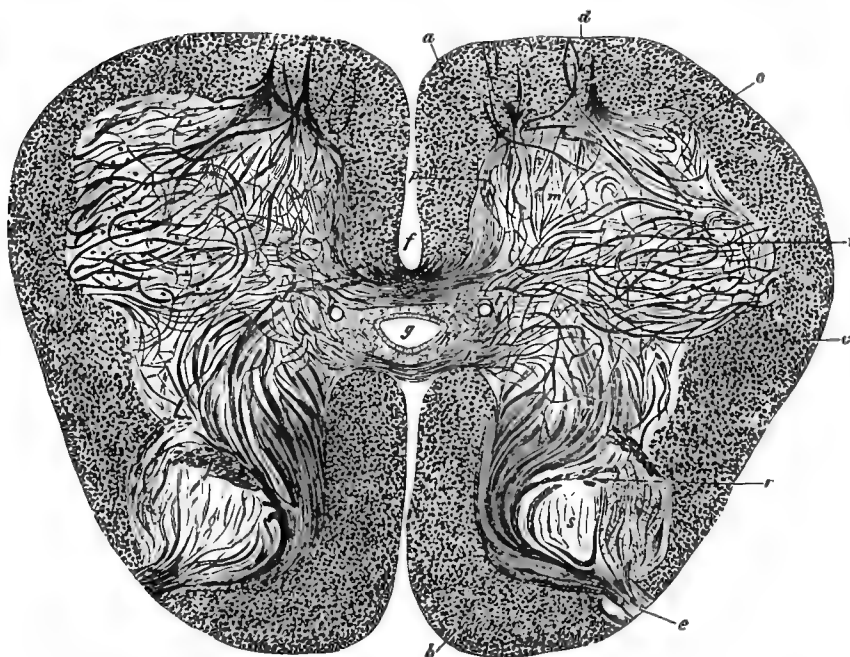

FIG. 342.—Transverse section of spinal cord of child six months old, at middle of lumbar region, showing especially the fibers of gray substance. 1×90 . (After Gerlach.) *a*, anterior columns; *b*, posterior columns; *c*, lateral columns; *d*, anterior roots; *e*, posterior roots; *f*, anterior white commissure; *g*, central canal lined by epithelial cells; *h*, connective-tissue substance surrounding it; *i*, transverse fibers of gray commissure in front, and *k*, the same behind central canal; *l*, two veins cut across; *m*, anterior cornua; *n*, great lateral cell group of anterior cornua; *o*, lesser anterior cell group (column); *p*, smallest median cell group; *q*, posterior cornua; *r*, ascending fasciculi in posterior cornua; *s*, substantia gelatinosa.

brain; or as a conductor of afferent and efferent impulses destined for the brain or originating in that organ. As a matter of fact, however, it is better to bear in mind that the cord and brain constitute one organ or chain of organs, which, as we have learned from our studies in development, are differentiations of one common track, originating from the epiblast.

While the brain and the cord may act independently to a very large extent, as may be shown by experiment, yet it can not be too well borne in mind that in the actual normal life of an animal such purely independent behavior must be exceedingly rare. We are constantly in danger, in studying a subject, of making in our minds isolations which do not exist in nature. When one accidentally sits upon a sharp object, he

rises suddenly without a special effort of will power ; he experiences pain, and has certain thoughts about the object, etc.



FIG. 343.—Group of cells in connection with anterior roots of spinal nerves, as seen in transverse section of spinal cord of sheep (after Flint and Dean). *A*, emergence of anterior roots from gray matter ; *b, b, b*, cells connected both with each other and with fibers of anterior roots.

Now, in reality this is very complex, though it can be analyzed into its factors. Thus, afferent nerves are concerned, the spinal cord as a reflex center, efferent nerves to the muscles called into action, the cord as a conductor of impulses which result in sensations, emotions and thoughts referable to the brain ; so that if we would grasp the state of affairs it is of importance

to so combine the various processes in our mental conception that it shall in our minds form that whole which corresponds



FIG. 344.

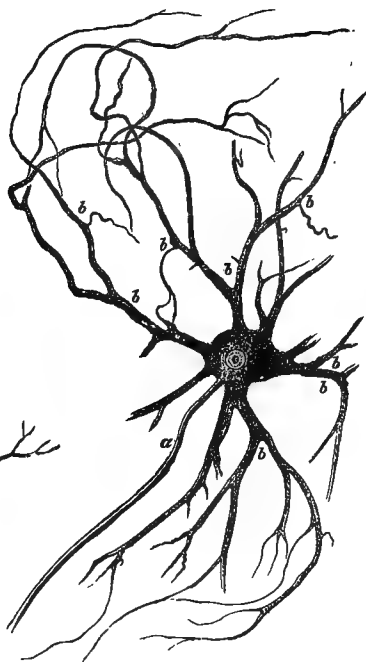

FIG. 345.

FIG. 344.—Division of a slender nerve-fiber, and communication of its branches with highly ramifying processes of two nerve-cells from spinal cord of ox. 1×150 . (After Gerlach.)
 FIG. 345.—Multipolar ganglion cell from anterior gray matter of spinal cord of ox (after Deiters). *a*, axis cylinder process; *b*, branched processes.

with nature, as we have been insisting upon in the last chapter. With this admonition, and assuming a good knowledge of the

general and minute anatomy of the spinal cord, we shall proceed to discuss its functions.

THE REFLEX FUNCTIONS OF THE SPINAL CORD.

The following experimental observations may readily be made by the student himself: Let a decapitated frog be suspended freely (from the lower jaw). It hangs motionless and limp at first, but when it recovers from the shock (abolition of function) to the spinal cord produced by the operation, it may be shown that this organ is functional: 1. When a piece of bibulous paper dipped in dilute acid is placed upon the thigh, the leg is drawn up and wipes away the offending body. 2. If the paper be placed on the anus, both legs may be drawn up, either successively or simultaneously. 3. If the leg of one side be allowed to hang in the dilute acid, it will be withdrawn. 4. If a small piece of blotting-paper dipped in the acid, be placed on the thigh, and the leg of that side gently held, the other may be drawn up and remove the object.

It may be noticed that in every case a certain interval of time elapses before the result follows. Upon increasing the strength of the acid very much this interval is shortened, and the number of groups of muscles called into action is increased. Again, the result is not the same in all respects when the nerve of the leg is directly stimulated, as when the skin first receives the impression. Section of the nerves of the parts abolishes these effects; so also does destruction of the spinal cord, or the part of it with which the nerves of the localities stimulated are connected; and more exact experiments show that in the absence of the gray matter the section of the posterior or anterior roots of the nerves also renders such manifestations as we have been describing impossible.

These experiments and others seem to show that an afferent nerve, an efferent nerve, and one or more central cells are necessary for a reflex action; that the latter is only a perfectly co-ordinated one when the skin (end-organs) and not the nerve-trunks are stimulated; that there is a latent period of stimulation, suggesting a central "summation" of impulses necessary for the effect; that the reflex is not due to the mere passage of impulses from an afferent to an efferent nerve through the cord, but implies important processes in the central cells themselves. The latter is made further evident from the fact that (1) strychnia greatly alters reflex action by short-

ening the latent period and extending the range of muscular action, which, it has been shown, is not due to changes in the nerves themselves. A very slight stimulus suffices in this instance to cause the whole body of a decapitated frog to pass into a tetanic spasm. We must suppose that the processes usually confined to certain groups of central cells have in such a case involved others, or that the "resistance" of the centers of the cord has been diminished, so that many more cells are now involved; hence many more muscles called into action. Normally there is resistance to the passage of an impulse to the opposite side of the cord, as is shown by the fact that when a slight stimulus is applied to the leg of one side the reflex is confined to this member.

It is evident, then, that the reflex resulting is dependent on (1) the location of the stimulus, (2) its intensity and duration, (3) its character, and (4) the condition of the spinal cord at the time. Occasionally on irritating one fore-limb the opposite hind one answers reflexly. Such is a "crossed reflex," and is the more readily induced in animals the natural gait of which involves the use of one fore-leg and the opposite hind-limb together.

Reflexes are often spoken of as purposive, and suggest at first intelligence in the cord; but such phenomena are explained readily enough without such a strained assumption.

Evolution, heredity, and the law of habit, apply here as elsewhere. The relations of an animal to its environment must necessarily call into play certain nervo-muscular mechanisms, which from the law of habit come to act together when a stimulus is applied. Naturally those that make for the welfare of the animal are such as are most used under the influence of the intelligence of the animal—i. e., of the domination of the higher cerebral centers, so that when the latter are removed it is but natural that the old mechanisms should be still employed. Moreover, the reflex movements are not always beneficial, as when a decapitated snake coils itself around a heated iron under reflex influence, which is readily enough understood if we remember the *habit* of coiling around objects, and what this involves—viz., organized tendencies.

Inhibition of Reflexes.—It can be shown in the case of a frog that still retains its optic lobes and the parts of the brain posterior to them that, when these are stimulated at the same time as the leg, the reflex, if it occurs at all, is greatly delayed.

On the other hand, in the case of dogs, from which a part

of the cerebral cortex has been removed, the reflexes are much more prominent than before. Experience teaches us that the acts of defecation, micturition, erection of the penis, and many others, are susceptible of arrest or may be prevented entirely when the usual stimuli are still active, by emotions, etc.

These and numerous other facts tend to show that the higher centers of the brain can control the lower; and it is not to be doubted that pure reflexes during the waking hours of the higher animals, and especially of man, are much less numerous than among the lower vertebrates. The cord is the servant of the brain, and a faithful and obedient one, except in cases of disease, to some forms of which we have already referred.

Certain recent experiments show in the clearest way how the conditions of the central nervous system, and especially in the first instance, the brain determines the reflex time to which we shall presently refer: thus, among other influences, music and even different airs greatly alter the reflex-time, and, indeed, the whole character of the act (tendon-reflex).

It is not to be supposed, however, that the processes that are clearly cerebral, and which modify normal reflexes so greatly, are all of the nature of inhibitions, or that they are at all fully understood. They are unquestionably very complex in nature, and probably too intricate to be completely unraveled.

Reflex Time.—One of the most satisfactory methods of ascertaining the length of time a reflex act occupies is the following: Let an electric stimulus be applied to one of the eyelids, whereupon both blink. The whole interval, minus the latent period of the orbicularis muscle and the time occupied in the transmission of the necessary nervous impulses over the nerves concerned (the fifth and facial) to and from the centers involved (medulla), gives the duration of the processes in the brain-cells. The whole period in one instance was $\cdot 0662$ seconds, which, reduced as indicated, gives $\cdot 0555$ as the time required for the changes that take place in the brain-cells.

It will, of course, be understood that at best these figures are but an approximation, owing to several possible sources of error; also that, as has been already stated, the actual period varies with the condition of each subject at the time of experiment, not to mention the variations for individuals and groups of animals. In the instance chosen the brain itself was the center involved, but the same laws apply to the reflex mechanisms of the cord.

THE SPINAL CORD AS A CONDUCTOR OF IMPULSES.

Before considering the results arrived at in this connection, some brief account of the methods applied in the investigation of the subject is called for, to enable the student to appreciate their difficulties and possible fallacies, as well as such grounds of certainty as there may be for the conclusions reached.

Three or four methods of research have been employed: 1. Sections of the spinal cord of varying extent, both unilateral and bilateral. In estimating the value to be attached to the symptoms following, the difficulties in limiting the section, the interference of hæmorrhage, the inevitable results of operative shock, and, as in all experiments on the nervous system of animals, the danger of misinterpreting the symptoms, must be given due weight. 2. Attempts have been made to determine the course and relations of nerve-fibers by ascertaining the order in which the different portions of the spinal nerve-fibers receive their investing myelin, those with the longest course being the latest to be thus completed. This is the method of Flechsig, who has mapped out the cord into a series of columns, to be referred to again presently. The method is open to the objection of all anatomical ones. It is a remarkable fact that, by strictly physiological methods (i. e., ascertaining the function of parts), nervous tracts have been traced, which were quite unsuspected as the result of anatomical investigation alone. Nevertheless, this method, taken with others now under consideration, has rendered important service. 3. Following upon experimental sections, as well as in consequence of certain diseases in the brain and cord, fibers have been found to degenerate along certain definite paths, owing, it is believed, to being cut off from their trophic centers; so that if, after section of the cord, there is degeneration of fibers downward, it is inferred that the trophic cells lie above the seat of degeneration and the reverse. This may be called the pathological (Wallerian) method, and in conjunction with clinical evidence has, in the case of man especially, been the chief source, perhaps, of our knowledge in regard to the conducting paths in the human cord; though other methods, as carried out in the lower animals, have yielded results which have been supplementary and corrective; and in truth a variety of means must be employed, and the greatest caution observed, or the inferences drawn will be partial if not actually erroneous.

It is to be carefully borne in mind now, and when studying

the brain, that a conducting path in the nervous centers is not synonymous with conducting fibers. The cells themselves and the neuroglia probably are also conductors. We shall now endeavor to map out, as established by the method of Flechsig, Waller, and others, the main fiber tracts of the spinal cord.

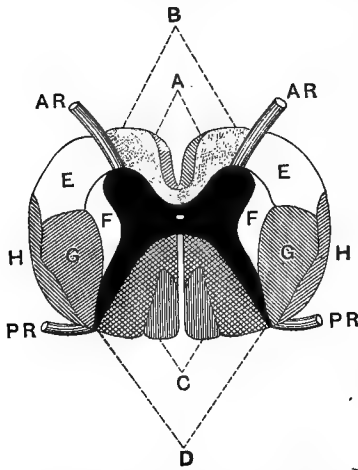

FIG. 346.—Diagrammatic representation of columns and conducting paths in spinal cord in upper dorsal region (after Flint and Landois). AR, AR, anterior roots of spinal nerves; PR, PR, posterior roots; A, A, columns of Türck (antero-median columns); B, anterior fundamental fasciculus; C, columns of Goll; D, columns of Burdach; E, E, anterior radicular zones; F, F, mixed lateral columns; G, G, crossed pyramidal tracts; H, H, direct cerebellar fibers.

the neuroglia probably are also conductors. We shall now endeavor to map out, as established by the method of Flechsig, Waller, and others, the main fiber tracts of the spinal cord.

1. *Antero-median Columns* (columns of Türck). These probably decussate in the cervical region, where they are most marked, constituting the direct or uncrossed pyramidal tract, and disappear in the lower dorsal region.

Secondary degeneration ensues in these tracts upon certain brain-lesions, in the motor regions.

2. *Crossed Pyramidal Tracts*.—They pass forward to form part of the anterior pyramids of the medulla after decussation

in their lower part. Similarly to the first, degeneration follows in these tracts when there are brain-lesions of the motor area. Hence, both of these constitute descending motor paths.

3. *Anterior Fasciculi* (fundamental or ground bundle).—They possibly connect the gray matter of the cord with that of the medulla.

4. *Anterior Radicular Zones*, in the anterior part of the lateral column.

5. *Mixed Lateral Columns*.—These and the preceding are functionally similar to 3. Neither 3, 4, nor 5 degenerate, on section of the cord, from which it is inferred that they have trophic cells both above and below.

6. *Direct Cerebellar Tracts*.—These bundles, passing by the funiculi graciles or posterior pyramids of the medulla, reach the cerebellum by its inferior peduncles.

These fasciculi enlarge from their site of origin in the lumbar cord upward. After section of the cord they show ascending degeneration, so that it seems probable that their trophic

cells are to be referred to the posterior gray cornua of the cord, which they connect in all probability with the cerebellum.

7. *Columns of Burdach* (postero-lateral columns).—This tract is connected with the restiform bodies and reaches the cerebellum by the inferior peduncles. Secondary degenerations do not occur in these fasciculi, so that it seems likely that they connect nerve-cells at different levels in the cord; and they may also connect the posterior gray cornua with the cerebellum as 6.

Columns of Goll (postero-median columns).—They do not extend beyond the lower dorsal or upper lumbar region; and their fibers pass to the funiculi graciles of the medulla. Ascending degeneration follows section of these columns.

The degenerations referred to above are visible by the microscope, and of the character following section of nerves. It is probable that they are the later stages of a primary molecular derangement in consequence of interference with that continuous functional connection between all parts on which what has been called nutrition, but which we have shown is but a phase of a complex metabolism, depends.

Decussation.—Sections of the cord, when confined to one lateral half, are followed by paralysis on the same side and loss of sensation, confined chiefly to the opposite half of the body below the point of section. The results of experiment, pathological investigation, etc., have rendered it clear that—1. The great majority of the fibers passing between the periphery and the brain decussate somewhere in the centers. 2. Afferent fibers cross almost directly but also to some extent along the whole length of the cord from their point of entrance, the decussation being, however, completed before the medulla is passed. 3. Motor or efferent fibers decussate chiefly in the medulla, though crossing is continued some distance down the cord, such latter fibers being but a small portion of the whole. This fact is best established, perhaps, by noting the results of brain-lesions. With few exceptions, susceptible of explanation, a lesion of one side of the cerebrum is followed by loss of motion of the opposite side of the body. These are all central, well-established truths. It is also now pretty well determined that voluntary motor impulses descend by the pyramidal tracts, both the direct and the crossed. That the posterior columns of the cord are in some way concerned with sensory impulses there is no doubt; but when an attempt is made to decide details, great difficulties are encountered. Experiments on

animals are of necessity very unsatisfactory in such a case, from the difficulty experienced in ascertaining their sensations at any time, and especially when disordered.

Pathological.—A good deal of stress has been laid upon the teachings of locomotor ataxia in the human subject. The symptoms of this disease are found associated with lesions of the posterior columns of the cord. The essential feature is an inability to co-ordinate movements, though muscular power may be unimpaired. But such inco-ordination is not usually the only symptom; and, while the disease seems usually to begin in Burdach's columns, the columns of Goll, the posterior nerve-roots, and even the cells of the posterior cornua, may be involved, so that the subject becomes very complicated. Co-ordination of muscular movements is normally dependent upon certain afferent sensory impulses, themselves very complex. It is to be remembered also that there are numberless

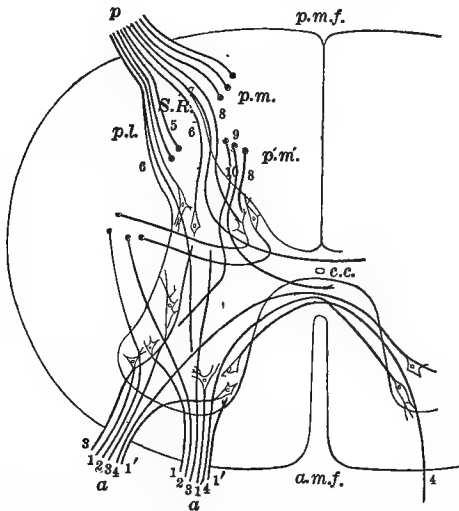

FIG. 347.—Diagram to illustrate probable course taken by fibers of nerve-roots on entering spinal cord (Schäfer).

connecting links between the two sides of the cord and between its different columns of an anatomical kind, not to mention the possibly numerous physiological (functional) ones.

We have stated above that section of one lateral half of the cord is followed by loss of sensation on the opposite side of the body; but directly the contrary has been maintained by other observers; while still others maintain that the effects are not

confined to one side, though most pronounced on the side of the section. The same remark applies to motion.

While there is considerable agreement as to the pyramidal tracts of the lateral column, the functions of the rest of these divisions of the cord are by no means well established. It is possible that vasomotor, respiratory, and probably other kinds of impulses, pass by portions of the lateral tracts other than the crossed pyramidal. When a lateral half of the cord is divided, the loss of function is not permanent in all instances, but has been recovered from without any regeneration of the divided fibers; and even when a section has been made higher up on the opposite side, partial recovery has again followed: so that it would appear that impulses had pursued a zigzag course in such cases. We do not think that such experiments show that impulses do not usually follow a definite course, but that the resources of nature are great, and that, when one tract is not available, another is taken.

It is plain that impulses do not in any case travel by one and the same nerve-fiber throughout the cord, for the size of this organ does not permit of such a view being entertained; at the same time there is a relation between the size of a cross-section of the cord at any one point and the number of nerves connected with it at that region.

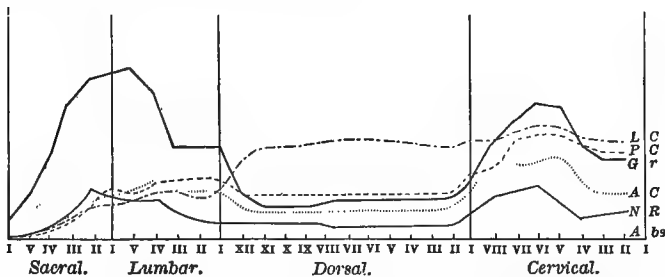

FIG. 348.—Diagram to illustrate relative and absolute extent of (1) gray matter, (2) white columns in successive sectional areas of spinal cord, and (3) sectional areas of several nerve-roots entering cord. *NR*, nerve-roots; *AC*, *LC*, *PC*, anterior, lateral, posterior columns; *Gr*, gray matter (after Schäfer, Ludwig, and Woroschloff).

We may attempt to trace the paths of impulses in the cord somewhat as follows: 1. Volitional impulses decussate chiefly in the medulla oblongata, but also, to some extent, throughout the whole length of the spinal cord. They travel in the lateral columns (crossed pyramidal tracts chiefly, if not exclusively), and eventually reach the anterior roots of the nerves through the anterior gray cornua, passing to them, possibly, by the ante-

rior columns. From the cells of the anterior cornua, impulses travel by the anterior nerve-roots to the motor nerves, by which connection is made with the muscles. 2. Sensory impulses enter the cord from the afferent nerve-fibers by the posterior nerve-roots, passing probably by the posterior columns to the posterior cornua, thence to the lateral columns, decussation being largely immediate though not completed for some distance up the cord.

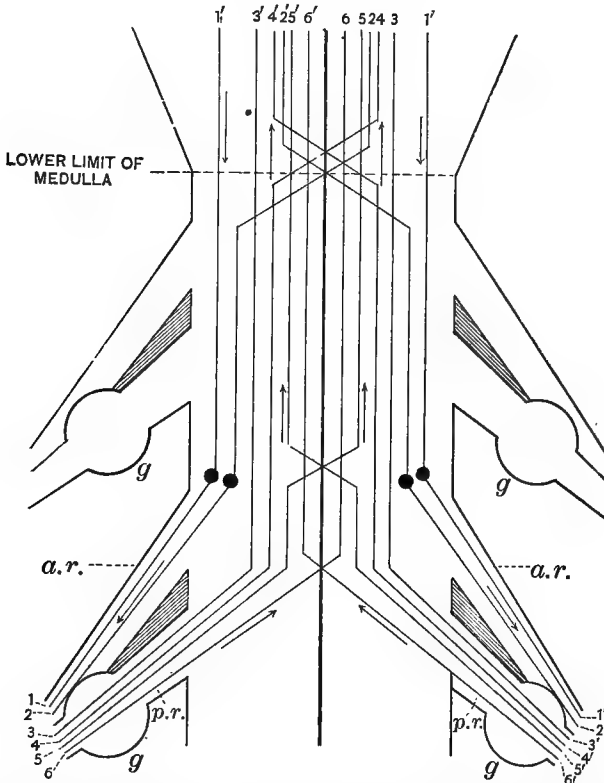

FIG. 349.—Diagram showing course of fibers in spinal cord (after Ranney). 1, 1', direct pyramidal bundles; 2, 2', crossed pyramidal bundles, decussating in medulla; 3, 3', direct cerebellar fibers; 4, 4', fibers related to "muscular sense," decussating in medulla; 5, 5', and 6, 6', fibers related to the appreciation of touch, pain, and temperature. The motor bundles have a dot upon them to represent the motor cells of the cord (anterior horn). Note that the motor fibers escape from the anterior nerve-root (*a. r.*), and that the sensory bundles enter at the posterior nerve-root (*p. r.*), which has a ganglion (*g*) upon it.

It would seem that the lateral columns are the great highways of impulses; though in all instances it is likely that the gray matter of the cord plays an important part in modifying them before they reach their destination. Some observers

believe that sensory impulses giving rise to pain travel by the gray matter of the cord almost exclusively. It would be easy to lay out the paths of impulses in a more definite and dogmatic manner; but the evidence does not seem to warrant it, and it is better to avoid making statements that may require serious modification, to say the least, in a few months. The prominent principle to bear in mind seems to be that while there are tracts in the cord of the animals that have been examined and probably of all that have well-formed spinal cords, along which impulses travel more frequently and readily than along others, it is equally true that these paths are not invariable, nor are they precisely the same for all groups of animals. The cord can not be considered independently of the brain; and there can be no doubt that the paths of impulses in the former are related to the constitution, anatomical and physiological, of the latter. It is still a matter of dispute whether the cord is itself irritable to a stimulus. As a whole it is without doubt; as also the white matter by itself. The gray matter is certainly conducting, but whether irritable or not is still doubtful. Why the sensibility of the side of the body on which one lateral half of the cord has been divided should be increased (hyperæsthesia), is also undetermined. Possibly it is due to a temporary disturbance of nutrition, or the removal of certain usual inhibitory influences from above, either in the cord or brain.

THE AUTOMATIC FUNCTIONS OF THE SPINAL CORD.

Reference has been already made to the fact that when portions of a mammal's cerebrum are removed the reflexes of the cord become more pronounced, owing apparently to the removal of influences operating on the cord from higher centers.

When the cord itself is completely divided across, it often happens (in the dog, for example) that there are rhythmic movements of the posterior extremities—i. e., when the animal has recovered from the shock of the operation—that part of the cord now independent of the rest and of the brain seems to manifest an unusual automatism. The question, however, may be raised as to whether this is a purely automatic effect, or the result of reflex action. But, whichever view be entertained, these phenomena certainly teach the dependence of one part upon another in the normal animal, and should make one cautious in drawing conclusions from any kind of experiment, in regard to the normal functions. As we have often urged in

the foregoing chapters, what a part may under certain circumstances manifest, and what its behavior may be as usually placed in its proper relations in the body, are entirely different, or at least may be. When one leg is laid over the other and a sharp blow struck upon the patella tendon, the leg is jerked up in obedience to muscular contraction. It is not a little difficult to determine whether this result is due to direct stimulation of the muscle or to reflex action, the first link in the chain of events necessary to call it forth originating in the tendon; hence the term tendon-reflex. But at present it is safer to speak of it as the "knee-jerk," or the "tendon-phenomenon." It disappears, however, when the spinal cord is destroyed or is diseased, as in locomotor ataxia, or when the nerves of the muscles or the posterior nerve-roots are divided, showing that the integrity of the center, the nerves, and the muscles are all essential. There are normally many such phenomena (reflexes) besides the "knee-jerk."

Another question very difficult to decide is that relating to the usual condition of the muscles of the living animal. It is generally admitted that the muscles of the body are all in a somewhat stretched condition, but it is not so clear whether the skeletal muscles are under a constant tonic influence like those of the blood-vessels. It is certain that, when the nerves going to a set of muscles are cut, when even the posterior roots of the nerves related to the part involved are divided or the spinal cord destroyed, there is an unusual flaccidity of the limb involved. But the natural condition may be, it has been suggested, the result of reflex action. The subject is probably more complex than it has hitherto been considered.

The facts of such a case—those of the tendon-phenomenon and similar ones—would be better understood if the spinal cord, the nerves, and the muscles associated with them, were regarded as parts of a whole so connected in their functions that severance of any one of them leads to disorder of the rest. That the cells of the cord are constantly exercising an influence through the nerves on the muscles, while they in turn do not lead an independent existence, but are as constantly influenced by afferent impulses, and that one of the results is the condition of the muscles referred to, is, we are convinced, the case. To say that it is either entirely automatic or purely reflex, or that the whole of the facts would be covered even by any combination of these two processes, would probably be unjustifiable. The influence of the centers over the metabolism of parts

is both constant and essential to their well-being; and in such a case as that now considered it may be that a certain degree of tonus is normal to a healthy muscle in its natural surroundings in the body.

There is now considerable evidence in favor of placing certain centers presiding over the lower functions, as micturition, defecation, erection of penis, etc., in the spinal cord of mammals, especially its lower part—which centers, if they be not automatic, are not reflex in the usual sense; but their consideration is better attempted in connection with the treatment of the physiology of the parts over which they preside.

SPECIAL CONSIDERATIONS.

Comparative.—Among invertebrates there is, of course, no spinal cord, but each segment of the animal is enervated by a special ganglion (or ganglia) with associated nerves. Nevertheless, these are all so connected that there is a co-ordination, though not so pronounced as in the vertebrate, in which the actual structural bonds are infinitely more numerous, and the functional ones still more so. From this result possibilities to the vertebrate unknown to lower forms; at the same time, independent life and action of parts are necessarily much greater among invertebrates, as evidenced especially by the renewal of the whole animal from a single segment in many groups, as in certain divisions of worms, etc.

It also follows from the same facts that a vertebrated animal must suffer far more from injury, in consequence of this greater dependence of one part on another; a thousand things may disturb that balance on which its well-being, indeed, its very life hangs. It is noticeable, moreover, that, as animals occupy a higher place in the organic scale, their nervous system becomes more concentrated; ganglia seem to have been fused together, and that extreme massing seen in the spinal cord and brain of vertebrates is foreshadowed. In the chapters on the brain numerous illustrations of the nervous system in lower forms will be found.

The fact that the brain and cord arise from the same germ layer, and up to a certain point are developed almost precisely alike, is full of significance for physiology as well as morphology. That original deep-lying connection is never lost, though functional differentiation keeps pace with later morphological differentiation. But even among vertebrates the spinal cord

shows a complexity gradually increasing with ascent in the organic series. In the lowest of the fishes or vertebrates (*Amphioxus lanceolatus*) the creature possesses a spinal cord only and no brain, so that an opportunity is afforded of witnessing how an animal departs itself in the absence of those directive functions, dependent on the existence of higher cerebral centers. The *Lancelet* spends a great part of its life buried in mud or sand on the bottom of the ocean, and its existence is very similar to that of an invertebrate, though, of course, the dependence of parts on each other is somewhat greater.

Evolution.—According to the general law of habit and inheritance, we should suppose that at birth each group of animals would manifest those reflex and other functions of the cord which were peculiar to its ancestors. Observation and experiment both show that reflexes, etc., are hereditary; that they tend to become more and more so with each generation; and at the same time that habit or exercise is essential for their perfect development. They stand, in fact, in the same relation as instincts, which are closely connected with them. Like the latter, they may be modified by way of increase or diminution and otherwise. To illustrate, it can not be doubted that galloping is the natural gait of horses, as shown by the tendency of even good trotters to “break” or pass into a gallop; but it is equally well known that famous trotters breed trotters. In other words, an acquired gait becomes organized in the nervous system (especially) of the animal, and is transmitted with more and more fixity and certainty with the lapse of time. But all experience goes to show that walking, running, or any of the movements of animals are, when fully formed as habit-reflexes, dependent for their initiation on the will in most but not all instances, and require for their execution certain combinations of sensory and other afferent impulses, and the integrity of a vast complex of nervous connections in the spinal cord.

It is well known that one in a period of absent-mindedness will walk into a building to which he was accustomed to go years before, though not of late, showing plainly that volition was not momentarily required for the act of walking and all else that is involved in the above behavior. It suggests that certain nervous and muscular connections have been formed, functionally at least. Plainly, then, we should not expect each individual man's spinal cord to be the same, but that the series of mechanisms of which every spinal cord is made up should differ with experience; and if this holds for individuals, how much

more must it be true of different groups of animals, the habits of which differ so widely! Experiment has proved this also so far as it has gone; hence the great danger of laying down laws for the spinal cord from the investigation of one animal or even one group. Recent investigations have shown that, in persons crippled from birth, or for long periods, reflexes which had never been properly established may, as the result of operative procedure, become possible through training. It has also been shown, both by experiment and clinical experience of the kind referred to, that when certain reflexes are imperfectly developed others are also defective, again impressing the importance of that balance of development which is essential to health or the normal condition of an animal. This subject is very wide, of great practical importance, and deserves consideration beyond what our limits of space will allow.

All the facts go to show that the cord is made up of nervous mechanisms—if we may so speak—which are naturally associated, both structurally and functionally, with certain nerves and muscles; these, like the paths which impulses take to and from the brain, though usual, are not absolutely fixed, though more so as reflex than conducting paths, while they are constantly liable to be modified in action by the condition of neighboring groups of mechanisms, etc.

We have said less about the gray matter of the cord as a conductor than its importance perhaps deserves. It is believed by many that impulses which give rise to sensations of pain always travel by the gray matter; and there is not a little evidence to show that, when none of the white columns are available owing to operative procedure, disease, or other disabling cause, the gray matter will conduct impulses that usually proceed by other tracts.

Synoptical.—The spinal cord is composed of large ganglionic nerve-cells, fibers, and connecting neuroglia. Functionally it is a conductor, the seat of certain automatic centers and of reflex mechanisms. Probably in every case the one function is to a certain extent associated with the other—i. e., when the cord acts reflexly it is also a conductor, and the cells concerned are so readily excited to certain discharges of nervous energy that automaticity is suggested, and so in other instances: thus, in the case of automaticity, reflex influence or afferent impulses are with difficulty entirely excluded from consideration.

The great majority of conducting fibers seem to cross either in the cord itself or in the medulla oblongata. The conducting

paths that have been shown by pathological and clinical investigation to be best marked out in the spinal cord are those for voluntary motor impulses. So far as the functions of the human organ are concerned, clinical and pathological facts have thrown the greatest amount of direct light on the subject; but the inferences thus drawn have been modified and supplemented by the results of experiments on certain other mammals.

It is especially important to bear in mind that, while certain conducting paths are usual, they are not invariable; in like manner, reflex impulses may not be confined to usual groups of cells, but may extend widely, and so bring into action a large number of muscles. The resulting reflex in any case is dependent on the character, intensity, and location of the stimulus, and especially on the condition of the central cells involved. In the whole functional life of the cord the influence of higher centers in the organ itself and especially in the brain is to be considered. The cord is rather a group of organs than a single one.

THE BRAIN.

The methods of investigating the functions of the brain are analogous to those employed for the cord, and may be classed as physiological proper and pathological, though, as a matter of fact, neither one nor the other is now considered as reliable when taken alone. With the pathological is generally included the clinical method; and the conclusions thus derived, are corrected and supplemented by the results obtained by section, removal, or other operative procedure affecting parts of the brain. The difficulties are still greater than in the case of the cord, on account of the extreme complexity of the organ, especially in the higher mammals and man.

At the outset we may remark that the whole subject will be studied more profitably if it be borne in mind that—1. The brain is rather a collection of organs, bound together by the closest anatomical and physiological ties than a single one; in consequence of which it is quite impossible to understand the normal function of one part without constantly bearing in mind this relationship. This aspect of the subject has not received the attention it deserves. No one regards the alimentary tract as a single organ; but it is likely that the dependence functionally of one part of the digestive canal upon another

is not more intimate than that established in that great collection of organs crowded together and making up the brain. 2. Since the relative size, position, and anatomical connections of the parts that make up the brain are different in different groups of animals, not to speak of the fact that the functions of any part of the brain of an animal, like that of its spinal cord, already alluded to, must depend in great part upon its own and its inherited ancestral experiences, it follows that the greatest caution must be exercised in applying conclusions true of one group of animals to another. As we shall point out, the neglect of this precaution has led to needless controversy and much misunderstanding. 3. It follows, from what has been referred to in 1 above, that conclusions based upon the behavior of an animal after section or removal of a part of the brain must be, until at least corrected by other facts, received with some hesitation. 4. It also might be inferred from 1 that it is desirable to study the simpler forms of brain found in the lower vertebrates, in order to prepare for the more elaborate development of the encephalon in the higher mammals and in man. 5. The embryological development of the organ also throws much light upon the whole subject.

The student will see from these remarks that a sound knowledge of the anatomy of the brain and its connections is indispensable for a just appreciation of its physiology; nor must such knowledge be confined to the human or any other single form of the organ. There is only one way by which this can be attained: dissection, with the help of plates and descriptions. The latter alone frequently impart ideas that are quite erroneous, though they serve an especially good purpose in helping to fix the pictures of the natural objects, and in reviving them when they have become dim.

It is neither difficult to obtain nor to dissect the brain of the fish, frog, bird, etc. Valuable material may be saved and the subject approached profitably, if, prior to the dissection of a human brain, a few specimens from some group or groups of the domestic animals be examined. However useful artificial brain preparations may be, they are so far from nature in color, consistence, and many other properties, that, taken alone, they certainly may serve greatly to mislead; and we hope the student will allow us to urge upon him the methods above suggested for getting real lasting knowledge. The figures given below may prove helpful when supplemented as we advise.

The great difference in total size, and in the relative propor-

tion, situation, etc., of parts, will, however, be obvious, from the figures themselves; and as we have already pointed out more than once, the preponderance of the cerebrum in man must ever be borne in mind in the consideration of his entire organization, whether physical, mental, or moral; or, to put the matter otherwise, all man's functions are the better understood by the remembrance of this one fact, which will be at once illustrated when we consider the result of removal of the cerebrum in animals.

ANIMALS DEPRIVED OF THE CEREBRUM.

The cerebrum may be readily removed from a frog, without producing either severe prolonged shock or any considerable hæmorrhage. Such an animal remains motionless, unless when stimulated, though in a somewhat different position from that of a frog having only its spinal cord. It can, however, crawl, leap, swim, balance itself on an inclined plane, and when leaping avoid obstacles. One looking at such an animal performing these various acts would scarcely suspect that anything was the matter with it, so perfectly executed are its movements. We are forced to conclude, from its remaining quiet, except when aroused by a stimulus, that its volition is lost; but, apart from that, and the fact that it evidently does not see as well as before, it appears to be normal. It has no intelligent directive power over its movements. It remains, therefore, to explain how it is that they are so much more complete, so much better co-ordinated in the entire animal than when only the spinal cord is left. It seems to be legitimate to infer that the other parts of the brain contain the nervous machinery for this work, which is usually stimulated to action by the will, but which an external stimulus may simulate. All the connections, structural and functional, are present, except those on which successful volition depends. The frog with the cord only, sinks at once when thrown into water; when gently placed on its back, it may and probably will remain in that position, without an attempt at recovery. There is, in fact, very limited power of co-ordination.

Removal of the cerebral lobes in the bird is more likely to be attended with difficulties, and conclusions must be drawn with greater caution.

But a pigeon may be kept alive after such an operation for months. It can stand, balancing on one leg; recover its posi-

tion when placed on its side; fly when thrown into the air; it will even preen its feathers, pick up food, and drink water. Its movements are such as might be those of a stupid, drowsy, or probably intoxicated bird; but it is plainly endowed with vision, though not as good as before. But spontaneous movements are absent, and the pecking at food, etc., must be considered as associated reflexes, and as such are very interesting, in that they show how machine-like, after all, many of the apparently volitional acts of animals really are. In a mammal so great is the shock, etc., resulting from the operative procedure, that the actual functions of the remaining parts of the brain, when the cerebral convolutions are removed, are greatly obscured; nevertheless, little doubt is left on the mind that homologous parts discharge analogous functions. It can walk, run, leap, right itself when placed in an unnatural position, eat when food is placed in its mouth, and avoid obstacles in its path, though not perfectly. Yet it remains motionless unless stimulated; all objects before its eyes impress it alike if at all. The animal evidently has neither volition nor intelligence. Now, if any of the parts between the cerebrum and the medulla be removed, the creature shows lessened co-ordinating power; so that the inference, that these various parts are essential constituents of a complex mechanism, all the components of which are necessary to the highest forms of muscular co-ordination and probably other functions, is unavoidable.

There are all degrees of consciousness, and it is quite impossible to determine the extent to which this is interfered with in animals treated as described. While there can be no doubt that for the possession of the higher forms of consciousness (as for the perfection of all visual and other sensory processes) the cerebrum is necessary. It would, however, be very hazardous to state that, apart from this part of the brain, consciousness did not exist. When the whole encephalon is removed, the spinal cord alone remaining, it would not be legitimate to infer consciousness in the sense in which that word is usually implied; at the same time, in the intact vertebrate, we may believe that consciousness is in some sense, at least related in indefinable ways to all the vital processes, if not their actual resultant; inasmuch as, either directly or indirectly, the nervous system in all its parts is functionally connected, and influences and is itself influenced by every cell in the body.

Since we are dealing with co-ordinated movements, we may

now treat of the functions of a portion of the ear, according to our present classification.

HAVE THE SEMICIRCULAR CANALS A CO-ORDINATING FUNCTION ?

Physiologists have as yet been unable to assign to the semicircular canals a function in hearing, and upon certain results, partly of disease but chiefly of experiment, it has been concluded, though somewhat dubiously, that they are concerned with those sensations that conduce to or are essential to maintenance of the sense of equilibrium ; in a word, that they are the organs of that sense in the same way that the eye is the organ of vision.

Experimental.—When in a bird, as a pigeon, one of the membranous semicircular canals on one side is cut through, movements of the head, varying with the canal cut, result ; though these are not permanent, when the operation is unilateral. After the bilateral operation a bird flies with difficulty, eats and drinks, but not as usual, and behaves generally in a way to indicate loss of co-ordination. It appears to be dizzy. It can hear well, and is not paralyzed, nor is there even weakness of the muscles. The phenomena in other animals, while not quite the same, indicate that the essential failure is in co-ordination of muscular movements. When the peculiar movements of the head or eyes, at first ensuing on operation, are permanent, it is possible that there may have been injury, either primary or secondary, to the cerebellum or other parts of the brain. There are very many ways in which giddiness and consequent inco-ordination may be induced in man and the lower animals. When this is brought about by rapid rotation, both the disturbance in the distribution of the blood within the cranium and actual displacement of brain-substance, or at least molecular disorder, must be at the bottom of the matter.

In Menière's disease, vertigo is a prominent symptom in certain cases, but absent in others. Again, it is asserted that vertigo may be induced in animals in which both auditory nerves are divided. For our own part, we believe an undue importance has been attached to the semicircular canals in the present connection. Experiments on animals can not alone solve such problems as this, for the reason that we can never know, except in the vaguest way, their states of consciousness. Indeed, the latter must always be interpreted by our own, or

remain inscrutable; so that it follows that human consciousness must be the final court of appeal; and that we must depend more upon clinical and pathological investigation than upon experiment; but even this is not final, and in the end our own conscious experience will alone enable us to interpret facts of the character now discussed. Assume that a human subject has been operated upon as above indicated, and feels so dizzy that he is unable to walk steadily, and possibly unable to remain standing. If interrogated, what would be the answers given by an accurate reporter, with no bias from any theory whatever bearing on the subject? As we conceive, somewhat as follows: "How do you feel? Why can you not rise and remain standing, or walk?" "I feel all confused. I can not stand or walk because I do not seem to be able to make out what I should do. I have no clear ideas of things about me, and so do not know how to proceed." Put in more abstract or generalized form, this amounts to saying: "I am so confused by conflicting sensations that all my old judgments about the world are upset, yet memory and reason, in so far as I can exercise them, tell me that they are wrong, and I fear to act, and so remain still; or, when I do try to stand or walk, my confusion leads to a sort of loss of control over my thoughts and feelings, and therefore my will-power, so that any effort to walk is feebly directed by will, and little regulated by my usual feelings; hence I accomplish little, and lose confidence in myself." Such may be considered an attempt, and only fairly successful, no doubt, so great is the complexity of the state of consciousness resulting, to describe the condition of a human being under such circumstances, as derived from a consultation with our experiences under peculiar conditions, as the various forms of giddiness, intense and sudden surprise, and a host of others not readily named but still real. With a bird or quadruped the case must be somewhat similar.

It has been suggested that there is experimental evidence to show a power of estimation of the distance and direction through which a human subject is moved, independent of the data furnished by other senses, as sight, tactile, and muscular sensation, etc. When an individual, blindfolded, lies upon a flat surface and is gently rotated through a certain angle, it is said that the subject of the experiment can make a fair estimate both of the direction and distance through which he is moved, from which it is argued that there is a sense answering to this result, and located, presumably, in the semicircular canals. But, in the

first place, we very much doubt whether, in such an experiment, tactile and muscular sensation is in abeyance, and, in the second place, if it were, there are associated sensations, possibly from the vascular and lymphatic systems, and many other sources within, which can not be ignored. We do not even yet seem to be sufficiently alive to the delicacy and the immense variety of our sensations, some of which are absolutely undefinable; otherwise we do not think such experiments as that above cited would be adduced in proof of a special sense of equilibrium.

Until further evidence is forthcoming, then, we are not inclined to give assent to the existence of any mechanism in the semicircular canals, affording sensory data so *entirely different* from those furnished by other recognized (and unrecognized) sense-organs, that upon them alone, or in a manner entirely their own, arises a consciousness of equilibrium. We are inclined to regard the latter as depending upon the fusion in consciousness of a vast complex of sensations; and that upon the whole being there represented, or a portion wanting, depends either the preservation of equilibrium, or a partial or entire loss of the same. Nevertheless, it is highly probable that sensory impulses of a very important character, in addition to such as are essential for hearing, may proceed from the semicircular canals, and indeed other parts of the labyrinth of the ear.

FORCED MOVEMENTS.

When certain portions of the brain of the mammal have been injured, movements of a special character result, and, inasmuch as they are not voluntary, in the ordinary sense at least, have been spoken of as forced or compulsory. The movements may be classified according as they are around the long vertical or the transverse axis of the body of the animal. Hence there are "circus" movements, when the creature simply turns about in a circle, "rolling" movements, etc. These and others may be toward or from the side of injury. While in some cases there may be a certain amount of muscular weakness in consequence of the injury, which may, in part, account for the direction of the movements, this is not so in all cases; nor does it, in itself, explain the fact of their being plainly not voluntary in the usual sense.

The parts of the brain, which, when injured, are most liable to be followed by forced movements are the basal ganglia (cor-

pora striata and optic thalami), the crura cerebri, corpora quadrigemina, pons Varolii, and medulla oblongata, and especially if the section be unilateral. We have already seen that several of these parts are concerned in muscular co-ordination; hence the disorderly character of any movements that might now result when any part of this related mechanism is thrown out of gear, so to speak; but, apart from that, we think that the view presented in the previous sections is applicable in this case also, while the forced movements themselves throw light upon the symptoms following injury to the semicircular canals. When that constant afflux of sensory impulses toward the nervous centers is interfered with, as must be the case in such sections as are now referred to, it is plain that the balance in consciousness must be disturbed; confusion results, and it is not surprising that, instead of a passive condition, one marked by disorderly movements should result in an animal, since movement so largely enters into its life-habits. It is important to remember, in this connection, that the great highway of impulses between the cerebral cortex and other parts of the brain and the spinal cord lies in the very parts of the encephalon we are now considering.

FUNCTIONS OF THE CEREBRAL CONVOLUTIONS.

Comparative.—It will conduce to the comprehension of this subject if some reference be now made to the development of the brain in the different groups of the animal kingdom.

Invertebrates not only have no cerebrum, but no brain in the strict sense of the term as applied to the higher mammals. In most forms of this great subdivision of the animal kingdom, the first or head segment is provided with ganglia arranged in the form of a collar around the cesophagus, by means of commissural nerve connections; so that the nervous supply of the head is not widely different from that of the other segments of the body. But as we ascend in the scale among the invertebrates these ganglia become more crowded together, and so resemble the vertebrate brain with its massed ganglia and numerous connections through nerve-fibers, etc. But in this respect we find great difference among vertebrates. We can recognize, on passing upward from the *Amphioxus*, destitute of a brain proper, to man, all gradations in the form, relative size, multiplicity of connecting ties, etc.

Speaking generally, there is great difference in the weight

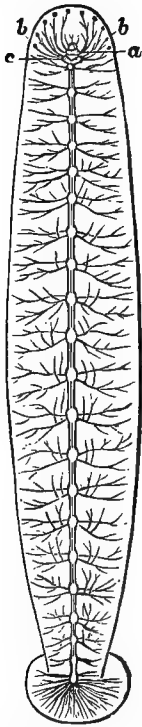

FIG. 350.

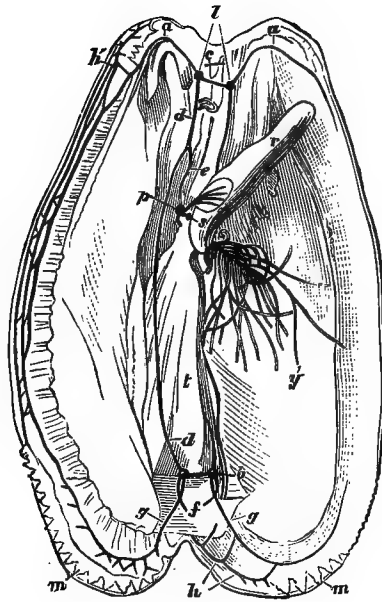

FIG. 351.

FIG. 350.—Nervous system of medicinal leech (after Owen). *a*, double supra-cesophageal ganglion connected with rudimentary ocelli (*b, b*) by nerves; *c*, double infra-cesophageal ganglionic mass, which is continuous with double ventral cord, having compound ganglia at regular intervals.

FIG. 351.—Nervous system of the common mussel (after Owen). *l, l*, labial ganglia connected by a short commissure above and in front of mouth; *b, b*, branchial ganglia, connected in like manner, and united by long nervous cords (*d, d*) with labial ganglia; *p*, bilobed pedal ganglion sending branches to the muscular foot (*r*), and closely united with the "auditory sacculles" (*s*); *h, h'*, circum-pallial plexus; *y*, byssus, by which the animal can attach itself to foreign bodies (anchor).

of the cerebrum, both relative and absolute. In all animals below the primates (man and the apes) the cerebellum is either not at all or but imperfectly covered by the cerebrum; while in man, so great is the relative size of the latter, that the cerebellum is scarcely visible from above. If we except the elephant, in which the brain may reach the weight of ten pounds, and the whale with its brain of more than five pounds in the largest specimens, the brain of man is even absolutely heavier than that of any other animal, which is in great part due to the preponderating development of the cerebrum.

While the cerebral surface is smooth in all the lower vertebrates, and but little convoluted until the higher mammals are

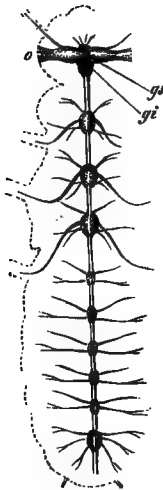

FIG. 352.

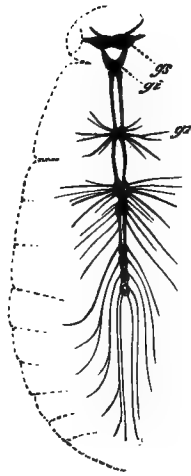

FIG. 353.

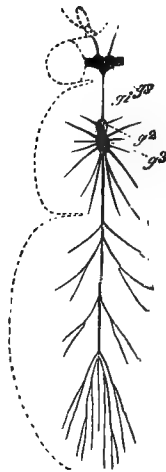

FIG. 354.



FIG. 355.

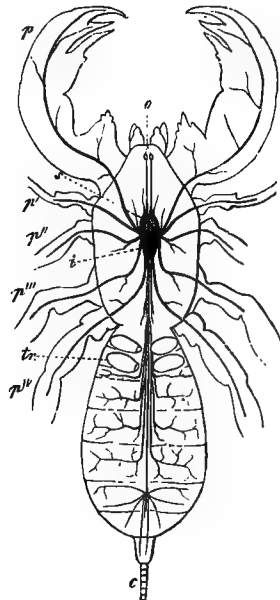

FIG. 356.

- FIG. 352.—Nervous system of a white ant, *Terres* (after Gegenbaur and Lespès).
 FIG. 353.—Nervous system of a water beetle, *Dytiscus* (after Gegenbaur).
 FIG. 354.—Nervous system of a fly, *Musca* (after Gegenbaur and Blanchard). o, eyes; gs, supra-oesophageal ganglia or brain; gi, sub-oesophageal ganglion; gr, gr², gr³, fused thoracic ganglia.
 FIG. 355.—Nervous system of a crab, *Palinurus vulgaris*, showing considerable fusion of ganglia (after Milne-Edwards). a, fused cerebral ganglia; b, b, long oesophageal cords; c, c, great ventral ganglionic mass.
 FIG. 356.—Nervous system of a large scorpion-like spider, *Thelyphonus caudatus* (after Gegenbaur and Blanchard). s, cerebral ganglia; i, great ventral ganglion; o, eyes; p, palpi; p'-p'', feet.

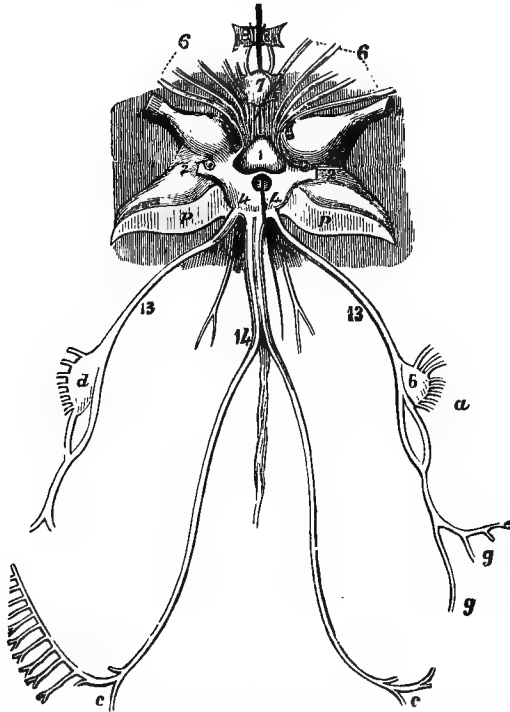

FIG. 357.—Nervous system of common cuttle-fish, *Sepia officinalis* (after Owen). 1, double supra-oesophageal ganglion; *p, p*, cut surfaces of the cartilaginous cranium; 2, 2, optic ganglia; 4, 4, posterior sub-oesophageal ganglia; 7, 8, ganglia in connection with pharynx and mouth; 13, 13, great motor nerves of mantle, etc., with other ganglia; 14, *c, c*, respiratory nerves. The intelligence of this animal is in proportion to the size and concentration of its ganglia.

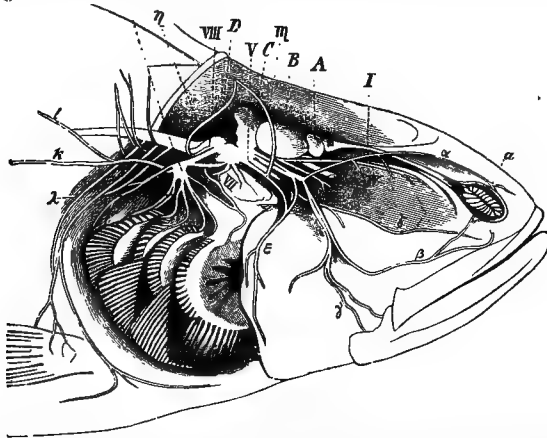

FIG. 358.—Brain and cranial nerves of perch, seen from the side (after Gegenbaur and Cuvier). *A*, cerebral lobe with olfactory ganglion in front; *B*, optic lobe; *C*, cerebellum; *D*, medulla oblongata; *I—VIII*, nerves in usual order; *K*, lateral branch of vagus; *l*, upper twig of same; *m*, dorsal branch of trigemini, joined by *n*, dorsal branch of vagus; α, β, γ , three branches of trigemini; $\delta\epsilon$, facial nerve; λ , branchial branches of vagus.

reached, the brain of the primates, and especially of man, has its surface enormously increased, owing to its numerous fissures and convolutions, which, in fact, arise from the growth of the organ being out of proportion to that of the bony case in which it is contained; and since those cells which go to



FIG. 359.—Brain and spinal cord of frog (Bastian). *A*, olfactory lobes; *B*, cerebral lobes; *E*, pineal body; *C*, *D*, optic lobes; *E*, cerebellum; *H*, spinal cord. The cerebellum is notably small.

make up the gray matter and are devoted to the highest functions, are disposed over the surface, the importance of the fact in accounting for the superior intelligence of the primates, and especially of man, becomes apparent. Depth of fissuring is, however, of more importance than multiplicity of furrows; and it may be observed that intelligence is not always in proportion to the extent to which the cerebral surface is broken

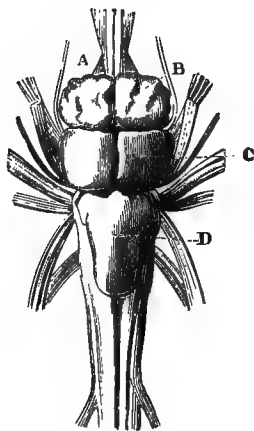

FIG. 360.

FIG. 360.—Brain of the pike, viewed from above (Huxley). *A*, the olfactory nerves or lobes, and beneath them the optic nerves; *B*, the cerebral hemispheres; *C*, the optic lobes; *D*, the cerebellum.

FIG. 361.—The brain of edible frog (*Rana esculenta*). 1×4 . (After Huxley.) *L. ol.*, the rhinencephalon, or olfactory lobes, with *I*, the olfactory nerves; *Hc.*, the cerebral hemispheres; *Fh. o.*, the thalamencephalon with the pineal gland, *Pn.*; *L. op.*, optic lobes; *C.*, cerebellum; *S. rh.*, the fourth ventricle; *Mo.*, medulla oblongata.

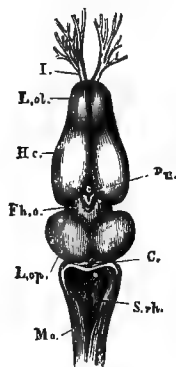

FIG. 361.

up into fissures and convolutions. The depth of the gray matter is also very variable, and seems to bear an important relation to psychic development. Man's brain, then, is characterized by its great size and complexity; while those parts treated

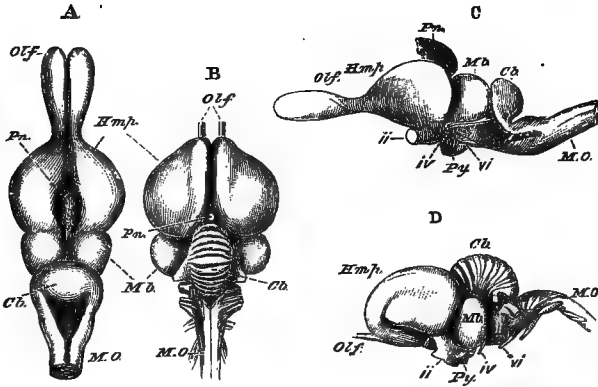

FIG. 362.—A, C, the brain of a lizard (*Psammosaurus Bengalensis*), and B, D, of a bird (*Meleagris gallopavo*, the turkey), drawn as if they were of equal lengths (after Huxley). A, B, viewed from above; C, D, from the left side. *Olf*, olfactory lobes; *Pn*, pineal gland; *Hmp*, cerebral hemispheres; *Mb*, optic lobes of the mid-brain; *Cb*, cerebellum; *M.O.*, medulla oblongata; *ii*, *iv*, *vi*, second, fourth, and sixth pairs of cerebral nerves; *Py*, pituitary body.

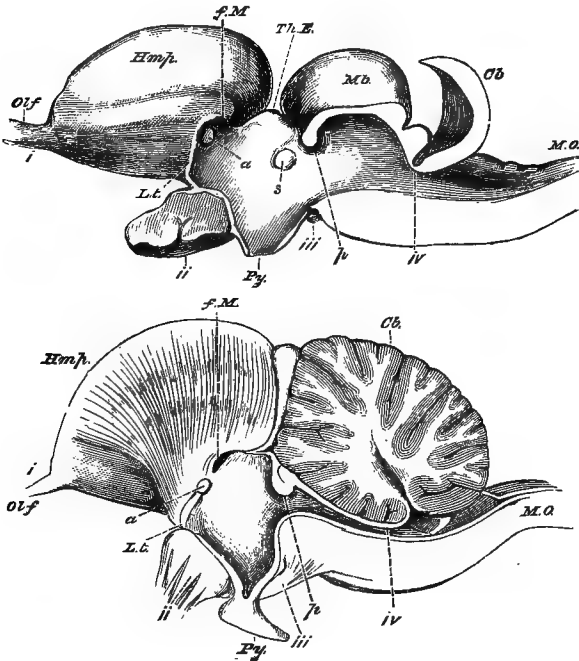

FIG. 363.—Brains of a lizard (*Psammosaurus Bengalensis*) and of a bird (*Meleagris gallopavo*) in longitudinal and vertical section. The upper figure represents the lizard's brain; the lower, that of the bird (after Huxley and Carus). Letters as in the preceding figure, except *L. t.*, lamina terminalis, or anterior wall of the third ventricle; *f. M.*, foramen of Munro; *a*, anterior commissure; *Th. E.*, thalamencephalon; *s*, soft commissure; *p*, posterior commissure; *iv*, indicates the exact point of exit of the fourth pair from that part of the brain which answers to the value of Viessens.

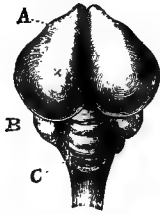

FIG. 364.



FIG. 365.



FIG. 366.

FIG. 364.—Brain of pigeon (after Ferrier). *A*, cerebral hemispheres; *B*, optic lobe; *C*, cerebellum, the lateral lobes of which are very small.

FIG. 365.—Brain and spinal cord of chick at sixteen days old; optic lobes, *b*, are still in contact (after Owen and Anderson).

FIG. 366.—Brain and part of spinal cord of chick twenty days old, showing optic lobes widely separated and cerebellum, *c*, largely developed.

elsewhere, concerned in co-ordination, vision, etc., are well developed, the cerebrum, especially its lobes as distinguished from its basal ganglia, is, out of all proportion, greater than in any other animal.

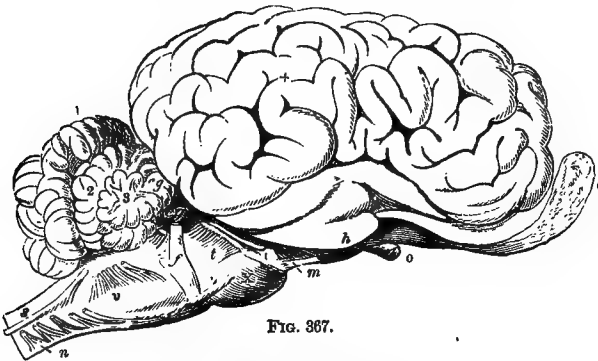

FIG. 367.

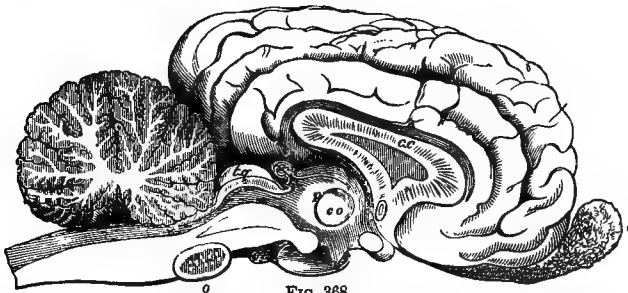

FIG. 368.

FIG. 367.—Outer surface of brain of horse (after Solly and Leuret). *e*, olfactory lobe; *h*, hippocampal lobe (processus pyriformis); 1, 2, 3, lobes of cerebellum; *o*, optic nerve; *m*, motor oculi; *p*, fourth nerve; *t*, fifth nerve; *u*, sixth nerve; *f*, facial; *l*, auditory; *g*, glossopharyngeal; *v*, vagus; *s*, spinal accessory; *n*, hypoglossal; *X*, pons Varoli.

FIG. 368.—Longitudinal section through center of brain of horse, presenting view of internal surface (after Solly and Leuret). *c. c.*, corpus callosum; *p*, thalamus; *co*, middle commissure; *t. q.*, corpora quadrigemina, in front of which is the pineal body. The cerebellum has been cut through.

The gray matter of the brains of the higher vertebrates is distributed as masses of ganglionic cells internally, and as a fairly uniform layer over its surface. The cerebrum of man

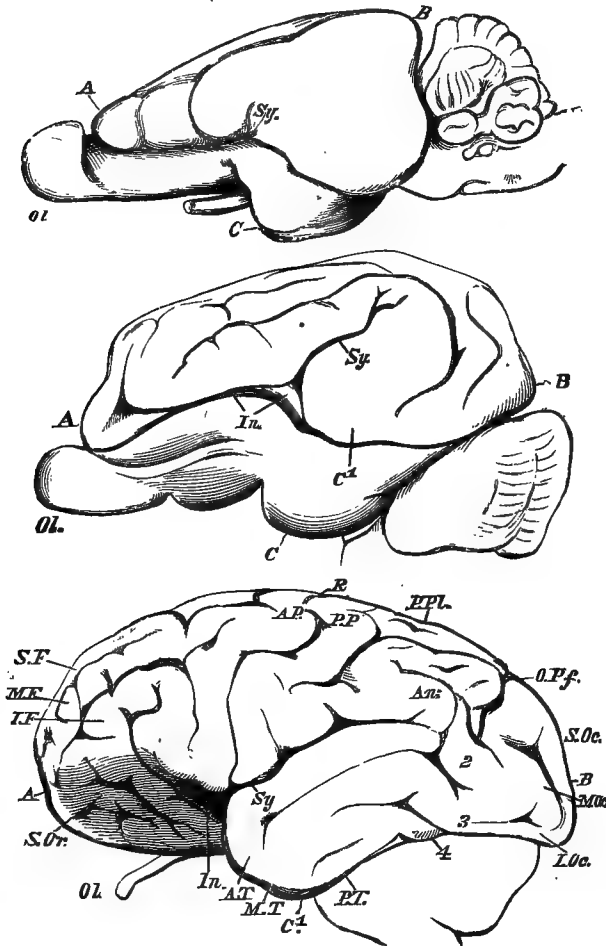

FIG. 369.—Lateral views of the brains of a rabbit, a pig, and a chimpanzee, drawn of nearly the same absolute size (Huxley). The rabbit's brain is at the top; the pig's in the middle; the chimpanzee's lowest. *Ol*, olfactory lobe; *A*, frontal lobe; *B*, occipital lobe; *C*, temporal lobe; *Sy*, the sylvian fissure; *In*, the insula; *S. Or*, supra-orbital; *S. F*, *M. F*, *I. F*, superior, middle, and inferior frontal gyri; *A. P*, antero-parietal; *P. P*, postero-parietal gyri; *R*, sulcus of Rolando; *P. Pl*, postero-parietal lobule; *O. Pf*, external perpendicular or occipito-temporal sulcus; *An*, angular gyrus; 2, 3, 4, annectent gyri; *A. T*, *M. T*, *P. T*, the three temporal, and *S. Oc*, *M. Oc*, *I. Oc*, the three occipital gyri.

weighs about three pounds on the average, that of the male being a few ounces (four to six) heavier than that of the female. The individual and race differences, though considerable, are

not comparable in degree to those that distinguish man from even the highest apes, the brain of the latter weighing not more than about one third as much as that of the human subject. While it has been shown that individual men and women may reach even distinction in the intellectual world, having

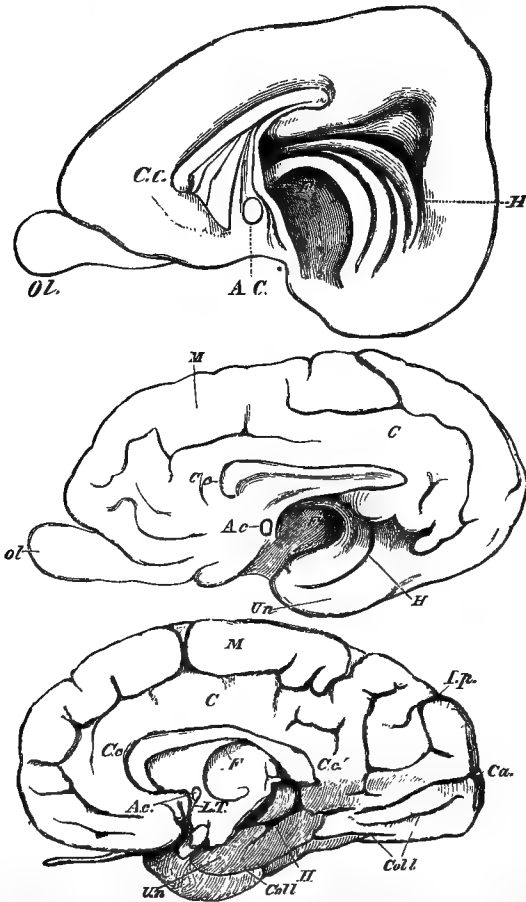

FIG. 370.—Inner views of cerebral hemispheres of the rabbit, pig, and chimpanzee, drawn as before, and placed in the same order (Huxley). *Ol*, olfactory lobe; *C. c.*, corpus callosum; *A. c.*, anterior commissure; *H*, hippocampal sulcus; *Un*, uncinatus; *M*, marginal; *C*, callosal gyri; *I. P.*, internal perpendicular; *Ca*, calcarine; *Coll*, collateral sulci; *F*, fornix.

brains of average or even sub-medium weight; and while idiots have been known to possess brains abnormally heavy, it is nevertheless true that brain-weight and the higher powers of man bear a close though not invariable relationship. The apparent discrepancies are susceptible of explanation.

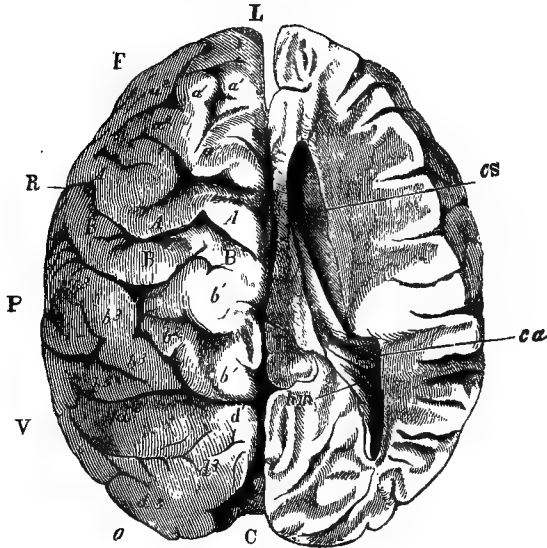

FIG. 371.

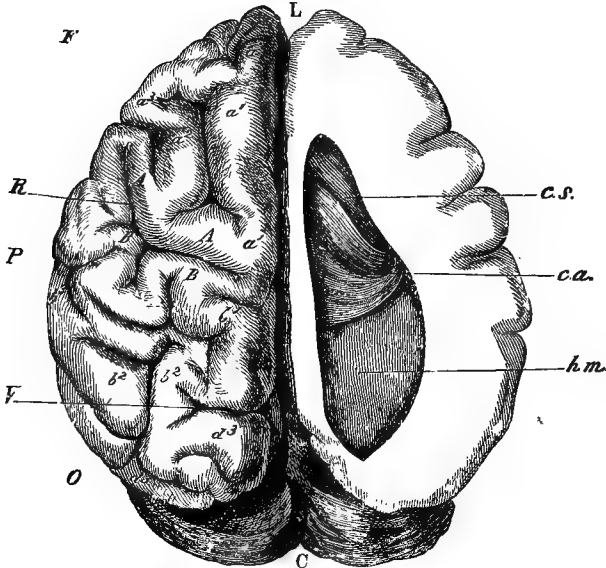

FIG. 372.

FIG. 371.—Brain of chimpanzee, part of right hemisphere being cut away so as to expose lateral ventricle (Vogt, after Marshall).

FIG. 372.—Brain of human idiot (after Vogt and Theile). This brain, one of the smallest ever examined, weighed only 300 grammes (10·6 oz). The resemblance between these two brains is striking. Lettering in each figure alike. *cs*, corpus striatum; *ca*, hippocampus major in descending cornu; *hm*, hippocampus minor in posterior cornu; *L*, great longitudinal fissure; *F*, frontal, *P*, parietal, *O*, occipital lobes; *R*, fissure of Rolando; *V*, external perpendicular fissure; *K*, operculum; *A*, *A*, ascending frontal; *B*, *B*, ascending parietal convolution.

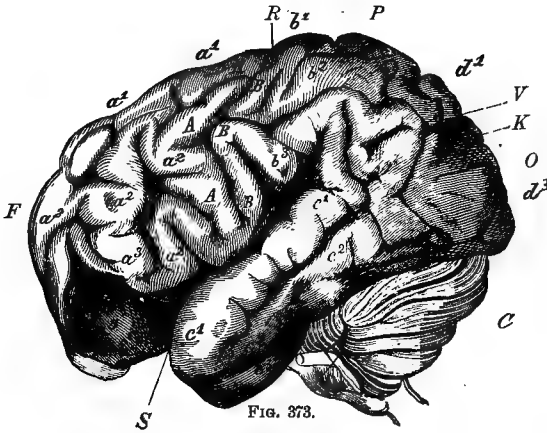

FIG. 373.

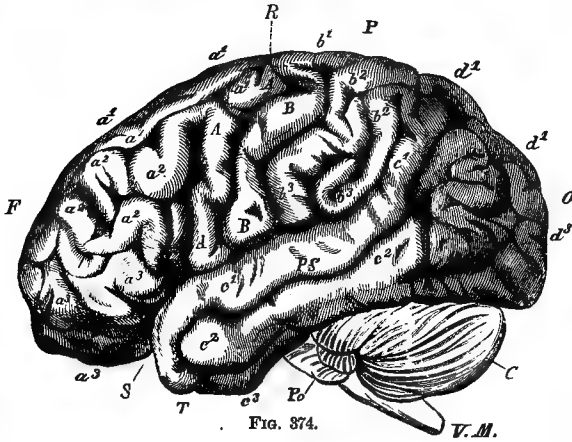

FIG. 374.

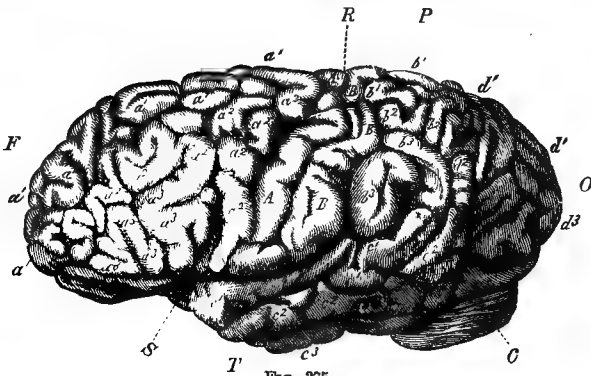

FIG. 375.

FIG. 373.—Brain of orang, side view (after Vogt and Gratiolet).

FIG. 374.—Brain of a Hottentot woman.

FIG. 375.—Brain of Gauss, the celebrated mathematician and astronomer (after Vogt and R. Wagner). The difference between this last brain and the two figured above will not fail to strike any observer. These figures are intended to illustrate racial and individual differences on the one hand, and the greater resemblance to lower forms of the brain of the more degraded races of men.

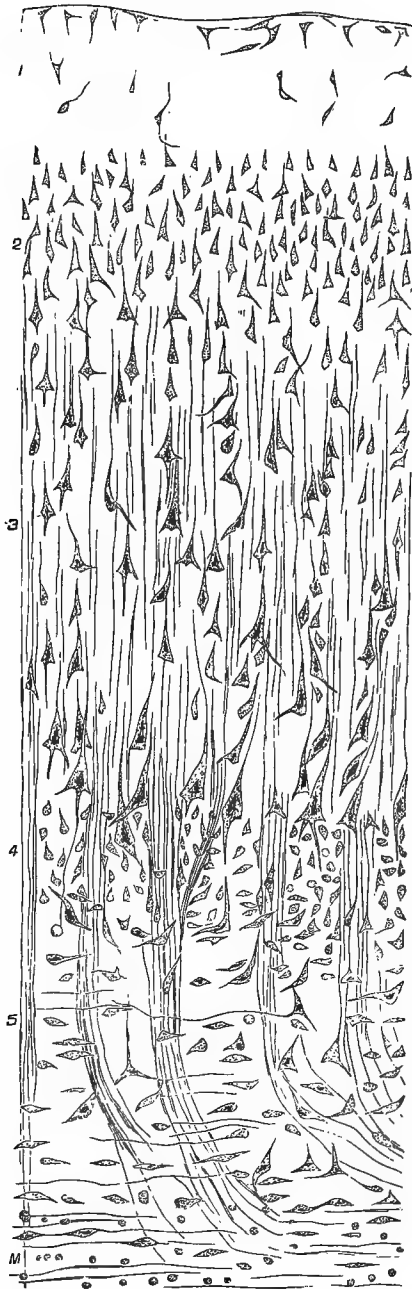

FIG. 376.—Vertical section of third cerebral convolution in man (after Meynert). 1, superficial cells; 2, layer of small pyramidal cells; 3, layer of large pyramidal cells; 4, layer of small irregular cells; 5, layer of spindle-shaped cells; *M*, white substance.

Besides the gray matter, with its cells of highest functional value from the standpoint now taken, the brain consists, and in large part, of neuroglia and nerve-fibers, with probably

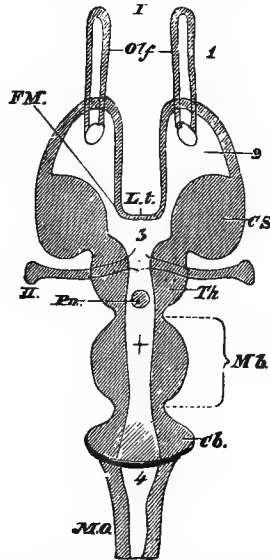

FIG. 377.—Diagrammatic horizontal section of a vertebrate brain (Huxley). The following letters serve for both this figure and the one following. *Mb*, mid-brain. What lies in front of this is the fore-brain, and what lies behind, the hind-brain. *L. t.*, the lamina terminalis; *Olf*, olfactory lobes; *Hmp*, hemispheres; *Th. E.*, thalamencephalon; *Pn*, pineal gland; *Pv*, pituitary body; *FM*, foramen of Munro; *CS*, corpus striatum; *Th*, optic thalamus; *CQ*, corpora quadrigemina; *CC*, crura cerebri; *Cb*, cerebellum; *PV*, pons Varolii; *MO*, medulla oblongata; *I*, olfactorii; *II*, optici; *III*, point of exit from brain of motores oculorum; *IV*, of pathetici; *V*, of abducentes; *V-XII*, origins of the other cerebral nerves. 1, olfactory ventricle; 2, lateral ventricle; 3, third ventricle; 4, fourth ventricle; +, iter *a tertio ad quartum ventriculum*.

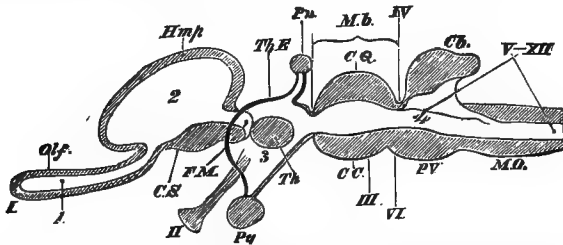

FIG. 378.—A longitudinal and vertical section of a vertebrate brain (Huxley). Letters as above. The lamina terminalis is represented by the strong black line between *FM* and 3.

chiefly, and in the case of the fibers solely, a conducting function. It will appear that body-weight must be taken into account in comparing the brains of the sexes and of individuals. Again, the quality or functional capacity of the indi-

vidual elements, especially of the cortical cells, both as the result of innate, inherited powers, and as altered by education, is, of course, a matter of great importance. By education we mean all those influences that have been brought to bear upon these cells from without, of whatever kind. Apart, too, from all these considerations, it must be clear that what any set of cells can accomplish, be they brain-cells or other, must depend largely upon their capacity to appropriate nourishment, which will in turn be modified by blood-supply, the behavior of excreting organs, etc. In a word, the intellectual achievements are dependent on a great variety of factors. The brain and other parts are so mutually dependent that they can not be understood by any isolated consideration of the one or the other. It is not to be supposed that an individual with a poor respiratory, circulatory, and digestive system, no matter what the possibilities of his cerebrum, can ever rank with an organism admirably balanced in these respects.

The Connection of one Part of the Brain with another.—Though it has long been known that the different parts of the brain were connected by bridges of fibers (*commissures*, etc.), the physiological significance of the fact seems to have been largely ignored, and even at the present day is too little considered.

1. *Cerebral fibers* pass between the convolutions of this part of the brain and the cerebellum; between the former and the main basal ganglia; between the gray matter of the convolutions on the same side, and between the latter and those on the opposite halves; between the gray matter of the cortex and the internal capsule, the corpora striata, optic thalami, pons Varolii, the medulla oblongata, and so to the spinal cord. The course of the latter tracts of fibers have been, especially by the help of pathology, definitely followed. Some of these connections are given in more detail below:

1. *Cerebro-cerebellar fibers.* (a.) From the cortical cells of the anterior cerebral lobe to the pons Varolii, passing through the internal capsule and thence through the lower and outer part of the crus cerebri (*crusta*). (b.) Fibers from the occipital and temporo-sphenoidal lobes, passing by the *crusta*, reach the upper surface of the cerebellum.

2. *Fibers bridging the two sides of the cerebrum.* (a.) By means of the corpus callosum chiefly, passing from the gray matter in the first instance. (b.) From the temporo-sphenoidal lobe on each side through the corpora striata and anterior commissure. (c.) Fibers from the upper part of the crus cerebri

(*tegmentum*) to the optic thalamus of each side and onward to the temporo-sphenoidal lobes, forming the posterior commissure.

3. *Fibers connecting different parts of the cerebral convolutions on the same side.* These are exceedingly numerous and are effected by such tracts as the "arcuate fibers," passing from one gyrus to another; "collateral fibers," forming distant convolutions; fibers of the fornix between the uncinate gyrus, hippocampus major, and optic thalamus; longitudinal fibers of the corpus callosum; fibers of the *tænia semicircularis*, uncinate fasciculus, etc.

4. *Fibers forming the cerebrum and the spinal cord.* According as they pass downward or upward do they converge or diverge, and the most important seem to pass through the internal capsule; and while the majority do perhaps form some connection, either with the corpora striata and optic thalami,

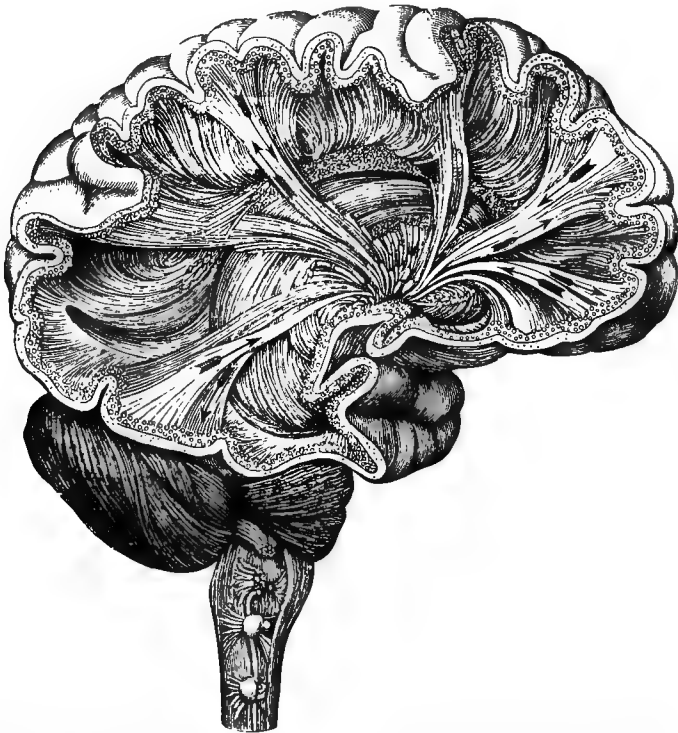

FIG. 379.—Diagrammatic representation of the course of some of the fibers in the cerebrum (after Le Bon).

some seem to pass directly downward through the internal capsule. It is held by many that the fibers passing through the posterior portion of the internal capsule are derived from the posterior lobe of the cerebrum, and are the paths of sensory impulses upward; while the rest of the internal capsule is made up of fibers from the anterior, and especially the middle portion of the cerebral cortex (motor area), and these fibers are the paths of motor (efferent) impulses.

It now becomes clearer that the brain is constituted a whole by such connections; and that, apart from the multiplicity of cells with different functions to perform, situated in different areas, the complexity and at the same time the unity of the encephalon becomes increasingly evident, merely upon anatomical grounds; but we shall find such a view still further strengthened by study of the functions of the various parts. While the tracts enumerated are anatomical and have been clearly traced, there can be little doubt that many others yet remain to be

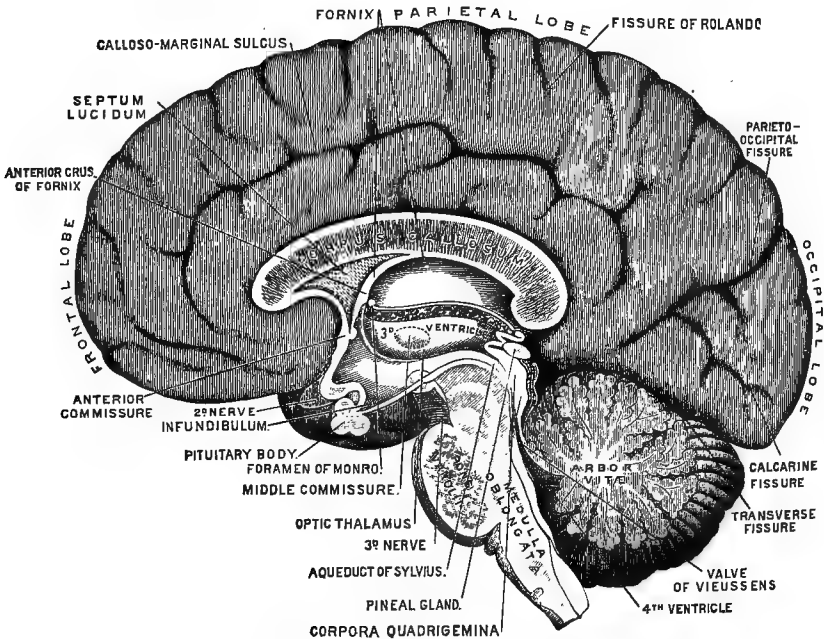

FIG. 380.—Median longitudinal section of human brain, semi-diagrammatic (after Flint).

marked out; and that, apart from such collections of fibers, we must recognize functional paths by the neuroglia, and possibly

others still. It is not to be forgotten that in the brain, as in the spinal cord, nerve-cells are themselves conductors, and while there may be certain areas within which the resistance is such that impulses are usually confined to them, it is also true that, as in the cord, there may be a kind of overflow. Adjacent cells, possibly widely separated cells, may become involved. We shall return to this important subject again, however, as, without recognizing such relationships, it seems to us quite impossible to understand the facts as we find them in the working of the body and the mind.

The Cerebral Cortex.—We may now proceed to inquire what are the functions of the cells of the gray matter covering the surface of the cerebrum. Before the birth of physiology as a science, Gall recognized and taught that the encephalon is a col-

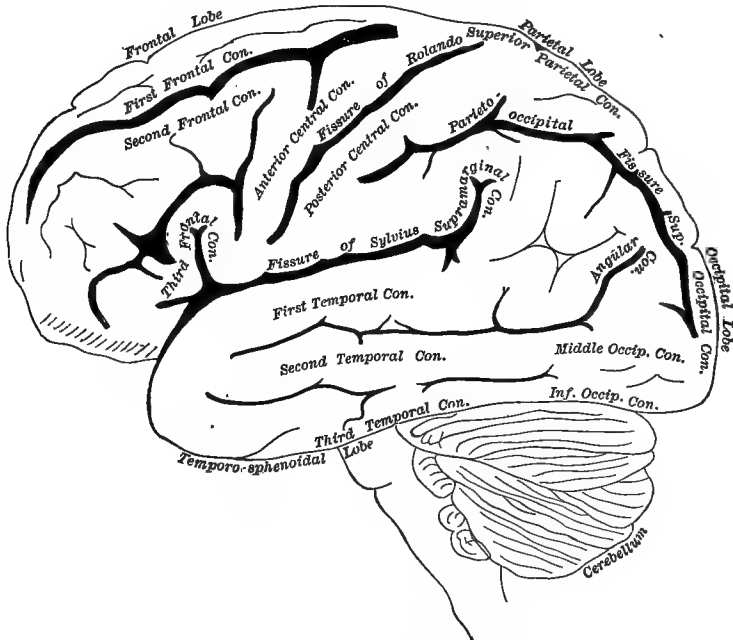

FIG. 381.—Diagrammatic representation of external surface of left cerebral hemisphere of man (after Flint and Ecker).

lection of organs; that these have separate functions; that the relative size of each determines the degree of its functional activity; and that the cranium developing in proportion to the growth of the brain, the former might give information as to the probable size of what lay beneath it in different regions.

It will be seen that, as thus interpreted, phrenology is a very different thing from what usually passes under that name, and is paraded before wondering audiences by ignorant charlatans. In the main the doctrines of Gall are not without a certain foundation in facts; and the modern theory of localization of function bears a strong resemblance to what Gall taught, though with greater limitations.

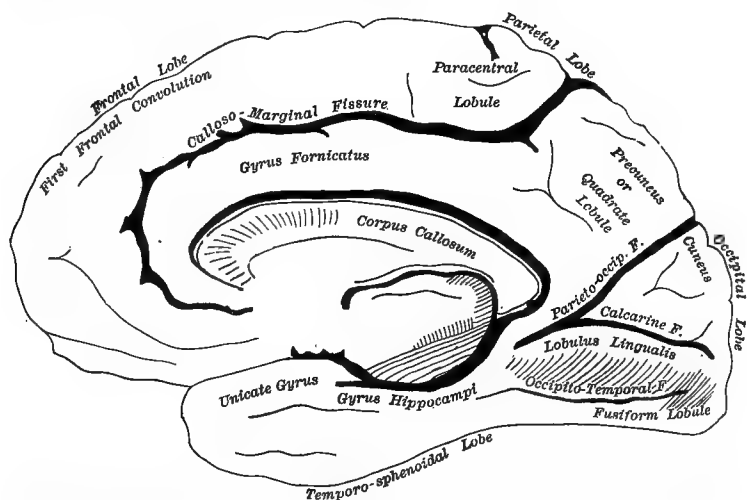

FIG. 382.—Diagrammatic representation of internal surface of right cerebral hemisphere, as seen in vertical longitudinal median section (after Flint and Ecker).

Among the more modern observers, Flourens held that removal of small portions of the cerebral cortex produced no effect on either will-power or intelligence, but that if carried far enough both volition and intelligence were completely destroyed. Later observers, say, of ten years ago, maintained that the whole or the greater part of the cerebral cortex might be mapped out into areas with a definite function. The methods of investigation have been clinico-pathological and physiological.

It was found that, on stimulating certain areas of the cortex (e. g., the so-called motor area), certain movements followed, but that similar results were obtained when the electrodes were applied directly to the white matter underlying the cortex; hence the results of such experiments were not conclusive. It was held that, if certain regions thus respondent to a stimulus were removed, the movements of corresponding muscles should be abolished; in other words, these should be localized paral-

sis. It was then asserted by certain experimenters that such was the case, while others strenuously denied this. By com-

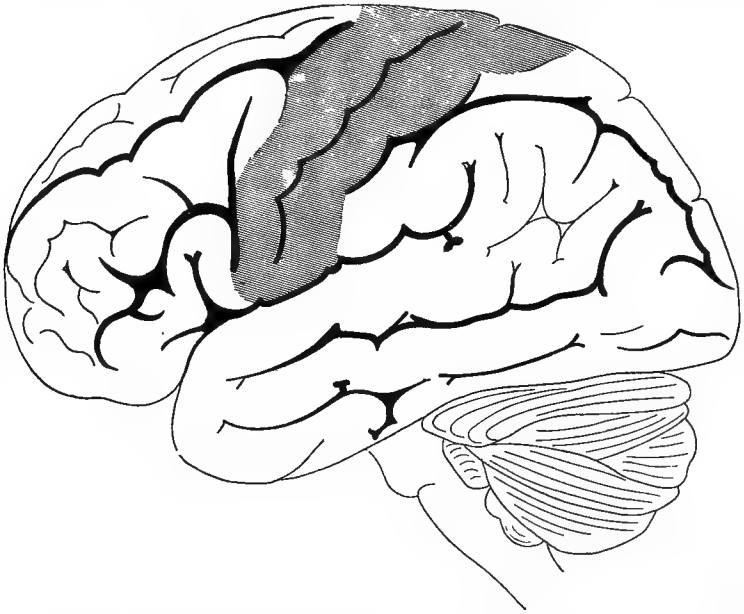

FIG. 383.—Outer surface of cerebrum (after Exner). The shaded portion represents *the motor* in man and the monkey—i. e., the area which most observers believe to be associated with certain voluntary movements of the limbs, etc.

binning the method of stimulation with that of ablation (or the removal of definite portions of the cortex), a very extensive localization was established by certain observers (Hitzig, Ferrier, etc.). This was not confined to motor functions, but involved sensory ones.

On the other hand, one physiologist (Goltz) has from the first maintained, as the result of experiments on the dog, that localization of the character described by the above-mentioned observers does not exist. He finds that no amount of ablation of the cerebrum will lead to paralysis, and that, if lesions in any part be but extensive enough, the sensory perceptions and the intelligence of the animal are impaired. It is found that the movements of dogs, after the removal of a considerable portion of the cerebral cortex are awkward; that one or all of the animal's sensory perceptions may be impaired; that, in fact, the creature may be reduced to a mere eating and drinking machine, as it were; but that paralysis proper does not exist.

About the same time another experimenter (Munk) had been attempting to map out the region of the cortex concerned in vision. As a result of removal of different portions of the occipital lobe in dogs, he had concluded that a portion of this lobe constituted the cortical visual center, and, further, that the blindness resulting from such operations as are now under consideration was either "absolute" or "psychical"; by which was meant, in the first instance, an inability to bring the images of the retina into consciousness, and, in the second, inability to interpret visual sensations intelligently, the one or the other result being dependent on the part of the limited visual center that was removed. This may be regarded as perhaps the most extreme form of sensory localization yet taught.

Goltz, as a result of his latest experiments, not only denies that operations on the occipital lobe are peculiar in producing visual disturbances, but points out that these lead to sensory defects overlooked by Munk. This observer (Goltz), as a result of comparing a dog, with both anterior cerebral lobes removed, with others from which were removed, in the one case, the right, and in the other the left corresponding parts (anterior cerebral lobes), since he finds the dog with both removed in a worse condition than would be represented by the joint result of the addition of the imperfections of the other two, concludes that one cerebral lobe may, to a certain extent, take up the functions of another. In other words, he admits localization but only of the roughest kind.

A view advanced by Schiff deserves probably more consideration than it has received, viz., that motor areas are so related to tactile sensations arising in different parts of the body that when the former are stimulated the resulting movements are really reflex—i. e., the stimulation of the cortex replaces the afferent sensory impulses, which usually are associated with the movements in question.

In the mean time it has been found that in many cases it was possible to locate the site of a brain-lesion (tumor, etc.) by the symptoms, chiefly motor, of the patient; and brain-surgery has in consequence entered upon a new era of development. Tumors thus localized have been removed successfully, and the patients restored to health. As a result of the various kinds of observations and discussions on this subject of late years, the localizationists are willing to admit that the areas of the cortex can not be marked off mathematically—that, in fact, they "overlan." This is in itself an important concession. Again,

there is less confidence in the location of the various sensory centers than of the motor centers. Most investigators are believers in a "motor area" *par excellence* (for the arm, leg, etc.) around the fissure of Rolando. This view is now, so far as man is concerned, widely accepted.

There is agreement in placing the sensory centers behind the above-mentioned motor area, and especially in the occipital lobes. The tendency to locate a visual center in this region is growing stronger. There is much disagreement as to the other sensory centers formerly placed in the angular gyrus and temporo-sphenoidal lobes. The intellectual faculties have not been located in any such sense as Gall and his followers attempted to establish. The first two frontal convolutions are those perhaps to which localization has as yet been least applied. Chiefly on clinical and pathological grounds a center for speech has long been located in the third (left) frontal convolution (Broca's) and parts immediately behind it. It has been observed that, when disease attacks this area, speech is interfered with in some way.

We may say then, generally, that the tendency at the present time, both on the part of physiologists and clinical observers, is to admit localization to some degree and in some sense. This has been the result in part of experiments on the dog and especially on the monkey, combined with the discussion of clinical cases which resulted in death (followed by an autopsy), or of others marked by a successful diagnosis and removal of lesions or other treatment. In other words, the truth, if it will be reached at all, must be reached by the method we have advocated throughout this work—the discussion of the results of as many different methods as can be brought to bear on this or any other subject. Neither the experimental nor the pathological method can settle such complex questions, as we shall endeavor to show when we return to the subject later.

The Circulation in the Brain.—The brain, being inclosed within an air-tight bony case, its circulation is of necessity peculiar. Since any undue compression of the encephalon may lead to even a fatal stupor, it is clear that there must exist some provision to permit of the excess of arterial blood that is required for unusual activity of the brain. It is to be borne in mind that the fluid within the ventricles is continuous, through the foramen of Majendie in the roof of the fourth ventricle, with that surrounding the spinal cord (spinal cavity); so that an increase in the volume of the encephalon in consequence of an afflux of blood might be in some degree compensated by an

efflux of the cerebro-spinal fluid. The part played by this arrangement has, however, been probably overestimated. But the peculiar venous sinuses do, it is likely, serve to regulate the blood-supply; being very large, they may answer as temporary overflow receptacles. An inspection of the fontanelles of an infant reveals a beating corresponding with the pulse; and, when a large part of the cranium is removed in an animal, a plethysmograph shows a rise in volume corresponding with the pulse and the respiratory movements, as in the case of the fontanelles. But, besides these, periodic waves of contraction are now known to pass over the cerebral arteries.

Whether the latter is part of a general wave traversing the whole arterial system is as yet uncertain. Though there is considerable anastomosis of vessels in the encephalon, it is not equal to what takes place in many other organs. It is well known that a clot or other plug within a cerebral vessel is more serious than in many other regions, which is partly to be explained by the lack of sufficient anastomosis for the vascular needs of the parts. It is also well known that, in organs which constitute parts of a related series, as the different divisions of the alimentary tract, all are not usually at the same time vascular to the same extent. While they act functionally in relation to each other, they exemplify also a certain degree of independence. Such a condition of things is now known to exist in the brain—i. e., certain areas may be abundantly supplied with blood as compared with others; and it seems highly probable that a condition of equal arterial tension throughout is scarcely a normal condition. Though the quantity of blood contained within the vessels of the whole brain at any one time is not so large as in some other organs (glands), yet the foregoing facts and the rapidity of the flow must be taken into account. The capillaries are very close and abundant, in the gray matter especially; and it is to be borne in mind that it is chiefly these vessels which are concerned in the actual metabolism (nutrition) of parts. However, the chemical changes in the nervous system being feeble, it would appear probable that it does its work with less consumption of pabulum than other parts of the body. We wish to lay stress on the local nature of vascular dilatation in the brain as, it greatly assists in explaining certain phenomena about to be considered.

Sleep.—Observations upon animals from which portions of the cranium had been removed, so that the brain was visible, show that during sleep the blood-vessels are much less promi-

ment than usual; and it is well known that means calculated to diminish the circulation in the brain, as cold and pressure, favor sleep. It is also well established by general experience that withdrawal of the usual afferent impulses through the various senses favors sleep. A remarkable case is on record of a youth whose avenues for sensory impressions were limited to one eye and a single ear, and who could be sent to sleep by closing these against the outer world. Yet this subject after a long sleep would awake of his own accord, showing that, while afferent impulses have undoubtedly much to do with maintaining the activity of the cerebral centers, yet their automaticity (independence) must also be recognized.

It is a matter of common experience that weariness, or the exhaustion following on pain, mental anxiety, etc., is favorable to sleep.

A good deal of light is thrown on this subject by *hibernation*, particularly in mammals.

From special study of the subject we have ourselves learned that, however temperature and certain other conditions may influence this state, it will appear at definite periods in defiance, to a large extent, of the conditions prevailing. Hibernation, we are convinced, is marked by a general slowing of all of the vital processes in which the nervous system takes a prominent part. Sleep and hibernation are closely related. In both there is a diminution of the rate of the vital processes, as shown by the income and output, measured by chemical standards, with of course obvious physical signs, as slowed respiration, circulation, etc. While sleep, then, is primarily the result of a rhythmical retardation of the vital processes, especially within the nervous system, it is like hibernation in some degree (in the lowest creatures, without a nervous system) the outcome of that rhythm impressed on every cell of the organism and the influence of which is felt in a thousand ways, that no doubt we are quite unable to recognize.

Dreaming is a partial activity of the mind, corresponding doubtless to functional wakefulness or relatively increased action of some limited part or parts of the brain. It is now all but certain that these parts are more vascular—i. e., we must reckon with a localized vascularity and functional activity. If this be recognized, almost all the peculiarities of the dreaming state may be understood. Dreams usually lack some elements that give the completeness and consistency of waking thought—a matter readily understood, as well as the unrest of a dreamy

night, by the facts above considered. It is, moreover, highly probable that not only different parts of the brain have a different psychological function, but also that in any one chain of thought or state of consciousness only a certain number of parts are prominently engaged; and that what is termed confusion of mind is probably a result of the activity of certain other centers to a degree unusual—i. e., they are relatively too obtrusive, hence that balance essential to all normal activity, psychological and other, is lost.

Specialization, physiological division of labor, holds here as elsewhere.

Hypnotism.—By the help of the above principles the subject of hypnotism, now of absorbing interest, may be in great part explained. This condition is characterized by loss of volition and judgment. It may be induced in man and certain other animals by prolonged staring at a bright object, assisted by a concentration of the attention on that alone, as far as possible, combined with a condition of mental passivity in other respects. The individual gradually becomes drowsy, and finally falls into a state in many respects strongly resembling sleep. With each recurrence, the hypnotic condition is usually more readily induced, and persons have passed into it in the entire absence of the usual procedure, having simply been told that they would be thus affected at a given hour. There is no special influence emanating from peculiarly gifted mediums, and most persons may be hypnotized to a greater or less degree, though with unequal readiness.

The manifestations are very variable, but are usually characterized by either total abolition of certain sensory perceptions, by their enfeeblement, or by one or both of these, combined possibly with exaltation of others. Thus, anæsthesia may be so great that surgical operations may be performed without consciousness of pain. The muscular sense may be good, so that the subject can write well. He may smell better than usual, so as to be able to detect persons by the odors from a portion of their clothing, like a dog. There may coexist, with vision for form, color-blindness. These are to be regarded merely as examples, from numberless curious combinations. Again, the affection of sense may be bilateral or only unilateral.

Hypnotism proper may be combined with *cataplexy*, a condition in which the limbs remain rigid in whatever condition they may be placed. Modifications of the vascular and respiratory systems occur. Other animals have been hypnotized, as

the fowl, rabbit, Guinea-pig, crayfish, frog, etc. This condition is readily induced in the common fowl, more especially the wilder individuals, by holding the creature with the bill down on a table and the whole animal perfectly quiet for a short time. Upon the removal of the pressure the bird remains perfectly passive and apparently asleep for some little time.

The subject of hypnotism and allied conditions has of late received close attention from a large number of observers. Among other surprising results as the consequence of "hypnotic suggestion," certain pathological effects have been produced: thus, placing a piece of tissue-paper on the skin, with the suggestion that an actual blister is being applied, has resulted in the usual effects of such treatment.

Somnambulism is very similar to hypnotism. Individuals have been known to walk, ride, climb, go upon a journey and pay toll, and also to perform their ordinary avocations. A student has been known to write a sermon, read it over, and make corrections, and when a piece of pasteboard was placed before his eyes this still went on, showing that the images were mental.

Without being actually hypnotized, by careful observation of one's experiences for a considerable period, one may catch, as it were, the realization, at different times, of the various phenomena that characterize the hypnotic condition, even to details—though not, of course, in that complex combination which would result in such partial or complete loss of consciousness as marks the actual condition; for in that case observation would be very difficult, if not impossible. To illustrate our meaning briefly, one may walk a considerable distance, noticing absolutely nothing *consciously*, but wholly absorbed in one idea, or possibly without any distinct train of thought. In such a case there is neither vision, hearing, nor tactile sensation in the ordinary sense. The person is, in fact, for the time practically in the somnambulistic condition or one closely allied to it. There are times when vision is in abeyance, or only one eye used. Though apparently looking, we do not see. The sensory perceptions from the skin may be so purely unilateral that the other side is practically anæsthetic from close attention to the condition of one side. All are familiar with unilateral vasomotor effects, such as the redness and "burning" of one cheek or one ear, and so of many other experiences that might be referred to did space permit. Such realizations furnish the highest kind of knowledge, we might say the only true knowledge.

Pathology sheds some light on this subject. In diseases of the membranes of the brain, all the sensory phenomena may be so heightened as to become painful. Slight sounds, a little light, feeble vibrations, a gentle touch, all give rise to effects out of proportion to the usual ones. From the close proximity of these membranes to the cerebral cortex, we may assume that they are affected. This, together with the results of stimulation and removal of the surface of the brain, brings us some way on toward an explanation of sleep, dreaming, hibernation, hypnotism, and cerebral localization itself.

One physiologist has given, as an explanation of hypnotism, etc., inhibition of the cells of the cerebral cortex, and this, within limits, is no doubt true. The facts of hypnotism and allied phenomena seem most of all to emphasize the dependence of the central cells when acting normally on afferent impulses. But we have already dwelt on this important subject sufficiently to render our meaning clear.

CEREBRAL LOCALIZATION RECONSIDERED.

An examination of the phenomena of the states recently considered can leave no doubt in the mind that certain parts of the brain, even certain portions of the cerebrum, may be active while the remaining ones are in abeyance or but feebly engaged; and, as has been seen, our every-day experience is an illustration of the same fact. The circulation in the brain points clearly to its being a collection of organs, with a certain degree of independence. It is therefore unreasonable to assume that all parts of the cerebral cortex discharge equally the same functions. On the other hand, it is just as unwarrantable to assume that, in the face of all the facts of physiology as now known to us, there are very precisely limited areas with as exactly restricted functions discharged independently of all the other parts. As we have frequently insisted, the functions of an organ are alone normal when in proper relation to all the parts with which it is connected—that is, in fact, with the entire body. We learned that any conclusions based on artificial fistulæ of the digestive organs could be only approximately correct at best, and might be very far from the truth in the sense to which we now refer. To assume that there is only one path by which certain classes of impulses *must* travel in the spinal cord has been shown to be unwarranted. Therefore, to argue that because the removal of a certain portion of the brain either is or is not followed by

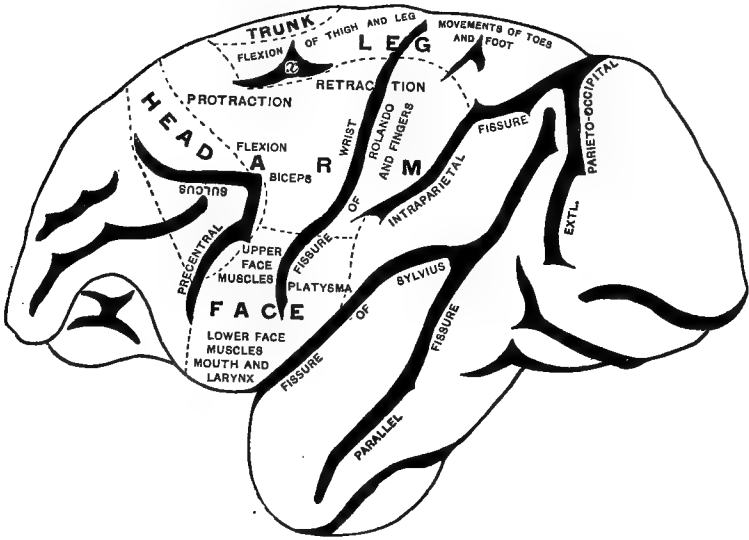

FIG. 384.—Lateral surface of brain of monkey, displaying motor areas (after Horsley and Schäfer).

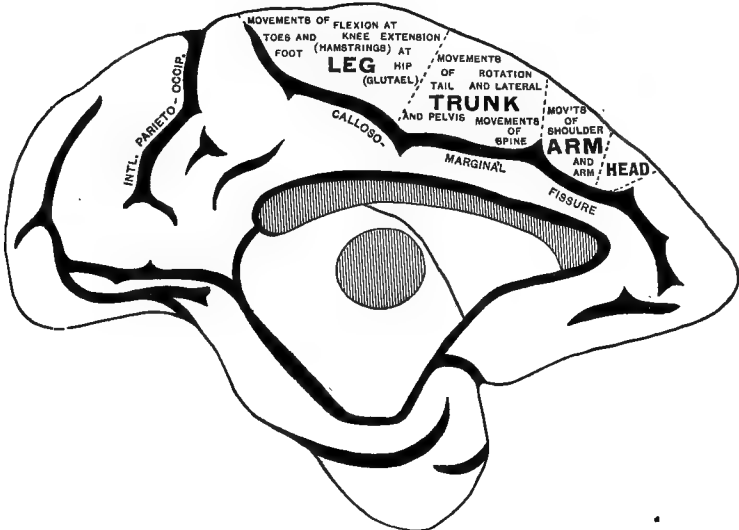

FIG. 385.—Median surface of brain of monkey (after Horsley and Schäfer).

Figs. 384 and 385 may be said to embody the views of Horsley and Schäfer more especially, in regard to motor localization.

certain modifications or loss of function, proves that this part is or is not concerned with that particular kind of activity, does not seem to be logical.

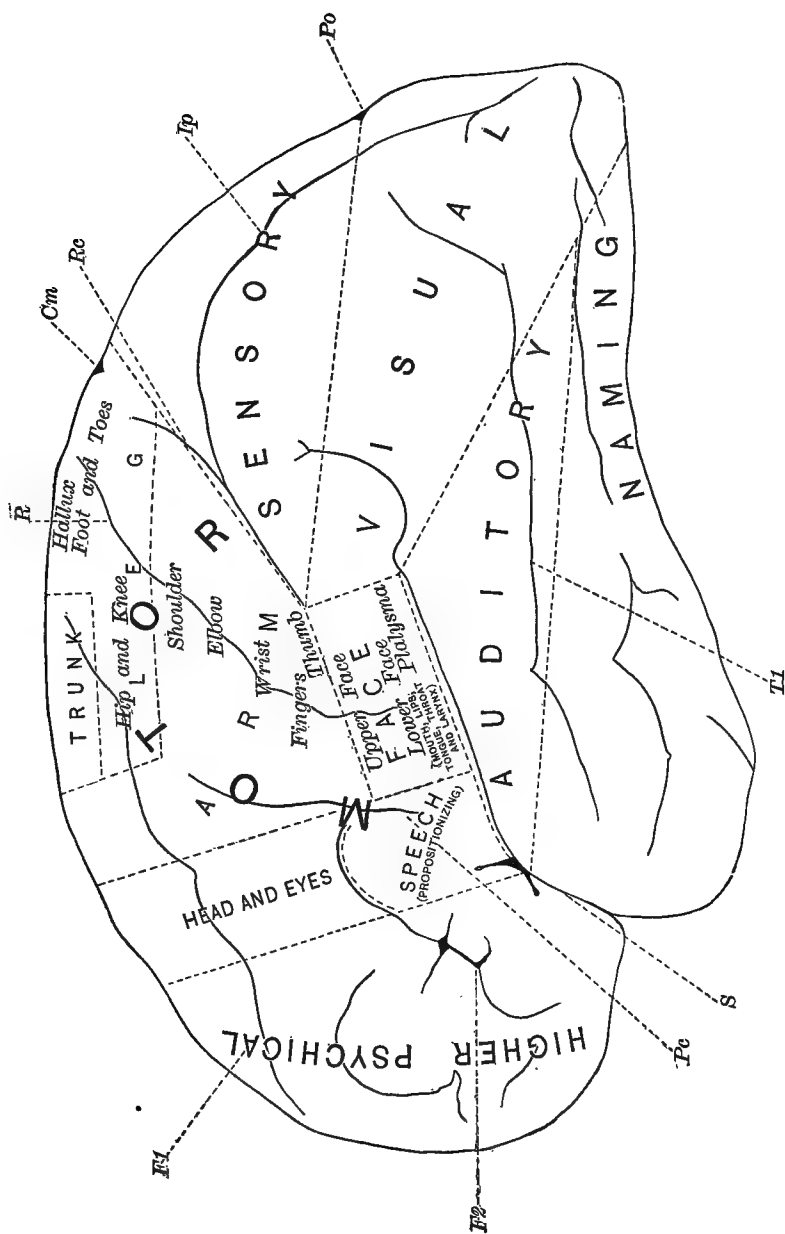

Fig. 886.—Areas of the lateral aspect of the cerebrum of man and subdivisions of the motor area. (after C. K. Mills).

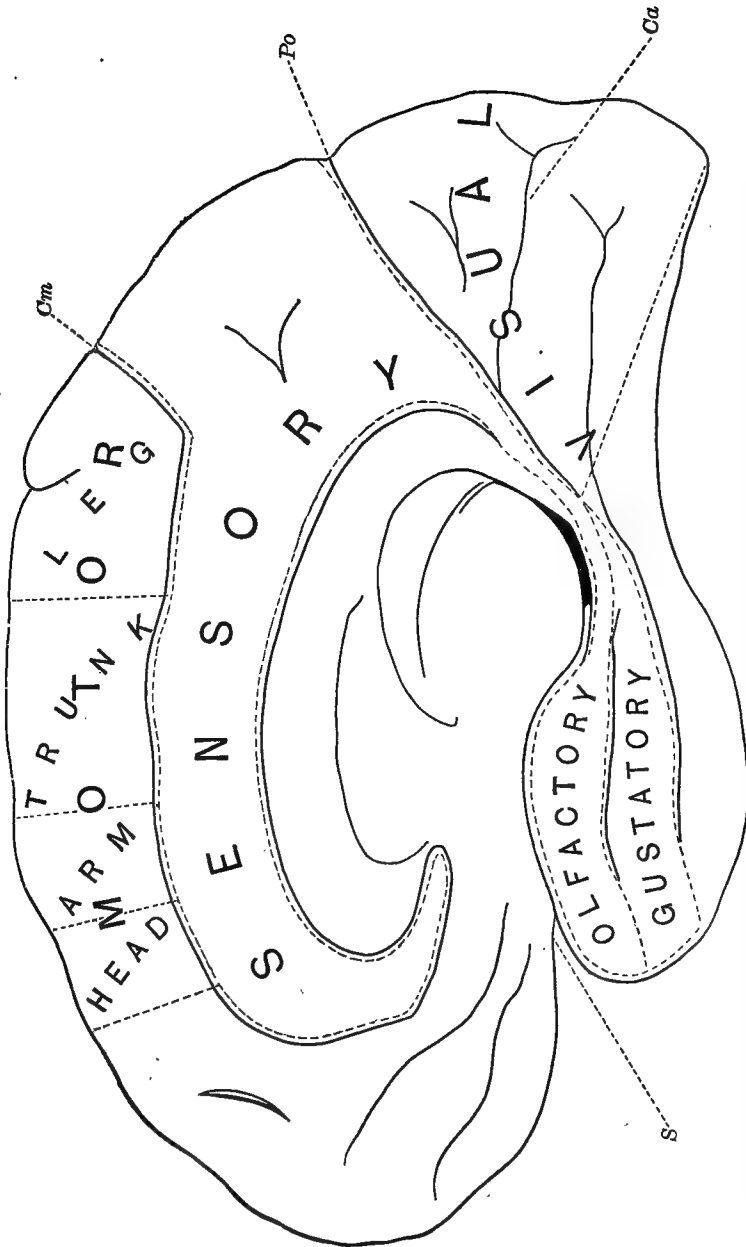

FIG. 387.—Areas of the median aspect of the cerebrum (after C. K. Mills). These figures, based upon the investigations of Ferrier, Horsley, Schäfer, and others, and upon a study of clinical cases, more especially in regard to the subdivisions of the motor zone, are an attempt, it will be seen, to embody the results of clinical, pathological, and physiological investigation together; and may be said to represent the limits to which localization theories have been pushed.

If it be true, as it unquestionably is, that a certain region of the cortex or other portion of the brain is normal only when in relation with others, it follows that mere removal can not entirely solve such problems as the function of the different parts. Nor does it follow, because a localization, meeting the needs of practical medicine and surgery, has been established, that therefore we are justified in assuming that a scientific localization rests upon the same grounds. Any theory that fails to recognize both the interdependence of parts and the resources of nature in substituting one part for another functionally, overlooks principles of very wide application in biology. We must express our conviction that neither ablation, stimulation, pathological observation, the results of surgical interference, nor the facts of clinical medicine, can any of them *singly* settle such questions.

The comparative method has been as yet but little used. Conclusions in regard to the monkey have been applied not only to man but other animals; and that the experiments upon dogs should result in changes or the absence of changes, to which there is no correspondence in the monkey, has hardly been recognized as it should. It is only by the synthetical method, as we have so often urged, that even an approximation to the truth or a part of it can be attained. Results from one method or another, taken alone, may be positively misleading, unless interpreted in the light of many other facts. The interpretation is the difficult portion of the task in the study of localization; but, before we are prepared to formulate a correct and comprehensive theory, we must begin lower in the animal scale, extend observations over a large number of animals, and complete these by pathological and clinical observations on man and other mammals. If the spinal cord becomes functionally what it is in any case largely through the life experiences of the individual, this must also apply to the brain, hence we must look for individual as well as group differences.

The loss of speech (aphasia), in consequence of lesions in the left third frontal convolution, was formerly pointed to as undoubted evidence of localization; but, the more this subject has been studied, the more clearly it has been perceived that even in this case the theories of a rigid localization break down.

The speech-center has had its boundaries extended; and it turns out that a vast complex of connections must be considered, many of which are not confined to the third frontal convolution or its neighborhood.

There is a kind of experimental evidence that throws a good deal of light on the present discussion. It is found that, when certain drugs have been administered, the irritability of the cortex is either increased or diminished, according to the stage of action of the drug (morphia, etc.). It is not impossible that epileptiform convulsions may result from the application of a stimulus of almost any strength, though this result does not follow when the electrodes are applied to the underlying white substance. The disease epilepsy has been known to follow injuries to the cranium or the brain membranes, in consequence of which the cells themselves of the cortex have been altered in function. Moreover, the epileptiform movements may be in such cases confined to certain muscles, thus pointing to a motor localization. If a muscle contraction, as the result of stimulation of a motor area (the animal being under the influence of morphia), be recorded by the graphic method, and the sciatic nerve then divided, in repeating the original experiment, it will be seen that the whole character of the curve is altered, the latent period having been lengthened, and the height of the curve lessened. This points to an inhibitory influence exercised over the cortical motor cells, by afferent influences, and we are at once reminded of Schiff's theory; but most of all do such experiments enforce that close relationship of all parts of the body which finds its reflection in the brain cortex as elsewhere.

We have dwelt upon the subject of cerebral localization at length, because of its great practical and scientific importance, not alone for medicine and physiology, but in the allied department of psychology. In conclusion, we may express the view that there is in the cerebral cortex a localization of function, variable for each group of animals, and to some extent for each individual; that it is not of a character to be mapped out by mathematical lines; that in case of disease or injury one part may to a certain extent take up the functions of another; that the functions of any part, however limited, are only to be understood when taken in connection with all other parts of the cortex, of the brain, and, in fact, of the entire body. These views we believe to be borne out by the facts of physiological experiment, clinical medicine, operative surgery, pathology, sleep, dreaming, hypnotism, the nature of the cerebral circulation, and the general truths of biology.

Cerebral Time.—We have already considered cerebral reflex time, and now proceed to examine into the period occupied by a mental operation involving attention and volition.

When a subject makes some signal in response to a stimulus, we recognize three parts to the entire chain of events: 1. The time occupied in the passage of the afferent impulses inward along certain lengths of nerve from a peripheral sense-organ. 2. The time taken up by the processes of the central cells before the efferent nervous discharge takes place. 3. The time consumed by the passage of the efferent impulses from the center to the muscle involved. The whole interval is termed the *reaction-time*, while the second constitutes the *reduced reaction-time*.

As the first and third probably vary but little, it is highly probable that the difference in the reaction-time observable in different individuals, and very much modified by the condition at the moment (as fatigue), and especially by practice, is traceable to the central cells. In popular language, some persons are, as compared with others, slow thinkers. This factor is the "personal equation," so called. There are, of course, many sources of error in such calculations, but approximate results of value may be reached. It would appear that the reaction period for tactile is shorter than for visual or auditory sensations, while that of vision is longer than for hearing. The respective periods have been set down as about $\frac{1}{4}$ of a second for vision, $\frac{1}{8}$ for audition, and $\frac{1}{4}$ for feeling.

The central processes may be reckoned to take (for perception and volition) about $\frac{1}{10}$ of a second.

If discriminations have to be made—so as to decide, e. g., whether it is the right or the left side of the body that has been touched—a longer time is, of course, required, and the reaction period in this case also varies greatly. It has been set down as occupying from $\frac{1}{10}$ to $\frac{1}{2}$ of a second. From these considerations, it will be plain that "the lightning-like rapidity of thought" is a rather extravagant figure of speech.

FUNCTIONS OF OTHER PORTIONS OF THE BRAIN.

Certain parts of the encephalon are spoken of as the basal ganglia, prominent among which are the corpus striatum and the optic thalamus.

The Corpus Striatum and the Optic Thalamus.—The corpus striatum consists of several parts, the main divisions being an intra-ventricular portion or caudate nucleus, and an extra-ventricular part or lenticular nucleus.

Between these lies the internal capsule, through which

pass fibers that spread out toward the cortex, as the *corona radiata*.

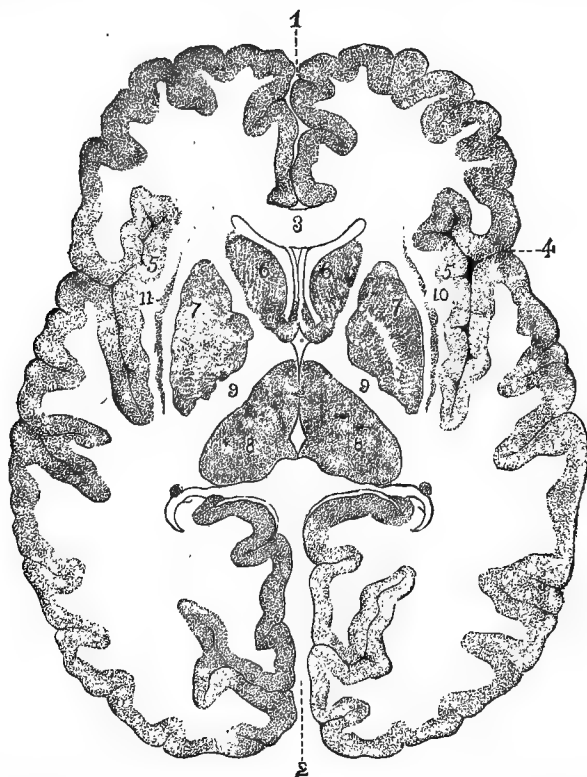

FIG. 388.—Transverse section of cerebral hemispheres, at level of cerebral ganglia (after Dalton). 1, great longitudinal fissure; 2, part of same between occipital lobes; 3, anterior part of corpus callosum; 4, fissure of Sylvius; 5, convolutions of island of Reil (insula); 6, caudate nucleus of corpus striatum; 7, lenticular nucleus of corpus striatum; 8, optic thalamus; 9, internal capsule; 10, external capsule; 11, claustrum.

Pathology, especially, has shown that a lesion of the intra-ventricular portion of the corpus striatum, and, above all, of the internal capsule, is followed by failure of voluntary movement (akinesia). It would appear that a great part of the fibers from the motor area around the fissure of Rolando, pass through the intra-ventricular parts of the corpus striatum, and especially its internal capsule. But it is also to be borne in mind that a large part of the fibers passing from the cortex make connection with the cells of the corpus striatum before reaching the cord. These facts render the occurrence of loss of voluntary motor power comprehensible.

The fibers of the peduncles of the brain may be divided into

an interior or lower division (*crusta*), going mostly to the corpus striatum, and a posterior division (*tegmentum*), passing principally to the optic thalami; many, possibly most of them, ultimately reach the cortex. Many clinical observers do not hesitate to speak of the optic thalamus as sensory, in function and the corpus striatum as motor; but the clinical and patho-

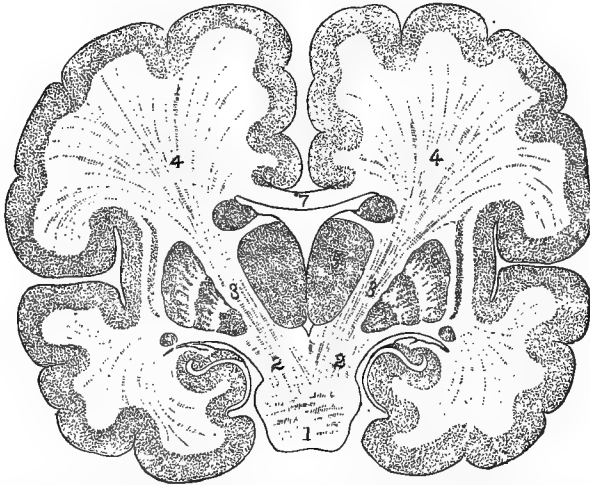

FIG. 389.—Transverse section of human brain (after Dalton). This and the preceding figure are somewhat diagrammatic. 1, pons Varolii; 2, 2, crura cerebri; 3, 3, internal capsule; 4, 4, corona radiata; 5, optic thalamus; 6, lenticular nucleus; 7, corpus callosum.

logical evidence is conflicting—all lesions of these parts not being followed by loss of sensation and motion respectively; though an injury to the internal capsule generally results in paralysis. All are agreed that the symptoms are manifested on the side of the body opposite to the side of the lesion, so that a decussation must take place somewhere between the ganglion and the periphery of the body.

There is no doubt that the optic thalamus, especially its posterior part, is concerned with vision, for injury to it is followed by a greater or less degree of disturbance of this function. As has been already pointed out, unilateral injury of either of these ganglia leads to inco-ordination or to forced movements. That these regions act some intermediate part in the transmission of impulses to and from the brain cortex, and that the anterior one is concerned with motor, and the posterior possibly with sensory (tactile, etc.), and certainly with visual impulses, may be stated with some confidence, though further details are not yet a subject of general agreement.

Corpora Quadrigemina.—The function of these parts in vision, as in the co-ordination of the movements of the ocular muscles,

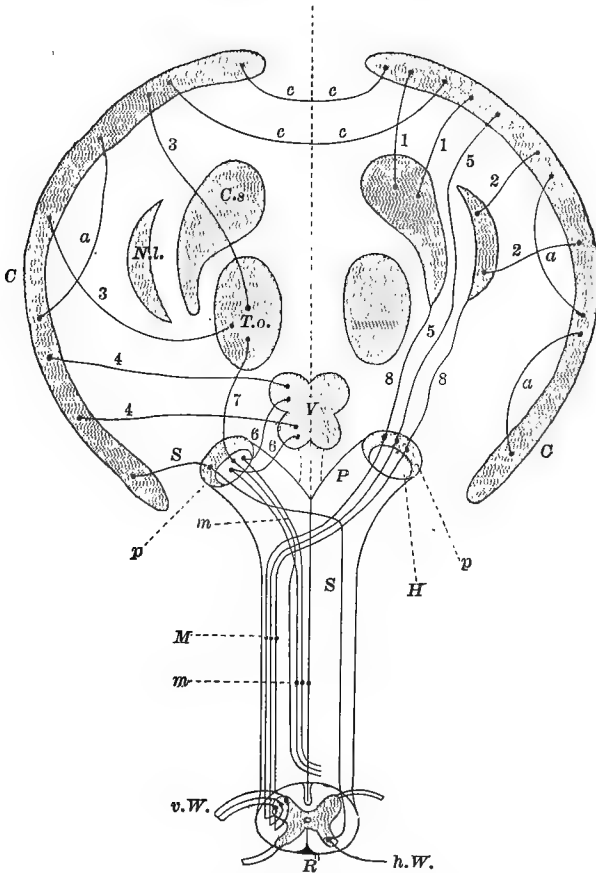

FIG. 390.—Diagrammatic representation of brain on transverse section to illustrate course of fibers (after Landois). *C, C*, cortex cerebri; *C. s.*, corpus striatum; *N. l.*, lenticular nucleus; *T. o.*, optic thalamus; *P*, peduncle; *H*, tegmentum; *p*, crusta; *V*, corpora quadrigemina; 1, 1, corona radiata of corpus striatum; 2, 2, of lenticular nucleus; 3, 3, of optic thalamus; 4, 4, of corpora quadrigemina; 5, direct fibers to cortex cerebri (Flechsig); 6, 6, fibers from corpora quadrigemina to tegmentum; *m*, further course of these fibers; 8, 8, fibers from corpus striatum and lenticular nucleus to crusta of peduncle of cerebrum; *M*, further course of these; *S, S*, course of sensory fibers; *R*, transverse section of spinal cord; *v. W.*, anterior, and *h. W.*, posterior roots; *a, a*, system of association fibers; *c, c*, commissural fibers.

and their relations to the movements of the pupil, will be considered later. However, the actual centers for these functions seem to lie in the anterior portion of the floor of the aqueduct of Sylvius, and are indirectly affected by stimulation of the corpora quadrigemina. Extirpation of these parts on

one side produces blindness of the opposite eye, and in birds, etc., the same result follows when their homologues—the optic lobes—are similarly treated. There can be no doubt, therefore, that they are a part of the central nervous machinery of vision, and it seems to be probable that the anterior parts of the corpora quadrigemina alone have this visual function. But, since it is the opposite eye that is affected, and in some animals (rabbits) that alone, we are led to infer a decussation of the optic fibers, or at least of impulses. In dogs, on the other hand, the crossing seems to be but partial. From the fact that only a part of the visual field is wanting (hemianopsia—i. e., that only the half of the usual field of view is visible), and, since there may be hemianopsia of both eyes, with unilateral disease of the brain, it has been inferred that in man the decussation is also incomplete. We may remark incidentally that it has lately been maintained that removal of one occipital lobe in the monkey leads to hemianopsia of the opposite eye. These parts, as we have already seen, take some share in the co-ordination of muscular movements, and give rise to forced movements after unilateral injury.

It begins to appear that there are several parts of the brain concerned with vision. After removal of almost any part of the cerebral cortex, if of sufficient extent, vision is impaired. We may say, then, that, before an object is “seen” in the highest sense, processes beginning in the retina undergo further elaboration in the corpora quadrigemina, optic thalami, and, finally, in the cerebral cortex. We may safely assume that the part played by the latter is of very great importance, making the perception assume that highest completeness which is of very varying character, no doubt, with different groups of animals. In a sense, all mammals may see alike, and, in another sense, they may see things very differently; for, if we may judge by the differences in this respect between educated and uneducated men, the great dissimilarity lies in the interpretation of what is seen; in a word, the cortex has to do with the perfecting of visual impulses. Nevertheless, a break anywhere in the long and complicated chain of processes must lead to some serious impairment of vision. Much of the same sort of reasoning applies to the other senses and also to speech.

To speak, therefore, of a visual center or a speech center in any very restricted sense is unjustifiable; at the same time, it is becoming clearer that there is in the occipital lobe, rather than in other parts of the cortex, an area which takes a pecul-

iar and special share in elaborating visual impulses into visual sensations and perceptions; and there can be little doubt that the other senses are represented similarly in the cerebral cortex.

The Cerebellum.—Both physiological and pathological research point to the conclusion that the cerebellum has an important share in the co-ordination of muscular movements. Ablation of parts of the organ leads to disordered movements; and, when the whole is removed in the bird, co-ordination is all but impossible, and the same holds for mammals. Section of the middle peduncle of one side is liable to give rise to rolling forced movements. In fact, injury to the cerebellum causes symptoms very similar to those following section of the semi-circular canals, so that many have thought that in the latter case the cerebellum had itself been injured.

Pathological.—Tumors and other lesions frequently, though not invariably, give rise to unsteadiness of gait, much like that affecting an intoxicated person. It may safely be said that the cerebellum takes a very prominent share in the work of the muscular co-ordination of the body.

As has already been pointed out, several tracts of the spinal cord make connection with the cerebellum, and it is not to be forgotten that this part of the brain has, in general, most extensive connections with other regions. Insufficient study has as yet been given to the cerebellum, and it is likely that the part it takes in the functions of the encephalon is greater than has yet been rendered clear. The old notion that this organ bears any direct relation to the sexual functions seems to be without foundation. It has now been clearly demonstrated that the lower region of the spinal cord is, in the dog and probably most mammals, the part of the nerve-centers essential for the sexual processes.

Crura Cerebri and Pons Varolii.—As has been already noted, the peduncles (crura) are the paths of impulses from certain parts of the cerebral cortex, the basal ganglia, and the spinal cord. The functions of the gray matter of the crura are unknown. But, since forced movements ensue on unilateral section, it is plain that they also have to do with muscular co-ordination.

The transverse fibers of the *pons Varolii* connect the two halves of the cerebellum. Its longitudinal fibers have extensive connections—the anterior pyramids and olivary bodies of the medulla, the lateral, and perhaps also a part of the posterior

columns of the cord, while upward these fibers connect with the crura cerebri and so with the cortex.

Pathological.—Paralysis of the face usually occurs on the same side as that of the rest of the body; hence it must be inferred that there is a decussation somewhere of the fibers of the facial nerve; but there is much still to be learned about this subject.

Medulla Oblongata.—In some animals (frogs) it is certainly known that this region of the brain has a co-ordinating function, and it is probable that it is concerned with such uses in all animals that possess the organ, or rather collection of organs, seeing that this part of the brain must be regarded as especially a mass of centers, the functions of which have been already considered at length. So long as the medulla is intact, life may continue; but, except under special circumstances, which do not invalidate this general statement, its destruction is followed by the death of the animal.

We may simply enumerate the centers that are usually located in the medulla: The respiratory (and convulsive), cardio-inhibitory, vaso-motor, center for deglutition, center for the movements of the gullet, stomach, etc., and the vomiting center; center for the secretion of saliva and possibly other of the digestive fluids. Some add a diabetic and other centers.

SPECIAL CONSIDERATIONS.

Embryological.—The further we progress in the study of the nervous system, the greater the significance of the facts of its early development becomes. It will be remembered that from that uppermost epiblastic layer of cells so early marked off in the blastoderm, is formed the entire nervous system, including centers, nerves, and end organs. The brain may be regarded

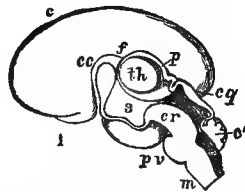

FIG. 391.—Vertical longitudinal section of brain of human embryo of fourteen weeks. 1×3 . (After Sharpey and Reichert.) *c*, cerebral hemisphere; *cc*, corpus callosum beginning to pass back; *f*, foramen of Munro; *p*, membrane over third ventricle and the pineal body; *th*, thalamus; *3*, third ventricle; *l*, olfactory bulb; *cg*, corpora quadrigemina; *cr*, crura cerebri, and above them, aqueduct of Sylvius, still wide; *c'*, cerebellum, and below it the

as a specially differentiated part of the anterior region of the medullary groove and its subdivisions; and the close relation of the eye, ear, etc., to the brain in their early origin, is not without special meaning, while the more diffused sensory developments in the skin connect the higher animals closely with the lower—even the lowest, in which sensation is almost wholly referable to the surface of the body.

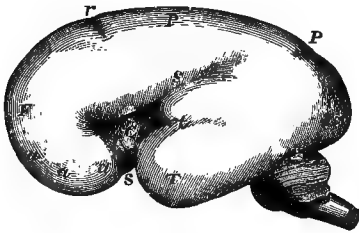

FIG. 392.

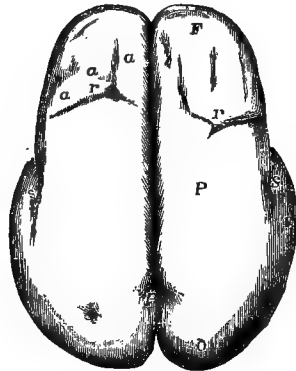

FIG. 393.

FIG. 392.—Outer surface of human foetal brain at six months, showing origin of principal fissures (after Sharpey and R. Wagner). *F*, frontal lobe; *P*, parietal; *O*, occipital; *T*, temporal; *a, a, a*, faint appearance of several frontal convolutions; *s, s*, sylvian fissure; *s'*, anterior division of same; *C*, central lobe of island of Reil; *r*, fissure of Rolando; *p*, external perpendicular fissure.

FIG. 393.—Upper surface of brain represented in Fig. 0q0 (after Sharpey and R. Wagner).

Without some knowledge of the mode of development of the encephalon, it is scarcely possible to appreciate that rising grade of complexity met with as we pass from lower to higher groups of animals, especially noticeable in vertebrates; nor is it possible to recognize fully the evidence found in the nervous system for the doctrine that higher are derived from lower forms by a process of evolution.

Evolution.—The same law applies to the nervous system as to other parts of the organism, viz., that the individual development (ontogeny) is a synoptical representation, in a general way, of the development of the group (phylogeny). A comparison of the development of even man's brain reveals the fact that, in its earliest stage, it is scarcely, if at all, distinguishable from that of any of the lower vertebrates. There is a period when even this, the most convoluted of all brains, is as smooth and devoid of gyri as the brain of a frog. The extreme complexity of the human brain is referable to excessive growth of

certain parts, crowding and alteration of shape, owing to the influence of its bony case, its membranes, etc.

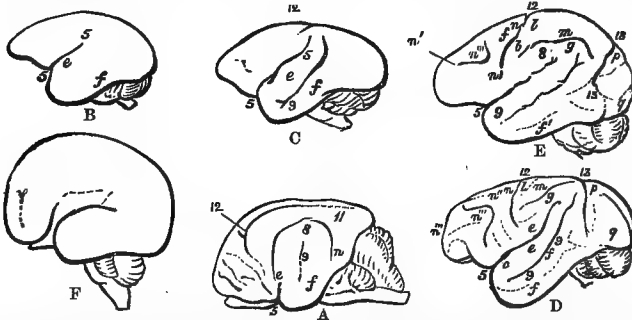

FIG. 394.—A, brain of aye-aye (*Lemur*); B, of marmoset; C, of squirrel-monkey (*Callithrix*); D, of macaque monkey; E, of gibbon; F, of a fifth-month human foetus (after Owen). Although naturalists are agreed that the monkeys, apes, and lemurs are related, considerable differences are to be observed in their brains. These figures also illustrate the remark made after the following ones.

It is evident, from an inspection of the cranial cavities of those enormous fossil forms that preceded the higher vertebrates, that their brains, in proportion to their bodies, were very small, so that any variation in the direction of increase in the encephalon—especially the cerebrum—must have given the creatures, the subject of such variation, a decided advantage in the struggle for existence, and one which may partly account, perhaps, for the extinction of those animals of vast proportions but limited intelligence. That the size of the brain

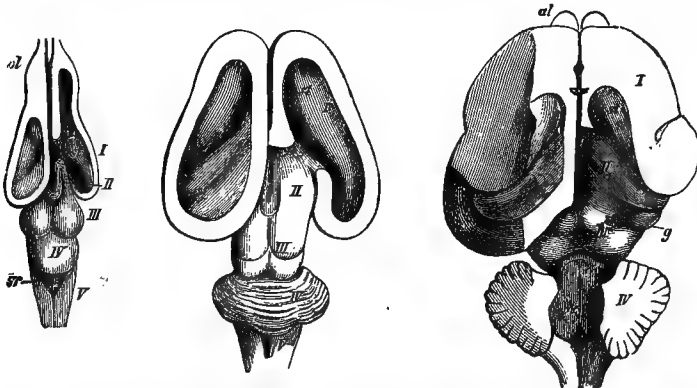

FIG. 395.—A, brain of a chelonian; B, of a foetal calf; C, of a cat. (All after Gegenbaur.) I indicates cerebral hemispheres; II, thalamus; III, corpora quadrigemina; IV, cerebellum; V, medulla; *st*, corpus striatum; *f*, fornix; *h*, hippocampus; *sr*, fourth ventricle; *g*, geniculate body; *ol*, olfactory lobe. It will be observed (1) how the foetal brain in a higher animal form resembles the developed brain in a lower form, and (2) how certain parts become crowded together and covered over by more prominent regions, e. g., the cerebrum, as we ascend the animal scale.

as well as its quality can be increased by use, seems to have been established by the measurements, at different periods of development, of the heads of those engaged in intellectual pursuits, and comparing the results with those obtained by similar measurement of the heads of those not thus specially employed. Of course, it must be assumed that the head measurement is a gauge of the size of the brain, which is approximately true, if

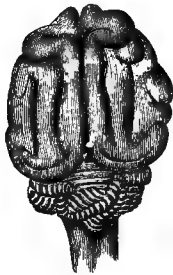

FIG. 396.

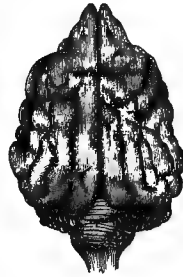

FIG. 397.

FIG. 396.—Brain of cat, seen from above (after Tiedemann).
 FIG. 397.—Brain of dog, seen from above (after Tiedemann).

not entirely so. There are many facts which go to show that the habits of ancestors tend to become almost the instincts of posterity, even in the case of man. It has been noticed that a facility in the acquisition of scholarship (languages, literature) has, in many cases, been associated with scholarly habits in numerous generations of ancestors. The inheritance of mental traits, which can not be considered wholly apart from a physical basis in the nervous system, and especially in the cerebrum, is a subject of great interest, but too wide for more than a passing allusion here.

Recent investigations seem to show that the development of the ganglion cells of the brain takes place first in the medulla, next in the cerebellum, after that in the mid-brain, and finally in the cerebral cortex. Animals most helpless at birth are those with the least development of such cells. The medulla may be regarded in some sense as the oldest (phylogenetically) part of the brain. In it are lodged those cells (centers) which are required for the maintenance of the functions essential to somatic life. This may serve to explain how it is that so many centers are there crowded together. It is remarkable that so small a part of the brain should preside over many important functions; but the principle of concentration with progressive development, and the law of habit making automatism

prominent, throw some light upon these facts, and especially the one otherwise not easy to understand, that so much important work should be done by relatively so few cells. Possibly, however, if localization is established as fully as it may eventually be, this also will not be so astonishing.

Nevertheless, the doctrine that so small a region of the medulla as is the vaso-motor center, for example, should control so many different vascular tracts, ought not to be finally accepted without close examination. It is so easy to speak of a "center" for any function and to locate it in the medulla; but it is not unlikely that the physiology of the future will greatly modify our present teaching in this regard. As in many other cases, the explanations seem to be too simple and too artificial.

The law of habit has, in connection with our psychic life and that of other mammals, some of its most striking developments. This has long been recognized, though that the same law is of universal application to the functions of the body has as yet received but the scantiest acknowledgment.

We shall not dwell upon the subject beyond stating that in our opinion the psychic life of animals can be but indifferently understood unless this great factor is taken into the account; and when it is, much that is apparently quite inexplicable becomes plain. That anything that has happened once anywhere in the vital economy is liable to repetition under a slighter stimulus, is a law of the utmost importance in physiology, psychology, and pathology. The practical importance of this, especially to the young animal, is of the highest kind.

The doctrine of a "cortical projection" for the senses, or cortical sense-centers, has enough foundation to enable us to draw certain inferences relative to the direction to be given to the education of youth. If true, then the education of the senses has a thoroughly good foundation in physiology, and "manual training" should receive the hearty support of scientists. It follows that in developing the senses we are developing the most important part of the brain for all higher ends, the cerebral cortex.

It will now also be clear that if there are cortical motor regions, then the size of the cerebrum and the muscular development may stand in a closer relation than we have been wont to believe. That connection of the muscular sense, tactile sensibility, sight, etc., aimed at in "manual training," is in harmony with what we have frequently urged in relation to the mutual dependence of one part of the brain upon another. Both theo-

retically and practically it is important to recognize that the value of vision, indeed, the extent to which we "see," is in no small degree related to what we feel. The carpenter judges distances well by his eye, because he is constantly correcting his visual judgments by his tactile sense, his muscular sense, etc.

We must point out, however, that the special developments of disease at the present day point to the dangers of an undue use or development of the cerebrum. That balance indispensable for health must be preserved, if the race is to avoid degeneration.

Synoptical.—There is as yet no systematized clear physiology of "the brain." We are conversant with certain phenomena referable to this organ in a number of animals, chiefly the higher mammals; but our knowledge is as yet insufficient to generalize, except in the broadest way, regarding the functions of the brain—i. e., to determine what is common to the brains of all vertebrates and what is peculiar to each group. Referring, then, to the higher mammals, especially to the dog, the cat, the monkey, and man, we may make the following statements:

The medulla oblongata is functionally the ruler of vegetative life—the lower functions; and so may be regarded as the seat of a great number of "centers," or collections of cells with functions to a large degree distinct, but like close neighbors, with a mutual dependence.

Phylogenetically (ancestrally) the medulla is a very ancient region, hence the explanation apparently of so many of its functions being common to the whole vertebrate group.

Parts of the mesencephalon, the pons Varolii, the optic lobes or corpora quadrigemina, the crura cerebri, etc., are not only connecting paths between the cord and cerebrum, but seem to preside over the co-ordination of muscular movements, and to take some share in the elaboration of visual and perhaps other sensory impulses.

The cerebellum may have many functions unknown to us. Its connections with other parts of the nerve-centers are numerous, though their significance is in great part unknown. Both pathological and physiological investigation point to its having a large share in muscular co-ordination.

It is certain that the cerebrum is the part of the brain essential for all the higher psychic manifestations in the most advanced mammals and in man.

The preponderating development of man's cerebrum explains at once his domination in the animal world, his power

over the inanimate forces of Nature and his peculiar infirmities, tendencies to a certain class of diseases, etc.—in a word, man is man, largely by virtue of the size and peculiarities of this part of his brain.

Modern research has made it clear also that there is a “projection” of sensory and motor phenomena in the cerebral cortex; in other words, that there are sensory and motor centers in the sense that in the cortex there are certain cells which have an important share in the initiation of motor impulses, and others employed in the final elaboration of sensory ones.

It is even yet premature to dogmatize in regard to the site of these centers; especially are we not ready for large generalizations. In man the convolutions around the fissure of Rolando constitute the motor area best determined.

The whole subject of cortical localization requires much additional study, especially by the comparative method in the widest sense—i. e., by a comparison of the results of operative procedure in a variety of groups of animals, and the results of clinical, pathological, physiological, and psychological investigation. Especially must allowance be made for differences to be observed, both for the group and the individual; and also for the influence which one region exerts over another. Between the weight of the cerebrum, the extent of its cortical surface, and psychic power, there is a general relationship.

GENERAL REMARKS ON THE SENSES.

Our studies in embryology have taught us that all the various forms of end-organs are developed from the epiblast, and

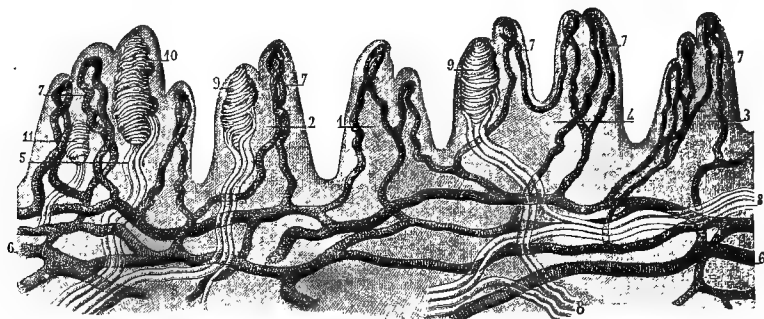

FIG. 398.—Papillæ of skin of palm of hand (after Sappey). A vascular network in all cases, and in some nerves and tactile corpuscles, enter the papillæ.

so may be regarded as modified epithelial cells, with which are associated a vascular and nervous supply. These end-organs are at once protective to the delicate nerves which terminate in them, and serve to convey to the latter peculiar impressions which are widely different in most instances from those resulting from the direct contact of the nerve with the foreign body. All are acquainted with the fact that, when

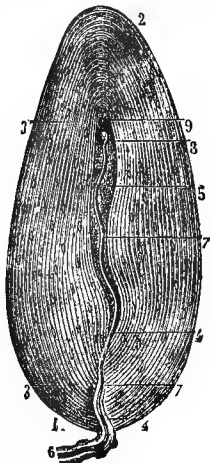
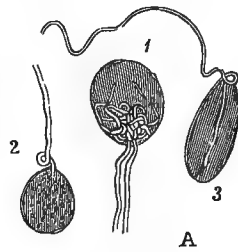
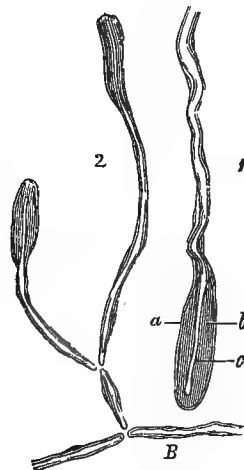

FIG. 399.

FIG. 399.—Corpuscle of Vater (after Sappey).



A



B

FIG. 400.

FIG. 400.—End-bulbs (corpuscles) of Krause (after Ludden). A, from conjunctiva of man; B, from conjunctiva of calf. It may be noticed that in all these cases the nerve loses its non-essential parts before entering the corpuscle.

the epithelium is removed, as by a blister, we no longer possess tactile sensibility of the usual kind, and experience pain on contact with objects; in a word, the series of connections necessary to a sense-perception is broken at the commencement.

Seeing that all the end-organs on the surface of the body have a common origin morphologically, it would be reasonable to expect that the senses would have much in common, especially when these organs are all alike connected with central nervous cells by nerves. As a matter of fact, such is the case, and in every instance we can distinguish between sensory impulses generated in the end-organ, conveyed by a nerve inward, and those in the cells of these central nervous systems, giving

rise to certain molecular changes which enable the mind or the *ego* to have a perception proper; which, when taken in connection with numerous past experiences of this and other senses, furnishes the material for a sensory judgment.

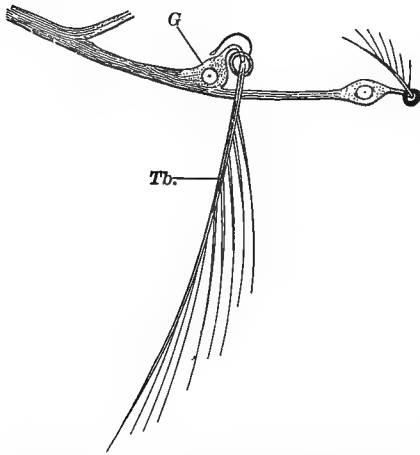

FIG. 401.—Nerves with ganglion cells (*G*) beneath a tactile bristle (*Tb*), from skin of an arthropod (*Corethra*) larva.

The chief events are, after all, internal, and hence it is found that the higher in the scale the animal ranks, the more developed its nervous centers, especially its brain, and the more it is able to capitalize its sensory impulses; also the greater the degree of possible improvement by experience, a difference well seen in blind men whose ability to succeed in life

without vision is largely in proportion to their innate and acquired mental powers. Inasmuch as all cells require rest, one would expect that under constant stimulation fatigue would soon result and perceptions be imperfect. Hence it happens that all the senses fail when exercised, even for but a short period, without change of stimulus leading to alteration of condition in the central cells. The change need not be one of entire rest, but merely a new form of exercise. Hence the freshness experienced by a change of view on passing through beautiful scenery.

Exhaustion may not be confined wholly to the central nerve-cells, but there can be little doubt that they are the most affected. Since also there must be a certain momentum, so to speak, to molecular activity, it is not surprising that we find that the sensation outlasts the stimulus for a brief period; and this applies to all the senses, and necessarily determines the rapidity with which the successive stimuli may follow each other without causing a blending of the sensations.

Thus, then, in every sense we must recognize (1) an end-organ in which the chain of processes begins; (2) a conducting nerve through which (3) the central nerve-cells are affected; and we may speak, therefore, of (1) sensory impulses and (2)

sensations, when these give rise to affections of the central nervous cells resulting in (1) perceptions and (2) judgments, when we take into account the psychic processes; and, from the nature of cell-life generally, we must recognize a certain intensity of the stimulus necessary to arouse a sensation and a limit within which alone we have power to discriminate (range of stimulation and perception); and also a limit to the rapidity with which stimuli may succeed each other to any advantage, so as to give rise to new sensations; and a limit to the endurance of the apparatus in good working condition corresponding to clear mental perceptions, together with the value of past experience in the interpretation of our sensations.

THE SKIN AS AN ORGAN OF SENSE.

Bearing in mind that all the sensory organs originate in the ectoderm, we find in the skin even of the highest animals the power to give the central nervous system such sense-impressions as bear a relation to the original undifferentiated sensations of lower forms as derived from the general surface of the body, but with less of specialization than is met with in the sense of hearing and vision; so that it is possible to understand how it is that the skin must be regarded not only as the original source of sensory impulses for the animal kingdom, but why it still remains perhaps the most important source of information in regard to the external world, and the condition of our own bodies; for it must be remembered that the data afforded for sensory judgments by all the other senses must be interpreted in the light of information supplied by the skin. We really perceive by the eye only retinal images. The distance, position, shape, etc., of objects are largely determined by feeling them, and thus associating with a certain visual sensation others derived from the skin and the muscles, which latter are, however, generally also associated with tactile sensations.

It is recorded of those blind from birth that, when restored to sight by surgical operations, they find themselves quite unable to interpret their visual sensations; or, in other words, seeing they do not understand, but must learn by the other senses, especially tactile sensibility, what is the real nature of the objects that form images on their retinae. All objects seen appear to be against the eyes, and any idea of distance is out of the question.

In man special forms of end-organs are found scattered over the skin, mucous and serous surfaces of the body, such as Pacinian corpuscles, touch-corpuscles, end-bulbs, etc. ; while in lower forms of vertebrates many others are found in parts where sensibility is acute. There seems to be little doubt that these are all concerned with the various sensory impulses that originate in the parts where they are found, but it is not possible at present to assign definitely to each form its specific function.

It has been contended that the various specific sensations of taste, as bitter, sweet, etc., are the result of impulses conveyed to the central nervous system by fibers that have this function, and no other ; and a like view has been maintained for those different sensations that originate from the skin. For such a doctrine there is a certain amount of support from experiment as well as analogy ; but the more closely the subject is investigated the more it appears that the complexity of our sensations is scarcely to be explained in so simple a way as many of these theories would lead us to believe. Whether there are nerve-fibers, with functions so specific, must be regarded as at least not yet demonstrated.

Let us now examine into the facts. What are the different sensations, the origin of which must be in the first instance sought in the skin, as the impulses aroused in some form of end-organ or nerve-termination ?

Suppose that one blindfolded lays his left hand and arm on a table, and a piece of iron be placed on the palm of his hand, he may be said to be conscious of the nature of the surface, whether rough or smooth, of the form, of the size, of the weight, and of the temperature of the body ; in other words, the subject of the experiment has sensations of pressure, of tactile sensibility, and of temperature at least, if not also to some extent of muscular sensibility. But if the right hand be used to feel the object its form and surface characters can be much better appreciated ; while, if the body be poised in the hand, a judgment as to its weight can be formed with much greater accuracy. The reason of the former is to be sought in the fact that the finger-tips are relatively very sensitive in man, and that from experience the mind has the better learned to interpret the sensory impulses originating in this quarter ; which again resolves itself into the particular condition of the central nerve-cells associated with the nerve-fibers that convey inward the impulses from those regions of the skin. **Mani-**

festly if there be a sense referable to the muscles (muscular sense) at all, when they are contracted at will the impression must be clearer than when they but feebly respond to the mere pressure of some body.

It is possible, as every one knows, to attend only to the data afforded by one set of impulses, such as those associated with our sensations of weight, temperature, etc., but such requires special attention; and as in the case of the eye we consider the object as a whole, its color, form, size, and other qualities, so does the mind form its complete conception by a synthesis or union of a variety of sensory data. Regarding the skin as a whole, we may speak of the skin-sense as we do of the ocular sense or vision. The separate treatment of tactile, thermal, and other forms of sensibility under separate headings is a matter of convenience; but there is considerable danger that we overlook the great fundamental fact that our knowledge of objects is primarily synthetic and not analytic. True, in disease, when one or more sets of the data of sense as derived from the skin is wanting, the others can be appreciated, and these alone. Nevertheless, such is an abnormal condition, and in that case the outer world passes to a large extent beyond the degree of control natural to man.

Pathological.—It does happen in certain forms of disease, notably of the spinal cord, that tactile sensibility is retained and thermal lost, or the muscular sense impaired. Such persons are plainly reduced at once to the condition, not only of being without certain sensory impressions, but in consequence unable to use others which they do possess to the same extent as before. A man with that affection of the spinal cord known as locomotor ataxy may have tactile and thermal sensibility, yet be unable to use these, in the absence of the muscular sense to enable him to be his own master, except when he calls in the help of his eyes, as, e. g., in walking.

It is thus seen how all the various sources of information from the skin and muscles blend psychically to produce a conception which, as a whole, corresponds to "seeing." The defects just referred to are in a measure comparable to color-blindness.

With this warning we shall now attempt to state some of the main facts in regard to the different functions of the skin as a sensory organ, especially endeavoring to trace parallel laws for this and the other senses.

PRESSURE SENSATIONS.

1. There is a relation between the intensity of the stimulus and the sensation resulting, and this limit is narrow. The greater the stimulus the more pronounced the sensation, though ordinary sensibility soon passes into pain. Weber's law (to be explained later) holds in the case of the skin as for other senses.

2. The duration of the sensation is very brief. It is said that a card in which holes have been punched, so that when in rotation it may bear on the skin, may be made to touch one of its holes against the finger as often as fifteen hundred times in a second before the sensations are fused.

3. The law of contrast may be illustrated by passing the finger up and down in a vessel containing mercury, when the pressure will be felt most distinctly at the point of contact of the fluid.

4. Pressure is much better estimated by some parts than others; hence the use of the tips of the fingers in counting the pulse, palpating tumors, etc.

THERMAL SENSATIONS.

1. The law of contrast is well illustrated by this sense; in fact, the temperature of a body exactly the same as that of the part of the skin applied to it can scarcely be estimated at all. The first plunge into a cold bath gives the impression that the water is much colder than it seems in a few seconds after, when the temperature has in reality changed but little; or, perhaps, the subject may be better illustrated by dipping one hand into warmer and the other into colder water than that to be adjudged. The sample feels colder than it really is to the hand that has been in the warm water, and warmer than it is to the other.

2. The limit within which we can discriminate is at most small, and the nicest determinations are made within about 27° and 33° C.—i. e., not far from the normal temperature of the body.

3. Variations for the different parts of the skin are easily ascertained, though they do not always correspond to those most sensitive to changes in pressure. The cheeks, lips, and eyelids are very sensitive to pressure.

Recent investigations have revealed the fact that there are in the skin "pressure-spots," and "cold-spots" and "heat-spots"—i. e., the skin may be mapped out into very minute areas which give when touched a sensation of pressure different from that produced by the same stimulus in the intermediate regions: and in like manner are there areas which are sen-

sitive to warm and to cold bodies respectively, but not to both; and these do not correspond with the pressure-spots, nor to those that give rise when touched to the sensation of pain. These spots are not placed symmetrically on both sides of the same individual, nor on corresponding parts of different individuals. So much has been ascertained by experiment. It is believed by some of the investigators that these areas are connected with the nerve-centers by nerve-fibers devoted to conducting impulses corresponding to the sensations which have the beginning of their formation in the different kinds of spots. The latter, however, has not been demonstrated.

While there can be no doubt that these investigations have furnished additional facts of great importance, they can not be considered as making the whole subject of sensation by the skin perfectly clear. For example, how are we to explain why a cold body feels heavier than a warm one, as may easily be demonstrated to one's own satisfaction by placing a large coin cooled down to near the freezing-point on the forehead beside a warmer one? We think such facts are calculated to enforce the lesson which we have been endeavoring to impress, viz., that our sensations are never single (thermal, tactile, etc.), but are compound, one or the other element preponderating; and that all interpretations of sense must take into account this fact—and the very important one—that every sensory impression is interpreted in the light of our past experience, as well as that of the immediate present.

It has been shown, also, that the extent of the area of skin stimulated determines to a large degree the quality of the resulting sensation. Thus, the temperature of a fluid does not seem the same to a finger and the entire hand. This fact is not irreconcilable with the existence of the various kinds of thermal spots, referred to above, but it does re-enforce the view we are urging of the complexity of those sensations which seem to us to form simple wholes—as, indeed, they do—just as a piece of cloth may be made up of an unlimited number of *different* kinds of threads.

TACTILE SENSIBILITY.

As a matter of fact, one may learn, by using a pair of compasses, that the different parts of the surface of our bodies are not equally sensitive in the discrimination between the contact of bodies—i. e., the judgment formed as to whether at a given

instant the skin is being touched by one or two points is dependent on the part of the body with which the points are brought into contact.

The following table will make this clear, the numbers indicating the distance at which the two points of a pair of compasses must be apart in order that they shall not give rise to the judgment of one point of contact, but be recognized as two:

	Millimetres.
Tip of tongue.....	1'1
Palm of last phalanx of finger.....	2'2
Palm of second phalanx of finger.....	4'4
Tip of nose.....	6'6
Whitish part of lips.....	8'8
Back of second phalanx of finger.....	11'1
Skin over malar bone.....	15'4
Back of hand.....	29'8
Forearm.....	39'6
Sternum.....	44'0
Back.....	66'0

There seem to be areas of skin which give rise when pricked to the sensation of pain; but, whether we should distinguish between tactile and pressure sensation by reference to corresponding spots, does not yet seem clear.

Certain it is that exercise of these and all the senses greatly improves them, though it is likely that such advance must be referred rather to the central nerve-cells than to the peripheral mechanism. Careful comparison of blind and seeing children has shown that the blind, in forming their judgments, apparently from sensations derived through the skin, in reality use much collateral help, which is very variable and certainly widely different, according to the past experience and general intelligence of the individual.

We practically distinguish between a great many sensations that we can neither analyze nor describe, though the very variety of names suffices to show how much our interpretation of sense depends on past experience.

We are always able to define the part of our bodies touched, and with great accuracy, no doubt, owing to the simultaneous use in early months and years of our lives of vision and the senses resident in the skin.

There are, however, transient illusions of sense which illustrate the remark just made. If a small marble be placed be-

tween the radial side of one finger and the ulnar side of the other (Aristotle's experiment), the subject of the experiment being blindfolded, it will be judged as two marbles at first, though the tactile impression is soon corrected, especially if the eyes be opened. These surfaces of the fingers have not been accustomed to touch at the same time the one body, hence the illusion.

An impression made on the trunk of a nerve is referred to the peripheral distribution of that nerve in the skin; thus, if the elbow be dipped in a freezing mixture, the skin around the joint will experience the sensation of cold, but a feeling of pain will be referred to the distribution of the ulnar nerve in the hand and arm. The same principle is illustrated by the common experience of the effects of a blow over the ulnar nerve, the pain being referred to the peripheral distribution; also by the fact that pain in the stump of an amputated limb is thought to arise in the missing toes, etc. It is said that when skin transplanted from the forehead to the nose, to repair missing parts, is touched, the sensation is located in the original site of the skin (forehead). In all such facts we see how dependent are all our sensory judgments on our past experience, illustrating the very important truth, with its wide ramifications, that, in a physiological sense, as well as in many others, our past makes our own future and that of the race to a very large extent.

THE MUSCULAR SENSE.

Every one must be aware how difficult it is to regulate his movements when the limbs are cold or otherwise deadened in sensibility. We know too that, in judging of the muscular effort necessary to be put forth to accomplish a feat, as throwing a ball or lifting a weight, we judge by our past experience. It is ludicrous to witness the failure of an individual to take up a mass of metal which was mistaken for wood. In these facts we recognize that in the successful use of the muscles we are dependent, not alone on the sensations derived from the skin, but also from the muscles themselves. True, the muscles are not very sensitive to pain when cut; it does not, however, follow that they may not be sensitive to that different effect, their own contraction; whether the numerous Pacinian bodies around joints, or the end-organs of the nerves of muscles are directly concerned, is not determined.

Pathological.—The teaching of disease is plainly indicative of

the importance of sensations derived both from the skin and the muscles for co-ordination of muscular movements.

In locomotor ataxy, in which the power of muscular co-ordination is lost to a large extent, the lesions are in the posterior columns of the spinal cord, or the posterior roots of the nerves, or both, and these are the parts involved in the transmission of afferent impulses.

Whether the muscular sense also implies a central "neural" sense, or consciousness of the changes of central origin, associated with the execution of a movement as distinct from the impressions derived from the muscles, is a matter of dispute. But the student will be already prepared for our answer to this question. The evidence of experiment seems to point to a distinct source of information in the muscles. We would take along with this the additional data of sense afforded by the skin, the "sense of effort" and other factors, as stored past experience, which must be very variable for the individual, as any one may observe by watching the muscular efforts of others and himself.

Comparative.—The more closely the higher vertebrates are observed, the more convinced does one become that those sensory judgments, based upon the information derived from the skin and muscles, which they are constantly called upon to form are in extent, variety, and perfection scarcely if at all surpassed by those of man. Of course, a sensory judgment in man, with his excessive cerebral development, may by associations in his experience be worked up into elaborate judgments impossible to the brutes, but we now refer to the judgments of sense in themselves.

The lips, the ears, the vibrissæ or stiff hairs, especially about the lips, the nose, in some cases the paws, all afford delicate and extensive sensory data.

It is a remarkable fact that the most intelligent of the groups of animals have these sensory surfaces well developed, as witness the elephant with his wonderful trunk, the hand of the monkey, and the paws and vibrissæ of the cat and dog tribe.

On the other hand, the groups with hoofs are notably inferior in the mental scale. When we pass to the lower forms of invertebrates the appreciation of vibrations of the air or water in which they live, of its temperature, of its pressure, must be considerable to enable them to adapt themselves to a suitable environment

We have not spoken of sensations derived from the internal organs and surfaces. These are ill-defined, and we know them mostly either as a vague sense of comfort or discomfort, or as actual pain. We are quite unable to refer them at present to special forms of end-organs. They are valuable as reports and warnings of the animal's own condition.

After-impressions ("after-images") of all the senses referred to exist, mostly positive in nature—i. e., the sensation remains when the stimulus is withdrawn.

Synoptical.—The information derived from the skin in man and the other higher vertebrates relates to sensations of pressure, temperature, touch, and pain. The muscles also supply information of their condition. In how far these are referable to certain end-organs in the skin is uncertain. There are dermal areas that give rise to the sensations of heat, cold, pressure, and pain. Whether these are connected with nerve-fibers that convey no other forms of impulses than those thus arising is undetermined.

In all these senses the laws of contrast, duration of the impression, limit of discrimination, etc., hold.

The sensory judgments based on sensations derived from the skin are syntheses or the result of the blending of many component sensations simultaneous in origin. All our sensory judgments are very largely dependent on our past experience.

VISION.

Light and vision are to some degree correlatives of each other. Light is supposed to have as its physical basis the vibrations of an imponderable ether. Such is, however, to a non-seeing animal as good as non-existent, so that we may look at this subject either with the eyes of the physiologist or the physicist, according as we regard the cause of the effects or the latter and their relations to one another. It is, however, impossible to understand the physiology of vision without a sound knowledge of the anatomy of the eye, and an apprehension of at least some of the laws of the science of optics. The student is, therefore, recommended to learn practically the coarse and microscopic structure of the eye in detail. The eyes of mammals are sufficiently alike to make the dissection of any of them profitable. Bullocks' eyes are readily obtainable, and from their large size may be used to advantage. We recom-

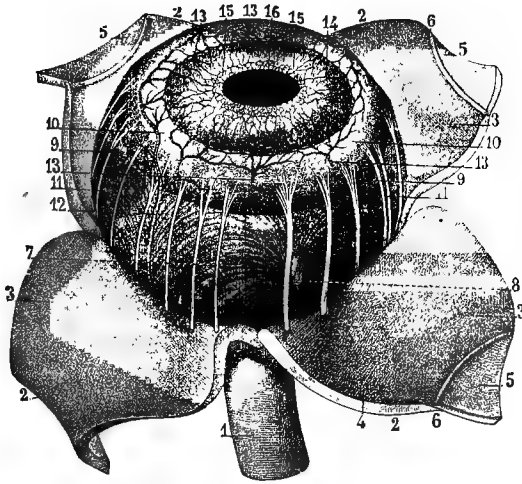
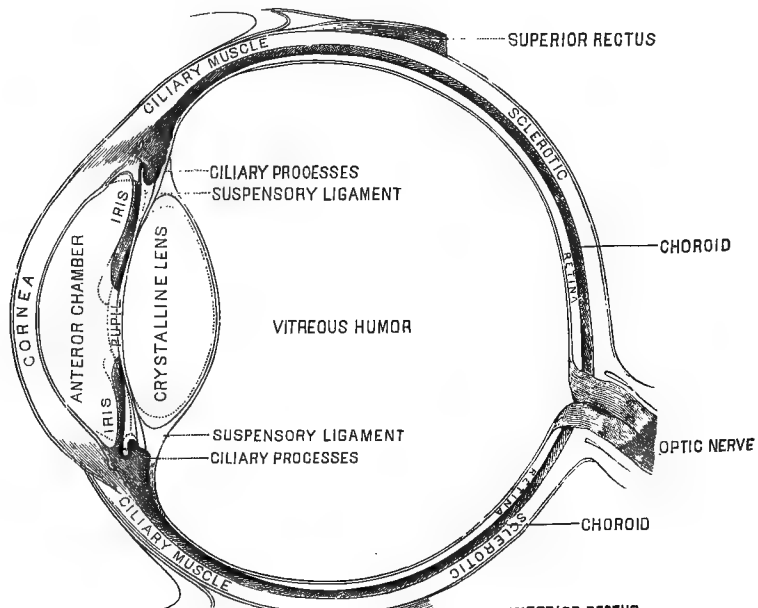

FIG. 402.—Eye partially dissected (after Sappey). 1, optic nerve; 2, 3, 4, sclerotic dissected back so as to uncover the choroid coat; 5, cornea, divided and folded back with sclerotic coat; 6, canal of Schlemm; 7, external surface of choroid, traversed by one of the long ciliary arteries and by ciliary nerves; 8, central vessel, into which the *vasa vorticosa* empty; 9, 10, choroid zone; 11, ciliary nerves; 12, long ciliary artery; 13, anterior ciliary arteries; 14, iris; 15, vascular circle of iris; 16, pupil.

mend one to be boiled hard, another to be frozen, and sections in different meridians to be made, especially one vertical longi-



tudinal section. Other specimens may be dissected with and without the use of water.

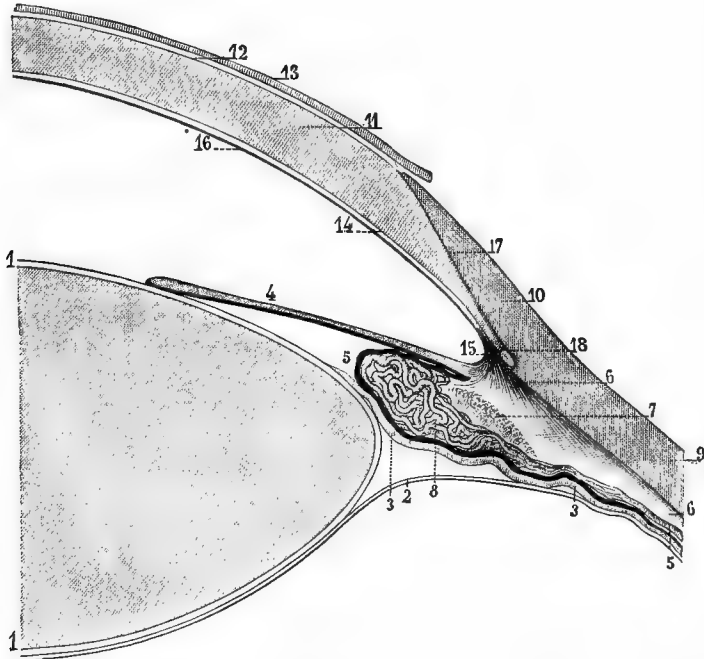

FIG. 404.—Certain parts of eye. 1×10 . (After Sappey.) 1, 1, crystalline lens; 2, hyaloid membrane; 3, zonule of Zinn; 4, iris; 5, a ciliary process; 6, radiating fibers of ciliary muscle; 7, section of circular portion of ciliary muscle; 8, venous plexus of ciliary muscle; 9, 10, sclerotic coat; 11, 12, cornea; 13, epithelial layer of cornea; 14, Descemet's membrane; 15, pectinate ligament of iris; 16, epithelium of membrane of Descemet; 17, union of sclerotic coat with cornea; 18, section of canal of Schlemm.

Assuming that some such work has been done, and that the student has become quite familiar with the general structure of the eye, we call attention specially to the strength of the sclerotic coat; the great vascularity of the choroid coat and its terminal ciliary processes, its pigmented character adapting it for the absorption of light; the complicated structure and protected position of the retinal expansion. It may be said that the whole eye exists for the retina, and that the entire mechanism besides is subordinated to the formation of images on this nervous expansion. The eye of the mammal may be regarded as an arrangement of refracting media, protected by coverings, with a window for the admission of light, a curtain regulating the quantity admitted; a sensitive screen on which the images are thrown; surfaces for the absorption of superfluous light;

apparatus for the protection of the eye as a whole, and for preserving exposed parts moist and clean.

Embryological.—We have already learned that the first indication of the eye is the formation of the optic vesicle, an outgrowth from the first cerebral vesicle. This optic vesicle becomes more contracted at the base, and the optic stalk remains as the optic nerve.

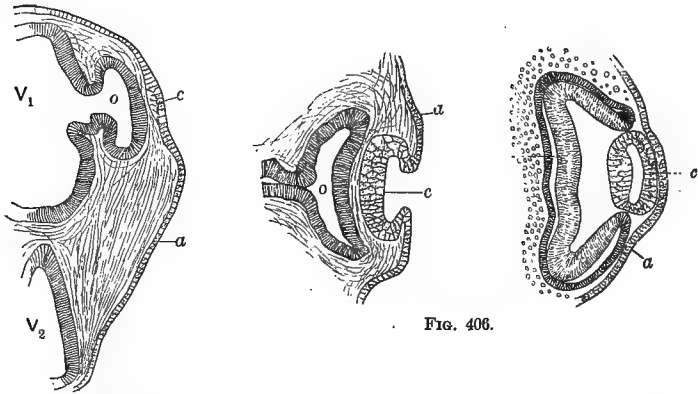

FIG. 405.

FIG. 405.—Section through head of chick on third day, showing origin of eye (after Yeo). *a*, epiblast undergoing thickening to form lens; *o*, optic vesicle; *V*₁, first cerebral vesicle; *V*₂, posterior cerebral vesicle. It will be observed that the retina is already distinctly indicated.

FIG. 406.—Later stages in development of eye (after Cardiat). *a*, epiblast; *c*, developing lens; *o*, optic vesicle.

At an early stage of development (second or third day in the chick) the outer portion of the optic vesicle is pushed inward, so that the cavity is almost obliterated; the anterior portion, becoming thickened, ultimately forms the retina proper, while the posterior is represented by the tessellated pigment layer of the choroid.

As this retinal portion breaks away from the superficial epithelium, the latter forms an elliptical mass of cells, the future lens, the changes of which in the formation of the cells peculiar to the lens illustrate to how great lengths differentiation in structure is carried in the development of a single organ. It will thus be seen that the most essential parts of the eye, the optic nerve, the retina, and the crystalline lens, are, according to a general law, the earliest marked out. The cornea, the iris, the choroid, the vascular supply, the sclerotic, etc., are all secondary in importance and in formation to these, and are derived from the mesoblast, while the essential structures are traceable,

Any act of perfect vision in a mammal may be shown to consist of the following: (1) The focusing of rays of light from

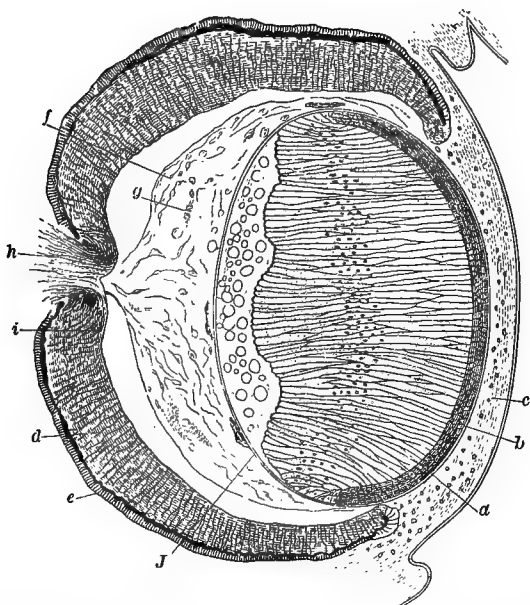

FIG. 407.—More advanced stage of development of eye (after Cardiat). *a*, epithelial cells forming lens, now much altered; *b*, lens capsule; *c*, cutaneous tissue about to form conjunctiva; *d*, *e*, two layers of optic vesicle, now folded back and forming retina; *f*, mucous tissue forming vitreous humors; *g*, intercellular substance; *h*, developing optic nerve; *i*, nerve-fibers entering retina.

an object on the retina, so as to form a well-defined image; (2) the conduction of the sensory impulses thus generated in the retina by the optic nerve inward to certain centers; and (3) the elaboration of these data in consciousness.

We thus have the formation of an image—a physical process; sensation, perception, and judgment—physiological and psychical processes.

In the natural order of things we must discuss first those arrangements which are concerned with the focusing of light—i. e., the formation of the image on the retinal screen.

DIOPTRICS OF VISION.

One of the most satisfactory methods of ascertaining that the eye does form images of the objects in the field of vision is to remove the eye of a recently killed albino rabbit. On

holding up before such an eye any small object, as a pair of forceps, it may be readily observed that an inverted image of the object is formed on the back of the eye (*fundus*). If, however, the lens be removed from such an eye, no image is formed. If the lens be itself held behind the object, an inverted image will be thrown upon a piece of paper held at a suitable (its focal) distance. By substituting an ordinary biconvex lens, the same effect follows. It thus appears, then, that the lens is the essential part of the refracting media, though the aqueous and vitreous humors and the cornea are also focusing mechanisms.

The surfaces of the refracting media may all be considered to be centered on *one of the axes*, which meets the retina above and to the inner side of the fovea centralis. We may for practical purposes reason from a diagrammatic eye, the refracting surfaces of which are (1) the anterior surface of the cornea, (2) the anterior surface of the lens, and (3) the posterior surface of the lens. The media may be reduced to (1) the lens substance and (2) the aqueous, or, as it has about the same refracting power, the vitreous humor.

By the *posterior principal focus* is meant the point at which all rays that fall on the cornea parallel to the optic axis are focused. It is 14.647 mm. behind the posterior surface of the lens, or 22.647 mm. behind the anterior surface of the cornea in

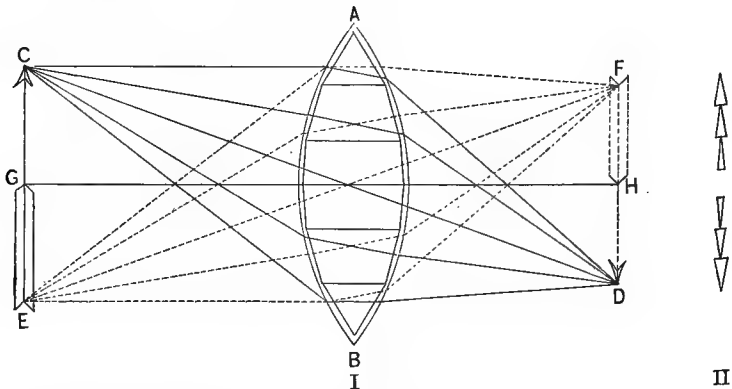

FIG. 408.—Refraction by convex lenses (after Flint and Weinhold). The lens may be assumed to consist of a series of lenses (II in figure), for the sake of simplicity, though of course this is not strictly accurate.

the diagrammatic eye. In the actual eye the fovea of the retina must occupy this position when at rest, if a distinct image is to be formed.

FIG. 409.—Diagrammatic eye, showing the eye as reduced to

the lens and the retina, and in many of the illustrations to follow this will be done. The experiments referred to above will convince the student that such is the case; and we may here state that, while the various principles involved in the physiology of vision may be illustrated in great perfection by elaborate experiments, we shall endeavor to supply the student with accounts of very simple methods of convincing himself by personal observation, such as may be readily *repeated* at a future time, which is more than can be said for those that involve expensive apparatus.

ACCOMMODATION OF THE EYE.

Using the material already referred to, the student may observe that, with the natural eye of the albino rabbit, its lens (or better that of a bullock's eye, being larger), or a biconvex lens of glass, there is only one position of the instruments and objects which will produce a perfectly distinct image. If either the eye (retina), the lens, or the object be shifted, instead of a distinct image, a blurred one, or simply *diffusion-circles*, appear.

A photographer must alter either the position of the object or the position of his lens when the focus is not perfect. The eye may be compared to a camera, and since the retina and lens can not change position, either the shape of the lens must change or the object assume a different position in space. As a matter of fact, any one may observe that he can not see objects *distinctly* within a certain limit of nearness to the eye, known as the *near point* (*punctum proximum*); while he becomes conscious of no effect referable to the eye until objects approach within about sixty-five to seventy yards. Beyond the latter distance objects are seen clearly without any effort. We thus learn that the range of accommodation lies between about five inches and sixty to seventy yards, though it is customary to speak of the far point as infinity (∞), which simply means that the rays from objects beyond the distance given above are practically parallel, and are, therefore, focused on the retina without any alteration in the shape of the lens (*negative accommodation*); while nearer ones require this. When objects are nearer to the eye than about five inches, for most persons, the eye can not accommodate sufficiently to bring the rays of light emanating from them to a focus on the retina.

There are many ways in which we may be led to realize these truths: 1. When one is reading a printed page it is only

the very few words to which the eyes are then specially directed that are seen clearly, the rest of the page appearing blurred; and the same holds for the objects in any small room. We speak of picking out an acquaintance in an audience or crowd, which implies that each of the individuals composing the throng is not distinctly seen at the same time. 2. If an observer hold up a finger before his eyes, and direct his gaze into the distance (relax his accommodation), presently he will behold a second shadowy finger beside the real one—i. e., he sees double: his eyes, being accommodated for the distant objects, can not adapt themselves at the same time for near ones. 3. The principle involved may be most precisely illustrated by Schein-

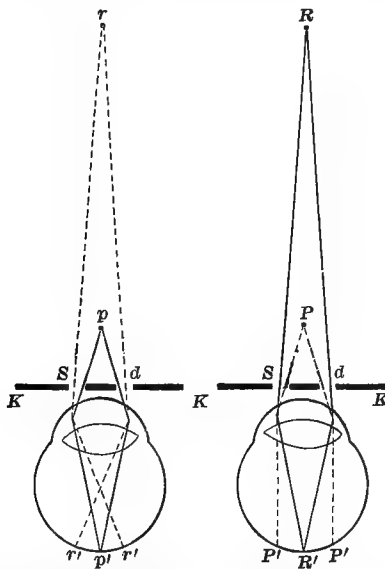

FIG. 409.—Diagram to illustrate Scheiner's experiment (after Landois). The dotted lines indicate the circumstances under which there is double vision.

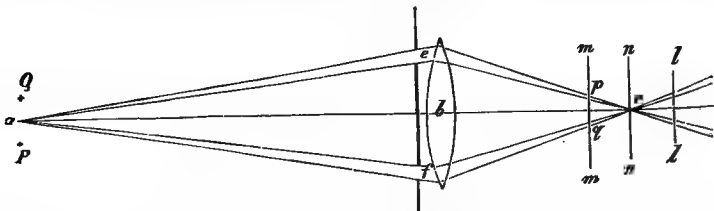

FIG. 410.—To explain Scheiner's experiment (after Bernstein). The object is at *a*; the lens is represented by *b*; and the retina may be at *m, n, n,* or *l, l*. The card with its holes, *e, f*, is directly in front of the lens. It is plain that, if the rays strike the retina in any way except as represented at *c*, double images must be formed. One or other of these will disappear according as the right or left hole of the card is stopped; which of them will depend on circumstances—i. e., as to whether the case is that figured at *m, m* or *l, l*.

er's experiments (Figs. 409 and 410). Let two small holes be pricked in a card, at a distance from each other not greater than the diameter of the pupil; fix the card upright on a piece of board, about two feet long, and, closing one eye, observe the effect of looking at two pins stuck into the board in line with each other, at different distances apart. It may be observed that as soon as the nearest pin is approximated to the card within a certain distance it fails to be distinctly seen, and appears double—i. e., the near point is exceeded; that when the distant pin is in focus, the near one appears double, and *vice versa*. When the image is double, blocking one of the two holes causes one image to disappear, and this is the right or the left hand image, according as the one or the other hole is stopped, and as it is the distant or near pin that is seen as two. The reason of this will be plain from the above figures, but it must be remembered that an image on the right of the retina is adjudged to be on the left of the visual field, as will be explained later.

In what does accommodation consist? If light from a candle or lamp be allowed to fall obliquely on the eye of a second person, through a card on which two triangular holes have been cut one above the other, three pairs of images of the flame (necessarily triangular) may be seen reflected from the eye of the observed subject, two of which are erect and one inverted; the brightest and most distinct being from the cornea, the second pair dimmer and larger from the anterior surface of the lens, and the smallest (*c*) from the posterior surface of the lens, inverted, since it is produced by a concave mirror. When the subject of the observation looks at a near object, only one of these pairs of images alters appreciably, viz., that from the anterior surface of the lens, the middle pair (*b*). The conclusion then follows that accommodation consists essentially in an alteration of

the convexity of the anterior surface of the lens. The images appear nearer to each other the more convex the lens becomes. Without the help of a special instrument (*phakoscope*) the observer may fail to see the change, though that the other pairs do *not* alter position or size he may certainly readily observe.

This change in the shape of the lens is accomplished as

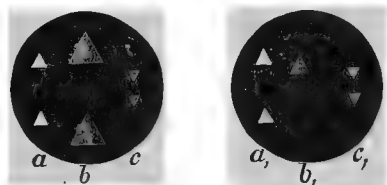

FIG. 411.—Purkinje's images. *a b c* during negative, *a, b, c*, during positive accommodation (after Landolt).

follows: The lens is naturally very elastic and is kept in a partially compressed condition by its capsule, to which is attached the suspensory ligament which has a posterior attachment to the choroid and ciliary processes. When the ciliary muscle,

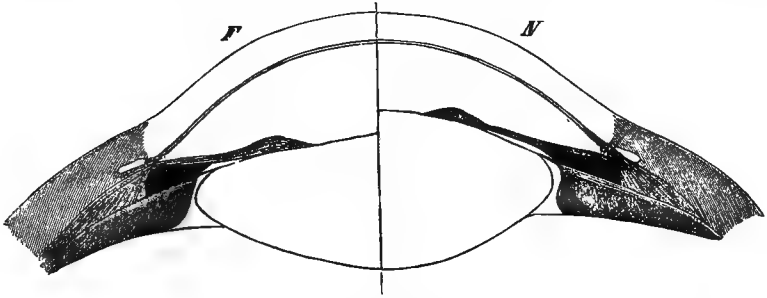

FIG. 412.—Illustrates mechanism of accommodation (after Fick). The left side depicts the relation of parts during the passive condition of the eye (negative accommodation, or accommodation for long distances); the right side, that for near objects.

which operates from a fixed point the corneo-sclerotic junction, pulls upon the choroid, etc., it relaxes the suspensory ligament; hence the lens, not being pressed upon in front as it is from behind by the vitreous humor (invested by its hyaloid membrane), is free to bulge and so increase its refractive power. The nearer an object approaches the eye, the greater the divergence of the rays of light proceeding from it, and hence the necessity for greater focusing power in the lens.

If a person be observed closely when looking from a remote to a near object, it may be noticed that the eyes turn inward—i. e., the visual axes converge and the pupils contract. These are not, however, essential in the sense in which the changes in the lens are; for, as before stated, in the absence of the lens distinct vision is quite impossible. Were additional evidence necessary to show that accommodation is effected as described, it might be stated that by stimulation of the lenticular ganglion the ciliary muscle may in an animal thus experimented upon be shown to contract, the choroid to be drawn forward, and the anterior convexity of the lens to be increased. Vasomotor changes or alterations in the size of the iris, if they have any effect upon the lens at all, must play a very unimportant part. The movements of the iris do, however, serve an important purpose, and to that subject we now turn.

ALTERATIONS IN THE SIZE OF THE PUPIL.

The pupil varies in size according as the iris is in a greater or less degree active. All observers are agreed that the circular fibers around the pupillary margin are muscular, forming the so-called sphincter of the iris; but great differences of opinion still exist in regard to the radiating fibers. It is thought by many that all the changes in the iris may be explained by the elasticity of its structure without assuming the existence of muscular fibers other than those of the sphincter; thus a contraction of the latter would result in diminution of the pupillary aperture, its relaxation to an enlargement, provided the rest of the iris were highly elastic.

The conclusions in regard to the innervation of the iris rest largely upon the results of certain experiments which we shall

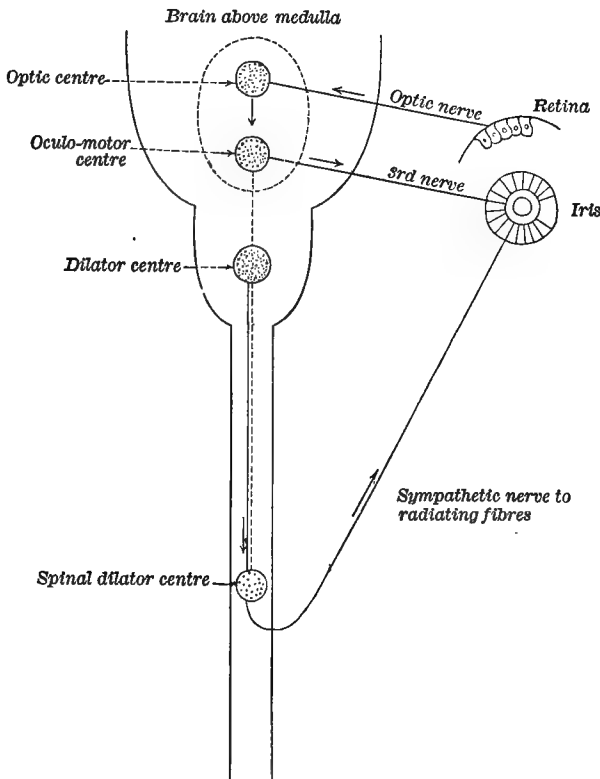

FIG. 413.—Diagram to illustrate innervation of the iris. Dotted lines indicate general functional connection (correlation). Course of impulses indicated by arrows.

now briefly detail: 1. When the third nerve is divided, stimulation of the optic nerve (or retina) does not cause contraction of the pupil as usual. 2. When the optic nerve is divided, light no longer causes a contraction of the pupil, though stimulation of the third nerve or its center in the anterior portion of the floor of the aqueduct of Sylvius does bring about this result. 3. Section of the cervical sympathetic is followed by contraction and stimulation of its peripheral end by dilation of the pupil.

From such experiments it has been concluded that—1. The optic is the afferent nerve and the third nerve the efferent nerve concerned in the contraction of the pupil; and that the center in the brain is situated as indicated above, so that the act is ordinarily a reflex. 2. That the cervical sympathetic is the path of the efferent impulses regulating the action of the radiating fibers of the iris.

Its center has been located near that for the contraction of the pupil, and it may be assumed to exert a tonic action over the iris comparable to that of the vaso-motor center over the blood-vessels.

The impulses may be traced through the cervical sympathetic and its ganglia back to the first thoracic ganglion, and thence to the spinal cord and brain. There may be subsidiary centers in the cervical spinal cord.

There are facts which it is difficult to explain in the above manner. Thus, when atropin is dropped into the eye, the dilatation is greater than that which follows section of the optic nerve or the third nerve. In such a case, paralysis of the contracting mechanism, by which the dilating mechanism is left free to act, should produce, we might suppose, the greatest possible dilation of the pupil, especially if we assume, as some do, that there are no radiating muscular fibers, but that all the effects are produced through the sphincter of the iris; but such is not the case. The result has been set down to the action of the drug upon a local nervous mechanism, or the muscular fibers themselves, or to the vaso-motor changes said to be coincident. This view is strengthened by the fact that stimulation of the retina in a recently removed eye will cause some reflex contraction of the pupil. In explaining the action of drugs on the pupil we are not limited to either a purely local or a purely central influence; some seem to act in one stage more upon the centers, in another more locally. Vaso-motor influences undoubtedly do affect the size of the pupil, full vessels

tending to contraction and the reverse to dilation. Upon the whole, it seems best to regard the two mechanisms as supplementary to one another, so that usually with increased action of the one there is diminished action of the other. We find that the two eyes move in harmony, and that the two pupils in health are always of the same size. Light thrown upon one eye contracts the pupil of the other. We are thus led to believe in associated or consensual movement of the iris, owing to nervous connections between the various centers involved. These are physiological, but whether anatomical or not, in the sense that annectant fibers exist, is uncertain; and, however, in the evolution of function, they may have been at first produced, have been so strengthened, according to the law of habit, that now it is with the greatest difficulty that one may learn to move one eye independently of the other, or modify the form of the pupils without also shifting the visual axes.

It is to be remembered that, although the dilating center is automatic in action, it may also act reflexly, or be modified by unusual afferent impulses—as, e. g., the strong stimulation of any sensory nerve which causes enlargement of the pupil through inhibition of the center. To render the paths of impulses affecting the iris somewhat clearer, it is well to bear in mind the nervous supply of the part: 1. The third nerve, through the ciliary (ophthalmic, lenticular) ganglion, supplies short ciliary nerves to the iris, ciliary muscle, and choroid. 2. The cervical sympathetic reaches the iris chiefly through the long ciliary nerves and the ophthalmic division of the fifth. 3. There are sensory fibers from the fifth nerve; and, according to some observers, also dilating fibers from this nerve independent of the sympathetic, as well as those that may reach the eye by the long ciliary nerves without entering the ciliary ganglion. 4. The centers from which both the contracting and dilating impulses proceed are situated near to each other in the floor of the aqueduct of Sylvius. It is of practical importance to remember the various circumstances under which the pupil contracts and dilates.

Contraction (Myosis).—1. Access of strong light to the retina. 2. Associated contraction on accommodation for near objects. 3. Similar associated contraction when the visual axes converge, as in accommodation for near objects. 4. Reflex stimulation of afferent nerves, as the nasal or ophthalmic division of the fifth nerve. 5. During sleep. 6. Upon stimulation of the optic or the third nerve, and the corpora quadrigemina

or adjacent parts of the brain. 7. Under the effects of certain drugs, as physostigmin, morphia, etc.

Dilation (Mydriasis).—1. In darkness. 2. On stimulation of the cervical sympathetic. 3. During asphyxia or dyspnoea. 4. By painful sensations from irritation of peripheral parts. 5. From the action of certain drugs, as atropin, etc. The student may impress most of these facts upon his mind by making the necessary observations, which can be readily done.

Pathological.—As showing the importance of such connections, we may instance the fact that, in certain forms of nervous disease (e. g., locomotor ataxia), the pupil contracts when the eye is accommodated to near objects, but not to light (the Argyll-Robertson pupil). In other cases, owing to brain-disease, the pupils may be constantly dilated or the reverse; or one may be dilated and the other contracted.

OPTICAL IMPERFECTIONS OF THE EYE.

The defects to be noticed now are common to all human eyes, and probably to the eyes of all mammals, though in some persons certain of them, as astigmatism, are of so serious a character that they require special remedies.

Spherical Aberration.—The nature of this defect may be best learned from an examination of Fig. 414, below. It will be seen that rays of light passing through the lens are brought to

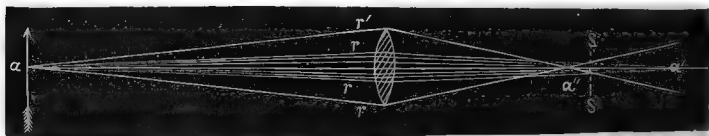

FIG. 414.—Illustrating spherical aberration (after Le Conte). The best image is formed at *S, S'*, but is not perfectly sharply defined even here.

a focus, varying with the point of the lens through which they pass, the focusing power of any ordinary convex lens being greater toward the circumference. This defect is believed to be corrected in the human eye, at least to some extent, by the following:

1. The iris cuts off the more strongly refracted outer rays.
2. The corneal curvature is rather ellipsoidal, so that those rays farthest from the optical axis are least deviated by it.
3. The anterior and posterior curvatures of the lens are corrective of each other.
4. The power of refraction of the lens

does not increase regularly from the center to the circumference.

Astigmatism.—In this defect the vertical meridian is supposed to be more convex than the horizontal, as is partially the case with the cornea of the eye, and it is to this body that astigmatism is usually referable, rather than to the lens, though the latter may also be defective.

In astigmatism, when a vertical line is in focus a horizontal can not be distinctly seen, and the reverse. This any one may readily demonstrate to himself by drawing one straight line at right angles to the center of another and looking at the figure; when the one is seen distinctly, the other is blurred. It is to be borne in mind that, in order to see a horizontal line distinctly, it is of most importance that the rays that diverge from this line, in a series of vertical planes, be well focused, rather than those which diverge in the plane of the line itself; so that, when the cornea is most curved in the vertical meridian, a horizontal line will be represented by an image of a horizontal line at the nearer focus—i. e., when the vertical is the most convex meridian, horizontal lines are soonest focused, and this holds, in fact, of most eyes.

When the astigmatism affects several meridians, “irregular astigmatism” results.

The defect in question is to be corrected by glasses made of sections of a cylinder, thickest in the region corresponding to that of greatest corneal, etc., defect.

Chromatic Aberration.—In the figure below, in which $h h$ represents the lens, it will be seen that the violet and red rays have different foci, so that, when the eye is accommodated for the one set of rays, the others are seen indistinctly. Assuming

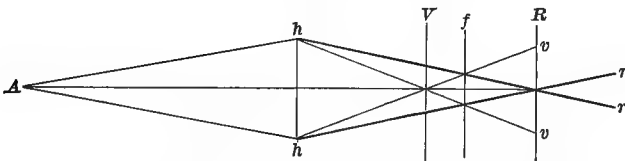

FIG. 415.—Diagram to illustrate chromatic aberration (after Foster).

that the retina is at f , the rays will be blended; but if between V and f , or f and R , the blue center will have a red circumference, and the reverse respectively.

As the focal distances for near objects differs so little usually, this defect is not observed by us; but it may be made ob-

vious by looking at a flame through cobalt-blue glass, which allows only the red and blue rays to pass: the flame may appear red surrounded by blue or blue surrounded by red, according to the character of the accommodation of the eye at the time. Since the eye has to be accommodated for violet (see Fig. 415) more than blue, bodies of equal size, red in color, always appear nearer than violet ones. Hence, also, it is difficult to see the red and violet of the spectrum with equal distinctness at the same time.

Entoptic Phenomena.—Opaque bodies in any of the media of the eye may cast shadows on the retina.

When movable, as they often are in the vitreous humor, they are known as *muscæ volitantes*, from their fancied resemblance to gnats.

One looking through a microscope is apt at first to see what does not exist, apart from his own eye, owing to various forms of the nature now referred to, but which may be distinguished from real objects by the inability to fix them in the field of vision, for as soon as the attempt is made they vanish.

Tears on the cornea and other inequalities from foreign bodies, pressure, etc., likewise give rise to such phenomena.

An interesting little experiment, which illustrates both the alterations in size of one's own pupils with the amount of light, and at the same time irregularities in their margins, if they exist, may be thus carried out: Let a pin-hole be pricked in a card, and, holding this close to the eye, look at a light or a bright surface. On opening and closing the other eye the changes in the size of the pupil of the first eye may be seen to alter with the amount of light admitted to the second—i. e., the field of view is alternately diminished and increased.

Anomalies of Refraction.—1. We may speak of an eye in which the refractive power is such that, under the limitations referred to before (page 564), images are focused on the retina, as the *emmetropic* eye. The latter is illustrated by Fig. 416. In the upper figure, in which the eye is represented as passive (negatively accommodated), parallel rays—i. e., rays from objects distant more than about seventy yards (according to some writers much less)—are focused on the retina; but those from objects near at hand, the rays from which are divergent, are focused behind the retina. In the lower figure the lens is represented as more bulging, from accommodation, as such divergent rays are properly focused.

2. In the *myopic* (near-sighted) eye the parallel rays cross

within the vitreous humor, and diffusion-circles being formed on the retina, the image of the object is necessarily blurred,

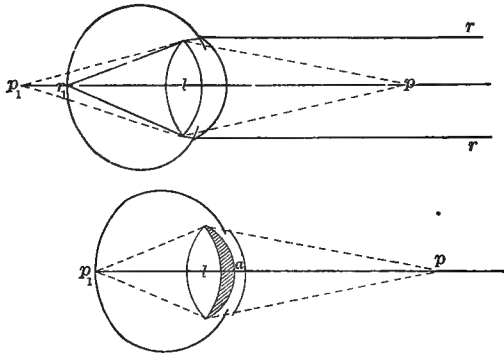

FIG. 416.—Diagrams to illustrate conditions of refraction in normal eye when unaccommodated (passive, or negatively accommodated), and when accommodated for "near" objects (after Landois).

so that an object must, in the case of such an eye, be brought unusually near, in order to be seen distinctly—i. e. the *near*

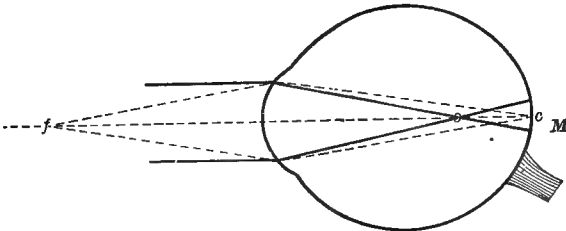

FIG. 417.—Anomalies of refraction in a myopic eye (after Landois).

point is abnormally near and the *far point* also, for parallel rays can not be focused; so that objects must be near enough for the rays from them that enter the eye to be divergent.

The myopic eye is usually a long eye, and, though the mechanism of accommodation may be normal, it is not so usually, the ciliary muscle being frequently defective in some of its fibers, which may be either hypertrophied or atrophied, or with some affected one way and others in the opposite. Moreover, there is also generally, in bad cases, "spasm of accommodation" (i. e., of the ciliary muscle), with increased ocular tension, etc. The remedies are, rest of the accommodation mechanism and the use of concave glasses.

3. The opposite defect is hypermetropia. The *hypermetropic*

eye (Fig. 418), being too short, parallel rays are focused behind the retina; hence no distinct image of distant objects can

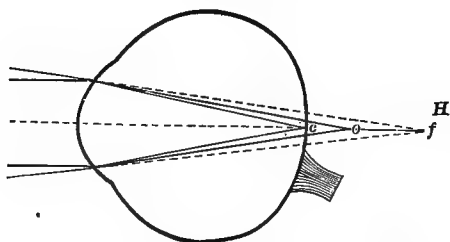

FIG. 418.—Anomalies of refraction in the hypermetropic eye (after Landois).

be formed, and they can only be seen clearly by the use of convex glasses, except by the strongest efforts at accommodation. When the eye is passive, no objects are seen distinctly beyond a certain distance—i. e., the *near point* is abnormally distant (eight to eighty inches). The defect is to be remedied by the use of convex glasses.

4. Presbyopia, resulting from the *presbyopic* eye of the old, is owing to defective focusing power, partly from diminished elasticity (and hence flattening) of the lens, but chiefly, probably, to weakness of the ciliary muscle, so that the changes required in the shape of the lens, that near objects may be distinctly seen, can not be made. The obvious remedy is to aid the weakened refractive power by convex glasses. It is practically important to bear in mind that, as soon as any of these defects in refractive power (though the same remark applies to all ocular abnormalities) are recognized, the remedy should be at once applied, otherwise complications that may be to a large extent irremediable may ensue.

VISUAL SENSATIONS.

We have thus far considered merely what takes place in the eye itself or the physical causes of vision, without reference to those nervous changes which are essential to the perception of an object. It is true that an image of the object is formed on the retina, but it would be a very crude conception of nervous processes, indeed, to assume that anything resembling that image were formed on the cells of the brain, not to speak of the superposition of images inconsistent with that clear memory of objects we retain. Before an object is "seen," not only

must there be a clear image formed on the retina, but impulses generated in that nerve expansion must be conducted to the brain, and rouse in certain cells there peculiar molecular conditions, upon which the perception finally depends.

For the sake of clearness, we may speak of the changes effected in the retina as *sensory impressions* or impulses, which, when completed by corresponding changes in the brain, develop into *sensations*, which are represented psychically by *perceptions*; hence, though all these have a natural connection, they may for the moment be considered separately. It is as yet beyond our power to explain how they are related to each other except in the most general way, and the manner in which a mental perception grows out of a physical alteration in the molecules of the brain is at present entirely beyond human comprehension.

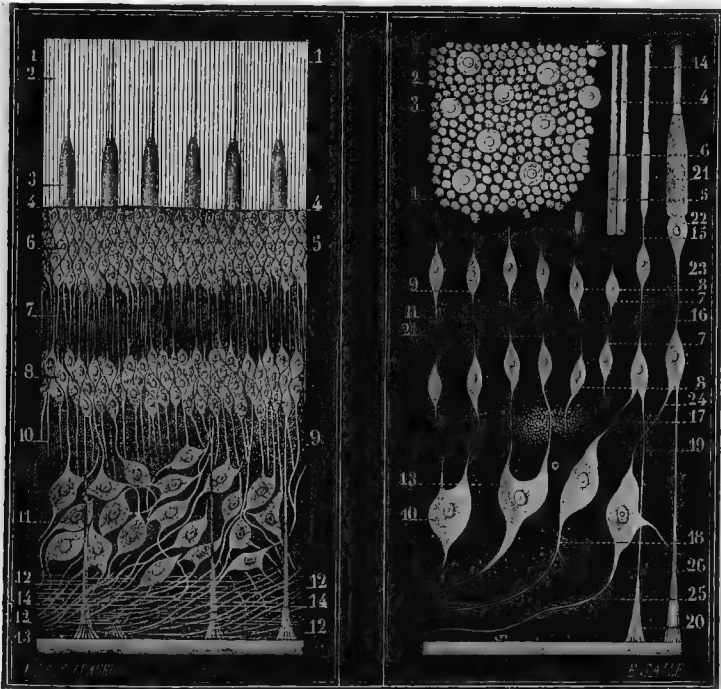

FIG. 419.

FIG. 420.

FIG. 419.—Vertical section of retina (after H. Müller). 1, layer of rods and cones; 2, rods; 3, cones; 4, 5, 6, external granule layer; 7, internal granule layer; 9, 10, finely granular gray layer; 11, layer of nerve-cells; 12, 14, fibers of optic nerve; 13, membrana limitans. FIG. 420.—Connection of rods and cones of retina with nervous elements (after Sappey). 1, 2, 3, rods and cones seen from in front; 4, 5, 6, side view. The rest will be clear from the preceding figure.

Affections of the Retina.—There is no doubt that the fibers of the optic nerves can not of themselves be directly affected by light. This may be experimentally demonstrated to one's self by a variety of methods, of which the following are readily carried out: 1. Look at the circle (Fig. 421) on the left hand with the



FIG. 421 (after Bernstein).

right eye, the left being closed, and, with the page about twelve to fifteen inches distant, gradually approximate it to the eye, when suddenly the cross will disappear, its image at that distance having fallen on the *blind-spot*, or the point of entrance of the optic nerve. 2. Fixing the eye as before on a mark on a sheet of white paper made by a pen, draw the latter outward till its point disappears from view. Mark the location of the pen-point when this occurs, and continue the movement till it again appears. Mark this point also. This process may be continued in other directions besides the horizontal, and, by joining these points, an irregular outline is formed, marking off a portion of the "visual field," within which there is really no vision. 3. A small image from a flame projected on the blind-spot by a mirror is not visible, though readily perceived when it falls on the retina proper.

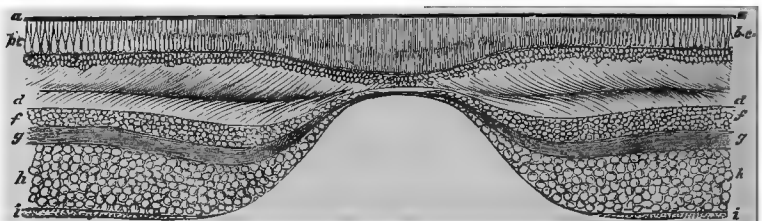

FIG. 422.—Diagrammatic section of macula lutea (after Huxley). *a, a*, pigment of choroid; *b, c*, rods and cones; *d, d'*, outer granular or nuclear layer; *f, f'*, inner granular layer; *g, g'*, molecular layer; *h, h'*, layer of nerve-cells; *i, i'*, fibers of optic nerve.

It remains, then, to determine what part of the retina is affected by light. The evidence that it is the layers of rods

and cones is convincing. If it could be shown that parts of the retina itself internal to these layers cast *perceptible* shadows, the conclusion that the rods and cones are the essential parts of the sensory organ would be inevitable. The following experiment proves this: When a light is moved backward and forward (to prevent retinal fatigue) before the eye, so that the rays from it enter the organ, while the subject, standing in a dark room, gazes toward a plain-colored wall, his accommodation being relaxed, he will behold radiating shadows, somewhat suggestive of the leafless branches of an old tree. These correspond with the picture of the retinal vessels as ascertained by an examination of the eye with the ophthalmoscope. Some persons always see the shadows of the blood-corpuses also; and, in fact, one physiologist has, by observing these, calculated the rate of the blood-flow in the retinal vessels. Instead of

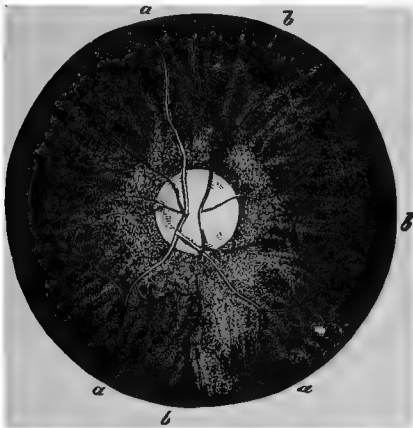

FIG. 423.

FIG. 423.—Ophthalmoscopic picture of *fundus oculi*, showing the generally red ground (dark in figure), on which may be distinguished the point of entrance of optic nerve, in the region of which the prominent vessels may be seen to arise (after Bernstein).

FIG. 424.—Diagram to explain experiment to get Purkinje's figures. In this case the light passes through the lens, an image is formed on the retina, and the light is reflected from this image to another part of the retina, at which, being less illuminated, the shadows of the retinal vessels are more readily perceived. Thus, suppose the candle to be held at *a*, its image will be formed at *b* and reflected to *c*, at which point shadows appear and are projected into the visual field at *d*. By moving the candle to *a'*, we get new relative positions for image, vessels, etc. (after Bernstein).

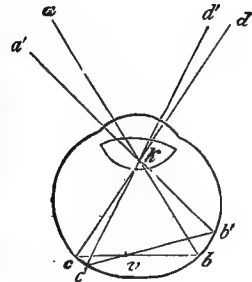

FIG. 424.

moving the light to and fro, it may be concentrated for a few seconds by a lens with the same result—the appearance of *Purkinje's figures*, as they are termed. When the light is moved, they shift place correspondingly. If the sensory parts were not situated behind the retinal vessels, it is impossible to conceive how their shadows could be seen, and certain mathe-

mathematical calculations, based on data derived from the experiment just described, locate the part concerned in the layer of rods and cones. Putting together all the facts of experiment with those derived from pathological conditions, there seems to be no reasonable doubt that the rods and cones of the retina are the seat of origin of the visual impulses.

The performance of the experiment as given above requires usually two persons, but there are simpler methods, which, in some cases, also bring out the figures more satisfactorily: (1) It often suffices to move the head back and forward before the tube of a microscope without its objective; or (2) to move rapidly a card with a pin-hole held close before the eye, while the subject gazes at a bright clear sky. When the card is moved from side to side, the vertical vessels are seen; if up and down, the horizontal. The shadows of the capillaries come out especially well by this method. It is essential, however, whatever plan be adopted, to gaze into infinite distance, as it were, in order fully to relax the accommodation and to avoid excessive expectancy, which frustrates the former attempts at relaxation.

The Nature of the Processes which originate Visual Impulses.—

Much interest attached at one time to *visual purple* (rhodopsin), because it was hoped that it might furnish a chemical explanation of vision. It was found that in certain animals, as frogs, when kept in darkness, the visual purple was renewed after having been bleached out by exposure to light; indeed an exact "optogram," or picture of an object, might be made and by appropriate reagents fixed on the retina as a bleached part of the visual purple.

This substance is found exclusively in the outer limbs of the rods and not at all in the cones; but, since the retinas of some animals (snakes) are destitute of rods, and visual purple is also wanting in the macula lutea and fovea centralis of man and the apes, the points of greatest retinal sensibility, it is manifest that the theory based upon its presence breaks down as an explanation of vision, if to be applied universally; besides, the retinas of some animals with rods (dove, hen, bat) are entirely devoid of visual purple.

But, though this particular method of application of chemistry to the explanation of the origin of retinal impulses has failed, it does not follow that a chemical theory as such is false, though it must be admitted that the evidence is as yet very incomplete on which to found such an explanation.

But when we consider the evolution of the eye, and examine

into the facts of comparative anatomy and physiology, there are many of a significance that we can not ignore; the importance of light to most protoplasmic processes, such as the accumulation of pigment in certain regions marking the very beginnings of eyes; the large amount of pigment found in the eyes of most groups of animals and of nearly all mammals suggesting that this is a provision for the retention of light, which we can scarcely conceive as acting in other than a chemical manner. At the same time, in keeping with the spirit of this work throughout, we suggest caution in believing that explanations based on our limited experience are the only ones possible.

It is worth while to bear in mind, however, that currents of rest and currents of action similar to those demonstrated to exist in muscle, glands, nerves, etc., may be shown to exist in the retina. In all the other cases these are in intensity parallel to the degree of functional (and chemical) activity of the part, and it makes the probability of there being a chemistry of the retina as a foundation for the impulses therein generated greater. The subject is as yet, however, in the region rather of speculation than of ascertained fact.

The Laws of Retinal Stimulation.—It may be noticed that, when a circular saw in a mill is rotated with extreme rapidity, it seems to be at rest.

If a stick on fire at one end be rapidly moved about, there seems to be a continuous fiery circle.

If a top painted in sections with various colors be spun, the different colors can not be distinguished, but there is a color resulting from the blending of the sensations from them all, which will be white if the spectral colors be employed.

When, on a dark night, a moving animal is illuminated by a flash of lightning, it seems to be at rest, though the attitude is one we know to be appropriate for it during locomotion.

It becomes necessary to explain these and similar phenomena. Another observation or two will furnish the data for the solution.

If on awakening in the morning, when the eyes have been well rested and the retina is therefore not so readily fatigued, one looks at the window for a few seconds and then closes the eyes, he may perceive that the picture still remains visible as a *positive after-image*; while, if a light be gazed upon at night and the eyes suddenly closed, an after-image of the light may be observed.

It thus appears, then, that the impression or sensation out-

lasts the stimulus in these cases, and this is the explanation into which all the above-mentioned facts fit. When the fiery point passing before the eyes in the case of the fire-brand stimulates the same parts of the retina more frequently than is consistent with the time required for the previous impression to fade, there is, of necessity, a continuous sensation, which is interpreted by the mind as referable to one object. In like manner, in the case of a moving object seen by an electric flash, the duration of the latter is so brief that the object illuminated can not make any appreciable change of position while it lasts; a second flash would show an alteration, another part of the retina being stimulated, or the original impression having faded, etc.

In the case of a top or (better seen) color-disk, painted into black and white sectors, it may be observed that with a faint light the different colors cease to appear distinct with a slower rotation than when a bright light is used. The variation is between about $\frac{1}{10}$ and $\frac{1}{20}$ of a second, according to the intensity of the light used. Fusion is also readier with some colors than others.

It is a remarkable fact that one can distinguish as readily between the quantity of light emanating from 10 and 11 candles as between 100 and 110. Weber's law is a highly generalized form of this statement applicable to all the senses.

But with vision, as with all the senses, a lower and especially an upper limit is soon reached, within which alone we can discriminate. It is not possible to distinguish between the difference in brightness of the central and the circumferential parts of the sun, though it is known that the actual difference is very great, while it is easy enough to recognize a marked difference in the light of a room when two candles are used instead of one. Within certain limits we can appreciate a difference in illuminating power of about $\frac{1}{100}$ of a given total.

The Visual Angle.—If two points be marked out with ink on a sheet of white paper, so close together that they can be just distinguished as two at the distance of 12 to 20 inches, then on removing them a little farther away they seem to merge into one.

The principle involved may be stated thus: When the distance between two points is such that they subtend a less visual angle than 60 seconds, they cease to be distinguished as two. Fig. 425 illustrates the visual angle. It will be noticed that a larger object at a greater distance subtends the same visual angle as a smaller one much nearer. The size of the retinal

image corresponding to 60 seconds is $.004$ mm. (4μ), and this is about the diameter of a single rod or cone. It is not, how-

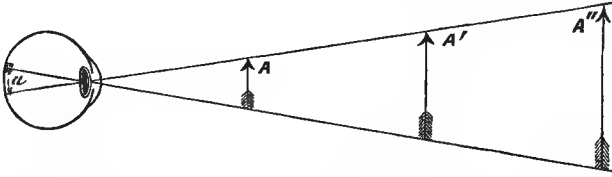

FIG. 425.—The visual angle. The object at A'' appears no larger than the one at A (Le Conte).

ever, true that when two cones are stimulated two objects are inferred to exist in every case by the mind; for the retina varies in different parts very greatly in general sensibility and in sensibility to color.

It is noticeable that visual discriminative power can be greatly improved by culture, a remark which applies especially to colors. It seems altogether probable that the change is central in the nerve-cells of the part or parts of the brain concerned, especially of the cortical region, where the cell processes involved in vision are finally completed.

Color-Sensations.—As this subject is still in a very unsettled condition, it will be well in discussing it to keep the facts of physiology and of physics distinct from each other and from the theories proposed to account for them.

It is rare to see in nature the pure colors of the spectrum; more frequently the reds, blues, etc., we behold are the corresponding colors of the spectrum, with the addition of a variable quantity of white light. In the spectrum itself there is an unlimited number of shades, not usually specially noticed, intermediate between the main colors.

Hence we may regard a color as dependent on (1) the wavelength of its constituent rays; (2) on the quantity of the particular light falling on the retina; and (3) on the quantity of white light mixed with this. When no white light at all enters, the color is said to be saturated, such being heavy and æsthetically unattractive; when much of such light, bright, etc. A gray results from a certain mixture of white with black; the browns by fusion of red, yellow, white, and black. But in this and all other instances in which we speak of "fusion," "blending," "mixture," etc., we refer to *physiological* blending owing to contemporaneous stimulation by light of different wavelengths. Thus, orange results from the action of the red and yellow rays at the same time, and can not be produced by any

mixture of the wave-lengths of red and yellow. Again, certain colors known as *complementary* by psychic fusion gave rise to white, though no physical mixture of such colored pigments will produce white. These are red and blue-green; orange and blue; yellow and indigo-blue; green-yellow and violet.

Now, when a child beholds orange, he has not the faintest idea that it is related to red, or that white can be in any way produced from any combination of colors, any more than, when he hears a perfect musical chord, has he any idea of its being produced by the simultaneous production of its component notes. To him both the colors and the chord are independent facts. But by simple experiments their origin may be illustrated.

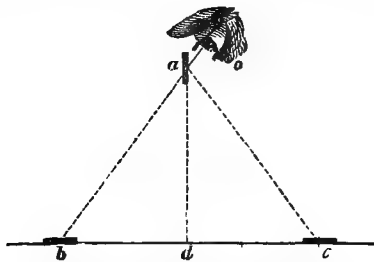

FIG. 426.—Lambert's experiment. The wafers are at *b* and *c*; the eye at *a*; and the vertical glass plate at *a* (after Bernstein):

As regards complementary colors, Lambert's experiment may easily be performed: Place a red wafer (or a slip of paper) on a sheet of white paper, and about three inches behind it a blue one. Hold a plate of glass between the two and vertically, so that while gazing at the red wafer through it a reflected image of the blue one

will be thrown into the eye in the same direction as that of the red image, the result being a sensation of purple.

As before referred to, a rotating disk on which all the colors of the spectrum are represented in equal subdivisions, when the speed is sufficiently great, appears white from the fusion of the sensations. Of course, instead of all the colors, complementary ones suffice. As a matter of fact, we may recognize six fundamental colors—white, black, red, yellow, green, and blue—and these may be the outcome of the physiological mixture of three "standard" sensations.

We now proceed to matters of speculation. At the present day two theories to account for color-vision monopolize attention: 1. The Young-Helmholtz theory assumes that there are only three primary sensations, or, in other words, that the retina is affected only by rays of light corresponding to red, green, and violet (or blue); and the manner in which any color is produced (in the mind) will appear from an examination of Fig. 427. Thus, when red is the color seen, though the retinal

stimulation is not confined solely to the rays of the red end of the spectrum, it is chiefly by these that what we may call psychic red is produced—i. e., the mental perception of red is dependent on a specific stimulation of the retina by rays of a certain wave-length, though at the same time there is a feebler sensation of green and violet. Orange would in like manner

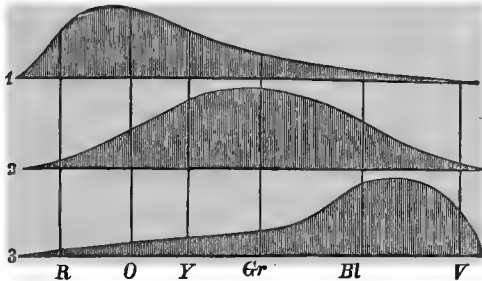

FIG. 427.—Illustrates the Young-Helmholtz theory of color-vision. The letters in the lower line indicate colors of spectrum in natural order. 1. denotes the "red"; 2, "green"; 3, "violet" primary-color sensation. The diagram shows by the height of the curve in each instance to what extent the primary-color sensations are respectively excited by vibrations of different wave-lengths (after Bernstein).

result from a large admixture of red, considerable of green, and very little of violet. 2. Hering's theory is a chemical one. He assumes the existence of three kinds of visual substances: white-black, yellow-blue, red-green. Either in the retina or elsewhere in the eye it is believed that two processes are in constant operation, the opposite of each other, and which correspond to the changes assumed to take place in protoplasm generally, and to which we have referred already as anabolism and katabolism, or construction (assimilation) and destruction (dissimilation). When dissimilation is in excess, the lighter colors result—white, yellow, red; and the others when assimilation prevails. Orange would be seen when red and yellow are simultaneously produced—i. e., when the red-green and yellow-blue substances both undergo dissimilation to a degree in excess of its opposite phase.

One test of these theories would be their application to explain the defect next to be mentioned.

Color-Blindness.—There are all degrees of this defect, from such as exists in every eye—i. e., inability to perceive color equally well by all parts of the retina, to complete loss of the faculty of discriminating color at all.

1. *Complete color-blindness* (achromatopsy) is marked by inability to distinguish any colors, the spectrum being brightest

in the middle, but any picture appears as a photograph. It may be unilateral.

2. *Yellow-Blue Blindness*.—The spectrum presents only red and green, and hence is usually much shortened. It is occasionally unilateral.

3. *Red-Green Blindness (Daltonism)*.—Yellow and blue may be discriminated, violet and blue seem alike, and red and green practically do not exist.

It is to be borne in mind that it is very difficult to ascertain the exact condition of color-blind persons, from their inability to communicate their state of mind. They often make discriminations apparently based on color distinctions, but, in reality, on the form, texture, position, etc., of objects. It is also all but impossible to be precisely certain as to the extent to which the lower animals can distinguish between colors.

To apply the above theories of color-vision to the explanation of color-blindness: In the case of red-green blindness, according to the Young-Helmholtz explanation, there is the absence of one of the primary sensations (red), so that the colors seen are the result of mixtures of the other two primary sensations. What we call yellow must be to the subject of this defect a bright green. According to Hering's theory such persons lack the red-green substance; hence their color-vision must be limited to mixtures of yellow and blue alone. But, if blindness to red and green can exist separately, as has been asserted, this theory fails to explain it, though the former would; while total color-blindness is explicable by Hering's theory, but not by the rival one. It is probable that neither is broad enough to meet the facts, even if correct in principle. They serve the end of being provisional hypotheses till better are found.

PSYCHOLOGICAL ASPECTS OF VISION.

It is impossible to ignore entirely, in treating of the physiology of the senses, the mind, or perceiving *ego*.

By virtue of our mental constitution, we refer what we "see" to the external world, though it is plain that all that we perceive is made up of certain sensations.

We recognize the "visual field" as that part of the outer world within which alone our vision can act at any one time; and this is, of course, smaller for one than for both eyes.

If one takes a large sheet of paper and marks on its center a spot on which one or both eyes are fixed, by moving a point

up or down, to the right or the left, he may ascertain the limits of the visual field for a plane surface. The visual field for both eyes measures about 180° in the horizontal meridian; for one eye about 145° ; and in the vertical meridian 100° .

Imperfections of Visual Perceptions.—We may now consider some defects which we know to exist by the use of our reasoning powers in the mental perception we form of objects in the visual field:

1. *Irradiation.*—It is easy to notice that a white spot on a dark ground appears larger than a dark spot of equal size on a white ground. This has been spoken of as the result of

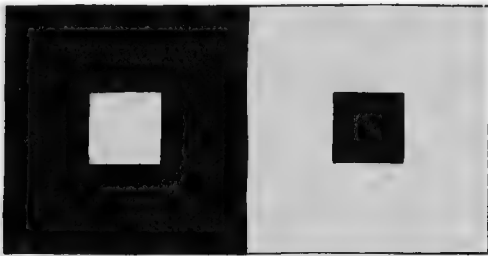

FIG. 428.—Illustrates irradiation. The white patch in the dark ground seems larger than the dark one in the light ground (after Bernstein).

irradiation—a sort of overflow of sensation, though whether to be referred to the retina or to the brain-areas concerned is uncertain.

2. *Contrast.*—When a white strip of paper is laid between two black ones, the center of the white strip is not so bright as its edges, from contrast; and experiments illustrating the same principle may be made with colored paper. This law of contrast is very wide in its application, and will be referred to later.

3. *The Blind-Spot.*—It might be supposed at first that one should perceive gaps in the field of vision on account of the blind-spot; but, when it is remembered that to see black we must have a definite sensation, and that the mind places objects lying on opposite sides of the spot close together, the reason that this defect in structure, if such it really be, is practically inoperative, becomes clearer. It is to be remembered that the image of an object (see Fig. 432) never falls on the blind-spot in both eyes; and, moreover, this area lies outside of that of greatest acuteness (*macula lutea*), on which images are focused.

The *macula lutea*, and especially the *fovea centralis*, are the

parts of the retina most sensitive to both form and color; or, to put it otherwise, when the retina is stimulated by an object, whether colored or not, the mind perceives, becomes most readily cognizant of the sensation, sees the object best, when the stimulation is confined to the yellow spot; and, as will be learned still more fully later, all the arrangements for vision are directed toward the focusing of the rays of light that emanate from objects, so that the image may fall on this region of the retina.

In like manner, by looking directly forward, and having some one move an object in space as before, and noting when it ceases to be visible, an irregular figure of the field, within which vision is distinct in varying degrees, and beyond which it is absolutely non-existent, may be mapped out.

By using colored objects, as small squares of paper, by the above method, it may be readily learned that the field for some colors is much more restricted than for others; in fact, as such an object is moved outward, its color seems to change: thus, purple becomes bluish. In all retinas there is more or less color-blindness toward the peripheral parts, and this is especially true of red. The field for the colors of the spectrum, etc., may easily be shown to be more limited than for white.

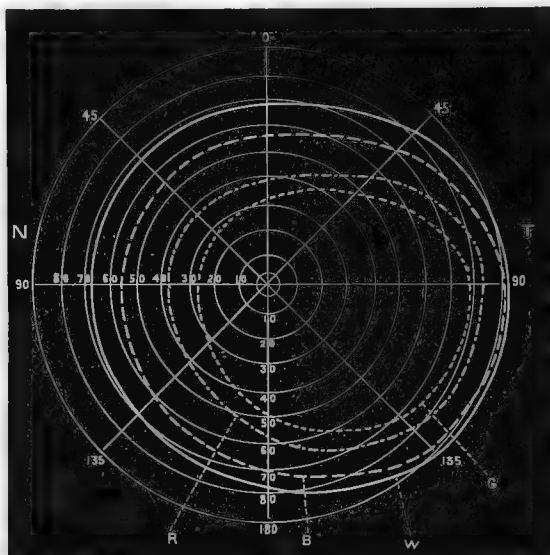

FIG. 429.—Field of color-vision of right eye, as projected by the subject on the inner surface of a hemisphere, the pole of which forms the point of fixation for the eye: semi-diagrammatic (after Nettleship and Landolt). T, temporal side; N, nasal side; w, boundary for white; b, for blue; r, for red; g, for green.

Influence of the Pigment of the Macula Lutea.—If we interpose a solution of chrome alum between the eye and a white cloud while the general field is purplish, a rosy patch appears in a position corresponding to the yellow spot. This is owing to the fact that the solution allows only the red and greenish-blue rays to pass, and, the latter being absorbed by the yellow spot, we see only the former in the part of the field of vision corresponding to this area. The experiment is also an excellent one to mark out the site of the spot. Since the macula lutea is the part of the retina concerned in the usual so-called "direct" vision, it will be evident that what would be yellow but for the influence of the pigment of this spot appears to us white.

After-Images, etc.—Positive after-images have already been referred to; but an entirely different result, owing to exhaustion of the retina, may follow when the eye is turned from the object. If, after gazing some seconds at the sun, one turns away or merely closes the eyes, he may see black suns. In like manner, when one turns to a gray surface after keeping the eyes fixed on a black spot on a white ground, he will see a light spot. Such are termed *negative* after-images, and these may themselves be colored, as when one turns from a red to a white surface and sees the latter green. They may be explained upon either theory of color-vision. According to the theory of Young and Helmholtz, in the latter case the green appears because the primary color-sensation for red is exhausted, while the others become more prominent accordingly; but it is more difficult to explain the black suns, etc., by this theory, though it is, of course, open to suppose that all the primary color-sensations have been exhausted.

According to Hering's theory, the dark after-images as well as the colored ones are the result of the preponderance of one or the other of the two processes of assimilation and dissimilation. But, in truth, the subject is very difficult of complete solution at all by the *kind* of explanations we are at present employing.

It is of some importance to remember that the retina is not equally sensitive to all colors. We see the blues of evening more readily than the reds or yellows, hence the employment of the former extensively by artists in depicting evening scenes.

Since there is a maximum point of stimulation for each main color, it is possible to understand how, by increase of the inten-

sity of its light, one color passes into another: e. g., let violet light be gradually increased in intensity, and the retina soon fails to perceive this color so strongly; but the red and green sensations being as yet submaximal, we perceive a color the result of the blending of these two with violet, and so on till we may get such a mixture of the sensations of violet, red, and green as produces white.

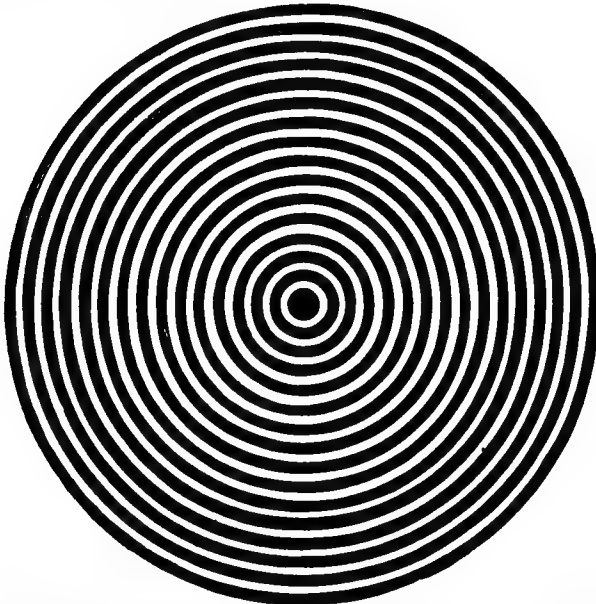

FIG. 430.—When looked at with one eye, the lines are never all distinct at one time; this is in part owing to astigmatism, but in part also to inability to accommodate perfectly apart from any defect of this kind for more than a very limited area. When viewed with both eyes, a number of curious phenomena may be observed, the explanation of which we leave the student to work out for himself (after Bernstein).

Misconceptions as to the Comparative Size, etc., of Objects.—A glance at Figs. 430 and 431 will illustrate some surprising peculiarities. On a clear day distant mountains appear nearer,

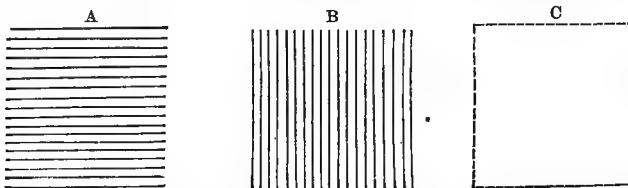

FIG. 431.—Illustrates illusions as to size. In A the height seems at first greater than the breadth, though they are equal: the reverse in B; while C appears to cover a less area than either of the others (after Bernstein).

from being seen better. The full moon looks larger when near the horizon than when overhead, from the absence of objects in the latter case with which to compare it; and in like manner distances on the water or on a vast plain seem less than they really are; and so in innumerable instances the influence of a standard of comparison or its absence is evident.

Subjective Phenomena.—When the eyelids are shut in a dark room, the eye does not seem absolutely devoid of light. Such sensation of luminosity as may be feebly present is sometimes spoken of as the “proper light of the retina.” When the ball of the eye is pressed upon, colored circles of light appear when the eyes are closed, such being plainly due to mechanical stimulation of the retina. These are “phosphenes,” and are akin to the stars seen when the eye receives a sudden blow, or to the sensations excited by electrical stimulation. But, apart from any stimulation of the retina, objects may apparently be seen in excited conditions of the brain, as in insanity, delirium tremens, etc. Sometimes one object, instead of being recognized, seems to arouse the perception of another. The cause is traceable in many cases solely to the brain itself, especially the part of the cerebral cortex concerned in vision, and illustrates the importance of this part of the central visual mechanism, and much more into which we can not enter now.

CO-ORDINATION OF THE TWO EYES IN VISION.

As a matter of fact, we are aware that an object may be seen as one either with a single eye or with both. For *binocular* vision it may be shown that the images formed on the two retinas must fall invariably on *corresponding* points.

The position of the latter may be gathered from Fig. 432. It will be noticed that the *malar* side of one eye corresponds to the *nasal* side of the other, though upper always an-

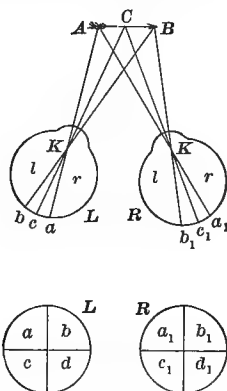

FIG. 432.—Diagram to illustrate corresponding points (after Foster). *L*, *R*, left and right eyes; *a*, *b*, *c*, are points in one eye corresponding to *a*₁, *b*₁, *c*₁, in the other. The lower figures are projections of the retina of the right (*R*) and the left (*L*) eye. It may be observed that the malar side of one retina corresponds to the nasal side of the other.

swers to upper and lower to lower. This may also be made evident if two saucers (representing the fundus of each eye) be laid over each other and marked off, as in the figure.

That such corresponding points do actually exist may be shown by turning one eye so that the image shall not fall, as indicated in the figure. Only now and then, however, is a person to be found who can voluntarily accomplish this; but it occurs in all kinds of natural or induced squint, as in alcoholism, owing to partial paralysis of some of the ocular muscles. We are thus naturally led to consider the action of these muscles.

Ocular Movements.—Upon observing the movements of an individual's eyes, the head being kept stationary, it may be noticed that (1) both eyes may converge; (2) one diverge and the other turn inward; (3) both move upward or downward;

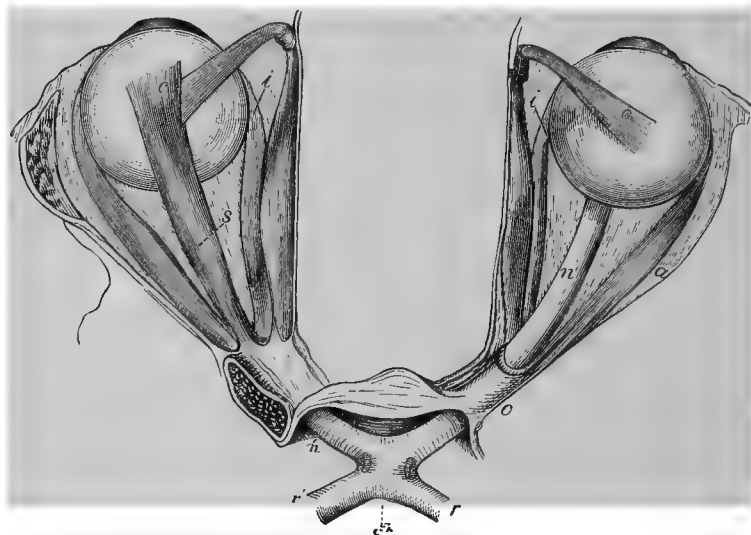

FIG. 433.—View of the two eyes and related parts (after Helmholtz).

(4) these movements may be accompanied by a certain degree of rotation of the eyeball.

The eye can not be rotated around a horizontal axis without combining this movement with others. To accomplish the above movements it is obvious that certain muscles of the six with which the eye is provided must work in harmony, both as to the direction and degree of the movement—i. e., the movements of the eyes are affected by very nice muscular co-ordinations.

We may speak of that position of the eye when, with the head vertical in the standing position, the distant horizon is viewed as the *primary* position and all others as *secondary* positions.

Fig. 434 is meant to illustrate diagrammatically the movements of the eyeball.

While the several recti muscles elevate or depress the eye, and turn it inward or outward, and the oblique muscles rotate it, the movements produced by the superior and inferior recti are always corrected by the assistance of the oblique muscles, since the former tend of themselves to turn the eye somewhat inward. In like manner the oblique muscles are corrected by the recti. The following tabular statement will express the conditions of muscular contraction for the various movements of the eye:

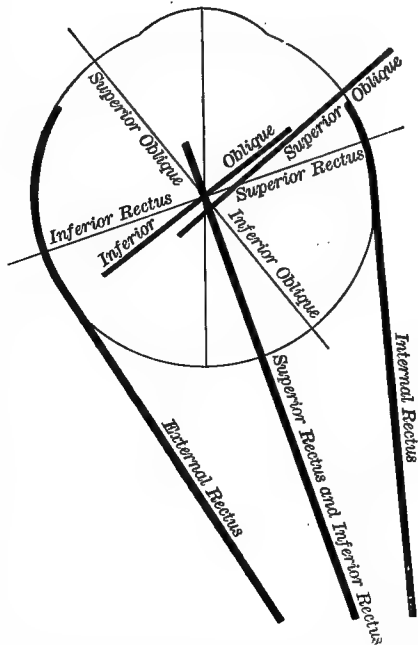

FIG. 434.—Diagram intended to illustrate action of extrinsic ocular muscles (after Fick). The heavy lines represent the muscles of the eyeball, and the fine lines the axes of movement.

Straight movements.	{	Elevation.....	Rectus superior and obliquus inferior.
		Depression....	Rectus inferior and obliquus superior.
		Adduction to nasal side..	Rectus internus.
		Adduction to malar side..	Rectus externus.
Oblique movements.	{	Elevation with adduction..	Rectus superior and internus, with obliquus inferior.
		Depression with adduction.	Rectus inferior and internus with obliquus superior.
		Elevation with abduction..	Rectus superior and externus with obliquus inferior.
		Depression with abduction.	Rectus inferior and externus, with obliquus superior.

What is the *nervous* mechanism by which these “associated” movements of the eyes are accomplished? It has been found, experimentally, that when different parts of the corpora quadrigemina are stimulated, certain movements of the eyes

follow. Thus, stimulation of the right side of the nates leads to movements of both eyes to the left, and the reverse when the opposite side is stimulated; also, stimulation in the middle line causes convergence and downward movement, etc., with the corresponding movements of the iris. Since section of the nates in the middle line leads to movements confined to the eye of the same side, the center would appear to be double. However, it may be that the cells actually concerned do not lie in the corpora quadrigemina, but below, or outside of them. The localization is as yet incomplete.

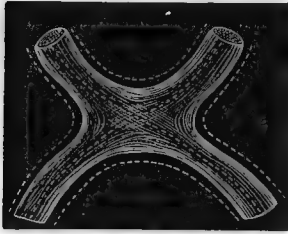

FIG. 435.—Diagram to illustrate decussation of fibers in the optic commissure of man (after Flint.)

The Horopter.—If we hold up one finger before another, in front of both eyes, when the accommodation is made for the one the other will appear double, owing to the images not falling on corresponding parts of the retina; for, if one eye be closed, one of the images disappears.

Another way of putting the matter is, to say that the objects in the field under consideration do not lie in the horopter. The

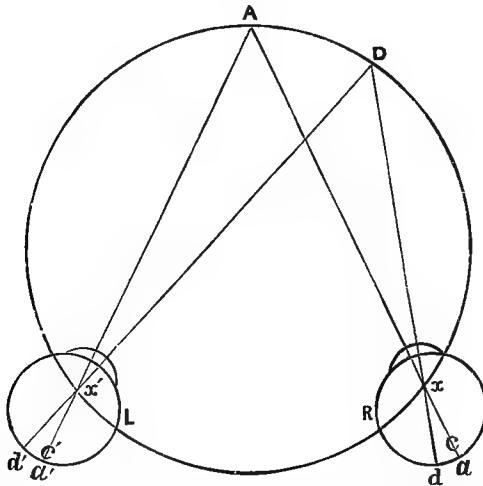

FIG. 436.—The horopter (after Le Conte). When the eyes are directed to the point *A* in the circle, images from any other part of it (as *D*) fall on corresponding points of the retinae.

latter is that arrangement of points in space from which rays fall on corresponding (identical) parts of the retina. It must

vary with the position of the eyes, head, etc., and often constitutes a very complex geometrical figure when the various points are united. The simpler case is when standing upright we look toward the distant horizon, in which instance the horopter forms a plane drawn beneath us—i. e., is the ground on which we stand. This will appear from Fig. 436.

Estimation of the Size and Distance of Objects.—The processes by which we form a judgment of the size and distance of objects are closely related.

As we have already shown (page 583), the visual angle varies both with the size and the distance of an object. Knowing that two objects are at the same distance from the eye, we estimate that the one is larger than the other when the image one forms on the retina is larger, or when the visual angle it subtends is greater than in the other case, and conversely. Thus, knowing that two persons are at the distance of half a mile away, if one is judged by us to be smaller than the other, it will be because the retinal image corresponding to the object is smaller, other things being equal. But the subject is more complex than might be inferred from these statements.

We have already pointed out that objects of a certain color seem nearer than others; also those that are brighter, as in the case of mountains on a clear day. And not only do all the qualities of the image itself enter as data into the construction of the judgment, but numerous muscular sensations. The eyes accommodating and converging for near objects, from the law of association, give rise to the idea of nearness, for habitually such takes place when near objects are viewed, so that the subject becomes very complex. That we judge imperfectly of the position of an object with but one eye is realized on attempting to stick a pin into a certain small spot, thread a needle, cork a small bottle, etc., when one eye is closed.

Solidity.—By the use of one eye alone we can form an idea of the shape of a solid body; though, in the case of such as are very complex, this process is felt to be both laborious and imperfect.

From the limited nature of the visual field for distinct vision, it follows that we can not with one eye see equally distinctly all the parts of a solid that is turned toward us. After a little practice one may learn to define for himself what he actually does see.

Such a figure as that following results from the combination, *mentally*, of two others, which answer to the images falling on the right and on the left eyes respectively.

In order that such fusion shall take place, the respective images must fall on identical (corresponding) parts of the retina.

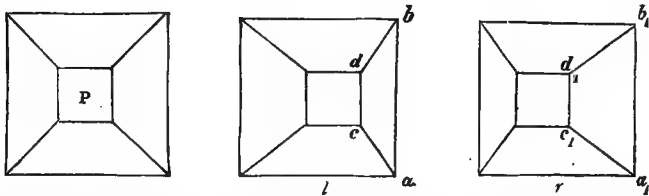

FIG. 437.—Illustrates binocular vision. If the truncated pyramid, P, be looked at with the head held perpendicularly over the figure, the image formed in the right eye when the left is closed is figured on the right, and that seen when the right eye is closed is represented by the figure in the middle. No superposition of these figures will give P, yet by a *psychic* process they are combined into P, the figure as it appears to both eyes (after Bernstein).

As is well known, the pictures used for stereoscopes give different views of the one object, as represented on a flat surface. These are thrown upon corresponding points of the retina by the use either of prisms or mirrors, when the idea of solidity is produced. As to whether movements of the eyes (convergence) are necessary for stereoscopic vision is disputed. It has been inferred, from the fact that objects appear solid during an electric flash, the duration of which is far too short to permit of movements of the ocular muscles, that such movements are not essential. The truth seems to lie midway; for while simple figures may not require them, the more complex do, or, at all events, the judgment is very greatly assisted thereby. It is of the utmost importance to bear in mind that all visual judgments are the result of many processes, in which, not the sense of vision alone, but others, are concerned; and the mutual dependence of one sense on another is great, probably beyond our powers to estimate. Reference has been made to this subject previously.

PROTECTIVE MECHANISMS OF THE EYE.

The eyelids have been appropriately compared to the shutters of a window. They are, however, not impervious to light, as any one may convince himself by noticing that he can locate the position of a bright light with the eyes shut; also that a sensitive person (child) will turn away (reflexly) from a light when sleeping if it be suddenly brought near the head. The Meibomian glands, a modification of the sebaceous, secrete an oily substance that seems to protect the lids against the lachry-

mal fluid, and prevents the latter running over their edges as oil would on the margins of a vessel. The lachrymal gland is not in structure unlike the parotid, the secretion of which its own somewhat resembles.

The saltness of the tears, owing to abundance of sodium chloride, is well known to all. The nervous mechanism of secretion of tears is usually reflex, the stimulus coming from the action of the air against the eyeball or from partial desiccation owing to evaporation. When the eyeball itself, or the nose, is irritated, the afferent nerves are the branches of the fifth, to which also belong the efferent nerves. The latter include also the cervical sympathetic. But it will, of course, be understood that the afferent impulses may be derived through a large number of nerves, and that the secreting center may be acted upon directly by the cerebrum (emotions). The excess of lachrymal secretion is carried away by the nasal duct into which the lachrymal canals empty. While it is well known that closure of the lids by the orbicularis muscle favors the removal of the fluid, the method by which the latter is accomplished is not agreed upon. Some believe that the closure of the lids forces the fluid on through the tubes, when they suck in a fresh quantity; others that the orbicularis drives the fluid directly through the tubes, kept open by muscular arrangements; and there are several other divergent opinions. The prevention of winking leads to irritation of the eye, which may assume a serious character, so that the obvious use of the secretion of tears is to keep the eye both moist and clean.

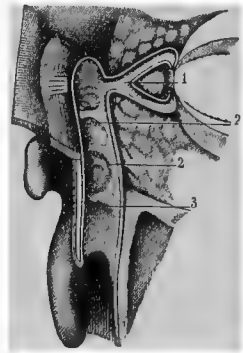

FIG. 438.—Lachrymal canals, lachrymal sac, and nasal canal, opened from the front (after Sappey).

SPECIAL CONSIDERATIONS.

Comparative.—It seems to be established that certain animals devoid of eyes, as certain myriopods, are able to perceive the presence of light, even when the heat-rays are cut off. The most rudimentary beginning of a visual apparatus appears to be a mass of pigment with a nerve attached, as in certain worms; though it is questionable whether mere collections of pigment without nerves may not in some instances represent still earlier

rudiments of our eyes. Among invertebrates, eyes may in general be divided into two classes: 1. The compound or faceted eyes, the structure of which may be gathered from the accompanying figures. It will be noted that in such the retina is convex, and is made up of large compound nerve-rods (*retinulæ*), separated from one another by pigment-sheaths. The picture

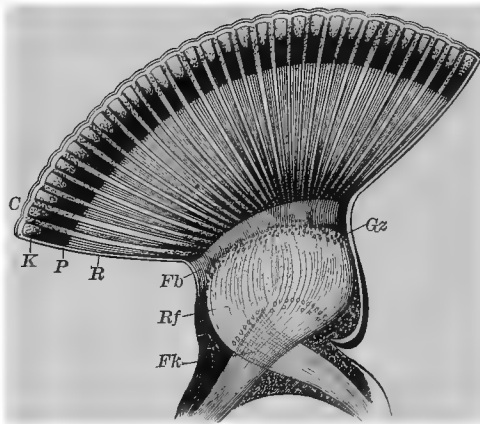

FIG. 439.

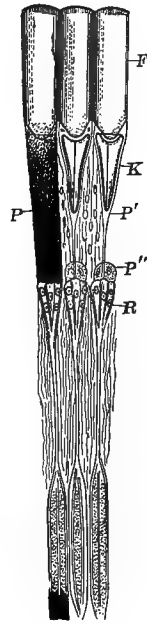

FIG. 440.

FIG. 439.—Diagrammatic representation of compound eye in an Arthropod (after Claus). *C*, cornea; *K*, crystalline lens; *P*, pigment; *R*, nerve-rods of retina; *Fb*, layer of fibers; *Gz*, layer of ganglion cells; *Rf*, retinal fibers; *Fk*, crossing of fibers.

FIG. 440.—Three facets with retinulæ from compound eye of cockchafer (after Grenacher). Pigment has been dissolved away from two of the facets. *F*, corneal facet; *K*, crystalline cone; *P*, pigment-sheath; *P'*, chief pigment-cell; *P''*, pigment-cells of second order; *R*, retinulæ.

formed by such eyes must represent a sort of mosaic, and be rather deficient in definition and brightness. It will be noticed that in such eyes, both the cornea and crystalline lens of vertebrates are represented in multiple form. This form of eye is found in crustaceans and some insects. 2. The simple eye prevails among annelids, insects, arachnids, mollusks, and vertebrates. A more advanced form of such a visual organ is found in the cuttle-fish. It may be seen (Fig. 442) that such an eye corresponds fairly well with the eye of a vertebrate.

The eye of the fish is characterized by flatness of the cornea;

spherical form of the lens, the anterior surface of which projects far beyond the pupillary opening; the presence of a pro-

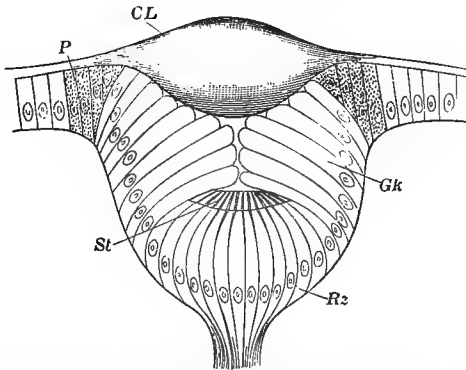

FIG. 441.—Transverse section of the simple eye of a beetle larva (after Claus and Grenacher). *CL*, corneal lens; *Gk*, subjacent hypodermic cells (vitreous humor); *P*, pigment in peripheral cells of latter; *Rz*, retinal cells; *St*, cuticular rods of latter.

cess of the choroid (*processus falciformis*); and usually the absence of eyelids, the cornea being covered with transparent skin.

The eye of the bird, in some respects the most perfect visual

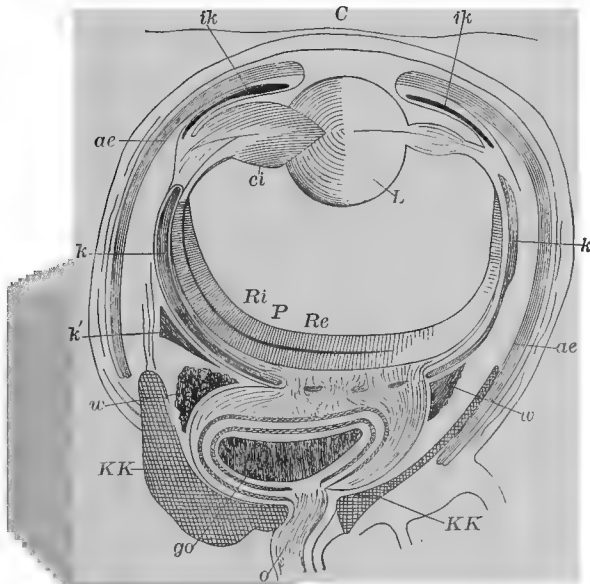

FIG. 442.—Diagrammatic horizontal section of eye of cuttle-fish (after Hensen and Gegenbaur). *KK*, cephalic cartilages; *C*, cornea; *L*, lens; *ci*, ciliary body of lens; *Ri*, internal layer of retina; *Re*, external layer of retina; *P*, pigment layer; *o*, optic nerve; *go*, ganglion; *k*, papillary cartilage; *ik*, cartilage of iris.

organ known, is of peculiar shape as a whole, presenting a large posterior surface for retinal expansion; a very convex cornea, a highly developed lens, an extremely movable iris; eyelids and a nictitating membrane (third eyelid), which may be made to cover the whole of the exposed part of the eye, and thus shield screen-like from excess of light; ossifications of the sclerotic;

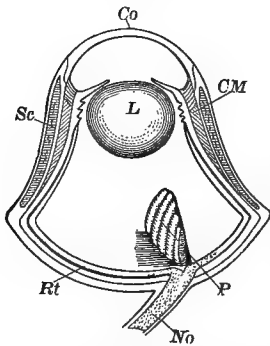

FIG. 443.—Eye of nocturnal bird of prey (after Wiedersheim). *Co*, cornea; *L*, lens; *Rt*, retina; *P*, pecten; *No*, optic nerve; *Sc*, ossification of sclerotic coat; *CM*, ciliary muscle. Birds have unusually keen vision, great power of accommodation, and extreme mobility of the iris.

a structure which is a peculiar modification of the choroid, of which it is a sort of offshoot and like it very vascular, answering to the falciform process of the eye of the fish and the reptile. From its appearance it is termed the *pecten*. Birds, on account of a highly developed ciliary muscle, possess wonderful powers of accommodation, rendered important on account of their rapid mode of progression. They also seem to be able to alter the size of the pupil at will.

Evolution.—From the above brief account of the eye in different grades of animals, it will appear that its modifications answer to differences in the environment.

Adaptation is evident. Darwin believes this to have been effected partly by natural selection—i. e., the survival of the animal in which the form of eye appeared best adapted to its needs, and partly by the use or disuse of certain parts.

The latter is illustrated—1. By the blind fishes, insects, etc., of certain caves, as those of Kentucky; and it is of extreme interest to note that various grades of transition toward complete blindness are observable, according to the degree of darkness in which the animal is found living, whether wholly within the cave or where there is still some light. A crab has been found with the eye-stalk still present, but the eye itself atrophied. Again, animals that burrow seem to be in process of losing their eyes, through inflammation from obvious causes; and some of them, as the moles, have the eye still existing, though well-nigh or wholly covered with skin. Internal parasites are often without eyes. It is not difficult to understand how one bird of prey, with eyes superior to those of its fellows, would gain supremacy, and, in periods of scarcity, survive and leave offspring when others would perish.

It is, of course, impossible to trace each step by which the vertebrate eye has been developed from more rudimentary forms, though the data for such an attempt have greatly accumulated within the last few years; and it is not to be forgotten that even the vertebrate eye has many imperfections, so that no doctrine of complete adaptation, according to the argument from design as usually understood, can apply.

Certain *acquired* imperfections of the eye seem to be multiplying at the present day, such as myopia, weakness of the accommodative mechanism, etc. The excessive use of the eyes, necessitating undue exercise of this apparatus or strain of the accommodation, is the fruitful source of evil. A good light—that is, one both sufficient in quantity and falling in the right direction upon the eyes and the objects to be viewed, together with adequate ventilation of the rooms occupied—is of great importance, though, as in the case of other organs, it is impossible to avoid wholly the penalties of over-use of the visual apparatus.

It is of great importance to recognize that what we really see depends more upon the brain and the mind than the eye. If any one will observe how frequent are his incipient errors

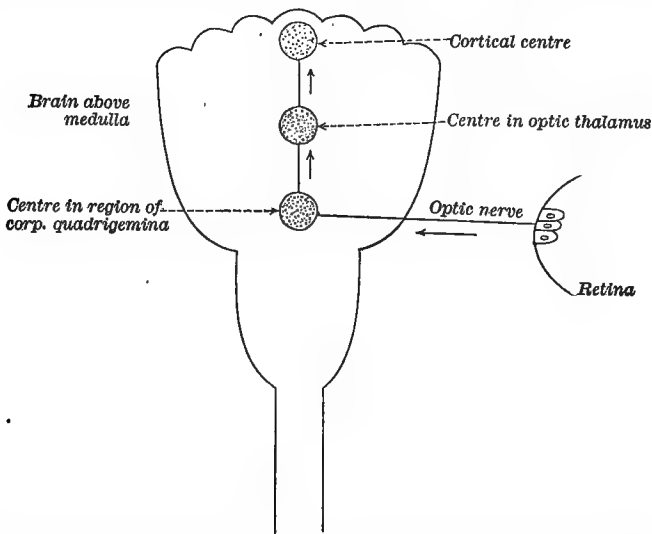

FIG. 444.—Diagram intended to illustrate the elaboration of visual impulses, beginning in retina and culminating in the cerebral cortex. Course of impulses is indicated by arrows. Knowledge of auditory centers is not yet exact enough to permit of the construction of a diagram, though doubtless eventually the central processes will be localized as with vision. The latter remark applies to the other senses to nearly the same extent, possibly quite as much.

of vision speedily corrected, he will realize the truth of the above remark. Precisely the same data furnished by the eye are in one mind worked up in virtue of past experience (education) into an elaborate conception, while to another they answer only to certain vague forms and colors. And herein lies the great superiority of man's vision over that of all other animals.

Within the limits of their *mental* vision do all creatures see. Man has not the keen ocular discriminating power of the hawk; he can neither see so far nor so clearly; nor has he the wide field of vision of the gazelle; but he has the mental resource which enables him to make more out of the materials with which his eyes furnish him. It is by virtue of his higher cerebral development that he has added to his natural eyes others in the microscope and telescope, which none of Nature's forms can approach.

Pathological.—There may be ulceration of the cornea, inflammation of this part, or various other disorders which lead to opacity. The low vitality of this region, probably owing to absence of blood-vessels, is evidenced by the slowness with which small ulcers heal. Opacity of the lens (cataract) when complete causes blindness, which can be only partially remedied by removal of the former. Inflammations of any part of the eye are serious, from possible adhesions, opacities, etc., following. Should such be accompanied by great excess of intra-ocular tension, serious damage to the retina may result. Of course, atrophy of the optic nerve (due to lesions in the brain, etc.) is irremediable, and involves blindness. Inspection of the internal parts of the eye (*fundus oculi*) often reveals the first evidence of disease in remote parts, as the kidneys.

From what has been said of the movements of the two eyes in harmony, etc., the student might be led to infer that disease of one organ, in consequence of an evident close connection of the nervous mechanism of the eyes, would be likely to set up a corresponding condition in the other unless speedily checked. Such is the case, and is at once instructive and of great practical moment.

Paralysis of the various ocular muscles leads to squinting, as already noticed.

Brief Synopsis of the Physiology of Vision.—All the other parts of the eye may be said to exist for the retina, since all are related to the formation of a distinct image on this nervous expansion. The principal refractive body is the crystalline lens.

The iris serves to regulate the quantity of light admitted to the eye, and to cut off too divergent rays. In order that objects at different distances may be seen distinctly, the lens alters in shape in response to the actions of the ciliary muscle on the suspensory ligament, the anterior surface becoming more convex. Accommodation is associated with convergence of the visual axes and contraction of the pupil. The latter has circular and radiating plain muscular fibers (striped in birds, that seem to be able to alter the size of the pupil at will), governed by the third, fifth, and sympathetic nerves. Contraction of the pupil is a reflex act, the nervous center lying in the front part of the floor of the aqueduct of Sylvius, while the action of the other center (near this one) through the sympathetic nerve is tonic.

Accommodation through the ciliary muscle is governed by a center situated in the hind part of the floor of the third ventricle near the anterior bundles of the third nerve, which latter is the medium of the change. There are certain imperfections common to all human eyes, such as spherical and chromatic aberration, a limited degree of astigmatism, etc. When rays of light are focused anterior to the retina, the eye is myopic; when posterior to it, hypermetropic.

The presbyopic eye is one in which the mechanism of accommodation is at fault, chiefly the ciliary muscle. The point of entrance of the optic nerve (blind-spot) is insensible to light; and visual impulses can be shown to originate in the layers of rods and cones, probably through stimulation from chemical changes effected by light acting on the retina. The sensation outlasts the stimulus; hence positive after-images occur. Negative after-images occur in consequence of excessive stimulation and exhaustion of the retina, or disorder of the chemical processes that excite visual impulses. When stimuli succeed one another with a certain degree of rapidity, sensation is continuous. The eye can distinguish degrees of light within certain limits, varying by about $\frac{1}{10}$ of the total.

Objects become fused or are seen as one when the rays from them falling on the retina approximate too closely on that surface. The brain, as well as the eye itself, is concerned in such discriminations, the former probably more than the latter. The various *color* sensations we have are the result either of definite single sensations or the fusion physiologically of two or more of these, and have no reference to the fusion of pigments external to the eye. All human eyes are to some extent color-

blind in the sense that it is probable that other animals (ants, etc.) can perceive colors not included in our spectrum, and also in the sense that all parts of the retina are not *equally* sensitive to rays of a certain wave-length; but some persons are unable to perceive certain colors at all.

The *macula lutea*, and especially the *fovea centralis*, are the points of greatest retinal sensitiveness. When the images of objects are thrown on these parts, they are seen with complete distinctness; and it is to effect this result that the movements of the two eyes in concert take place. An object is seen as one when the position of the eyes (visual axes) is such that the images formed fall on corresponding parts of the retina. Binocular vision is important to supply the sensory data for the idea of solidity. It is important to remember that, before an object is "seen" at all, the sensory impressions furnished by the retina and conveyed inward by the optic nerve are elaborated in the brain and brought under the cognizance of the perceiving *ego*. We recognize many visual illusions and imperfections of various kinds, the course of which it is difficult to locate in any one part of the visual tract, such as are referred to "irradiation," "contrast," etc. There may also be visual phenomena that are purely subjective, and others that result from suggestion rather than any definite sensory basis of retinal images. Hence what one sees depends on his state of mind at the time.

This applies to appreciation of size and distance also, though in such cases we have the visual angle, certain muscular movements (muscular sense), the strain of accommodation, etc., as guides.

HEARING.

As the end-organ of vision is protected both without and within, so is the still more complicated end-organ of the sense of hearing more perfectly guarded against injury, being inclosed within a membranous as well as bony covering and surrounded by fluid, which must shield it from stimulation, except through this medium.

Hearing proper, as distinguished from the mere recognition of jars to the tissues, can, in fact, only be attained through the impulses conveyed to the auditory brain-centers, as originated in the end-organ by the vibrations of the fluid with which it is bathed.

It will be assumed that the student has made himself familiar with the general anatomy of the ear. The essential points in regard to sound are considered in the chapter on "The Voice." It will be remembered that what we term a musical tone, as distinguished from a noise, is characterized by the regularity of vibrations of the air that reach the ear; and that just as ethereal vibrations of a certain wave-length give rise to the sensation of a particular color, so do aërial vibrations of a definite wave-length originate a certain tone. In each case must we take into account a physical cause for the physiological effect, and these bear a very exact relationship to one another.

As will be seen later, while in all animals that have a well-defined sense of hearing the process is essentially such as we have indicated above, the means leading up to the final stimulation of the end-organ are very various. At present we shall consider the acoustic mechanism in mammals, with special reference to man. There are in fact three sets of apparatus: (1)

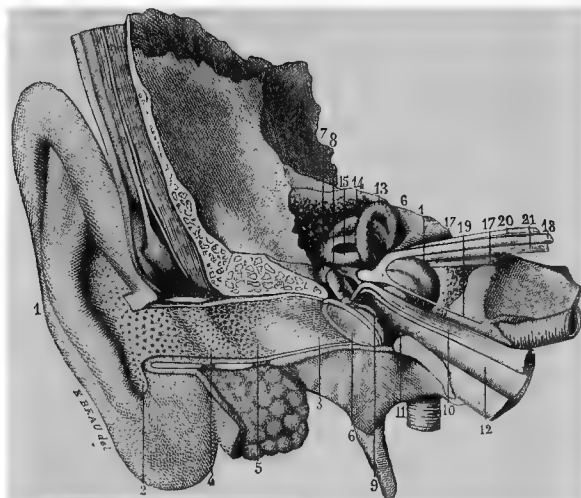

FIG. 445.—Section through auditory organ (after Sappey). 1, pinna; 2, 4, 5, cavity of concha, external and auditory meatus with opening of ceruminous glands; 6, membrana tympani; 7, anterior part of incus; 8, malleus; 9, long handle of malleus, attached to internal surface of tympanic membrane—it is here represented as strongly indrawn; 10, tensor tympani muscle; 11, tympanic cavity; 12, Eustachian tube; 13, superior semicircular canal; 14, posterior semicircular canal; 15, external semicircular canal; 16, cochlea; 17, internal auditory meatus; 18, facial nerve; 19, large petrosal nerve; 20, vestibular branch of auditory nerve; 21, cochlear branch of same.

one for collecting the aërial vibrations; (2) one for transmitting them; and (3) one for receiving the impression through a fluid medium; in other words, an external, middle, and internal ear.

The *external* ear in man being practically immovable, owing to the feeble development of its muscles, has, as compared with such animals as the horse or cow, but little use as a collecting organ for the vibrations of the air. The meatus or auditory canal may be regarded both as a conductor of vibrations and as protective to the middle ear, especially the delicate drum-head, since it is provided with hairs externally in particular, and with glands that secrete a bitter substance of an unctuous nature.

The **Membrana Tympani** is concavo-convex in form, and, having attached to it the chain of bones shortly to be noticed, is well adapted to take up the vibrations communicated to it from the air; though it also enters into sympathetic vibration when

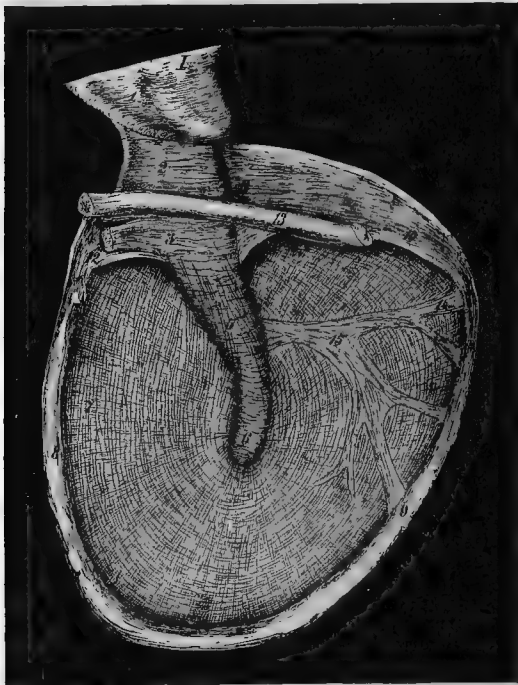

FIG. 446.—Photographic representation of right membrana tympani, viewed from within (after Flint and Rüdinger). 1, divided head of malleus; 2, neck; 3, handle, with attachment of tendon of tensor tympani; 4, divided tendon; 5, 6, long handle of malleus; 7, outer radiating and inner circular fibers of tympanic membrane; 8, fibrous ring encircling membrana tympani; 9, 14, 15, dentated fibers of Gruber; 10, 11, posterior pocket connecting with malleus; 12, anterior pocket; 13, chorda tympani nerve.

the bones of the head are the medium, as when a tuning-fork is held between the teeth. Ordinary stretched membranes

have a fundamental (self-tone, proper tone) tone of their own, to which they respond more readily than to others.

If such held for the membrana tympani, it is evident that certain tones would be heard better than others, and that when the fundamental one was produced the result might be a sensation unpleasant from its intensity. This is partially obviated by the damping effect of the auditory ossicles, which also prevent after-vibrations.

Some suppose that what we denominate shrill or harsh sounds are, in part at least, owing to the auditory meatus having a corresponding fundamental note of its own.

The Auditory Ossicles.—Though these small bones are connected by perfect joints, permitting a certain amount of play upon one another, experiment has shown that they vibrate in response to the movements of the drum-head *en masse*; though

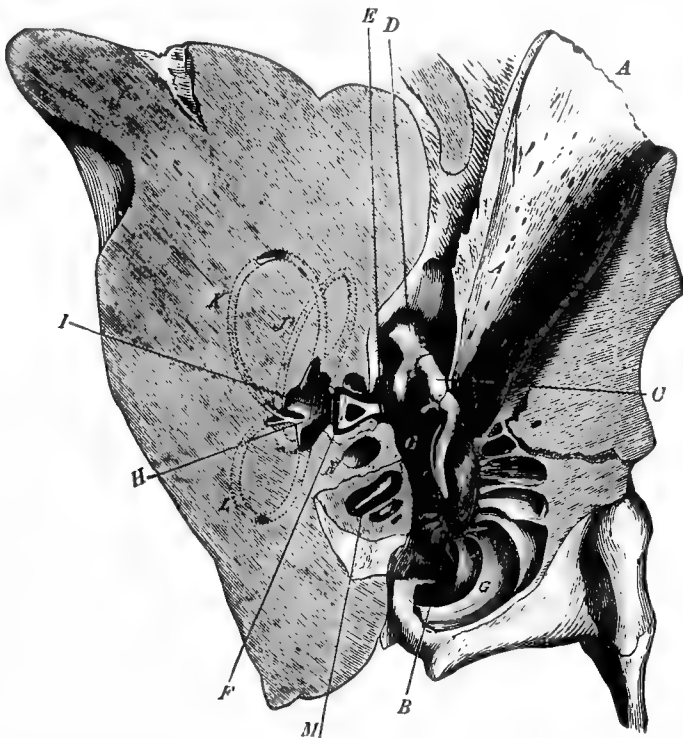

FIG. 447.—Section of auditory organ of horse (after Chauveau). A, auditory canal; B, membrana tympani; C, malleus; D, incus; F, stapes; G, mastoid cells; H, fenestra ovalis; I, vestibule; J, K, L, outline of semicircular canals; M, cochlea; N, commencement of scala tympani.

the stapes has by no means the range of movement of the handle of the malleus; in other words, there is loss in amplitude, but gain in intensity. A glance at Fig. 448 will show that the end attained by this arrangement of membrane and bony levers, which may be virtually reduced to one (as it is in the frog, etc.), is the transmission of the vibrations to the membrane of the fenestra ovalis, through the stapes finally, and so to the fluids within the internal ear. But it might be supposed that, for the

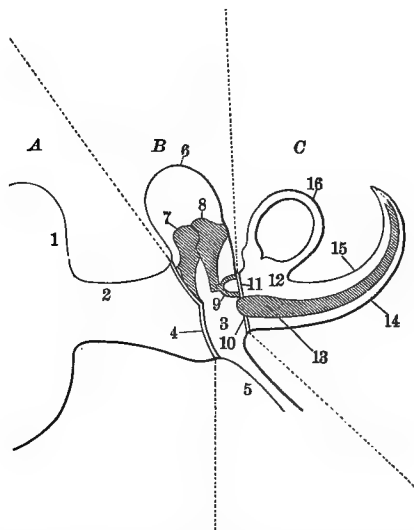

FIG. 448.—Diagrammatic representation illustrating auditory processes (after Beaunis). *A*, external ear; *B*, middle ear; *C*, internal ear; 1, auricle; 2, external auditory meatus; 3, tympanum; 4, membrana tympani; 5, Eustachian tube; 6, mastoid cells; 10, foramen rotundum; 11, foramen ovale; 12, vestibule; 13, cochlea; 14, scala tympani; 15, scala vestibuli; 16, semicircular canals.

N. B.—The ear is so complicated an organ that it is almost impossible to give a diagrammatic representation of it at once simple and complete in a single figure. A comparison of the whole series of cuts is therefore desirable. It is essential to understand how the end-organ within the scala media is stimulated.

avoidance of shocks and the better adaptation of the apparatus to its work, some regulative apparatus, in the form of a nervous and muscular mechanism, would have been evolved in the higher groups of animals. Such is found in the tensor tympani, laxator tympani, and stapedius muscles, as well as the Eustachian tube.

Muscles of the Middle Ear.—The tensor tympani regulates the degree of tension of the drum-head, and hence its amplitude of vibration, having a damping effect, and thus preventing the ill results of very loud sounds.

Ordinarily this is, doubtless, a reflex act, in which the fifth

is usually the afferent nerve concerned. It is well-known that, when we are aware that an explosion is about to take place, we are not as much affected by it, which would seem to argue a voluntary power of accommodation; but of this we must speak with caution.

According to some authorities the *laxator tympani* is not a muscle, but a supporting ligament for the malleus. The *stapedius*, however, has the important function of regulating the movements of the stapes, so that it shall not be too violently driven against the membrane covering the fenestra ovalis.

The two muscles, stapedius and tensor, suggest the accommodative mechanism of the iris. The motor nerve of the stapedius is derived from the facial; of the tensor, from the trigeminus through the otic ganglion.

The Eustachian Tube.—Manifestly, if the middle ear were closed permanently, its air would gradually be absorbed. The drum-head would be thrust in by outward pressure, and become useless for its vibrating function. The Eustachian tube, by communicating with the throat, keeps the external and internal pressure of the middle ear balanced. Whether this canal is permanently open, or only during swallowing, is as yet undetermined.

One may satisfy himself that the middle ear and pharynx communicate, by closing the nostrils and then distending the upper air-passages by a forced expiratory effort, when a sense of distention within the ears is experienced, owing to the rise of atmospheric pressure in the tympanum.

Pathological.—Inflammation of the tympanum may result in adhesions of the small bones to other parts or to each other, or to occlusion of the Eustachian tube from excess of secretion, cicatrices, etc., in consequence of which the relations of atmospheric pressure become altered, the membrani tympani being indrawn, and the whole series of conditions on which the normal transmission of vibrations depends disturbed, with the natural result, partial deafness. The hardness of hearing experienced during a severe cold in the head (catarrh, etc.) is owing in great part to the occlusion of the Eustachian tube, which may be either partial or complete.

By filling one or both of the ears external to the membrana tympani with cotton-wool, one may satisfy himself how essential for hearing is the vibratory mechanism, which is, of course, under such circumstances inactive or nearly so; hence the deafness.

When the middle ear is not functionally active, it is still possible, so long as the auditory nerve is normal, to hear vibrations of a body (as a tuning-fork) held against the head; though, as would be expected, discrimination as to pitch is very imperfect.

Auditory impulses originate within the inner ear—that is to say, in the vestibule and possibly the semicircular canals,

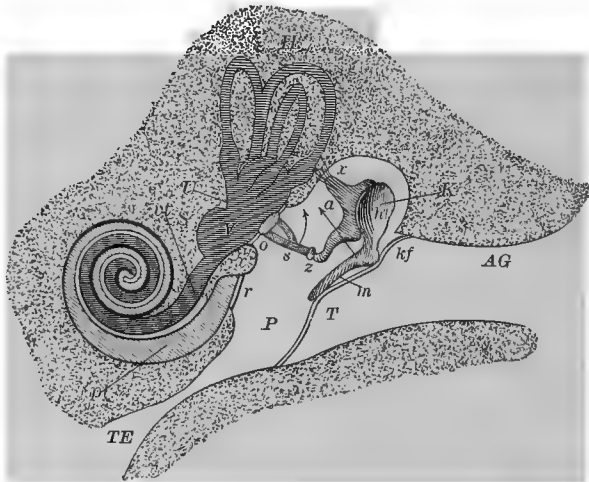

FIG. 449.—Diagram intended to illustrate the processes of hearing (after Landois). *AG*, external auditory meatus; *T*, tympanic membrane; *K*, malleus; *a*, incus; *P*, middle ear; *o*, fenestra ovalis; *r*, fenestra rotunda; *pl*, scala tympani; *vf*, scala vestibuli; *V*, vestibule; *S*, saccule; *U*, utricle; *H*, semicircular canals; *TE*, Eustachian tube. Long arrow indicates line of traction of tensor tympani; short curved one that of Stapedius.

but especially in the cochlea. It is to be remembered that the whole of the end-organ concerned in hearing is bathed by endolymph; and that the vibrations of the latter are originated by

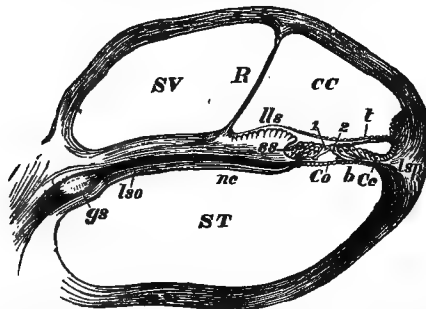

FIG. 450.—Section through one of the coils of cochlea (after Chauveau). *ST*, scala tympani; *SV*, scala vestibuli; *CC*, cochlear canal (scala media); *Co*, organ of Corti; *R*, membrane of Reissner; *b*, membrana basilaris; *lso*, lamina spiralis ossea; *t*, membrana tectoria; 1, 2, rods of Corti; *nc*, cochlear nerve with its ganglion, *gs*.

corresponding vibrations of the perilymph, which again is sent into oscillation by the movements of the stapes against the membrane covering the fenestra ovalis; so that the vibrations thus set up without the membranous labyrinth are transformed into similar ones within the vestibule and the scala vestibuli, and end, after passing over the scala tympani, against the membrane of the fenestra rotunda. The cochlear canal may be regarded as the seat of the most important part of the organ of hearing, and answers to the macula lutea of the eye in many respects.

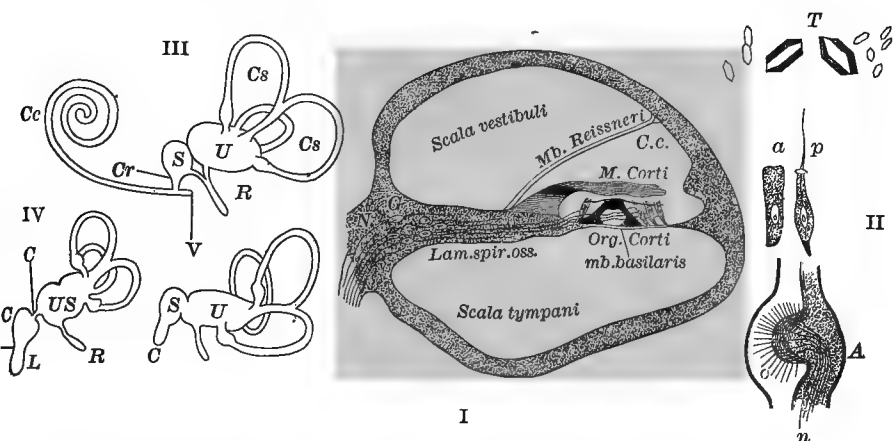

FIG. 451.—I. Transverse section of a turn of cochlea. II. Ampulla of a semicircular canal and its crista acoustica; *ap*, auditory cells, one of which is a hair-cell. III. Diagram of labyrinth of man. IV. Of bird. V. Of fish. (After Landois.)

The organ of Corti has given rise to certain speculations which require a brief notice. It has been supposed that, as the key-board of a piano may be said to cause certain tones by being associated with stretched wires of varying lengths, so the vibrations of the *rods* of Corti originate in certain nerve-fibers the sensations answering to the different tones we hear. It was found, however, (1) that these rods, though very numerous (6,000 to 10,000), are insufficient to account for the actual range of our hearing; (2) that they are absent in certain classes of animals that discriminate sounds very well, as birds; and (3) that the nerve-fibers do not terminate in these rods at all, but in the hair-cells of the organ of Corti. It is now proposed that the *basilar membrane* (present in birds) may, like a series of tense strings of different lengths, be the required organ. The failure of certain theories of vision should have

made physiologists cautious in adopting so mechanical an explanation. If all our perceptions of color, however minute the

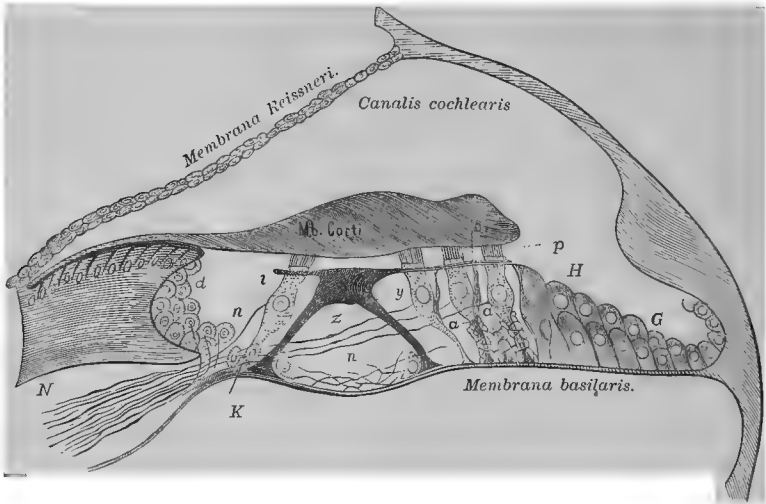

FIG. 452.—Diagrammatic representation of ductus cochlearis and organs of Corti (after Landolt). *N*, nerve of cochlea; *K*, inner, and *P*, outer, hair-cells; *n*, nerve-fibrils terminating in *P*; *a, a*, supporting cells; *d*, cells of succus spiralis; *z*, inner rod of Corti; *y*, outer rod of Corti; *mb*, membrane of Corti (membrana tectoria); *o*, membrana reticularis; *H, G*, cells of area toward outer wall.

shade of difference from others (and some believe we can recognize millions of such gradations), are the result of the fusion,

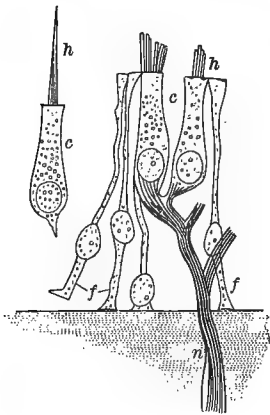

FIG. 453.

FIG. 453.—Auditory epithelium from macula acoustica of saccule of alligator, much magnified (after Schäfer). *c, c*, columnar hair-cells; *f, f*, fiber-cells; *n*, nerve-fiber losing its medullary sheath and about to terminate in columnar auditory cells; *h*, auditory hair; *h'*, base of auditory hairs split up into fibrils.

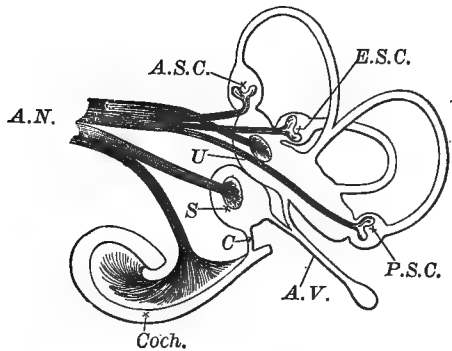

FIG. 454.

FIG. 454.—Diagrammatic representation of distribution of auditory nerve in membranous labyrinth and cochlea (after Huxley).

etc., of three different fundamental sensations, or the result of chemical processes few in kind, why should not hearing be explained in an equally simple way? Such views as those re-

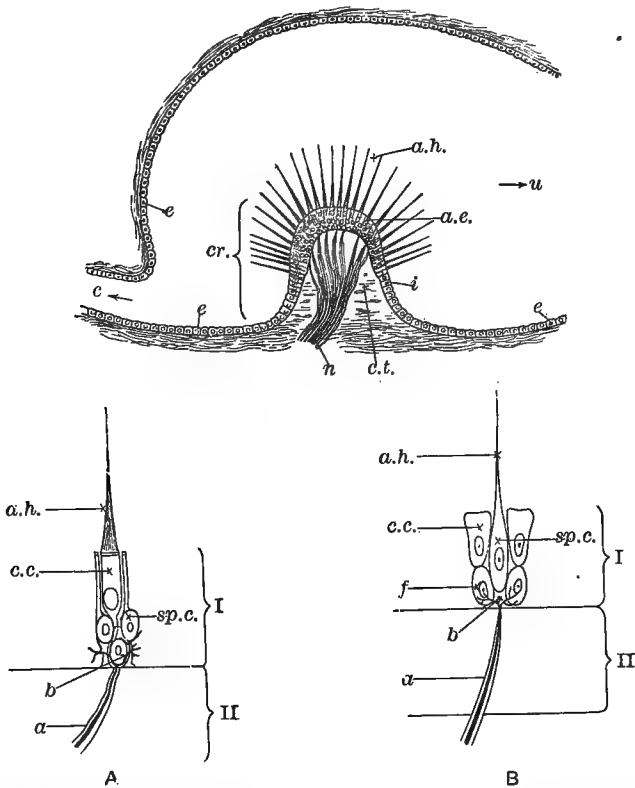

FIG. 455.—Longitudinal section of ampulla, somewhat diagrammatic (after Huxley). *c*, end of ampulla joining semicircular canal; *u*, opening into utricle; *cr.*, crista acoustica with hair-cells, to which may be seen passing, *n*, fibers of auditory nerve; *ct.*, connective-tissue support for auditory hairs.

ferred to above seem to us utterly at variance with the fundamental conceptions of biology; are so purely conceptions that have their birth in physics, that we deem it wiser to rest without any attempt at an explanation of the origin of auditory sensations in detail, than to accept such artificial and inadequate solutions as have been proposed. *Subjective* sensations of hearing are common enough in the insane, and answer to the visions of the same class of persons; so that we must recognize the possibility of such sensations arising without the usual external stimulus.

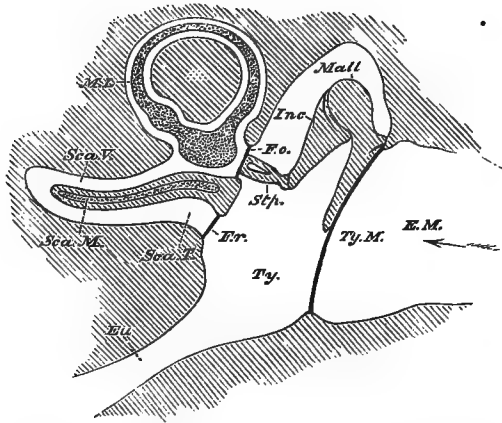

FIG. 456.—Diagram intended to illustrate relative position of various parts of ear (after Huxley). *E. M.*, external auditory meatus; *Ty. M.*, tympanic membrane; *Ty.*, tympanum; *Mall.*, malleus; *Inc.*, incus; *Stp.*, stapes; *F. o.*, fenestra ovalis; *F. r.*, fenestra rotunda; *Eu.*, Eustachian tube; *M. L.*, membranous labyrinth, only one of the semicircular canals and its ampulla being represented; *Sca. V.*, *Sca. T.*, *Sca. M.*, scalæ of cochlea, represented as straight (uncoiled).

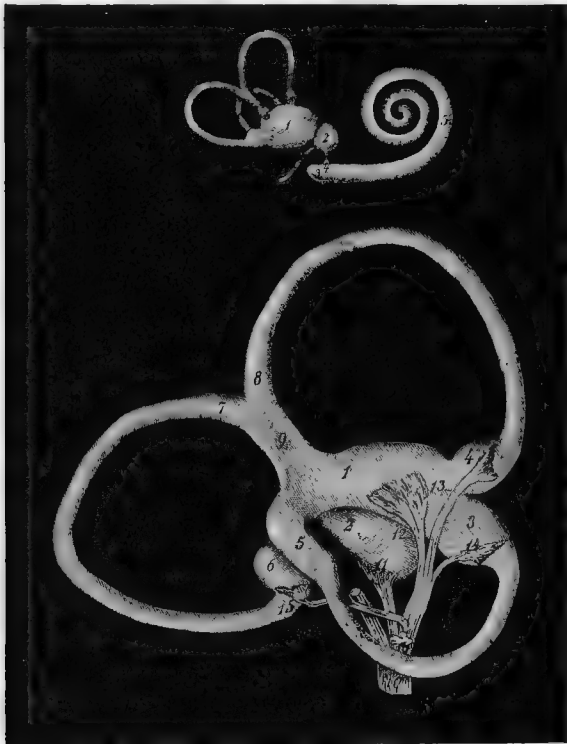

FIG. 457.—Photographic diagram of labyrinth (after Flint and Rüdinger). Upper figure: 1, utricle; 2, saccule; 3, 5, membranous cochlea; 4, canalis reuniens; 6, semicircular canals. Lower figure: 1, utricle; 2, saccule; 3, 4, 6, ampullæ; 5, 7, 8, 9, semicircular canals; 10, auditory nerve (partly diagrammatic); 11, 12, 13, 14, 15, distribution of branches of nerve to vestibule and semicircular canals.

The structure of the ampullæ of the semicircular canals, and other parts of the labyrinth besides those specially considered, with their peculiar hair-cells, suggests an auditory function; but what that may be is as yet quite undetermined.

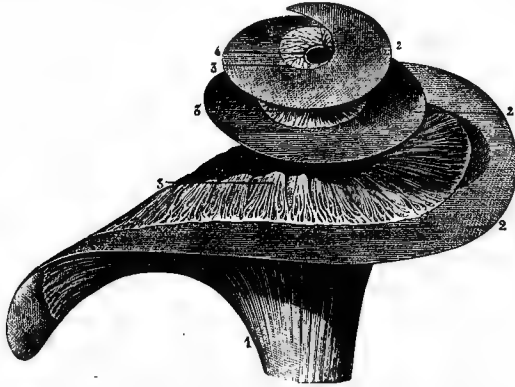

FIG. 458.—Distribution of cochlear nerve in spiral lamina of antero-inferior part of cochlea of right ear (after Sappey). 1, trunk of cochlear nerve; 2, membranous zone of spiral lamina; 3, terminal expansion of cochlear nerve exposed throughout by removal of superior plate of lamina spiralis; 4, orifice of communication between scala tympani and scala vestibuli.

It has been thought that the parts, other than the cochlea, are concerned with the appreciation of noise, or perhaps the intensity of sounds; but this is a matter of pure speculation.

AUDITORY SENSATIONS, PERCEPTIONS, AND JUDGMENTS.

We have thus far been concerned with the conduction of the aerial vibrations that are the physical cause of hearing; but before we can claim to have "heard" a word in the highest sense, certain processes, some of them physiological and some psychical, take place, as in the case of vision; hence we may speak of the affection of the end-organ or of auditory impulses, and of the processes by which these become, by the mediation of the brain, auditory sensations, and when brought under the cognizance of the mind as auditory perceptions and judgments.

Auditory Judgments.—Such are much more frequently erroneous than are our visual judgments, whether the direction or the distance of the sound be considered. As in the case of the eye, the muscular sense, from accommodation of the vibratory mechanism, may assist our judgments, being aided by our stored past experiences (memory) according to the law of

association. Sounds are, however, always referred to the world without us. The animals with movable ears greatly excel man in estimating the direction, if not the distance, of sounds. There are few physiological experiments more amusing than those performed on a person blindfolded, when attempting to determine either the distance or the direction of a sounding tuning-fork, so gross are the errors made.

One who makes such observations on others may notice that most persons move the ears slightly when attempting to make the necessary discriminations, which of itself tends to show how valuable mobility of these organs must be to those animals that have it highly developed.

Range of Auditory Discrimination.—If we compare the *range* of sense-perception of eye and ear, we find that the latter is in this respect far superior to the former. Assuming that the perception of red is owing to the influence of rays of light with four hundred and fifty-six billions of vibrations per second and violet at the opposite end of the spectrum with rays of six hundred and sixty-seven billions, it will be seen that the total range does not correspond with even one octave; while the ear can discriminate between tones answering on the one hand to about forty aërial vibrations per second and on the other to thirty-eight thousand or more, though this latter is greater in the upward direction than most persons can appreciate. Such limits answer to at least ten times that for the eye. On the other hand, a sense-impression on the organ of hearing lasts a shorter time by far than in the case of the eye, so that fusion of auditory sense-impressions is less readily produced.

SPECIAL CONSIDERATIONS.

Comparative.—Among invertebrates steps of progressive development can be traced. Thus, in certain of the jelly-fishes we find an auditory vesicle (Fig. 459) inclosing fluid provided with one or more otoliths or calcareous nodules and auditory cells with attached cilia, the whole making up an end-organ connected with the auditory nerve. A not very dissimilar arrangement of parts exists in certain mollusks (Fig. 460). The vesicle may lie on a ganglion of the central nervous system. On the other hand, the vesicle may lie open to the exterior, as in decapod crustaceans; and the otoliths be replaced by grains of sand from without. It is difficult to decide what the function of otoliths may be in mammals; but there seems to be little reason

to doubt that they communicate vibrations in the invertebrates. When the cephalopod mollusks, with their highly developed nervous system, are reached, we find a membranous and cartilaginous labyrinth.

Among *vertebrates* the different parts of the mammalian ear are found in all stages of development. The outer ear may be wholly wanting, as in the frog, or it may exist as a meatus only, as in birds. The tympanic cavity is wanting in snakes. Most fishes have a utricle and three semicircular canals, but some have only one; and the lowest of this group have an ear not greatly removed from the invertebrate type, as may be seen in the lamprey, which has a sacculus with auditory hairs and otoliths, in communication with two semicircular canals. Most of the amphibia are without a membrana tympani. The frog has (1) a membrana tympani communicating with the inner ear by (2) a bony and cartilaginous lever (*columella auris*), and (3) an inner ear consisting of three semicircular canals, a saccule and

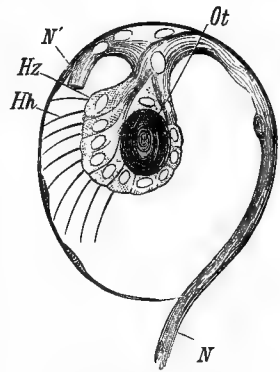

FIG. 459.—Auditory vesicle of *Geryonia* (*Carmarina*), seen from the surface (after O. and R. Hertwig). *N* and *N'*, the auditory nerves; *Ot*, otolith; *Hz*, auditory cells; *Hh*, auditory cilia (type of the auditory organ of the *Trachymedusae*).

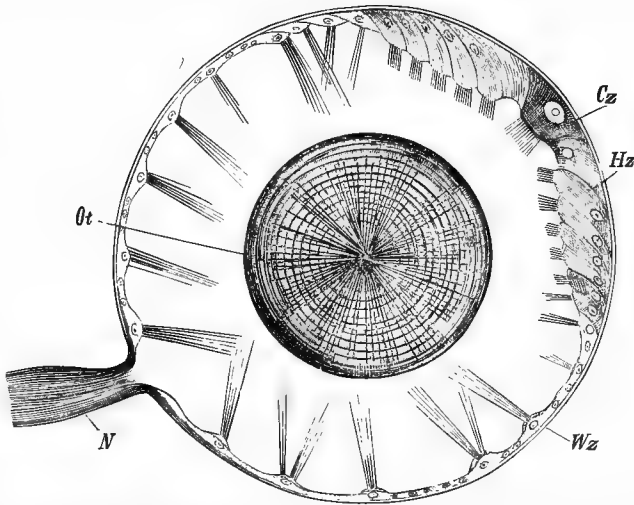

FIG. 460.—Auditory vesicle of a heteropod mollusk (*Pterotrachea*) (after Claus). *N*, auditory nerve; *Ot*, otolith in fluid of vesicle; *Wz*, ciliated cells on inner wall of vesicle; *Hz*, auditory cells; *Cz*, central cells.

utricle containing many otoliths, and a small dilatation of the vestibule, which may indicate an undeveloped cochlea. The

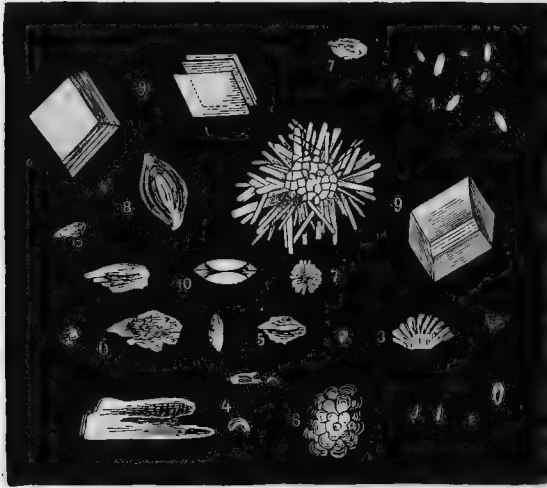

FIG. 461.—Otoliths from various animals (after Rüdinger). 1, from goat; 2, herring; 3, devil-fish; 4, mackerel; 5, flying-fish; 6, pike; 7, carp; 8, ray; 9, shark; 10, grouse.

membranous labyrinth is contained in a periotic capsule, partly bony and partly cartilaginous, which is supplied with perilymph. There is a fenestra ovalis, but not a fenestra rotunda, though the latter is present in reptiles. In crocodiles and birds the cochlea is tubular, straight, and divided into a scala tympani and a scala vestibuli. The columella of lower forms still persists. In birds and mammals the bone back of the ear is hollowed out to some extent and communicates with the tympanum. Except among the very lowest mammals (*Echidna*), the ear is such as has been described in detail already.

Evolution.—The above brief description of the auditory organ in different groups of the animal kingdom will suffice to show that there has been a progressive development or increasing differentiation of structure, while the facts of physiology point to a corresponding progress in function—in other words, there has been an evolution. No doubt natural selection has played a great part. It has been suggested that this is illustrated by cats, that can hear the high tones produced by mice, which would be inaudible to most mammals; and, as the very existence of such animals must depend on their detecting their prey, it is possible to understand how this principle has operated to determine even what cats shall survive. The author has noticed

that terrier dogs also have a very acute sense of hearing, and they also kill rats, etc. But, unless it be denied that the improvement from use and the reverse can be inherited, this factor must also be taken into the account.

There seem to be great differences between hearing as it exists in man and in lower forms. Birds, and at least some horses, possibly some cats and dogs, like music, and give evidence of the possession of a sense of rhythm, as evidenced by the conduct of the steed of the soldier. On the other hand, some dogs seem to greatly dislike music. Certain animals that

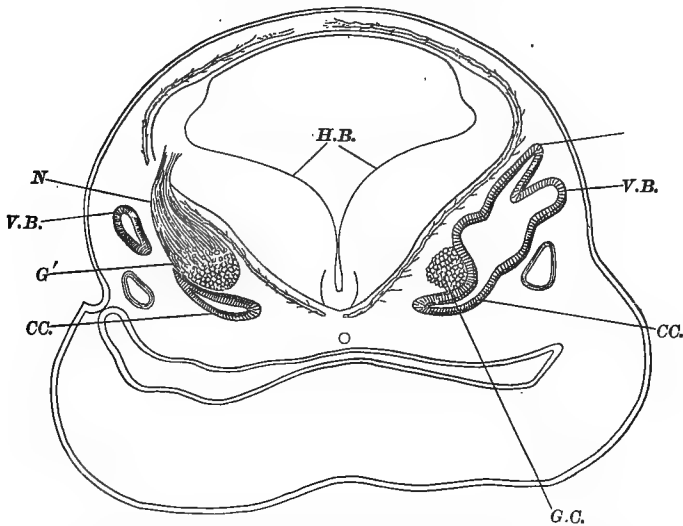

FIG. 462.—Transverse section through head of foetal sheep, in region of hind-brain, to illustrate development of ear (after Böttcher). *H. B.*, hind-brain; *N.*, auditory nerve; *V. B.*, vertical semicircular canal; *CC.*, canal of cochlea; *R. V.*, recessus vestibuli; *G. C.*, auditory ganglion; *G'.*, terminal portion of auditory nerve.

appear to be devoid of true hearing, as spiders, are nevertheless sensitive to aërial vibrations; whether by some special undiscovered organ or through the general cutaneous or other kind of sensibility is unknown. It also seems to be more than probable that some groups of insects can hear sounds quite inaudible to us, though by what organs is in great measure unknown.

The so-called musical ear differs from the non-musical in the ability to discriminate differences in pitch rather than in quality; in fact, that one defective in the former power may possess the latter in a high degree is a fact that has been somewhat lost sight of, both theoretically and practically. It does not at all follow that one with little capacity for tune may not

have the qualifications of ear requisite to make a first-rate elocutionist. Following custom, we have spoken as though certain defects and their opposites depended on the ear, but in reality we can not, in the case of man at all events, affirm that such is the case; indeed, it seems, on the whole, more likely that they are cerebral or mental. Auditory discriminations seem to be equally if not more susceptible of improvement by culture than visual ones, especially in the case of the young.

A "good ear" seems to depend in no small degree on memory of sounds, though the latter may again have its basis in the auditory end-organs or in the cerebral cortex, as concerned in hearing. The necessity for the close connection between the co-ordinations of the laryngeal apparatus in singing and speaking and the ear might be inferred from the fact that many excellent musicians are themselves unable to vocalize the music they perfectly appreciate.

Synopsis of the Physiology of Hearing.—The ear can appreciate differences in pitch, loudness, and quality of sounds, though whether different parts of the inner ear are concerned in these discriminations is unknown. Hearing is the result of a series of processes, having their physical counterpart in aërial vibrations, which begin in the end-organ in the labyrinth and terminate in the cerebral cortex. We recognize conducting apparatus which is membranous, bony, and fluid. The auditory nerve conveys the auditory impulses to the brain, though exactly what terminal cells are concerned and how in originating them must be regarded as undetermined. The essential part of the organ of hearing is bathed by endolymph, and the principal part (in mammals) is within the cochlear canal. Man's power to locate sounds is very imperfect. The auditory brain center (or centers) has not been definitely located. Comparative anatomy and physiology point clearly to a progressive development of the sense of hearing.

THE SENSE OF SMELL.

The nose internally may be divided into a respiratory and an olfactory region. The latter, which corresponds, of course, with the distribution of the olfactory nerve, embraces the upper and part of the middle turbinated bone and the upper part of the septum, all of which differ in microscopic structure from the respiratory region. Among the ordinary cylindrical epi-

thelium of the olfactory region are found peculiar hair-cells highly suggestive of those of the labyrinth of the ear, and

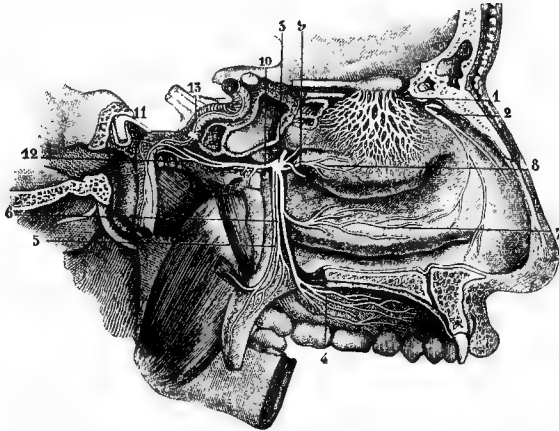

FIG. 463.—Parts concerned in smell (after Hirschfeld). 1, olfactory ganglion and nerves; 2, branch of nasal nerve, distributed over the turbinated bones.

which are to be regarded as the end-organs of smell. If aromatic bodies be held before the nose, and respiration suspended, they will not be recognized as such, and it is well known that sniffing greatly assists the sense of smell. Again, if fluids, such as *eau de Cologne*, be held in the nose, their aroma is not detected; and immediately after water has been kept in the nostrils for a few seconds, it may be noticed that smell is greatly blunted. Such is the case also when the mucous membrane is much swollen from a cold. There can be no doubt that the presence of fluid in the above cases is injurious to the delicate hair-cells, and that smell is dependent upon the excitation of these cells by *extremely minute* particles emanating from aromatic bodies.

When ammonia is held before the nose, a powerful sensation is experienced; but this is not smell proper, but an affection of ordinary sensation, owing to stimulation of the terminals of the

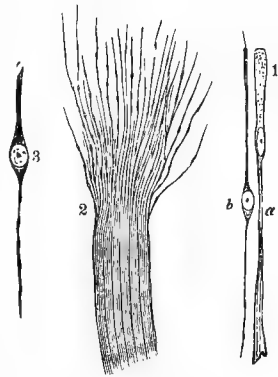

FIG. 464.—End-organs concerned in smell (after Kölliker). 1, from frog—*a*, epithelial cell of the olfactory area; *b*, olfactory cell. 2, small branch of olfactory nerve of frog, breaking up into a brush of varicose fibers. 3, olfactory cell of sheep.

fifth nerve. It is possible that the auditory nerve may also participate, though certainly not so as to produce a pure sensation of smell.

Like the other sense-organs, that of smell is readily fatigued; and perhaps the satisfaction from smelling a bouquet of mixed flowers is comparable to viewing the same, one scent after another being perceived, and no one remaining predominant.

Our judgment of the position of bodies possessing smell is less perfect even than for those emitting sounds; but we always project our sensations into the outer world, never referring the object to the nose itself. Subjective sensations of smell are rare in the normal subject, though common enough among the diseased, as is complete or partial loss of smell. It has been found that injury to the fifth nerve interferes with smell, which is probably due to trophic changes in the olfactory region.

Comparative.—The investigation of the senses in the lower forms of life is extremely difficult, and in the lowest presents almost insurmountable obstacles to the physiologist, because their psychic life is so far removed from our own in terms of which we must interpret, if at all.

The earliest form of olfactory organ appears to be a depression lined with special cells in connection with a nerve, which, indeed, suggests the embryonic beginnings of the olfactory organ in vertebrates, as an involution (pit) on the epithelium of the head region. It would appear that we must believe that in some of the lower forms of invertebrates the senses of smell and taste are blended, or possibly that a perception results which is totally different from anything known to us. The close relation of smell and taste, even in man, will be referred to presently. There are, perhaps, greater individual differences in sensitiveness of the nasal organ among mankind than of any other of the sense-organs. Women usually have a much keener perception of odors than men. The sense of smell in the dog is well known to be of extraordinary acuteness; but there are not only great differences among the various breeds of dogs, but among individuals of the same breeds; and this sense is being constantly improved by a process of "artificial selection" on the part of man, owing to the institution of field trials for setters and pointers, the best dogs for hunting (largely determined by the sense of smell) being used to breed from, to the exclusion of the inferior in great part. Our own power to think in terms of smell is very feeble, and in this respect the

dog and kindred animals probably have a world of their own to no small extent. Their memory of smells is also immeasurably better than our own. A dog has been known to detect an old hat, the property of his master, that had been given away two years before, as evidenced by his recovering it from a remote place.

The importance of smell as a guide in the selection of food, in detecting the presence of prey or of enemies, etc., is very obvious. By culture some persons have learned to distinguish individuals by smell alone, like the dog, though to a less degree.

THE SENSE OF TASTE.

The tongue is provided with peculiar modifications of epithelial cells, etc., known as papillæ and taste-buds which may be regarded as the end-organs of the glosso-pharyngeal and lingual nerves; though that these all, especially the taste-buds, are concerned with taste alone, seems more than doubtful. In certain animals with rough tongues, the papillæ, certain of them at least, answer to the hairs of a brush for the cleansing and general preservation of the coat of the animal in good condition. We may, perhaps, speak of certain fundamental taste-perceptions, such as *sweet*, *bitter*, *acid*, and *saline*. Certainly the natural power of gustatory discrimination is considerable; and, as in the case of tea-tasters, capable of extraordinary cultivation. All parts of the tongue are not equally sensitive, nor is taste-sensation confined entirely to the tongue. It can be shown that the back edges and tip of the tongue, the soft palate, the anterior pillars of the fauces, and a limited portion of the back part of the hard palate, are concerned in tasting. Making allowances for individual differences, it may be said that the back of the tongue appreciates best bitter substances, the tip, sweet ones, and the edges acids.

If any substance with a decided taste be placed upon the tongue when wiped quite dry, it can not be tasted at all, showing that solution is essential.

If a piece of apple, another of potato, and a third of onion, be placed upon the tongue of a person blindfolded, and with the nostrils closed, he will not be able to distinguish them, showing that the senses of smell and of taste are related; or, perhaps, it may be said that much that we call tasting is in large part smelling. When the electrodes from a battery are

placed on the tongue, a sensation of taste is aroused, described differently by different persons; also when the tongue is quick-

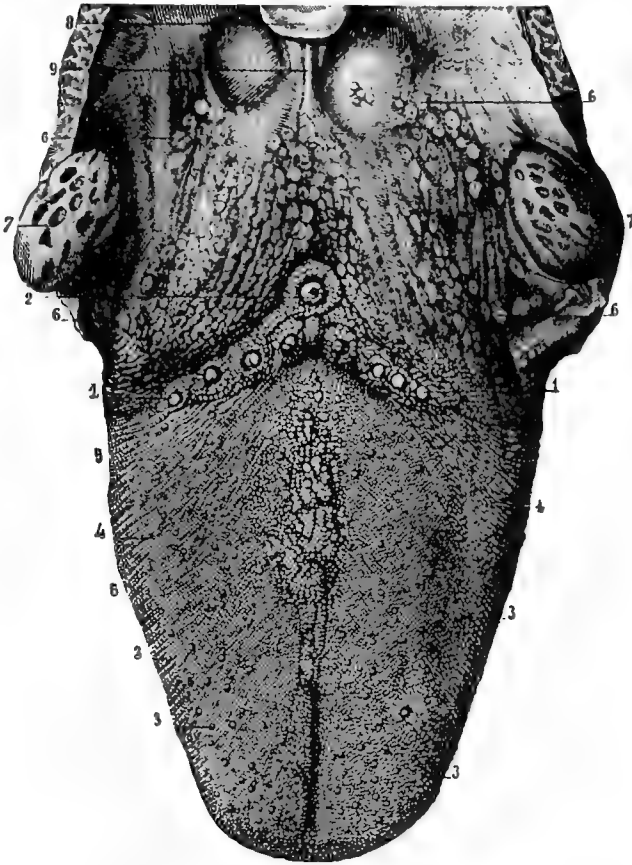

FIG. 465.—Papillæ of tongue (after Sappey). 1, circumvallate papillæ; 3, fungiform papillæ; 4, filiform papillæ; 6, glands at base of tongue; 7, tonsils.

ly tapped, showing that, though taste is usually the result of chemical stimulation, it may be excited by such as are electrical or mechanical.

But it is not to be forgotten that we have usually no pure gustatory sensations, but that these are necessarily blended with those of common sensation, temperature, etc., and that our judgments must, in the nature of the case, be based upon highly complex data, even leaving out of account other senses such as vision.

The glosso-pharyngeal is the principal nerve for the back of the tongue, and for the tip, the lingual; or according to some special fibers in this nerve, derived from the chorda tympani.

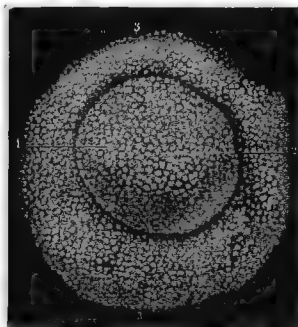

FIG. 466.

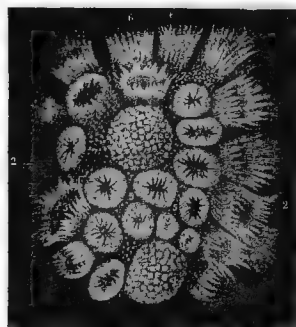

FIG. 467.

FIG. 466.—Medium-sized circumvallate papilla (after Sappey).

FIG. 467.—Various kinds of papillæ (after Sappey). 1, fungiform; 2, 3, 4, 5, 6, filiform; 7, hemispherical papillæ.

It is worthy of note that temperature has much to do with gustatory sensations, a very low or a very high temperature being fatal to nice discrimination, and, as would be expected, a

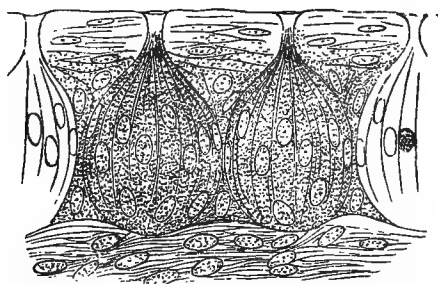

FIG. 468.—Taste-buds, from tongue of rabbit (after Engelmann).

temperature not far removed from "body-heat" (40° C.) is the most suitable.

A certain amount of pressure is favorable to tasting, as any one may easily determine by simply allowing some solution of quinine to rest on the tongue, and comparing the sensation with that resulting when the same is rubbed into the organ; hence the importance of the movements of the tongue in appreciating the sapid qualities of food.

Pathological.—Among insane persons both olfactory and

gustatory subjective sensations are common, and must be referred to the central nervous system.

After the injection of some drugs subcutaneously, certain tastes are experienced. Persons born deficient in the sense of smell to a marked degree are very frequently also wanting in tasting power.

Comparative.—Among the lowest forms of life it is extremely difficult to determine to what extent taste and smell exist separately or at all, as we can conceive of them. The differentiation between ordinary tactile sensibility and these senses has no doubt been very gradually effected. Observations on our domestic animals show that their power of discrimination by taste as well as by smell is very pronounced, though their likes and dislikes are so different from our own in many instances. At the same time we find that they often coincide, and it is not unlikely that a dog's power of discriminating between a good beefsteak and a poor one is quite equal if not superior to man's, and certainly so if his sense of taste, as in the human subject, is developed in proportion to his smelling power.

THE CEREBRO-SPINAL SYSTEM OF NERVES.

I. SPINAL NERVES.

These (thirty-one pairs), which leave the spinal cord through the intervertebral foramina, are mixed nerves—i. e., their main trunks consist of motor and sensory fibers. But before they enter the spinal cord they separate into two groups, which are

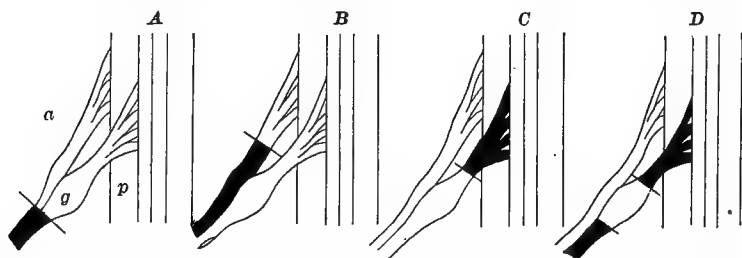

FIG. 469.—Diagram of roots of spinal nerve illustrating effects of section (after Dalton). The dark regions indicate the degenerated parts.

known as the anterior or motor and the posterior or sensory roots, which make connection with the anterior and posterior gray horns respectively.

These facts have been established by a few simple but important physiological experiments, which will now be briefly described: 1. Stimulation of the peripheral end of a spinal nerve gives rise to muscular movements; while stimulation of its central end causes pain. 2. Upon section of the anterior root, stimulation of its central end gives negative results; but of its peripheral end causes muscular movements. 3. After section of the posterior root, stimulation of the distal end is followed by no sensory or motor effects; of its central end, by sensory effects (pain).

These experiments show clearly that the anterior roots are motor, the posterior sensory, and the main trunk of the nerve made up of mixed motor and sensory fibers.

Exception.—It has been found that sometimes stimulation of the peripheral end of the anterior root has given rise to pain, an effect which disappears if the posterior root be cut. From this it is inferred that certain sensory fibers turn up into the anterior root a certain distance. Such are termed “recurrent sensory fibers.”

Additional Experiments.—1. It is found that if the anterior root be cut, the fibers below the point of section degenerate, while those above it do not. 2. On the other hand, when the posterior root is divided above the ganglion, the fibers toward the cord degenerate, while those on either side of the ganglion do not. From these experiments it is inferred that the cells of the posterior ganglion are essential to the nutrition of the sensory fibers, and those of the anterior horn of the cord to the motor fibers.

Pathological.—Pathology teaches the same lesson, for it is observed that, when there is disease of the anterior gray cornua, degeneration of motor fibers is almost sure to follow. These cells, whether in the ganglion or the anterior horn, have been termed “trophic.” It is true, the functions of the ganglia on the posterior roots, other than those just indicated, are unknown; on the other hand, the cells of the anterior horn are distinctly motor in function. To assume, then, that the cells of the ganglion are exclusively trophic, with the evidence now before us, would be premature.

The view we have presented of the relation of the nervous system makes all cells trophic in a certain sense; and we think the view that certain cells or certain fibers are exclusively trophic must, as yet, be regarded as an open question.

It is important, however, to recognize that certain connec-

tions between the parts of the nervous system, and indeed all of the tissues, are essential for perfect "nutrition," if we are to continue the use of that term at all.

II. THE CRANIAL NERVES.

These nerves have been divided into nerves of special sense, motor, and mixed nerves.

The first class has already been considered with the senses to which they belong.

The physiology of the cranial nerves has been worked out by means of sections and clinico-pathological investigations. Speaking generally, a good knowledge of the anatomy of these nerves is a great step toward the mastery of what is known of their functions, and such will be assumed in this chapter, so that the student may expect to find the treatment of the subject somewhat condensed.

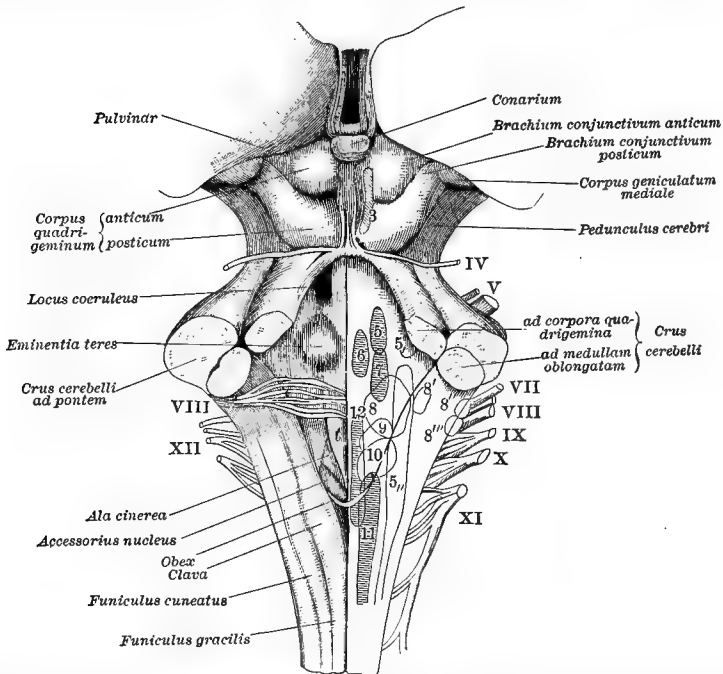

FIG. 470.—Intended to show especially the origin both deep and superficial of cranial nerves (after Landois). Roman characters are used to indicate the nerves as they emerge, and Arabic figures their nuclei or deep origin.

The Motor-Oculi or Third Nerve.—With a deep origin in the gray matter of the floor and roof of the aqueduct of Sylvius,

branches of distribution pass to the following muscles: 1. All of the muscles attached to the eyeball, with exception of the external rectus and the superior oblique. 2. The levator palpebræ. 3. The circular muscle of the iris. 4. The ciliary muscle. Both the latter branches reach the muscles by the ciliary nerves, as they pass from the lenticular (ciliary, ophthalmic) ganglion. The relation of the third nerve, as seen in the changes of the pupil with the movements of the eyeballs, has already been noticed.

Pathological.—It follows that section or lesion of the third nerve must give rise to the following symptoms: 1. Drooping of the upper lid (ptosis). 2. Fixed position of the eye in the outer angle of the orbit (lucitas). 3. Immobility, with dilatation of the pupil (mydriasis). 4. Loss of accommodation.

The Trochlear or Fourth Nerve.—This nerve, arising in the aqueduct of Sylvius, passes to the superior oblique muscle.

Pathological.—Lesion of this nerve leads to peculiar changes. As there is double vision, some alteration must have occurred in the usual position of the globe of the eye, though this is not easily seen on looking at a subject thus affected. The double image appears when the eyes are directed downward, and appears oblique and lower than that seen by the unaffected eye.

The Abductor or Sixth Nerve.—Arising on the floor of the fourth ventricle, it passes to the external rectus of the eyeball, thus with the third and fourth nerve completing the innervation of the external ocular muscles (extrinsic muscles).

Pathological.—Lesion of this nerve causes paralysis of the above-mentioned muscle, and consequently internal squint (strabismus).

The Facial, Portia Dura, or Seventh Nerve.—It arises in a gray nucleus in the floor of the fourth ventricle, and has an extensive distribution to the muscles of the face, and may be regarded, in fact, as the nerve of the facial muscles, since it supplies, (1) the *muscles of expression*, as those of the forehead, eyelids, nose, cheek, mouth, chin, outer ear, etc., and (2) certain *muscles of mastication*, as the buccinator, posterior belly of the digastric, the stylohyoid, and also (3) to the *stapedius*, with branches to the soft palate and uvula.

Pathological.—It follows that paralysis of this nerve must give rise to marked facial distortion, loss of expression, and flattening of the features, as well as possibly some deficiency in hearing, smelling, and swallowing. Mastication is difficult,

and the food not readily retained in the mouth. Speech is affected from paralysis of the lips, etc.

Secretory fibers proceed (1) to the parotid gland by the superficial petrosal nerve, thence (2) to the otic ganglion, from which the fibers pass by the auriculo-temporal nerve to the gland.

Gustatory Fibers.—According to some, the chorda tympani really supplies the fibers to the lingual nerve that are concerned with taste.

It will thus be seen that the facial nerve has a great variety of important functions, and that paralysis may be more or less serious, according to the number of fibers involved.

The Trigeminal, Trifacial, or Fifth Nerve.—This nerve has very extensive functions. It is *the* sensory nerve of the face; but, as will be seen, it is peculiar, being a combination of the motor and sensory, or, in other words, has paths for both afferent and efferent impulses. The motor and less extensive division arises from a nucleus in the floor of the fourth ventricle. The sensory, much the larger, seems to have a very wide origin. The nerve-fibers may be traced from the pons Varolii through the medulla oblongata to the lower boundary of the olivary body and to the posterior horn of the spinal cord. This origin suggests a resemblance to a spinal nerve, the motor root corresponding to the anterior, and the sensory to a posterior root, the more so as there is a large ganglion connected with the sensory part of the nerve within the brain-case.

Efferent Fibers.—1. *Motor.*—To certain muscles (1) of mastication—temporal, masseter, pterygoid, mylohyoid, and the anterior part of the digastric. 2. *Secretory.*—To the lachrymal gland of the ophthalmic division of this nerve. 3. *Vaso-motor.*—Probably to the ocular vessels, those of the mucous membrane of the cheek and gums, etc. 4. *Trophic.*—From the results ensuing on section of this nerve, it has been maintained that it contains special trophic fibers. We have discussed this subject in an earlier chapter.

Afferent Fibers.—1. *Sensory.*—To the entire face. To particularize regions: 1. The whole of the skin of the face and that of the anterior surface of the external ear. 2. The external auditory meatus. 3. The mucous lining of the cheeks, the floor of the mouth, and the anterior region of the tongue. 4. The teeth and periosteum of the jaws. 5. The lining membrane of the entire nasal cavity. 6. The conjunctiva, globe of the eye, and orbit. 7. The dura mater throughout.

Many of these afferent fibers are, of course, intimately con-

cerned with reflexes, as sneezing, winking, etc. Certain secretory acts are often excited through this nerve, as lachrymation,

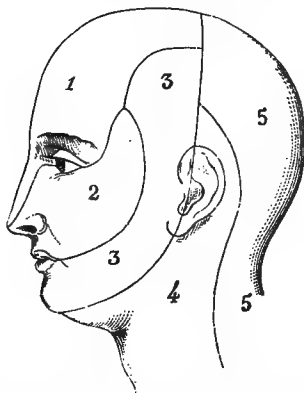

FIG. 471.—Limits of cutaneous distribution of sensory nerves to face, head, and neck (after Bécclard). 1, cutaneous distribution of ophthalmic division of fifth nerve; 2, of superior maxillary division; 3, 3, of inferior maxillary; 4, of anterior branches of cervical nerves; 5, 5, of posterior branches of cervical nerves.

when the nasal mucous membrane is stimulated; indeed, the paths for afferent impulses giving rise to reflexes, including secretion, are very numerous.

Gustatory impulses from the anterior end and lateral edges of the tongue are conveyed by the lingual (gustatory) branch of this nerve. Many are of opinion, however, that the fibers of the chorda tympani, which afterward leave the lingual to unite with the facial nerve, alone convey such impressions. The subject can not be regarded as quite settled. Tactile sensibility in the tongue is very pronounced, as we have all experienced when a tooth, etc., has for some reason presented an unusual surface quality, and become a source of constant offense to the tongue.

The ganglia of the fifth nerve, so far as the functions of their cells are concerned, are enigmatical at present. They are doubtless in some sense trophic at least. With each of these are nerve connections ("roots" of the ganglia), which seem to contain different kinds of fibers. These ganglia are connected with the main nerve-centers by both afferent and efferent nerves, and also with the sympathetic nerves themselves. Some regard the ganglia as the representatives of the sympathetic system within the cranium.

I. *The Ciliary (Ophthalmic, Lenticular) Ganglion.*—Its three roots are: 1. From the branch of the third nerve to the inferior

oblique muscle (motor root). 2. From the nasal branch of the ophthalmic division of the fifth. 3. From the carotid plexus of the sympathetic. The efferent branches pass to the iris, are derived chiefly from the sympathetic, and cause dilatation of the pupil. There are also vaso-motor fibers to the choroid, iris, and retina. The afferent fibers are sensory, passing from the conjunctiva, cornea, etc.

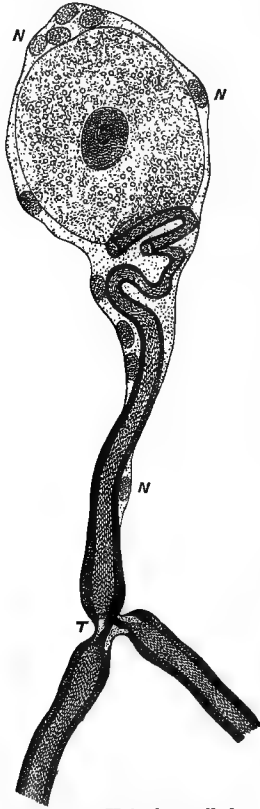

FIG. 472. — Unipolar cell from Gasserian ganglion (after Schwalbe). *N, N, N*, nuclei of sheath; *T*, fiber branching at a node of Ranvier.

II. *The Nasal or Spheno-Palatine Ganglion.*—The motor root is derived from the facial through the great superficial petrosal nerve; its sympathetic root from the carotid plexus. Both together constitute the vidian nerve. It would seem that afferent impulses from the nasal chambers pass through this ganglion. The efferent paths are: 1. Motor to the levator palati and asygos uvulæ. 2. Vaso-motor, derived from the sympathetic. 3. Secretory to the glands of the cheek, etc.

III. *The Otic Ganglion.*—Its roots are: 1. Motor, from the third division. 2. Sensory, from the inferior division of the fifth. 3. Sympathetic, from the plexus around the meningeal artery. It makes communication with the chorda tympani and seventh, and supplies the parotid gland with some fine filaments. Motor fibers mixed with sensory ones pass to the tensor tympani and tensor palati.

IV. *The Submaxillary Ganglion.*—Its roots are: 1. Branches of the chorda tympani, from which pass (*a*) secretory fibers to the submaxillary and sublingual glands, (*b*) vaso-motor (dilator) fibers to the vessels of the same glands. 2. The *sympathetic*, derived from the superior cervical ganglion, passing to the submaxillary gland. It is also thought to be the path of vaso-constrictor fibers to the gland. 3. The sensory, from the lingual nerve, supplying the gland substance, its ducts, etc.

Pathological.—1. The motor division of the nerve, when the medium of efferent impulses, owing to central disorder, may

cause trismus (locked-jaw) from *tonic* tetanic action of the muscles of mastication supplied by this nerve. 2. Paralysis of the same muscles may ensue from degeneration of the motor nuclei or pressure on the nerve in its course. 3. Neuralgia of any of the sensory branches may occur from a great variety of causes, and often maps out very exactly the course and distribution of the branches of the nerve. 4. Vaso-motor disturbances are not infrequently associated with neuralgia. Blushing is an evidence of the normal action of the vaso-motor fibers of the fifth nerve. 5. A variety of trophic (metabolic) disturbances may arise from disorder of this nerve, its nuclei of origin or its ganglia, such as grayness and loss of hair (imperfect nutrition), eruptions of the skin along the course of the nerves, etc. Atrophy of the face, on one or both sides, gradual and progressive, may occur. Such affections, as well as others, point in the most forcible manner to the influence of the nervous system over the metabolism of the body.

The Glosso-pharyngeal or Ninth Nerve.—This nerve, together with the vagus and spinal accessory, constitutes the eighth pair, or rather trio. Functionally, however, they are quite distinct.

The glosso-pharyngeal arises in the floor of the fourth ventricle above the nucleus for the vagus. It is a mixed nerve with efferent and afferent fibers: 1. *Efferent fibers*, furnishing motor fibers to the middle constrictor of the pharynx, stylo-pharyngeus, levator palati, and asygos uvulæ. 2. *Afferent fibers*, which are the paths of sensory impulses from the base of the tongue, the soft palate, the tonsils, the Eustachian tube, tympanum, and anterior portion of the epiglottis. Stimulation of the regions just mentioned gives rise reflexly to the movements of swallowing and to reflex secretion of saliva.

This nerve is also the special nerve of taste to the back of the tongue.

The Pneumogastric, Vagus, or Tenth Nerve.—Most of the functions of this nerve have already been considered in previous chapters.

In some of the lower vertebrates (sharks) the nerve arises by a series of distinct roots, some of which remain separate throughout. This fact explains its peculiarities, anatomical and functional, in the higher vertebrates. In these there have been concentration and blending, so that what seems to be one nerve is really made up of several distinct bundles of fibers, many of which leave the main trunk later.

It may be regarded as the *most* complicated nerve-trunk in the body, and the distribution of its fibers is of the most extensive character. Following our classification of efferent and afferent, we recognize:

1. *Efferent fibers*, which are *motor* to an extensive tract in the respiratory and alimentary regions.

Thus the constrictors of the pharynx, certain muscles of the palate, the œsophagus, the stomach, and the intestine, receive an abundant supply from this source. By the laryngeal nerves, probably derived originally from the spinal accessory, the muscles of the larynx are innervated. The muscles of the trachea, bronchi, etc., are also supplied by the pneumogastric. It is probable that *vaso-motor* fibers derived from the sympathetic run in branches of the vagus. The relations of this nerve to the heart and lungs have already been explained.

2. *Afferent Fibers*.—It may be said that afferent impulses from all the regions to which efferent fibers are supplied pass inward by the vagus. One of the widest tracts in the body for afferent impulses giving rise to reflexes is connected with the nerve-centers by the branches of this nerve, as evidenced by the many well-known phenomena of this character referable to the pharynx, larynx, lungs, stomach, etc., as vomiting, sneezing, coughing, etc. This nerve plays some important part in secretion, no doubt, but what that is has not been as yet well established.

Pathological.—Section of both vagi, as might be expected, leads to death, which may take place from a combination of pathological changes, the factors in which vary a good deal with the class of animals the subject of experiment. Thus, the heart in some animals (dog) beats with great rapidity and tends to exhaust itself. In birds especially is fatty degeneration of heart, stomach, intestines, etc., liable to follow.

Paralysis of the muscles of the larynx renders breathing laborious. From loss of sensibility food accumulates in the pharynx and finds its way into the larynx, favoring, if not actually exciting, inflammation of the air-passages.

But it is not to be forgotten that upon the views we advocate as to the constant influence of the nervous system over all parts of the bodily metabolism, it is plain that after section of the trunk of a nerve with fibers of such wide distribution and varied functions the most profound changes in so-called nutrition must be expected, as well as the more obvious functional derangements; or, to put it otherwise, the results that

follow are in themselves evidence of the strongest kind for the doctrine of a constant neuro-metabolic influence which we advocate. It will not be forgotten that the depressor nerve, which exerts reflexly so important an influence over blood-pressure, is itself derived from the vagus.

The Spinal Accessory or Eleventh Nerve.—This nerve arises from the medulla oblongata somewhat far back, and from the spinal cord in the region of the fifth to the seventh vertebra. Leaving the lateral columns, its fibers run upward between the denticulate ligament and the posterior roots of the spinal nerve to enter the cranial cavity, which as they issue from the cranium subdivide into two bundles, one of which unites with the vagus, while the other pursues an independent course to reach the sterno-mastoid and trapezius muscles, to which they furnish the motor supply; so that it may be considered functionally equivalent to the anterior root of a spinal nerve. The portion joining the vagus seems to supply a large part of the motor fibers of that nerve.

Pathological.—Tonic contraction of the flexors of the head causes wry-neck, and when they are paralyzed the head is drawn to the sound side.

The Hypoglossal or Twelfth Nerve.—It arises from the lowest part of the calamus scriptorius and perhaps from the olivary body. The manner of its emergence between the anterior pyramid and the olivary body, on a line with the anterior spinal roots, suggests that it corresponds to the latter; the more so as it is motor in function, though also containing some vasomotor fibers, in all probability destined for the tongue. Such sensory fibers as it may contain are derived from other sources (vagus, trigeminus). It supplies motor fibers to the tongue and the muscles, attached to the hyoid bone.

Pathological.—Unilateral section of the nerve gives rise to a corresponding lingual paralysis, so that when the tongue is protruded it points to the injured side; when being drawn in, the reverse. Speech, singing, deglutition, and taste may also be abnormal, owing to the subject being unable to make the usual co-ordinated movements of the tongue essential for these acts.

RELATIONS OF THE CEREBRO-SPINAL AND SYMPATHETIC SYSTEMS.

No division of the nervous system has been so unsatisfactory, because so out of relation with other parts, as the sympathetic. It was also desirable to attempt to co-ordinate the cerebral and spinal nerves in a better fashion; and various attempts in that direction have been made. Very recently a plan, by which the whole of the nerves issuing from the brain and cord may be brought into a unity of conception, has been proposed; and, though it would be premature to pronounce definitely as yet upon the scheme, yet it does seem to be worth while to lay it before the student, as at all events better than the isolation implied in the three divisions of the nerves which has been taught hitherto.

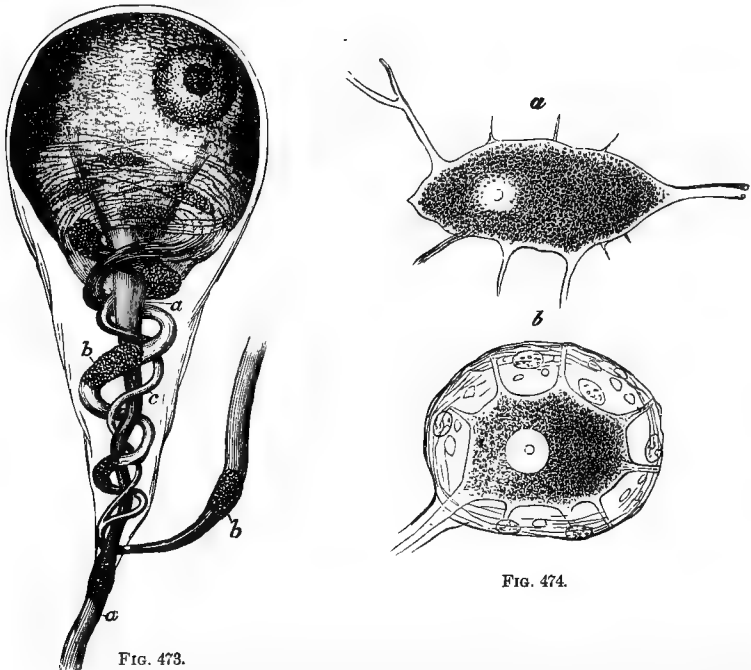

FIG. 473.

FIG. 473.—Ganglion cell from sympathetic ganglion of frog; greatly magnified, and showing both straight and coiled fibers (after Quain).

FIG. 474.—Multipolar ganglion cells from sympathetic system of man, highly magnified (after Max Schultze). *a*, cell freed from capsule; *b*, inclosed within a nucleated capsule. In both the processes have been broken away.

Instead of the classification of nerves into efferent and afferent, connected with the anterior and the posterior horns

of the gray matter of the spinal cord, another division has been proposed, viz., a division of nerve-fibers and their centers of origin in the gray matter for the supply of the internal and the external parts of the body—i. e., into splanchnic and somatic nerves. The centers of origin of the splanchnic nerves are referred to groups of cells in the gray matter of the cord around the central canal; while the somatic nerves spring from the gray cornua and supply the integument and the ordinary muscles of locomotion, etc. The splanchnic nerves supply certain muscles of respiration and deglutition, derived from the embryonic lateral plates of the mesoblast; the somatic nerves, muscles formed from the muscle-plates of the same region.

It is assumed that the segmentation of the vertebrate and invertebrate animal is related; and that segmentation is preserved in the cranial region of the vertebrate, as shown by the nerves themselves.

The afferent fibers of both splanchnic and somatic nerves pass into the spinal ganglion, situated in the nerve-root, which may be regarded as stationary.

It is different with the anterior roots. Some of the fibers are not connected with ganglia at all; others with ganglia not fixed in position, but occurring at variable distances from the central nervous system (these being the so-called sympathetic ganglia): thus, the anterior root-fibers are divisible into two groups, both of which are efferent, viz., ganglionated and non-ganglionated. The ganglionated belong to the splanchnic system, and have relatively small fibers; the non-ganglionated includes both somatic and splanchnic nerves, composing the ordinary nerve-fibers of the voluntary striped muscles of respiration, deglutition, and locomotion.

It would appear that these now isolated ganglia have been themselves derived from a primitive ganglion mass situated on the spinal nerves; so that the distinction usually made of ganglionated and non-ganglionated roots is not fundamental.

A spinal nerve is, then, formed of—1. A posterior root, the ganglion of which is stationary in position, and connected with splanchnic and somatic nerves, both of which are afferent. 2. An anterior root, the ganglion of which is vagrant, and connected with the efferent small-fibered splanchnic nerves.

Among the lower vertebrates both anterior and posterior roots pass into the same stationary ganglion. Such is also the case in the first two cervical nerves of the dog.

Does the above-mentioned plan of distribution, etc., hold for the cranial nerves ?

Leaving out the nerves of special sense (olfactory, optic, and auditory), the other cranial nerves may be thus divided : 1. A foremost group of nerves, wholly efferent in man, viz., the third, fourth, motor division of the fifth, the sixth, and seventh. 2. A hindmost group of nerves of mixed character, viz., the ninth, tenth, eleventh, and twelfth.

The nerves of the first group, since they have both large-fibered, non-ganglionated motor nerves, and also small-fibered splanchnic efferent nerves, with vagrant ganglia (ganglion oculomotorii, ganglion geniculatum, etc.), resemble a spinal nerve in respect to their anterior roots. They also resemble spinal nerves as to their posterior roots, for at their exit from the brain they pass a ganglion corresponding to the stationary posterior ganglion of the posterior root of a spinal nerve. These being, however, neither in roots nor ganglion functional, are to be regarded as the phylogenetically (ancestrally) degenerated remnants of what were once functional ganglia and nerve-fibers ; in other words, the afferent roots of these nerves and their ganglia have degenerated.

The hindmost group of cranial nerves also answers to the spinal nerves. They arise from nuclei of origin in the medulla and in the cervical region of the spinal cord, directly continuous with corresponding groups of nerve-cells in other parts of the spinal cord ; but in these nerves there is a scattering of the components of the corresponding spinal nerves. Certain peculiarities of these cranial nerves seem to become clearer if it be assumed that, in the development of the vertebrate, degeneration of some region once functional has occurred, in consequence of which certain portions of nerves, etc., have disappeared or become functionless.

It is also to be remembered that a double segmentation exists in the body, viz., a somatic, represented by vertebræ and their related muscles, and a splanchnic represented by visceral and branchial clefts, and that these two have not followed the same lines of development ; so that in comparing spinal nerves arranged in regard to somatic segments with cranial nerves, the relations of the latter to the somatic muscles of the head must be considered ; in other words, like must be compared with like.

THE VOICE AND SPEECH.

It is convenient to speak of the singing voice and the speaking voice, though there is no fundamental difference in their production.

Since musical tones can be produced by instruments greatly resembling those of the human voice, it becomes evident that in explaining the human voice we must take large account of the principles of physics.

It is to be remembered that sound is to us an affection of the nervous centers through the ear, as the result of aërial vibrations.

We are now to explain how such vibrations are caused by the vocal mechanisms of animals and especially of man.

The tones of a piano or violin are demonstrably due to the vibrations of their strings; of a clarionet to the vibration of its reed. But, however musical tones may be produced, we distinguish in them differences in pitch, quantity, and quality.

The pitch is dependent solely upon the number of vibrations within a given time as one second; the quantity or loudness upon the amplitude of the vibrations, and the quality upon the form of the vibrations. The first two scarcely require any further notice; but it is rather important for our purpose to understand clearly the nature of quality or timbre, which is a more complex matter.

If a note be sounded near an open piano, it may be observed that not only the string capable of giving out the corresponding note passes into feeble vibration, but that several others also respond. These latter produce the over-tones or partials which enter into notes and determine the quality by which one instrument or one voice differs from another. In other words, every tone is in reality compound, being composed of a fundamental tone and overtones. These vary in number and in relative strength with each form of instrument and each voice; and it is now customary to explain the differences in quality of voices solely in this way; and this is, no doubt, correct in the main; but when two individuals, using successively the same violin, play a scale nearly equal in loudness and as much alike in all respects as possible, are we to explain our ability to discriminate when the one or the other may be playing (out of our sight) solely by the overtones? To answer this would lead us into very complex considerations, and we only raise the

question to keep the mind of the student open to new or possible additional factors in the explanation.

What are the mechanisms by which voice is produced in man? Observation proves that the following are essential: 1. A certain amount of tension of the vocal cords (bands). 2. A certain degree of approximation of their edges. 3. An expiratory blast of air.

It will be noted that these are all conditions favorable to the vibration of the vocal bands. The greater the tension the higher the pitch; and the more occluded the glottic orifice the more effective the expiratory blast of air.

The principle on which the vocal bands act may be illustrated in the simplest way by a well-known toy, consisting of an elastic bag tied upon a hollow stem of wood, across which rubber bands are stretched, and the vibration of which caused by the air within the distended bag gives rise to the note. The student who would really understand the mechanism of voice-production in man, should not only acquire a thorough knowledge of the anatomy of the larynx, especially of its muscles and their individual action, but by means of the laryngoscope become familiar with the appearances of the glottis and adjacent parts during phonation. The latter is not difficult, and auto-laryngoscopy or self-examination

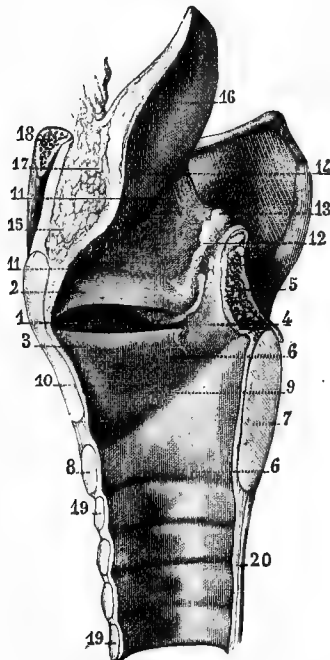

FIG. 475.—Longitudinal section of human larynx (after Sappey). 1, ventricle of larynx; 2, superior vocal cord; 3, inferior vocal cord; 4, arytenoid cartilage; 5, section of arytenoid muscle; 6, 6, inferior portion of cavity of larynx; 7, section of posterior part of cricoid cartilage; 8, section of anterior part of same; 9, superior border of cricoid cartilage; 10, section of thyroid cartilage; 11, 11, superior portion of cavity of larynx; 12, 13, arytenoid gland; 14, 16, epiglottis; 15, 17, adipose tissue; 18, section of hyoid bone; 19, 19, 20, trachea.

may be made instructive beyond what can be indicated in any text-book.

In order to acquire a knowledge of the human larynx, we recommend the dissection of the larynx of a pig, this being more like the organ of man than is that of the sheep or most other animals. It is especially important to recognize the nature, extent, and effect on the vocal bands of the movements of

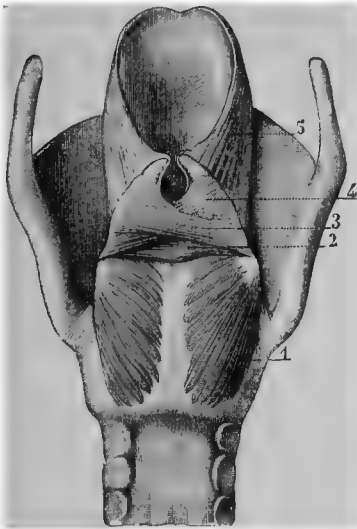

FIG. 476.

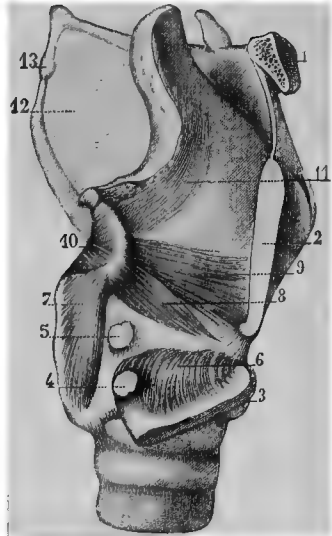

FIG. 477.

FIG. 476.—Posterior aspect of muscles of human larynx (after Sappey). 1, posterior crico-arytenoid muscle; 2, 3, 4, different fasciculi of arytenoid muscle; 5, aryteno-epiglottidean muscle.

FIG. 477.—Lateral view of laryngeal muscles (after Sappey). 1, body of hyoid bone; 2, vertical section of thyroid cartilage; 3, horizontal section of thyroid cartilage, turned downward to show deep attachment of crico-thyroid muscle; 4, facet of the articulation of small cornu of thyroid cartilage with cricoid cartilage; 5, facet on cricoid cartilage; 6, superior attachment of crico-thyroid muscle; 7, posterior crico-arytenoid muscle; 8, lateral crico-arytenoid muscle; 9, thyro-arytenoid muscle; 10, arytenoid muscle proper; 11, aryteno-epiglottidean muscle; 12, middle thyro-hyoid ligament; 13, lateral thyro-hyoid ligament.

the arytenoid cartilages. These are most marked around a vertical axis, giving rise to an inward and outward movement of rotation, but there are also movements of less extent in all directions. It is in fact through the movements of these cartilages to which the vocal bands are attached posteriorly, that most of the important changes in the tension, approximation, etc., of the latter are produced. The lungs are to be regarded as the bellows furnishing the necessary wind-power to set the vocal bands vibrating, while the larynx has respiratory as well as vocal functions, as has been already learned. Assuming that the student has a good knowledge of the

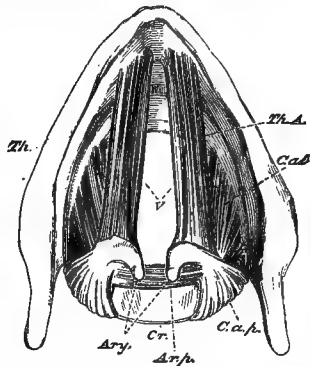

FIG. 478.—Larynx, viewed from above, on partial dissection (after Huxley). *Th.*, thyroid cartilage; *Cr.*, cricoid cartilage; *V.*, edges of vocal ligaments bounding glottis; *Ary.*, arytenoid cartilages; *Th.A.*, thyro-arytenoid muscle; *C.a.l.*, lateral crico-arytenoid muscle; *C.a.p.*, posterior crico-arytenoid muscle; *Ar.p.*, posterior arytenoid muscles.

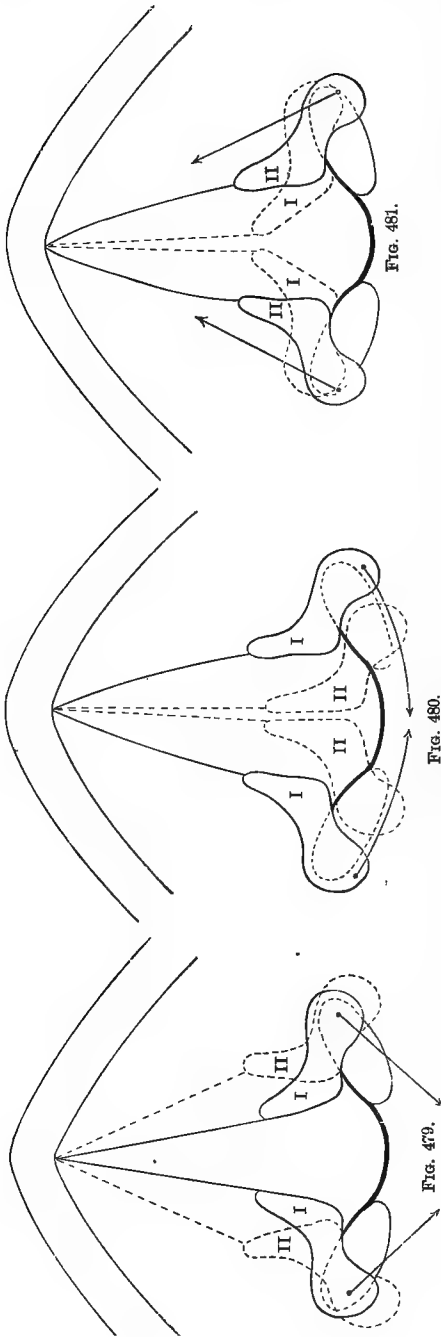

FIG. 479.—Diagrammatic section of larynx to illustrate action of posterior crico-arytenoid muscle (after Landois). In this and the two following figures the dotted lines indicate the new position of the parts owing to the action of the muscles concerned.
 FIG. 480.—Diagrammatic section of larynx to illustrate action of arytenoideus proprius muscle (after Landois).
 FIG. 481.—Illustrates action of thyro-arytenoideus internus.

general anatomy of the larynx, we call attention briefly to the following:

Widening of the glottis is effected by the *crico-arytenoideus posticus* pulling outward the processus vocalis or attachment posteriorly of the vocal band, and a similar effect is produced by the *arytenoideus posticus* acting alone.

Narrowing of the glottis is accomplished by the *crico-arytenoideus lateralis*, and the following when acting either singly (except the *arytenoideus posticus*), or in concert, as the sphincter of the larynx, viz., the *thyro-arytenoideus externus*, *thyro-arytenoideus internus*, *thyro-aryepiglotticus*, *arytenoideus posticus*.

Tension of the vocal bands is brought about by the sphincter group, and especially by the external and internal thyro-arytenoid muscles.

Nerve Supply.—The *superior laryn-*

geal contains the motor fibers for the crico-thyroid (possibly also the arytеноideus posticus) and also supplies the mucous membrane. The *inferior laryngeal* supplies all the other muscles. While both of these nerves are derived from the vagus, their fibers really belong to the spinal accessory. It is worthy of note that the entire group of muscles making up the sphincter of the larynx is contracted when the inferior laryngeal is stimulated.

Above the true vocal bands lie the so-called false vocal bands (cords) which take no essential part in voice-production. Between these two pairs of bands are the *ventricles of Morgagni*, which, as well as the adjacent parts, secrete mucus and allow of the movements of both sets of bands and in so far only assist in phonation.

What is the nature of the nervous connections by which the muscular movements necessary for voice-production is accomplished. They are certainly more complex in nature, at least in all their highest manifestations, than might at first appear.

Volition is unquestionably the starting-point, but the result is modified by a great variety of afferent impulses, including those from the larynx and supra-laryngeal cavities, the thorax, lungs, even the ear, and possibly the eye. Muscular co-ordinations of the most delicate kind must be effected, seeing the fine shades in pitch and quality which a first-rate singer can produce.

To watch, with the laryngoscope, these changes in the vocal bands alone, gives one an idea of the complexity and perfection of such adjustments which no verbal description can convey. It is impossible for a deaf man, or one defective in sensibility in the regions concerned in phonation, to produce good musical tones. No doubt one born blind, and without those stored experiences derived from countless pictures, can but very imperfectly make adaptations in singing dependent on such experience; and one has only to hear deaf-mutes, who have learned to speak from imitation of the speech-movements of normal persons, to become convinced of how important a part the ear plays in vocalization. The efforts of such persons nearly always seem to be out of harmony with the surroundings.

There are many subjects connected with the production of the singing-voice especially which have been matters of animated controversy, chiefly because investigators have restricted their observations to an unduly limited range of facts.

The whole of the supra-laryngeal cavities, the trachea and bronchial tubes, may be regarded as resonance-chambers, the former of which are of the most importance, so far as the quality of the voice is concerned. There seems to be little doubt that they have much to do with determining the differences by which one individual's voice at the same pitch differs from another; nor is the view that they may have a slight influence on the pitch of the voice, or even its intensity, to be ignored.

The epiglottis, in so far as it has any effect, in all probability modifies the voice in the direction of quality.

The range of any one voice in pitch is, of course, much less than what may be termed the human vocal limit—i. e., the range of the deepest, the intermediate, and the highest voices combined.

The following graphic representation will serve a good purpose. It will be observed that the extreme limits are tones of about eighty and one thousand vibrations per second, respectively.

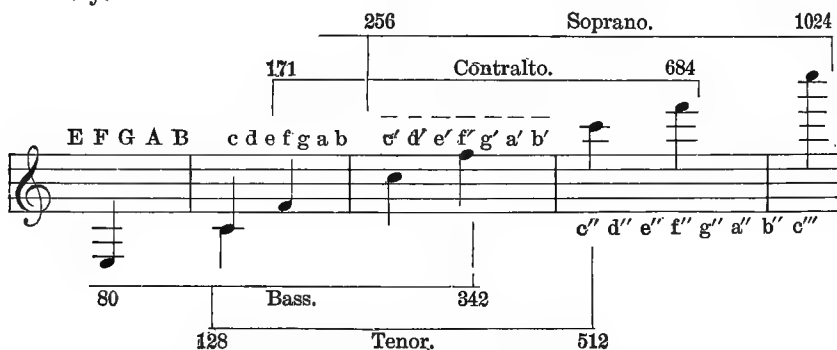

FIG. 482.—This figure illustrates the range of the different kinds of voices, and the number of vibrations answering to the compass of each. The limits here indicated are, of course, not absolute.

The Registers and the Falsetto-Voice.—Among points most disputed even yet are the registers and the falsetto-voice. The subject of registers turns upon the answer to the question, What is the natural method of producing tones? All admit that they may be sung with different vocal mechanisms, so to speak—i. e., that different persons, as a matter of fact, do not co-ordinate the various parts of the larynx in quite the same way. In attempting to settle a question of this character a good deal of difference in individuality must be allowed for; and, given equally effective results, viewed artistically, that

may be considered as the natural method of singing a certain range of notes which leads to the least expenditure of energy; and certain rules may be laid down for the average man, with, however, a good deal of latitude for special cases, as we have said. But certainly any method that disorders the larynx or

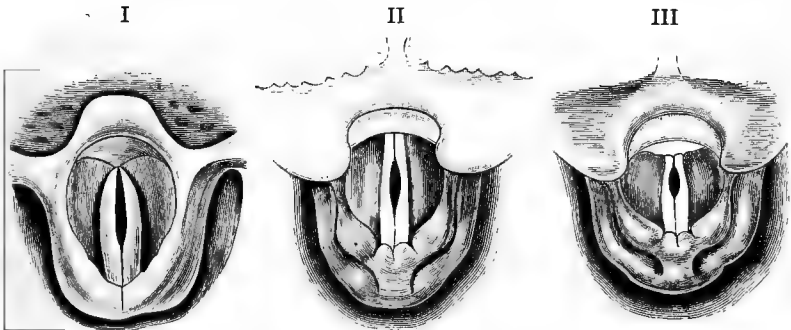

FIG. 483.—Laryngoscopic appearances during production of (I, II) falsetto-voice and (III) head-tones. I. Falsetto production (after Mandl). II. Falsetto production (after Holmes). III. Larynx of female during production of head-tones, as seen by the author.

the general health can not be correct. Hence clinical and pathological observations become of great importance. One of the commonest faults consists in persons, whose laryngeal mechanism does not permit of the necessary changes within the power of those specially endowed, using a method of voice-production for higher tones, which is really, in their case at least, adapted only to lower ones, hence straining, congestions, fatigue, catarrh, and a host of attendant evils.

It does not come within our province to treat of the artistic side of the question; but we may point out that nearly all the compositions of the greatest masters of music are written within a comparatively small range of notes; and when it is remembered that these are such as are most heard in the intercourse of daily life by the speaking-voice, or at least do not depart widely from them, we may understand how it is that such music has ever stirred, and does still appeal to, the heart (and ear) of man so generally, alike in the cultivated and uncultivated.

Attempts have been made to explain the *falsetto-voice* by the action of the vocal bands alone; but any one who will compare his sensations, his consciousness of altered muscular arrangement, and consequent changed relative position of parts in the supra-laryngeal cavities, even without the use of a laryngoscope at all, can not fail to perceive that the vocal

bands are not alone to be taken into account. But there can be no question of a very great difference in the behavior of the

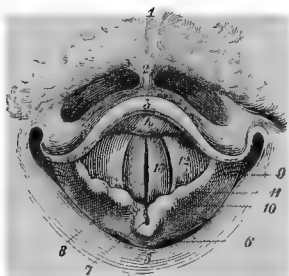

FIG. 484.

FIG. 484.—Laryngoscopic view of the glottis during emission of high-pitched notes (Le Bon). 1, 2, base of tongue; 3, 4, epiglottis; 5, 6, pharynx; 7, arytenoid cartilages; 8, opening between true vocal cords; 9, aryteno-epiglottidean folds; 10, cartilage of Santorini; 11, cuneiform cartilage; 12, superior vocal cords; 13, inferior vocal cords (bands).

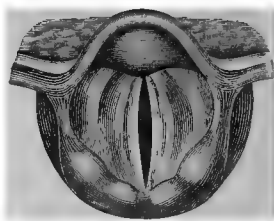

FIG. 485.

FIG. 485.—Glottis as seen by laryngoscope during production of chest-voice (after Mandl and Grützner).

vocal bands in the production of the falsetto as compared with the chest voice.

As has been suggested, in the higher tones of the falsetto, the vocal bands are shortened and come together posteriorly, at all events; and this may be produced largely by the action of the thyro-arytenoideus internus, and possibly several other muscles. There is little doubt that the whole breadth of the bands does not share in the vibrations. In many of its features, the high falsetto of the male voice is allied in production to the head-voice of females, in which only the central parts of the bands seem, in the highest notes, to be involved.

In nearly all previous considerations of this topic, it seems to us that insufficient attention has been paid to the method of applying the blast of air by the lungs. The great importance of this in playing wind-instruments is practically recognized, yet in our own wind-instrument, the most perfect of all, it has received too little practical, and still less theoretical, attention.

Pathological.—The results of the paralysis of the several muscles of the larynx, of the soft palate, etc., throw a certain amount of light upon this subject; it is not to be forgotten, however, that in this instance, as in others, the usual (normal) mechanism may be obscured through adaptations by unusual methods, so that the best is made of a bad case:

1. When the widening of the glottis can not take place, and the glottic opening assumes the cadaveric position, owing to paralysis of the crico-arytenoidei postici, there may be dyspnoea.
2. Paralysis of the *arytenoideus transversus*, in consequence of

which the glottic opening can not be sufficiently narrowed, allows of undue escape of air, and gives rise to feebleness and harshness of the voice. 3. There may be almost complete loss of voice from paralysis of *both* thyro-arytenoid muscles. 4. When the crico-thyroid muscles are paralyzed, owing to imperfect tension of the vocal bands, the voice may become lower pitched and harsh. Any form of paralysis of the vocal bands should arrest attention and lead to a careful examination of the chest for aneurism, etc., and to general inquiry, for even the brain may be involved.

The importance of the muscles, by which the larynx is raised and steadied, must not be overlooked. In professional singers from constant practice they often become greatly enlarged. We may here remark upon the value of singing when not pushed to the verge of fatigue, when free from straining, and in a pure atmosphere, as a healthful exercise, the whole of which does not consist in the good arising from the use of the chest, larynx, etc., or the additional amount of oxygen respired, but also from complicated and ill-understood nervous effects.

At puberty, in both sexes, the larynx shares in those changes of relative and absolute size which the body then experiences so generally. The thickening from excess of blood and nervous energy produces, especially in youths, a harsh voice, which is, in this instance, as in all others, an indication of the need of rest of the parts. To sing under such circumstances is, of course, liable to induce permanent injury in the form of weakness or harshness of voice; but once this period is passed, regular vocal gymnastics may be of great service in perfecting an organ unrivaled as a musical instrument, and by means of which man is raised through the endowment of speech vastly above all other animals.

The subject of voice production and voice preservation is one of the utmost importance in education, though it receives comparatively little attention. The public taste for high-pitched vocalization does unquestionably tend to ruin voices, and is alike opposed to artistic and physiological principles. While a few may reach the prescribed standard of the public taste, the many fail in the attempt.

Comparative.—Much more is known of the sounds emanating from the lower animals than of the mechanisms by which they are produced. This applies, of course, especially to such sounds as are not produced by external parts of the body, it being very difficult to investigate these experimentally or to observe

the animal closely enough when producing the various vocal effects naturally.

All of our domestic mammals have vocal bands and a larynx, not as widely different from that of man as might be supposed from the feeble range of their vocal powers.

The actual behavior of the vocal bands has been studied experimentally in the dog when growling, barking, etc. And, so far as it goes, this mechanism of voice production is not essentially different from that of man. Growling is the result of the functional activity of the vocal mechanism, not unlike that of man when singing a bass note; barking, of that analogous to coughing or laughing, when the vocal bands are rapidly approximated and separated.

The grunting of hogs and the lowing and bawling of horned cattle is probably very similar in production, so far as the larynx is concerned, to the above. The cat has plainly very great command over the larynx, and can produce a wide range of tones.

The quality of the voice of most animals appears harsh to our ears, owing probably to a great preponderance of over-tones, in consequence of an imperfect and unequal tension of the vocal bands; but the influence of the supra-laryngeal cavities, often very large, must also be taken into account.

In certain of the primates, and especially in the howling monkeys, large cheek-pouches can be inflated with air from the larynx, and so add to the intensity of the note produced by the vocal bands that their voice may be heard for miles. Song-birds produce their notes, as may be seen, by external movements low down at the bifurcation of the trachea (syrinx). The notes are owing to the vibration of two folds of the mucous membrane, which project into each bronchus, and are regulated in their

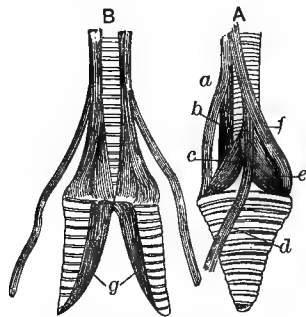

FIG. 486.—Lower larynx (*Syrinx*) of crow (after Gegenbaur). A, seen from side; B, seen from in front. *a-f*, muscles concerned in movements of lower larynx; *g*, membrana tympaniformis interna, stretching from median surface of either bronchus to a bony ridge (pessulus) which projects at the angle of bifurcation of trachea.

movements by muscles, the bronchial rings in this region being correspondingly modified.

A large number of species of *fishes* produce sounds and in a variety of ways, in which the air-bladder, stomach, intestines,

etc., take part. Most *reptiles* are voiceless, in the proper sense, though there are few that can not produce a sort of hissing sound, caused by the forcible emission of air through the upper respiratory passages.

Frogs, as is well known, produce sounds of great variety in pitch, quality, and intensity, some species croaking so as to be heard at the distance of at least a mile. It is a matter of easy observation that when frogs croak the capacity of the mouth cavity is greatly increased, owing to distention of resonating sacs situated at each angle of the jaws. When tree-frogs croak, their throats are greatly distended, apparently in successive waves. But it is among insects that the greatest variety of methods of producing sounds is found.

In bees and flies sounds are caused by the vibration of muscular reeds placed in the stigmata or openings of their tracheal tubes, also by the extremely rapid vibration of their wings. The death-head moth is said to force air from its sucking stomach, and thus give rise to a sound in the same way as certain fishes.

In the grasshopper a noise is produced by rubbing its rough legs against the wing-cases, and in allied forms (locusts) by moving the wing-cases against one another; and in other groups different parts of the body are brought into mutual contact or rubbed or struck against foreign bodies.

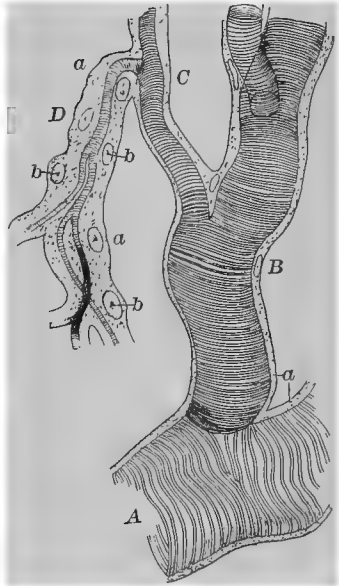

FIG. 487.—Portion of trachea or air-tube of a caterpillar (after Gegenbaur). *a*, epithelial-like cellular layer; *b*, nuclei. The air-tubes in insects are kept up by coiled chitinous tubes, as seen above; and, like the blood-vessels of mammals, penetrate every part of the body.

SPEECH.

It may be noticed that the differences of voices, by which we are enabled to discriminate between individuals, are much more marked during speaking than singing. This is owing to greater prominence of over-tones in the speaking voice, as may be readily shown.

If a series of tuning-forks be held before the open mouth, it will be found that but one position of the buccal cavity and its contents answers to a certain note, but that when this is assumed it acts as a resonance-chamber; thus, for a tuning-fork sounding A, when the cavity takes the shape necessary to sound (speak) that note, the tone produced by the fork is greatly augmented when the latter is held before the mouth. It has thus been estimated that the fundamental tones of the vowel cavity are these: U = b; O = b', A = b'', I = b'''. If the vowels of this series be whispered, their pitch rises. Whispering may be termed speech without voice—i. e., the vocal bands do not vibrate, but the total effect is produced by the blast of air acting through the supra-laryngeal parts as a resonance cavity.

Now, if it be true that there is but one position of the supra-laryngeal cavities that will give a pure vowel-sound, and this sound corresponds in *pitch* to a certain note of the scale, it seems to us that the conclusion that the pitch of the voice, as well as its quality, is dependent to some extent upon these parts as well as the vocal bands. Such a view is, however, not that generally taught. Every singer knows that it is impossible to produce certain vowel-sounds pure with notes of a certain pitch. Usually, when the nasal cavity is shut off posteriorly by the soft palate, or stopped anteriorly by closing the nostrils, a change in quality of the vowel-sounds, characterized as nasal, is produced; but, as illustrating well that the organism has more ways than one of accomplishing the larger part if not all its ends, by effort, and especially by practice, the vowels may be sounded nearly as well as usual under these unfavorable conditions.

Consonants.—The sounds produced by the vocal bands may be modified by interruption in their formation or otherwise, though it is plain, from what has been said, that the form of the mouth, etc., can not be ignored in any form of vocalization.

According to the parts of the supra-laryngeal cavities concerned in the modification referred to, may we have the basis of a physiological classification of the consonants, though it is obvious that they may be dealt with on wholly different principles. By the first method, which alone chiefly concerns us, we have a division into *labials*, *dentals*, and *gutturals*, according as the lips, teeth, or soft palate and pharynx are chiefly concerned. Of course, several parts are involved in all sound-production, and we recommend the student to resort to the forma-

tion of the vowels and consonants before a mirror, in order to acquire a practical knowledge of the relative share taken by the different parts of the supra-laryngeal vocal organs. Ordinarily the tongue does, of course, function as the most important organ of speech; but the extent to which this organ, the front teeth, the lips, etc., can by practice be dispensed with is surprising in the extreme. Persons with more than half of the tongue removed manage to speak quite intelligibly.

Consonants may be further classified according to the nature of the movements associated with their formation: thus, they may be either *continuous* or *explosive*, the meaning of which will be clear from the classification given below, and the basis of the latter from an inspection of the parts by a mirror during their formation, supplemented by consultation of our sensations at the time.

The following tabulation may be of service, as representing at least certain aspects of the subject:

Explosives: *Labials*, P, B.

Dentals, T, D.

Gutturals, K, G.

Aspirates: *Labials*, F, V.

Dentals, L, S, Sh, Th, Z.

Gutturals, Ch (as in loch), Gh (as in laugh).

Resonants: *Labials*, M.

Dentals, N.

Gutturals, N, G.

Vibratory: *Labial*.

Dental, R (common).

Guttural, R (guttural).

It is remarkable that certain consonantal (and vowel) sounds are wholly absent from some languages. All are familiar with the difficulty Europeans find in sounding the English *th*, as in *thin*. Their vocal organs fail to make the necessary co-ordinations, these not having been practised in youth.

Pathological.—Paralysis of the soft palate, giving rise to a nasal quality of voice, illustrates the importance of this little muscular curtain.

Stammering is believed to be caused by long-continued spasm of the diaphragm—in other words, upon tonic contraction of this muscle in the inspiratory position, usually dependent on some form of psychic excitement. *Stuttering*, on the other hand, is temporary inability to form the sounds desired; lack of co-ordination of parts principally. The various paraly-

ses of the vocal bands affect speech as well as voice, though to a less extent; and whispering is, of course, always possible.

SPECIAL CONSIDERATIONS AND SUMMARY.

Evolution.—The very lowest forms, and in fact most invertebrate groups, seem to be voiceless. Darwin has shown that voice is, in a large number of groups, confined either entirely to the male, or that it is so much more developed in him as to become what he terms a “sexual character.” There is abundant evidence that males are chosen as mates by the females, among birds especially, not alone for superiority in beauty of plumage, but also for their song. Thus, by a process of natural selection (sexual selection), the voice would tend to improve with the lapse of time, if we admit heredity, which is an undeniable fact, even among men—whole families for generations, as the Bachs, having been musicians.

One can also understand why on these principles voice should be especially developed in certain groups (birds), while among others (mammals) form and strength should determine sexual selection, the strongest winning in the contests for the possession of the females, and so propagating their species under the more favorable circumstances of chance of the most desirable females.

Pathology teaches that, when certain parts of the brain (speech-centers) of man are injured by accident or disease, the power of speech may be lost. From this it is evident that the vocal apparatus may be perfect and yet there be no speech; so that it becomes comprehensible that the vocal powers of, e. g., a dog, are so limited, notwithstanding his comparatively highly developed larynx. He lacks the energizing and directive machinery situated in the brain.

Some believe that there was a period when man did not possess the power of speech at all; and many are convinced that the human race has undergone a gradual development in this as in other respects. Certain it is that races differ still very widely in capacity to express ideas by spoken words.

We may regard the development of a race of speaking animals as dependent upon a corresponding advance in brain-structure, whether that was acquired by a sudden and pronounced variation, or by gradual additions of increase in certain regions of the brain, or whether to the first there was then added the second.

It is not unlikely that, whether sexual selection has played any considerable part, natural selection at all events has had not a little to do with the preservation of those individuals and races that soonest and most fully developed the speech-centers; for it is to be remembered that the principle of correlated growth must be taken into account. In nature generally, as in social life, success very frequently leads to success. As man's superiority over the highest of the mammals below him is largely due to his possession of a speaking (and writing) faculty, so must we concede that racial superiority is in part traceable to the same cause. It is well known that the leaders among savage tribes are frequently effective in speech as well as strong of heart and arm.

This subject is a very large, suggestive, and complex one, and is worthy of some thought.

Apart from speech proper, there is a language of the face and body generally, in which there is much that we share with lower forms, especially lower mammals. Darwin, noticing this resemblance, regarded it as evidence strengthening the belief that man is derived from lower forms. Why should the forms of facial expression associated with certain emotions so widely among different races of men be so similar to each other and to those which the lower animals employ, if there is not some community of origin? This is Darwin's query, and he considered, as has been stated, that the answer to be given was in harmony with his views of man's origin, as based on an altogether different sort of testimony.

The high functional development of the hand and arm in man, and the use of these parts in writing, are suggestive.

Summary.—The musical tones of the voice are caused by the vibrations of the vocal bands, owing to the action on them of an expiratory blast of air from the lungs. In order that the bands may act effectively, they must be rendered tense and approximated, which is accomplished by the action of the laryngeal muscles, especially those attached to the arytenoid cartilages. We may speak of the respiratory glottis and the vocalizing glottis, according as we consider the position and movements of the vocal bands in respiration or in phonation.

The pitch of the voice is determined by the length and the tension of the vocal bands, and frequently both shortening and increased tension are combined; perhaps we may say that altered (not necessarily increased) tension and length are always combined.

The quality of the voice depends chiefly upon the supra-laryngeal cavities.

The vocal bands of the child and of woman, being both shorter and lighter, account largely for the differences in pitch, quality, and loudness of their voices as compared with that of man. Success in vocalization is dependent, not only on a suitable laryngeal and other mechanism, but upon the rapidity and completeness with which a large number of muscular and nervous co-ordinations can be made. Speech may be either reflex or voluntary, but for high-class results many afferent impulses must determine or modify the nature of the efferent impulses.

There is no *essential* difference in the mechanism of the speaking and singing voice; in the latter, however, the vocal bands take a relatively greater share than in the former, in which the supra-laryngeal parts are more concerned. This applies especially to the utterance of consonants, which may be classified according to the part of the above-mentioned apparatus that is more especially employed.

It is important to remember that in all phonation, in the case of man at least, many parts combine to produce the result; so that voice-production is complex and variable in mechanism, beyond what would be inferred from the apparent simplicity of the mechanism involved; while the central nervous processes are, when comparison is made with phonation in lower animals, seen to be the most involved and important of the whole—a fact which the results of disease of the brain are well calculated to impress, inasmuch as interruptions anywhere among a class of cerebral connections, now known to be very extensive, suffice to abolish voice, and especially speech-production.

It is of great practical moment for each individual to recognize both the limit of his natural powers, especially of his range in singing, and at the same time to appreciate the large margin there is for improvement, more particularly when cultivation of the voice is commenced in childhood, and resumed soon after the age of puberty is attained.

Among mammals below man the vocal bands and laryngeal and thoracic mechanism are very similar, but less perfectly and complexly co-ordinated; so that their vocalization is more limited in range, and their tones characterized by a quality which to the human ear is less agreeable. Man's superiority as a speaking animal is to be traced chiefly to the special development of his cerebrum, both generally and in certain definite regions.

LOCOMOTION.

The entire locomotor system of tissues is derived from the embryonic mesoblast. These include the muscles, bones, cartilage, and connective and fibrous tissues; and the tissues that make up the vascular system or the motor apparatus for the circulation of the blood. Locomotion in the mammal is effected by the movement of certain bony levers, while the equilibrium of the body is maintained. The whole series of levers is bound together by muscles, tendons, ligaments, etc., and play over one another at certain points where they are invested with cartilage, and kept moist by a secretion from the cells covering the synovial membranes that form the inner linings of joints.

Cartilage, a very low form of tissue destitute of blood-vessels, and hence badly repaired when lost by injury or disease, forms a series of smooth surfaces admirably adapted for joints, and especially fitted to act as a series of elastic buffers, and thus prevent shocks. Bone, though brittle in the dried state, possesses, when alive, a favorable degree of elasticity, while sufficiently rigid. Provision is made by its vascular periosteum and central marrow (in the case of the long bones), as well as by the blood-supply derived from the nutrient artery and its ramifications throughout the osseous tissue, for abundant nourishment, growth, and repair after injury.

We find in the body of mammals, including man, examples of all three kinds of levers. It sometimes happens that there is an apparent sacrifice of energy, the best leverage not being exemplified; but on closer examination it will be seen that the weight must either be moved with nice precision or through large distances, and these objects can not be accomplished always by the arrangements that would simply furnish the most



FIG. 488.

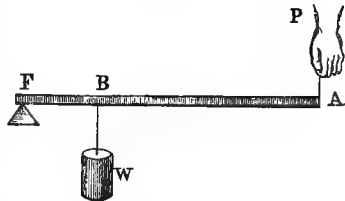

FIG. 489.

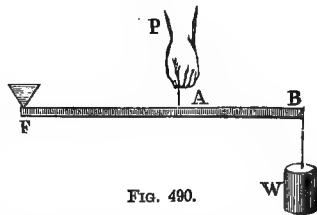

FIG. 490.

powerful lever. This is illustrated by the action of the biceps on the forearm.

It is to be remembered that, while the flexors and extensors of a limb act in a certain degree the opposite of one another,

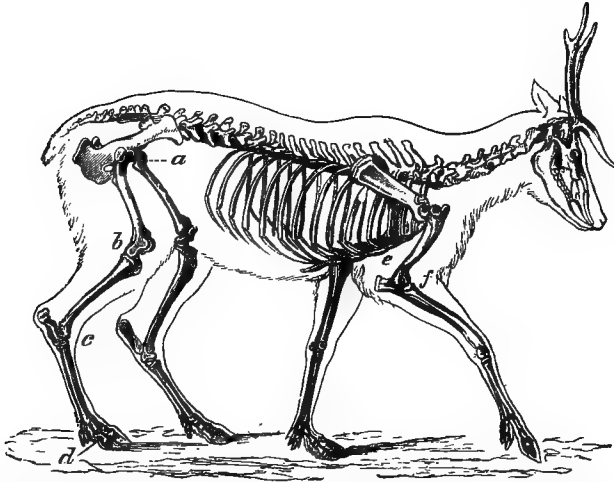

FIG. 491.—Skeleton of deer. The bones in the extremities of this the fleetest of quadrupeds are inclined very obliquely toward each other and toward the scapular and iliac bones. This arrangement increases the leverage of the muscular system and confers great rapidity on the moving parts. It augments elasticity, diminishes shock, and indirectly begets continuity of movement. *a*, angle formed by femur with ilium; *b*, angle formed by tibia and fibula with femur; *c*, angle formed by phalanges with cannon-bone; *e*, angle formed by humerus with scapula; *f*, angle formed by radius and ulna with humerus (Pettigrew).

there is also, in all cases perhaps, a united action; the one set, however, preponderating over the other, and usually several muscles, whether of the same or different classes, act together.

Standing itself requires the exercise of a large number of similar and antagonistic muscles so co-ordinated that the line of gravity falls within the area of the feet. An unconscious person falls, which is itself an evidence of the truth of the above remarks.

The following statements in regard to the direction of the line of gravity may prove useful: 1. That for the head falls in front of the occipital articulation, as exemplified by the nodding of the head in a drowsy person occupying the sitting attitude. 2. That for the head and trunk together passes behind a line joining the centers of the two hip-joints, hence the uncorrected tendency of the erect body of man is to fall backward. 3. That for the head, trunk, and thighs falls behind the knee-

joints somewhat, which would also favor falling backward (bending of the knees). 4. The line of gravity of the whole body passes in front of a line joining the two ankle-joints, so that the body would tend, but for the contraction of the muscles of the calves of the legs, to fall forward.

Taking these different facts into consideration explains the various directions in which an individual, when erect, may fall according as one or the other line (center) of gravity is displaced for a long enough time.

Walking (man) implies the alternate movement of each leg forward, pendulum-like, so that for a moment the entire body

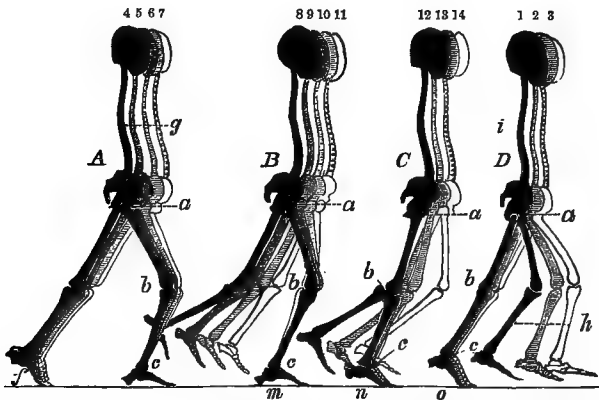

FIG. 492.—Shows the simultaneous positions of both legs during a step, divided into four groups (after Weber). First group (A), 4 to 7, gives the different positions which the legs simultaneously assume while both are on the ground; second group (B), 8 to 11, shows the various positions of both legs at the time when the posterior leg is elevated from the ground, but behind the supported one; third group (C), 12 to 14, shows the positions which the legs assume when the swinging leg overtakes the standing one; and the fourth group (D), 1 to 3, the positions during the time when the swinging leg is propelled in advance of the resting one. The letters *a*, *b*, and *c* indicate the angles formed by the bones of the right leg when engaged in making a step; the letters *m*, *n*, and *o*, the positions assumed by the right foot when the trunk is rolling over it; *g*, shows the rotating forward of the trunk upon the left foot (*f*) as an axis; *h*, shows the rotating forward of the left leg and foot upon the trunk (*a*) as an axis.

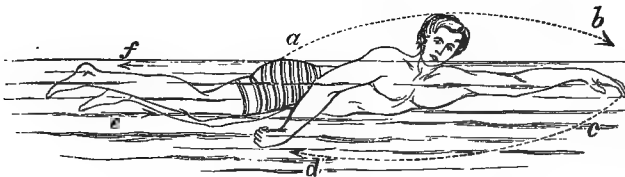

FIG. 493.—Overhand swimming (Pettigrew).

must be supported on one foot. When the right foot is lifted or swung forward, the left must support the weight of the



FIG. 494.—Runner provided with apparatus intended to register his different paces (Marey).

body. It becomes oblique, the heel being raised, the toe still resting on the ground; and it is upon this as a fulcrum that

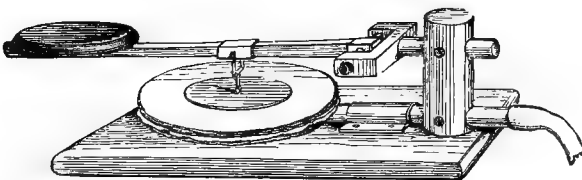

FIG. 495.—Instrument to register vertical reactions during various paces (Marey).

the body-weight is moved forward, when a similar action is taken up by the opposite leg.

It follows that to prevent a fall there must be a leaning of the body to one side, so that the line of gravity may pass through each stationary foot. It follows that a walking person describes a series of vertical curves with the head, and of horizontal ones with the body, the resulting total being complex.

The peculiarities of the gait of different persons are naturally determined by their height, length of leg, and a variety of other factors, which are often inherited with great exactness. We instinctively adopt that gait which economizes energy, both physical and mental.

Running differs from walking, in that both feet are for a period of the cycle off the ground at the same time, owing to a very energetic action of the foot acting as a fulcrum.

Jumping implies the propulsion of the body by the impulse given by both feet at the same moment.

Hopping is the same act accomplished by the use of one leg.

Comparative.—The movements of quadrupeds are naturally very complicated, but have now been well worked out by

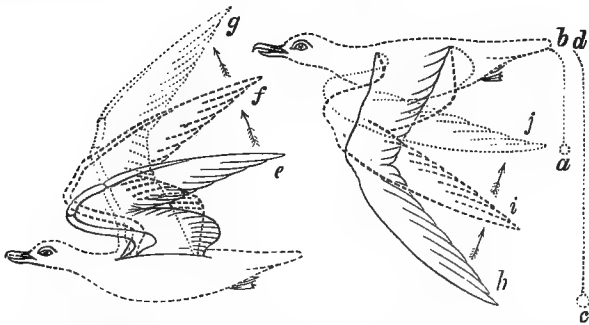

Figs. 496 and 497.—Showing the more or less perpendicular direction of the stroke of the wing in the flight of the bird (gull): how the wing is gradually extended as it is elevated (*e, f, g*); how it descends as a long lever until it assumes the position indicated by *h*: how it is flexed toward the termination of the down-stroke, as shown at *h, i, j*, to convert it into a short lever (*a, b*) and prepare it for making the up-stroke. The difference in the length of the wing during flexion and extension is indicated by the short and long levers *a, b* and *c, d*. The sudden conversion of the wing from a long into a short lever at the end of the down-stroke is of great importance, as it robs the wing of its momentum and prepares it for reversing its movements (Pettigrew).

the use of instantaneous photography. Even the bird's flight is no longer a wholly unsolved problem, but is fairly well understood. The movements of centipeds and other many-legged invertebrates are highly complicated, while their rapid

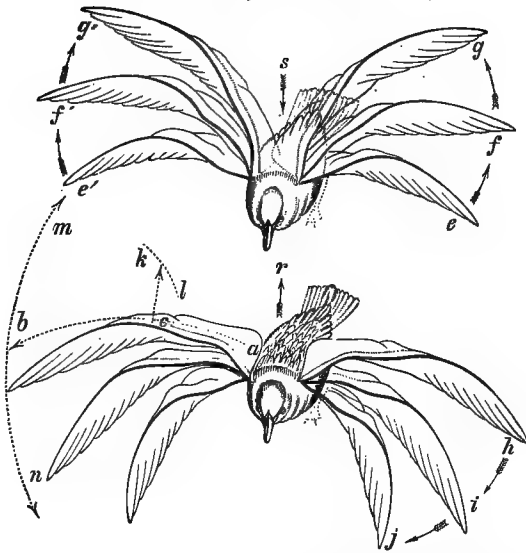

FIGS. 498 and 499 show that when the wings are elevated (*e, f, g*), the body falls (*s*); and that when the wings are depressed (*h, i, j*), the body is elevated (*r*). Fig. 498 shows that the wings are elevated as short levers (*e*) until toward the termination of the up-stroke, when they are gradually expanded (*f, g*) to prepare them for making the down-stroke. Fig. 499 shows that the wings descend as long levers (*h*) until toward the termination of the down-stroke, when they are gradually folded or flexed (*i, j*) to rob them of their momentum and prepare them for making the up-stroke. Compare with Figs. 496 and 497. By this means the air beneath the wings is vigorously seized during the down-stroke, while that above it is avoided during the up-stroke. The concavo-convex form of the wings and the forward travel of the body contributes to this result. The wings, it will be observed, act as a parachute both during the up and down strokes. Fig. 499 shows also the compound rotation of the wing, how it rotates upon *a*, as a center, with a radius *m, b, n*, and upon *a, c, b* as a center, with a radius *k, l* (Pettigrew).

movements are to be accounted for by the multiplicity of their levers rather than the rapidity with which they are moved.

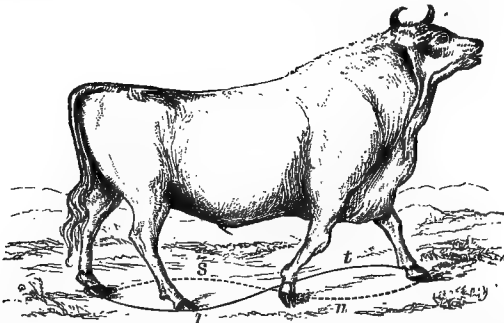

FIG. 500.—Chillingham bull (*Bos Scoticus*). Shows powerful heavy body, and the small extremities adapted for land transit. Also the figure-of-8 movements made by the feet and limbs in walking and running. *u, t*, curves made by right and left anterior extremities; *r, s*, curves made by right and left posterior extremities. The right fore and the left hind foot move together to form the waved line (*s, w*); the left fore and the right hind foot move together to form the waved line (*r, t*). The curves formed by the anterior (*t, u*) and posterior (*r, s*) extremities form ellipses (Pettigrew).

The length and flexibility of their bodies must also be taken into account, rendering many legs necessary for support. We

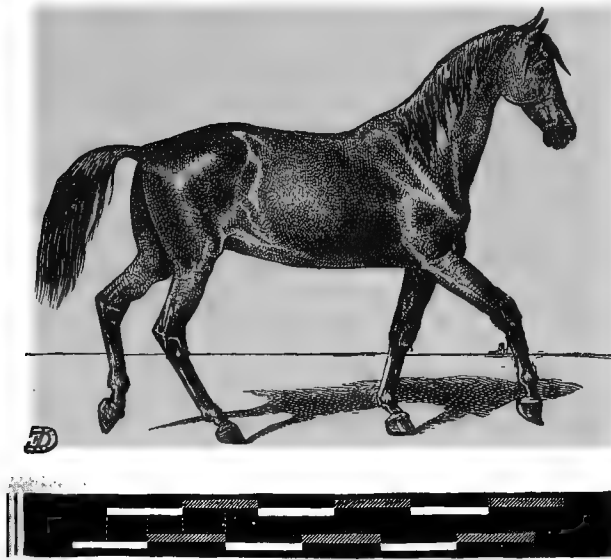

FIG. 501.—Representation of horse at walking pace (Marey).

can only briefly refer to the method of locomotion well exemplified by our domestic quadrupeds. However, the whole subject will become plainer after a careful study of the cuts introduced in this chapter.

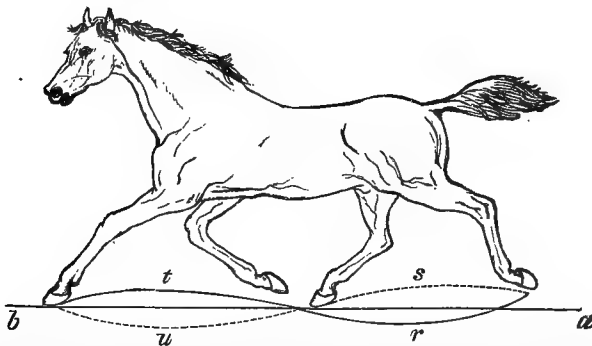

FIG. 502.—Horse in act of trotting. In this, as in all the other paces, the body of the horse is levered forward by a diagonal twisting of trunk and extremities, the extremities describing a figure-of-8 track ($s\ u, r\ t$). The figure-of-8 is produced by the alternate play of the extremities and feet, two of which are always on the ground (a, b). Thus the right fore-foot describes the curve marked t , the left hind-foot that marked r , left fore-foot that marked u , and right hind-foot, s . The feet on ground in the present instance are left fore and right hind (Pettigrew).

In walking, quadrupeds like the horse use the limbs alternately, and in a diagonal sequence, so that the right fore-leg

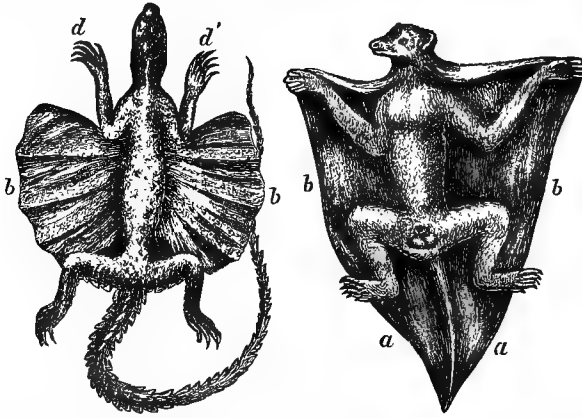

FIG. 503.—Red-throated dragon (*Draco haematopogon*, Gray), shows a large membranous expansion (*b, b*) situated between anterior (*d, d'*) and posterior extremities, and supported by the ribs. The dragon by this arrangement can take extensive leaps with perfect safety.

FIG. 504.—Flying lemur (*Galeopithecus volans*, Shaw). In the flying lemur the membranous expansion (*a, b*) is more extensive than in the flying dragon. It is supported by the neck, back, and tail, and by the anterior and posterior extremities. The flying lemur takes enormous leaps; its membranous tunic all but enabling it to fly. The bat, *Phyllorhina gracilis* (Fig 505), flies with a very slight increase of surface. The surface exposed by the bat exceeds that displayed by many insects and birds. The wings of the bat are deeply concave, and so resemble the wings of beetles and heavy-bodied, short-winged birds. The bones of the arm (*r*), forearm (*d*), and hand (*n, n, n*) of the bat support the anterior or thick margin and the extremity of the wing, and may not inaptly be compared to the nervures in corresponding positions in wing of beetle (Pettigrew).

and the left hind-leg are associated. Trotting corresponds to running in man, and there is the same diagonal action. There

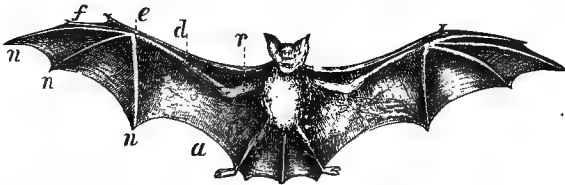

FIG. 505.—The bat (*Phyllorhina gracilis*, Peters). Here the traveling-surfaces (*r d e f, a n n n*) are enormously increased as compared with that of the land and water animals generally (Pettigrew). *r*, arm; *d*, forearm; *e f, n n n*, hand of bat.

is also a gait natural to some horses, some dogs, the camel, etc., termed ambling, or pacing, characterized by both legs on the same side working simultaneously and alike. This is perhaps comparable to human walking. In galloping, all four feet are off the ground together for a portion of the cycle, though they do not strike the ground again at the same moment.

Evolution.—It is noteworthy that with almost all quadrupeds the gallop is the natural method for rapid propulsion. In all

animals, either bred by man to attain great speed, as the race-horse and greyhound, or those that have become so by the process of natural selection, the entire conformation of the body has been modified in harmony with the changes that have taken place in the legs and feet. This is seen in the greyhound among domestic animals, and in the wild deer of the plain and forest. Such instances illustrate not only the principle of natural selection as a whole, but the subordinate one of correlated growth.

Any one observing the modes of locomotion of quadrupeds, especially horses and dogs, will perceive the advantages of the four-legged arrangement. Not only is there a variety of modes of progression, as walking, trotting, galloping, cantering, the alternations of which permit of rest to certain groups of muscles, with their corresponding nervous connections, etc., but on occasion some of these animals can progress fairly well with three legs. Sometimes it may also be noticed that a horse that prefers one gait, as pacing, for his easy, slow movements, will break into a trot when pushed to a higher rate of speed.

Trotting can not be considered the natural gait for high speed in the horse, yet, by a process of "artificial selection" (by man) from horses that have shown capacity for great speed by this mode of progression, strains of racers have been bred, showing that even an acquired mode of locomotion may be hereditary; while that galloping is the more natural mode of locomotion of the horse is evident, among other things, by the tendency of even the best trotting racers to break into a gallop when unduly pushed—an instance also of an hereditary tendency of more ancient origin prevailing over one more recent.

The bipedal modes of progression of birds are naturally very like those of man.

MAN CONSIDERED PHYSIOLOGICALLY AT THE DIFFERENT PERIODS OF HIS EXISTENCE.

Growth.—As a result of the intra-uterine development of two cells, neither of which is visible by the naked eye, the human being reaches about one third of its total length and one twentieth of its maximum weight. In the infant the relatively larger size of the head and face is obvious, while among internal organs the liver is especially large. The child's future increase in weight is chiefly from growth of muscles. Increase

in stature continues up to about the twenty-fifth year, though the increase is most rapid during infancy and puberty, when, in fact, the weight is also greatly augmented.

Digestive System.—While it is now established that all of the digestive secreting mechanisms are active at or shortly after birth, it must be borne in mind that these, like the other organs, adapt gradually to the new conditions. This is a matter of practical importance in infant feeding. Thus, while it is true that the young infant's saliva will act on starch, it is not to be supposed that its amylolytic powers are equal to those of the adult.

Circulatory and Respiratory Systems.—The babe's heart is larger than that of the adult relatively to its body-weight, and its action more rapid; hence the circulation is accomplished in a shorter space of time, an advantage when it is considered that the need for oxygen and tissue-food in the young organism is so great.

The respirations are correspondingly rapid, and the actual amount of the respiratory interchanges is greater than in adult life. There appears, however, to be a storing up of oxygen—i. e., all of the oxygen used up does not shortly appear again as carbonic anhydride.

The *metabolism* of the infant is very active, and is spent largely in construction; growth is in excess of waste; indeed, this feature is characteristic of the metabolism of all young animals. There is, in consequence of the excessive loss of heat, from a relatively larger surface than in the adult, the need for a more active metabolism; the young animal must eat more, to meet this waste. It is, moreover, in consequence of this fact that infants, when not protected better than adults, perish from a fall in the temperature, which their sensitive organizations can not endure.

Immediately after birth the adaptation to the new environment is less perfect than at a later period; respiration is feeble; the blood is imperfectly aërated; the temperature is lower; the entire metabolism goes on but feebly: hence it is that newly born kittens, puppies, etc., can be immersed in water for a considerable period (twenty to thirty minutes) without drowning. The tissues do not demand much oxygen; they live on what they already have stored up, after that in the blood is exhausted—in a word, they behave much as they did during intra-uterine life. The excretions, as would be supposed from the rapid metabolism, are more abundant than in the adult. There

is more urine passed and more urea excreted in proportion to the weight.

The lymphatic system, as a whole, is more pronounced in youth. Certain glands, the functions of which are not well understood, for which reason we have thought it well to pass them over entirely, are at their highest development during infantile life, as the thymus and thyroid. These atrophy as puberty approaches, especially the thymus gland.

The prominence of the lymphatic system harmonizes with what we know of the functions of the colorless corpuscles of the blood in the work of building up tissues. They may be regarded as remnants of embryonic life, undifferentiated cells awaiting their opportunity to develop, though we do not, of course, mean to affirm that in the blood and elsewhere they have no other functions; in fact, it has been shown that in the alimentary tract they are porters of digestive products (fat, etc.); and they also likely play an important part as scavengers and as guardians of the nobler cells against micro-organisms, etc.

Dentition.—The change in the metabolic powers of the animal is foreshadowed by the gradual appearance of teeth for the preparation of a more solid food to meet the altered wants of the economy.

The first appearance of teeth is in the upper jaw, the two central incisors, soon to be followed by the corresponding ones of the lower jaw. This is at about the seventh or eighth month, to be succeeded by the lateral incisors a couple of months later; the first molars about the end of the first year of life; the canines (eye-teeth) half a year later; and the whole of the temporary set before the second year is completed.

The permanent teeth replace the milk-teeth very gradually, and are thus adapted to the growing jaws. The new dentition begins to appear about the sixth year, and may continue for six or eight years. The last molar (wisdom tooth) appears very late, between the seventeenth and the twenty-fifth year. It is noteworthy that this tooth seems to be more and more delayed, and often never appears at all, which may be said of some others, especially the lateral incisors; so that it looks as if, as civilization progressed, the jaw were becoming smaller and the teeth suffering atrophy. Both the teeth and the hair are epidermic structures, and their defective growth at the present time in so many individuals raises suggestive questions. The face of civilized man seems also to be getting smaller relatively

to the head. Is this an example of correlated growth, to be explained by the predominance of the cerebrum?

Nervous System.—The nervous system, like all the others, is highly sensitive; it reacts powerfully to moderate stimuli; its equilibrium is more readily disturbed than that of any other; and, since to it belongs the work of guiding the metabolic processes of the various tissues, this peculiarity explains the readiness with which the health of the infant can be deranged or restored. Hence it follows that a prognosis in the case of infants must be unusually guarded.

As has been already indicated, the cortical cells of the cerebrum, and other parts of the brain, are but indifferently developed at birth; so that stimulation of the cerebral surface in young animals (though there is great difference in this respect) must not be expected to give precisely the same results as in adults.

From the share that we now know the cortex of the cerebrum to take in the elaboration of probably all sensory impulses, it follows that in the infant all of the senses must be to a certain extent imperfect, even assuming that the peripheral mechanisms are as perfect functionally as in the adult, which is not likely.

In some respects, however, the eye of the infant is more perfect. Its power of accommodation for near objects is wonderful, while at a very early age the pupil acts perfectly, and binocular vision is established.

Touch is fairly developed, and probably also taste and smell; though as to the last two there is more doubt. On the other hand, hearing in the infant is very imperfect; power to discriminate between the pitch and quality of sounds is rudimentary; while appreciation of direction, which is largely the result of experience, is necessarily of the crudest.

It is doubtful if the middle ear is properly pervious to air, on which its functioning depends greatly for some time after birth. But certainly, as regards the processes of the peripheral mechanisms of the senses, the child that has passed the years of infancy knows a perfection, to which he becomes more and more a stranger as years pass by. Later he will, in consequence of accumulating experience, make more out of his sensory data; his cerebral cortex will be more developed, both structurally and functionally.

Maturity (Puberty).—Though most of the organs of the body continue to improve, and certainly the organism, as a whole,

up to about the fortieth year of life or later, puberty is that period of life which is most remarkable for sudden, striking development. While this is in some respects most pronounced in the sexual organs and related parts, as the pelvis and mammary glands of the female, yet a whole host of other changes take place simultaneously, in such a way as to leave no doubt that they are related to those of the sexual organs. Not only the characteristic form of the body, but the psychic peculiarities of the sexes, appear and become fully established with an extraordinary rapidity.

There is, therefore, no period of life fraught with so much of developmental good or ill as puberty. A host of diseases may now show themselves, according to the laws of heredity, as a result of deficient resistance, etc.

The Sexes.—While the differentiation of sex becomes greatly more pronounced at puberty, there are decided differences between the male and female infant. The male from birth is the taller and the heavier. This inequality is maintained in adult life. The average woman is shorter and lighter than the man; her muscular and bony systems are less developed, both absolutely and relatively; her brain is some ounces lighter; her blood is poorer in hæmoglobin, of lighter specific gravity, and, as a whole, less in quantity. Woman's metabolism, if we may judge by the income and expenditure, is both absolutely and relatively less. Man's physical strength is nearly double that of woman.

These facts have an important bearing on some of the burning questions of the day. There are, it will be seen, deep-lying differences between the sexes, which can not be ignored in our education and civilization generally, without running counter to that sexual differentiation which Nature, through long ages, has been bringing toward higher and higher development.

Old Age.—From middle life onward, in most persons, there is a gradual process of deterioration going on in every tissue. Elasticity diminishes and rigidity of tissues becomes more and more marked. The arteries undergo changes which, whether fatty or calcareous, greatly impair their usefulness; the cartilages of the ribs and other parts tend to become calcareous, so that the chest-walls possess less of elasticity; this, combined with a general impairment of muscular power, lessens the capability of thoracic movement. Protoplasm everywhere has less vital potential, so to speak; hence with the approach of old age we often find adipose tissue in excess. It becomes a bur-

den to an already weakened organism. Nervous discharges tend more and more to be slow, weak, and to take the lines fixed by long usage; hence, perhaps, that undue conservation of mind common to the old; that lack of enterprise, which is strengthened by the consciousness of inability, physical and mental, for the strain of new undertakings. Hence also the natural failure of acquiring power and the memory. The judgment, dependent as it is on accumulating experience, improves. With extreme old age there is a reversion to the infantile condition, marked by irritability of tissues, weakness, etc.

The laws of habit and rhythm are illustrated abundantly in the subjects we have been considering. Rhythm seems to be a sort of key-note to the interpretation of the universe; but since we have frequently referred to this subject throughout the volume, it will not be further dwelt upon now.

Comparative.—All mammals have their periods of rapid growth, slower decay, and death. Their growth is usually more rapid than man's, and as their whole lives are shorter, with few exceptions, their rate of decay is faster. There are great differences between various mammals in their degree of development at birth. Among some (the marsupials) they separate from the mother internally, to become attached to the nipples externally when very imperfectly developed. Though puppies, kittens, and other members of the groups to which they belong (carnivora) are born with the eyes unopened, no mammal is so helpless as the human infant when ushered into the world. Most animals learn the use of their muscles, and to provide for themselves in a very short period. Slowness of development is, however, even among the lower animals, frequently associated with the attainment of an ultimately higher functional status, and the precocious child should be the object of some anxiety. It may develop into a prodigy of talent, rise little above mediocrity, or become the subject of some serious or fatal form of disease.

It is important to recognize that sexual maturity, in the sense of ability to produce ripe ova and spermatozoa, does not correspond with the full development of the animal; so that it may be as unscientific to breed together animals that are very young as those that are decaying from age. Especially is it undesirable to mate two very young or very old animals. Such a principle applies, of course, also to man.

Death.—If the continuance of life is dependent on the cease-

less adaptation of internal to external conditions, it becomes clear that death may be said to be ever imminent; and in the highest mammals the vital organism is so complex and so delicately balanced, that it is marvelous that life lasts so long as it does. Few animals perish from simple decay leading to a gradual slowing of the vital machinery, down to zero, so to speak; but when death is not due to violence, as it frequently is, it rather arises from some essential part getting out of gear, either directly or indirectly. So great is the need of a constant supply of free oxygen in the mammal, that an arrest of the respiration always implies a stoppage of the circulation. These results may be brought about by the direct action of poisoned blood on the heart, or on the nervous centers presiding over lungs, heart, and other organs. Death may then be due to central influences, though finally the arrest of the circulation is the real proximate cause. When the circulation is so arrested that it can not be started again, somatic or body death must follow, which is to be distinguished from the death of the individual tissues.

Somatic death marks the first stage of the return of a vital organism toward the inorganic world, whence it was, in a sense, derived. That molecular arrangement or movement peculiar to living things once being permanently deranged, its resolution into the less complex forms of the inorganic compounds speedily follows, though the rate will depend much upon circumstances in any individual case. Life is much more of a mystery than death. Physiology attempts to define the conditions under which life exists, but can not explain life itself. Will it ever lift the veil?

APPENDIX.

ANIMAL CHEMISTRY.

AN attempt will be made in this chapter to give a brief account of the principal substances entering into or derivable from the mammalian body, or resulting from its metabolism. We may repeat that, inasmuch as chemical treatment kills living organisms, we can only know the chemical constitution of the dead body.

The cells and tissues of the body of a mammal are made up of protoplasm, which belongs to that large class of bodies known as proteids. However, it is seldom, if ever, that pure protoplasm is found, for even in the youngest cells and in unicellular animals and plants this substance usually contains some representatives of the class of bodies known as carbohydrates and fats. Protoplasm is, moreover, the producer or builder of both fats and carbohydrates, as has been already learned. In one sense all the chemistry of the body is the chemistry of protoplasm, in that it is either by one or other phase of the metabolism of cells that the various secretions, excretions, and reserve products of cells arise. We have already considered this aspect of the subject in connection with the treatment of the metabolism of the animal body, and shall now direct attention in more detail to certain chemical facts, groupings, and principles, largely with the purpose of illustrating the resemblances between the products of our laboratories and of our bodies. At the same time it is to be borne in mind, as we have often remarked in the main body of the work, that we are generally unable to say whether the syntheses and analyses of the body resemble those made by the chemist in the laboratory or not. Indeed, the whole subject, from this point of view, is as yet in a very crude condition.

PROTEIDS.

These include a large class of bodies as yet very imperfectly understood chemically. According to Hoppe-Seyler, the following percentage composition may be assigned to them :

O	N	H	C	S
20.9-23.5,	16.2-17.0,	6.9-7.3,	51.5-54.5,	0.3-2.0.

Usually on ignition a very small quantity of ash remains.

Proteids are amorphous ; insoluble in alcohol and ether ; some of them soluble in water ; soluble with change of constitution in strong acids and alkalies, and lævo-rotatory.

Tests for Proteids.—1. With Millon's reagent (mercury dissolved in its own weight of nitric acid, and the solution diluted with twice its volume of water) a precipitate, rendered red by boiling. 2. Heated with strong nitric acid, they become yellow. On adding ammonia or caustic soda, or potash, the yellow is replaced by an orange (*xanthoproteic reaction*). 3. On adding caustic alkali and a drop or two of copper sulphate, a violet color is produced, which can be deepened by boiling. 4. To the suspected fluid add enough acetic acid to render it decidedly acid, and then a few drops of potassium ferrocyanide. A white precipitate indicates that proteids are present. 5. To the fluid rendered decidedly acid, add a strong solution of sodium sulphate and boil. If a precipitate falls, some proteid was present.

The first three tests are the most reliable, and apply to all classes of proteids.

PROPERTIES AND CLASSIFICATION OF THE PROTEIDS.

I. *Native Albumins.*

These occur naturally in the tissues and fluids of the body. They are soluble in water, are not thrown down by the alkaline carbonates, by sodium chloride, or by *very* dilute acids. Their coagulation-point lies below 70° C. They may be dried with change of color to a pale yellow, but remain soluble.

1. **Egg-Albumin.**—This may be obtained for purposes of experiment by cutting up raw white of egg with scissors, diluting with water, straining through cotton, and afterward through filter-paper. The resulting fluid is almost colorless at first, but on standing darkens gradually. It may be precipitated by strong alcohol, which does not seem to alter its chemical constitution, or by strong acids, when a great chemical change takes place. Various mineral salts, as silver nitrate, mercuric chloride, etc., form with albumin insoluble compounds. Whether albumin ever exists entirely free from combination with salts in the animal body is a question ; probably not.

By the addition of strong acetic acid or caustic alkali, a clear, jelly-like mass results, being, in the first case, acid-albumin, and in the second alkali-albumin. It is lævo-rotatory to the extent of 35·5° (−35·5°).

2. **Serum-Albumin.**—This compound greatly resembles the foregoing, but may be distinguished by the following characteristics: (a) Serum-albumin is not, like egg-albumin, coagulated by ether. (b) Serum-albumin is less readily coagulated by strong hydrochloric acid, and any precipitate formed is easily dissolved by excess of acid, in which respects it is the reverse of egg-albumin. (c) Coagulated serum-albumin is readily soluble in strong nitric acid, the reverse holding for egg-albumin. (d) The specific rotation of egg-albumin is −35·5° ; of serum-albumin, −56°. (e) Serum-albumin occurs in blood, lymph, chyle, milk, and pathological

transudations ; and, when injected into the blood, does not reappear in the urine, while the injection of egg-albumin is followed by its appearance in the urine apparently unaltered. In fact, this form of proteid constitutes a great part of the "albumin" of the urine of such significance in pathological conditions. However, increasing knowledge seems to point to the "albumin" of the urine, like many other forms of proteid, being more complex than was once supposed.

II. *Derived Albumins* (Albuminates).

1. **Acid-Albumin.**—This may be formed by the addition of a strong acid to egg-albumin, or, more gradually, by heating a weaker solution of egg-albumin with an extremely dilute acid.

Acid-albumin is characterized by non-precipitation on boiling, complete precipitation on the addition of a dilute alkali to the point of neutralization—that is, acid-albumin is insoluble in water or such like neutral liquids. It is soluble in an excess of acid or of alkali.

By treating finely minced muscle with a weak acid, a substance is obtained not readily distinguishable from acid-albumin, but known as *syntonin*. This is probably not identical with acid-albumin as formed by the method indicated above, though a distinguishing test of a wholly satisfactory character is not known. Neither this substance nor acid-albumin coagulates on boiling, in which it bears a resemblance to peptone. The *parapeptone* of digestion seems to be very similar to acid-albumin. A solution of acid-albumin in acid may be precipitated by the addition of an excess of common salt.

2. **Alkali-Albumin.**—This corresponds to the foregoing, and may be formed in a similar way by the addition of an alkali instead of an acid. It is not coagulable on boiling, and is precipitated by dilute acid, in excess of which and of alkali it is soluble, but, like acid-albumin, is insoluble in water and solution of neutral salts. The specific rotation varies with the mode of preparation, from which, as well as on other grounds, it is more than likely that there are different kinds of alkali-albumin. It is highly probable that acid-albumin and alkali-albumin are combinations of an acid or an alkali, as the case may be, with albumin, and that the neutralization precipitate is not in itself either one or the other.

3. **Casein.**—This substance is the proteid most characteristic of milk, from which it may be obtained by dilution ten to fifteen times with water, adding acetic acid till a precipitate begins to form, and then sending a current of CO₂ through the fluid. After standing, the precipitate may be collected in a filter. It is freed from salts, sugar, fat, etc., by first washing with water and then with alcohol and ether.

It is so like alkali-albumin that there is no agreement yet as to the differences between them. However, the presence in milk of potassium phosphate modifies the reactions of casein in this fluid. It may be precipitated also by adding magnesium sulphate to saturation to milk. This precipitate is, however, easily soluble in water. The specific rotation of casein, when in solution in water is -80° , but in other solutions is different.

III. *Globulins.*

This class of bodies is characterized by being insoluble in water, soluble in dilute saline solutions (especially sodium chloride); soluble in dilute acids and alkalis, when they are transformed into acid-albumin and alkali-albumin respectively. Most of the globulins are precipitated by saturation with solid sodium chloride.

1. **Globulin** (Crystallin).—When the crystalline lens of the eye is rubbed up with fine sand and extracted with water, upon filtration and passing a stream of carbon dioxide through the filtrate, a precipitation of globulin is obtained. Though strongly resembling paraglobulin and fibrinogen, it is not known to favor fibrin-formation.

2. **Paraglobulin** (Fibrinoplastin).—This body may be obtained from blood-serum by passing through it a current of carbonic anhydride, when a flocculent precipitate falls, which later becomes very finely granular, and may be separated by filtration. Addition of solid sodium chloride precipitates this substance only in part. It is very readily changed into alkali-albumin, and still more so to acid-albumin, by addition of dilute alkalis or acids. This body is not easily precipitated by alcohol. Its coagulation-point is about 70° C.

Paraglobulin has been found in blood-serum, lymph, chyle, serous fluids, the aqueous humor, the cornea, connective tissue, and in the pale and colored corpuscles. It occasionally appears in urine as a pathological product.

3. **Fibrinogen**.—While greatly resembling paraglobulin in most characteristics, the coagulation-point is different, being 52° to 55° when in solution in dilute sodium chloride. It is not so readily precipitated from diluted solutions as the body previously described, and is viscous rather than granular.

It may be obtained from blood-plasma by special precautions, though more readily from hydrocele-fluid. Fibrinogen occurs in blood, chyle, serous fluids, and numerous transudations. It has been considered by many observers to be essential in the formation of fibrin.

4. **Myosin**, as its name implies, is derivable from muscle-plasma, and may be regarded as the latter substance in an altered form. It may be prepared from washed muscle, by treatment with a ten-per-cent solution of common salt, and dropping the viscid product slowly into distilled water, when it falls as a flocculent, whitish precipitate. It is readily converted into syntonin (a form of acid-albumin, as has been pointed out) by acids, and into alkali-albumin by alkalis. In very weak acids and alkalis it is soluble without conversion into a different substance. The coagulation-point of myosin is low, 55° to 60° C.

5. **Vitellin**.—This body, probably united with lecithin, is the chief proteid constituent of the yolk of egg, from which it is usually prepared. It differs from most of the globulins in not being precipitated from its solutions by sodium chloride. The coagulation-point lies between 70° and 80° C.

6. **Globin** is a doubtful member of this class. It is regarded as the

proteid residue of hæmoglobin. It is not easily soluble in dilute acids or sodium chloride, hence it is with hesitation ranked with the other globulins.

IV. *Fibrin.*

This body has peculiarities which warrant, in the present state of our knowledge, its separation from the foregoing and placing it in a separate division. It is insoluble in water and dilute solutions of sodium chloride; dissolved only with difficulty in concentrated neutral saline solutions, and in dilute acids and alkalis.

Fibrin is highly elastic. It always swells under the action of weak (1 to 5 per cent) hydrochloric acid. But continued action of the acid changes the fibrin to syntonin. Heat hastens the process. By the action of alkalis, especially when aided by warming, fibrin is converted into alkali-albumin. By the prolonged action of solutions of sodium chloride (10 per cent), sodium sulphate, etc., conversion into a substance very like myosin or globulin is effected. Myosin may be regarded as an intermediate product, lying between globulin and fibrin. This becomes clear when comparing their respective solubilities in a ten-per-cent solution of sodium chloride. Fibrin and myosin, it will be remembered, are both the products of coagulation processes. The highly filamentous character of fibrin distinguishes it physically from all other proteids.

V. *Coagulated Proteids.*

This class of bodies may be obtained from a variety of others by the use of heat, alcohol, acids, etc. By heating to about 70° C., solutions of egg-albumin, serum-albumin, and globulins are coagulated. Precipitated acid-albumin and alkali-albumin, and fibrin in solution in salines, are converted into coagulated proteids by boiling. The digestive juices act readily on them, converting them finally into peptones.

VI. *Peptones.*

Peptones are proteids which, though possessing little absolute diffusibility, as compared with solutions of ordinary salts, yet pass through animal membranes with much greater readiness than any other proteids. Also, unlike most other proteids, they are not coagulated by boiling. They are not precipitated by cupric sulphate, ferric chloride, nor usually by potassium ferrocyanide and acetic acid. Though precipitated by alcohol from solution in water, they do not undergo a true coagulation, even after standing long under this liquid.

Peptones are coagulated by chlorine, iodine, tannin, the nitrates of mercury and silver, mercuric chloride, and the lead acetates. A mere trace of cupric sulphate to which a strong solution of caustic alkali has been added, introduced into a solution of peptones, gives rise to a *red* (pink) color. If more than a trace of the copper salt be added, the usual proteid reaction results.

Peptones may be formed through the action of dilute or stronger acids at medium temperatures, or by the action of distilled water heated

above the boiling-point under pressure in a special apparatus. The usual method is, however, by the action of gastric or pancreatic juice on white of egg or other form of proteid.

It seems more than probable that the bodies formed by the different methods indicated above are not identical, though having many properties in common. Between the original proteid and the peptone other bodies seem to be formed either as by-products or as intermediate bodies, and the relation of these has been expressed in tabular form (Foster) thus :

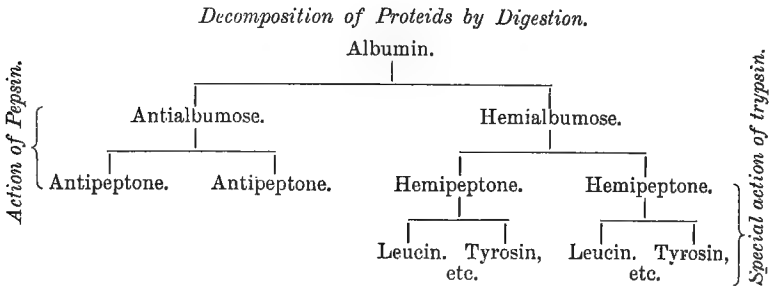

Decomposition by Acids.

1.

By .25 per cent HCl at 40° C.

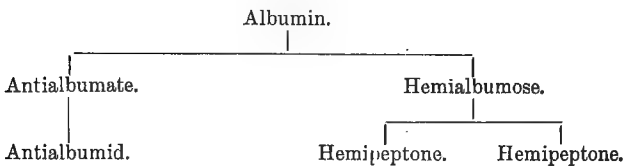

2.

By 3 to 5 per cent H₂SO₄ at 100° C.

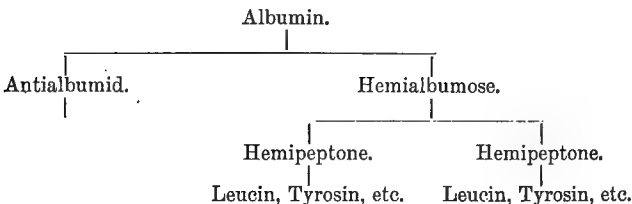

It will be observed that antialbumose and hemialbumose are intermediate products of digestion, and they occur in both peptic and tryptic digestion.

Antialbumate takes the place of antialbumose when albumin is digested with dilute hydrochloric acid at 40° C., or when peptic digestion is not normally active. It can be changed into peptone by trypsin, but not by pepsin, and seems to correspond with the parapeptone of some authors (Meissner). The table is also meant to indicate that antialbu-

mose and hemialbumose both result from peptic digestion, and it is assumed that these both split up into two molecules of antipeptone or hemipeptone, according as the digestion is either peptic or tryptic. Evidently, trypsin carries the processes much further than pepsin.

VII. *Lardacein* (Amyloid Substance).

This body is not found in the tissues in health, but results from a pathological process, and is most frequently found in the spleen, liver, kidneys, lungs, blood-vessels, etc. It consists of CHNO and a little sulphur in some oxidized form. It is insoluble in water, dilute acids and alkalies, and neutral saline solutions. Like other proteids, it can be converted into acid-albumin and alkali-albumin; but, unlike all other proteids, it is not affected by the digestive juices. It may be recognized by giving a red color with iodine, and a violet or blue when heated with iodine and sulphuric acid.

We are still in ignorance of the real molecular constitution of proteids, and our whole knowledge of this class of bodies is in the empirical rather than the scientific stage.

NITROGENOUS NON-CRYSTALLINE BODIES ALLIED TO PROTEIDS.

These bodies resemble each other much less than the proteids proper :

1. **Mucin** (CHNO).

It is the characteristic body of mucus, which abounds in the bile of the gall-bladder and in snails, from either of which it may be prepared. It may be precipitated from its solutions by alcohol, alum, mineral acids, and acetic acid. The precipitate is dissolved by excess of mineral acids, but not by acetic acid, so that the latter forms one of the best tests for mucin.

2. **Chondrin** (CHNOS).

This substance may be extracted from hyaline cartilage, and less easily from elastic cartilage. It readily gelatinizes from its solutions on standing; is soluble in hot water, alkalies, and ammonia; insoluble in cold water. It is very doubtful whether chondrin of itself exists in cartilage; it is more likely an allied product.

3. **Gelatin, or Glutin** (CHNOS).

This substance may be obtained by heating connective tissue for days with dilute acetic acid at about 15°, or by prolonged treatment with water under high pressures. It forms, when not pure, the well-known "glue." Though swelling in cold water, it does not dissolve, but is readily soluble in warm water. It forms insoluble precipitates with tannic acid and mercuric chloride.

4. **Elastin** (CHNO).

This is one of the most insoluble substances derivable from animal tissues. It, however, yields to concentrated nitric and sulphuric acids in the cold and to boiling alkalies, and may be precipitated from its solutions by tannic acid. The substance is best obtained from the ligamentum nuchæ of the ox.

5. **Keratin** (CHNOS).

It makes up a large part of horn, hair, nails, feathers, and is also a highly insoluble body. In all probability it is not a simple substance.

6. **Nuclein** (CHNOP).

This body is derivable from the nuclei of cells, from yeast, semen, and from the yellow corpuscles of the yolk of eggs. It is slightly soluble in water, easily so in alkalis, though the solubility changes on keeping. It is best prepared from pus-corpuscles, and contains a notably large quantity of phosphorus—nine to ten per cent.

7. **Chitin** (CHNO).

Though not occurring in appreciable quantity, at all events in the body of the mammal, it makes up a good part of the hard covering of insects, crustaceans, etc. It has been regarded as analogous to the *cellulose* of plants. It is a highly insoluble substance, resisting all reagents except strong mineral acids. It may be obtained pure, as a white amorphous body. The insolubility of the above products as a class is remarkable. Most of them yield either leucin or tyrosin, or both, under hydrolytic treatment. Their relations are very ill understood, and it is doubtful if any of them are simple substances, or exist as such in the tissues from which they are extracted with so much difficulty in most instances. No attempt has been made to give the percentage composition of the above bodies.

CARBOHYDRATES.

Of this class glycogen, dextrose (grape-sugar, glucose), maltose, milk-sugar, and inosit occur normally in the mammalian body.

The exact chemical constitution and relations of the sugars are still under discussion; we shall, therefore, pass this subject over in this brief outline.

1. **Dextrose** (grape-sugar). $C_6H_{12}O_6$.

The occurrence of this body in the various fluids and tissues has been already considered.

This sugar crystallizes from aqueous solutions in prisms, which may be agglutinated into lumps, and is, when chemically pure, colorless, readily soluble in warm water, more slowly soluble in cold water, sparingly soluble in alcohol, and insoluble in ether. Specific rotation, $+104^\circ$ —i. e., dextro-rotatory 104° for yellow light. In the presence of yeast-cells, and at a temperature of from 5° to 45° C. (best at about 25° C.), dextrose undergoes the alcoholic fermentation. The reactions may be thus expressed:



In the presence of decomposing nitrogenous matter, as the casein of milk, the *lactic* fermentation results.

Reactions:

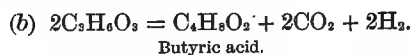
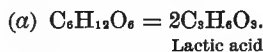

A temperature of about 35° C. is the most favorable for this fermentation. Dextrose readily reduces copper salts in the presence of caustic alkali.

Maltose. $C_{12}H_{22}O_{11}$.

This sugar may be artificially produced by the action of *diastase*, a ferment obtained from malted barley, on starch.

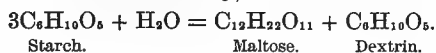

It may also be formed by the action of dilute sulphuric acid on starch. It reduces copper salts; is dextro-rotatory; ferments with yeast, and crystallizes in fine needles. It seems to be the principal sugar formed in the natural digestive processes.

Milk-Sugar (lactose). $C_{12}H_{22}O_{11}$.

This form of sugar is found in the milk of all animals normally, and occasionally in the urine of animals during lactation.

It crystallizes in rhombic prisms; its taste is slightly sweetish; is dextro-rotatory; much less soluble in water than cane-sugar. When the lactose of milk ferments; it breaks up into alcohol and lactic acid, hence the souring of milk. It reduces solutions of copper salts, but less perfectly than dextrose, and is dextro-rotatory.

Inosit. $C_6H_{12}O_6$.

This substance has been obtained sparingly from the muscle-cells of the heart and from some other organs. It crystallizes in rhombic prisms; readily soluble in water but insoluble in alcohol and ether. This sugar has no specific action on light, and is susceptible of the *lactic* fermentation.

Dextrin. $C_6H_{10}O_5$.

This substance may be formed by the action of dilute acids on starch, or by the action of *diastase* on the same body. It is strongly dextro-rotatory, does not reduce solutions of copper salts, gives a red color with iodine, is soluble in water, and precipitated by alcohol. It is a product of both artificial and natural digestion.

By the action of acids and ferments on starch, certain modifications of dextrin are formed. Of these, erythro-dextrin becomes sugar by the continued action of ferments. Achroo-dextrin remains unaltered and is characterized by giving no red color with iodine. It may be converted into dextrose by boiling with dilute hydrochloric acid.

Glycogen. $C_6H_{10}O_5$.

This substance is pretty widely distributed in the organs of the body especially in the mammalian foetus, and is found in abundance in the liver of the adult in both vertebrates and invertebrates. Glycogen when pure is white, amorphous, tasteless, easily soluble in water, insoluble in alcohol and ether, highly dextro-rotatory, and does not reduce metallic oxides. It is changed by the digestive ferments into a form of sugar and of dextrin, and gives a red (port-wine) color with iodine, which disappears on warming but returns on cooling, by which latter it is distin-

guished from dextrin. It is best extracted from the liver, removed as soon as possible after killing an animal and minced, by boiling water, then purified and precipitated.

Tunicin. $C_6H_{10}O_6$.

This body is closely allied to the cellulose of plants, and forms the greater part of the integument of ascidians or tunicates. Like chitin, it is extremely insoluble.

FATS, FATTY ACIDS, ETC.

General formula of series : $C_nH_{2n}O_2$ or $C_nH_{2n+1}.CO_2H$.

The fatty acid series answers to the series of monatomic alcohols: thus, formic acid corresponds to methyl alcohol, and acetic acid to ethyl or ordinary alcohol.

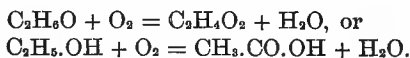

From which it appears that O has taken the place of H_2 in the alcohol to form the acid—i. e., the acid is an oxidized alcohol. The lowest members of the line are volatile liquids with strongly acid reactions. As the series is ascended, fluidity diminishes, and finally the acids are solids, greatly resembling the neutral fats in appearance.

The derivatives of the fatty acids are very important in the animal economy, but the free acids occur sparingly.

Formic acid. $H.CO_2H$.

A strongly corrosive liquid, boiling at $100^\circ C.$, solidifying at 0° , and mixing readily with water and alcohol. It has been extracted from various organs.

Acetic acid. $CH_3.CO_2H$.

An acid liquid of characteristic odor, boiling at $117^\circ C.$, solidifying at $5^\circ C.$ Readily miscible with alcohol and water.

It often occurs in the stomach, from fermentative changes.

Propionic acid. $C_2H_5.CO_2H$.

Resembles acetic acid, soluble in water and boiling at $141^\circ C.$ It is found in perspiration, the stomach, diabetic urine when fermenting, etc.

Butyric acid. $C_3H_7.CO_2H$.

An oily, colorless liquid, with the smell of rancid butter, soluble in water, alcohol, ether; and boiling at $162^\circ C.$

It is found in sweat, fæces, urine, and the contents of the large intestine.

Valerianic acid. $C_4H_9.CO_2H$.

An oily liquid of strong smell and taste, soluble in water, and more so in alcohol and ether. It is found in solid excrement. In fatty degeneration of the liver it may occur in the urine, as a result of the decomposition of leucin, which appears in abundance in the urine in the above disease.

Caproic acid. $C_6H_{11}.CO_2H.$

Caprylic acid. $C_7H_{13}.CO_2H.$

Capric acid. $C_8H_{17}.CO_2H.$

These acids enter into the fats of butter, from which they are readily prepared. They are all soluble to but a slight extent in water, but readily in alcohol and ether. They probably occur in the products of the sebaceous glands and the sweat, at least occasionally in some animals.

Laurostearic acid. $C_{11}H_{23}.CO_2H.$

Myristic acid. $C_{13}H_{27}.CO_2H.$

They occur as neutral fats in butter, spermaceti, etc.

Palmitic acid. $C_{16}H_{33}.CO_2H.$

Stearic acid. $C_{17}H_{35}.CO_2H.$

These are colorless solids with melting-points, the former at $62^\circ C.$, the latter at $69.2^\circ C.$ Insoluble in water, but readily dissolved by hot alcohol, ether, or chloroform. With alkalis they form soaps; and with glycerin they, together with the oleates, make up the greater part of human fat. As salts of sodium (?) they occur in chyle, blood, serous fluids. Combined with calcium they occur in the fæces and the adipocere of the buried cadaver. They are said to occur *free* in the caseous nodules of tubercle and in decomposing pus.

The Oleic (Acrylic) Acid Series.

General formula of series $C_nH_{2n-2}O_2$. Several of the acids of this series occur as compounds of glycerin in various fats. They may be decomposed into acids of the acetic series.

Oleic acid. $C_{18}H_{34}O_2.$

The most important to the physiologist; is a colorless, oily liquid solidifying to a crystalline mass at $4^\circ C.$ Soluble in alcohol and ether but not in water; forms soaps with alkalis.

The Neutral Fats.

To understand this class of bodies it becomes necessary to bear in mind the relations of the acids of the fatty and oleic series to glycerin. Glycerin may be regarded as a tri-acid alcohol:

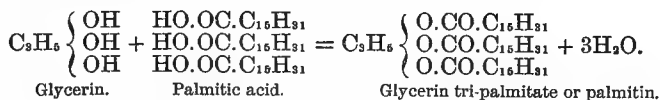

From which the relations of glycerin and a fatty acid to the neutral fat appear—i. e., a neutral fat is the result of the replacement of the exchangeable atoms of hydrogen in the tri-atomic alcohol (glycerin) by the acid radicles of the acetic or oleic series; so that the neutral fats may be regarded as ethers, of which, in the nature of the case, there are theoretically three; but those only in which the most complete substitution has taken place are of importance from a physiological point of view.

These neutral fats are insoluble in water and cold alcohol, soluble in hot alcohol, ether, chloroform, etc.

By the action of caustic alkalis or superheated steam they may be readily decomposed into glycerin and their fatty acids.

Saponification may be thus represented :

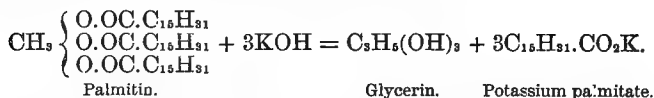

It is known that fats are not only emulsified in the alimentary tract, but split up into their component fatty acids and glycerin. A certain proportion of soluble soaps are formed and taken into the blood ; some insoluble soaps appear in the fæces.

But the chemical changes of fats, destructive and constructive, effected by the organs that prepare food to become blood, are doubtless very complex, and in large part as yet unknown.

Glycolic Acid Series.

Glycol may be formulated thus : $\begin{array}{c} \text{CH}_2\text{OH} \\ | \\ \text{CH}_2\text{OH} \end{array}$, the general formula of the glycols being $\text{C}_n\text{H}_{2n+2}\text{O}_2$ —i. e., the glycols are diatomic alcohols, from which acids may be obtained by oxidation, thus :

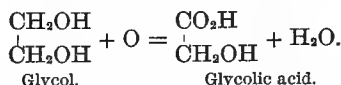

By additional oxidation a member of the glycolic series may be converted into one of the oxalic series, thus :

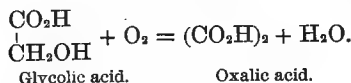

1. Lactic acid. $\text{C}_3\text{H}_6\text{O}_3$ or $\text{C}_2\text{H}_4 \begin{array}{l} \diagup \text{OH} \\ \diagdown \text{CO}_2\text{H} \end{array}$.

Exists in four isomeric conditions, three of which have been found in the mammalian (human) body. These have the following properties in common : Are sirup-like in consistence, colorless, soluble in water, alcohol, and ether ; have an extremely sour taste and a strong acid reaction. They form salts (lactates) with the metals. (a) *Ordinary lactic acid*, in active ethylidene-lactic acid, a hydroxyl-propionic acid, $\text{CH}_3.\text{CH} \begin{array}{l} \diagup \text{OH} \\ \diagdown \text{CO}_2\text{H} \end{array}$. This is the form of lactic acid that occurs in the fermentation of milk. It is found in the contents of the stomach, intestines, and pathologically in the urine. (b) *Ethylene-lactic acid*. This isomer of lactic acid occurs, though there is some doubt about the subject, in muscle. (c) *Sarcrolactic acid*, active ethylidene-lactic acid, $\text{CH}_3.\text{CH} \begin{array}{l} \diagup \text{OH} \\ \diagdown \text{CO}_2\text{H} \end{array}$. This acid may be readily obtained from flesh, and is therefore found in abundance in the "meat extracts." It is the only one of the lactic acids

that rotates the plane of polarized light, the free acid being dextro-rotatory.

The Bibasic Acids (C_nH_{2n-2}O₂) of the Oxalic Series.

Only a few members of this series are of special interest to the medical chemist.

Oxalic acid. C₂H₂O₄, (CO₂H)₂.

Does not occur free in the mammalian body, but is normally present in small quantity as an oxalate, chiefly of calcium, in the urine of most mammals. In certain disordered states of the metabolism it occurs in the urine of man in characteristic dumb-bell forms, in regular octahedra, or in square columns with pyramidal ends. These are insoluble in water, alcohol, ether, ammonia, and acetic acid, but readily dissolve in hydrochloric acid.

Succinic acid. C₂H₄(CO₂H)₂.

Occurs in the spleen, thymus and thyroid bodies, and in hydrocele and hydrocephalic fluids. It crystallizes in large rhombic tablets, and more rarely in prisms; sparingly soluble in water.

COMPLEX NITROGENOUS FATS.

The bodies to be described in this chapter may most of them be extracted from the nerves and nervous centers.

Lecithin. C₄₄H₉₀NPO₈.

This substance may be obtained from diverse sources—the blood, bile, serous fluids, and especially from the brain, nerves, yolk of egg, semen, pus, the colorless corpuscles, and even the electrical organ of fishes. It may be separated as a white, somewhat crystalline, soft body, soluble in cold alcohol, more so in hot alcohol, in ether, chloroform, fats, benzol, etc.

Glycerinphosphoric acid. C₉H₉PO₆.

May arise as a decomposition product of lecithin, thus:

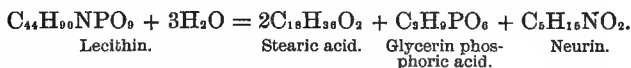

Protogon. C₁₈₀H₃₀₂N₆PO₃₅ (?).

The formula of most of these bodies is doubtful, and especially is this remark true of protogon. This body is insoluble in cold water, but swells in it like gelatin. At 200° C. it melts to a sirup. There has been much discussion as to whether it is a single body, or a mixture of lecithin and cerebrin. It is derivable from the brains of mammals.

Neurin. C₆H₁₆NO₂.

It is a very unstable body, difficult to get or keep in a free state. It has been obtained from bile; hence the name cholin.

Cerebrin. C₁₇H₃₂NO₃ (?).

Abounds in the brain in the axis cylinder of nerves and in pus-corpuscles. It may be obtained as a colorless hygroscopic powder.

THE SERIES OF BILE ACIDS, ETC.

Cholic (cholalic) acid. $C_{24}H_{40}O_6$.

It is the starting-point of the bile-acid series, and may be obtained pure in an amorphous or crystalline form, soluble in water. This acid is dextro-rotatory. It may occur in the large or small intestine and in the fæces. In jaundice it is in excess in the blood, tissues, and excretions, especially the urine.

Pettenkofer's Test.—With sugar and sulphuric acid it gives a reddish color, which may or may not require slight heat for its production; but it is important to remember that this reaction may be produced by other substances, so that the test is at best by itself a doubtful one.

Glycocholic acid. $C_{26}H_{42}NO_6$.

This is the principal acid of ox-gall; occurs also in that of man, but apparently not in the bile of carnivora.

This acid crystallizes in fine needles, soluble in water especially if hot, in alcohol, but not in ether. It has a strongly acid reaction.

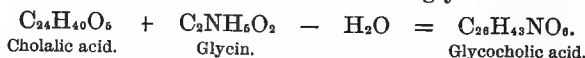

Whether it is formed in the body in the manner indicated by the above equation is uncertain, as glycin has not as yet been obtained free from any tissue. This acid is best prepared from ox-gall.

Taurocholic acid. $C_{26}H_{46}NSO_7$.

Though found in ox-gall it is most plentiful in human bile, that of the carnivora, and especially in dog's gall.

It crystallizes in needles but not readily. It is soluble in water and alcohol, insoluble in ether. Its salts are also soluble in water. Taurocholic acid is a very insoluble substance.

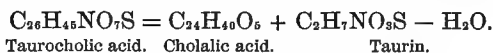

Like the preceding, it is dextro-rotatory.

Cholesterin. $C_{26}H_{44}.OH$.

Remarkable as the only free alcohol occurring in the human body. This substance may readily and in great abundance be extracted from the nervous tissues, but most easily from gall-stones, of which it forms a large part. It can be derived from other tissues, the blood and especially bile. It may be obtained in white fine needles from solution in hot alcohol, ether, etc. The substance is lævo-rotatory.

Test.—Strong sulphuric acid added to it in solid form and heated, or to its solution in chloroform, gives a bright-red color, which changes on standing.

*Bile-Pigments.***Bilirubin.** $C_{18}H_{18}N_2O_6$.

It makes up a great part of the pigment of the bile of the carnivora and perhaps of man. It abounds also in gall-stones, from which it may be obtained, in either the amorphous or crystalline condition, by extracting with chloroform and further treatment. When heated with nitrous

acid it undergoes a series of oxidations, giving rise to distinct products of which one is the green biliverdin. These oxidations are the basis of *Gmelin's test* for bile-pigment, which consists in adding a drop of strong nitric acid containing nitrous acid to bile, when a series of rather rapid changes in color in a certain order takes place.

Biliverdin. $C_{16}H_{18}N_2O_4$.

It is this pigment which gives the characteristic color to ox-gall, from which it is best prepared. It is not soluble in ether or chloroform, but dissolves readily in alcohol.

In all probability both the bile-pigments and their derivatives are the result of the final transformations of hæmoglobin.

Choletelin. $C_{16}H_{18}N_2O_6$.

This is the final product of the oxidation of bilirubin.

Hydrobilirubin. $C_{32}H_{46}N_4O_7$.

When an alkaline solution of bilirubin is acted upon by sodium amalgam, the above results. It is thought by many to be identical with sterco-bilin, a product of the decomposition, etc., of bile in the intestine. Since hydrogen in the nascent condition probably occurs in the intestines as the result of fermentations, the conditions for the formation of this substance seem to be met.

Pigments of Urine.

It seems to be more than probable that the urine contains a great number of pigments. But few of these, however, have been isolated.

The best known are the following:

Urobilin. $C_{32}H_{46}N_4O_7$.

The formulæ of all these bodies are but indifferently known.

Urobilin is thought to be identical with hydrobilirubin. It is present, but in small quantities, in normal urine, though often largely in the urine of febrile conditions. It is supposed to be an oxidized form of chromogen.

Uroerythrin.

Supposed to abound in the urine of rheumatic patients. It becomes greenish on addition of caustic alkali, and reddish or reddish-yellow when concentrated hydrochloric acid is added.

The Indigo Series.

Indican. $C_{26}H_{31}NO_{12}$.

Some regard indican as indoxyl sulphuric acid, which does not occur in the free state, but as a salt of potassium. It represents in the urine the indol of the alimentary canal.

Indigo. $C_{16}H_{10}N_2O_2$.

It occasionally occurs in sweat and urine as an oxidation product of indican.

It may be obtained from human urine, and still more readily from that of the herbivora, by the cautious addition of a weak solution of

chlorinated lime to some urine to which an equal bulk of strong hydrochloric acid has been added. Unless great care is employed in mixing up the fluids, in the drop-by-drop addition of the solution of chlorinated lime, the indigo-blue will be oxidized (bleached) to indigo-white.

The substance is soluble in chloroform which, being heavy, falls to the bottom of the glass and carries with it the indigo.

Indol. C_8H_7N .

A substance to which the odor of fæces is in part due. It occurs in artificial and natural pancreatic digestion as a product of the action of bacteria. It is crystalline, soluble in boiling water, alcohol, and ether. Its alcoholic solution when nitrous acid is added gives a red color and its aqueous solution a red precipitate.

Skatol. C_9H_9N (?).

A substance occurring under the same circumstances as indol. It does not give the same reactions with nitrous acid as indol, but gives a violet-red color, when in urine, on the addition of concentrated hydrochloric acid. It may, like the preceding, be obtained in crystalline form.

NITROGENOUS METABOLITES.

As may be gathered by a perusal of the chapter on the metabolism of the body, the nitrogenous metabolism, while most interesting and important, presents problems which as yet are in great part unsolved. However, something more of the nature of certain nitrogenous chemical compounds, either occurring in the body or related to such as are present, may now be considered with advantage.

Urea. $CO \begin{matrix} \diagup NH_2 \\ \diagdown NH_2 \end{matrix}$.

Urea may be regarded as the most important and by far the most abundant solid of the urine of man and many other mammals, including practically, so far as known, all the carnivora and several other groups. It also occurs to a slight extent in the urine of birds. It is found in small quantity in blood and many of the fluids of the mammalian body, though not at all or to but the smallest extent in muscles. It may be prepared from urine and obtained in colorless needles, soluble in water and alcohol, but not in anhydrous ether. When urine decomposes, urea, possibly under the action of a ferment, becomes ammonium carbonate:

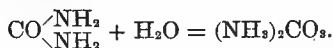

Urea may be made in the laboratory in several ways, some of which are indicated in the following equations:

1. By heating ammonium carbonate:

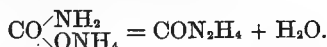

2. By heating ethyl carbonate with ammonia:

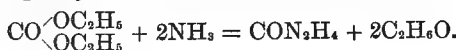

3. By addition of water to cyan-amide:

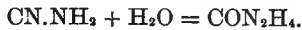

4. By evaporation of ammonium cyanate in aqueous solution:

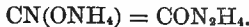

The last reaction possesses a historical interest, for it was by this method that an organic compound occurring in the animal body was first formed from inorganic substances in the laboratory by Wöhler in 1828. Urea forms compounds with acids, the most interesting of which to the student of animal chemistry is the following:

Urea nitrate. $\text{CH}_4\text{N}_2\text{O.HNO}_3.$

When urine is concentrated, and strong nitric acid added cautiously, the above crystallizes out in glistening six-sided or rhombic tablets, soluble in water, but insoluble in ether. This makes a reliable and fairly delicate test for the presence of urea.

Uric acid. $\text{C}_5\text{H}_4\text{N}_4\text{O}_3.$

This metabolite occurs in the spleen and several other organs and tissues; sparingly in the urine of man and most mammals; abundantly in that of birds and serpents, in which it takes the place of urea. In its purest form it presents itself as a colorless crystalline powder, tasteless and odorless. Its crystalline forms, arising spontaneously from urine, are very variable and always colored. Very insoluble in cold water, ether, and alcohol; readily soluble in sulphuric acid, caustic alkalies, and some of their salts. The most important salts of uric acid are the urates of sodium, potassium, and ammonium, all of which occur in urinary sediments.

The murexid test for uric acid is as follows: Add strong nitric acid in very small quantity, and evaporate to dryness, when a red color should appear, which on addition of ammonia gives rise to a purple. The following equations will show the relations of uric acid to urea, etc., so far as laboratory reactions are concerned. We have in the body of the work shown that uric acid is not in all probability itself an antecedent of urea in the body:

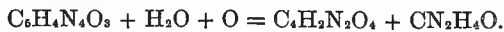

Uric acid. Alloxan. Urea.

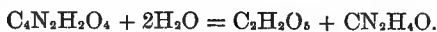

Alloxan. Mesoxalic acid. Urea.

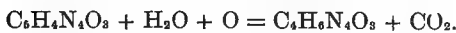

Uric acid. Allantoin.

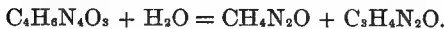

Allantoin. Urea. Allanturic acid.

Uric acid has been made artificially by fusing together urea and glycocin (glycin, glycoll, or amido-acetic acid):



Creatin. $\text{C}_4\text{H}_8\text{N}_3\text{O}_2.$

This body may be abstracted from dead muscle, and obtained either in a white amorphous condition or in rhombic prisms, soluble in cold

water and in ether; less so in alcohol. Creatin may be changed into urea and sarcosin or methyl-glycin:

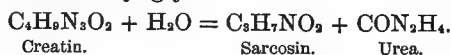

It may also be formed synthetically under the action of acids. Creatin may by dehydration be transformed into creatinin.

Creatinin. $\text{C}_4\text{H}_7\text{N}_3\text{O}$.

This body may be regarded as dehydrated creatin. It occurs normally in flesh and urine, and may be obtained in prisms; soluble in water and alcohol, but not appreciably in ether. It acts as a strong base, the most important salt being the zinc chloride ($\text{C}_4\text{H}_7\text{N}_3\text{O}$)₂ZnCl₂.

Allantoin. $\text{C}_4\text{H}_6\text{N}_4\text{O}_3$.

A body characteristic of the allantoinic fluid of foetal life, and which may occur in the urine. Its relations to uric acid and urea have been indicated above.

Hypoxanthin (sarkin). $\text{C}_6\text{H}_4\text{N}_4\text{O}$.

Occurs in flesh, in the spleen, liver, medulla of the bones, etc. It may be obtained in fine needles, soluble in hot water.

Xanthin. $\text{C}_8\text{H}_4\text{N}_4\text{O}_2$.

May be derived from muscles, the liver, spleen, thymus, and some other organs and tissues. It is probably a normal constituent of the urine in minute quantity. It may be obtained as a colorless powder, only slightly soluble in water, but soluble in dilute acids and alkalies. Xanthin may be regarded as the oxidized form of hypoxanthin.

Carnin. $\text{C}_7\text{H}_8\text{N}_4\text{O}_3$.

Occurs in extract of flesh, and may be obtained in crystals, insoluble in alcohol and ether, but slightly soluble in cold water, and more so in hot water.

Guanin. $\text{C}_6\text{H}_6\text{N}_6\text{O}$.

So called because first obtained from guano (excrement of birds); it is, however, also to be extracted from several organs and tissues; as a white amorphous powder, insoluble in water, alcohol, ether, etc. By treatment with nitrous acid it may be converted into xanthin.

Kynurenic acid. $\text{C}_{10}\text{H}_{14}\text{N}_2\text{O}_6$.

This body has been found in the urine of dogs.

Glycin. (Glycocoll, glycocin, amido-acetic acid.) $\text{C}_2\text{H}_5\text{NO}_2$, or $\text{CH}_2 \begin{array}{l} \nearrow \text{NH}_2 \\ \searrow \text{CO}_2\text{H} \end{array}$

This is one of that important class of compounds, the amido-acids, and may be formed in the laboratory from mono-chlor-acetic acid and ammonia:



It is peculiar in having both acid and basic properties—i. e., it unites with both acids and bases to form crystallizable compounds. Glycin itself may be obtained in crystalline form soluble in water. Though

not found in the free state as yet in the body, it may be split off from bile acids and hippuric acid.

Taurin. $C_2H_7NO_2S$, or $C_2H_4 \begin{matrix} \diagup SO_2H \\ \diagdown NH_2 \end{matrix}$.

This is an amido-isethionic acid, and may be made artificially by a laboratory synthesis, as well as derived from the taurocholic acid of the bile. It assumes the form of large prisms, soluble in water, and is a remarkably stable compound. Taurin has been extracted from several organs of the mammalian body.

Leucin. $C_6H_{13}NO_2$ or $CH_3, CH_2, CH_2, CH_2, CH(NH_2), CO_2H$ —i. e., an amido-caproic acid.

This compound, which may be obtained from the pancreas, spleen, thymus, and thyroid bodies, the liver, etc., and occurs as a product of natural and artificial pancreatic digestion, and in the urine in acute atrophy of the liver, in thin whitish, glistening, flat crystals, soluble in water. Leucin is one of the chief products of the decomposition of nitrogenous (proteid) matter.

Asparagin. $C_4H_8N_2O_3$, or $C_2H_5(NH_2) \begin{matrix} \diagup CONH_2 \\ \diagdown CO_2H \end{matrix}$ —i. e.,

Amido-succinamic acid.

Found in many plants—as asparagus, licorice, beets, peas, beans, etc.—but not in the animal body, so far as is yet known.

Aspartic acid (or Amido-succinic acid).

$C_4H_7NO_4$ or $C_2H_3(NH_2) \begin{matrix} \diagup CO_2H \\ \diagdown CO_2H \end{matrix}$.

Found, like the preceding, most abundantly in seeds, but said also to occur, in minute quantity, among the products of pancreatic digestion.

Glutaminic acid. $C_5H_9NO_4$.

Seems to occur, under similar natural conditions, to those giving rise to the preceding compound. It has not, however, as yet been shown to arise in the digestive processes of animals.

Cystin. $C_3H_7NSO_2$.

By some chemists this compound is believed to be an amido-acid. It appears occasionally in the urine, but is chiefly of importance as making up the greater part of certain urinary calculi in men, dogs, etc. The body is crystalline: insoluble in water, alcohol, and ether, but soluble in ammonia, other alkalies, and the mineral acids.

Acids of the Benzine or Aromatic Series.

Benzoic acid. $C_6H_5.CO_2H$.

The acid itself is not known to exist in the body, but may arise in urine, especially that of the herbivora, from fermentative decomposition:

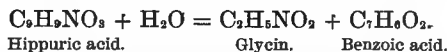

Benzoic acid is very sparingly soluble in water, but readily dissolved by alcohol and ether.

Hippuric acid (Benzoyl-Glycin, or Benzoyl-amido-acetic Acid). $C_9H_9NO_3$.

This acid abounds in the urine of the herbivora, being derived, probably, from some benzoic residue in the food (hay). It occurs in only small quantity in the urine of man. It may be obtained in prisms, soluble in boiling water and in alcohol.

Phenol (Carbolic acid). $C_6H_5.OH$.

This compound occurs under the same circumstances as indol in the alimentary tract, and may be extracted from the fæces and the urine. Slightly soluble in water, it readily dissolves in alcohol and ether.

Tyrosin. $C_9H_{11}NO_3$.

This substance, the molecular constitution of which is still in doubt, is certainly an aromatic body, which may be obtained in needles; soluble in hot water, acids, and alkalies, but insoluble in alcohol and ether.

Tyrosin occurs with leucin in the decomposition of proteids, and abundantly in the natural and artificial digestion of the proteids, by trypsin. A substance greatly resembling it has been made artificially, in the laboratory, by a synthesis.

I N D E X.

- Aberration, chromatic, 573.
 spherical of the lens, 572.
- Absorption of digested food, 341.
 by lymphatics, 341.
 by skin, 418.
- Accelerator nerves of heart, 270.
- Accommodation of eye, 565.
- Act of inspiration, 370.
- Acid albumin, 673.
- Acids, fatty series, 680.
 acrylic or oleic series, 681.
 glycolic series, 682.
 oxalic series, 683.
 bile series, 684.
 benzine or aromatic series, 689.
- Afferent nerves, 482.
- Affections of retina, 482, 578.
- After-images, 589.
- Air, entrance to and exit from lungs, 369.
 quantity respired, 378.
 inspired and expired, comparison of,
 381.
- Albumin, native, 672.
 egg, 672.
 serum, 672.
 acid, 673.
 alkali, 673.
- Allantoin, 688.
- Allantois, 75.
- Alteration of generations, 27.
- Amido-succinamic acid, 689.
- Amnion, 74.
- Amœba, morphology and physiology of,
 12, 13.
- Amyolytic action of saliva, 306.
- Amylopsin, 316.
- Anacrotic pulse, 249.
- Anæmia, 164.
- Animal chemistry, 671.
 heat, 461.
 body, 27.
 kingdom, classification of, 33.
- Anode, 197.
- Anomalies of refraction, 574.
- Anterior fasciculi, 488.
 radicular zones, 488.
- Antero-median columns, 488.
- Aphasia, 534.
- Apnœa, 398.
- Appendix.
- Area pellucida, 67.
 opaca, 67.
- Arteries, 221.
- Asparagine, 689.
- Aspartic acid, 689.
- Asphyxia, respiration and circulation in,
 404.
 pathological, 406.
- Astigmatism, 573.
- Auditory ossicles, 607.
 impulses, 610.
 sensations, 615.
 perceptions, 615.
 judgments, 615
 discriminations, 616.
- Auricles of heart, 218.
- Automatism, 214.
- Axis cylinder of nerve, 196.
- Bacteria, 18.
- Benzoic acid, 689.
- Bile, composition of, 311.
 salts, 312.
 pigments, 312, 684.
 digestive action of, 313. ✓
 comparative, 314.

- Bile, secretion of, 323.
 Bilirubin, 684.
 Biliverdin, 685.
 Biology general, 1.
 Blastoderm, 67.
 Blind-spot, 587.
 Blood, 147.
 comparative, 148.
 Blood-cells, size of, 149.
 varieties of, 149.
 ratio of varieties of, 150.
 history, 151.
 decline and death of, 153.
 Blood, morphological elements of, 149.
 chemical composition of, 154.
 quantity and distribution of, 156.
 coagulation, 157.
 clinical and pathological, 163.
 summary of physiology of, 165.
 supply, influence of, 200.
 circulation of, 216-221.
 velocity of, 224.
 pressure, 224-228.
 quantity of, 275.
 arterial, 383.
 venous, 383.
 carbon dioxide in, 389.
 vessels, origin of, 97.
 Brain, 498.
 circulation in, 525.
 Broca's convolution, 525.
 Bronchial tubes, structure of, 368.
 Bulbus arteriosus, 99.
 Burdach, columns of, 498.

 Capillaries, 281.
 Carbohydrates, 140, 678.
 Cardiac movements, 232.
 sounds, 235.
 cycle, 240.
 Carnin, 688.
 Carbon dioxide in blood, 389.
 Casein, 291, 673.
 Catelectrotonus, 197.
 Causes of heart-sounds, 236.
 Causation of heart-beat, 264.
 Caudate nucleus, 536.
 Cell, 5.
 Cellulose, 7.
 Cerebro-cerebellar fibers, 519.
 Cerebro-spinal fibers, 519.

 Cerebral cortex, 521.
 time, 535.
 Cerebro-spinal and system of nerves, 626.
 relations of, 636.
 Cerebrum general, 500.
 functions of its convolutions, 505.
 Cerebellum, functions of the, 541.
 Chemical constitution of the animal body, 135.
 Chemical changes in muscle, 192.
 Cheyne-Stokes respiration, 398.
 Chitin, 678.
 Chlorophyl, 11.
 Choletelin, 685.
 Cholesterin, 684.
 Chondrin, 677.
 Chorion, 78.
 Chromatic aberration, 573.
 Chronographs, 171.
 Chyle, 342.
 Cicatricula, 67.
 Cilia, 12.
 Ciliary ganglion, 631.
 movements, 168.
 Circulation, diagram of, 224.
 under the microscope, 226.
 changes in, after birth, 121.
 in the brain, 525.
 influenced by respiration, 400.
 Circulatory and respiratory systems, man, 664.
 Classification of animal kingdom, 33.
 Classification and distinguishing characters of proteids, 138.
 Clinical and pathological, blood, 163.
 re nerve, 198.
 pulse, 251.
 saliva, 308.
 liver, 325.
 stomach, 336.
 vomiting, 339.
 lymph, 353.
 excretion, 354.
 digestion, 357.
 respiration, 379.
 asphyxia, 406.
 respiration, 408.
 glycogen, 435.
 fat, 445.
 heat, 467.
 vision, 602.
 hearing, 609.

- Clinical and Pathological, taste, 625.
 spinal nerves, 627.
 cranial nerves, 629.
 voice, 646.
 speech, 651.
- Coagulation of the blood, 157.
- Coitus, 121.
- Collateral fibers, 519.
- Color-sensations, 583.
- Color-blindness, 585.
- Columns of Türk, 488.
 Burdach, 489.
 Gall, 489.
- Commissural fibers in brain, 518.
- Comparative *re* blood, 148.
 heart's pulsations, 243.
 pulse, 251.
 circulation, 253.
 capillaries, 281.
 digestion, 296, 319, 357.
 teeth, 304.
 saliva, 308.
 bile, 314.
 stomach, 330.
 swallowing, 335.
 vomiting, 339.
 movements of lymph, 343.
 respiration, 375.
 hæmoglobin, 389.
 protective function of skin, 313.
 respiration by skin, 415.
 kidney, 419.
 urine, 425.
 fat, 445.
 heat, 462.
 spinal cord, 495.
 vision, 597.
 hearing, 616.
 smell, 622.
 taste, 626.
 voice and speech, 647.
 locomotion, 659.
 man, 668.
- Conjugation, 17.
- Constitution of animal body, 137.
- Constitution, chemical, of the animal body, 135.
- Constituents of dead muscle, 192.
- Contraction, tetanic, 182.
 a single simple muscular, 178.
 law of, 198.
 of pupil (myosis), 571.
- Contrast, 587.
- Co-ordination, 490.
 of the two eyes in vision, 591.
- Corpuscles, composition of, 155.
- Corpus luteum, 113.
 striatum, functions of, 536.
- Corpora quadrigemina, functions of, 539.
 striata, 518.
- Coughing, 406.
- Cranial nerves, 628.
- Cramp, 205.
- Creatin, 197, 687.
- Creatinin, 446.
- Crura cerebri, functions of, 541.
- Crusta, 538.
- Crying, 406.
- Curve, the muscle, 180.
- Cystin, 689.
- Death, 668.
- Decussation, 489.
- Defecation, 337.
- Deglutition, 332.
- Dentition, 665.
- Development, physiological aspects of, 112.
 post-embryonic, of blood-cells, 152.
- Dextrin, 679.
- Dextrose, 678.
- Diapedesis, 281.
- Diastole, 240.
- Diabetes, artificial, 435.
- Dicrotic, 249.
- Dicidua vera, scrotina, reflexa, 81.
- Diet, 452.
 fats and carbohydrates in, 457.
 salts, etc., in, 458.
 pathological, 459.
- Diffusion-circles 565.
- Differentiation of unicellular animals, 20.
- Digestion of food, 290.
 comparative, 296, 319, 357.
 pathological, 357.
 summary, 364.
- Digestive juices, 306.
 action of bile, 313.
 organs, self-digestion of, 327.
 movements, 331.
 evolution, 363.
 system, man, 664.
- Dilation (mydriasis), 572.
- Dioptrics of vision, 563.

- Direct observation, method of, 141.
 cerebellar tracts, 488.
 Discus proligerus, 58.
 Divisions of food-stuffs, 290.
 Dreaming, 527.
 Ductus venosus, 104.
 Dyspnœa, 397.

 Ectoplasm, 7.
 Efferent nerves, 482.
 Elasticity of muscle, 187.
 Elastin, 677.
 Electrical phenomena of muscle, 188.
 organs, 199.
 Electrodes non-polarizable, 189.
 Electrotonus, 197.
 Embryo, 54.
 development of, 90.
 Embryological, alimentary tract, 295.
 nervous system, 542.
 vision, 562.
 Endoplasm, 7.
 End-plates, nerve, 170.
 End-bulbs of Krause, 549.
 Energy of the animal body, 459.
 Entoptic phenomena, 574.
 Epiblast, 93.
 Estimation of the size and distance of
 objects, 595.
 Eustachian tube, 609.
 Evolution of vascular system, 285.
 digestive organs, 363.
 respiratory organs, 409.
 uric acid, 448.
 digestion, 468.
 spinal cord, 496.
 nervous system, 543.
 evidences of, 43.
 placenta, 89.
 organic, reconsidered, 127.
 vision, 600.
 voice and speech, 652.
 locomotion, 662.
 hearing, 616.
 Excretion of perspiration, 416.
 by kidney, 419.
 pathological, 354.
 Experimental, reflex action, 212.
 Expulsion of urine, 429.
 Extractives of muscle, 194.
 Eye, optical imperfections of, 572.
 protective mechanisms, 596.

 Fæces, 353.
 Fallopian tube, 114.
 Fatigue, 200.
 Fats, the, 139.
 peculiar, 140.
 in milk, 292.
 Fat, the construction of, 440.
 formation of, 441.
 pathological, 445.
 comparative, 445.
 Feeding experiments, 454.
 Ferments, unorganized, 160.
 Fibrin, 675.
 Fibrin-ferment, 160.
 Fibrinogen, 159, 674.
 Fission, 11.
 Fœtal circulation, 103-118.
 Food, digestion of, 290.
 special considerations, 358.
 Food-stuffs, divisions of, 290.
 Forced movements, 504.
 Formic acid, 680.
 Frog, the rheoscopic, 191.
 Fungi, 15.

 Ganglia, cardiac, 273.
 Ganglion, ciliary, otic, etc., 631.
 Gas-pump, mercurial (Ludwig's), 384.
 Gases, foreign in respiration, 392.
 Gastric juice, 308.
 characters of, 309.
 Gastrula, the, 66.
 Gelatine, 677.
 Gelatine in diet, 457.
 Gemmation, 11.
 Germinal vesicle, 54.
 spot, 54.
 ridge, 57.
 Globin, 674.
 Globulins, 674.
 Glomerulus, 42.
 Glycin, 688.
 Glycocholic acid, 312.
 Glycocoll (glycin), 312.
 Glycogen, 432, 679.
 uses of, 434.
 pathological, 435.
 Glutamic acid, 689.
 Goll, columns of, 489.
 Goltz, experiments of, 523.
 Graafian follicles, 57.
 Gray matter of cerebrum, 512.

- Graphic method, applications of, 171.
 Growth at different periods, 663.
 Guanin, 688.
- Habit, the law of, 40.
 Hæmatoblasts, 149.
 Hæmatin, 389.
 Hæmin, 389.
 Hæmoglobin, 385
 comparative, 389.
 Hearing, 604.
 Heart, the mammalian, 217, 232.
 the action of, 223.
 impulse, 233.
 sounds, causes of, 236.
 work, 241.
 nervous system in relation to, 261.
 beat, causation of, 270.
 accelerator, nerves of, 385.
- Heat, animal, 461.
 comparative, 462.
 production of, 465.
 pathological, 467.
- Heat-producing power of foods, 460.
- Hermaphroditism, 25.
- Hibernation, 465, 470, 527.
- Hiccough, 407.
- Hippuric acid, 440.
- Holoblastic, 70.
- Homoiothermer, 465.
- Horopter, the, 594.
- Hyphæ, 15.
- Hypernœa, 397.
- Hydra, 22.
- Hydrobilirubin, 685.
- Hypnotism, 528.
- Hypoblast, 69, 93.
- Hypoxanthin, 688.
- Imperfections of visual perceptions, 587.
- Impulse of the heart, 233.
- Impulses, path of, in spinal cord, 491.
- Indican, 685.
- Indigo series, 685.
- Indol, 313, 686.
- Inductorium, Du Bois-Reymond's, 175.
- Influence of pigment of macula lutea, 539.
- Infusoria, 22.
- Inhibition, venous, 215.
 of reflexes, 485.
- Inosit, 679.
- Intercerebral fibers, 518.
- Internal capsule, 536.
- Intestinal movements, 337.
- Inspiration, act of, 370.
- Irradiation, 587.
- Irritability of muscle and nerve, 169.
- Juice, gastric, 308.
 pancreatic, 315.
- Juices, the digestive, 306.
 characteristics of, 307.
- Karyokinesis, 6, 65.
- Katacrotic pulse, 249.
- Kathode, 197.
- Keratin, 678.
- Kidney, excretion by, 419.
 comparative, 419.
- Kymograph, 231.
- Kynurenic acid, 688.
- Latent period, 181.
- Lardacein, 677.
- Laughing, 406.
- Law of contraction, 198.
 rhythm, 206.
- Lecithin, 683.
- Lenticular nucleus, 536.
- Leucin, 316.
- Leucocytes, 150.
- Liquor amnii, 74.
 sanguinis, 150.
- Liver, metabolism of, 490.
- Localization, in cerebral cortex, 523, 530.
- Locomotion, 655.
- Locomotor ataxia, 490.
- Lymph, 342.
 movements of, comparative, 343.
- Lymphatics, absorption of food by, 341.
- Macula lutea, influence of pigment of, 539.
- Malpighian tubules, 421.
- Maltose, 679.
- Man at different periods of his existence, 663.
- Man's place in the animal kingdom, 35.
- Maturity (puberty), 666.
- Mastication, 332.
- Maximal stimulus, 185.
- Medulla oblongata, 542.
- Membrana tympani, 606.

- Membranes, embryonic, of birds, 72.**
 fœtal of mammal, 76.
Menstruation, 113.
Meroblastic, 70.
Mesoblast, 93.
Mesonephros, 106.
Metanephros, 106.
Metabolism, the, of the body, 431.
 of the liver, 432.
 of the spleen, 436.
 in formation of urea, uric acid, hippu-
 ric acid, etc., 446.
 proteid, 455.
 influence of nervous system on, 471.
 summary of, 476.
Metazoa, 5.
Methæmoglobin, 389.
Micturition, 430.
 pathological, 430.
Middle ear, muscles of, 608.
Milk, proteids of, 291.
 fats, 292.
 sugar of, 292, 679.
 salts, 292.
Minimal stimulus, 185.
Misconceptions as to comparative size,
 etc., of objects, 590.
Moist chamber, 176.
Morphology, definition of, 1.
Motor area, 525.
Movements, cardiac, 232.
 ciliary, 168.
 stomach, 335.
 intestinal, 337.
 digestive organs, 331.
 ocular, 592.
Mucin, 327, 677.
Mucor mucedo, 15.
Mucigen, 327.
Müllerian duct, 108.
Multicellular organism, 22.
Munk, experiments of, 524.
Muscle, 167.
 irritability of, 169.
 curve, 180.
 changes in, during contraction, 186.
 elasticity of, 187.
 electrical phenomena of, 188.
 electrical currents in, 190.
 chemical changes in, 192.
 dead, constituents of, 194.
 thermal changes in contracting, 195.
Muscle, unstriated, 204.
 comparative, 205.
Muscles of respiration, 372.
 of middle ear, 608.
Muscular note, 184.
 work, 199.
 sense, 557.
 energy, sources of, 461.
Mydriasis, 572.
Myosis, 571.
Myograph, pendulum, 179.
Myosin, 193, 674.
Nerve-supply, 643.
Nerves, the physiology of, 197.
 clinical and pathological, 198.
 irritability of, 169.
 afferent and efferent, 482.
 cerebro-spinal, 626.
 third, fourth, etc., 628, 629.
Nervous system, 210.
 in relation to the heart, 261.
 relation to respiration, 393.
 man, 666.
Nervous supply, muscles of mastication,
 332.
Nervous mechanism in the sexual act,
 124.
Neurin, 683.
Neuralgia, 517.
Neutral fats, 681.
Nitrogenous metabolites, 140, 686.
 equilibrium, 456.
 fats, complex, 683.
Non-crystalline bodies, 677.
Non-crystalline bodies, certain, 138.
Non-nitrogenous metabolites, 141.
Note, the muscular, 184.
Nucleus, 5.
Nucleolus, 5.
Nuclein, 678.
Objects, estimation of size and distance,
 590.
Observation, direct method of, 141.
 graphic method of, 143.
 summary of methods of, 147.
Ocular movements, 592.
Old age, 667.
Oligæmia, 164.
Oncograph, 438.
OöspERM, the, 62.

- Optic thalami, 518.
 Optic thalamus, functions of, 536.
 Optical imperfections of the eye, 572.
 Organic evolution, 41.
 Organs, electrical, 199.
 Origin, the, of the germs of life, 41.
 Ovary, origin of, 110.
 Ovulation, 115.
 Ovum, the, 54.
 origin and development of, 57.
 changes in, 59.
 fertilization of, 62.
 nutrition of, 115.
 Oxyhæmoglobin, 386.

 Pacinian corpuscles, 552.
 Pancreatic juice, 315.
 Physiology of secretion, 323.
 Paraglobulin, 159, 674.
 Parthenogenesis, 53.
 Parturition, 120.
 Patellar reflex, 494.
 Path of impulses in spinal cord, 491.
 Peduncles of the brain, 537.
 Pepsin, 311.
 Peptone, 310, 315.
 Peptones, 675.
 Perspiration, excretion of, 416.
 Pettenkofer's test, 684.
 Phenol, 690.
 Physiology of secretion, 319.
 sweating, 417.
 Pigments of urine, 685.
 Placenta, 80.
 the discoidal and meta-discoidal, 81.
 the zonary, diffuse, polycotyledonary, 86.
 evolution of, 89.
 Poikilothermer, 465.
 Polar cells of globules, 59.
 Polyps, 22.
 Pons Varolii, 518.
 functions of, 541.
 Predierotic, 249.
 Pressure sensations, 554.
 Pressures, endocardial, 238.
 Primitive streak, 71.
 groove, 71.
 Pro-amnion, 78.
 Production of heat, 465.
 Pronephros, 95.
 Pronucleus, female, 60.

 Protagon, 683.
 Protective mechanism of the eye, 596.
 Proteid metabolism, 455.
 Proteids, 671.
 properties and classification of the, 672.
 general characteristics of, 138.
 classification and distinguishing characters of, 138.
 of milk, 291.
 metabolism, 455.
 tests for, 672.
 coagulated, 675.
 Protococcus, morphology and physiology of, 11, 12.
 Protoplasm, 2, 27.
 Protovertebræ, 95.
 Psychological aspects of vision, 586.
 Pulse, the, 244.
 venous, 251.
 Pupil, alterations in the size of the, 569.

 Quantity of air respired, 373.

 Reaction time, 536.
 Reduced reaction time, 536.
 Reflex action, 211.
 functions of spinal cord, 484.
 time, 486.
 Reflexes, inhibition of, 485.
 Refraction, anomalies of, 574.
 Regulation of temperature, 464.
 Regurgitation, 340.
 Reproduction, 50.
 Research and reasoning, physiological, 141.
 Respiratory system, 365.
 sounds, 379.
 Respiration, muscles of, 372.
 types of, 373.
 comparative, 375.
 pathological, 379.
 in the blood, 383.
 in the tissues, 392.
 relation of nervous system to, 393.
 influence of condition of blood in, 397.
 Cheyne-Stokes, 398.
 effects of variations in atmospheric pressure, 399.
 influence on circulation, 400.
 clinical and pathological, 408.
 evolution, 409.
 Resting stage of ovum, 65.

- Rhythm, law of, 206.
 in nature, 36.
 appetite, 362.
 respiratory, 379.
- Retina, affections of, 578.
- Retinal stimulation, laws of, 580.
- Rigor mortis, 192.
- Rheoscopic frog, 191.
- Rouleaux of blood-cells, 158.
- Saliva, 306.
 amylolytic action of, 306.
 of parotid gland, 307.
 comparative, 308.
 pathological, 308.
- Salivary glands, physiology of secretion of, 319.
- Salts of milk, 292.
- Sarcolemma, 170.
- Secretion, physiology of, 319.
 nature of the act of, 326.
 of urine, 426.
- Segmentation of ovum, 65.
- Segregation, 130.
- Self-digestion of digestive organs, 329.
- Semicircular canals, co-ordinating functions of, 502.
- Sensations, visual, 576.
- Senses, general remarks, 548.
- Sensory area, 525.
- Serum, composition of, 155.
- Sexes at different periods, 667.
- Sexual selection, 42.
- Sighing, 407.
- Skatol, 686.
- Skin, functions of, 412.
 protective functions of, comparative, 413.
 respiration by, comparative, 415.
 absorption by, 418.
 as an organ of sense, 451.
- Sleep, 526.
- Smell, sense of, 620.
- Sneezing, 407.
- Sobbing, 406.
- Solidity in vision, 595.
- Somatopleure, 74.
- Somnambulism, 529.
- Sound, cardiac, Marey's, 234.
- Sounds, cardiac, 235.
 respiratory, 381.
- Special considerations as to food, 358.
- Special considerations as to digestion, 468.
 vision, 597.
 hearing, 616.
 voice and speech, 652.
- Spectrum of hæmoglobin, 386.
- Spermatozoön, 52.
 origin of, 61.
- Speech, 649.
 consonants, 650.
- Spherical aberration, 572.
- Sphygmograph, the, 247.
- Spinal nerves, 626.
 cord, 480.
 reflex functions of, 484.
 as a conductor of impulses, 487.
 automatic functions of, 493.
 comparative, 495.
 evolution, 496.
- Splanchnopleure, 74.
- Sporangia, 15.
- Spleen, metabolism of, 436.
 nervous system's influence on, 439.
 pulp, comparative, 437.
- Stasis, 281.
- Starvation, influence on metabolism, 450.
- Steapsin, 316.
- Stimulation, laws of retinal, 581.
- Stimulus, 170.
 maximal, 185.
 minimal, 185.
 sub-maximal, 185.
- Stomach of ruminants, 300.
 physiology of secretion by, 323.
 comparative, 330.
 movements of, 335.
- Subjective phenomena, 591.
- Succus entericus, 317.
- Summary of physiology of blood, 165.
 muscle and nerve, 208.
 circulation, 286.
 digestion, 355-364.
 respiration, 410.
 functions of the skin, 418.
 urine, 430.
 reproduction, 89.
 voice and speech, 652.
 spinal cord, 497.
 functions of the brain, 548.
 of evidences of evolution, 47.
- Swallowing, comparative, 334, 335.
- Sweating, 415.
 physiology of, 417.

- Synopsis, brief, of physiology of vision, 602.
 physiology of hearing, 620.
 Systole, 240.
- Tactile sensibility, 555.
 Tambour of Marey, 177.
 Taste, sense of, 623.
 Taurin, 312.
 Taurocholic acid, 312.
 Teeth, comparative, 304.
 Tegmentum, 538.
 Temperature, influence of, on muscle, 202.
 regulation of, 464.
 Testes, 61.
 Tests for proteids, 672.
 Tetanic contraction, 183.
 Thermal changes in contracting muscle, 195.
 sensations, 554.
 Thoracic breathing, 373.
 Time, cerebral, 535.
 Tissues, the contractile, 166.
 respiration in, 392.
 comparative, 167.
 Traube-Hering curves, 403.
 Trypsin, 316.
 Tunicin, 680.
 Türk, columns of, 488.
 Types of respiration, 373.
 Tyrosin, 316.
- Unicellular animals, 20.
 Umbilical vesicle, 72.
 Urea, 424, 686.
 and uric acid, metabolism, in formation of, 446.
 nitrate, 687.
 Uric acid, 448.
 evolution, 448.
 Urine, chemically and physiologically considered, 422.
 quantity, 423.
 constituents of, 423.
 salts of, 424.
 abnormal, 425.
 comparative, 425.
 secretion of, 426.
 expulsion of, 429.
 pigments of, 685.
 Urobilin, 685.
 Uroerythrin, 685.
- Urogenital system, development of, 106.
 Uses of glycogen, 434.
- Vagus, influence on the heart, 265.
 Valves of the heart, 219.
 Valvulæ conniventes, 357.
 Variations, functional, in muscle, 207.
 of cardiac pulsation, 242.
 Vascular system, evolution of the, 285.
 development of the, 103.
 Vaso-motor influences, 277.
 Vas deferens, origin of, 110.
 Veins, 221.
 valves of, 222.
 Velocity, the, of the blood, 224.
 of nervous impulse, measurement of, 181.
 Venous pulse, 251.
 Ventricles, of the heart, 218.
 Vision, 559.
 embryological, 562.
 dioptrics of, 563.
 psychological aspect of, 583.
 synopsis of physiology of, 602.
 astigmatic, 573.
 spherical aberration of, 572.
 chromatic aberration of, 573.
 entoptic phenomena of, 574.
 anomalies of refraction of, 574.
 sensations of, 576.
 affections of the retina in, 578.
 psychological aspects of, 586.
 co-ordination of the two eyes in, 591.
 estimation of solidity by, 595.
- Visual sensations, 576.
 impulses, nature of, 580.
 angle, 582.
 perceptions, imperfections of, 587.
- Vitellin, 674.
 Vitelline membrane, 55.
 Voice and speech, 639.
 registers and falsetto, 644.
 pathological, 646.
 comparative, 647.
 evolution, 652.
 summary, 652.
- Vomiting, comparative, 338, 339.
 pathological, 339.
- Wolffian duct, 98, 100.
 bodies, 100.
- Work, muscular, 199.
 of the heart, 241.

Xanthin, 194.

Yawning, 407.

Yeast, morphology, chemistry, and physiology of, 9, 10.

Zona radiata, 55.

Zoöglæa, 18.

Zygospore, 17.

Zymogen, 328.

THE END.

THE
NEW YORK MEDICAL JOURNAL,
A WEEKLY REVIEW OF MEDICINE,

PUBLISHED BY
D. APPLETON & CO.,



EDITED BY
FRANK P. FOSTER, M. D.,

HAS for its principal features LECTURES, ORIGINAL COMMUNICATIONS, CLINICAL REPORTS, CORRESPONDENCE, BOOK NOTICES, LEADING ARTICLES, MINOR PARAGRAPHS, NEWS ITEMS, LETTERS TO THE EDITOR, PROCEEDINGS OF SOCIETIES, REPORTS ON THE PROGRESS OF MEDICINE, and MISCELLANY.

So rapidly has the JOURNAL gained in public favor that it is now **acknowledged** to be the **Leading Journal of America**. It numbers among its contributors many of the most eminent men in the profession, whose papers are valuable additions to medical literature. The **Society Reports**, of which each number of the JOURNAL contains several, are full of interesting and instructive matter. The **Reports on the Progress of Medicine**, written by men especially qualified in their respective branches, cover the most recent advances in medical science. Current events of the day are treated under the head of **News Items**, from a medical stand-point. Everything new and useful in materia medica is chronicled under the head of **Miscellany** in "Therapeutical Notes," which appear weekly, and are alone well worth the subscription price of the JOURNAL.

The arrangement of the matter in the JOURNAL enables us to furnish a greater amount of reading-matter in its twenty-eight double-columned pages than is given by any other journal of its class in America. Illustrations are more freely given than in most journals, and are, as a rule, much better executed.

To the physician who desires to keep abreast of the times in medicine and surgery, "**The New York Medical Journal**" is an indispensable requisite, and to the ADVERTISER who wishes to reach the medical profession it is a medium second to none, as its rapidly increasing circulation, distributed throughout the entire Union, will abundantly prove.

The volumes begin with January and July of each year. Subscriptions must be arranged to expire with the volume.

Subscription price, \$3.00 per Annum.

New York: D. APPLETON & CO., 1, 3, & 5 Bond Street.

JOURNAL OF CUTANEOUS AND GENITO-URINARY DISEASES.

Edited by { PRINCE A. MORROW, A. M., M. D., and
JOHN A. FORDYCE, M. D.

PUBLISHED MONTHLY.

WITH the number for January, 1889, this JOURNAL enters upon the seventh year of its publication. The history of the JOURNAL has been one of progression, and, under the present editorial management, there can be no doubt that it will preserve and increase the reputation already established.

Devoted to the diseases indicated in its title, the JOURNAL will be contributed to by the most eminent dermatologists and syphilographers in this country. Whenever the subject requires illustration, wood-cuts or chromo-lithographs will be employed.

Letters from Europe, one or more of which will appear in each issue of the JOURNAL, will keep the reader informed of the advances in this department of medicine at the great medical centers—Vienna, Berlin, and Paris.

A feature of the JOURNAL will be the publication of abstracts of translations of notable papers and selections from foreign journals.

Due prominence will be given to Society Transactions, including papers read and the discussions had thereon, so far as they have a bearing upon the subjects to which the pages of the JOURNAL are devoted.

Both the editors and the publishers will put forth every effort to make the JOURNAL instructive, attractive, and a representative one of its class; and they feel assured that every practitioner, whose work brings him in contact with cutaneous or genito-urinary diseases, will find it of great value and assistance to him.

Subscription price, \$2.50 per Annum.

Subscriptions should be arranged to expire with either June or December number.

New York: D. APPLETON & CO., 1, 3, & 5 Bond Street

ESTABLISHED BY EDWARD L. YOUMANS.

THE POPULAR SCIENCE MONTHLY,

EDITED BY WILLIAM JAY YOUMANS,

Well known as a trustworthy medium for the spread of scientific truth in popular form, is filled with articles of interest to everybody, by the ablest writers of the time. Its range of topics, which is widening with the advance of science, includes—

PREVENTION OF DISEASE AND IMPROVEMENT OF THE RACE.
AGRICULTURAL AND FOOD PRODUCTS.

SOCIAL AND DOMESTIC ECONOMY.

POLITICAL SCIENCE, OR THE CONDUCT OF GOVERNMENT.

SCIENTIFIC ETHICS; MENTAL SCIENCE AND EDUCATION.

MAN'S ORIGIN AND DEVELOPMENT.

RELATIONS OF SCIENCE AND RELIGION.

THE INDUSTRIAL ARTS.

NATURAL HISTORY; DISCOVERY; EXPLORATION, ETC.

With other illustrations, each number contains a finely engraved PORTRAIT of some eminent scientist, with a BIOGRAPHICAL SKETCH.

Among its recent contributors are :

W. A. HAMMOND, M. D.,
HERBERT SPENCER,
DAVID A. WELLS,
T. H. HUXLEY,
SIR JOHN LUBBOCK,
EDWARD ATKINSON,
T. D. CROTHERS, M. D.,
W. K. BROOKS,
E. D. COPE,
DAVID STARR JORDAN,
T. MITCHELL PRUDDEN, M. D.,
JOSEPH LE CONTE,
APPLETON MORGAN,
FELIX L. OSWALD,
J. S. BILLINGS, M. D.,

BENJ. WARD RICHARDSON, M. D.,
ANDREW D. WHITE,
F. W. CLARKE,
HORATIO HALE,
EDWARD S. MORSE,
J. S. NEWBERRY,
WALTER B. PLATT, M. D.,
EUGENE L. RICHARDS,
THOMAS HILL,
N. S. SHALER,
D. G. THOMPSON,
AMBROSE L. RANNEY, M. D.,
GRANT ALLEN,
SIR WILLIAM DAWSON,
J. HUGHLINGS JACKSON, M. D.

Subscription price, \$5.00 per Annum.

New York: D. APPLETON & CO., 1, 3, & 5 Bond Street.

TEXT-BOOK OF HUMAN PHYSIOLOGY, FOR THE USE OF STUDENTS AND PRACTITIONERS OF MEDICINE.

Third edition, revised and corrected.

By AUSTIN FLINT, JR., M. D.,

Professor of Physiology and Physiological Anatomy, in the Bellevue Hospital Medical College, New York; Fellow of the New York Academy of Medicine, etc.

In one large 8vo volume of 978 pp., elegantly printed on fine paper, and profusely illustrated with three Lithographic Plates and 315 Engravings on Wood. Cloth, \$6.00; sheep, \$7.00.

"The author of this work takes rank among the very foremost physiologists of the day, and the care which he has bestowed in bringing this third edition of his text-book up to the present position of his science is exhibited in every chapter."—*Medical and Surgical Reporter (Philadelphia)*.

"In the amount of matter that it contains, in the aptness and beauty of its illustrations, in the variety of experiments described, in the completeness with which it discusses the whole field of human physiology, this work surpasses any text-book in the English language."—*Detroit Lancet*.

"We have not the slightest intention of criticising the work before us. The medical profession and colleges have taken that prerogative out of the hands of the journalists by adopting it as one of their standard text-books. The work has very few equals and no superior in our language, and everybody knows it."—*Hahnemannian Monthly*.

"The student and the practitioner, whose sound practice must be based on an intelligent appreciation of the principles of physiology, will herein find all subjects in which they are interested fully discussed and thoroughly elaborated."—*College and Clinical Record*.

"We need only say that in this third edition the work has been carefully and thoroughly revised. It is one of our standard text-books, and no physician's library should be without it. We treasure it highly, shall give it a choice, snug, and prominent position on our shelf, and deem ourselves fortunate to possess this elegant, comprehensive, and authoritative work."—*American Specialist*.

THE SOURCE OF MUSCULAR POWER. Arguments and Conclusions drawn from Observations upon the Human Subject under Conditions of Rest and of Muscular Exercise.

By AUSTIN FLINT, JR., M. D.,

Professor of Physiology in the Bellevue Hospital Medical College, New York, etc., etc.

8vo, 103 pp. Cloth, \$1.00.

ON THE PHYSIOLOGICAL EFFECTS OF SEVERE AND PROTRACTED MUSCULAR EXERCISE. With Special Reference to its Influence upon the Excretion of Nitrogen.

By AUSTIN FLINT, JR., M. D.,

Professor of Physiology in the Bellevue Hospital Medical College, New York, etc., etc.

8vo, 91 pp. Cloth, \$1.00.

New York: D. APPLETON & CO., 1, 3, & 5 Bond Street.

*** THE BOOKS advertised in this LIST are commonly for sale by booksellers in all parts of the country; but any work will be sent by D. APPLETON & Co. to any address in the United States, postage prepaid, on receipt of the advertised price.*

CATALOGUE

OF

MEDICAL WORKS.

BARKER. On Sea-Sickness. By **FORDYCE BARKER, M. D.** 16mo, 36 pages. Flexible cloth, 75 cents.

Reprinted from the "New York Medical Journal." By reason of the great demand for the number of that Journal containing the paper, it is now presented in book form, with such prescriptions added as the author has found useful in relieving the suffering from sea-sickness.

BARKER. The Puerperal Diseases. Clinical Lectures delivered at Bellevue Hospital. By **FORDYCE BARKER, M. D.**, Clinical Professor of Midwifery and the Diseases of Women in the Bellevue Hospital Medical College; late Obstetric Physician to Bellevue Hospital; Surgeon to the New York State Woman's Hospital, etc. Fourth edition. 8vo, 526 pages. Cloth, \$5.00; sheep, \$6.00.

"For nearly twenty years it has been my duty, as well as my privilege, to give clinical lectures at Bellevue Hospital on midwifery, the puerperal and the other diseases of women. This volume is made up substantially from phonographic reports of the lectures which I have given on the puerperal diseases. Having had rather exceptional opportunities for the study of these diseases, I have felt it to be an imperative duty to utilize, so far as lay in my power, the advantages which I have enjoyed for the promotion of science, and, I hope, for the interests of humanity."—*From Author's Preface.*

BARTHOLOW. A Treatise on the Practice of Medicine, for the Use of Students and Practitioners. By **ROBERTS BARTHOLOW, M. A., M. D., LL. D.**, Professor of Materia Medica and General Therapeutics in the Jefferson Medical College of Philadelphia; recently Professor of the Practice of Medicine and of Clinical Medicine in the Medical College of Ohio, in Cincinnati, etc., etc. Sixth edition, revised and enlarged. 8vo. Cloth, \$5.00; sheep or half russia, \$6.00.

The same qualities and characteristics which have rendered the author's "Treatise on Materia Medica and Therapeutics" so acceptable are equally manifest in this. It is clear, condensed, and accurate. The whole work is brought up on a level with, and incorporates, the latest acquisitions of medical science, and may be depended on to contain the most recent information up to the date of publication.

"The large number of readers who are already familiar with this work will be glad to learn that the present edition has been carefully revised by the author, considerably enlarged, and is intended to include all that has in the most recent period been added to practical medicine, especially in its clinical horizon. The author felicitates himself on the large sales obtained for the previous editions, and there is no reason why the present one should not continue to gain in the opinion of many. What doubtless lends the volume one of its special attractions to these is the authoritative expressions which are frequent in its pages on subjects where

favorable. In the preface to this edition is an announcement which will be welcomed by all of Dr. Bartholow's numerous admirers, namely, that he has now in preparation another work on the 'Principles of Medicine' which, together with the one under review, and his 'Materia Medica and Therapeutics,' shall constitute a trio of volumes, each containing matter complementary to the others. Certainly three such volumes must constitute a monument which will render the writer's fame almost undying."—*Medical Press of Western New York.*

"Professor Bartholow announces in the preface of this edition his intention of preparing a work in three volumes which shall cover the whole domain of special pathology and therapeutics. The volume on 'Materia Medica' appeared some time ago, but the third volume, which will treat of the 'Principles of Medicine,' is now in course of careful preparation, and will, when published, complete a most valuable set. The present edition of Professor Bartholow's 'Practice' is considerably larger than the last, several new subjects having been introduced, together with numerous new illustrations. It is deservedly popular with practitioners and students, and likely ere long to become one of the standard works on practice, if it has not already attained this position."—*Pacific Medical and Surgical Journal and Western Lancet.*

"The deserved popularity of this work is attested by the fact that the first edition was issued in 1880, that a second was demanded in three months, and that the others have followed them in rapid succession and been met by appreciative students always. The author says in his preface to this edition that he has sought to make it worthy of the approbation of his readers by increasing the practical resources of his work, devoting his attention chiefly to the clinical aspects of medicine, without overlooking the advances made in the scientific branch. This book, like the previous editions of the work, is the product of a master and an honored authority, and in its new form, with such of the latest ideas as the author can conscientiously indorse or present for consideration, continues to hold its place among the standard text-books on all matters included in it."—*North Carolina Medical Journal.*

"This valuable work appears in its sixth edition considerably enlarged, and improved materially in many respects. The arrangement of the subjects appears to be pretty much the same as in former editions, and the description of diseases is also little modified. Some new chapters have been added, however, and new subjects introduced, making the volume completely cover the entire domain of practice, without anything superfluous. Considering the immense scope of subjects, the directness of statement, and the plain, terse manner of dealing with the phenomena of disease, this practical work has no counterpart."—*Kansas City Medical Record.*

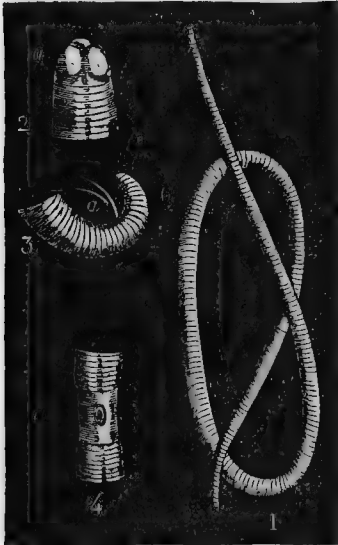

Ascaris lumbricoides.—1, complete worm; 2, head; 3, tail of the male; 4, middle of the body of female.

the reader might be left in uncertainty elsewhere. This remark applies both to pathology and treatment. The fullness with which therapeutics are taught stands in noteworthy contrast to the majority of treatises on practice. This, too, is undoubtedly a feature which will be agreeable to numerous purchasers. Some seeming excess of conciseness in certain portions is explained by the fact that this is but one volume of a series proposed by the author, which will cover the whole domain of special pathology and therapeutics."—*Medical and Surgical Reporter.*

"That six editions of such a work should be called for in six years is, perhaps, the most flattering testimonial that a book can receive, and must outweigh every other comment, favorable or un-

BARTHOLOW. On the Antagonism between Medicines and between Remedies and Diseases. Being the Cartwright Lectures for the Year 1880. By ROBERTS BARTHOLOW, M. A., M. D., LL. D., Professor of Materia Medica and General Therapeutics in the Jefferson Medical College of Philadelphia, etc., etc. 8vo. Cloth, \$1.25.

"We are glad to possess, in a form convenient for reference, this most recent summary of the physiological action of important remedies, with the

deductions of a careful and accomplished observer, regarding the applications of this knowledge to diseased states."—*College and Clinical Record.*

"There are few writers who have taken the trouble to compile the lucubrations of the multitude of scribblers who find a specific in every drug they happen to prescribe for a self-limited, non-malignant disease; and fewer who can detect the trashy chaff and garner only the ripe, plump grains. This Bartholow has done, and no one is more ripe, nor better qualified for this herculean task; and, the best of all is, condense it all in his antagonisms. No one can peruse its pregnant pages without noticing the painstaking research and large collection of authorities from which he has drawn his conclusions. The practitioner who purchases these antagonisms will find himself better qualified to cope with the multifarious maladies after its careful perusal."—*Indiana Medical Reporter*.

"The criticisms made upon these lectures have invariably been most favorable, the topic itself is one of the most interesting in the entire range of medicine, and it is treated of by the accomplished author in a most scholarly manner. Dr. Bartholow worthily ranks as one of the best writers, while at the same time one of the most diligent workers, in the medical field in all America, and there can be no doubt that this, his latest contribution to medical science, will add materially to his previously high reputation. Much profit, no little pleasure,

and material assistance in the solution of many therapeutical problems are to be obtained from a perusal of these lectures. The author has done wisely and conferred a boon by permitting their publication in the present book-form, and we are satisfied it will be extensively asked for, and just as extensively read and appreciated."—*Canada Medical and Surgical Journal*.

"It will be observed that the scope of the work is extensive, and, in justice to the author, not only is the extent of this indicated, but the character of it is also furnished. No one can read the synopsis given without being impressed with the importance and diversity of the subjects considered. Indeed, most of the important forces in therapeutics and materia medica are herein stated and analyzed."—*American Medical Bi-Weekly*.

"Probably most of our readers will consider that we have awarded this treatise high praise when we say that it seems to us the most carefully written, best thought-out, and least dogmatic work which we have yet read from the pen of its author. It is indeed a very praiseworthy book; not an original research, indeed, but, as a *résumé* of the world's work upon the subject, the best that has hitherto been published in any language."—*Philadelphia Medical Times*.

BARTHOLOW. *Treatise on Materia Medica and Therapeutics.*

Revised and enlarged. Edition of 1883, with Complete Index and Table of Contents. By ROBERTS BARTHOLOW, M. A., M. D., LL. D., Professor of Materia Medica and Therapeutics in the Jefferson Medical College; formerly Professor of the Theory and Practice of Medicine, and of Clinical Medicine, and Professor of Materia Medica and Therapeutics in the Medical College of Ohio, etc. Seventh edition, revised and enlarged. 8vo. Cloth, \$5.00; sheep, \$6.00.

The following are notices of the sixth edition:

"The very best evidence of the success of a work is the continuous and increasing demand for it. Bartholow's 'Materia Medica and Therapeutics' has followed this course since the appearance of the first edition, in June, 1876, and has compelled the publishers to again place before the profession the sixth edition. In this issue of the work the author has revised the former edition most carefully, and has included in its pages the latest and the most valuable remedies. About one hundred pages have thus been added to this valuable work, the new contributions having, as the author states, been assigned to places according to their physiological relations. The many additions, just referred to, can only be observed by a careful examination of all parts of the book. . . . The work is not only, as in former editions, well arranged, but is the most progressive one of all those now before the profession, in the thorough consideration of all therapeutic measures of value in the treatment of disease."—*Medical Register*.

"Since 1876 this work has passed through six editions, a degree of favor which is seldom accorded to medical works. . . . We have written in former issues of the *Journal* our appreciation of this volume, and we take this occasion to say that we consider it essential to every well-selected library."—*North Carolina Medical Journal*.

"It is to be naturally assumed that the appearance of six editions of this work in a period of a little more than eleven years is an indication of the measure of appreciation in which it is held by the profession. . . . The author's additions have been extensive and important, and give increased value to a work that is already recognized as occupying a very conspicuous place in the medical literature of the day."—*College and Clinical Record*.

"Since Bartholow's 'Materia Medica' appeared eleven years ago, its several editions have occupied a place of which its author may well feel proud. In the present edition we find much new matter, which, taken as a whole, adds nearly one hundred pages. The 'Clinical Index,' which contributes greatly to the value of the book, has been retained. But few books become so popular as Bartholow's 'Materia Medica.'"—*Practice*.

"Bartholow's 'Materia Medica' is a book too well known to the practitioners of medicine to need at this day any review. . . . Unquestionably the new edition is a great improvement on the old one; and even if nothing were added but a summary statement about new remedies in use since the last edition, the work would be desirable."—*Gaillard's Medical Journal*.

BASTIAN. Paralysis: Cerebral, Bulbar, and Spinal. A Manual of Diagnosis for Students and Practitioners. By H. CHARLTON BASTIAN, M. A., M. D., F. R. S.; Fellow of the Royal College of Physicians; Examiner in Medicine at the Royal College of Physicians; Professor of Clinical Medicine and of Pathological Anatomy in University College, London, etc. With 136 Illustrations. Small 8vo, 671 pages. Cloth, \$4.50.

"The work is designed to facilitate diagnosis of the various forms of paralysis. . . . The book supplies a want long felt; to come from this celebrated author makes it much more valuable."—*Buffalo Medical and Surgical Journal*.

"We deem the work to be one of immense value which must add greatly to its author's already large reputation, and we are heartily glad to see it reproduced by an American publishing house."—*Medical Press of Western New York*.

"Throughout the work the author's mastery of the subject is constantly apparent, and it must take rank as without a superior in its special department."—*Medical and Surgical Reporter*.

"This is 'a manual of diagnosis for students and practitioners,' and as a special work on the diagnosis on localization of a paralyzing lesion we do not know of its equal in any language."—*Virginia Medical Monthly*.

"We can strongly recommend Dr. Bastian's work to the student and practitioner as a monument of learning exceedingly well put together."—*Lancet*.

"For diagnosis Bastian's work will take the highest rank. It is remarkable for its philosophical tone and for the author's critical comments on numerous obscure problems on neurology."—*American Journal of the Medical Sciences*.

"The book is devoted to the study of the diagnosis of paralysis, and its declared purpose is to aid the physician, when brought face to face with a case of central nervous trouble resulting in paralysis, to locate the seat of the lesion and the probable extent of the trouble. It fills a space in this department of medical literature not heretofore taken up by any author with such definite limits, and its merit is equal to the author's reputation."—*North Carolina Medical Journal*.

"In unfolding this great theme, the author not only sets forth with care the symptomatology of the affections in hand, but passes in review all essential factors in the anatomy, physiology, and pathology of the nervous system. The reader of this work will find many points hitherto obscure in diagnosis made clear, and in practice will be able to rest his prognosis and treatment in not a few of the forms of paralysis upon a firmer scientific basis."—*American Practitioner and News*.

BASTIAN. Paralysis from Brain Disease in its Common Forms. By H. CHARLTON BASTIAN, M. A., M. D., Fellow of the Royal College of Physicians; Professor of Pathological Anatomy in University College, London. With Illustrations. 12mo, 340 pages. Cloth, \$1.75.

"These lectures were delivered in University College Hospital last year, at a time when I was doing duty for one of the senior physicians, and during the same year—after they had been reproduced from very full notes taken by my friend Mr. John Tweedy—they appeared in the pages of 'The Lancet.' They are now republished at the request of many friends, though only after having undergone a very careful revision, during which a considerable quantity of new matter has been added. It would have been easy to have very much increased the size of the book by the introduction of a larger number of illustrative cases, and by treatment of many of the subjects at greater length, but this the author has purposely abstained from doing under the belief that in its present form it is likely to prove more acceptable to students, and also perhaps more useful to busy practitioners."—*Extract from Preface*.

BASTIAN. The Brain as an Organ of Mind. By H. CHARLTON BASTIAN, M. A., M. D., Fellow of the Royal College of Physicians; Professor of Pathological Anatomy in University College, London. With 184 Illustrations and an Index. 12mo, 708 pages. Cloth, \$2.50.

"This work is the best book of its kind. It is full, and at the same time concise; comprehensive, but confined to a readable limit; and, though it deals with many subtle subjects, it expounds them in a style which is admirable for its clearness and simplicity."—*Nature*.

"The fullest scientific exposition yet published of the views held on the subject of psychology by the advanced physiological school. It teems with new and suggestive ideas."—*London Athenaeum*.

"Dr. Bastian's new book is one of great value and importance. The knowledge it gives is universal in its claims, and of moment to everybody. It should be forthwith introduced as a manual into all colleges, high schools, and normal schools in the country; not to be made a matter of ordinary mechanical recitations, but that its subject may arrest attention and rouse interest, and be lodged in the minds of students in connection with observations and experiments that will give reality to the knowledge required."—*Popular Science Monthly*.

BENNET. **On the Treatment of Pulmonary Consumption,** by Hygiene, Climate, and Medicine, in its Connection with Modern Doctrines. By JAMES HENRY BENNET, M. D., Member of the Royal College of Physicians, London; Doctor of Medicine of the University of Paris, etc., etc. Thin 8vo, 190 pages. Cloth, \$1.50.

An interesting and instructive work, written in the strong, clear, and lucid manner which appears in all the contributions of Dr. Bennet to medical or general literature.

"We cordially commend this book to the attention of all, for its practical, common-sense views of the nature and treatment of the scourge of all

temperate climates, pulmonary consumption."—*Detroit Review of Medicine.*

BENNET. **Winter and Spring on the Shores of the Mediterranean;** or, the Genoese Rivieras, Italy, Spain, Corfu, Greece, the Archipelago, Constantinople, Corsica, Sicily, Sardinia, Malta, Algeria, Tunis, Smyrna, Asia Minor, with Biarritz and Arcachon, as Winter Climates. By JAMES HENRY BENNET, M. D., Member of the Royal College of Physicians, London, etc., etc. Fifth edition. With numerous Illustrations and Maps. 12mo, 655 pages. Cloth, \$3.50.

This work embodies the experience of fifteen winters and springs passed by Dr. Bennet on the shores of the Mediterranean, and contains much valuable information for physicians in relation to the health-restoring climate of the regions described.

"We commend this book to our readers as a volume presenting two capital qualifications—it

is at once entertaining and instructive."—*New York Medical Journal.*

BILLINGS. **The Relation of Animal Diseases to the Public Health, and their Prevention:** With a Brief Historical Sketch of the Development of Veterinary Medicine, from the Earliest Ages to the Present Time; and a Critical Historical Sketch of the Leading Schools of the World, showing the Reasons which led to their Foundation, and with the Endeavor to draw from their Experiences Teachings of Value toward the Establishment of a General Veterinary Police-hygienic System and Veterinary Schools in this Country. By FRANK S. BILLINGS, Veterinary Surgeon, Graduate of the Royal Veterinary Institute, Berlin; Member of the Royal Veterinary Association of the Province of Brandenburg, Prussia; Honorary Member of the Veterinary Society of Montreal, Canada, etc., etc. 8vo. Cloth, \$4.00.

"This is the great health-book of Dr. Frank S. Billings, and it is not too much to promise that a study and observance of its teachings, that are the results of actual experiments, will work a revolution in the sanitary condition of the United States. . . . It is a work for all stock-breeders and for all families."—*Louisville Courier-Journal.*

"This is the title of a work just given to the world, and in its pages subjects of vital interest are treated of in a lucid and perspicuous manner. . . . These well-established statements should arouse the public feeling to provide that boards of health should be careful and efficient in the exercise of their duties, as also that, as individuals, every one should labor to take good care of himself, his family, and his domestic animals."—*New York Times.*

"This handsome volume does great credit to its author and publishers. It is an excellent book in most respects, an extraordinary one in many, and an objectionable one in very few. It at the

very least should be in the libraries of every national, State, city, town, and county Board of Health. It certainly should be studied by every teacher and scientific practitioner of veterinary medicine, and will be of great service to every great stock and cattle holder and dealer. . . . It is evidently written by a man of great ability and high culture, well versed both in the literature and science as well as the practical bearings of his subject. Such a man has a great and inalienable right to have opinions of his own; and he has them, and does not hesitate to express them. . . . We hope and believe that the volume will be received by all, except perhaps by those especially attacked, with the great welcome that its author and publishers must expect for it. It will take its stand alongside of the popular treatises of Hilliard and Robertson, and on all purely scientific matters will lead them. Either of these works, together with Dr. Billings's, will make almost a complete library on veterinary medicine."—*Journal of Comparative Medicine and Surgery.*

BILLROTH. General Surgical Pathology and Therapeutics, in Fifty-one Lectures. A Text-Book for Students and Physicians. By Dr. THEODOR BILLROTH, Professor of Surgery in Vienna. With Additions by Dr. Alexander von Winiwarter, Professor of Surgery in Lüttich. Translated from the fourth German edition with the special permission of the author, and revised from the tenth edition, by Charles E. Hackley, A. M., M. D., Physician to the New York and Trinity Hospitals; Member of the New York County Medical Society, etc. 8vo, 835 pages. Cloth, \$5.00; sheep, \$6.00.

SPECIMEN OF ILLUSTRATION.



Tissue of a glioma sarcoma after Virchow. Magnified 850 diameters.

"Since this translation was revised from the sixth German edition in 1874, two other editions have been published. The present revision is made to correspond to the eighth German edition.

"Lister's method of antiseptic treatment is referred to in various places, and other new points that have come up within a few years are discussed.

"A chapter has been written on amputation and resection. In all, there are *seventy-four* additional pages, with a number of woodcuts."—*Extract from Translator's Preface to the Revised Edition.*

"The want of a book in the English language, presenting in a concise form the views of the German pathologists, has long been felt, and we venture to say no book could more perfectly supply that want than the present volume."—*The Lancet.*

BRAMWELL. Diseases of the Heart and Thoracic Aorta. By BYROM BRAMWELL, M. D., F. R. C. P. E., Lecturer on the Principles and Practice of Medicine and on Medical Diagnosis in the Extra-Academical School of Medicine, Edinburgh; Pathologist to the Royal Infirmary, Edinburgh, etc. Illustrated with 226 Wood Engravings and 68 Lithograph Plates, showing 91 Figures—in all, 317 Illustrations. 8vo, 783 pages. Cloth, \$8.00; sheep, \$9.00.

"A careful perusal of this work will well repay the student and refresh the memory of the busy practitioner. It is the outcome of sound knowledge and solid work, and thus devoid of all 'padding,' which forms the bulk of many monographs on this and other subjects. The material is treated with due regard to its proportionate importance, and the author has well and wisely carried out his apparent intention of rather furnishing a groundwork of knowledge on which the reader must build for himself by personal observation, than of making excursions into the region of dogma and of fancy by which his book might have secured a perhaps more rapid but certainly a more evanescent success than that which it will now undoubtedly and deservedly attain."—*Medical Times and Gazette.*

"In this elegant and profusely illustrated volume Dr. Bramwell has entered a field which has hitherto been so worthily occupied by British authors—Hope, Hayden, Walshe, and others; and

we can not but admire the industry and care which he has bestowed upon the work. As it stands, it may fairly be taken as representing the stand-point at which we have arrived in cardiac physiology and pathology; for the book opens with an extended account of physiological facts, and especially the advances made of late years in the neuro-muscular mechanism of the heart and blood-vessels. Although in this respect physiological research has outstripped clinical and pathological observation, Dr. Bramwell has, we think, done wisely in so introducing his treatise, and has thereby greatly added to its value. A chapter upon thoracic aneurism terminates a work which, from the scientific manner in which the subject is treated, from the care and discrimination exhibited, and the copious elaborate illustrations with which it is adorned, is one which will advance the author's reputation as a most industrious and painstaking clinical observer."—*Lancet.*

BRYANT. A Manual of Operative Surgery. By JOSEPH D.

BRYANT, M. D., Professor of Anatomy and Clinical Surgery, and Associate Professor of Orthopædic Surgery in Bellevue Hospital Medical College; Visiting Surgeon to Bellevue Hospital, and Consulting Surgeon to the New York Lunatic Asylum and the Out-Door Department of Bellevue Hospital. New edition, revised and enlarged. With 793 Illustrations. 8vo, 530 pages. Cloth, \$5.00; sheep, \$6.00.

"The apology given by the author, if any apology be needed for the appearance of so excellent a work, is the frequent request on the part of those whom it has been his pleasure to instruct in operative surgery during the past few years, to make a book based somewhat on the plan he has employed in teaching this subject. We have perused this work with great pleasure and profit, and can bear testimony to the care and attention which the author has bestowed to make the book a benefit to his co-workers in the same field. The cuts are numerous and well executed, and the text clear and well printed. The various operative procedures are clearly and concisely described, and the results of the various operations briefly stated. The chapter on the treatment of operation wounds is worthy of special mention. The work is fully abreast of the most recent advances in operative surgery, and we have much pleasure in recommending it to our readers."—*Canada Lancet*.

"The author of this work seems to know how in the briefest space to give the student of surgery the aid necessary 'to acquire established facts,' and this is an important point in a book of this kind. The text is most fully illustrated, and brings the subject to date, and it will be found useful in the sphere to which it belongs."—*New York Medical Times*.

"The work of Professor Bryant, while it does not pretend to be a rival of the larger works or systems of surgery, is of its kind a most excellent book. Theories and doubtful methods of operating find no place in the volume. It is rather to known facts and established procedures that the author has limited his labor, and the judgment which he evinces in selecting from the various methods of operating in surgical cases is generally of a most reliable nature; indeed, it is this selecting from many proposed procedures, which are usually met with in the larger surgical works, that much of the value of Professor Bryant's book depends, and in this respect the book becomes a very able aid to the inexperienced surgeon. The scope of the work includes most of the surgical diseases, and the operative methods for their relief or cure. The operations peculiar to the female sex, and the surgery of the eye and ear, are not considered in the book. . . . In concluding our notice of Professor Bryant's book, it remains for us to congratulate him upon the successful result of his labor. He has written a very able and reliable surgical work, one that may be consulted both by surgeon and student, and one that contains all the more important advances of modern surgery. The publishers' part of the work has been well done, and the numerous illustrations add much to the value of the volume."—*Therapeutic Gazette*.

"The scope of the above work includes the methods of operating for the relief or cure of all surgical lesions, with the exception of those peculiar to the female sex and those of the eye and ear. It is, therefore, seen that much ground would have to be gone over if a description of all operations were given; and, indeed, to describe all the operations proposed for every surgical

SPECIMENS OF ILLUSTRATIONS.

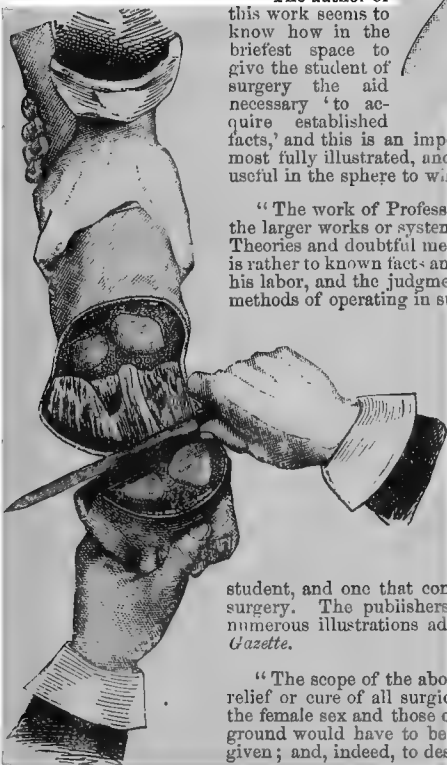

lesion would be a laborious and useless task. The plan adopted by Professor Bryant has been to select such procedures that experience and judgment recommend as the best, and it is in making the selections that the author has shown his ability to write a good book. Not only have there been shown unusually good discriminating powers in the choice of selecting the various methods, but the views of the author are unhesitatingly given when differing from the generally accepted opinions; so that we have something more than a compilation of previously described surgical operations. . . . An extended review of the above work, while desirable, is not allowable from the limited space at our command. However, we can assure our readers that, after a careful reading of Professor Bryant's book, we can unhesitatingly recommend it for information, reliability, and guidance on all connected with operative surgery. The publishers' part of the work is unusually good, and the numerous illustrations add much to its value."—*Polyclinic*.

"The book is one which we feel sure will recommend itself. . . . We would say that the book 'met a long-felt want,' if we dared to use the phrase.

The general practitioner who occasionally does a little surgery, particularly the 'dweller in the country or small town,' will find this book invaluable, for he can turn in a minute to the very place he wants, and find there an intelligent description of instruments, operation, and dressing."—*Maryland Medical Journal*.

"The various operative procedures are clearly and concisely described, and the results of the various operations briefly stated. . . . The work is fully abreast of the most recent advances in operative surgery, and we have much pleasure in recommending it to our readers."—*Canada Lancet*.

" . . . In concluding our notice of Professor Bryant's book, it remains for us to congratulate him upon the successful result of his labor. He has written a very able and reliable surgical work, one that may be consulted both by surgeon and student, and one that contains all the more important advances of modern surgery. The publishers' part of the work has been well done, and the numerous illustrations add much to the value of the volume."—*Therapeutic Gazette*.

BUCK. Contributions to Reparative Surgery, showing its Application to the Treatment of Deformities, produced by Destructive Disease or Injury; Congenital Defects from Arrest or Excess of Development; and Cicatricial Contractions following Burns. Illustrated by Thirty Cases and fine Engravings. By GURDON BUCK, M. D. 8vo. 237 pages. Cloth, \$3.00.

SPECIMENS OF ILLUSTRATIONS.



"There is no department of surgery where the ingenuity and skill of the surgeon are more severely taxed than when required to repair the damage sustained by the loss of parts, or to remove the disfigurement produced by destructive disease or violence, or to remedy the deformities of congenital malformation. The results obtained in such cases within the last half-century are among the most satisfactory achievements of modern surgery. The term 'Reparative Surgery' chosen as the title of this volume, though it may, in a comprehensive sense, be applied to the treatment of a great variety of lesions to which the body is liable, is, however, restricted in this work exclusively to what has fallen under the author's own observation, and has been subjected to the test of experience in his own practice. It largely embraces the treatment of lesions of the face, a region in which plastic surgery finds its most frequent and important applications. Another and no less important class of lesions will also be found to have occupied a large share of the author's attention, viz., cicatricial contractions following burns. While these cases have a very strong claim upon our commiseration, and should stimulate us, as surgeons, to the greatest efforts for their relief, they have too often in the past been dismissed as hopelessly incurable. The satisfactory results obtained in the cases reported in this volume will encourage other surgeons, we trust, to resort with greater hopefulness in the future to operative interference. Accuracy of description and clearness of statement have been aimed at in the following pages; and if, in his endeavor to attain this important end, the author has incurred the reproach of tediousness, the difficulty of the task must be his apology."—*Extract from Preface*.

BURT. Exploration of the Chest in Health and Disease. By STEPHEN SMITH BURT, M. D., Professor of Clinical Medicine and Physical Diagnosis in the New York Post-Graduate Medical School and Hospital; Physician to the Out-Door Department (Diseases of the Heart and Lungs), Bellevue Hospital. 8vo, 210 pages. With Illustrations. Cloth, \$1.50.

"This handy little book has lately been received by us, and we can recommend its many virtues and its usefulness to physicians and students. It is well illustrated, with large, clear type, and handsome cloth binding. The author's object in compounding this work is to aid the student in his efforts to learn the significance of physical signs and their mode of development. He has utilized his own experience, as well as the common stock of medical teaching, to extend to others the knowledge of the relative position of the viscera to the parietes, and the physical signs that can be developed in the normal chest; for upon such a foundation rests the only true basis for a correct understanding of the changes caused by disease."—*Texas Courier-Record of Medicine*.

"This is a small but exceedingly comprehensive book on auscultation and percussion, and is evidently written by one who has given frequent instruction on the subject. . . . After each disease a summary of the principal signs and symptoms is given. The book is well printed, with a sufficient number of cuts and diagrams to make it of especial value to students."—*Maryland Medical Journal*.

" . . . While this book was written with particular reference to the needs of the student, we are sure the practitioner will find it immensely

useful for his needs as well. Like all of their books, the work of the publishers makes it a model of excellence."—*Practice*.

"The aim of this work is, as described by the author, to emphasize the importance of knowing the physiological anatomy of the heart and lungs, the relative position of the viscera to the parietes, and the physical signs that can be developed in the normal chest, as upon such a foundation rests the only true basis for a correct understanding of the changes caused by disease. The difficulty encountered in producing a good text-book for students has been ably surmounted in this instance. Dr. Burt's intimate knowledge of his subject, utilized from his own personal experience and teaching, renders this a work at once sound and practical."—*Medical Brief*.

"Dr. Burt has not attempted to establish pathognomonic or distinctive signs of disease, thinking that precision is more surely attained by treating each sign as subordinate to the various combinations of signs which are found in the different maladies. . . . The work is a convenient compilation of knowledge contained in various text-books on this subject, with the result of the author's personal experience interspersed."—*St. Louis Medical and Surgical Journal*.

CAMPBELL. The Language of Medicine. A Manual giving the Origin, Etymology, Pronunciation, and Meaning of the Technical Terms found in Medical Literature. By F. R. CAMPBELL, A. M., M. D., Professor of Materia Medica and Therapeutics, Medical Department of Niagara University. 8vo, 325 pages. Cloth, \$3.00.

"A most valuable book, and no less valuable than charming. Upon studying these pages, we begin to have an idea of the manner in which the names of our various diseases originated. . . . Suffice it to say that we have here an excellent text-book and history combined, a work which will be appreciated by both old and young. . . ."—*Medical Register*.

" . . . Certainly such a book is sadly needed when we reflect upon the wholesale mispronunciation, not only by medical students, but by old practitioners of medicine. To the medical teacher, student, and practitioner, Campbell's 'Language of Medicine' is indispensable."—*Practice*.

"This is not only a very interesting but a very instructive book, and fulfills the object intended by the author, to 'provide the medical student with a suitable means of acquiring the vocabulary of his science.' Like Shakespeare, the great majority of medical students have but 'small Latin and less Greek.' It is not necessary for us to give a synopsis of the work, nor to dwell at length upon any particular part. We can only advise our readers to procure the book and read it with care. We sincerely believe it will be useful to old and young, and especially to medical students."—*Columbus Medical Journal*.

"We welcome with much gratification a volume which forms such pleasant reading for the physician who may desire to know something of the grammar and orthography of the medical portion of the English language, if we may so term it. It is a sort of guide or introduction to the dictionary, showing him why the words exist, or rather the foundation of their existence. The mere practitioner will not find in such chapters as the Origin of Words, The Life and Death of Words, Nomenclature, etc., anything available for him in the next case of gastric fever or diphtheria he may be called upon to attend, but Dr. Campbell has given much food for reflection to the earnest, thoughtful student of his profession."—*College and Clinical Record*.

"This is a book that everybody will like. There are too few of this kind written. We think it is just the sort of work to be put into the hands of a youth previous to his entry into a medical school. The exercises are excellent, and are of more use than the ordinary Latin exercises usually given at school, for they bear directly on future work. There is too little preparatory work at schools for those who are intended for a special profession. We recommend it to practitioners, especially those engaged in literary work, as a good book."—*Pacific Medical and Surgical Journal and Western Lancet*.

CARPENTER. Principles of Mental Physiology, with their Applications to the Training and Discipline of the Mind and the Study of its Morbid Conditions. By WILLIAM B. CARPENTER, M. D., LL. D., Registrar of the University of London, etc. 8vo, 737 pages. Cloth, \$3.00.

"Among the numerous eminent writers this country has produced, none are more deserving of praise for having attempted to apply the results of physiological research to the explanation of the mutual relations of the mind and body than Dr. Carpenter."—*The Lancet*.

CARTER. Elements of Practical Medicine. By ALFRED H. CARTER, M. D., Member of the Royal College of Physicians, London; Physician to the Queen's Hospital, Birmingham, etc. Third edition, revised and enlarged. 12mo, 427 pages. Cloth, \$3.00.

"Although this work does not profess to be a complete treatise on the practice of medicine, it is too full to be called a compend; it is rather an introduction to the more exhaustive study embodied in the larger text-books. An idea of the degree to which condensation has been carried in it can be gathered from the statement that but twenty-one pages are occupied with the diseases of the circulatory system. If the reader gets the impression that the physical signs are given somewhat too meagerly, it is to be said that, by way of compensation, the symptomatology in general is considered with admirable perspicuity and good judgment."—*New York Medical Journal*.

CASTRO. Elements of Therapeutics and Practice according to the Dosimetric System. By Dr. D'OLIVEIRA CASTRO. 8vo, 488 pages. Cloth, \$4.00.

"This translation" (of Dr. Castro's work) "has been made for several laymen of New York and Boston, who, having derived great benefit themselves from the daily use of the alkaloids as recommended by Dr. Burggraave, are desirous of bringing this admirable book to the knowledge of the physicians of the United States."—*From Preface to the American Edition*.

CHAUVEAU. The Comparative Anatomy of Domesticated Animals. By A. CHAUVEAU, Professor at the Lyons Veterinary School. Second edition, revised and enlarged, with the co-operation of S. Arloing, late Principal of Anatomy at the Lyons Veterinary School; Professor at the Toulouse Veterinary School. Translated and edited by George Fleming, F. R. G. S., M. A. I., Veterinary Surgeon, Royal Engineers. 8vo, 957 pages. With 450 Illustrations. Cloth, \$6.00.

SPECIMEN OF ILLUSTRATION.

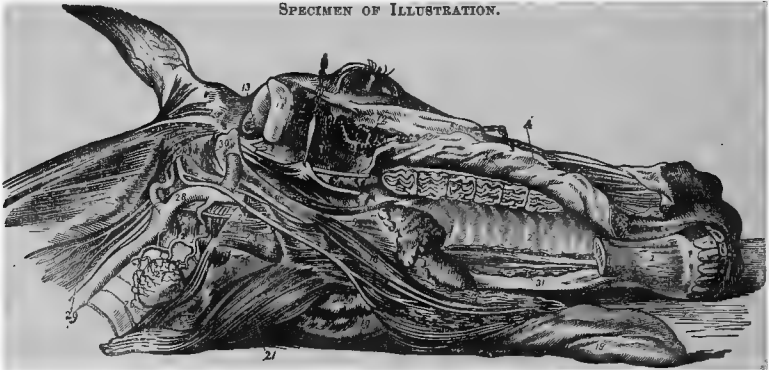

"Taking it altogether, the book is a very welcome addition to English literature, and great credit is due to Mr. Fleming for the excellence of the translation, and the many additional notes he has appended to Chauveau's treatise."—*Lancet (London)*.

"The descriptions of the text are illustrated

and assisted by no less than 450 excellent woodcuts. In a work which ranges over so vast a field of anatomical detail and description, it is difficult to select any one portion for review, but our examination of it enables us to speak in high terms of its general excellence. . . ."—*Medical Times and Gazette (London)*.

COMBE. The Management of Infancy, Physiological and Moral. Intended chiefly for the Use of Parents. By ANDREW COMBE, M. D. Revised and edited by Sir James Clark, K. C. B., M. D., F. R. S., Physician-in-ordinary to the Queen. First American from the tenth London edition. 12mo, 302 pages. Cloth, \$1.50.

"This excellent little book should be in the hand of every mother of a family."—*The Lancet*.

CORFIELD. Health. By W. H. CORFIELD, Professor of Hygiene and Public Health at University College, London. 12mo. Cloth, \$1.25.

"Few persons are better qualified than Dr. Corfield to write intelligently upon the subject of health, and it is not a matter for surprise, therefore, that he has given us a volume remarkable for accuracy and interest. Commencing with general anatomy, the bones and muscles are given attention; next, the circulation of the blood, then respiration, nutrition, the liver, and the excretory organs, the nervous system, organs of the senses, the health of the individual, air, foods and drinks, drinking-water, climate, houses and towns, small-pox, and communicable diseases."—*Philadelphia Item*.

CORNING. A Treatise on Brain Exhaustion, with some Preliminary Considerations on Cerebral Dynamics. By J. LEONARD CORNING, M. D., formerly Resident Assistant Physician to the Hudson River State Hospital for the Insane; Member of the Medical Society of the County of New York, of the Physicians' Mutual Aid Association, of the New York Neurological Society, of the New York Medico-Legal Society, of the Society of Medical Jurisprudence; Physician to the New York Neurological Infirmary, etc.; Member of the New York Academy of Medicine. Crown 8vo. Cloth, \$2.00.

"Dr. Corning's neat little volume has the merit of being highly suggestive, and, besides, it is better adapted to popular reading than any other professional work on the subject that we know of."—*Pacific Medical and Surgical Journal*.

"This is a capital little work on the subject upon which it treats, and the author has presented, from as real a scientific stand-point as possible, a group of symptoms the importance of which is sufficiently evident. To fully comprehend the ideas as presented by the author, the whole book should be read; and, as it consists of only 234 pages, the task would not be a severe or tedious one, and the information or knowledge obtained would be much more than equivalent for the time spent and cost of book included. Literary men and women would do well to procure it."—*Therapeutic Gazette*.

"This book belongs to a class that is more and more demanded by the cultured intelligence of the period in which we live. Dr. Corning may be ranked with Hammond, Beard, Mitchell, and Crothers, of this country, and with Winslow, Anstie, Thompson, and more recent authors of Great Britain, in discussing the problems of mental disturbance, in a style that makes it not only profitable but attractive reading for the student of psychology. The author has divided the work into short chapters, under general headings, which are again subdivided into topics, that are paraphrased in a concise and definite form, which at once strikes the careful reader as characteristic of a method that is terse, concise, and readily apprehended. There are twenty-eight of these pithy chapters, which no student of mental diseases can fail to read without loss."—*American Psychological Journal*.

"... In this work on the exhaustion of the brain the author presents, in a very clear and intelligent form, the various causes and symptoms of the complaint, and points out the principles upon which its treatment should be pursued. . . . The subject of the book is indeed worthy of careful consideration, and it is presented by the author in such a pleasant and attractive style that the reader will find himself entertained as well as instructed."—*Medical Record*.

"... The study of what is now becoming a most interesting subject to the general practitioner, as well as to the neurologist, viz.: intellectual diseases, has created a demand for works of the kind before us, and that Dr. Corning's memoir will meet with the reception that its merits deserve, we have not a doubt."—*New Orleans Medical and Surgical Journal*.

"... The quantity of advice is abundant, and every separate chapter is instructive. A student having the intention to become a practitioner will find a rich store of material, and the general reader will discover much to interest him, even including certain passages concerning education."—*Philadelphia Evening Bulletin*.

"Dr. Corning has given to the public and to the medical profession a work which reports very creditably the results of a somewhat extended study of his subject."—*Providence Evening Herald*.

"... In some respects Dr. Corning's book is entirely original; in others it is a clear arrangement and condensation of facts previously known. It distinctly supplies a want because it is the first book on the subject adapted to popular reading."—*Journal of Commerce*.

CORNING. Local Anæsthesia in General Medicine and Surgery.

Being the Practical Application of the Author's Recent Discoveries in Local Anæsthesia. By J. LEONARD CORNING, M. D., author of "Brain Exhaustion," "Carotid Compression," "Brain Rest," etc.; Fellow of the New York Academy of Medicine, Member of the Medical Society of the County of New York, of the New York Neurological Society, etc. Small 8vo, 103 pages. With 14 Illustrations. Cloth, \$1.25.

"The work has in it much that is instructive and attractive, and is quite an addition to a field of literature which may be considered novel. . . ."—*College and Clinical Record*.

"The book should find its way everywhere on its merits, and will be welcomed by a host of interested readers."—*Medical Press of Western New York*.

"This is a valuable little work on cocaine, giving the author's method of increasing and prolonging the cocaine anæsthesia. . . . Some very formidable operations, even amputation of the thigh, have been performed by this method and with but very little pain. It is a valuable contribution to surgical practice."—*Peoria Medical Monthly*.

"The book merits careful consideration, as being an interesting and practical original contribution to surgery."—*Medical Bulletin*.

"The work is worthy the careful study of every practical surgeon and physician. It is clearly writ-

ten, with little useless padding. The author stops when he has said 'what he wishes.'"—*American Lancet*.

"To Dr. Corning belongs the honor of discovering that cocaine anæsthesia may be almost indefinitely prolonged by checking the circulation in the part anæsthetized by means of an Esmarch's bandage, and any one desiring full details should send to the Appletons for this neat little work."—*Kansas City Medical Index*.

"It is of interest to note the author's statement that the 'discovery in question was in no respect the result of a chance, but was, on the contrary, the direct outgrowth of a chain of deductive reasoning.' The importance of this discovery needs no insisting on; and no surgeon can afford to be in ignorance of its details, or can fail to be scientifically the richer for the possession of the present work."—*New England Medical Gazette*.

DAVIS. Conservative Surgery, as exhibited in remedying some of the Mechanical Causes that operate injuriously both in Health and Disease. With Illustrations. By HENRY G. DAVIS, M. D., Member of the American Medical Association, etc. 8vo, 315 pages. Cloth, \$3.00.

The author has enjoyed rare facilities for the study and treatment of certain classes of disease, and the records here presented to the profession are the gradual accumulation of over thirty years' investigation.

"Dr. Davis, bringing as he does to his specialty a great aptitude for the solution of mechanical problems, takes a high rank as an orthopædic surgeon, and his very practical contribution to the literature of the subject is both valuable and opportune. We

deem it worthy of a place in every physician's library. The style is unpretending, but trenchant, graphic, and, best of all, quite intelligible."—*Medical Record*.

DOTY. A Manual of Instruction in the Principles of Prompt Aid to the Injured. Designed for Military and Civil Use. By ALVAH H. DOTY, M. D., Major and Surgeon, Ninth Regiment, N. G. S. N. Y.; Attending Surgeon to Bellevue Hospital Dispensary, New York. 16mo. 224 pages. With 96 Illustrations. Cloth, \$1.25.

This book is intended to impart the knowledge necessary for the prompt and intelligent care of persons suffering from hæmorrhage, fractures, dislocations, wounds, contusions, burns, shock, sprains, poisoning, the effects of heat or cold, apoplexy, epilepsy, those rescued from the water, and other accidents which are liable to occur at any time, the results of which may be materially influenced by the care and attention which the sufferer receives at the outset.

In order that the book may be read intelligently, the author has given, in a clear and simple manner, the elementary principles of anatomy and physiology, including the anatomy of bones, ligaments, cartilages, joints, muscles, synovial membranes, arteries and veins, and the physiology of circulation, respiration, alimentation, secretion, excretion, and the nervous system, both subjects being profusely illustrated with woodcuts which contribute much to a clear understanding of the text. This is followed by instructions in bandaging and the use of antiseptics and disinfectants; after which the various conditions in which one may be placed by accident are treated in a manner calculated to enable any person, who has mastered the contents of the book, to render intelligent assistance to the sufferer. Illustrations are numerous and simplify the methods described. For the Ambulance Corps connected with the different

regiments of militia of the various States, for which, and for the classes for instruction, the book is especially designed, it will be of inestimable value. The methods employed in the United States Army for the transportation of wounded men, the manner in which swords, bayonets, and guns can be used as splints or as means of transportation, are fully described and illustrated.

The book is of a size convenient for the pocket, and embraces a greater range of subjects than is found in any work of the kind heretofore published; and its completeness and simplicity commend it to the general public as well as to that portion which forms the militia of the States of the Union.

DOWN. Health Primers. Edited by J. LANGDON DOWN, M. D., F. R. C. P.; HENRY POWER, M. B., F. R. C. S.; J. MORTIMER-GRANVILLE, M. D.; JOHN TWEEDY, F. R. C. S. In square 16mo volume. Cloth, 40 cents each.

Though it is of the greatest importance that books upon health should be in the highest degree trustworthy, it is notorious that most of the cheap and popular kind are mere crude compilations of incompetent persons, and are often misleading and injurious. Impressed by these considerations, several eminent medical and scientific men of London have combined to prepare a series of HEALTH PRIMERS of a character that shall be entitled to the fullest confidence. They are to be brief, simple, and elementary in statement, filled with substantial and useful information suitable for the guidance of grown-up people. Each primer will be written by a gentleman specially competent to treat his subject, while the critical supervision of the books is in the hands of a committee who will act as editors.

As these little books are produced by English authors, they are naturally based very much upon English experience, but it matters little whence illustrations upon such subjects are drawn, because the essential conditions of avoiding disease and preserving health are to a great degree everywhere the same.

Volumes now ready.

- | | |
|---|---|
| I. EXERCISE AND TRAINING. | V. PERSONAL APPEARANCE IN HEALTH AND DISEASE. |
| II. ALCOHOL: ITS USE AND ABUSE. | VI. BATHS AND BATHING. |
| III. PREMATURE DEATH: ITS PROMOTION AND PREVENTION. | VII. THE SKIN AND ITS TROUBLES. |
| IV. THE HOUSE AND ITS SURROUNDINGS. | VIII. THE HEART AND ITS FUNCTIONS. |
| | IX. THE NERVOUS SYSTEM. |

ELLIOT. Obstetric Clinic. A Practical Contribution to the Study of Obstetrics, and the Diseases of Women and Children. By GEORGE T. ELLIOT, M. D., late Professor of Obstetrics and Diseases of Women and Children in the Bellevue Hospital Medical College; Physician to Bellevue Hospital and to the New York Lying-in Asylum, etc. 8vo, 458 pages. Cloth, \$4.50.

This work is, in a measure, a *résumé* of separate papers previously prepared by the late Dr. Elliot; and contains, besides, a record of nearly two hundred important and difficult cases in midwifery, selected from his own practice. The cases thus collected represent faithfully the difficulties, anxieties, and disappointments inseparable from the practice of obstetrics, as well as some of the successes for which the profession are entitled to hope in these arduous and responsible tasks. It has met with a hearty reception, and has received the highest encomiums both in this country and in Europe.

EVANS. Hand-Book of Historical and Geographical Phthisiology, with Special Reference to the Distribution of Consumption in the United States. Compiled and arranged by GEORGE A. EVANS, M. D., Member of the Medical Society of the County of Kings, New York; Member of the American Medical Association; formerly Physician to the Atlantic Avenue, and Bushwick and East Brooklyn Dispensaries, etc. 8vo, 294 pages. Cloth, \$2.00.

"This work of Dr. Evans's presents a most comprehensive view of the subject of phthisis. The historical sketch of the disease is complete and entertaining, the account of the geographical distribution, both in this country and abroad, very instructive, and the conclusions drawn are logical and concise. Considerable space is given to the topography and meteorology of different parts of the United States with reference to consumption.

The author has evidently exercised an unusual amount of painstaking care in the compilation of his statistics, with the result of affording the reader an accurate picture of the climatic and geographical factors that bear such an important part in the distribution of the disease. The book is one which should meet with a large sale."—*Pittsburgh Medical Review.*

"... A work in which is collected all the known facts in regard to the disease must certainly excite such interest as to cause every physician to desire to have a copy of it in his library."—*Cincinnati Medical News*.

"Dr. Evans has, in this little volume, rendered an immense assistance to the practitioner in the way of determining for him the best locality for patients suffering with a disease with which climate and location have more to do than any other malady to which the human flesh is heir. . . . We commend it to our readers as a valuable addition to their libraries."—*American Medical Digest*.

"... It presents the most reliable data obtainable, and is altogether an interesting and valuable book."—*New England Medical Monthly*.

"... It has a peculiar value of its own in bringing into practical relationships facts more or less isolated and difficult of access."—*American Lancet*.

"In compiling the above work, Dr. Evans has rendered a most useful service to the profession. Heretofore it has been necessary to glean from many sources the knowledge here contained in one small volume. Any one who has had occasion to perform this arduous work will appreciate at once the labors of the author. . . . The task has been performed thoroughly and well. . . . We feel sure the book will be found upon the table of every physician interested in this widespread and fatal disease. . . ."—*Buffalo Medical and Surgical Journal*.

EVETZKY. The Physiological and Therapeutical Action of Ergot. Being the Joseph Mather Smith Prize Essay for 1881. By ETIENNE EVETZKY, M. D. 8vo. Limp cloth, \$1.00.

"In undertaking the present work my object was to present in a condensed manner all the therapeutic possibilities of ergot. In a task of this nature, original research is out of the question. No man's evidence is sufficient to establish the merits of a drug considered in the manner indicated, and no one man's opportunities are sufficient to grasp the entire subject. Consequently it remained to gather from the volumes of past and current periodical literature the testimony of the multitude of physicians that had been led to use ergot in different morbid conditions. I have recorded everything that has come to my notice, I have grouped and classified the immense material in our possession. In all cases in which the action of ergot could be explained I have attempted to do so, although this task is frequently difficult, if not impossible. . . . The reader will see that ergot has been used in a large number of diseases; some of these uses have little or no practical value, yet it is very important to know them, as they serve to illustrate the therapeutic properties of the drug. They have been brought to the notice of the reader without any comments, but those that are essential and of the greatest practical importance have been dealt with more fully. Among the latter may be mentioned the use of ergot in inflammation, aneurism, cardiac diseases, the post-parturient state, uterine fibroid tumors, rheumatism, etc."—*From Preface*.

FLINT. Text-Book of Human Physiology, for the Use of Students and Practitioners of Medicine. By AUSTIN FLINT, M. D., LL. D., Professor of Physiology and Physiological Anatomy in the Bellevue Hospital Medical College, New York; Fellow of the New York State Medical Association, etc. Fourth edition. Entirely rewritten. In one large 8vo volume of 872 pages, elegantly printed on fine paper, and profusely illustrated with two Lithographic Plates and 316 Engravings on Wood. Cloth, \$6.00; sheep, \$7.00.

SPECIMEN OF ILLUSTRATION.

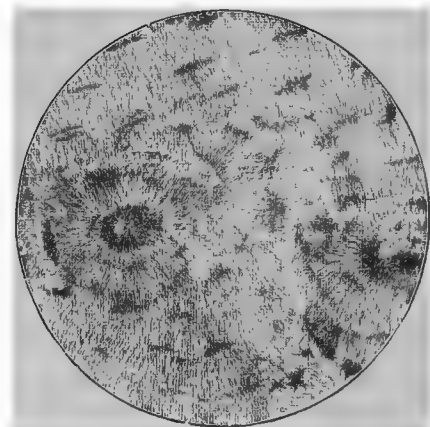

"Flint's Physiology needs no introduction to the profession, as it has been a standard text-book since its first appearance in 1875. In this edition the text has been entirely rewritten, and all the new facts that have been established are introduced, so that it is essentially a new treatise, the changed form and typography of the book also giving it the countenance of a stranger, until we trace in the general plan and arrangement the old, familiar lineaments of its predecessors. Obsolete matter, peculiar views and theories, historical references, lengthy descriptions of experimental methods and apparatus have all been wisely omitted. So also of minute anatomy, which has only been considered incidentally, and consigned to its proper place in works on anatomy.

"The object being to make a text-book of physiology, only recognized and well-established facts have been presented; but no pains have been spared to present these in such a clear and connected manner as to give the student the plainest sailing possible. With this end in view, great improvements have been made in the illustrations.

"It is a complete and reliable text-book, up to the times, and written by one who has definite ideas of what a text-book should and should not contain. Besides, we are proud of it as an American production, and hope to see it still more extensively used in American colleges."—*Cleveland Medical Gazette*.

"This is the fourth edition of one of the most popular American text-books. A comparison with former editions shows that while the general arrangement of subjects has been retained, but little remains of the original text; it has, indeed, been

"To those familiar with the merits of Prof. Flint's physiology, it is only necessary to say that the present volume retains all the excellences of its predecessors, and will be found a reliable and useful work of reference for the practitioner who desires to inform himself as to the present state of physiological science. To the medical student this work will commend itself on account of its clearness, conciseness, and intelligible presentation of the fundamental and generally accepted facts of physiology. The author has selected, with judicious care and excellent judgment, those physiological facts and theories which, when once comprehended, will materially assist the student in the elucidation of clinical and pathological problems, and will thus serve to reveal the close relationship and interdependence of physiology and general medicine."—*Polyclinic*.

"The great charm of Flint's work on physiology is that it is made interesting to the reader. This does not by any means imply that it is a popular work, or one addressed to the unprofessional mind, for it is as thoroughly scientific and goes as fully into all technical details as it could if written in the driest and most prosaic style. But the author has a knack of weaving together his facts into so connected a form that many parts of the book are absorbing in their interest. Many works on physiology, notably those of the Germans, consist of a mere record of the results of

entirely rewritten in order to keep pace with the rapid advances in physiological research. The author has adopted the new chemical nomenclature, and he has very wisely retained the English weights and measures and the Fahrenheit scale of the thermometer, placing their metric equivalents in parentheses.

"If one thing more than another has contributed to make this *the* text-book of human physiology, it is that established facts have been allowed to take precedence over peculiar views and pet theories, whether of the author or of others."—*Practice*.

SPECIMEN OF ILLUSTRATION.

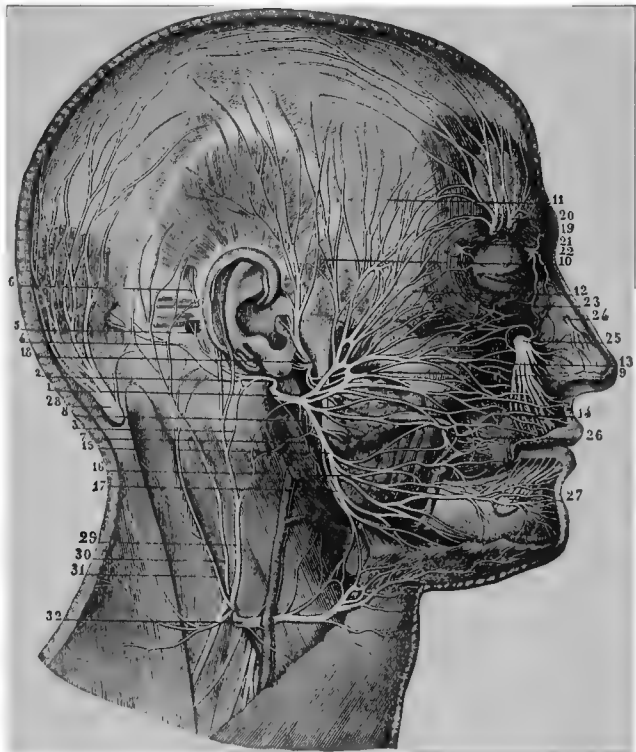

operations and experiments, the facts grouped according to the part or organ described, but their relation to one another and the outcome of the whole often left for the student to figure out for himself."—*Northwestern Lancet*.

FLINT. **Manual of Chemical Examination of the Urine in Disease.** With Brief Directions for the Examination of the most Common Varieties of Urinary Calculi. By AUSTIN FLINT, M. D., LL. D., Professor of Physiology and Microscopy in the Bellevue Hospital Medical College; Fellow of the New York Academy of Medicine, etc. Fifth edition, revised and corrected. 12mo. 77 pages. Cloth, \$1.00.

The chief aim of this little work is to enable the busy practitioner to make for himself, rapidly and easily, all ordinary examinations of Urine; to give him the benefit of the author's experience in eliminating little difficulties in the manipulations, and in reducing processes of analysis to the utmost simplicity that is consistent with accuracy.

FLINT. Medical Ethics and Etiquette. Commentaries on the National Code of Ethics. By AUSTIN FLINT, M. D., LL. D. 12mo. 101 pages. 60 cents.

FLINT. Medicine of the Future. An Address prepared for the Annual Meeting of the British Medical Association in 1886. By AUSTIN FLINT (Senior), M. D., LL. D. With Steel Engraving of the author. 12mo. 37 pages. Cloth, \$1.00.

"The late Dr. Austin Flint was appointed to read the address on Medicine before the British Medical Association at its meeting in 1886. The manuscript was found among his papers, and the address is printed precisely as it was written. The proof was reverently read by his son, who dedicates this, his father's last literary work, to the profession he so loved and admired. The book contains an excellent portrait of the late Dr. Flint. It is a most fitting memorial volume. The address itself is a most scholarly work, and should be added to the library of every practitioner."—*Buffalo Medical and Surgical Journal*.

"The above, the last of the thoughts of Austin Flint, should be in the hands of every admirer of the great and good physician, and who that knows anything of American medicine did not admire him? Flint never wrote anything that was not good, and the nice little book—*souvenir*—before us bears that characteristic. The manuscript was found among his papers after his death, and was printed just as it was written. It contains a good likeness of the author—an elegant steel engraving—and nothing has been left undone by the well-known publishers to make it attractive."—*Mississippi Valley Medical Monthly*.

FLINT. On the Physiological Effects of Severe and Protracted Muscular Exercise. With special reference to its Influence upon the Excretion of Nitrogen. By AUSTIN FLINT, M. D., LL. D., Professor of Physiology in the Bellevue Hospital Medical College, New York, etc., etc. 8vo. 91 pages. Cloth, \$1.00.

This monograph on the relations of Urea to Exercise is the result of a thorough and careful investigation made in the case of Mr. Edward Payson Weston, the celebrated pedestrian. The chemical analyses were made under the direction of R. O. Doremus, M. D., Professor of Chemistry and Toxicology in the Bellevue Hospital Medical College, by Mr. Oscar Loew, his assistant. The observations were made with the co-operation of J. C. Dalton, M. D., Professor of Physiology in the College of Physicians and Surgeons; Alexander B. Mott, M. D., Professor of Surgical Anatomy; W. H. Van Buren, M. D., Professor of Principles of Surgery; Austin Flint, M. D., Professor of the Principles and Practice of Medicine; W. A. Hammond, M. D., Professor of the Diseases of the Mind and Nervous System—all of the Bellevue Hospital Medical College.

FLINT. The Source of Muscular Power. Arguments and Conclusions drawn from Observations upon the Human Subject under conditions of Rest and of Muscular Exercise. By AUSTIN FLINT, M. D., LL. D., Professor of Physiology in the Bellevue Hospital Medical College, New York, etc., etc. 8vo. 103 pages. Cloth, \$1.00.

"There are few questions relating to Philosophy of greater interest and importance than the one which is the subject of this essay. I have attempted to present an accurate statement of my own observations and what seem to me to be the logical conclusions to be drawn from them, as well as from experiments made by others upon the human subject under conditions of rest and of muscular exercise."—*From the Preface*.

FOSTER. The First Volume of an Illustrated Encyclopædic Medical Dictionary. Being a Dictionary of the Technical Terms used by Writers on Medicine and the Collateral Sciences in the Latin, English, French, and German Languages. By FRANK P. FOSTER, M. D., Editor of "The New York Medical Journal." With the Collaboration of W. C. AYRES, M. D.; E. B. BRONSON, M. D.; C. S. BULL, M. D.; H. C. COE, M. D., M. R. C. S., etc.; A. F. CURRIER, M. D.; A. DUANE, M. D.; Prof. S. H. GAGE; H. J. GARRIGUES, M. D.; C. B. KELSEY, M. D.; R. H. NEVINS, M. D.; and B. G. WILDER, M. D. This work will be completed in Four Volumes, and is sold by Subscription only.

SPECIMEN OF ILLUSTRATION.



THE GALL-BLADDER AND ADJACENT STRUCTURES. (FROM FLINT, AFTER SAPPÉY.)

1, 2, 3, duodenum; 4, 4, 5, 6, 7, 7, 8, pancreas and pancreatic ducts; 9, 10, 11, 12, 13, liver; 14, gall-bladder; 15, hepatic duct; 16, cystic duct; 17, common duct; 18, portal vein; 19, branch from the cœliac axis; 20, hepatic artery; 21, coronary artery of the stomach; 22, cardiac portion of the stomach; 23, splenic artery; 24, spleen; 25, left kidney; 26, right kidney; 27, superior mesenteric artery and vein; 28, inferior vena cava.

The distinctive features of Foster's "Illustrated Encyclopædic Medical Dictionary" are as follows: It is founded on independent reading, and is not a mere compilation from other medical dictionaries, consequently its definitions are more accurate. Other medical dictionaries have, it is true, been consulted constantly in its preparation, but what has been found in them has not been accepted unless scrutiny showed it to be correct.

It states the sources of its information, thus enabling the critical reader to provide himself with evidence by which to judge of its accuracy, and also in many instances guiding him in any further study of the subject that he may wish to make.

It is the only work of the kind printed in the English language in which pictorial illustrations are used.

It tells, in regard to every word, what part of speech it is, and does not define nouns as if they were adjectives, and *vice versa*; and it does not give French adjectives as the "analogues" of English or Latin nouns.

It contains more English and Latin major headings than any other medical dictionary printed in English or Latin, more French ones than any printed in French, and more German ones than any printed in German, all arranged in a continuous vocabulary.

The sub-headings are usually arranged under the fundamental word, making it much more encyclopædic in character than if the common custom had been followed.

FOTHERGILL. The Diseases of Sedentary and Advanced Life.

A WORK FOR MEDICAL AND LAY READERS. By J. MILNER FOTHERGILL, M. D., M. R. C. P., Physician to the City of London Hospital for Diseases of the Chest (Victoria Park); late Assistant Physician to the West London Hospital; Hon. M. D., Rush Medical College, Chicago; Foreign Associate Fellow of the Royal College of Physicians of Philadelphia. Small 8vo. 296 pages. Cloth, \$2.00.

"The book is full of useful and wise hints for the physician and lay reader, whether an adult or already of advanced years, who may, by digesting the instruction he finds within its covers, very materially lengthen his life."—*Pacific Medical and Surgical Journal and Western Lancet*.

"It is difficult to select from a book of such all-round goodness any special points for notice. It must suffice to say that it is such a work as the physician may not only read himself but especially

recommend to such of his more intelligent patrons as are passing into the sere and yellow leaf."—*Medical Age*.

"The present work is really a valuable one. It covers a ground which is usually but lightly touched upon by the ordinary text-book. It is full of valuable suggestions, and either the old or young physician who may take it up will read it through with interest and profit."—*Buffalo Medical and Surgical Journal*.

FOURNIER. Syphilis and Marriage. Lectures delivered at the St. Louis Hospital, Paris. By ALFRED FOURNIER, Professeur à la Faculté de Médecine de Paris; Médecin de l'Hôpital Saint-Louis. Translated by P. Albert Morrow, M. D., Physician to the Skin and Venereal Department, New York Dispensary, etc., etc. 8vo. Cloth, \$2.00; sheep, \$3.00.

"The book supplies a want long recognized in medical literature, and is based upon a very extended experience in the special hospitals for syphilis of Paris, which have furnished the author with a rich and rare store of clinical cases, utilized by him with great discrimination, originality, and clinical judgment. It exhibits a profound knowledge of its subject under all relations, united with marked skill and tact in treating the delicate social questions necessarily involved in such a line of investigation. The entire volume is full of information, mnemonically condensed into axiomatic 'points.' It is a book to buy, to keep, to read, to profit by, and to lend to others."—*Boston Medical and Surgical Journal*.

"This work of the able and distinguished French syphilographer, Professor Fournier, is without doubt one of the most remarkable and important productions of the day. Possessing profound knowledge of syphilis in all its protean forms, an unexcelled experience, a dramatic force of expression, untinged, however, by even a suspicion of exaggeration, and a rare tact in dealing with the most delicate problems, he has given to the world a series of lectures which, by their fascination of style, compels attention, and by their profundity of wisdom carries conviction."—*St. Louis Courier of Medicine and Collateral Sciences*.

"Written with a perfect fairness, with a superior ability, and in a style which, without aiming at effect, engages, interests, persuades, this work is one of those which ought to be immediately placed in the hands of every physician who desires not only to cure his patients, but to understand and fulfill his duty as an honest man."—*Lyon Médicale*.

"No physician, who pretends to keep himself informed upon the grave social questions to which this disease imparts an absorbing interest, can afford to leave this valuable work unread."—*St. Louis Clinical Record*.

"The author handles this grave social problem without stint. A general perusal of this work would be of untold benefit to society."—*Louisville Medical News*.

"Every page is full of the most practical and plain advice, couched in vigorous, emphatic language."—*Detroit Lancet*.

"The subject here presented is one of the most important that can engage the attention of the profession. The volume should be generally read, as the subject-matter is of great importance to society."—*Maryland Medical Journal*.

FREY. The Histology and Histo-Chemistry of Man. A Practical Treatise on the Elements of Composition and Structure of the Human Body. By HEINRICH FREY, Professor of Medicine in Zurich. Translated from the fourth German edition, by Arthur E. J. Barker, Surgeon to the City of Dublin Hospital; Demonstrator of Anatomy, Royal College of Surgeons, Ireland; and revised by the Author. With 680 Engravings. 8vo. 683 pages. Cloth, \$5.00; sheep, \$6.00.

CONTENTS.—The Elements of Composition and of Structure of the Body: Elements of Composition—Albuminous or Protein Compounds, Hæmoglobin, Histogenic Derivatives of the Albuminous Substances or Albuminoids, the Fatty Acids and Fats, the Carbo-hydrates, Non-Nitrogenous Acids, Nitrogenous Acids, Amides, Amido-Acids, and Organic Bases, Animal Coloring Matters, Cyanogen Compounds, Mineral Constituents; Elements of Structure—the Cell, the Origin of the Remaining Elements of Tissue; the Tissues of the Body—Tissues composed of Simple Cells, with Fluid Intermediate Substance, Tissues composed of Simple Cells, with a small amount of Solid Intermediate Substance, Tissues belonging to the Connective Substance Group, Tissues composed of Transformed and, as a rule, Cohering Cells, with Homogeneous, Scanty, and more or less Solid Intermediate Substance; Composite Tissues: The Organs of the Body—Organs of the Vegetative Type, Organs of the Animal Group.

FRIEDLAENDER. The Use of the Microscope in Clinical and Pathological Examinations. By DR. CARL FRIEDLAENDER, Privat-Dozent in Pathological Anatomy in Berlin. Translated from the enlarged and improved second edition, by Henry C. Coe, M. D., etc. With a Chromo-Lithograph. 12mo. 195 pages. With copious Index. Cloth, \$1.00.

"We are very much pleased to see Dr. Friedlaender's little book make its appearance in English dress. As we have a practical acquaintance with the German edition since its appearance, we can speak of it in terms of unqualified praise. . . . Every one doing pathological work should have this little

book in his possession. . . . The translator has done his work well, and has certainly conferred a great favor on all microscopists by placing within the reach of every one the work of so accomplished a teacher as Dr. Carl Friedlaender."—*Canada Medical and Surgical Journal*.

"Much good has been done in placing this little work in the hands of the profession. The technique of preparing, cutting, and staining specimens is given at some length; also rules for the examination of the various bodily fluids in both health and disease. The use of the microscope with high powers, immersion lenses, and other accessories, is explained very clearly. It is a very readable volume, even for those not engaged in actual laboratory work. A chromo-lithograph shows the various forms of disease-germs which have been definitely isolated."—*Medical Record*.

"Microscopical *technique* has improved so much of late, especially in the direction of studying parasites, that amateurs must keep constantly on the lookout for all that is new, or they will find their work of little avail. The book before us is designed for just such workers; it is small, simple, compact, but contains all that one needs to know."—*Columbus Medical Journal*.

"This is one of the best books of the kind. Its descriptions are short, detailed, and accurate. It is devoted wholly to descriptions of the methods best adapted to use for making microscopical examinations for clinical purposes. By those inter-

ested in this subject, and especially by the beginner, will this little book be found valuable."—*Journal of the American Medical Association*.

"This is the very book on microscopy that the general run of practitioners have long been wanting. Many doctors recognize their ignorance on the subject who, while neither expecting nor caring to become expert microscopists, do want to know, in plain language that is easily intelligible, how normal structures and abnormal tissues look under the microscope. This book is a great help to such a practitioner, and will do much to popularize the subject of microscopy in questions of diagnosis, etc."—*Virginia Medical Monthly*.

"We are glad to see that a good translation of this valuable little book has been made. The author is well known for his original work, and we can feel assured that what he writes must have come from practical experience in the laboratory and is not simply a product of the 'library table.' . . . It is not intended as a treatise in pathological histology, but rather as a practical guide, and as such we can most heartily recommend it."—*Boston Medical and Surgical Journal*.

GAMGEE. Yellow Fever a Nautical Disease. Its Origin and Prevention. By JOHN GAMGEE. 8vo. 207 pages. Cloth, \$1.50.

"The author discusses, with a vast array of clear and well-digested facts, the nature and prevention of yellow fever. The work is admirably written, and the author's theories plausible and well sustained by logical deductions from established facts."—*Homoeopathic Times*.

"The theory is certainly shown to be a plausible one; and every reader, whether he be convinced or not, can not but be interested, instructed, and set to thinking."—*Lancet and Clinician*.

GARMANY. Operative Surgery on the Cadaver. By JASPER JEWETT GARMANY, A. M., M. D., F. R. C. S., Attending Surgeon to Outdoor Poor Dispensary of Bellevue Hospital; Visiting Surgeon to Ninety-ninth Street Reception Hospital; Member of the British Medical Association, etc. Small 8vo. 150 pages. With Two Colored Diagrams showing the Collateral Circulation after Ligatures of Arteries of Arm, Abdomen, and Lower Extremity. Cloth, \$2.00.

"To the more advanced student who has the opportunity of operating on the cadaver, this work will be of great value, since it reduces to a system the procedure of ordinary surgical operations. To the practitioner it will be valuable as a work of easy reference as to the best methods of operation. In fact, it should have been named a manual of surgical operations. The instructions given are full, yet very plain and concise, and we predict for it a wide circulation."—*Pooria Medical Monthly*.

"... In its necessarily limited scope it is above criticism. . . . Indeed, there is nothing superfluous in the book, and the busy practitioner, who must do more or less surgery, would find it a very useful manual for frequent reference."—*Medical Press of Western New York*.

"... For the student in the dead-room, or the busy operating surgeon, this book is one of the most reliable and handy works we have ever seen."—*Southern Clinician*.

"Post-mortem surgery must always precede intelligent and successful surgery. No more acceptable or useful guide to this form of experimental teaching could be desired than the admirable little work before us. Not a superfluous phrase and not

an obscure phrase mars its pages. . . ."—*New England Medical Gazette*.

"... No space is wasted, either by words or by illustrations, a fact which we believe greatly enhances its value for the earnest student."—*Pacific Medical and Surgical Journal and Western Lancet*.

"... All the ordinary operations practiced in surgery are described in a concise and clear manner, many of the later procedures finding a place which are not incorporated in larger works on surgery already before the public. The book will prove to be a great convenience to the practitioner in active work, as well as to the student in the dissecting-room."—*Weekly Medical Review*.

"This book contains a simple and clear statement of the way in which a large number of operations are to be performed on the cadaver, and can be recommended to the use of teachers and students in this important part of a surgical education. . . ."—*Medical and Surgical Reporter*.

"It is well fitted to be a text-book for classes on operative surgery. . . . As a manual it is excellent."—*Philadelphia Medical Times*.

GERSTER. The Rules of Aseptic and Antiseptic Surgery. A Practical Treatise for the Use of Students and the General Practitioner. By ARPAD G. GERSTER, M. D., Professor of Surgery at the New York Polyclinic; Visiting Surgeon to the German Hospital and to Mount Sinai Hospital, New York. 8vo. Illustrated with Two Hundred and Forty-eight Fine Engravings. Cloth, \$5.00; sheep, \$6.00.

"Messrs. D. Appleton & Co. have rarely or never produced so strikingly picturesque and attractive a work upon any medical subject as this latest contribution to the exposition of the principles of asepsis and antiseptics in their various interesting applications to surgery. It is but necessary to open the volume and turn over a few pages to become thoroughly and deeply interested. Each step of many of the most important operations of modern surgery is reproduced in lifelike form through the medium of phototypography, which is enhanced in effect by the beautiful type and paper which have been selected as media for the production of the most effective artistic results.

To this let us add that the object of the volume is a systematic yet practical presentation of the Listerian principle, which has revolutionized surgery within the last fifteen years. . . . Every surgeon, interested in the most advanced operative procedures of the day, accompanied with the most scientific precautionary aseptic and antiseptic measures of conservative surgery, should possess this beautiful and thorough work of Dr. Gerster. It bears the stamp on every page of conscientious surgical knowledge and skill, tender regard for the patient's safety, and a true, manly sense of the duties of the operator."—*College and Clinical Record.*

SPECIMEN OF ILLUSTRATION.

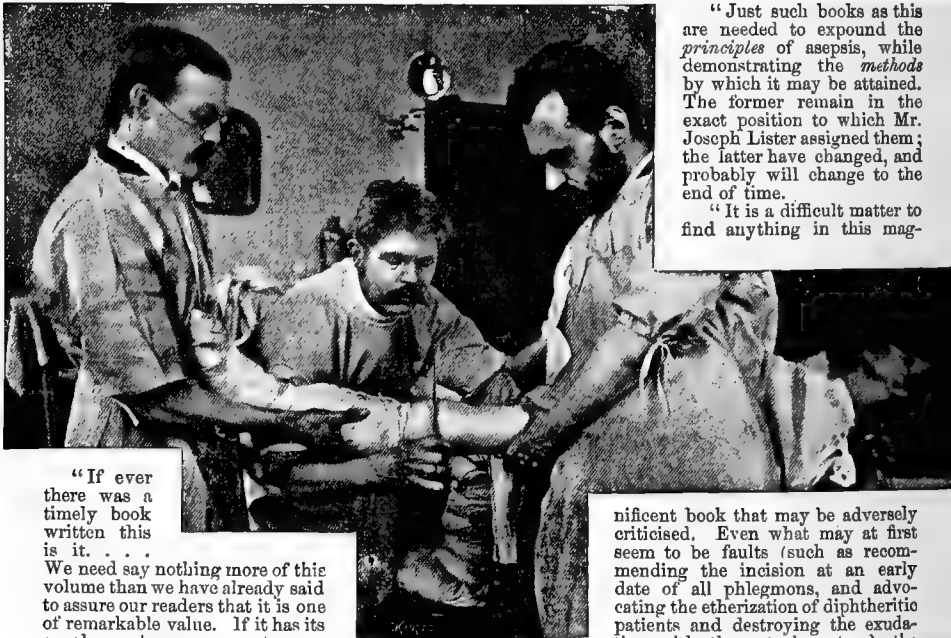

"If ever there was a timely book written this is it. . . .

We need say nothing more of this volume than we have already said to assure our readers that it is one of remarkable value. If it has its equal anywhere we are not aware of it. If anything is needed to make the author's reputation, this book will do it, as it will most surely find its way into every town, village, and hamlet in our broad land. . . ."—*North Carolina Medical Journal.*

"This is as beautiful a specimen of the book-maker's art as we have seen. . . . The beauty and abundance of the illustrations—which are photographs taken during operation—add greatly to the practical value of the work. In a word, it is a book which every physician who does any surgical work ought to have."—*Buffalo Medical and Surgical Journal.*

"Just such books as this are needed to expound the principles of asepsis, while demonstrating the methods by which it may be attained. The former remain in the exact position to which Mr. Joseph Lister assigned them; the latter have changed, and probably will change to the end of time.

"It is a difficult matter to find anything in this mag-

nificent book that may be adversely criticised. Even what may at first seem to be faults (such as recommending the incision at an early date of all phlegmons, and advocating the etherization of diphtheritic patients and destroying the exudation with the actual cautery), the

lapse of a few years may demonstrate to be correct practices given to the world in advance of their time."—*Pittsburgh Medical Review.*

"The book is an honest and vigorous exponent of the doctrines and practical details of antiseptic surgery, and, unlike too many modern works in medicine, is strikingly original in design and execution. The illustrations, of which there are two hundred and fifty-one, constitute a novel feature in book-making. They are in most instances a reproduction of photographic views of the author and his assistants at work in the surgical clinic. They are admirably executed, and, while serving

to illustrate disease, wounds, the author's method of operating for their relief, and his armamentarium, many of them would make excellent studies for the realistic artist. As a specimen of the book-maker's art the volume is exquisitely beautiful."—*American Practitioner and News*.

"... The book may be termed a treatise on operative surgical physiology and pathology, if there be no contradiction in this combination of words. Or, it may be said that the book is a series of illustrative sermons on the text, *The surgeon's act determines the fate of a fresh wound, and its infection and suppuration are due to his technical faults of omission and commission.*..."—*Journal of the American Medical Association*.

"The title of this magnificent book gives no adequate idea of its contents. . . . The methods of operating are those most approved by the best surgeons living, and are described in a thoroughly lucid manner. . . . It is no small addition to the value of the text of Dr. Gerster's book that the illustrations of it are of a very high order of excellence. . . . The work of the publishers, in preparing this book, is as creditable to them as is that of the author to him, . . . and we can and do recommend it very strongly to our readers, as we feel that it is a book which ought to be in the hands of every practicing surgeon."—*Medical and Surgical Reporter*.



"This is an elegant work, and as valuable as it is beautiful. Profusely illustrated, printed from large, clear type on excellent calendered paper, and carefully edited.

This work brings surgery up to the present moment."—*Southern Clinic*.

GROSS. A Practical Treatise on Tumors of the Mammary Gland: embracing their Histology, Pathology, Diagnosis, and Treatment. By SAMUEL W. GROSS, A. M., M. D., Surgeon to, and Lecturer on Clinical Surgery in, the Jefferson Medical College Hospital and the Philadelphia Hospital, etc. In one handsome 8vo vol. of 246 pages. With 29 Illustrations. Cloth, \$2.50.

SPECIMEN OF ILLUSTRATION.

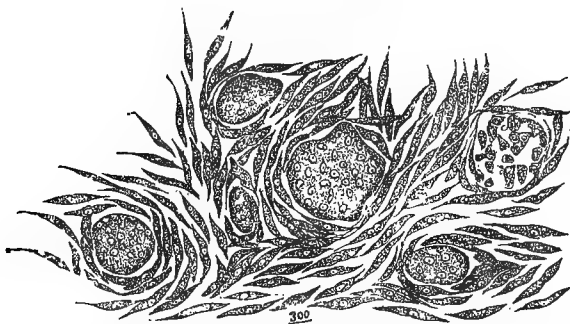

GIANT-CELLED SARCOMA.—Showing the characteristic multinucleated elements contained in a stroma of spindle cells, transverse sections of which are seen at the upper corner to the right of the figure.

"This book is a real contribution to our professional literature; and it comes from a source which commands our respect. The plan is very systematic and complete, and the student or practitioner alike will find exactly the information he seeks upon any of the diseases which are incident to the mammary gland."—*Obstetrical Gazette*.

practical value; finally, a chapter is devoted to diagnosis, one to treatment, and one to the tumors in the mammary gland of the male."—*New York Medical Journal*.

"Altogether, the work is one of more than ordinary interest to the surgeon, gynecologist, and physician."—*Detroit Lancet*.

"We know of no book in the English language which attempts to cover the ground covered by this one—indeed, the author seems to be the first who has sought to handle the whole subject of mammary tumors in one systematic treatise. How he has succeeded will best be seen by a study of the book itself. In the early chapters the classification and relative frequency of the various tumors, their evolution and transformations, and their etiology, are dealt with; then each class is studied in a separate chapter, in which the result of the author's work is compared with that of others, and the general conclusions are drawn which give to the book its great

GUTMANN. *The Watering-Places and Mineral Springs of Germany, Austria, and Switzerland.* With Notes on Climatic Resorts and Consumption, Sanitariums, Peat, Mud, and Sand Baths, Whey and Grape Cures, etc. By EDWARD GUTMANN, M. D. With Illustrations, Comparative Tables, and a Colored Map, explaining the Situation and Chemical Composition of the Spas. 12mo. Cloth, \$2.50.

"Dr. Gutmann has compiled an excellent medical guide, which gives full information on the manners and customs of living at all the principal watering-places in Europe. The chemical compositions, with the therapeutical applications of the mineral waters, are very thoroughly presented in separate parts of the volume."—*New York Times*.

HAMMOND. *Clinical Lectures on Diseases of the Nervous System.* Delivered at the Bellevue Hospital Medical College. By WILLIAM A. HAMMOND, M. D., Professor of Diseases of the Mind and Nervous System, etc. Edited, with Notes, by T. M. B. CROSS, M. D., Assistant to the Chairs of Diseases of the Mind and Nervous System, etc. In one handsome volume of 300 pages. \$3.50.

These lectures have been reported in full, and, together with the histories of the cases, which were prepared by the editor after careful study and prolonged observation, constitute a clinical volume which, while it does not claim to be exhaustive, will nevertheless be found to contain many of the more important affections of the kind that are commonly met with in practice.

As these lectures were intended especially for the benefit of students, the author has confined himself to a full consideration of the symptoms, causes, and treatment of each affection, without attempting to enter into the pathology or morbid anatomy.

HAMMOND. *A Treatise on Insanity, in its Medical Relations.* By WILLIAM A. HAMMOND, M. D., Surgeon-General U. S. Army (retired list); Professor of Diseases of the Mind and Nervous System in the New York Post-Graduate Medical School; President of the American Neurological Association, etc. 8vo. 767 pages. Cloth, \$5.00; sheep, \$6.00.

In this work the author has not only considered the subject of Insanity, but has prefixed that division of his work with a general view of the mind and the several categories of mental faculties, and a full account of the various causes that exercise an influence over mental derangement, such as habit, age, sex, hereditary tendency, constitution, temperament, instinct, sleep, dreams, and many other factors.

Insanity, it is believed, is in this volume brought before the reader in an original manner, and with a degree of thoroughness which can not but lead to important results in the study of psychological medicine. Those forms which have only been incidentally alluded to or entirely disregarded in the text-books hitherto published are here shown to be of the greatest interest to the general practitioner and student of mental science, both from a normal and abnormal stand-point. To a great extent the work relates to those species of mental derangement which are not seen within asylum walls, and which, therefore, are of special importance to the non-asylum physician. Moreover, it points out the symptoms of Insanity in its first stages, during which there is most hope of successful medical treatment, and before the idea of an asylum has occurred to the patient's friends.

"We believe we may fairly say that the volume is a sound and practical treatise on the subject with which it deals; contains a great deal of information carefully selected and put together in a pleasant and readable form; and, emanating, as it does, from an author whose previous works have met with a most favorable reception, will, we have little doubt, obtain a wide circulation."—*The Dublin Journal of Medical Science*.

"... The times are ripe for a new work on insanity, and Dr. Hammond's great work will serve hereafter to mark an era in the history of American psychiatry. It should be in the hands of every physician who wishes to have an understanding of the present status of this advancing science. Who begins to read it will need no urging to continue; he will be carried along irresistibly. We unhesitatingly pronounce it one of the best works on insanity which has yet appeared in the English language."—*Am. Journal of the Medical Sciences*.

"Dr. Hammond is a bold and strong writer, has given much study to his subject, and expresses himself so as to be understood by the reader, even if the latter does not coincide with him. We like the book very much, and consider it a valuable addition to the literature of insanity. We have no hesitancy in commending the book to the medical profession, as it is to them it is specially addressed."—*Therapeutic Gazette*.

"Dr. Hammond has added another great work to the long list of valuable publications which have placed him among the foremost neurologists and alienists of America; and we predict for this volume the happy fortune of its predecessors—a rapid journey through paying editions. We are sorry that our limits will not permit of an analysis of this work, the best text-book on insanity that has yet appeared."—*The Polyclinic*.

"We are ready to welcome the present volume as the most lucid, comprehensive, and practical

exposition on insanity that has been issued in this country by an American alienist, and, furthermore, it is the most instructive and assimilable that can be placed at present in the hands of the student uninitiated in psychiatry. The instruction contained within its pages is a food thoroughly prepared for mental digestion; rich in the condiments that stimulate the appetite for learning, and substantial in the more solid elements that enlarge and strengthen the intellect."—*New Orleans Medical and Surgical Journal*.

"This is the first systematic attempt, we believe, to describe all the various forms of medical insanity by their clinical features, and the work is destined to rank far above the few treatises that are already recognized as authorities on the sub-

ject. In the consideration of insanity every author has his own pet classification; but Dr. Hammond's, being based upon clinical manifestations, is more complete, more philosophical, and less complex than any that we remember to have seen. The least we can say is, that, although we differ from the author in some of his conclusions, we rarely have the privilege to read a book containing so much originality and giving so lasting a satisfaction as this. So perfectly natural is the style of composition that one feels as if he were reading a fascinating novel instead of a medical treatise, and the whole book will interest not only the non-medical reader, but also the alienist and general practitioner."—*International Review of Medical and Surgical Technique*.

HAMMOND. A Treatise on the Diseases of the Nervous System. By WILLIAM A. HAMMOND, M. D., Surgeon-General U. S. Army (retired list); Professor of Diseases of the Mind and Nervous System in the New York Post-Graduate Medical School and Hospital; Member of the American Neurological Association and of the New York Neurological Society; of the New York County Medical Society, etc. With 112 Illustrations. Eighth edition, revised, corrected, and enlarged by the Addition of a New Section on Certain Obscure Nervous Diseases. 8vo. 945 pages. Cloth, \$5.00; sheep, \$6.00.

The work has received the honor of a French translation by Dr. Labadie-Lagrave, of Paris, and an Italian translation, by Professor Diodato Borrelli, of the Royal University, has gone through the press at Naples.

"In the Buddhist faith the eight gates of purity are described as: 1. Correct ideas; 2. Correct thoughts; 3. Correct words; 4. Correct works; 5. Correct life; 6. Correct endeavors; 7. Correct judgment; and 8. Correct tranquillity. If Dr. Hammond has not attained the medical nirvana, and passed those eight gates of purity, he has at least realized the Buddhist beatitude: 'Much in sight and education, self-control and pleasant speech; and whatever word be well spoken, this is the greatest blessing.' At least, the thoughts and utterances, of Dr. Hammond have been so appreciated by the medical profession of America and England that the work has already passed through eight editions since its first appearance in 1871. As now revised by the author and published by the Appletons, it constitutes decidedly the best work in the English language upon diseases of the nervous system."—*Kansas City Medical Index*.

"This excellent work has now been fifteen years before the profession, its popularity being sufficiently evidenced by the fact that it has rapidly passed through eight editions."—*College and Clinical Record*.

"This volume has been received by the profession 'to an extent beyond that ever given to any other work of like scope and objects published in any part of the world.' The present edition con-

SPECIMEN OF ILLUSTRATION.

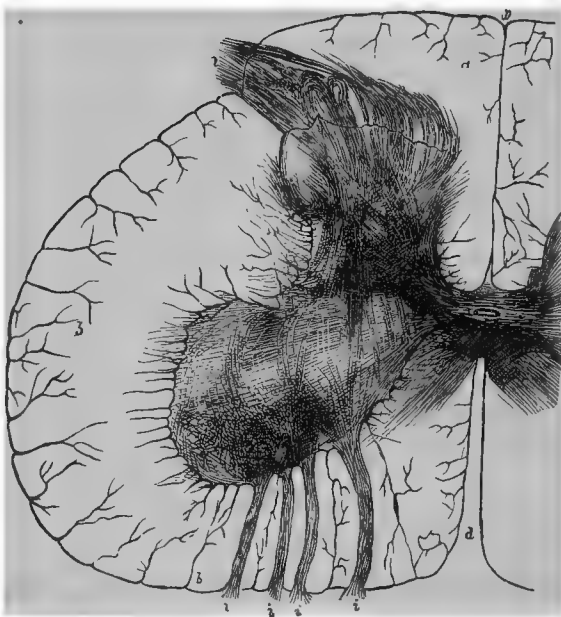

tains a section on 'Certain Obscure Diseases of the Nervous System,' is thoroughly revised throughout, and several changes made, thereby increasing greatly its usefulness."—*Buff. Med. and Sur. Jour.*

HARVEY. First Lines of Therapeutics as Based on the Modes and the Processes of Healing, as occurring spontaneously in Diseases; and on the Modes and the Processes of Dying as resulting naturally from Disease. In a Series of Lectures. By ALEXANDER HARVEY, M. A., M. D., Emeritus Professor of Materia Medica in the University of Aberdeen, etc., etc. 12mo. 278 pages. Cloth, \$1.50.

"If only it can get a fair hearing before the profession it will be the means of aiding in the development of a therapeutics more rational than we now dream of. To medical students and practitioners of all sorts it will open up lines of thought and investigation of the utmost moment." *Detroit Lancet.*

"We may say that, as a contribution to the philosophy of medicine, this treatise, which may be profitably read during odd moments of leisure, has a happy method of statement and a refreshing freedom from dogmatism."—*New York Medical Record.*

HOFMANN AND ULTMANN. Analysis of the Urine, with Special Reference to the Diseases of the Genito-Urinary Organs. By K. B. HOFMANN, Professor in the University of Gratz, and R. ULTMANN, Docent in the University of Vienna. Translated by T. BARTON BRUNE, A. M., M. D., late Professor of the Practice of Medicine in the Baltimore Polyclinic and Post-Graduate Medical School, etc., and H. HOLBROOK CURTIS, Ph. B., M. D., Fellow of the New York Academy of Medicine, etc. Third edition, revised and enlarged. With 8 Lithographic Plates. 8vo. 310 pages. Cloth, \$2.00.

"Hofmann and Ultmann's popular work on the urine needs neither criticism nor recommendation. Its claims have been substantiated in the offices of thousands of physicians both in Europe and America. It covers the entire field of chemical and microscopical examination of urine so far as diagnosis is concerned, giving explicit directions as to details of manipulation."—*Hahnemannian.*

"Possessed of this book, a few reagents, a microscope with glasses powerful enough to magnify two or three hundred diameters, and a few test-tubes and slides, there is no good reason why every physician should not become a good urinary analyst."—*Mississippi Valley Medical Monthly.*

"For the every-day wants of the practitioner, we know of no manual on urinary analysis that equals Hofmann and Ultmann's work. . . . The second edition contains all the important advances that have been made in the examination of the urinary constituents during the past three years. One of the most important sections of the work is that devoted to an account of the microscopical and clinical aids for the diagnosis of the different forms of albuminuria. The translators are to be congratulated on producing a very clear and readable rendering of the original."—*Canada Medical and Surgical Journal.*

"The second edition of this classical work on the urine will be welcomed as containing all the latest advances in urinary analysis. All unnecessary matter has been eliminated, and the chemistry is so simple as to be within the comprehension of all. The translators have made a few additions which are practical and therefore useful."—*Canada Lancet.*

"This work has long been standard authority. But the late advances in urinalogy have made it necessary for the American translators practically to become editors of a new or second edition.

They have done their work well, and in this volume present the profession with a reliable, practical book, giving the most advanced ideas as to urinalysis and diagnosis of urinary troubles in simple language, which does not require a mastery of clinical technology to understand."—*Virginia Medical Monthly.*

"In the present edition all unnecessary matter has been eliminated, and the translators have incorporated all that has recently been added to our knowledge of the subject that will be of especial interest to the student and practitioner. A valuable feature of the book is the illustrations, which are very fine indeed."—*Indiana Medical Journal.*

"Students and general practitioners can ask no better working guide on the subjects treated than this standard work. The publishers present it in a handsome and durable form, and the colored plates are uncommonly finished and fine."—*New England Medical Gazette.*

"That this work is a valuable and practical one is attested by its continued popularity. It is not a mere compilation of the work of others, but contains the result of years of careful research. It gives many details that will be found most helpful to students of urinary analysis as well as to general practitioners. The lithographic plates at the end are very accurate. The book ranks among the best of its kind, and we can heartily commend it."—*Medical Record.*

"This is a translation of a work well known abroad. It is intended as a hand-book for student and practitioner, and contains many valuable suggestions and practical hints both as regards analysis and diagnosis. The profession is under special obligations to the able translators for smooth and elegant translation from the German. The work will certainly obtain a large share of favorable attention."—*Nashville Journal of Medicine.*

HOWE. Emergencies, and How to treat Them. The Etiology, Pathology, and Treatment of Accidents, Diseases, and Cases of Poisoning, which demand Prompt Action. Designed for Students and Practitioners of Medicine. By JOSEPH W. HOWE, M. D., Clinical Professor of Surgery in the Medical Department of the University of New York, etc., etc. Fourth edition, revised. 8vo. 265 pages. Cloth, \$2.50.

"To the general practitioner in towns, villages, and in the country, where the aid and moral support of a consultation can not be availed of, this volume will be recognized as a valuable help. We commend it to the profession."—*Cincinnati Lancet and Observer*.

"The author wastes no words, but devotes himself to the description of each disease as if the patient were under his hands. Because it is a good

book we recommend it most heartily to the profession."—*Boston Medical and Surgical Journal*.

"This work bears evidence of a thorough practical acquaintance with the different branches of the profession. The author seems to possess a peculiar aptitude for imparting instruction as well as for simplifying tedious details. A careful perusal will amply repay the student and practitioner."—*New York Medical Journal*.

HOWE. The Breath, and the Diseases which give it a Fetid Odor. With Directions for Treatment. By JOSEPH W. HOWE, M. D., Clinical Professor of Surgery in the Medical Department of the University of New York, etc. Second edition, revised and corrected. 12mo. 108 pages. Cloth, \$1.00.

"This little volume well deserves the attention of physicians, to whom we commend it most highly."—*Chicago Medical Journal*.

"To any one suffering from the affection, either in his own person or in that of his intimate acquaintances, we can commend this volume as containing all that is known concerning the sub-

ject, set forth in a pleasant style."—*Philadelphia Medical Times*.

"The author gives a succinct account of the diseased conditions in which a fetid breath is an important symptom, with his method of treatment. We consider the work a real addition to medical literature."—*Cincinnati Medical Journal*.

HUEPPE. The Methods of Bacteriological Investigation. By FERDINAND HUEPPE, Docent in Hygiene and Bacteriology in the Chemical Laboratory of R. Fresenius, at Wiesbaden. Written at the request of Dr. ROBERT KOCH. Translated by HERMANN M. BIGGS, M. D., Instructor in the Carnegie Laboratory, and Assistant to the Chair of Pathological Anatomy in Bellevue Hospital Medical College. 8vo. 218 pages. With 31 Illustrations. Cloth, \$2.50.

"This is the best book so far available in English, being better adapted to the general student who undertakes the study from first principles."—*North Carolina Medical Journal*.

"All students of bacteriology will at once place this volume on their tables as indispensable for their most accurate and rapid study."—*American Lancet*.

"The work is written by one who thoroughly understands his subject and puts it clearly before the student."—*Pacific Medical and Surgical Journal and Western Lancet*.

"He has sifted the whole of the scattered and sometimes almost inaccessible literature of the subject, and has furnished the independent investigator a most valuable book, useful alike to the practitioner and to the student, as a trustworthy introduction into this territory."—*College and Clinical Record*.

"To those who wish to have more than a mere theoretical knowledge of the subject the manual will be found indispensable."—*Medical Record*.

"As a whole, the book, written at Professor Koch's request, reflects credit on the master's

choice of author, and is one which no student of pathology can afford to be without. The translation seems to have been most acceptably made."—*Medical Press of Western New York*.

"Of the many works that have recently appeared on the subject of bacterial technology, this one certainly meets the requirements of a practical guide and book of reference; . . . the merits of the work are decided and should secure for it the reputation it deserves."—*Atlanta Medical and Surgical Journal*.

"The book treats the subject in an exceedingly clear and comprehensive manner, and leaves little to be desired by the beginner, and is a complete guide to those wishing to work out any of the innumerable problems connected with the life-history of the bacteria. . . . The translation seems to be well done."—*American Journal of the Medical Sciences*.

"The importance of this subject in the scientific world . . . should insure for so practical a presentation of it as is found in the present volume a wide popularity."—*New England Medical Gazette*.

HUXLEY. The Anatomy of Vertebrated Animals. By THOMAS HENRY HUXLEY, LL. D., F. R. S. 12mo. Illustrated. 431 pages. Cloth, \$2.50.

"The present work is intended to provide students of comparative anatomy with a condensed statement of the most important facts relating to the structure of vertebrated animals which have hitherto been ascertained. The *Vertebrata* are distinguished from all other animals by the circumstance that a transverse and vertical section of the body exhibits two cavities completely separated from one another by a partition. The dorsal cavity contains the cerebro-spinal nervous system; the ventral, the alimentary canal, the heart, and usually a double chain of ganglia, which passes under the name of the 'sympathetic.' It is probable that this sympathetic nervous system represents, wholly or partially, the principal nervous system of the *Annulosa* and *Mollusca*. And, in any case, the central parts of the cerebro-spinal nervous system—viz., the brain and the spinal cord—would appear to be unrepresented among invertebrated animals."—*The Author*.

"This long-expected work will be cordially welcomed by all students and teachers of Comparative Anatomy as a compendious, reliable, and, notwithstanding its small dimensions, most comprehensive guide on the subject of which it treats. To praise or to criticise the work of so accomplished a master of his favorite science would be

equally out of place. It is enough to say that it realizes, in a remarkable degree, the anticipations which have been formed of it; and that it presents an extraordinary combination of wide, general views, with the clear, accurate, and succinct statement of a prodigious number of individual facts."—*Nature*.

JACCOUD. The Curability and Treatment of Pulmonary Phthisis. By S. JACCOUD, Professor of Medical Pathology to the Faculty of Paris; Member of the Academy of Medicine; Physician to the Lariboisière Hospital, Paris, etc. Translated and edited by MONTAGU LUBBOCK, M. D. (London and Paris), M. R. C. P. (England), etc. 8vo. 407 pages. Cloth, \$4.00.

"This is the work of that most eminent Frenchman of the *École de Médecine* of Paris, and the translation of Lubbock is strong and masterly inasmuch as it evidences the possession of a large vocabulary knowledge of both the original and English. No man of the present day, with the single exception perhaps of Hughes Bennet, has devoted as much careful study to the climatic treatment of phthisis as Dr. Jaccoud, and his conclusions on this point so far as regards the Continent of Europe must be deemed final."—*Annuaire Lancet and Clinic*.

"M. Jaccoud, the author of the work, and the eminent professor of the *École de Médecine*, Paris, is generally recognized on the Continent as one of the best authorities on pulmonary phthisis, so that an English edition of his work will certainly be very acceptable to those interested in the subject. . . . M. Jaccoud's reputation is justly so great that his opinions with respect to the treatment will be read with general interest."—*Texas Courier-Record of Medicine*.

JOHNSTON. The Chemistry of Common Life. Illustrated with numerous Wood Engravings. By the late JAMES F. W. JOHNSON, F. R. S., Professor of Chemistry in the University of Durham. A new edition, revised and brought down to the Present Time. By ARTHUR HERBERT CHURCH, M. A., Oxon. Illustrated with Maps and numerous Engravings on Wood. 12mo. 592 pages. \$2.00.

SUMMARY OF CONTENTS.—The Air we Breathe; the Water we Drink; the Soil we Cultivate; the Plant we Rear; the Bread we Eat; the Beef we Cook; the Beverages we Infuse; the Sweets we Extract; the Liquors we Ferment; the Narcotics we Indulge in; the Poisons we Select; the Odors we Enjoy; the Smells we Dislike; the Colors we Admire; What we Breathe and Breathe for; What, How, and Why we Digest; the Body we Cherish; the Circulation of Matter.

JONES. Practical Manual of Diseases of Women and Uterine Therapeutics. For Students and Practitioners. By H. MACNAUGHTON JONES, M. D., F. R. C. S. I. and E., Examiner in Obstetrics, Royal University of Ireland; Fellow of the Academy of Medicine in Ireland; and of the Obstetrical Society of London, etc. 12mo. 410 pages. 188 Illustrations. Cloth, \$3.00.

"As a concise, well-written, useful manual, we consider this one of the best we have ever seen. The author, in the preface, tells us that 'this book is simply intended as a practitioner's and student's manual. I have endeavored to make it as practical in its teachings as possible.' The style is pleasant to peruse. The author expresses his ideas in a clear manner, and it is well up with the approved methods and treatment of the day. It is well illustrated, and due credit is given to American gynecologists for work done. It is a good book, well printed in good, large type, and well bound."—*New England Medical Monthly*.

"It is seldom that we see a book so completely fill its avowed mission as does the one before us. It is practical from beginning to end, and can not fail to be appreciated by the readers for whom it is intended. The author's style is terse and perspicuous, and he has the enviable faculty of giving the learner a clear insight of his methods and reasons for treatment. Prepared for the practitioner, this little work deals only with his every-day wants in ordinary family practice. Every one is compelled to treat uterine disease who does any general business whatever, and should become acquainted with the minor operations thereto pertaining. The book

before us covers this ground completely, and we have nothing to offer in the way of criticism."—*Medical Record*.

"The manual before us is not the work of a specialist—using this term in a narrow sense—but of an author already favorably known to the students of current medical literature by various and comprehensive works upon other branches of his profession. Nor is it, on the other hand, the work of an amateur or merely ingenious collaborateur, for Dr. Macnaughton Jones's gynecological experience in connection with the Cork Hospital for Women and the Cork Maternity was such as fairly entitles him to speak authoritatively upon the subjects with which it deals. But, after so many works by avowed specialists, we are glad to welcome one upon Gynecology by an author whose opportunities and energy have enabled him to master the details of so many branches of medicine. We are glad also to be able to state that his work compares very favorably with others of the same kind, and that it does admirably fulfill the purposes with which it was written—'as a safe guide in practice to the practitioner, and an assistance in the study of this branch of his profession to the student.'"—*Dublin Journal of Medical Science*.

KEYES. A Practical Treatise on the Surgical Diseases of the Genito-Urinary Organs, including Syphilis. Designed as a Manual for Students and Practitioners. With Engravings. By E. L. KEYES, A. M., M. D., Professor of Genito-Urinary Surgery, Syphilology, and Dermatology in Bellevue Hospital Medical College. Being a revision of a Treatise, bearing the same title, by VAN BUREN and KEYES. Second edition, thoroughly revised, and somewhat enlarged. 8vo. 688 pages. Cloth, \$5.00; sheep, \$6.00.

"Those who are familiar with the older works of Keyes (Van Buren and Keyes) will scarcely recognize the present treatise. Since 1874 the advances in the department of surgery included under the term genito-urinary have been so considerable that the work before us is practically a new book. The author appears to have been prompted by feelings of reverence for his 'dear old master' in calling this a revision of the work alluded to. To mention but a few subjects that are essentially new, we may allude to litholapaxy, suprapubic cystotomy (the modified and revised older operation), renal surgery, the modern methods of dealing with hydrocele, and the radical cure of varicocele. The profession will give glad and speedy welcome to Dr. Keyes's treatise as it now stands. It may well challenge favorable comparison with similar works by other authors, and if so examined it will not be found wanting in all that is essential to a reliable, readable, and instructive manual on a highly important branch of the healing art."—*Medical Record*.

"Professor Keyes has done the profession good service in this thorough revision of the original work which Professor Van Buren and himself prepared, now many years ago. As the latter states in his preface, litholapaxy has had its birth since that date, the surgery of the kidney has been constructed anew, and very different views are entertained as to the pathology and treatment of many of the abnormal conditions of the genito-urinary system. Thoroughly modernized as Dr. Keyes's important work now is, it will long remain a monument of the skill, originality, and tact of its talented author."—*College and Clinical Record*.

"Dr. Keyes, from his daily contact with students, knows their needs, and his pointed manner of saying the right thing shows that he knows how to teach. To the practitioner also, who wants a work to which he can refer at all times with confidence, when seeking guidance for the proper man-

SPECIMEN OF ILLUSTRATION.



agement of an old case of stone, or enlarged prostate, or any genito-urinary trouble, we can heartily recommend this edition of Keyes's book."—*Practice*.

"Professor Keyes has now become so well and favorably known in connection with genito-urinary surgery that any work bearing his name is sufficiently recommended, and we are sure this new revision of Van Buren and Keyes's text-book is quite up to any work upon the same subject heretofore produced. We can recommend it highly because it is a complete treatise of the diseases of the genito-urinary system, including syphilis, and further, on account of the able and practical manner with which the subject is handled. Any one who will carefully read the pages of this work will find his time has been well spent."—*Canada Lancet*.

"The labors of Dr. Keyes are too well known to require further commendation. The last effort is eminently lucid and practical, and is deserving of general recognition. There are some things with which we might feel disposed to differ with the author—notably, treatment of syphilis and urethral stricture—but the general merit of the

production compels us to refrain from criticism. It ought to be in the hands of every physician, for it is interesting and instructive. The publishers have, as usual, issued it in good style."—*Medical and Surgical Synopsis*.

"It is safe to predict that no book of the year will meet with a more eager welcome than this revision by Dr. Keyes of the classical work of which he was joint author. . . . He has virtually rewritten the book which first gave him fame, bringing to the work the experience of added years of active labor, and the result is a treatise on the subject, of which it is not too high praise to say that it stands without a peer in the English language. It is valuable alike to the surgeon and the physician, the oculist, the aurist, the gynecologist, the alienist, and the general practitioner, for, unhappily, the subject of which it treats exercises a defining influence on a large proportion of the ills of humanity. From the fetus in utero to the octogenarian 'the trail of the serpent is over them all,' and every practitioner of medicine in every varying circumstance of practice may profit by Dr. Keyes's labors."—*Pittsburgh Medical Review*.

KEYES. The Tonic Treatment of Syphilis. By E. L. KEYES, A. M., M. D., Adjunct Professor of Surgery and Professor of Dermatology in the Bellevue Hospital Medical College, etc. 8vo. 83 pages. Cloth, \$1.00.

"My studies in syphilitic blood have yielded results at once so gratifying to me, and so convincing as to the tonic influence of minute doses of mercury, that I feel impelled to lay this brief treatise before the medical public in support of a continuous treatment of syphilis by small (tonic) doses of mercury. I believe that a general trial of the method will, in the long run, vindicate its excellence."—*Extract from Preface*.

KINGSLEY. A Treatise on Oral Deformities, as a Branch of Mechanical Surgery. By NORMAN W. KINGSLEY, M. D. S., D. D. S., President of the Board of Censors of the State of New York, late Dean of the New York College of Dentistry and Professor of Dental Art and Mechanism, etc., etc. With over 350 Illustrations. 8vo. Cloth, \$5.00; sheep, \$6.00.

SPECIMEN OF ILLUSTRATION.



"I have read with great pleasure and much profit your valuable 'Treatise on Oral Deformities.' The work contains much original matter of great practical value, and is full of useful information, which will be of great benefit to the profession."—LEWIS A. SAYRE, M. D., LL. D., *Professor of Orthopedic Surgery and Clinical Surgery, Bellevue Hospital Medical College*.

"A casual glance at this work might impress the reader with the idea that its contents were of more practical value to the dentist than to the general practitioner or surgeon. But it is by no means a mere work on dentistry, although a practical knowledge of the latter art seems to be essential to the carrying out of the author's views regarding the correction of the different varieties of oral deformities of which he treats. We would be doing injustice to the work did not we make particular reference to the masterly chapter on the treatment of fractures of the lower jaw. The whole subject is so thoroughly studied that nothing is left to be desired by any surgeon who wishes to treat these fractures intelligently and successfully. The work, as a whole, bears marks of originality in every section, and impresses the reader with the painstaking efforts of the author to get at the truth, and apply it in an ingenious and practical way to the wants of the general practitioner, the surgeon, and the dentist."—*Medical Record*.

"The profession is to be congratulated on possessing so valuable an addition to its literature, and the author to be unstintedly praised for his successful issue to an arduous undertaking. The work bears, in a word, every evidence of having been written leisurely and with care. . . ."—*Dental Cosmos*.

"I consider it to be the most valuable work that has ever appeared in this country in any department of the science of dental surgery. There is no doubt of its great value to every man who wishes to study and practice this branch of surgery, and I hope it may be adopted as a text-book in every dental college, that the students may have the benefit of the great experience of the author. It places many things between the covers of one book which heretofore I have been obliged to look for in many directions, and often without success."—FRANK ABBOT, M. D., *Dean of the New York College of Dentistry*.

"The writer does not hesitate to express his belief that the chapters on the 'aesthetics of dentistry' will be found of more practical value to the prosthetic dentist than all the other essays on this subject existent in the English language. . . . A perusal of its pages seems to compel the mind to advance in directions variously indicated; so variously, indeed, that there is hardly a page of the book which does not contain some important truth, some pregnant hint, or some valuable conclusion."—*Dental Miscellany*.

LEGG. On the Bile, Jaundice, and Bilious Diseases. By J.

WICKHAM LEGG, M. D., F. R. C. S., Assistant Physician to St. Bartholomew's Hospital, and Lecturer on Pathological Anatomy in the Medical School. With Illustrations in Chromo-lithography. Svo. 719 pages. Cloth, \$6.00; sheep, \$7.00.

" . . . And let us turn—which we gladly do—to the mine of wealth which the volume itself contains, for it is the outcome of a vast deal of labor; so great, indeed, that one unfamiliar with it would be surprised at the number of facts and references which the book contains."—*Medical Times and Gazette, London*.

"The book is an exceedingly good one, and, in some points, we doubt if it could be made better. . . . And we venture to say, after an attentive perusal of the whole, that any one who takes it in hand will derive from it both information and pleasure; it gives such ample evidence of honest hard work, of wide reading, and an impartial attempt to state the case of jaundice, as it is known by observation up to the present date. The book will not only live, but be in the enjoyment of a vigorous existence long after some of the more popular productions of the present age are buried, past all hope of resurrection."—*London Medical Record*.

"This portly tome contains the fullest account of the subjects of which it treats in the English language. The historical, scientific, and practical details are all equally well worked out, and together constitute a repertorium of knowledge which no practitioner can well do without. The illustrative chromo-lithographs are beyond all praise."—*Edinburgh Medical Journal*.

"I congratulate you on having written a book containing so much valuable and original matter. It will prove of value not only to dentists, but also to surgeons and physicians."—FRANK HASTINGS HAMILTON, M. D., LL. D., *Professor of the Practice of Surgery with Operations, and of Clinical Surgery in Bellevue Hospital Medical College*.

SPECIMEN OF ILLUSTRATION.

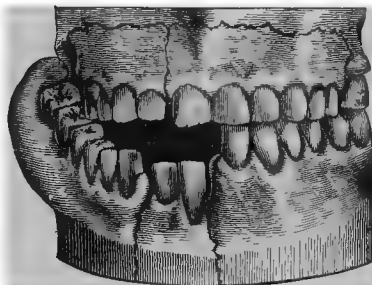

"To the surgeon and general practitioner of medicine, as well as the dentist, its instruction will be found invaluable. It is clear in style, practical in its application, comprehensive in its illustrations, and so exhaustive that it is not likely to meet in these respects a rival."—WILLIAM H. DWYNELLE, A. M., M. D.

"Dr. Legg's treatise is a really great book, exhibiting immense industry and research, and full of valuable information."—*American Journal of Medical Science*.

"It seems to us an exhaustive epitome of all that is known on the subject."—*Philadelphia Medical Times*.

"This volume is one which will command professional respect and attention. It is, perhaps, the most comprehensive and exhaustive treatise upon the subject treated ever published in the English language."—*Maryland Medical Journal*.

"It is the work of one who has thoroughly studied the subject, and who, when he finds the evidence conflicting on disputed points, has attempted to solve the problem by experiments and observations of his own."—*Practitioner, London*.

"It is a valuable work of reference and a welcome addition to medical literature."—*Dublin Journal of Medical Science*.

" . . . The reader is at once struck with the immense amount of research exhibited, the author having left unimproved no accessible source of information connected with his subject. It is, indeed, a valuable book, and the best storehouse of knowledge in its department that we know of."—*Pacific Medical and Surgical Journal*.

LETTERMAN. **Medical Recollections of the Army of the Potomac.** By JONATHAN LETTERMAN, M. D., late Surgeon U. S. A., and Medical Director of the Army of the Potomac. 8vo. 194 pages. Cloth, \$1.00.

"We venture to assert that but few who open this volume of medical annals, pregnant as they are with instruction, will care to do otherwise than finish them at a sitting."—*Medical Record.*

LITTLE. **Medical and Surgical Aspects of In-Knee (Genu-Valgum):** Its Relation to Rickets; its Prevention; and its Treatment, with or without Surgical Operation. By W. J. LITTLE, M. D., F. R. C. P., late Senior Physician to and Lecturer on Medicine at the London Hospital; Visiting Physician to the Infant Orphan Asylum at Wanstead; the Earlswood Asylum for Idiots; Founder of the Royal Orthopædic Hospital, etc. Assisted by E. MUIRHEAD LITTLE, M. R. C. S. With complete Index, and illustrated by upward of 50 Figures and Diagrams. 8vo. 161 pages. Cloth, \$2.00.

LORING. **A Text-Book of Ophthalmoscopy.** By EDWARD G. LORING, M. D. PART I.—The Normal Eye, Determination of Refraction, and Diseases of the Media. With 131 Illustrations, and Four Chromo-Lithograph Plates, containing 14 Figures. 8vo. 267 pages. Cloth, \$5.00.

SPECIMEN OF ILLUSTRATION.

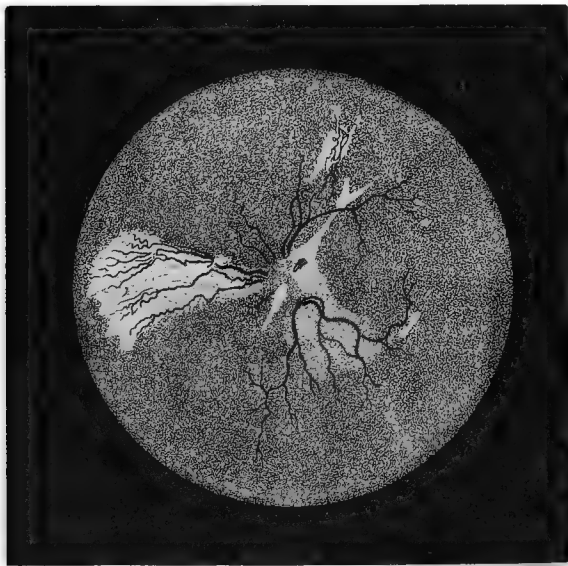

"The 'Text-book of Ophthalmoscopy,' by Edward G. Loring, M. D., is a splendid work. . . . I am well pleased with it, and am satisfied that it will be of service both to the teacher and pupil. . . . In this book Dr. Loring has given us a substantial exposition of Nature's deeds and misdeeds as they are found written in the eye, and the key by means of which they can be comprehended."—W. R. AMICK, A. M., M. D., *Professor of Ophthalmology and Otology, Cincinnati College of Medicine and Surgery.*

"This fine and scholarly work, if one may justly estimate it from this, its first part, is destined to become a classic in its branch of medical literature, being almost a cyclopaedia in its treatment of its theme."—*New England Medical Gazette.*

"Dr. E. G. Loring has written a very valuable book, and one which every physician who uses, or wishes to use, the ophthalmoscope should possess. . . . The book had a master of its scientific principles for its author, and a master of the book-maker's art for its publisher. So far as we know, it has, in this branch of ophthalmic science, no equal in the English language."—*North Carolina Medical Journal.*

"Although American ophthalmologists have done much good work, and as expert operators are excelled by none, we have no work which can take rank as a text-book with many English, German, and French books. It takes but a brief examination of this work to demonstrate its superiority to many of the so-called text-books on ophthalmoscopy which have appeared during the past few years. The chapter devoted to directions for using the ophthalmoscope can not be excelled, and every student should be as familiar with it as with Gray's anatomy. The chapter devoted to the fundus of the eye is unusually full, and the portion devoted to 'anomalies' can not fail to be of interest even to the specialist. The lithographs are very good, many of them new to ophthalmic text-books."—*Cleveland Medical Gazette.*

LUSK. The Science and Art of Midwifery. By WILLIAM THOMPSON LUSK, M. A., M. D., Professor of Obstetrics and Diseases of Women and Children in the Bellevue Hospital Medical College; Obstetric Surgeon to the Maternity and Emergency Hospitals; and Gynæcologist to the Bellevue Hospital. New edition, revised and enlarged. With 246 Illustrations. 8vo. Cloth, \$5.00; sheep, \$6.00.

"It is but a short time since we had occasion to review this work, of which we were enabled to speak in the highest terms of praise. The rapid advance of many departments of obstetrics has meantime called for a few additions. These having been made, it can be confidently said that Lusk's midwifery holds a high place amongst American authors, and deserves to be extensively employed for reference, and recommended to students as a reliable and unusually readable text-book."—*Canada Medical and Surgical Journal.*

"The book is now beyond criticism, for it has been accepted by the unerring judgment of the great body of physicians. We congratulate Dr. Lusk upon this reward for the immense labor he has bestowed upon it."—*New York Medical Journal.*

"It contains one of the best expositions of the obstetric science and practice of the day with which we are acquainted. Throughout the work the author shows an intimate acquaintance with the literature of obstetrics, and gives evidence of large practical experience, great discrimination, and sound judgment. We heartily recommend the book as a full and clear exposition of obstetric science and safe guide to student and practitioner."—*London Lancet.*

SPECIMENS OF ILLUSTRATIONS.

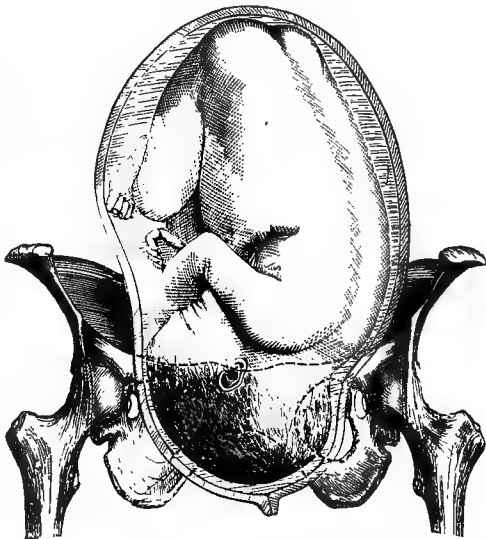

"The work is, perhaps, better adapted to the wants of the student as a text-book, and to the practitioner as a work of reference, than any other one publication on the subject. It contains about all that is known of the *ars obstetrica*, and must add greatly to both the fame and fortune of the distinguished author."—*Medical Herald, Louisville.*

"Dr. Lusk's style is clear, generally concise, and he has succeeded in putting in less than seven hundred pages the best exposition in the English language of obstetric science and art. The book will prove invaluable alike to the student and the practitioner."—*American Practitioner.*

"Dr. Lusk's book is eminently viable. It can not fail to live and obtain the honor of a second, a third, and nobody can foretell how many editions. It is the mature product of great industry and acute observation. It is by far the most learned and most complete exposition of the science



and art of obstetrics written in the English language. It is a book so rich in scientific and practical information that nobody practicing obstetrics ought to deprive himself of the advantage he is sure to gain from a frequent recourse to its pages."—*American Journal of Obstetrics.*

LUYS. The Brain and its Functions. By J. LUYs, Physician to the Hospice de la Salpêtrière. With Illustrations. 12mo. Cloth, \$1.50.

"No living physiologist is better entitled to speak with authority upon the structure and functions of the brain than Dr. Luy's. His studies on the anatomy of the nervous system are acknowledged to be the fullest and most systematic ever undertaken."—*St. James's Gazette*.

"It is not too much to say that M. Luy's has gone further than any other investigator into this great field of study, and only those who are at least dimly aware of the vast changes going on in the realm of psychology can appreciate the importance of his revelations. Particularly interest-

ing and valuable are the chapters dealing with the genesis and evolution of memory, the development of automatic activity, and the development of the notion of personality."—*Boston Evening Traveller*.

"Dr. Luy's, at the head of the great French Insane Asylum, is one of the most eminent and successful investigators of cerebral science now living; and he has given unquestionably the clearest and most interesting brief account yet made of the structure and operations of the brain."—*Popular Science Monthly*.

MARKOE. A Treatise on Diseases of the Bones. By THOMAS M. MARKOE, M. D., Professor of Surgery in the College of Physicians and Surgeons, New York, etc. With numerous Illustrations. 8vo. 416 pages. Cloth, \$4.50.

This valuable work is a treatise on Diseases of the Bones, embracing their structural changes as affected by disease, their clinical history and treatment, including also an account of the various tumors which grow in or upon them. None of the *injuries* of bone are included in its scope, and no *joint* diseases, excepting where the condition of the bone is a prime factor in the problem of disease. As the work of an eminent surgeon of large and varied experience, it may be regarded as the best on the subject, and a valuable contribution to medical literature.

MAUDSLEY. Body and Mind: An Inquiry into their Connection and Mutual Influence, especially in reference to Mental Disorders; an enlarged and revised edition, to which are added Psychological Essays. By HENRY MAUDSLEY, M. D., London. 12mo. 275 pages. Cloth, \$1.50.

The general plan of this work may be described as being to bring man, both in his physical and mental relations, as much as possible within the scope of scientific inquiry.

"Many and valuable books have been written by English physicians on insanity, idiocy, and all the forms of mental aberration. But derangement had always been treated as a distinct subject, and therefore empirically. That the phenomena of sound and unsound minds are not matters of distinct investigation, but inseparable parts of one and the same inquiry, seems a truism as soon as stated. But, strange to say, they had always been pursued separately, and been in the hands of two distinct classes of investigators. The logicians and metaphysicians occasionally borrowed a stray fact from the abundant cases compiled by the medical authorities; but the physician, on the other hand, had no theoretical clew to his obser-

vations beyond a smattering of dogmatic psychology learned at college. To effect a reconciliation between the Psychology and the Pathology of the mind, or rather to construct a basis for both in a common science, is the aim of Dr. Maudsley's book."—*London Saturday Review*.

"A representative work, which every one must study who desires to know what is doing in the way of real progress, and not mere chatter, about mental physiology and pathology."—*Lancet*.

"It distinctly marks a step in the progress of scientific psychology."—*The Practitioner*.

MAUDSLEY. Responsibility in Mental Diseases. By HENRY MAUDSLEY, M. D., London. 12mo. 313 pages. Cloth, \$1.50.

"This book is a compact presentation of those facts and principles which require to be taken into account in estimating human responsibility—not legal responsibility merely, but responsibility for conduct in the family, the school, and

all phases of social relation, in which obligation enters as an element. The work is new in plan, and was written to supply a wide-felt want which has not hitherto been met."—*The Popular Science Monthly*.

MAUDSLEY. The Pathology of Mind. Being the third edition of the Second Part of the "Physiology and Pathology of Mind," recast, enlarged, and rewritten. By HENRY MAUDSLEY, M. D., London. 12mo. 580 pages. \$2.00.

CONTENTS.—Chapter I. Sleeping and Dreaming; II. Hypnotism, Somnambulism, and Allied States; III. The Causation and Prevention of Insanity: (A) Etiological; IV. The same continued;

V. The Causation and Prevention of Insanity; (B) Pathological; VI. The Insanity of Early Life; VII. The Symptomatology of Insanity; VIII. The same continued; IX. Clinical Groups of Mental Disease; X. The Morbid Anatomy of Mental Derangement; XI. The Treatment of Mental Disorders.

The new material includes chapters on "Dreaming," "Somnambulism and its Allied States," and large additions in the chapters on the "Causation and Prevention of Insanity."

"Unquestionably one of the ablest and most important works on the subject of which it treats that has ever appeared, and does credit to his philosophical acumen and accurate observation."—*Medical Record*.

"Dr. Maudsley has had the courage to undertake, and the skill to execute, what is, at least in English, an original enterprise."—*London Saturday Review*.

MAUDSLEY. The Physiology of the Mind. Being the First Part of a third edition, revised, enlarged, and in a great part rewritten, of "The Physiology and Pathology of the Mind." By HENRY MAUDSLEY, M. D., London. 12mo. 547 pages. Cloth, \$2.00.

CONTENTS.—Chapter I. On the Method of the Study of the Mind; II. The Mind and the Nervous System; III. The Spinal Cord, or Tertiary Nervous Centers; or, Nervous Centers of Reflex Action; IV. Secondary Nervous Centers, or Sensory Ganglia; Sensorium Commune; V. Hemispherical Ganglia; Cortical Cells of the Cerebral Hemispheres; Ideational Nervous Centers; Primary Nervous Centers; Intellectorium Commune; VI. The Emotions; VII. Volition; VIII. Motor Nervous Centers, or Motorium Commune and Actuation or Effectation; IX. Memory and Imagination.

"The 'Physiology of the Mind,' by Dr. Maudsley, is a very engaging volume to read, as it is a fresh and vigorous statement of the doctrines of a growing scientific school on a subject of transcendent moment, and, besides many new facts and important views brought out in the text, is en-

riched by an instructive display of notes and quotations from authoritative writers upon physiology and psychology; and by illustrative cases, which add materially to the interest of the book."—*Popular Science Monthly*.

MCSHERRY. Health, and How to Promote it. By RICHARD MCSHERRY, M. D., Professor of Practice of Medicine, University of Maryland; President of Baltimore Academy of Medicine, etc. 12mo. 185 pages. Cloth, \$1.25.

"An admirable production which should find its way into every family in the country. It comprises a vast amount of the most valuable matter expressed in clear and terse language, and the subjects of which it treats are of the deepest interest to every human being."—*Prof. S. D. Gross, of Jefferson Medical College, Philadelphia*.

"On the whole, this little book seems to us very well adapted to its purpose, and will, we hope, have a wide circulation, when it can not fail to do much good."—*American Journal of the Medical Sciences*.

"It is the work of an able physician, and is written in a style which all people can understand. It deals with practical topics, and its ideas are set forth so pointedly as to make an impression."—*The Independent*.

"This is a racy little book of 185 pages, full of good advice and important suggestions, and written in a free and easy style, which crops out in continued humor and crispness by which the advice is seasoned, and which render the reading of the book a pleasant pastime to all, whether professionals or non-professionals."—*Canadian Journal of Medical Science*.

"It contains a great deal of useful information, stated in a very simple and attractive way."—*Baltimore Gazette*.

"This is one of the best popular essays on the subject we have ever seen. It is short, clear, positive, sensible, bright and entertaining in its style, and is as full of practical suggestions as a nut is full of meat."—*Literary World*.

NEFTEL. Galvano-Therapeutics. The Physiological and Therapeutical Action of the Galvanic Current upon the Acoustic, Optic, Sympathetic, and Pneumogastric Nerves. By WILLIAM B. NEFTEL. Fourth edition. 12mo. 161 pages. Cloth, \$1.50.

This book has been republished at the request of several aural surgeons and other professional gentlemen, and is a valuable treatise on the subjects of which it treats. Its author, formerly visiting physician to the largest hospital of St. Petersburg, has had the very best facilities for investigation.

"This little work shows, as far as it goes, full knowledge of what has been done on the subjects treated of, and the author's practical acquaintance with them."—*New York Medical Journal*.

"Those who use electricity should get this work, and those who do not should peruse it to learn that there is one more therapeutical agent that they could and should possess."—*The Medical Investigator*.

NEUMANN. Hand-Book of Skin Diseases. By Dr. ISIDOR NEUMANN, Lecturer on Skin Diseases in the Royal University of Vienna. Translated from the German, second edition, with Notes, by LUCIUS D. BULKLEY, A. M., M. D., Surgeon to the New York Dispensary, Department of Venereal and Skin Diseases; Assistant to the Skin Clinic of the College of Physicians and Surgeons, New York, etc., etc. 8vo. 467 pages and 66 Woodcuts. Cloth, \$4.00; sheep, \$5.00.

Prof. Neumann ranks second only to Hebra, whose assistant he was for many years, and his work may be considered as a fair exponent of the German practice of Dermatology. The book is abundantly illustrated with plates of the histology and pathology of the skin. The translator has endeavored, by means of notes from French, English, and American sources, to make the work valuable to the student as well as to the practitioner.

"It is a work which I shall heartily recommend to my class of students at the University of Pennsylvania, and one which I feel sure will do much toward enlightening the profession on this subject."—*Louis A. Duhring.*

"There certainly is no work extant which deals so thoroughly with the Pathological Anatomy of the Skin as does this hand-book."—*New York Medical Record.*

"I have already twice expressed my favorable opinion of the book in print, and am glad that it is given to the public at last."—*James C. White, Boston.*

"More than two years ago we noticed Dr. Neumann's admirable work in its original shape, and we are therefore absolved from the necessity of saying more than to repeat our strong recommendation of it to English readers."—*Practitioner.*

NIEMEYER. A Text-Book of Practical Medicine. With Particular Reference to Physiology and Pathological Anatomy. By the late Dr. FELIX VON NIEMEYER, Professor of Pathology and Therapeutics; Director of the Medical Clinic of the University of Tübingen. Translated from the eighth German edition, by special permission of the author, by GEORGE H. HUMPHREYS, M. D., one of the Physicians to Trinity Infirmary, Fellow of the New York Academy of Medicine, etc., and CHARLES E. HACKLEY, M. D., one of the Physicians to the New York Hospital and Trinity Infirmary, etc. Revised edition of 1880. 8vo. 1,628 pages. Cloth, \$9.00; sheep, \$11.00.

The author undertakes, first, to give a picture of disease which shall be as life-like and faithful to nature as possible, instead of being a mere theoretical scheme; secondly, so to utilize the more recent advances of pathological anatomy, physiology, and physiological chemistry, as to furnish a clearer insight into the various processes of disease.

The work has met with the most flattering reception and deserves success; has been adopted as a text-book in many of the medical colleges both in this country and in Europe; and has received the very highest encomiums from the medical and secular press.

"This new American edition of Niemeyer fully sustains the reputation of previous ones, and may be considered, as to style and matter, superior to any translation that could have been made from the latest German edition. It will be recollected that since the death of Prof. Niemeyer, in 1871, his work has been edited by Dr. Eugene Scitz. Although the latter gentleman has made many additions and changes, he has destroyed somewhat the individuality of the original. The American editors have wisely resolved to preserve the style of the author, and adhere, as closely as possible, to his individual views and his particular style. Extra articles have been inserted on chronic alcoholism, morphia-poisoning, paralysis agitans, scleroderma, elephantiasis, progressive pernicious anæmia, and a chapter on yellow fever. The work is well printed as usual."—*Medical Record.*

"The first inquiry in this country regarding a German book generally is, 'Is it a work of practical value?' Without stopping to consider the justness of the American idea of the 'practical,'

we can unhesitatingly answer, 'It is!'"—*New York Medical Journal.*

"It is comprehensive and concise, and is characterized by clearness and originality."—*Dublin Quarterly Journal of Medicine.*

"Its author is learned in medical literature; he has arranged his materials with care and judgment, and has thought over them."—*The Lancet.*

"While, of course, we can not undertake a review of this immense work of about 1,600 pages in a journal of the size of ours, we may say that we have examined the volumes very carefully, as to whether to recommend them to practitioners or not; and we are glad to say, after a careful review, 'Buy the book.' The chapters are succinctly written. terse terms and, in the main, brief sentences are used. Personal experience is recorded, with a proper statement of facts and observations by other authors who are to be trusted. A very excellent index is added to the second volume, which helps very much for ready reference."—*Virginia Medical Monthly.*

NIGHTINGALE. Notes on Nursing: WHAT IT IS, AND WHAT IT IS NOT. By FLORENCE NIGHTINGALE. 12mo. 140 pages. Cloth, 75 cents.

These notes are meant to give hints for thought to those who have personal charge of the health of others.

Every-day sanitary knowledge, or the knowledge of nursing, or, in other words, of how to put the constitution in such a state as that it will have no disease or that it can recover from disease, is recognized as the knowledge which every one ought to have—distinct from medical knowledge, which only a profession can have.

OSWALD. Physical Education; or, The Health Laws of Nature. By FELIX L. OSWALD, M. D. 12mo. Cloth, \$1.00.

"Dr. Oswald is a medical man of thorough preparation and large professional experience, and an extensively traveled student of nature and of men. While in charge of a military hospital at Vera Cruz, his own health broke down from long exposure in a malarial region, and he then struck for the Mexican mountains, where he became director of another medical establishment. He has also journeyed extensively in Europe, South America, and the United States, and always as an open-eyed, absorbed observer of nature and of men. The 'Physical Education' is one of the most wholesome and valuable books that have emanated from the American press in many a day. Not only can everybody understand it, and, what is more, feel it, but everybody that gets it will be certain to read and re-read it. We have known of the positive and most salutary influence of the papers as they appeared in the 'Monthly,' and the extensive demand for their publication in a separate form shows how they have been appreciated. Let those who are able and wish to do good buy it wholesale and give it to those less able to obtain it."—*The Popular Science Monthly*.

"Here we have an intelligent and sensible treatment of a subject of great importance, viz., physical education. We give the headings of some of the chapters, viz.: Diet; In-door Life; Out-door Life; Gymnastics; Clothing; Sleep; Recreation; Remedial Education; Hygienic Precautions; Popular Fallacies. These topics are discussed in a plain, common-sense style suited to the popular

mind. Books of this character can not be too widely read."—*Albany (N. Y.) Argus*.

"Dr. Oswald is as epigrammatic as Emerson, as spicy as Montaigne, and as caustic as Heine. And yet he is a pronounced vegetarian. His first chapter is devoted to a consideration of the diet suitable for human beings and infants. In the next two he contrasts life in and out of doors. He then gives his ideas on the subjects of gymnastics, clothing, sleep, and recreation. He suggests a system of remedial education and hygienic precautions, and he closes with a diatribe against popular fallacies."—*Philadelphia Press*.

"It is a good sign that books on physical training multiply in this age of mental straining. Dr. Felix L. Oswald, author of the above book, may be somewhat sweeping in his statements and beliefs, but every writer who, like him, clamors for simplicity, naturalness, and frugality in diet, for fresh air and copious exercise, is a benefactor. Let the dyspeptic and those who are always troubling themselves and their friends about their manifold ailments take Dr. Oswald's advice and look more to their ailments and their exercise."—*New York Herald*.

"One of the best books that can be put in the hands of young men and women. It is very interesting, full of facts and wise suggestions. It points out needed reforms, and the way we can become a strong and healthy people. It deserves a wide circulation."—*Boston Commonwealth*.

PEASLEE. Ovarian Tumors; THEIR PATHOLOGY, DIAGNOSIS, AND TREATMENT, WITH REFERENCE ESPECIALLY TO OVARIOTOMY. By E. R. PEASLEE, M. D., Professor of Diseases of Women in Dartmouth College; formerly Professor of Obstetrics and Diseases of Women in the New York Medical College, etc. 8vo. 551 pages. Illustrated with many Woodcuts, and a Steel Engraving of Dr. E. McDowell, the "Father of Ovariectomy." Cloth, \$5.00; sheep, \$6.00.

This valuable work, embracing the results of many years of successful experience in the department of which it treats, will prove most acceptable to the entire profession; while the high standing of the author and his knowledge of the subject combine to make the book the best in the language. Fully illustrated, and abounding with information, the result of a prolonged study of the subject, the work should be in the hands of every physician in the country.

"In closing our review of this work, we can not avoid again expressing our appreciation of the thorough study, the careful and honest statements, and candid spirit, which characterize it. For the use of the student we should give the preference to Dr. Peaslee's work, not only from its completeness, but from its more methodical arrangement."—*American Journal of the Medical Sciences*.

"We deem its careful perusal indispensable to all who would treat ovarian tumors with a good conscience."—*American Journal of Obstetrics*.

"It shows prodigal industry, and embodies within its five hundred and odd pages pretty much all that seems worth knowing on the subject of ovarian diseases."—*Philadelphia Medical Times*.

PEREIRA. *Dr. Pereira's Elements of Materia Medica and Therapeutics.* Abridged and adapted for the Use of Medical and Pharmaceutical Practitioners and Students, and comprising all the Medicines of the British Pharmacopœia, with such others as are frequently ordered in Prescriptions, or required by the Physician. Edited by ROBERT BENTLEY and THEOPHILUS REDWOOD. New edition. Brought down to 1872. Royal 8vo. 1,093 pages. Cloth, \$7.00; sheep, \$8.00.

PEYER. *An Atlas of Clinical Microscopy.* By ALEXANDER PEYER, M. D. Translated and edited by ALFRED C. GIRARD, M. D., Assistant Surgeon United States Army. First American, from the manuscript of the second German edition, with Additions. 90 Plates, with 105 Illustrations, Chromo-Lithographs. Square 8vo. Cloth, \$6.00.

"All who are interested in clinical microscopy will be pleased with the design and execution of this work, and will feel under obligation to the author, translator, and publishers for placing so valuable a work in their hands. The plates in which are figured the various urinary inorganic deposits are especially fine, and the various forms of tubercasts, hyaline, waxy, epithelial, and mucous, are depicted with great fidelity and accuracy."—*Philadelphia Medical Times.*

"To those students and practitioners of medicine who are interested in microscopical work and who are familiar with the use of this valuable aid to human vision in the study of nature, the present work will prove of incalculable value, since it represents the original work of an accomplished microscopist and artist. Accompanying the plates is a text of explanatory notes showing the various methods of working with the microscope and the significance of what is observed. The plates have been most handsomely printed. We have seen nothing in this special line of study that will com-

pare in point of accuracy of detail and artistic effect with the work under consideration."—*Maryland Medical Journal.*

"There is probably no work in any language that will prove of as much real service to the beginner in microscopy as the one before us, and this value is due to the number and excellence of the plates with which it is literally crowded. One ordinary plate is often worth ten pages of explanation; who then can reckon the assistance lent by a life-size, well-colored plate such as we have here?"—*Peoria Medical Monthly.*

"This valuable and beautiful addition to scientific and medical literature can not but be destined to receive a warm welcome from a wide circle of students and practitioners. . . . So practically useful are its contents, and so attractive—one may almost say artistic—is the form in which it is presented, that to see it is to covet it; to own it is to rejoice in its possession."—*New England Medical Gazette.*

POMEROY. *The Diagnosis and Treatment of Diseases of the Ear.* By OREN D. POMEROY, M. D., Surgeon to the Manhattan Eye and Ear Hospital, etc. With 100 Illustrations. New edition, revised and enlarged. 8vo. Cloth, \$3.00.

"The several forms of aural disease are dealt with in a manner exceedingly satisfactory. The work is quite exhaustive in its scope, and will represent an authority on this subject which we believe will be duly appreciated by the profession."—*Medical Record.*

"The author uses good language, telling in a clear and interesting manner what he has to say. The book is a valuable one for both students and practitioners."—*Lancet and Clinic.*

"The author's opportunity to know of what he writes has been abundant, and the work itself shows that he has made good use of his information. We have not the slightest reason for not commending it not only to the otologist but also to the general student."—*Therapeutic Gazette.*

"It is plain and practical in every way, and will long be one of the standard works on the subject."—*Peoria Medical Monthly.*

"Well arranged and well written, and not too scientific."—*Boston Medical and Surgical Journal.*

"This second edition has been carefully revised, and a number of pages as well as some illustrations have been added, so as to render the volume an accurate representative of the science of aural surgery as it exists to-day."—*Medical and Surgical Reporter.*

"Every country practitioner and those in small towns—in fact, every doctor who wants to treat ear-diseases—would be better prepared by having read Dr. Pomeroy's very excellent text-book."—*Daniel's Texas Medical Journal.*

"Not the least of the qualifications which have enabled Dr. Pomeroy to produce so satisfactory a work of the kind is his exceptionally large experience in the department of otology, and the pages of his treatise bear constant testimony to its extent and varied character."—*Gaillard's Med. Journal.*

POORE. Osteotomy and Osteoclasis, for the Correction of Deformities of the Lower Limbs. By CHARLES T. POORE, M. D., Surgeon to St. Mary's Free Hospital for Children, New York. 8vo. 202 pages, with 50 Illustrations. Cloth, \$2.50.

SPECIMENS OF ILLUSTRATIONS.

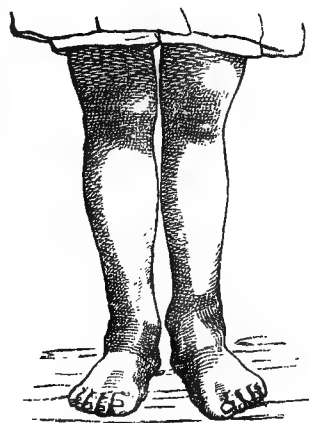
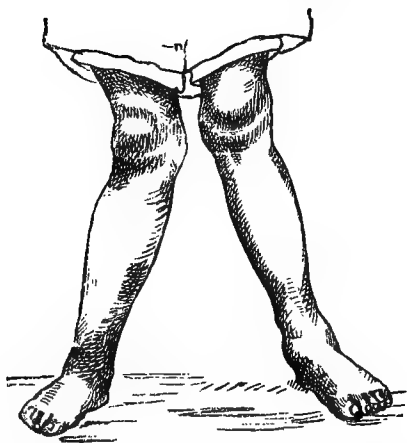

"This handsome and carefully prepared monograph treats of osteotomy as applied to the repair of genu valgum, genu varum, ankylosis of the knee-joint, deformities of the hip-joint, and for curves of the tibia. The author has enjoyed large opportunities to study these special malformations in the hospitals to which he is attached, and describes the operations from an ample observation. Quite a number of well-engraved illustrations add to the value of the volume, and an exhaustive bibliography appended enables the reader to pursue any topic in which he may be interested into the productions of other writers."—*Medical and Surgical Reporter*.

"Dr. Poore, who has already become so well known by journal articles on bone surgery, has con-

densed his experience in the work before us. He has succeeded in doing this in a very satisfactory way. We can not too strongly commend the clear and succinct manner in which the author weighs the indications for treatment in particular cases. In so doing he shows a knowledge of his subject which is as extensive as it is profound, and no one at all interested in orthopedy can read his conclusions without profit. His own cases, which are carefully reported, are valuable additions to the literature of the subject. These, together with others, which are only summarized, contain so much practical information and sound surgery that they give a special value to the work, altogether independent of its other excellences. It is a good book in every way, and we congratulate the author accordingly."—*Medical Record*.

QUAIN. A Dictionary of Medicine, including General Pathology, General Therapeutics, Hygiene, and the Diseases peculiar to Women and Children. By Various Writers. Edited by RICHARD QUAIN, M. D., F. R. S., Fellow of the Royal College of Physicians; Member of the Senate of the University of London; Member of the General Council of Medical Education and Registration; Consulting Physician to the Hospital for Consumption and Diseases of the Chest at Brompton, etc. 8vo. 1,834 pages, and 138 Illustrations. Half morocco, \$8.00. Sold only by subscription.

This work is primarily a Dictionary of Medicine, in which the several diseases are fully discussed in alphabetical order. The description of each includes an account of its etiology and anatomical characters; its symptoms, course, duration, and termination; its diagnosis, prognosis, and, lastly, its treatment. General Pathology comprehends articles on the origin, characters, and nature of disease.

General Therapeutics includes articles on the several classes of remedies, their modes of action, and on the methods of their use. The articles devoted to the subject of Hygiene treat of the causes and prevention of disease, of the agencies and laws affecting public health, of the means of preserving the health of the individual, of the construction and management of hospitals, and of the nursing of the sick.

Lastly, the diseases peculiar to women and children are discussed under their respective headings, both in aggregate and in detail.

Among the leading contributors, whose names at once strike the reader as affording a guarantee of the value of their contributions, are the following:

ALLBUTT, T. CLIFFORD, M. A., M. D.
 BARNES, ROBERT, M. D.
 BASTIAN, H. CHARLTON, M. A., M. D.
 BINZ, CARL, M. D.
 BRISTOWE, J. SYER, M. D.
 BROWN-SÉQUARD, C. E., M. D., LL. D.
 BRUNTON, T. LAUDER, M. D., D. Sc.
 FAYREER, SIR JOSEPH, K. C. S. I., M. D., LL. D.
 FOX, TILBURY, M. D.
 GALTON, Captain DOUGLAS, R. E., (retired).
 GOWERS, W. R., M. D.

GREENFIELD, W. S., M. D.
 JENNER, Sir WILLIAM, Bart., K. C. B., M. D.
 LEGG, J. WICKHAM, M. D.
 NIGHTINGALE, FLORENCE.
 PAGET, Sir JAMES, Bart.
 PARKES, EDMUND A., M. D.
 PAVY, F. W., M. D.
 PLAYFAIR, W. S., M. D.
 SIMON, JOHN, C. B., D. C. L.
 THOMPSON, Sir HENRY.
 WATERS, A. T. H., M. D.

WELLS, T. SPENCER.

"Not only is the work a Dictionary of Medicine in its fullest sense, but it is so encyclopedic in its scope that it may be considered a condensed review of the entire field of practical medicine. Each subject is marked up to date and contains in a nutshell the accumulated experience of the leading medical men of the day. As a volume for ready reference and careful study, it will be found of immense value to the general practitioner and student."—*Medical Record*.

"The 'Medical Dictionary' of Dr. Quain is something more than its title would at first indicate. It might with equal propriety be called an encyclopædia. The different diseases are fully discussed in alphabetical order. The description of each includes an account of its various attributes, often covering several pages. Although we have possessed the book only the short time since its publication, its loss would leave a void we would not know how to fill."—*Boston Medical and Surgical Journal*.

"Although a volume of over 1,800 pages, it is truly a *multum in parvo*, and will be found of much more practical utility than other works which might be named extending over many volumes. The profession of this country are under obligations to you for the republication of the work, and I desire to congratulate you on the excellence of the illustrations, together with the excellent typographical execution in all respects."—AUSTIN FLINT, M. D.

"It is with great pleasure, indeed, that we announce the publication in this country, by the Appletons, of this most superb work. Of all the medical works which have been, and which will

be, published this year, the most conspicuous one as embodying learning and research—the compilation into one great volume, as it were, of the whole science and art of medicine—is the 'Dictionary of Medicine' of Dr. Quain. Ziemssen's 'Practice of Medicine' and Reynolds's 'System of Medicine' are distinguished works, forming compilations, in the single department of practice, of the labors of many very eminent physicians, each one in his contributions presenting the results of his own observations and experiences, as well as those of the investigations of others. But in the dictionary of Dr. Quain there are embraced not merely the principles and practice of medicine in the contributions by the various writers of eminence, but general pathology, general therapeutics, hygiene, diseases of women and children, etc."—*Cincinnati Medical News*.

"In this important work the editor has endeavored to combine two features or purposes: in the first place, to offer a dictionary of the technical words used in medicine and the collateral sciences, and also to present a treatise on systematic medicine, in which the separate articles on diseases should be short monographs by eminent specialists in the several branches of medical and surgical science. Especially for the latter purpose, he secured the aid of such well-known gentlemen as Charles Murchison, John Rose Cornack, Tilbury Fox, Thomas Hayden, William Aitken, Charlton Bastian, Brown-Séguard, Sir William Jenner, Erasmus Wilson, and a host of others. By their aid he may fairly be said to have attained his object of 'bringing together the latest and most complete information, in a form which would allow of ready and easy reference.'"—*Medical and Surgical Reporter*.

RANNEY. *The Applied Anatomy of the Nervous System, being a Study of this Portion of the Human Body from a Standpoint of its General Interest and Practical Utility, designed for Use as a Text-book and as a Work of Reference.* By AMBROSE L. RANNEY, A. M., M. D., Adjunct Professor of Anatomy and late Lecturer on the Diseases of the Genito-Urinary Organs and on Minor Surgery in the Medical Department of the University of the City of New York, etc., etc. Second edition, thoroughly revised. 8vo. Profusely illustrated. Cloth, \$5.00; sheep, \$6.00.

"The many favorable reviews of the first edition of the work and its general adoption as a text-book has induced the author to modify its scope and plan, with a view of rendering it more worthy of commendation. The student who desires a trustworthy guide in the study of the anat-

omy and physiology of the nervous system, and a clear interpretation of the main facts applicable to diagnosis, will find in this book all that he could wish. The book contains 791 pages, and the typographical and mechanical execution is superb."—*Indiana Medical Journal*.

"There are very few works on the above subject, and none at all comparable with the one before us. To be perfectly candid, we will say that we know of no book so valuable to the physician, in every branch of the profession, as the one above mentioned. Proper and successful practice must of necessity depend upon a proper diagnosis, and it is for this end that Dr. Ranney has written this work. Based upon a sound knowledge of anatomy—minute, general, and special—this excellent treatise covers the ground fully. The type is large and clear, and the illustrations are very excellent, both in correctness and in artistic execution. The thorough manner in which physiological functions are pointed out in connection with anatomical teaching, thus leading one on to appreciate the pathological changes and manifestations, is a grand feature of the book. No progressive physician should be without this very valuable work."—*Southern Clinic*.

"The second edition of Dr. Ranney's excellent work on the applied anatomy of the nervous system has been almost entirely rewritten, so that it includes the latest discoveries in the anatomy and physiology of the brain and the nervous system. A careful study of the anatomy and uses of nerve structure is of the utmost importance in the correct diagnosis of a host of diseases about which, without the information obtained in a work like this, we should be very much in the dark. By means of a very full table of contents the reader can turn at once to the action of every nerve and branch of nerve in health and the disturbance produced by it when diseased."—*New York Medical Times*.

"This work will be found exceedingly useful by all who come frequently in contact with those suffering from disease of the nervous system. Its object is to aid in the anatomical diagnosis of such diseases. It is unusually complete in its treatment of the subject. Numerous diagrams and illustrations have been introduced in order to make explanations clear. The present, although called a new edition, is practically a new book. It is much larger and for the most part newly written. If we were to make any criticism upon the book, it would be to urge the author to condense the subject-matter. So much of the substance of the work deals with the physiology of the nervous system that the title is somewhat misleading as regards its scope."—*Journal of the American Medical Association*.

"The book will be a great help to the student of neurology, since it sets to his hand matter which otherwise could be found only by tedious research through many volumes, and for the same reason

RICHARDSON. A Ministry of Health and other Addresses.

By B. W. RICHARDSON, M. D., M. A., F. R. S., etc. 12mo. 354 pages. Cloth, \$1.50.

"The author is so widely and favorably known that any book which bears his name will receive respectful attention. He is one of those highly educated yet practical, public-spirited gentlemen who adorn the profession of medicine and do far more than their share toward elevating its position before the public. This book, owing to the character of the matter considered and the author's attractive style, affords means for relaxation and instruction to every thoughtful person."—*Medical Gazette*.

"This book is made up of a number of addresses on sanitary subjects, which Dr. Richardson

SPECIMEN OF ILLUSTRATION.

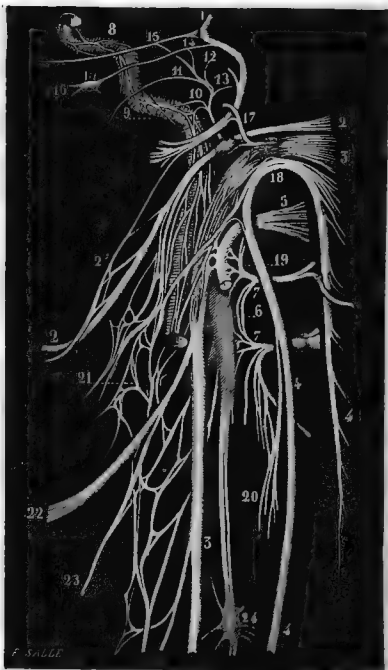

the practitioner will give it hearty welcome."—*American Practitioner and News*.

"This is without exception one of the best treatises on Applied Anatomy of the Nervous System to be found in any language. It is clearly written, the type good, and the plates are all that could be desired. In reading the ordinary works on the Physiology of the Nervous System, one finds many contradictions, and many confused ideas naturally result. In this work every part is, so far as possible, dealt with separately, carefully, and thoroughly explained so as to leave its teachings clear in the mind of the student. We especially recommend this treatise, for it is a work of great excellence, and we are sure one which the neurologist will find indispensable, while the general practitioner will find it one of the most useful works in his library."—*Canada Lancet*.

delivered at various times in Great Britain, and which are intended to invite attention to the pressing reforms that are making progress in medical science. The work, which has the great merit of being written in the simplest and clearest language, gives special attention to the origin and causes of diseases, and a demonstration of the physical laws by which they may be prevented. . . . The author does not, like some members of his profession, enter into a learned description of cures, but traces the causes of diseases with philosophical precision. The book contains what every one should know, and members of the medical profession will not find a study of it in vain."—*Phila. Enquirer*.

RICHARDSON. Diseases of Modern Life. By B. W. RICHARDSON, M. D., M. A., F. R. S., etc., etc. 12mo. 520 pages. Cloth, \$2.00.

"In this valuable and deeply interesting work Dr. Richardson treats the nervous system as the very principle of life, and he shows how men do it violence, yet expect immunity where the natural sentence is death."—*Charleston Courier*.

"The work is of great value as a practical guide to enable the reader to detect and avoid various sources of disease, and it contains, in addition, several introductory chapters on natural life and natural death, the phenomena of disease, disease antecedent to birth, and on the effects of the

seasons of atmospheric temperature, of atmospheric pressure, of moisture, winds, and atmospheric chemical changes, which are of great general interest."—*Nature*.

"Particular attention is given to diseases from worry and mental strain, from the passions, from alcohol, tobacco, narcotics, food, impure air, late hours, and broken sleep, idleness, intermarriage, etc., thus touching upon causes which do not enter into the consideration of sickness."—*Boston Commonwealth*.

ROBINSON. A Manual of Dermatology. By A. R. ROBINSON, M. B., L. R. C. P. and S. (Edinburgh), Professor of Dermatology at the New York Polyclinic; Professor of Histology and Pathological Anatomy at the Woman's Medical College of the New York Infirmary. Revised and corrected. 8vo. 647 pages. Cloth, \$5.00.

"It includes so much good, original work, and so well illustrates the best practical teachings of the subject by our most advanced men, that I regard it as commanding at once a place in the very front rank of all authorities. . . ."—JAMES NEVINS HYDE, M. D.

"Dr. Robinson's experience has amply qualified him for the task which he assumed, and he has given us a book which commends itself to the consideration of the general practitioner."—*Medical Age*.

"In general appearance it is similar to Duhring's excellent book, more valuable, however, in that it contains much later views, and also on account of the excellence of the anatomical description accompanying the microscopical appearances of the diseases spoken of."—*St. Louis Medical and Surgical Journal*.

"Altogether it is an excellent work, helpful to every one who consults its pages for aid in the study of skin-diseases. No physician who studies it will regret placing it in his library."—*Detroit Lancet*.

ROSCOE AND SCHORLEMMER. A Treatise on Chemistry.

By H. R. ROSCOE, F. R. S., and C. SCHORLEMMER, F. R. S., Professors of Chemistry in the Victoria University, Owens College, Manchester. Illus.

Inorganic Chemistry. 8vo. Vol. I: NON-METALLIC ELEMENTS. \$5.00.

Vol. II, Part I: METALS. \$3.00. Vol. II, Part II: METALS. \$3.00.

Organic Chemistry. 8vo. Vol. III, Part I: THE CHEMISTRY OF THE HYDROCARBONS AND THEIR DERIVATIVES. \$5.00. Vol. III, Part II: THE SAME. \$5.00. Vol. III, Part III: THE SAME. Cloth, \$3.00. Vol. III, Part IV: THE SAME. Cloth, \$3.00. Vol. III, Part V: THE SAME. Cloth, \$3.00.

SPECIMEN OF ILLUSTRATION.

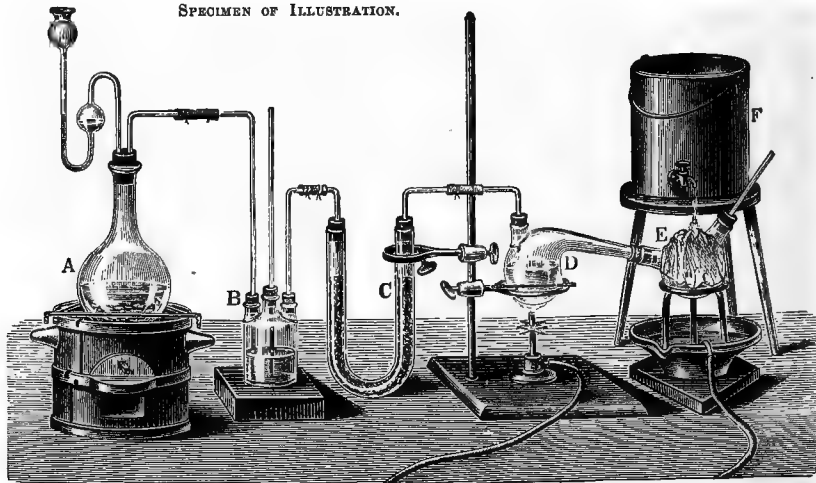

"It has been the aim of the authors, in writing their present treatise, to place before the reader a fairly complete and yet a clear and succinct statement of the facts of Modern Chemistry, while at the same time entering so far into a discussion of chemical theory as the size of the work and the present transition state of the science will permit.

"Special attention has been paid to the accurate description of the more important processes in technical chemistry, and to the careful representation of the most approved forms of apparatus employed.

"Much attention has likewise been given to the representation of apparatus adopted for lecture-room experiment, and the numerous new illustrations required for this purpose have all been taken from photographs of apparatus actually in use."—*Extract from Preface.*

"The authors are evidently bent on making their book the finest systematic treatise on modern chemistry in the English language, an aim in which they are well seconded by their publishers, who spare neither pains nor cost in illustrating and otherwise setting forth the work of these distinguished chemists."—*London Athenæum.*

"It is difficult to praise too highly the selection of materials and their arrangement, or the wealth of illustrations which explain and adorn the text. In its woodcuts, in its technological details, in its historical notices, in its references to original memoirs, and, it may be added, in its clear type, smooth paper, and ample margins, the volume under review presents most commendable features. Whatever tests of accuracy as to figures and facts we have been able to apply have been satisfactorily

met, while in clearness of statement this volume leaves nothing to be desired. Moreover, it is most satisfactory to find that the progress of this valuable work toward completion is so rapid that its beginning will not have become antiquated before its end has been reached—no uncommon occurrence with elaborate treatises on natural science subjects"—*London Academy.*

"We have no hesitation in saying that this volume fully keeps up the reputation gained by those that preceded it. There is the same masterly handling of the subject-matter; the same diligent care has been bestowed on hunting up all the old history connected with each product. It is this that lends so great a charm to the whole work, and makes it very much more than a mere text-book."—*Saturday Review.*

ROSENTHAL. General Physiology of Muscles and Nerves.

By Dr. I. ROSENTHAL, Professor of Physiology at the University of Erlangen. With 75 Woodcuts. 12mo. Cloth, \$1.50.

"Dr. Rosenthal claims that the present work is the first attempt at a connected account of general physiology of muscles and nerves.' This being the case, Dr. Rosenthal is entitled to the greatest credit for his clear and accurate presentation of the experimental data upon which must rest all future knowledge of a very important branch of medical and electrical sciences. The book consists of 817 pages, with seventy-five woodcuts, many of which represent physiological apparatus devised by the author or by his friends, Professor Du Bois-Reymond and Helmholtz. It must be regarded as indispensable to all future courses of medical study."—*New York Herald.*

"Although this work is written for the instruction of students, it is by no means so technical

and recondite as to be unprofitable or uninteresting to the inquiring general reader."—*New York Observer.*

"In this volume an attempt is made to give a connected account of the general physiology of muscles and nerves, a subject which has never before had so thorough an exposition in any text-book, although it is one which has many points of interest for every cultivated man who seeks to be well informed on all branches of the science of life. This work sets before its readers all, even the most intricate, phases of its subject with such clearness of expression that any educated person though not a specialist can comprehend it."—*New Haven Palladium.*

SAYRE. A Practical Manual on the Treatment of Club-foot.

By LEWIS A. SAYRE, M. D., Professor of Orthopædic Surgery and Clinical Surgery in Bellevue Hospital Medical College; Consulting Surgeon to Bellevue Hospital, Charity Hospital, etc., etc. Fourth edition, enlarged and corrected. 12mo. Illustrated. Cloth, \$1.25.

"A more extensive experience in the treatment of club-foot has proved that the doctrines taught in my first edition were correct, viz., that in all cases of congenital club-foot the treatment should commence at birth, as at that time there is generally no difficulty that can not be overcome by the ordinary family physician; and that, by following the simple rules laid down in this volume, the great majority of cases can be relieved, and many cured, without any operation or surgical interference. If this early treatment has been neglected, and the deformity has been permitted to increase by use of the foot in its abnormal position, surgical aid may be requisite to overcome the difficulty; and I have here endeavored to clearly lay down the rules that should govern the treatment of this class of cases."—*Preface.*

"The book will very well satisfy the wants of the majority of general practitioners, for whose use, as stated, it is intended."—*New York Medical Journal.*

SAYRE. Lectures on Orthopædic Surgery and Diseases of the Joints. By LEWIS A. SAYRE, M. D., Professor of Orthopædic Surgery and Clinical Surgery in Bellevue Hospital Medical College; Consulting Surgeon to Bellevue Hospital, Charity Hospital, etc., etc. Second edition, revised and greatly enlarged. 324 Illustrations. 8vo. 569 pages. Cloth, \$5.00; sheep, \$6.00.

This edition has been thoroughly revised and rearranged, and the subjects classified in the anatomical and pathological order of their development. Many of the chapters have been entirely rewritten, and several new ones added, and the whole work brought up to the present time, with all the new improvements that have been developed in this department of surgery. Many new engravings have been added, each illustrating some special point in practice.

SPECIMENS OF ILLUSTRATIONS.

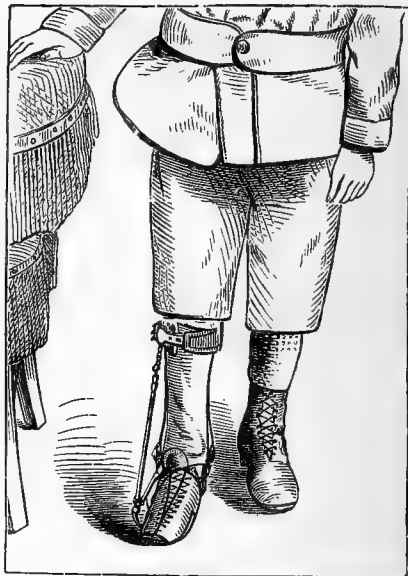

"The name of the author is a sufficient guarantee of its excellence, as no man in America or elsewhere has devoted such unremitting attention for the past thirty years to this department of surgery, or given to the profession so many new truths and laws as applying to the pathology and treatment of deformities."—*Western Lancet*.

"The name of Lewis A. Sayre is so intimately connected and identified with orthopædics in all its branches, that a book relating his experience can not but form an epoch in medical science, and prove a blessing to the profession and humanity. Dr. Sayre's views on many points differ from those entertained by other surgeons, but the great successes he has obtained fully warrant him in maintaining the 'courage of his opinions.'"—*American Journal of Obstetrics*.

"Dr. Sayre has stamped his individuality on every part of his book. Possessed of a taste for mechanics, he has admirably utilized it in so modifying the inventions of others as to make them of far greater practical value. The care, patience, and perseverance which he exhibits in fulfilling all the conditions necessary for success in the treatment of this troublesome class of cases are worthy of all praise and imitation."—*Detroit Review of Medicine*.

"Its teaching is sound, and the originality throughout very pleasing; in a word, no man should attempt the treatment of deformities of joint affections without being familiar with the views contained in these lectures."—*Canada Medical and Surgical Journal*.

"... Taken as a whole, the book will prove a valuable addition to the library of the general practitioner, as well as the orthopædist, both as a work of reference and as a guide to the principles and practice pertaining to this much-neglected branch of surgery, and it should meet with the general commendation it deserves."—*Medical Record*.

"... It is a book of expedients rather than of dry pathological details, although this foundation of treatment is by no means neglected. On turning over its pages, there will be found those practical applications of the healing art which are acquired by extended experience, and which prove of inestimable value to the general practitioner. . . . Few books have the personality of their authors more forcibly impressed upon them than this one. This fact gives piquancy and interest to the volume, and the reader of it will rise from its perusal with the impression that its author has written of that he has had experience in, and that

the extent of Dr. Sayre's experience gives weight to his opinions. . . . Every surgeon who has to do with the subjects of which it treats will do wisely to have this volume within easy reach upon his shelves."—*American Journal of the Medical Sciences*.

" . . . There is no higher authority on deformities and chronic diseases of joints than Dr. Sayre among living surgeons. His words contain the results of almost unequalled observations, and we doubt not this treatise will be received as the

most complete expression of our knowledge of this branch of science for a long time to come."—*Medical and Surgical Reporter*.

" . . . The edition of 1883 will be the one for present consultations on all subjects relating to orthopædics. . . . He who does not now recognize Dr. Sayre as the author of the age, on most all orthopædic questions, almost thereby confesses himself ignorant of what has been accomplished in this special line of practice."—*Virginia Medical Monthly*.

SCHROEDER. A Manual of Midwifery. Including the Pathology of Pregnancy and the Puerperal State. By Dr. CARL SCHROEDER, Professor of Midwifery and Director of the Lying-in Institution in the University of Erlangen. Translated from the third German edition by CHARLES H. CARTER, B. A., M. D., B. S., London, Member of the Royal College of Physicians, London. With 26 Engravings on Wood. 8vo. 388 pages. Cloth, \$3.50; sheep, \$4.50.

"The translator feels that no apology is needed in offering to the profession a translation of Schroeder's 'Manual of Midwifery.' The work is well known in Germany, and extensively used as a text-book; it has already reached a third edition within the short space of two years, and it is hoped that the present translation will meet the want, long felt in this country, of a manual of midwifery embracing the latest scientific researches on the subject."

SCHULTZE. The Pathology and Treatment of Displacements of the Uterus. By Dr. B. S. SCHULTZE, Professor of Gynæcology, Director of the Lying-in Institution, and of the Gynæcological Clinic, in Jena. Translated from the German by JAMESON J. MACAN, M. A., M. R. C. S. Eng., etc.; and edited by ARTHUR V. MACAN, M. B., M. Ch., etc., Master of the Rotunda Hospital, Dublin. With 120 Illustrations. 8vo. 378 pages. Cloth, \$3.50.

"American gynæcologists will heartily welcome this translation of Professor Schultze's work on uterine displacements into the English language. The translation has been very well done, and the ideas of the author turned into good, easy English. The notes by the editor are valuable and well-timed. . . . It's a book that will richly repay a careful study."—*Peoria Medical Monthly*.

"The author of this work, it is very evident, has bestowed upon it a vast amount of research. He therefore gives his readers the benefit not only of his own rich, individual experience, but also presents them with the best thoughts of other ex-

perts in this branch of medicine, culled from an enormous quantity of modern literature. The book contains much original matter. . . . The work partakes of a scientific character throughout, and will doubtless be well received by the profession."—*Pacific Medical Journal*.

" . . . In the interests of gynæcology we trust that this work may have a large circulation."—*American Lancet*.

"The work, as a whole, is the most elaborate of any extant upon the subject, and worthy a place in our library."—*New York Medical Times*.

SHEARS. The New York Medical Journal Visiting-List and Complete Pocket Account-Book. Prepared by CHARLES H. SHEARS, A. M., M. D. Price, \$1.25.

This List is based upon an entirely new plan, the result of an effort to do away with the defective method of keeping accounts found in all visiting-lists hitherto published. Each page is arranged for the accounts of three patients, to the number of thirty-one visits each, which may have been made during a current month or may extend over a number of months, according to the frequency of the visits. With the simple system here inaugurated, the practitioner can at a glance, and without the trouble of tracing the narrow columns found in the ordinary lists, ascertain the condition of the account of any patient; when, and how many visits have been made; what has been paid, and how much is still due. It is provided with an Index, and is, without doubt, the most perfect Visiting-List ever offered to the profession, as it possesses all the advantages without the objectionable features found in all others. ITS USE CAN BE BEGUN AT ANY TIME.

SHOEMAKER. A Text-Book of Diseases of the Skin. By JOHN V. SHOEMAKER, A. M., M. D., Professor of Dermatology in the Medico-Chirurgical College of Philadelphia. 8vo. With Six Chromo-Lithographs and numerous Engravings. Cloth, \$5.00; sheep, \$6.00.

SPECIMENS OF ILLUSTRATIONS.



"... It is a treatise on the skin which we can recommend to every physician as a work of reference, and in which he will find the latest views on pathology and treatment. At the end of the work are a number of formulæ, which will prove very valuable as a reference. It is certainly a very complete book."—*Canada Lancet*.

"This is an entirely new work upon diseases of the skin, by one who evidently has had very large observation and experience in those affections. . . . Students and physicians will find it well adapted to their wants. A proper study of it will give them a very satisfactory knowledge of skin affections."—*Cincinnati Medical News*.

"... Dr. Shoemaker's excellent work will be especially acceptable to the profession as being free from cumbrous technicality, and as having been prepared to interest and instruct the practitioner, and not to embarrass him with burdensome details that might make the study and the subject a tax rather than a pleasure."—*College and Clinical Record*.

"This treatise, by a well-known writer and authority upon diseases of the skin, will doubtless receive a warm welcome from the profession. It is everything a text-book should be, concise, clear, exhaustive, and well illustrated. We unhesitatingly recommend it to all physicians and students."—*Nashville Journal of Medicine*.

"Every practitioner has frequent need for a concise, practical, and reliable guide in the diagnosis and treatment of skin diseases—a book free from the cumbrous technicalities which oftener mislead than instruct. Such is the work before us, and we think our readers will thank us for

advising them to buy it, if they desire a good authority on diseases of the skin."—*Practice*.

"Of the many works issued in the past few years on dermatology, Dr. Shoemaker's book bids fair to rival its predecessors in this particular branch of medical science. Every part is quite up to the requirements of a modern book of reference, and the whole is agreeably stamped with the individuality of the author, showing clearly that it is not a mere compilation but is the product of an original investigator and an experienced observer. The excellent work of Appleton & Co. is apparent in the binding and typographical part."—*Western Medical Reporter*.

"No physician in this country is better fitted, by personal experience, to give the profession a text-book on skin diseases than Dr. Shoemaker. The work before us is one of great merit, and is a complete treatise on the whole subject. It has a number of beautifully colored plates illustrating the text. No class of diseases is so troublesome as that of the skin, and this valuable book will be welcomed by the profession."—*Southern Clinic*.

"A very careful examination leads to the conclusion that Shoemaker's 'Diseases of the Skin' is destined to become the leading work of its kind in America."—*Kansas City Medical Index*.

"For the general practitioner, this is the text-book he should adopt for practical purposes. Descriptions are good; diagnostic points between diseases bearing a similar phase are clearly made; the drawings well delineate the distinctive features of special diseases; and, above all, the therapeutics suited to given cases are well indicated."—*Virginia Medical Monthly*.

"We shall not be accused of over-patriotic zeal if we recommend Dr. Shoemaker's book as the preferable one for American physicians and students. His style is simplicity itself, and therein has he scored his greatest success over other authors we might name."—*Medical Record*.



SIMPSON. **The Posthumous Works of Sir James Young Simpson, Bart., M.D.** In Three Volumes. Vol. I.—SELECTED OBSTETRICAL AND GYNÆCOLOGICAL WORKS OF SIR JAMES Y. SIMPSON. Edited by J. WATT BLACK, M.D. 8vo. 852 pages. Cloth, \$3.00; sheep, \$4.00.

This first volume contains many of the papers reprinted from his Obstetric Memoirs and Contributions, and also his Lecture Notes, now published for the first time, containing the substance of the practical part of his course of midwifery. It is a volume of great interest to the profession, and a fitting memorial of its renowned and talented author.

Vol. II.—ANÆSTHESIA, HOSPITALISM, ETC. Edited by Sir WALTER SIMPSON, Bart. 8vo. 560 pages. Cloth, \$3.00; sheep, \$4.00.

"We say of this, as of the first volume, that it should find a place on the table of every practitioner; for, although it is patchwork, each piece may be picked out and studied with pleasure and profit."—*The Lancet (London)*.

Vol. III.—DISEASES OF WOMEN. Edited by ALEXANDER SIMPSON, M.D. 8vo. 789 pages. Cloth, \$3.00; sheep, \$4.00.

One of the best works on the subject extant. Of inestimable value to every physician.

SKENE. **Treatise on the Diseases of Women.** For the Use of Students and Practitioners. By ALEXANDER J. C. SKENE, M.D., Professor of Gynæcology in the Long Island College Hospital, Brooklyn, N. Y.; formerly Professor of Gynæcology in the New York Post-graduate Medical School and Hospital, etc. 8vo. 966 pages. Illustrated with 251 Fine Engravings and Nine Chromo-lithographs. Cloth, \$6.00; sheep, \$7.00. Sold by subscription only.

"If asked to select a guide for the practitioner in his daily work, we would unhesitatingly name Dr. Skene's book. Its strong points are its conservatism and its minute consideration of the *non-operative* measures at our disposal. The author never advises a method of treatment merely because it has the sanction of a great name; he carefully tries the proposed remedy and decides solely according to the results. The illustrations are good, many of them excelling those found in any other text-book. The histories of cases appended to each subject are an invaluable aid. To master these portions of the work alone would give the reader a very fair knowledge of the whole subject."—*Southern California Practitioner*.

"We commend this volume to all students and others whose knowledge of gynæcology is either confused or rusty. It will be found useful as a final reference before examinations. The author deserves great credit for the amount of patient labor he has expended in making the work so comprehensive and clear."—*University Medical Magazine*.

"To Professor Skene undoubtedly belongs the credit of having written the book of the year; nothing that has appeared during the season can be compared with it. There has long been a need for a text-book that should comprehend all the recent advances in gynæcology, yet not be so 'long-drawn-out' as to be tedious. Professor Skene has given this—writing in an attractive style, yet in terms so plain as to be unmistakable; the work bears upon the face of it the fact that it is the outgrowth of the experience of the author in a long and active professional life, devoted almost exclusively to the treatment of diseases of

SPECIMEN OF ILLUSTRATION.

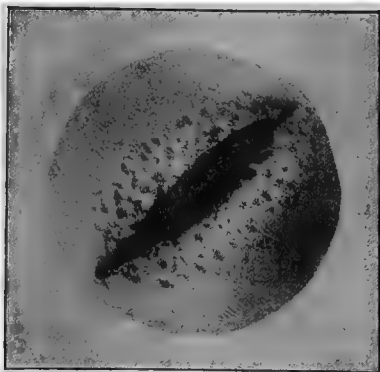

women. It seems to be written, however, not from the standpoint of a 'specialist,' but from that of the general practitioner who sees there is a woman beyond the uterus—whose professional eye is not confined to what can be seen through a speculum. Again, the author has not given way to the surgical furor that now agitates the (medical) world, but, while giving due attention to the surgical procedures, at the same time has kept constantly in mind the medical treatment of all diseases liable to yield to medication alone. But, better than all, he has manifested no tendency to 'ride a hobby,' as has been the case with all his

SPECIMEN OF ILLUSTRATION.

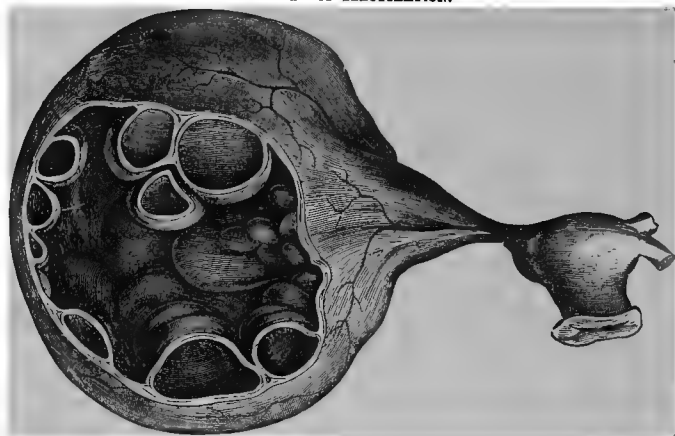

predecessors in this department of medical literature; all diseases are considered briefly or extensively in accordance with their degree of importance, and many subjects not hitherto specially mentioned are given the prominence they deserve. This is especially the case with diseases of the bladder and urethra—a class little understood by the average physician, yet of prime importance; so, too, of the abuse of pessaries, gynecology as related to insanity, and, best of all, the use of electricity in the treatment of uterine tumors.”—*Kansas City Medical Index.*

“We regard the book as one of the best extant on gynecology, and especially so for the student and general practitioner; and we think that but few specialists can read it without profit as well as pleasure. The illustrations are of more than usual excellence, and many of them are original. The printing also is good, but the paper is rather poor.”—*Medical and Surgical Reporter.*

“The name of Skene will cause the reader to open this volume with an eager interest that will be amply justified. In the plan adopted in this book, the diseases of women are divided into three classes, viz.: Those which occur between birth and puberty, those between puberty and the menopause, and those which come after the menopause. Each subject being briefly described with history of cases, typical and complicated, which are given as illustrative of the disease or injury under consideration, with the author’s method of treatment. In carrying out this plan, the history of gynecology and the discussion of all disputed questions have been omitted as being at variance with scope adopted. Taken altogether, we find that it is one of the very best books extant on the subject of gynecology, and we can not too warmly commend it to the readers of the *New England Monthly.*”

SMITH. *Health: A Hand-Book for Households and Schools.*

By EDWARD SMITH, M. D., F. R. S., Fellow of the Royal College of Physicians and Surgeons of England, etc. 12mo. Illustrated. 198 pages. Cloth, \$1 00.

It is intended to inform the mind on the subjects involved in the word Health to show how health may be retained and ill-health avoided, and to add to the pleasure and usefulness of life.

“The author of this manual has rendered a real service to families and teachers. It is not a mere treatise on health, such as would be written by a medical professor for medical students. Nor is it a treatise on the treatment of disease, but a plain, common-sense essay on the prevention of most of the ills that flesh is heir to. There is no doubt that much of the sickness with which humanity is afflicted is the result of igno-

rance, and proceeds from the use of improper food, from defective drainage, overcrowded rooms, ill-ventilated workshops, impure water, and other like preventable causes. Legislation and municipal regulations may do something in the line of prevention, but the people themselves can do a great deal more—particularly if properly enlightened; and this is the purpose of the book.”—*Albany Journal.*

SMITH. *On Foods.* By EDWARD SMITH, M. D., LL. B., F. R. S. Fellow of the Royal College of Physicians of London, etc., etc. 12mo. 485 pages. Cloth, \$1.75.

“Since the issue of the author’s work on ‘Practical Dietary,’ he has felt the want of another, which would embrace all the generally known and some less known foods, and contain the latest sci-

tific knowledge respecting them. The present volume is intended to meet this want, and will be found useful for reference, to both scientific and general readers. The author extends the ordinary

view of foods, and includes water and air, since they are important both in their food and sanitary aspects. The book contains a series of diagrams, displaying the effects of sleep and meals on pulsation and respiration, and of various kinds of food on respiration, which, as the results of Dr. Smith's

own experiments, possess a very high value. We have not far to go in this work for occasions of favorable criticism; they occur throughout, but are perhaps most apparent in those parts of the subject with which Dr. Smith's name is especially linked."—*London Examiner*.

SMITH. Diseases of Memory: An Essay in the Positive Psychology. By TH. RIBOT, Author of "Heredity," etc. Translated from the French by WILLIAM HUNTINGTON SMITH. 12mo. Cloth, \$1.50.

"Not merely to scientific, but to all thinking men, this volume will prove intensely interesting."—*New York Observer*.

"M. Ribot has bestowed the most painstaking attention upon his theme, and numerous examples of the conditions considered greatly increase the value and interest of the volume."—*Philadelphia North American*.

"'Memory,' says M. Ribot, 'is a general function of the nervous system. It is based upon the faculty possessed by the nervous elements of conserving a received modification, and of forming associations.' And again: 'Memory is a biological fact. A rich and extensive memory is not a collection of impressions, but an accumulation of dynam-

ic associations, very stable and very responsive to proper stimuli. . . . The brain is like a laboratory full of movement where thousands of operations are going on all at once. Unconscious cerebration, not being subject to restrictions of time, operating, so to speak, only in space, may act in several directions at the same moment. Consciousness is the narrow gate through which a very small part of all this work is able to reach us.' M. Ribot thus reduces diseases of memory to law, and his treatise is of extraordinary interest."—*Philadelphia Press*.

"It is not too much to say that in no single work have so many curious cases been brought together and interpreted in a scientific manner."—*Boston Evening Traveller*.

STEINER. Compendium of Children's Diseases. A Hand-Book for Practitioners and Students. By Dr. JOHANN STEINER, Professor of the Diseases of Children in the University of Prague. Translated from the second German edition by LAWSON TAIT, F. R. C. S., Surgeon to the Birmingham Hospital for Women. 8vo. Cloth, \$3 50; sheep, \$4.50.

"Dr. Steiner's book has met with such marked success in Germany that a second edition has already appeared, a circumstance which has delayed the appearance of its English form, in order that I might be able to give his additions and corrections.

"I have added as an Appendix the 'Rules for Management of Infants,' which have been issued by the staff of the Birmingham Sick Children's Hospital, because I think that they have set an example, by freely distributing these rules among the poor, for which they can not be sufficiently commended, and which it would be wise for other sick children's hospitals to follow.

"I have also added a few notes, chiefly, of course, relating to the surgical ailments of children."—*Extract from Translator's Preface*.

STEVENS. Functional Nervous Diseases: Their Causes and their Treatment. Memoir for the Concourse of 1881-1883, Académie Royale de Médecine de Belgique. With a Supplement, on the Anomalies of Refraction and Accommodation of the Eye, and of the Ocular Muscles. By GEORGE T. STEVENS, M. D., Ph. D., Member of the American Medical Association, of the American Ophthalmological Society, etc.; formerly Professor of Ophthalmology and Physiology in the Albany Medical College. Small 8vo. 217 pages. With Six Photographic Plates and Twelve Illustrations. Cloth, \$2.50.

"A careful study of this work will undoubtedly clear up many hitherto illy understood cases of nervous troubles, and will lead to a more successful treatment of such. . . ."—*Peoria Medical Monthly*.

"... We heartily commend his book to all thoughtful students of nervous diseases, feeling sure that they can not fail of finding in it most valuable suggestions."—*Medical and Surgical Reporter*.

"... It is fortunate for the profession that Dr. Stevens has done his views full justice in a work to which all can have access, for they certainly deserve careful attention."—*Medical Press of Western New York*.

"... The work is eminently suggestive and practical upon numerous points, and must prove interesting and very useful to the student and practitioner."—*Southern Medical Record*.

STONE. Elements of Modern Medicine, including Principles of Pathology and Therapeutics, with many Useful Memoranda and Valuable Tables of Reference. Accompanied by Pocket Fever Charts. Designed for the Use of Students and Practitioners of Medicine. By R. FRENCH STONE, M. D., Professor of Materia Medica and Therapeutics and Clinical Medicine in the Central College of Physicians and Surgeons, Indianapolis; Physician to the Indiana Institute for the Blind; Consulting Physician to the Indianapolis City Hospital, etc., etc. In wallet-book form, with pockets on each cover for Memoranda, Temperature Charts, etc. \$2.50.

"This is an abridged work in pocket-book form, presenting the more advanced views of leading authorities, with reference to general pathology and therapeutics. Under general pathology are included articles on the origin, nature, and duration of disease, chief symptoms, diagnosis, prognosis, and treatment. In the second part will be found what is regarded by the author as an improved classification of drugs, followed by articles on their physiological action, indications, and methods of use. The work contains a fund of useful information culled from the best authorities in the Old and New World."—*Canada Lancet*.

"This is a neatly printed pocket manual of medical practice. It is a well-condensed compilation of the kind, containing a short sketch of nearly everything that is met with in practice. The fever charts are well arranged, and there is a convenient therapeutic table which will be found valuable. It will probably be more suitable for young practitioners, on account of its containing many practical points that are not to be found elsewhere in such a condensed manner. It will be found a valuable aid to those just commencing practice."—*Medical Herald*.

STRECKER. Adolph Strecker's Short Text-Book of Organic Chemistry. By Dr. JOHANNES WISLICENUS. Translated and edited, with Extensive Additions, by W. H. HODGKINSON, Ph. D., and A. J. GREENAWAY, F. I. C. 8vo. 789 pages. Cloth, \$5.00.

The great popularity which Prof. Wislicenus's edition of "Strecker's Text-Book of Organic Chemistry" has enjoyed in Germany has led to the belief that an English translation will be acceptable. Since the publication of the book in Germany, the knowledge of organic chemistry has increased, and this has necessitated many additions and alterations on the part of the translators.

SPECIMEN OF ILLUSTRATION.



"Let no one suppose that in this 'short text-book' we have to deal with a primer. Everything is comparative, and the term 'short' here has relation to the enormous development and extent of recent organic chemistry. This solid and comprehensive volume is intended to represent the present condition of the science in its main facts and leading principles, as demanded by the systematic chemical student. We have here, probably, the best extant text-book of organic chemistry. Not only is it full and comprehensive and remarkably clear and methodical, but it is up to the very latest moment, and it has been, moreover, prepared in a way to secure the greatest excellences in such a treatise."—*The Popular Science Monthly*.

STRÜMPPELL. A Text-Book of Medicine. For Students and Practitioners. By ADOLPH STRÜMPPELL, formerly Professor and Director of the Medical Polyclinic at the University of Leipsic. Translated, by permission, from the second and third German editions by HERMAN F. VICKERY, A. B., M. D., Assistant in Clinical Medicine, Harvard Medical School, etc., and PHILIP COOMBS KNAPP, Physician to Out-patients with Diseases of the Nervous System, Boston City Hospital, etc. With Editorial Notes by FREDERICK C. SHATTUCK, A. M., M. D., Instructor in the Theory and Practice of Physic, Harvard Medical School, etc. With 111 Illustrations. 8vo. 981 pages. Cloth, \$6.00; sheep, \$7.00.

"The above work, which is new to most of our readers, has achieved great success in Germany, having reached the third edition in a very short time. It has been introduced as the text-book on medicine in the Harvard Medical School. The work is especially commendable in its treatment of nervous diseases, which are dealt with fully, concisely, and clearly. The pathology of disease, as might be expected from so eminent a teacher, has received due and careful attention, and this is another strong feature of the work. The author gives in this work the results of the experience and observation of more than six years' active work in the medical clinic in Leipsic. We heartily commend the work to the attention of our readers."

—*Canada Lancet.*

"In spite of the fact that within the last year or two so many excellent works on general medicine have appeared, we think there will be found a place for the volume before us. The best part of the book is the section devoted to nervous diseases. The various affections of the nervous system are discussed in a very concise way, together with the most recent discoveries in neuro-pathology. The translators have done their work well, and the editor has made a number of important additions. Altogether the book is a very valuable contribution and compilation, and will be useful both to teacher and practitioner."—*Maryland Medical Journal.*

"The work before us is one that is peculiarly attractive to the student of medicine, not only on account of the well-delineated German plans of treatment, but especially for the clear and accurate pathology given by the author in almost all diseases. Dr. Shattuck states that he is acquainted with no work which treats of the diseases of the nervous system, in which our knowledge has advanced so rapidly of late years, so fully, concisely, and clearly. The style is clear for a German work, which as a rule do not make models in this particular. The translators have overcome the difficulties of the original so successfully that they have made it a decidedly agreeable text-book. The book is extremely popular in Germany, having reached the third edition in a comparatively short time, and we do not doubt but that its popularity in America will soon be assured."—*Mississippi Valley Medical Monthly.*

"I like it so well that I have commended it to my class and have called special attention to its three hundred pages devoted to the nervous system, bringing to date all the knowledge which the last ten years, more than many centuries past, have brought to the use of the profession."—H. D. DIDAMA, M. D., *Professor of the Principles and Practice of Medicine and Clinical Medicine, College of Medicine, Syracuse University.*

"I consider it the best text-book of medicine with which I am acquainted. The part on nervous

SPECIMEN OF ILLUSTRATION.



diseases is so excellent that I shall recommend the whole book to my class as a text-book on diseases of the nervous system."—HENRY HUN, M. D., LL. D., *Dean of the Faculty and Emeritus Professor of the Institutes of Medicine, Albany Medical College.*

"Of the German text-books of practice that have been translated into English, Prof. Strümpell's will probably take the highest rank. Between its covers will be found a very complete and systematic description of all the diseases which are classed under the head of internal medicine. Unlike most of the larger works on practice, we do not find the preliminary discourse on general pathological subjects, an omission which is very much to be commended, because there are at the present day so many special treatises upon pathological subjects that there is no longer a necessity for such a section in a work of this kind. While it is impossible to refer to all these particularly, we may call attention to the chapter on Typhoid Fever as being especially valuable, not only on account of the advanced views in regard to the pathology of that disease, but also because of the careful description of its clinical history and of its treatment. Taken altogether, it is one of the most valuable works on practice that we have, and one which every studious practitioner should have upon his shelves."—*New York Medical Journal.*

SWANZY. A Hand-Book of the Diseases of the Eye, and their Treatment. By HENRY R. SWANZY, A. M., M. B., F. R. C. S. I., Surgeon to the National Eye and Ear Infirmary; Ophthalmic Surgeon to the Adelaide Hospital, Dublin. Crown 8vo. 437 pages. With 122 Illustrations, and Holmgren's Tests for Color-Blindness. Cloth, \$3.00.

"Though, amid the numerous recent textbooks on eye-diseases, there would appear to be little room or necessity for another, we must admit that this one justifies its presence, by its admirable type, illustrations, and dress, by its clear wording, and, above all, by the vast amount of varied matter which it embraces within the relatively small compass of some four hundred pages. The author has omitted—and, in our opinion, with perfect wisdom—the usual collection of indifferent, second-hand ophthalmoscopic plates. So, also, he has not included test-types, though he has appended, for explanatory purposes, the fan which is often used in astigmatism. Admirable samples of the colored wools, used in Holmgren's tests, are sewn into the cover, and, by aid of these, it will be perfectly within

the power of any one, wherever residing, to make a proper collection of colored wools and tests for the qualitative estimation of congenital color-defects. We have criticised the book at length, and drawn attention freely to points on which the author's opinion is at variance with the commonly received teaching. This we have done because there is much individuality in the work, which bears every mark of having been well thought out and independently written. In these respects it presents a marked superiority over the ordinary run of medical hand-books; and we have no hesitation in recommending it to students and young practitioners as one of the very best, if not actually the best, work to procure on the subject of ophthalmology."—*British Medical Journal*.

TRACY. Hand-Book of Sanitary Information for Household-ers. Containing Facts and Suggestions about Ventilation, Drainage, Care of Contagious Diseases, Disinfection, Food, and Water. With Appendices on Disinfectants and Plumbers' Materials. By ROGER S. TRACY, M. D., Sanitary Inspector of the New York City Health Department. 16mo. Cloth, 50 cents.

"This volume of about one hundred pages embodies a great deal of useful information upon the subjects of air, ventilation, drainage, plumbing, disinfection, treatment of contagious diseases, and

other matters relating to the personal comfort and welfare of humanity. . . . The language is clear, plain, and concise, and the work will undoubtedly find a large sale. . . ."—*Architect and Builder*.

TRACY. The Essentials of Anatomy, Physiology, and Hygiene. By ROGER S. TRACY, M. D., Sanitary Inspector of the New York City Health Department. 12mo. Cloth, \$1.25.

This work has been prepared in response to the demand for a thoroughly scientific and yet practical text-book for schools and academies, which shall afford an accurate knowledge of the essential facts of Anatomy and Physiology, as furnishing a scientific basis for the study of Hygiene and the Laws of Health. It also treats, in a rational manner, of the physiological effects of alcohol and other narcotics, fulfilling all the requirements of recent legislative enactments upon this subject.

"It is one of the best of the kind that I have ever seen. One of the most important features about the book is the clear and concise manner in which it is written—a thing much to be desired in

a work of the kind. The illustrations are excellent, and show that Dr. Tracy gave thorough consideration to his subject."—M. F. COOMES, M. D., *Professor of Physiology, Kentucky School of Med.*

TUSON. Cyclopædia of Practical Receipts, and Collateral Information in the Arts, Manufactures, Professions, and Trades, including Medicine, Pharmacy, and Domestic Economy. Designed as a Comprehensive Supplement to the Pharmacopœia, and General Book of Reference for the Manufacturer, Tradesman, Amateur, and Heads of Families. Sixth edition, revised and partly rewritten by RICHARD V. TUSON, Professor of Chemistry and Toxicology in the Royal Veterinary College. Complete in Two Volumes. 1,796 pages. With Illustrations. Cloth, \$9.00.

Cooley's "Cyclopædia of Practical Receipts" has for many years enjoyed an extended reputation for its accuracy and comprehensiveness. The sixth edition, now just completed, is larger than the last by some six hundred pages. Much greater space than hitherto is devoted to Hygiene (including sanita-

tion, the composition and adulteration of foods), as well as to the Arts, Pharmacy, Manufacturing Chemistry, and other subjects of importance to those for whom the work is intended. The articles on what is commonly termed "Household Medicine" have been amplified and numerically increased.

The design of this work is briefly but not completely expressed in its title-page. Independently of a reliable and comprehensive collection of formulae and processes in nearly all the industrial and useful arts, it contains a description of the leading properties and applications of the substances referred to, together with ample directions, hints, data, and allied information, calculated to facilitate the development of the practical value of the book in the shop, the laboratory, the factory, and the household. Notices of the substances embraced in the *Materia Medica*, in addition to the whole of their preparations, and numerous other animal and vegetable substances employed in medicine, as well as most of those used for food, clothing, and fuel, with their economic applications, have been included in the work. The synonyms and references are other additions which will prove invaluable to the reader. Lastly, there have been appended to all the principal articles referred to brief but clear directions for determining their purity and commercial value, and for detecting their presence and proportions in compounds. The indiscriminate adoption of matter, without examination, has been uniformly avoided, and in no instance has any formula or process been admitted into this work, unless it rested on some well-known fact of science, had been sanctioned by usage, or come recommended by some respectable authority.

TYNDALL. Essays on the Floating Matter of the Air, in Relation to Putrefaction and Infection. By Prof. JOHN TYNDALL, F.R.S.
12mo. Cloth, \$1.50.

CONTENTS.—I. On Dust and Disease; II. Optical Department of the Atmosphere in Relation to Putrefaction and Infection; III. Further Researches on the Department and Vitality of Putrefactive Organisms; IV. Fermentation, and its Bearings on Surgery and Medicine; V. Spontaneous Generation; Appendix.

"Prof. Tyndall's book is a calm, patient, clear, and thorough treatment of all the questions and conditions of nature and society involved in this theme. The work is lucid and convincing, yet not prolix or pedantic, but popular and really enjoyable. It is worthy of patient and renewed study."
—*Philadelphia Times*.

"The matter contained in this work is not only presented in a very interesting way, but is of great value."
—*Boston Journal of Commerce*.

"The germ theory of disease is most intelligently presented, and indeed the whole work is instinct with a high intellect."
—*Boston Commonwealth*.

"In the book before us we have the minute details of hundreds of observations on infusions exposed to optically pure air; infusions of mutton, beef, haddock, hay, turnip, liver, hare, rabbit, grouse, pheasant, salmon, cod, etc.; infusions heated by boiling water and by boiling oil, sometimes for a few moments and sometimes for several hours, and, however varied the mode of procedure, the result was invariably the same, with not even a shade of uncertainty. The fallacy of spontaneous generation and the probability of the germ theory of disease seem to us the inference, and the only inference, that can be drawn from the results of nearly ten thousand experiments performed by Prof. Tyndall within the last two years."
—*Pittsburgh Telegraph*.

ULTZMANN. Pyuria; or, Pus in the Urine, and its Treatment: Comprising the Diagnosis and Treatment of Acute and Chronic Urethritis, Prostatitis, Cystitis, and Pyelitis, with especial reference to their Local Treatment. By Dr. ROBERT ULZMANN, Professor of Genito-Urinary Diseases in the Vienna Poliklinik. Translated, by permission, by Dr. WALTER B. PLATT, F.R.C.S. (Eng.), Baltimore. 12mo. Cloth, \$1.00.

"Those of the profession who are familiar with the works of Prof. Ultzmann will welcome this translation as constituting a real addition to our literature on genito-urinary diseases. It can not be too highly recommended to the attention of the profession, not only on account of its scientific value, but also for the many practical suggestions regarding treatment to be found in the chapter on Therapeutics. The translator is to be congratulated upon the excellent manner in which his work has been accomplished. The book is neatly and tastefully got up by the publishers."
—*Maryland Medical Journal*.

"This excellent monograph contains, in less than one hundred pages, a complete review of the conditions that give rise to pus within the urinary

tracts. Acute and chronic urethritis, prostatitis, cystitis, and pyelitis are discussed in turn, with especial reference to their differential diagnosis and treatment. As a result of observation and experience, the author states that while acute urethritis can only be cured by the direct application of remedies to the diseased part, other forms of acute pyuria, and above all that of the bladder and neck of the bladder, ought never to be treated locally, but by internal medication and regulation of diet; while in chronic pyuria of any part of the urinary tract an appropriate local treatment takes a prominent place. The remedies and methods of treatment that have been used with most success by the author are considered in detail in the chapter on the Therapeutics of Polyuria."
—*Medical Bulletin*.

VAN BUREN. Lectures on the Principles of Surgery. Delivered at the Bellevue Hospital Medical College. By the late W. H. VAN BUREN, M. D., LL. D. Edited by Dr. LEWIS A. STIMSON. 8vo. 588 pages. Cloth, \$4.00; sheep, \$5.00.

"If we are to judge of the interesting style by the mere reading of these lectures, how greatly they must have been appreciated by those who heard them by the teacher! There is nothing dry or prosy in them. The illustrations of principles are drawn from the clinical material of the teacher, and are always fresh and *à propos*. Past and present theories are compared in such a way as to give the student an interest in the work of older pathologists, and to point out progress made, without wearying him with a dry narration at a time when he is not able to comprehend the underlying philosophy. Dr. Van Buren's popularity as a teacher can be easily understood from a study of this volume. His manner is vivacious, his matter select, and his fullness of knowledge easily discernible. He writes like one in authority, full of enthusiasm, and possessed of the skill of imparting to students just that sort of knowledge best suited to their future intellectual growth. The work is handsomely printed, with full-faced, clear type and leaded lines, and is in every way a credit to the publishers."—*North Carolina Med. Journal*.

"Dr. Van Buren, for a period of thirty-five years prior to his death, occupied a phenomenal

position as a teacher of surgery. Dr. Lewis A. Stimson has conferred a lasting benefit upon the profession by the conscientious discharge of his duty as editor of the late Prof. Van Buren's lecture notes. As a tribute to the memory of a great American surgeon, and as an invaluable contribution to the literature of the subject, Van Buren's 'Lectures on the Principles of Surgery' will find an honored place in every well-selected medical library."—*Chicago Medical Journal and Examiner*.

"This book is the teaching of an experienced surgeon, of one who knew of what he was saying, and from personal observation. It is such a work on surgery that the general practitioner should consult and be governed by, as from it he can be advised how to treat and manage the complications of surgery. Known so well as is Dr. Van Buren, we can neither add to nor detract from what he has given in this work before us. It has been ably edited by Dr. Stimson, and we advise our readers to have a copy of it in their libraries."—*Therapeutic Gazette*.

VAN BUREN. Lectures upon Diseases of the Rectum and the Surgery of the Lower Bowel. Delivered at the Bellevue Hospital Medical College. By W. H. VAN BUREN, M. D., late Professor of the Principles and Practice of Surgery in the Bellevue Hospital Medical College, etc., etc. Second edition, revised and enlarged. 8vo. 412 pages. With 27 Illustrations and complete Index. Cloth, \$3.00; sheep, \$4.00.

SPECIMEN OF ILLUSTRATION.

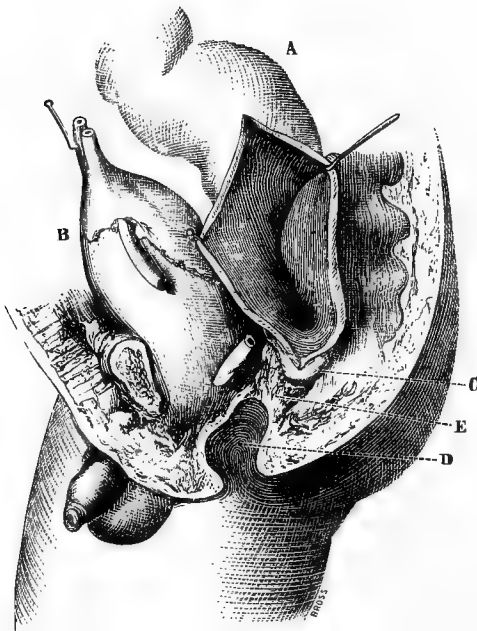

"The reviewer too often finds it a difficult task to discover points to praise, in order that his criticisms may not seem one-sided and unjust. These lectures, however, place him upon the other horn of the dilemma, viz., to find somewhat to criticize severely enough to clear himself of the charge of indiscriminating laudation. Of course, the author upholds some views which conflict with other authorities, but he substantiates them by the most powerful of arguments, viz., a large experience, the results of which are enunciated by one who elsewhere shows that he can appreciate, and accord the due value to, the work and experience of others."—*Archives of Medicine*.

"The present is a new volume rather than a new edition. Both its size and material are vastly beyond its predecessor. The same scholarly method, the same calm, convincing statement, the same wise, carefully matured counsel, pervade every paragraph. The discomfort and dangers of the diseases of the rectum call for greater consideration than they usually receive at the hands of the profession."—*Detroit Lancet*.

"These lectures are twelve in number, and may be taken as an excellent epitome of our present knowledge of the diseases of the parts in question. The work is full of practical matter, but it owes not a little of its value to the original thought, labor, and

suggestions as to the treatment of disease, which always characterize the productions of the pen of Dr. Van Buren."—*Philadelphia Medical Times*.

"The most attractive feature of the work is the plain, common-sense manner in which each subject is treated. The author has laid down instructions for the treatment, medicinal and operative, of rectal diseases in so clear and lucid style as that any practitioner is enabled to follow it. The large and successful experience of the distinguished author in this class of diseases is sufficient of itself to warrant the high character of the book."—*Nashville Journal of Medicine and Surgery*.

"... We have thus briefly tried to give the reader an idea of the scope of this work; and the work is a good one—as good as either Allingham's or Curling's, with which it will inevitably be compared. Indeed, we should have been greatly surprised if any work from the pen of Dr. Van Buren had not been a good one; and we have to thank

him that for the first time we have an American text-book on this subject which equals those that have so long been the standards."—*New York Medical Journal*.

"Mere praise of a book like this would be superfluous—almost impertinent. The author is well known to the profession as one of our most accomplished surgeons and ablest scientific men. Much is expected of him in a book like the one before us, and those who read it will not be disappointed. It will, indeed, be widely read, and in a short time take its place as the standard American authority."—*St. Louis Courier of Medicine*.

"Taken as a whole, the book is one of the most complete and reliable ones extant. It is certainly the best of any similar work from an American author. It is handsomely bound and illustrated, and should be in the hands of every practitioner and student of medicine."—*Louisville Medical Herald*.

VOGEL. A Practical Treatise on the Diseases of Children.

Third American from the eighth German edition. Revised and enlarged. Illustrated by Six Lithographic Plates. By ALFRED VOGEL, M. D., Professor of Clinical Medicine in the University of Dorpat, Russia. Translated and edited by H. RAPHAEL, M. D., late House Surgeon to Bellevue Hospital; Physician to the Eastern Dispensary for the Diseases of Children, etc., etc. 8vo. 640 pages. Cloth, \$4.50; sheep, \$5.50.

"Vogel's Treatise on Diseases of Children" has a world-wide reputation, having appeared in the Russian, German, Dutch, and English languages. This is a deserved success, for it is a book admirably adapted to the wants both of the practitioner and student. The present edition is brought well up to the present state of pathological knowledge; it is complete without prolixity, and the book bears upon its pages the evidence of the work of a skillful and experienced clinical practitioner. . . . We would most heartily commend the book as one of the most valuable upon the subject, and indeed few physicians can afford to forego the advantages to

be derived from the possession of this work."—*Buffalo Medical and Surgical Journal*.

"This is indeed a valuable addition to the literature of Pædiatrics. . . . In this latest edition (3d American) much has been added to the chapters on Artificial Nutrition, a subject of deep interest to the practitioner, on Difficulties of Dentition, and on Nervous Diseases of Children. . . . This alone should be worth the price of the book, as the treatment of diseases of children is too much after the stereotyped fashion of the last century."—*Daniel's Texas Medical Journal*.

VON ZEISSL. Outlines of the Pathology and Treatment of

Syphilis and Allied Venereal Diseases. By HERMANN VON ZEISSL, M. D., late Professor at the Imperial-Royal University of Vienna. Second edition, revised by MAXIMILIAN VON ZEISSL, M. D., Privat-Docent for Diseases of the Skin and Syphilis at the Imperial-Royal University of Vienna. Authorized edition. Translated, with Notes, by H. RAPHAEL, M. D., Attending Physician for Diseases of the Genito-Urinary Organs and Syphilis, Bellevue Hospital Out-patient Department, etc. 8vo. 402 pages. Cloth, \$4.00; sheep, \$5.00.

"We regard the book as an excellent text-book for student or physician, and hope to hear of its adoption as such. In therapeutic detail, the recommendations are all good."—*Virginia Medical Monthly*.

"It is scarcely necessary to refer to the talented author of the above-named work, since his life-long labor as a teacher and writer upon venereal diseases has made him known and quoted wherever these affections exist and are treated."—*Polyclinic*.

"It is a most thorough and practical manual, and translator and publisher both have done well

in their respective capacities in thus issuing it."—*Medical Press of Western New York*.

"The book is a most excellent one in every respect, and the translator has done his work well."—*Columbus Medical Journal*.

"The chapter on Gonorrhœa is masterly and concisely written. . . . A line of treatment prudent, concise, and thorough is advised, and in the choice and uses of the mercurial salts shows good reasoning, clear observation, and a clinically experienced judgment."—*Alabama Medical and Surgical Journal*.

"Medical science suffered a severe loss when, in September, 1884, Hermann von Zeissel died. Happily for us, this master in his chosen specialty had embodied the results of his vast experience in a text-book on syphilis and venereal diseases and published it some years before his death. The book now before us is a second edition of the former book, revised and in large part rewritten by Maximilian von Zeissel, and issued in the origi-

nal some seven months before the father's death. It is a masterly treatise and thoroughly practical. We can commend it to all who are interested in venereal subjects. . . . Dr. Raphael has made a smooth and readable translation, and has added much valuable matter to the book, adapting it to the use of American physicians. The chapter on Galloping Syphilis is entirely by him."—*The New York Medical Journal*.

WAGNER. A Hand-Book of Chemical Technology. By RUDOLPH WAGNER, Ph. D., Professor of Chemical Technology at the University of Würzburg. Translated and edited, from the eighth German edition, with Extensive Additions, by WILLIAM CROOKS, F. R. S. With 336 Illustrations. 8vo. 761 pages. Cloth, \$5.00.

Under the head of Metallurgic Chemistry, the latest methods of preparing iron, cobalt, nickel, copper, copper-salts, lead and tin and their salts, bismuth, zinc, zinc-salts, cadmium, antimony, arsenic, mercury, platinum, silver, gold, manganates, aluminium, and magnesium, are described. The various applications of the voltaic current to electro-metallurgy follow under this division. The preparation of potash and soda salts, the manufacture of sulphuric acid, and the recovery of sulphur from soda waste, of course occupy prominent places in the consideration of chemical manufactures. It is difficult to overestimate the mercantile value of Mond's process, as well as the many new and important applications of bisulphide of carbon. The manufacture of soap will be found to include much detail. The technology of glass, stone-ware, limes, and mortars will present much of interest to the builder and engineer. The technology of vegetable fibers has been considered to include the preparation of flax, hemp, cotton, as well as paper-making; while the application of vegetable products will be found to include sugar-boiling, wine- and beer-brewing, the distillation of spirits, the baking of bread, the preparation of vinegar, the preservation of wood, etc.

Dr. Wagner gives much information in reference to the production of potash from sugar-residues. The use of baryta-salts is also fully described, as well as the preparation of sugar from beet-roots. Tanning, the preservation of meat, milk, etc., and the preparation of phosphorus and animal charcoal, are considered as belonging to the technology of animal products. The preparation of materials for dyeing has necessarily required much space; while the final sections of the book have been devoted to the technology of heating and illumination.

WALTON. The Mineral Springs of the United States and Canada, with Analyses and Notes on the Prominent Spas of Europe and a List of Sea-side Resorts. By GEORGE E. WALTON, M. D., Lecturer on *Materia Medica* in the Miami Medical College, Cincinnati. Second edition, revised and enlarged. 12mo. 414 pages. With Maps. \$2.00.

The author has given the analyses of all the springs in this country, and those of the principal European spas, reduced to a uniform standard of one wine-pint, so that they may readily be compared. He has arranged the springs of America and Europe in seven distinct classes, and described the diseases to which mineral waters are adapted, with references to the class of waters applicable to the treatment; and the peculiar characteristics of each spring as near as known are given—also the location, mode of access, and post-office address of every spring are mentioned. In addition, he has described the various kinds of baths and the appropriate use of them in the treatment of disease.

"Precise and comprehensive, presenting not only reliable analyses of the waters, but their therapeutic value, so that physicians can hereafter advise their use as intelligently and beneficially as they can other valuable alterative agents."—*Sanitarian*.

WEBBER. A Treatise on Nervous Diseases: Their Symptoms and Treatment. A Text-Book for Students and Practitioners. By S. G. WEBBER, M. D., Clinical Instructor in Nervous Diseases, Harvard Medical School; Visiting Physician for Diseases of the Nervous System at the Boston City Hospital, etc. 8vo. 415 pages. 15 Illustrations. Cloth, \$3.00.

"The book before us is especially adapted to the needs of the general practitioner who, though conscious of his inability to discern and trace the nervous element in the cases under his care, realizes very fully that this inability is not consonant with

the best interests of his patient. Dr. Webber has not written for the specialist, but for the student and general practitioner, who will find in his book what they most need for the diagnosis and treatment of the diseases as they present themselves in

general practice. His style is very readable and lucid, and is well adapted to those who have not specially prepared themselves to understand the peculiar language of the more advanced neurologist. He covers very completely the field of nervous affections, and his book will prove a very valuable acquisition to the library of the intelligent physician."—*Medical Age*.

"The beauty and usefulness of the book are much enhanced by the fact that it is not loaded down with references to other authors, but proceeds in an original manner to sum up all that is known to the present day upon the subjects treated. Taking the book as a whole, it is one of

the best we have seen in many a day."—*Texas Courier-Record*.

". . . The man with but a single book on nervous diseases can not do better than to buy it. One feature in it which merits especial praise is the admirable bibliographies prefixed to each chapter."—*Journal of Nervous and Mental Disease*.

". . . We have no hesitation in recommending this admirable little book to students and practitioners alike."—*New York Medical Journal*.

". . . The anatomy and physiology of the brain are treated of in an exceptionally clear and concise manner."—*Denver Medical Times*.

WEEKS. A Text-Book of Nursing. For the Use of Training-Schools, Families, and Private Students. Compiled by CLARA S. WEEKS, Graduate of the New York Hospital Training-School; Superintendent of Training-School for Nurses, Paterson, New Jersey. 12mo. 366 pages. With 13 Illustrations. Questions for Review and Examination, and Vocabulary of Medical Terms. \$1.75.

"This book, in twenty-three chapters, communicates a large quantity of useful information in a form intelligible to the public. It is well written, remarkably correct, sufficiently illustrated, and handsomely printed. The amount of technical skill and knowledge required of nurses at the present day makes the use of some text-book indispensable. To those who need such a work we

can speak approvingly of its design, scope, and execution."—*Philadelphia Medical Times*.

"This is an admirably written book, and is full of those important practical details necessary for the medical and surgical nurse. In fact, it could be read with profit by every medical student and young practitioner."—*Medical Record*.

WELLS. Diseases of the Ovaries: Their Diagnosis and Treatment. By T. SPENCER WELLS, Fellow and Member of Council of the Royal College of Surgeons of England, etc., etc. 8vo. 478 pages. Illustrated. Cloth, \$4.50.

"In 1865 the author issued a volume containing reports of one hundred and fourteen cases of ovariectomy, which was little more than a simple record of facts. The book was soon out of print, and, though repeatedly asked for a new edition, the author was unable to do more than prepare papers for the Royal Medical and Chirurgical Society, as series after series of a hundred cases accumulated. On the completion of five hundred cases, he embodied the results in the present volume, an entirely new work, for the student and practitioner, and trusts it may prove acceptable to them and useful to suffering women.

WYETH. A Text-Book on Surgery: GENERAL, OPERATIVE, AND MECHANICAL. By JOHN A. WYETH, M.D., Professor of General and Genito-Urinary Surgery in the New York Polyclinic; Visiting Surgeon to Mount Sinai Hospital, etc. Sold by Subscription. Cloth, \$7.00; sheep, \$8.00; half morocco, \$8.50.

"Dr. Wyeth has succeeded in compressing into less than eight hundred octavo pages a more or less complete description of almost every surgical disease and condition, including those of the eye and ear. The chapter on the ligature of arteries is undoubtedly the best in the book, the plates being beautifully colored and nearly all original. The subjects of genito-urinary disease and orthopaedic surgery are likewise fully discussed, and show an intimate knowledge thereof on the part of the author. The work throughout is copiously illustrated, and may be relied upon as a fair guide to both the general practitioner and student."—*Canada Medical and Surgical Journal*.

"A modern text-book on surgery, provided it professes to give within a moderate compass a satisfactory account of the general range of sur-

gery, is valuable to the general practitioner in proportion as it makes details plain and clearly presents their underlying principles. Gauging it on this basis, we are convinced that Dr. Wyeth's work will speedily take a prominent place in the esteem of the profession. . . . In particular, we would commend the care that has been bestowed on the important matters of surgical dressings, bandaging, and the like. These details lie at the very foundation of success in surgical practice, and too much attention can scarcely be given to them in a text-book. The appearance of the book is in the highest degree creditable to the publishers; the print is clear, the paper is excellent, and the illustrations, which are numerous and nearly all original, are among the best of their class that we have seen. They include quite a number printed in colors."—*New York Medical Journal*.

SPECIMEN OF ILLUSTRATION.



" . . . The writing of a surgery that shall be new in its matter is simply impossible. But the author has evidently grasped and digested the facts of surgery as known to-day, and, after finding those which best suited his practical work, presented them to his professional fellow-workers. Others would write a different work from the same data, because no two minds run in the same direction. But in this sense this work is original. In this sense it will be found interesting and instructive to all students and professional men. The chapter on the Litigation of Arteries is worth the price of the entire work. The illustrations are superb, showing in color the parts to be met with in the reaching of arteries in every portion of the body. Quite as important and as beautifully illustrated is the chapter on amputations. He who, possessing proper anatomical knowledge, could not by the directions here given perform these amputations, should be convinced that he had missed his calling."—*American Lancet*.

"As a specimen of typographical and book-makers' work it is unexceptionable. It is one of the handsomest works ever published, is profusely and beautifully illustrated, having 771 engravings, of which about fifty are colored, and is printed in large type on heavy paper. Nor, when we have praised the mechanical work of the book, have we given all of its merits. It is undoubtedly a useful and convenient manual of surgery. The author has kept himself thoroughly posted in the present literature of his profession, and has incorporated in his book nearly all of the latest achievements and notions in surgery. We believe the book to be the production of a good and conscientious surgeon, and can safely recommend it to the profession."—*Medical Herald*.

"The perusal of this book by any one interested in surgery can not fail to afford both pleasure and instruction. . . . The illustrations constitute a special feature, for they are used unsparingly throughout the entire work, and are of a very superior order of merit. . . . The book is well written, fully up with

the present status of surgery, is a credit alike to author and publishers, and would be very cheap at double the price charged for it. It affords us pleasure to look over a book which we can thus praise without stint, knowing that we can say nothing in excess of its merits."—*Southern Clinic*.

" . . . Its readers will have nothing derived from its study to unlearn. Its teachings are the accepted ones of to-day, while within its nearly 800 pages we have found but very few superfluous sentences. . . . In conclusion, we may say that the book is characterized throughout by good, practical common-sense, wide research, and excellent judgment as to what should be left out of, as well as what should enter into, a work of this scope."—*Canada Lancet*.

"Dr. Wyeth has prepared a very excellent treatise on general, mechanical, and operative surgery, . . . The work . . . is distinctly what it claims to be, 'A Text-Book on General, Operative, and Mechanical Surgery,' carefully prepared and fully up to all the modern improvements in surgery."—*New York Medical Times*.

" . . . The eminent surgeon, Dr. Wyeth, has here presented a most valuable production. Though styled a text-book, it is admirably adapted as a work of reference for the surgeon and practitioner, giving, as it does, the recent and advanced views upon all surgical procedures. . . . In short, the entire book evinces the work of a master-mind and a superior operator in surgery."—*Southern Medical Record*.

"A surgeon who has in his library such works as Agnew's, Gross's, Hamilton's, Ashurst's, System, etc., may think that he needs no new one, but we venture the opinion that if he sees this work he will buy it. The first thing that will attract him is the elegant colored illustrations—the new cuts and the perfect press-work. Then the terseness and vigor of the style in which it is written will delight him, and a more complete examination will convince him that the book is so full of meat that he can not do without it."—*Buffalo Medical and Surgical Journal*.

SPECIMEN OF ILLUSTRATION.

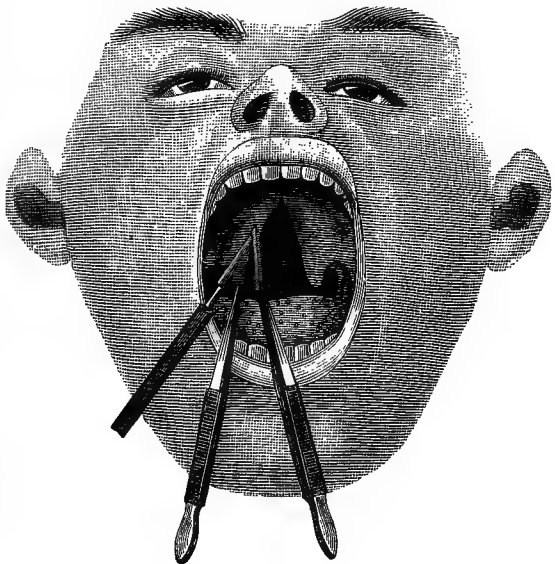

WYLLIE. Reports. Bellevue and Charity Hospital Reports for 1870, containing valuable contributions from ISAAC E. TAYLOR, M. D., AUSTIN FLINT, M. D., LEWIS A. SAYRE, M. D., WILLIAM A. HAMMOND, M. D., T. GAILLARD THOMAS, M. D., FRANK H. HAMILTON, M. D., and others. 8vo. 415 pages. Cloth, \$4.00.

"These institutions are the most important, as regards accommodations for patients and variety of cases treated, of any on this continent, and are surpassed by but few in the world. The gentlemen connected with them are acknowledged to be among the first in their profession, and the volume is an important addition to the professional literature of this country."—*Psychological Journal*.

Journal of Cutaneous and Genito-Urinary Diseases. Edited by PRINCE A. MORROW, A. M., M. D., and JOHN A. FORDYCE, M. D. Subscription price, \$2.50 per annum.

"The New York Medical Journal," \$5.00; "Journal of Cutaneous and Genito-Urinary Diseases," \$2.50; Club rate, \$7.00 per annum.

With the number for January, 1889, this Journal enters upon the seventh year of its publication. The history of the Journal has been one of progression, and, under the present editorial management, there can be no doubt that it will preserve and increase the reputation already established.

Devoted to the diseases indicated in its title, the Journal will be contributed to by the most eminent dermatologists and syphilographers in this country. Whenever the subject requires illustration, woodcuts or chromo-lithographs will be employed.

Letters from Europe, one or more of which will appear in each issue of the Journal, will keep the reader informed of the advances in this department of medicine at the great medical centers, Vienna, Berlin, and Paris.

A feature of the Journal will be the publication of abstracts of translations of notable papers and selections from foreign journals.

Due prominence will be given to Society Transactions, including papers read and the discussions had thereon, so far as they have a bearing upon the subjects to which the pages of the Journal are devoted.

Both the editors and the publishers will put forth every effort to make the Journal instructive, attractive, and a representative one of its class; and they feel assured that every practitioner, whose work brings him in contact with cutaneous or genito-urinary diseases, will find it of great value and assistance to him.

The New York Medical Journal. A Weekly Review of Medicine. Edited by FRANK P. FOSTER, M. D. The volumes begin with January and July of each year. Subscriptions can be arranged to begin with the volume. Terms, Payable in Advance: One Year, \$5.00; Six Months, \$2.50; Single Copy, 10 cents. (No subscriptions received for less than six months.) Binding Cases, Cloth, 50 cents.

"The Popular Science Monthly" and "The New York Medical Journal" to the same address, \$9.00 per annum (full price, \$10.00), payable in advance.

"The New York Medical Journal," now in the twenty-fourth year of its publication, is published every Saturday, each number containing twenty-eight large double-columned pages of reading matter. By reason of the condensed form in which the matter is arranged, it contains more reading matter than any other journal of its class in the United States. It is also more freely illustrated, and its illustrations are generally better executed than is the case with other weekly journals.

REASONS WHY PHYSICIANS SHOULD SUBSCRIBE FOR THE JOURNAL.

- BECAUSE:** It is the *LEADING JOURNAL* of America, and contains more reading matter than any other journal of its class.
- BECAUSE:** It is the exponent of the most advanced scientific medical thought.
- BECAUSE:** Its contributors are among the most learned medical men of this country.
- BECAUSE:** Its "Original Articles" are the results of scientific observation and research, and are of infinite practical value to the general practitioner.
- BECAUSE:** The "Reports on the Progress of Medicine," which are published from time to time, contain the most recent discoveries in the various departments of medicine, and are written by practitioners especially qualified for the purpose.

- BECAUSE: The column devoted in each number to "Therapeutical Notes" contains a *résumé* of the practical application of the most recent therapeutic novelties.
- BECAUSE: The Society Proceedings, of which each number contains one or more, are reports of the practical experience of prominent physicians, who thus give to the profession the results of certain modes of treatment in given cases.
- BECAUSE: The Editorial Columns are controlled only by the desire to promote the welfare, honor, and advancement of the science of medicine, as viewed from a standpoint looking to the best interests of the profession.
- BECAUSE: Nothing is admitted to its columns that has not some bearing on medicine, or is not possessed of some practical value.
- BECAUSE: It is published solely in the interests of medicine, and for the upholding of the elevated position occupied by the profession of America.

The Popular Science Monthly. Established by E. L. YOUMANS. Edited by W. J. YOUMANS. The volumes begin in May and November of each year. Subscriptions may begin at any time. Terms, \$5.00 per annum; single numbers, 50 cents.

"The Popular Science Monthly" and "The New York Medical Journal" to one address, \$9.00 per annum (full price, \$10.00), payable in advance.

"The Popular Science Monthly" will contain articles by well-known writers on all subjects of practical interest. Its range of topics, which is widening with the advance of science, includes:

Political Science and Government.
Domestic and Social Economy.
Education.

Religion as it is related to Science.
Ethics, based on Scientific Principles.
Sanitary Conditions; Hygiene; the Prevention of Disease.

Architecture and Art in connection with Practical Life.

The Development of the Race.
Food-products and Agriculture.
Natural History; Scientific Exploration.
Discovery; Experimental Science.
The Practical Arts.

The Science of Living.

Contains Illustrated Articles; Portraits; Biographical Sketches.

It records the advance made in every branch of science.

It is not technical; it is intended for non-scientific as well as scientific readers, for all persons of intelligence.

No magazine in the world contains papers of a more instructive and at the same time of a more interesting character.

"This is one of the very best periodicals of its kind published in the world. Its corps of contributors comprises many of the ablest minds known to science and literature."—*American Medical Journal (St. Louis)*.

"No scientific student can dispense with this monthly, and it is difficult to understand how any one making literary pretensions fails to become a regular reader of this journal. 'The Popular Science Monthly' meets a want of the medical profession not otherwise met. It keeps full pace with the progress of the times in all the departments of scientific pursuit."—*Virginia Medical Monthly*.

"Outside of medical journals, there is no periodical published in America as well worthy of being placed upon the physician's library-table and regularly read by him as 'The Popular Science Monthly.'"—*St. Louis Clinical Record*.

"'The Popular Science Monthly' is invaluable to persons of literary tastes who have neither time nor opportunity to prosecute special scientific researches, but who nevertheless wish to have a correct understanding of what is being done by others in the various departments of science."—*Louisiana Journal of Education*.

"A journal of eminent value to the cause of popular education in this country."—*N. Y. Tribune*.

"Every physician's table should bear this valuable monthly, which we believe to be one of the most interesting and instructive of the periodicals now published, and one which is destined to play a large part in the mental development of the laity of this country."—*Canadian Journal of Medical Science*.

"This magazine is worth its weight in gold for its service in educating the people."—*American Journal of Education (St. Louis)*.

"Journal of Cutaneous and Genito-Urinary Diseases," "New York Medical Journal," and "Popular Science Monthly," to one address, \$11.00 per annum.

INDEX.

Anatomy.

	PAGE
Chauveau. The Comparative Anatomy of the Domesticated Animals.....	10
Huxley. The Anatomy of Vertebrated Animals.....	26
Ranney. The Applied Anatomy of the Nervous System.....	38
Tracy. The Essentials of Anatomy, Physiology, and Hygiene.....	50

Bacteriology.

Hucppe. The Methods of Bacteriological Investigation.....	25
---	----

Brain.

Bastian. The Brain as an Organ of Mind....	4
Corning. A Treatise on Brain Exhaustion....	11
Hammond. A Treatise on Insanity.....	22
Luis. The Brain and its Functions.....	32
Smith. Diseases of Memory.....	47

Chemistry.

Johnston. The Chemistry of Common Life..	26
Roscoe and Schorlemmer. A Treatise on Chemistry.....	40
Wagner. A Hand-book of Chemical Technology.....	54
Wislicenus. Adolph Strecker's Short Text-book of Organic Chemistry.....	48

Children's Diseases.

Steiner. Compendium of Children's Diseases.	47
Vogel. A Practical Treatise on the Diseases of Children.....	53

Dermatology.

Neumann. Hand-book of Skin Diseases.....	34
Robinson. A Manual of Dermatology.....	40
Shoemaker. A Text-book of Diseases of the Skin.....	44

Diagnosis.

Burt. Exploration of the Chest in Health and Disease.....	9
---	---

Dictionaries.

Campbell. The Language of Medicine.....	9
Foster. An Illustrated Encyclopedic Medical Dictionary.....	16
Quain. A Dictionary of Medicine.....	37

Ear.

	PAGE
Pomeroy. The Diagnosis and Treatment of Diseases of the Ear.....	36

Electricity.

Nefel. Galvano-Therapeutics.....	33
----------------------------------	----

Emergencies.

Doty. A Manual of Instruction in the Principles of Prompt Aid to the Injured.....	12
Howe. Emergencies, and How to Treat them.	25

Eye.

Loring. A Text-book of Ophthalmoscopy....	30
Swanzy. A Hand-book of the Diseases of the Eye, and their Treatment.....	50

Genito-Urinary Diseases.

Keyes. A Practical Treatise on the Surgical Diseases of the Genito-Urinary Organs....	27
Keyes. The Tonic Treatment of Syphilis....	28
Von Zeissl. Outlines of the Pathology and Treatment of Syphilis and Allied Venereal Diseases.....	53

Gynæcology.

Jones. Practical Manual of Diseases of Women and Uterine Therapeutics.....	26
Schultze. The Pathology and Treatment of Displacements of the Uterus.....	43
Skene. A Text-book on the Diseases of Women	45

Health.

Billings. The Relation of Animal Diseases to the Public Health.....	5
Down. Health Primers.....	13
McSherry. Health, and How to Promote it... 33	
Richardson. A Ministry of Health.....	39
Smith. Health.....	46

Health Resorts.

Bennet. Winter and Spring on the Shores of the Mediterranean.....	5
Gutmann. The Watering-Places and Mineral Springs of Germany, Austria, and Switzerland.....	22
Walton. The Mineral Springs of the United States and Canada.....	54

Heart.

	PAGE
Bramwell. Diseases of the Heart and Thoracic Aorta.....	6

Materia Medica and Therapeutics.

Bartholow. On the Antagonism between Medicines and between Remedies and Diseases.	2
Bartholow. Treatise on Materia Medica and Therapeutics.....	3
Castro. Elements of Therapeutics and Practice according to the Dosimetric System...	10
Evetzky. The Physiological and Therapeutical Action of Ergot.....	14
Harvey. First Lines of Therapeutics.....	24
Pereira. Elements of Materia Medica and Therapeutics.....	36

Medicine.

Bartholow. A Treatise on the Practice of Medicine.....	1
Carter. Elements of Practical Medicine.....	10
Flint. Medicine of the Future.....	16
Legg. On the Bile, Jaundice, and Bilious Diseases.....	29
Niemeyer. A Text-book of Practical Medicine.	34
Stone. Elements of Modern Medicine.....	48
Strümpell. A Text-book of Medicine.....	49

Microscopy.

Friedlaender. The Use of the Microscope in Clinical and Pathological Examinations...	18
Peyer. An Atlas of Clinical Microscopy.....	36

Nervous Diseases.

Bastian. Paralyzes: Cerebral, Bulbar, and Spinal.....	4
Bastian. Paralysis from Brain Disease.....	4
Hammond. A Treatise on the Diseases of the Nervous System.....	23
Hammond. Clinical Lectures on Diseases of the Nervous System.....	22
Stevens. Functional Nervous Diseases.....	47
Webber. A Treatise on Nervous Diseases....	54

Nursing.

Nightingale. Notes on Nursing.....	35
Weeks. A Text-book of Nursing.....	55

Obstetrics.

Barker. The Puerperal Diseases.....	1
Elliot. Obstetric Clinic.....	13
Lusk. The Science and Art of Midwifery....	31
Schroeder. A Manual of Midwifery.....	43
Simpson. The Posthumous Works of Sir James Y. Simpson.....	45

Orthopædics.

	PAGE
Little. Medical and Surgical Aspects of In-Knee.....	30
Poore. Osteotomy and Osteoclasis.....	37
Sayre. A Practical Manual on the Treatment of Club-Foot.....	41
Sayre. Lectures on Orthopedic Surgery and Diseases of the Joints.....	42

Ovaries.

Peaslee. Ovarian Tumors.....	35
Wells. Diseases of the Ovaries.....	55

Pathology.

Billoth. General Surgical Pathology and Therapeutics.....	6
Frey. The Histology and Histo-Chemistry of Man.....	18
Maudsley. The Pathology of Mind.....	32

Periodicals.

Journal of Cutaneous and Genito-Urinary Diseases.....	57
New York Medical Journal.....	57
Popular Science Monthly.....	58

Phthisis.

Bennet. On the Treatment of Pulmonary Consumption.....	5
Evans. A Hand-book of Historical and Geographical Phthisiology.....	13
Jaccoud. The Curability and Treatment of Pulmonary Phthisis.....	26

Physiology.

Carpenter. Principles of Mental Physiology..	10
Flint. Text-book of Human Physiology.....	14
Flint. The Physiological Effects of Severe and Protracted Muscular Exercise.....	16
Maudsley. The Physiology of the Mind.....	33
Rosenthal. General Physiology of Muscles and Nerves.....	41

Rectum.

Van Buren. Lectures upon Diseases of the Rectum and the Surgery of the Lower Bowel.....	52
---	----

Surgery.

Bryant. A Manual of Operative Surgery....	7
Buck. Contributions to Reparative Surgery...	8
Corning. Local Anæsthesia in General Medicine and Surgery.....	12
Davis. Conservative Surgery.....	12
Garmany. Operative Surgery on the Cadaver. 19	19

	PAGE		PAGE
Gerster. The Rules of Aseptic and Antiseptic Surgery.....	20	Gamgee. Yellow Fever a Nautical Disease....	19
Gross. A Practical Treatise on Tumors of the Mammary Gland.....	21	Howe. The Breath, and the Diseases which give it a Fetid Odor.....	25
Kingsley. A Treatise on Oral Deformities....	28	Letterman. Medical Recollections of the Army of the Potomac.....	30
Van Buren. Lectures on the Principles of Surgery.....	52	Markoe. A Treatise on Diseases of the Bones.	32
Wyeth. A Text-book on Surgery.....	55	Maudsley. Body and Mind.....	32
Urinalysis.		Maudsley. Responsibility in Mental Diseases.	32
Flint. Manual of Chemical Examination of the Urine in Disease.....	15	Oswald. Physical Education.....	35
Hofmann and Ultzmann. Analysis of the Urine.	24	Richardson. Diseases of Modern Life.....	40
Miscellaneous.		Shears. The New York Medical Journal Visiting-List.....	43
Barker. On Sea-Sickness.....	1	Smith. On Foods.....	46
Combe. The Management of Infancy.....	11	Tracy. Hand-book of Sanitary Information for Household-ers.....	50
Flint. Medical Ethics and Etiquette.....	16	Tuson. Cyclopædia of Practical Receipts....	50
Flint. The Source of Muscular Power.....	16	Tyndall. Essays on the Floating Matter of the Air.....	51
Fothergill. The Diseases of Sedentary and Advanced Life.....	17	Ultzmann. Pyuria; or, Pus in the Urine, and its Treatment.....	51
Fournier. Syphilis and Marriage.....	18	Wylie. Hospitals.....	57

INTERNATIONAL SCIENTIFIC SERIES

Published by D. APPLETON & CO.

Each book complete in One Volume, 12mo, and bound in Cloth.

1. **Forms of Water:** A Familiar Exposition of the Origin and Phenomena of Glaciers. By J. TYNDALL, LL. D., F. R. S. With 25 Illustrations. \$1.50.
2. **Physics and Politics;** Or, Thoughts on the Application of the Principles of "Natural Selection" and "Inheritance" to Political Society. By WALTER BAGEHOT. \$1.50.
3. **Foods.** By EDWARD SMITH, M. D., LL. B., F. R. S. With numerous Illustrations. \$1.75.
4. **Mind and Body:** The Theories of their Relation. By ALEXANDER BAIN, LL. D. With four Illustrations. \$1.50.
5. **The Study of Sociology.** By HERBERT SPENCER. \$1.50.
6. **The New Chemistry.** By Prof. J. P. COOKE, of Harvard University. With 31 Illustrations. \$2.00.
7. **On the Conservation of Energy.** By BALFOUR STEWART, M. A., LL. D., F. R. S. With 14 Illustrations. \$1.50.
8. **Animal Locomotion;** Or, Walking, Swimming, and Flying. By J. B. PETTIGREW, M. D., F. R. S., etc. With 130 Illustrations. \$1.75.
9. **Responsibility in Mental Disease.** By HENRY MAUDSLEY, M. D. \$1.50.
10. **The Science of Law.** By Prof. SHELDON AMOS. \$1.75.
11. **Animal Mechanism:** A Treatise on Terrestrial and Aërial Locomotion. By Prof. E. J. MAREY. With 117 Illustrations. \$1.75.
12. **The History of the Conflict between Religion and Science.** By J. W. DRAPER, M. D., LL. D. \$1.75.
13. **The Doctrine of Descent and Darwinism.** By Prof. OSCAR SCHMIDT (Strasburg University). With 26 Illustrations. \$1.50.
14. **The Chemical Effects of Light and Photography.** By Dr. HERMANN VOGEL (Polytechnic Academy of Berlin). Translation thoroughly revised. With 100 Illustrations. \$2.00.
15. **Fungi:** Their Nature, Influences, Uses, etc. By M. C. COOKE, M. A., LL. D. Edited by the Rev. M. J. Berkeley, M. A., F. L. S. With 109 Illustrations. \$1.50.
16. **The Life and Growth of Language.** By Prof. WILLIAM DWIGHT WHITNEY, of Yale College. \$1.50.
17. **Money and the Mechanism of Exchange.** By W. STANLEY JEVONS, M. A., F. R. S. \$1.75.
18. **The Nature of Light,** with a General Account of Physical Optics. By Dr. EUGENE LOMMEL. With 188 Illustrations and a Table of Spectra in Chromo-lithography. \$2.00.
19. **Animal Parasites and Messmates.** By Monsieur VAN BENEDEN. With 83 Illustrations. \$1.50.
20. **Fermentation.** By Prof. SCHÜTZENBERGER. With 28 Illustrations. \$1.50.
21. **The Five Senses of Man.** By Prof. BERNSTEIN. With 91 Illustrations. \$1.75.
22. **The Theory of Sound in its Relation to Music.** By Prof. PIETRO BLASERNA. With numerous Illustrations. \$1.50.

23. **Studies in Spectrum Analysis.** By J. NORMAN LOCKYER, F. R. S. With six Photographic Illustrations of Spectra, and numerous Engravings on Wood. \$2.50.
24. **A History of the Growth of the Steam-Engine.** By Prof. R. H. THURSTON. With 163 Illustrations. \$2.50.
25. **Education as a Science.** By ALEXANDER BAIN, LL. D. \$1.75.
26. **Students' Text-Book of Color; Or, Modern Chromatics.** With Applications to Art and Industry. By Prof. OGDEN N. ROOD, Columbia College. New edition. With 130 Illustrations. \$2.00.
27. **The Human Species.** By Prof. A. DE QUATREFAGES, Membre de l'Institut. \$2.00.
28. **The Crayfish: An Introduction to the Study of Zoölogy.** By T. H. HUXLEY, F. R. S. With 82 Illustrations. \$1.75.
29. **The Atomic Theory.** By Prof. A. WURTZ. Translated by E. Cleminshaw, F. C. S. \$1.50.
30. **Animal Life as affected by the Natural Conditions of Existence.** By KARL SEMPER. With two Maps and 106 Woodcuts. \$2.00.
31. **Sight: An Exposition of the Principles of Monocular and Binocular Vision.** By JOSEPH LE CONTE, LL. D. With 132 Illustrations. \$1.50.
32. **General Physiology of Muscles and Nerves.** By Prof. J. ROSENTHAL. With 75 Illustrations. \$1.50.
33. **Illusions: A Psychological Study.** By JAMES SULLY. \$1.50.
34. **The Sun.** By C. A. YOUNG, Professor of Astronomy in the College of New Jersey. With numerous Illustrations. \$2.00.
35. **Volcanoes: What they Are and what they Teach.** By JOHN W. JUDD, F. R. S., Professor of Geology in the Royal School of Mines. With 96 Illustrations. \$2.00.
36. **Suicide: An Essay in Comparative Moral Statistics.** By HENRY MORSELLI, M. D., Professor of Psychological Medicine, Royal University, Turin. \$1.75.
37. **The Formation of Vegetable Mould, through the Action of Worms.** With Observations on their Habits. By CHARLES DARWIN, LL. D., F. R. S. With Illustrations. \$1.50.
38. **The Concepts and Theories of Modern Physics.** By J. B. STALLO. \$1.75.
39. **The Brain and its Functions.** By J. LUYB. \$1.50.
40. **Myth and Science.** By TITO VIGNOLI. \$1.50.
41. **Diseases of Memory: An Essay in the Positive Psychology.** By TH. RIBOT, author of "Heredity." \$1.50.
42. **Ants, Bees, and Wasps.** A Record of Observations of the Habits of the Social Hymenoptera. By Sir JOHN LUBBOCK, Bart., F. R. S., D. C. L., LL. D., etc. \$2.00.
43. **Science of Politics.** By SHELDON AMOS. \$1.75.
44. **Animal Intelligence.** By GEORGE J. ROMANES. \$1.75.
45. **Man before Metals.** By N. JOLY, Correspondent of the Institute. With 148 Illustrations. \$1.75.
46. **The Organs of Speech and their Application in the Formation of Articulate Sounds.** By G. H. VON MEYER, Professor in Ordinary of Anatomy at the University of Zürich. With 47 Woodcuts. \$1.75.
47. **Fallacies: A View of Logic from the Practical Side.** By ALFRED SIDGWICK, B. A., Oxon \$1.75.

48. **Origin of Cultivated Plants.** By ALPHONSE DE CANDOLLE. \$2.00.
49. **Jelly-Fish, Star-Fish, and Sea-Urchins.** Being a Research on Primitive Nervous Systems. By GEORGE J. ROMANES. \$1.75.
50. **The Common Sense of the Exact Sciences.** By the late WILLIAM KINGDON CLIFFORD. \$1.50.
51. **Physical Expression: Its Modes and Principles.** By FRANCIS WARNER, M.D., Assistant Physician, and Lecturer on Botany to the London Hospital, etc. With 51 Illustrations. \$1.75.
52. **Anthropoid Apes.** By ROBERT HARTMANN, Professor in the University of Berlin. With 63 Illustrations. \$1.75.
53. **The Mammalia in their Relation to Primeval Times.** By OSCAR SCHMIDT. \$1.50.
54. **Comparative Literature.** By HUTCHESON MACAULAY POSNETT, M. A., LL. D., F. L. S., Barrister-at-Law; Professor of Classics and English Literature, University College, Auckland, New Zealand; author of "The Historical Method," etc. \$1.75.
55. **Earthquakes and other Earth Movements.** By JOHN MILNE, Professor of Mining and Geology in the Imperial College of Engineering, Tokio, Japan. With 38 Figures. \$1.75.
56. **Microbes, Ferments, and Moulds.** By E. L. TROUESSART. With 107 Illustrations. \$1.50.
57. **The Geographical and Geological Distribution of Animals.** By ANGELO HEILPRIN. \$2.00.
58. **Weather.** A Popular Exposition of the Nature of Weather Changes from Day to Day. With Diagrams. By HON. RALPH ABERCROMBY. \$1.75.
59. **Animal Magnetism.** By ALFRED BINET and CHARLES FÉRÉ, Assistant Physician at the Salpêtrière. \$1.50.
60. **International Law, with Materials for a Code of International Law.** By LEONE LEVI, Professor of Common Law, King's College. \$1.50.
61. **The Geological History of Plants.** With Illustrations. By Sir J. WILLIAM DAWSON, LL. D., F. R. S. \$1.75.
62. **Anthropology.** An Introduction to the Study of Man and Civilization. By EDWARD B. TYLOR, D. C. L., F. R. S. Illustrated. \$2.00.
63. **The Origin of Floral Structures, through Insect and other Agencies.** By the Rev. GEORGE HENSLOW, M. A., F. L. S., F. G. S. With 88 Illustrations. \$1.75.
64. **On the Senses, Instincts, and Intelligence of Animals, with Special Reference to Insects.** By Sir JOHN LUBBOCK. With over 100 Illustrations. \$1.75.
65. **The Primitive Family in its Origin and Development.** By Dr. C. N. STARCKE, of the University of Copenhagen.

New York: D. APPLETON & CO., 1, 3, & 5 Bond Street.



