

THE MICROSCOPE

GAGE



THE METRIC SYSTEM



10 CENTIMETER RULE

The upper edge is in millimeters, the lower in centimeters and half centimeters

UNITS.

The most commonly used divisions and multiples

- THE METER FOR LENGTH { *Centimeter* (cm.), 0.01 Meter; *Millimeter* (mm.), 0.001 Meter; *Micron* (μ), 0.001 Millimeter; the Micron is the unit in Micrometry (§182). *Kilometer*, 1000 Meters; used in measuring roads and other long distances.
- THE GRAM FOR WEIGHT { *Milligram* (mg.), 0.001 Gram, *Kilogram*, 1000 Grams, used for ordinary masses, like groceries, etc.
- THE LITER FOR CAPACITY { *Cubic Centimeter* (cc.), 0.001 Liter. This is more common than the correct form, *Milliliter*.

Divisions of the Units are indicated by the Latin prefixes; *deci*, 0.1; *centi*, 0.01; *Milli*, 0.001; *Micra*, one millionth (0.000001) of any unit.

Multiples are designated by the Greek prefixes: *deka*, 10 times; *hecto*, 100 times; *kilo*, 1000 times; *myria*, 10,000 times; *Mega*, one million (1,000,000) times any unit.

TABLE OF METRIC AND ENGLISH MEASURES

Meter (Unit of length)=100 centimeters; 1,000 millimeters; 1,000,000 **microns** (μ) 39.3704 inches = 3.2808 feet; 1.0936 yards.

Centimeter (cm.)=10 millimeters; 10,000 microns (μ) 0.01 meter; 0.3937 ($\frac{2}{5}$) inch.

Millimeter (mm.)=1,000 microns (μ); 0.1 cm.; 0.001 meter; 0.03937 ($\frac{1}{25}$) inch.

Micron (μ) (Unit of measure in micrometry (§182))=0.001 millimeter; one millionth of a meter; 0.00003937 ($\frac{1}{25000}$) inch.

Yard=3 feet; 36 inches; 0.91439 meter; 91.4399 centimeters.

Foot=12 inches; 30.4799 centimeters; 304.799 millimeters.

Inch= $\frac{1}{12}$ foot; $\frac{3}{8}$ yard; 25.3999 millimeters (2.54 centimeters).

Liter (Unit of capacity)=1,000 cubic centimeters (milliliters); (1 quart—)

Cubic centimeter=0.001 liter (milliliter); ($\frac{1}{175}$ cub. inch.)

Fluid ounce (8 fluidrachms)=29.574 cubic centimeters (30 cc.—).

Gram (Unit of weight)=1 cc. of water; 15.432 grains.

Kilogram=1,000 grams; 2.2046 ($2\frac{1}{2}$) lbs. avoirdupois.

Ounce avoirdupois=437 $\frac{1}{2}$ grains; 28.349 grams.

Ounce Troy or apothecaries=480 grains; 31.103 grams } 30 grams, approx.

TEMPERATURE

To change Centigrade to Fahrenheit; $(C. \times \frac{9}{5}) + 32 = F.$ For example, to find the equivalent of 10° Centigrade, $C. = 10^\circ \times \frac{9}{5} + 32 = 50^\circ F.$

To change Fahrenheit to Centigrade; $(F. - 32^\circ) \times \frac{5}{9} = C.$ For example, to reduce 50° Fahrenheit to Centigrade, $(F. = 50^\circ, \text{ and } (50^\circ - 32^\circ) \times \frac{5}{9} = 10^\circ C.; \text{ or } -40^\circ \text{ Fahrenheit to Centigrade, } F. = -40^\circ (-40^\circ - 32^\circ) = -72^\circ, \text{ whence } -72^\circ \times \frac{5}{9} = -40^\circ C.$

Address of American Opticians: For the price of microscopes and microscopical supplies the student is advised to obtain a catalog of one or more of the opticians. Nearly all of them import foreign apparatus. For foreign opticians see the table of tube-length p. 18.

- The Bausch & Lomb Optical Co. Rochester, New York
- James T. Dougherty 409-411 West 59th St., New York
- Eimer & Amend 205-211 3d Ave., New York
- The Gundlach-Manhattan Optical Company Rochester, N. Y.
- E. Leitz 39 East 18th St., New York
- Edward Pennock 3609 Woodland Ave., Philadelphia, Pa
- A. B. Porter 324 Dearborn St., Chicago
- Queen & Company 1010 Chestnut St., Philadelphia, Pa.
- Spencer Lens Company 367-373 Seventh St., Buffalo, N. Y.
- Williams, Brown & Earle 918 Chestnut St., Philadelphia, Pa.
- Voigtländer und Sohn, A. G. 225 Fifth Ave., New York
- Joseph Zentmayer 226-228 South 15th St., Philadelphia, Pa.

Besides the names here given, nearly every large city has one or more dealers in microscopes and microscope supplies.

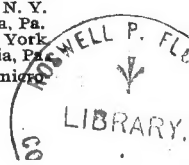

Cornell University Library
QM 551.G13 1908

The microscope :an introduction to micro



3 1924 001 037 088

vet



Flower Library

Compliments of

SIMON HENRY GAGE,

Professor of Histology and Embryology, Emeritus,

Cornell University, Ithaca, New York,

U. S. A.

THIS BOOK IS THE GIFT OF



THE METRIC SYSTEM



10 CENTIMETER RULE

The upper edge is in millimeters, the lower in centimeters and half centimeters

UNITS.

The most commonly used divisions and multiples

- THE METER FOR LENGTH { Centimeter (cm.), 0.01 Meter; Millimeter (mm.), 0.001 Meter; Micron (μ), 0.001 Millimeter; the Micron is the unit in Micrometry (§182). Kilometer, 1000 Meters; used in measuring roads and other long distances.
- THE GRAM FOR WEIGHT { Milligram (mg.), 0.001 Gram. Kilogram, 1000 Grams, used for ordinary masses, like groceries, etc.
- THE LITER FOR CAPACITY { Cubic Centimeter (cc.), 0.001 Liter. This is more common than the correct form, Milliliter.

Divisions of the Units are indicated by the Latin prefixes; *deci*, 0.1; *centi*, 0.01; *Milli*, 0.001; *Micro*, one millionth (0.000001) of any unit

Multiples are de times; *myria*, 10,000

TAB

- Meter** (Unit of 1 (μ) 39,3704 i
Centimeter (cm.)
 inch.
Millimeter (mm.)
Micron (μ) (Unit
 millionth of
 Yard=3 feet; 36
 Foot=12 inches;
 Inch= $\frac{1}{12}$ foot; $\frac{1}{3}$
Liter (Unit of ca
 Cubic centimeter
 Fluid ounce (8 fl
Gram (Unit of w
 Kilogram=1,000
 Ounce avoirdupo
 Ounce Troy or ap

TEMPERATURE

To change Centigrade to Fahrenheit; $(C. \times \frac{9}{5}) + 32 = F.$ For example, to find the equivalent of 10° Centigrade, $C. = 10^\circ \times \frac{9}{5} + 32 = 50^\circ F.$

To change Fahrenheit to Centigrade; $(F. - 32^\circ) \times \frac{5}{9} = C.$ For example, to reduce 50° Fahrenheit to Centigrade, $(F. = 50^\circ, \text{ and } (50^\circ - 32^\circ) \times \frac{5}{9} = 10^\circ C.; \text{ or } -40^\circ \text{ Fahrenheit to Centigrade, } F. = -40^\circ (-40^\circ - 32^\circ) = -72^\circ, \text{ whence } -72^\circ \times \frac{5}{9} = -40^\circ C.$

Address of American Opticians: For the price of microscopes and microscopical supplies the student is advised to obtain a catalog of one or more of the opticians. Nearly all of them import foreign apparatus. For foreign opticians see the table of tube-length p. 18.

The Bausch & Lomb Optical Co.	Rochester, New York
James T. Dougherty	409-411 West 59th St., New York
Eimer & Amend	205-211 3d Ave., New York
The Gundlach-Manhattan Optical Company	Rochester, N. Y.
E. Leitz	30 East 18th St., New York
Edward Penneck	3609 Woodland Ave., Philadelphia, Pa
A. B. Porter	324 Dearborn St., Chicago
Queen & Company	100 Chestnut St., Philadelphia, Pa.
Spencer Lens Company	367-373 Seventh St., Buffalo, N. Y.
Williams, Brown & Earle	918 Chestnut St., Philadelphia, Pa.
Voigtländer und Sohn, A. G.	225 Fifth Ave., New York
Joseph Zentmayer	226-228 South 15th St., Philadelphia, Pa.

Besides the names here given, nearly every large city has one or more dealers in microscopes and microscope supplies.

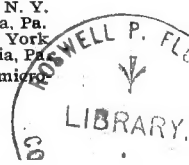

Cornell University Library
QM 551.G13 1908

The microscope :an introduction to micro



3 1924 001 037 088

vet

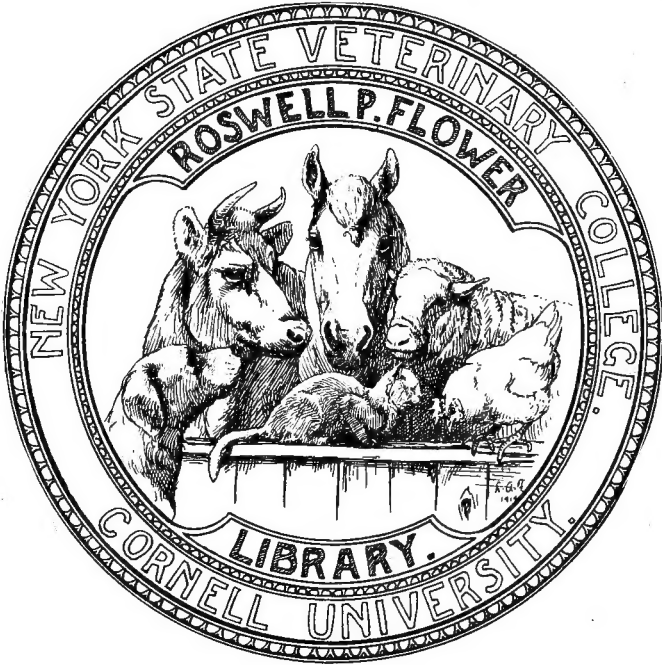

THIS BOOK IS THE GIFT OF

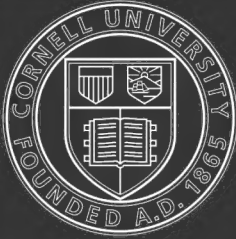

Cornell University
Library

The original of this book is in
the Cornell University Library.

There are no known copyright restrictions in
the United States on the use of the text.

<http://archive.org/details/cu31924001037088>

THE MICROSCOPE

AN
INTRODUCTION TO MICROSCOPIC
METHODS AND TO HISTOLOGY

BY SIMON HENRY GAGE
Professor of Histology and Embry-
ology, Emeritus in Cornell University

10th
EDITION

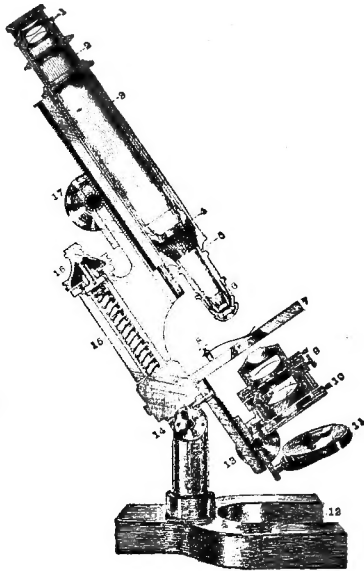

REVISED AND ILLUSTRATED BY OVER
TWO HUNDRED FIGURES

COMSTOCK PUBLISHING COMPANY
ITHACA, NEW YORK
1908

Copyright, 1908
BY SIMON HENRY GAGE
All Rights Reserved

Printed by
Priest & Benjamin
Ithaca, N. Y.

To
THE STUDENTS WHO HAVE BEEN
UNDER MY PERSONAL SUPERVISION,
AND TO THE UNKNOWN GROUPS OF
WORKERS WHO HAVE RECEIVED AID
FROM EARLIER EDITIONS, I DEDI-
CATE THIS TENTH EDITION. ❀ ❀

PREFACE TO THE TENTH EDITION

WITH the general progress of Science, the Microscope and its Accessories have not only kept pace, but have added their full share to the momentum of that progress. With the increased usefulness and consequent use of the microscope it has steadily advanced in excellence and efficiency; and the means of applying it to the solution of the problems confronting the workers in various fields are becoming more simple and exact every year.

In rewriting this book the aim has been to represent the microscope of the present day, and to serve as a helpful introduction to the microscopic world. Constant reference has been made to original sources in books and periodicals so that the investigator, the teacher and the ambitious student might find fuller treatment of any subject in which he is especially interested.

Grateful acknowledgement is made to the opticians, and the manufacturers of laboratory supplies for the loan of cuts, and for courteous and complete answers to numerous questions; to the directors of laboratories for helpful suggestions; to my colleagues in Cornell University and to my pupils; to Henry Phelps Gage for help in optics, micro-chemistry and photography; to Susanna Phelps Gage for a critical revision of the whole work, for proof reading and the preparation of the index. And finally to Professor Burt Green Wilder who encouraged me when a student to undertake work with the microscope, and gave me every facility in his power, I wish to express special feelings of gratitude.

SIMON HENRY GAGE,
CORNELL UNIVERSITY,
ITHACA, N. Y., U. S. A.

October 1, 1908

CONTENTS

	PAGE
CHAPTER I	
The Microscope and its Parts : Lenses ; Simple Microscopes ; Compound Microscopes ; Objectives, Oculars and their Function ; Tube-Length of the Microscope ; Field of the Microscope ; Aperture	1- 38
CHAPTER II	
Lighting and Focusing : Day Light ; Artificial Light ; Diaphragms ; Condensers ; Dark-Ground Illumination ; Ultramicroscopy ; Refraction and Color Images ; Adjustable and Immersion Objectives ; Testing a Microscope ; Care of the Microscope and of the Eyes ; The Royal Microscopical Society's Standard Sizes and Screws ; Laboratory Microscopes	39- 98
CHAPTER III	
Interpretation of Appearances under the Microscope ; Pedesis or Brownian Movement ; Binocular Microscopes	99-115
CHAPTER IV	
Magnification and Micrometry : Magnification of a Simple Microscope ; Magnification of a Compound Microscope ; Varying the Magnification ; Camera Lucida ; Micrometry ; Micrometry with a Simple and with a Compound Microscope ; Unit of Measure in Micrometry ; Ocular Micrometers ; Filar Micrometers ; Varying the Ocular Micrometer Valuation ; Wright's Eikonometer	116-140
CHAPTER V	
Drawing with the Microscope : Camera Lucida ; Magnification of Drawings ; Drawing with the Projection Microscope	141-154
CHAPTER VI	
Micro-Spectroscope ; Micro-Polariscope ; Micro-Chemistry ; Textile Fibers ; Food and Pharmacological Products ; Metallography	155-184
CHAPTER VII	
The Abbe Test Plate ; Apertometer ; Determination of the Equivalent Focus of Objectives and Oculars ; Class Demonstrations ; Individual Demonstrations in Microscopy, Histology and Embryology	185-202

CHAPTER VIII

Photographing with a Vertical Camera; Photographing large, Transparent Objects with a Camera pointed to the Sky; Photographing with a Microscope; Photographing Opaque Objects and the Surfaces of Metals and Alloys; Enlargements; Lantern Slides and Bacterial Cultures.....	203-244
--	---------

CHAPTER IX

Slides and Cover-Glasses; Temporary and Permanent Mounting; Labeling Microscopic Slides; Cabinets and Trays for Storing Microscopic Specimens; Isolation of Histologic Elements; Preparation of Reagents used in Microscopy, Histology and Embryology.....	245-183
--	---------

CHAPTER X

Fixation; Microtomes and Section Knives; Sectioning Free-Hand, with the Freezing Microtome, with a Hand or Table Microtome; Preparation of Sections by the Paraffin Method; by the Collodion Method; Staining Microscopic Preparations; Mounting; Serial Sectioning of Embryos etc.; Drawings for Book Illustrations and for the Preparation of Models; Wax Models; Models of Blotting Paper.....	284-332
Bibliography.....	333-345
Index.....	346-359

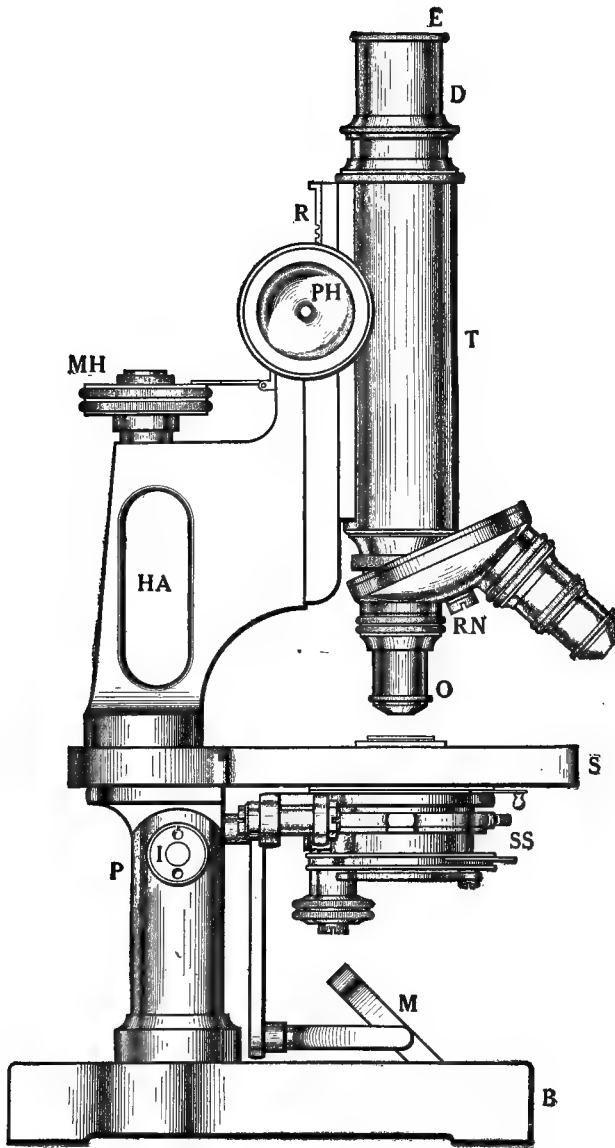

Parts of a Microscope : B Base or foot ; D Draw-tube ; E Ocular or eye-piece ; HA Handle ; I Joint for inclination ; M Mirror ; MH Head of the micrometer screw for fine adjustment ; O Objective ; P Pillar ; PH Head of the Pinion for the coarse adjustment ; R Rack of coarse adjustment ; RN Revolving nose-piece ; S Stage of the microscope ; SS Substage containing the Abbe condenser ; T Body Tube. (Cuts loaned by the Bausch & Lomb Opt. Co.)

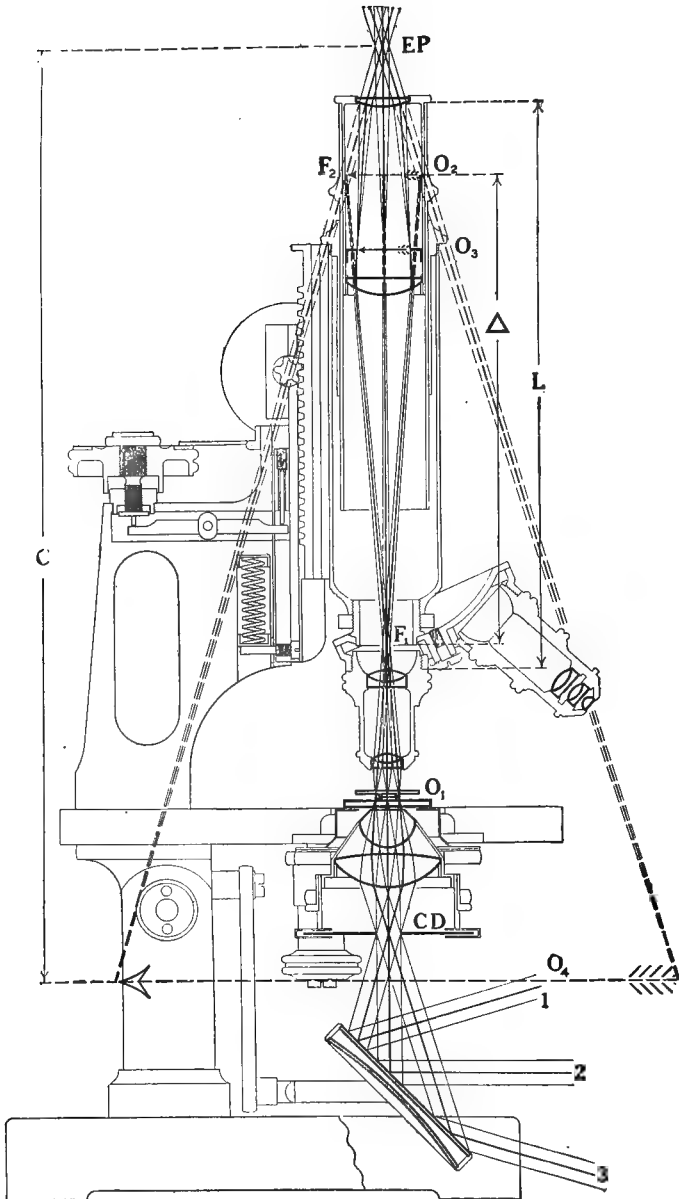

The Microscope in Section with the Images: 1, 2, 3, Beams of light to the mirror; C Image distance, *i. e.*: from eye-point, E-P, to virtual image (O_4); CD Condenser diaphragm; EP Eye-point; F_1 Upper focal plane of the objective; F_2 Lower focal plane of the eye-piece; L Mechanical tube-length, *i. e.*: from top of draw-tube to screw for insertion of the objective; O_1 Object on the stage; O_2 Image formed by the objective were no field lens present; O_3 Image when field lens is present; O_4 Virtual image; Δ Optical tube-length, *i. e.*: distance from the upper focal plane of the objective (F_1) to lower focal plane of eye-piece F_2 .

THE MICROSCOPE

AND

MICROSCOPICAL METHODS

CHAPTER I

THE MICROSCOPE AND ITS PARTS

APPARATUS AND MATERIAL FOR THIS CHAPTER

A simple microscope (§ 2, 12); A compound microscope with nose-piece (Figs. 76-95); eye-shade (Fig. 67), achromatic (§ 23), apochromatic (§ 25), dry (§ 20), immersion (§ 21), unadjustable and adjustable objectives (§ 26, 27); Huygenian or negative (§ 45), positive (§ 43) and compensation oculars (§ 46); stage micrometer (Ch. IV); homogeneous immersion liquid (§ 21); mounted letters or figures (§ 60); ground-glass and lens paper (§ 60).

A MICROSCOPE*

§ 1. A **Microscope** is an optical apparatus with which one may obtain a clear image of a near object, the image being always larger than the object; that is, it enables the eye to see an object under a greatly increased visual angle, as if the object were brought very close to the eye without affecting the distinctness of vision. Whenever the microscope is used for observation, the eye of the observer forms an integral part of the optical combination (Figs. 16, 26).

§ 2. A **Simple Microscope**.—With this an enlarged, erect image of an

* For the History of the Microscope see: Harting, Poggendorff, Mayall, Carpenter-Dallinger, Petri; and Gage, the Origin and Development of the Projection Microscope.

object may be seen. It always consists of one or more converging lenses or lens-systems (Fig. 16), and the object must be placed within the principal focus (§ 12-14). The simple microscope may be held in the hand or it may be mounted in some way to facilitate its use (Figs. 19-22).

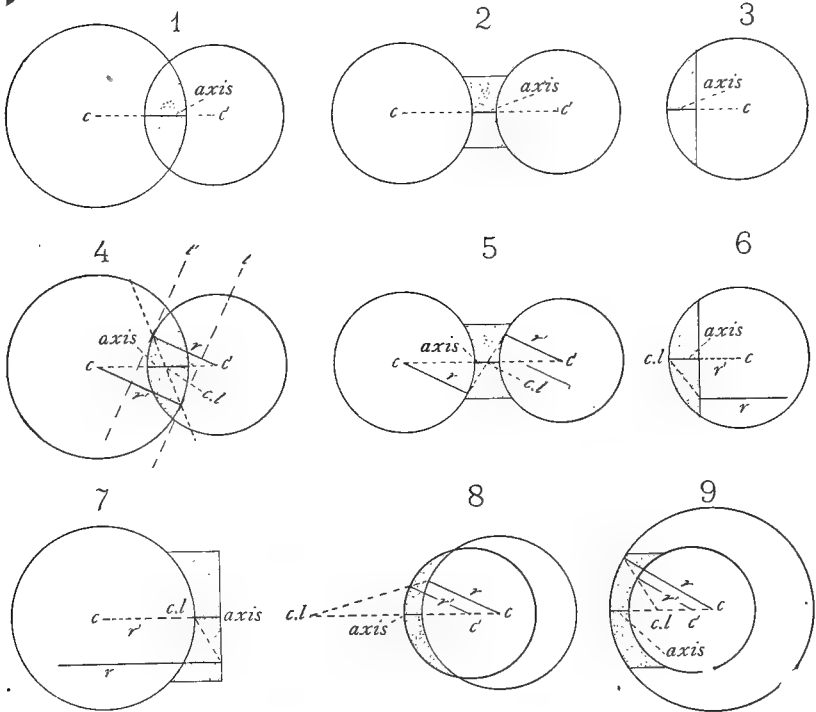

FIGS. 1-9, Showing the Principal Optic Axis and the Optical Center of various forms of Lenses.

Axis. The Principal Optic Axis. $c-c'$. Centers of curvature of the two surfaces of the lens. $c.l.$ Optical center of the lens. $r-r'$. Radii of curvature of the two lens surfaces. $t-t'$. Tangents in Fig. 4.

§ 3. Principal Optic Axis.—In spherical lenses, *i. e.*, lenses which have spherical surfaces, the Axis is a line joining the centers of curvature and indefinitely extended. In the figures (1-9) this line ($c-c'$) is broken except where it traverses the lens. In lenses with one plane surface (Figs. 3, 6, 7) the radius of the plane surface is any line at right angles to it, but in determining the axis it must be the one which is continuous with the radius of the curved surface, consequently the axis in such lenses is on the radius of the curved surface which meets the plane surface at right angles.

§ 4. **Optical Center.**—The optical center of a lens is the point through which rays pass without angular deviation, that is, the emergent ray is parallel to the incident ray. It is determined geometrically by drawing parallel radii of the curved surfaces, $r-r'$ in Figs. 4-9, and joining the peripheral ends of the radii. The optical center is the point on the axis cut by the line joining the peripheral ends of the parallel radii of the two lens surfaces. In Figs. 4-5 it is within the lens; in 6-7 it is at the curved surface, and in the meniscus (8, 9) it is wholly outside the lens, being situated on the side of the greater curvature.

In determining the center in a lens with a plane surface, the conditions can be satisfied only by using the radius of the curved surface which is continuous with the axis of the lens, then any line at right angles to the plane surface will be parallel with it, and may be considered part of the radius of the plane surface. (That is, a plane surface may be considered part of a sphere with infinite radius, hence any line meeting the plane surface at right angles may be considered as the peripheral part of the radius.) In Figs. 6, 7, (r') is the radius of the curved surface and (r) of the plane surface; and the point where a line joining the ends of these radii crosses the axis is at the curved surface in each case.

By a study of Fig. 4 it will be seen that if tangents be drawn at the peripheral ends of the parallel radii, the tangents will also be parallel and a ray incident at one tangential point and traversing the lens and emerging at the other tangential point acts as if traversing, and is practically traversing a piece of glass which has parallel sides at the point of incidence and emergence, therefore the emergent ray will be parallel with the incident ray. This is true of all rays traversing the center of the lens.

§ 5. **Thick Lenses.**—In all of the diagrams of lenses and the course of rays through them in this book the lenses are treated as if they were infinitely thin. In thick lenses like those figured, while there would be no angular

FIGS. 10, 11.—Sectional views of a concave or diverging and a convex or converging lens to show that in the concave lens the principal focus is virtual as indicated by the dotted lines, while with the convex lens the focus is real and on the side of the lens opposite to that from which the light comes.

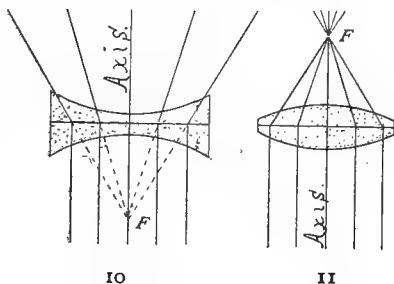

deviation for rays traversing the center of the lens, there would be lateral displacement. This is shown in Fig. 64 illustrating the effect of the cover-glass.

§ 6. **Secondary Axis.**—Every ray traversing the center of the lens, except the principal axis, is a secondary axis; and every secondary axis is

more or less oblique to the principal axis. In Fig. 14, line (2), is a secondary axis, and in Fig. 15, line (1). See also Fig. 65.

§ 7. **Principal Focus.**—This is the point where rays parallel with the axis and traversing the lens cross the axis; and the distance from the focus to the center of the lens measured along the axis is the *Principal Focal Distance*. In the diagrams, Fig. 10 is seen to be a diverging lens, and the rays cross the axis only by being projected backward. Such a focus is said to be virtual, as it has no real existence. In Fig. 11 the rays do cross the axis and the focus is said to be real. If the light came from the opposite direction it would be seen that there is a principal focus on the other side, that is there are two principal foci, one on each side of the lens. These two foci are both principal foci, but they will be equally distant from the center of the lens only when the curvature of the two lens surfaces are equal. There may be foci on secondary axes also, and each focus on a secondary axis has its conjugate. In the formation of images the image is the conjugate of the object and conversely the object is the conjugate of the image.

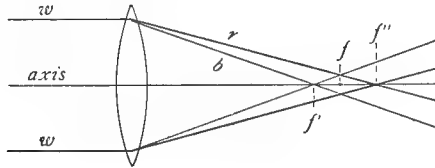

FIG. 12.—Double Convex Lens, Showing Chromatic Aberration.

The ray of white light (w) is represented as dividing into the short waved, blue (b) and the long waved, red (r) light. The blue (b) ray comes to a focus nearer the lens and the red ray (r) farther from the lens than the principal focus (f). Principal focus (f) for rays very near the axis; f' and f'' , foci of blue and red light coming from near the edge of the lens. The intermediate wave lengths would have foci all the way between f' and f'' .

§ 8. **Chromatic Aberration.**—This is due to the fact that ordinary light consists of waves of varying length, and as the effect of a lens is to change the direction of the waves, it changes the direction of the short waves more markedly than the long waves. Therefore, the short waved, blue light will cross the axis sooner than the long waved, red light, and there will result a superposition of colored images, none of which are perfectly distinct (Fig. 12).

§ 9. **Spherical Aberration.**—This is due to the unequal turning of the light in different zones of a lens. The edge of the lens refracts proportionally too much and hence the light will cross the axis or come to a focus nearer the lens than a ray which is nearer the middle of the lens. Thus, in Fig. 13, if the focus of parallel rays very near the axis is at f , rays ($o i$), nearer the edge, would come to a focus nearer the lens, the focus of the ray nearest the edge being nearest the lens.

§ 10. **Correction of Chromatic and of Spherical Aberration.**—Every simple lens has the defect of both chromatic and spherical aberration, and to overcome this, kinds of glass of different refractive power and different dispersive power are combined, concave lenses neutralizing the defects of convex lenses. If the concave lens is not sufficiently strong to neutralize the aberra-

FIG. 13. *The ray (o) near the edge of the lens is brought to a focus nearer the lens than the ray (i). Both are brought to a focus sooner than rays very near the axis. (f) Principal focus for rays very near the axis; (f') Focus for the ray (i), and (f'') Focus for the ray (o). Intermediate rays would cross the axis all the way from (f' to f).*

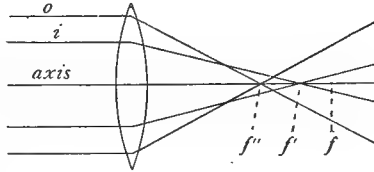

FIG. 13. *Double Convex Lens, showing Spherical Aberration.*

tions of the convex lens, the combination is said to be *under-corrected*, while if it is too strong and brings the marginal rays or the blue rays to a focus beyond the true principal focus, the combination is *over-corrected*.

In Newton's time there was supposed to be a direct proportion between the refractive power of any transparent medium and its dispersive power (*i. e.* its power to separate the light into colors). If this were true then the contention of Newton that it would be impossible to do away with the color without at the same time doing away with the refraction would be true and useful achromatic combinations would be impossible. It was found by experiment, however, that there is not a direct ratio between the refractive and dispersive powers for the different colors in different forms of glass, so that it is possible to do away largely with chromatic aberration and retain sufficient refraction to make the combination serve for the production of images. (See also the discussion under apochromatic objectives § 25.)

Probably no higher technical skill is used in any art than is requisite in the preparation of microscopical objectives, oculars and illuminators.*

§ 11. **Geometrical Construction of Images.**—As shown in Figs. 14-15, for the determination of any point of an image, or the image being known, to determine the corresponding part of the object, it is necessary to know the position of the principal focus (and there is one on each side of the lens, § 7), and the optical center of the lens (Figs. 1-9). Then a secondary axis (2) in Fig. 14, (1) in Fig. 15, is drawn from the extremity of the object and prolonged indefinitely above the lens, or below it for virtual images. A second line is drawn from the extremity of the object, (3) in Fig. 14, (2) in Fig. 15, to the lens parallel with the principal axis. After traversing the lens it must be drawn through the principal focal point. If now it is prolonged it will cross the secondary axis above the lens for a real image and below for a virtual

image. The crossing point of these lines determines the position of the corresponding part of the image. Commencing with any point of the object the corresponding point of the image may be determined as just described, and conversely commencing with the image, corresponding points of the object may be determined.

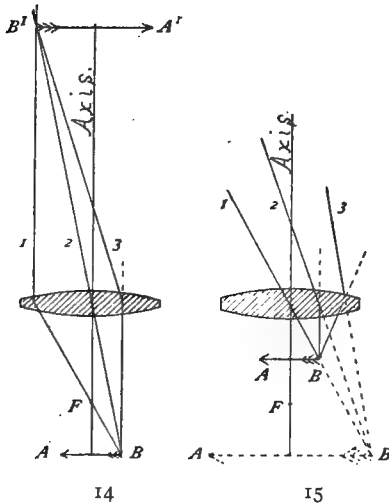

FIGS. 14 AND 15. 14. Convex lens showing the position of the object ($A-B$) outside the principal focus (F), and the course of the rays in the formation of real images. To avoid confusion the rays are drawn from only one point.

$A B$. Object outside the principal focus. $B' A'$. Real, enlarged image on the opposite side of the lens.

Axis. Principal optic axis. 1, 2, 3. Rays after traversing the lens. They are converging, and consequently form a real image. The dotted line and the line (2) give the direction of the rays as if unaffected by the lens. (F). The principal focus.

FIG. 15. Convex lens, showing the position of the object ($A B$) within the principal focus and the course of the rays in the formation of a virtual image.

$A B$. The object placed between the lens and its focus; $A' B'$ virtual image formed by tracing the rays backward. It appears on the same side of the lens as the object, and is erect (§ 11).

Axis. The principal optic axis of the lens. F . The principal focus.

1, 2, 3. Rays from the point B of the object. They are diverging after traversing the lens, but not so divergent as if no lens were present, as is shown by the dotted lines. Ray (1) traverses the center of the lens, and is therefore not deflected. It is a secondary axis (§ 6).

SIMPLE MICROSCOPE : EXPERIMENTS

§ 12. Employ a tripod or other simple microscope, and for object a printed page. Hold the eye about two centimeters from the upper surface of the magnifier, then alternately raise and lower

the magnifier until a clear image may be seen. (This mutual arrangement of microscope and object so that a clear image is seen, is called focusing.) When a clear image is seen, note that the letters appear as with the unaided eye except that they are larger, and the letters appear erect or right side up, instead of being inverted, as with the compound microscope (§ 15, Fig. 15).

FIG. 16. Diagram of the simple microscope showing the course of the rays and all the images, and that the eye forms an integral part of it.

$A^1 B^1$. The object within the principal focus. $A^2 B^2$. The virtual image on the same side of the lens as the object. It is indicated with dotted lines, as it has no actual existence.

$B^2 A^2$. Retinal image of the object ($A^1 B^1$). The virtual image is simply a projection of the retinal image in the field of vision.

Axis. The principal optic axis of the microscope and of the eye. *Cr*. Cornea of the eye. *L*. Crystalline lens of the eye. *R*. Ideal refracting surface at which all the refractions of the eye may be assumed to take place.

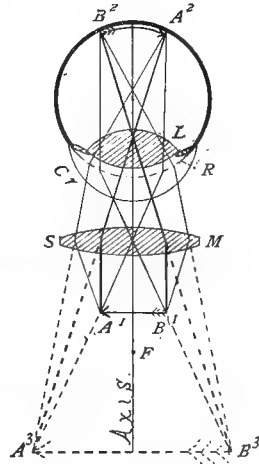

§ 13. Obtaining the Principal Focus.—Hold the simple microscope directly toward the sun and move it away from and toward a piece of printed paper until the smallest bright point is obtained. This is the burning point or focus and as the rays of the sun are nearly parallel, the burning point represents approximately the principal focus (Fig. 11). The above and following operations are more easily accomplished if the lens is supported as in Fig. 22.

§ 14. Real and Virtual Images with a Simple Microscope.—Without changing the position of the magnifier or paper look into the magnifier, holding the eye close to the upper surface and the letters on the paper may be seen, but they will appear much sharper to the eyes of most people if the magnifier is brought nearer to the paper, that is so that the printed paper is within the principal focal distance (Fig. 15 and 16).

After getting as clear an image as possible by focusing the simple microscope, raise the magnifier until the letters are at a dis-

tance a little greater than the principal focal distance. Look into the magnifier and note the clearness of the virtual image, then slowly elevate the head above the magnifier and when the eye is about 60 to 100 centimeters above the lens a real image can be seen. That is an image in which the letters are inverted as with the objective of the compound microscope (see § 60). If the magnifier is raised somewhat so that the printed letters are markedly without the principal focus the real image will be seen more clearly especially if the eye is brought somewhat near the magnifier. The above experiments show two things.

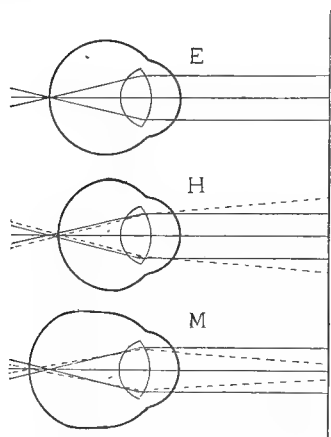

FIG. 17. *Figures of a normal (emmetropic), a far sighted (hyperopic) and a short sighted (myopic) eye to show that when the eye is at rest the normal eye (E) focuses parallel rays on the retina while the far-sighted eye (H) focuses parallel rays beyond the retina. The short sighted eye (M) focuses parallel rays in front of the retina. The dotted lines show that in the hyperopic eye the rays must be converging to come to a focus on the retina while with the myopic eye they must be diverging.*

(1) That every convex or converging lens or lens system can serve to form either a virtual or a real image, depending upon its position with reference to the object.

(2) They show also that without changing the position of the magnifier, if it is slightly further from the object than its principal focal distance, either a virtual image or a real image may be seen by many people, depending upon the position of the eye. (a) If the eye is close to the magnifier an enlarged erect virtual image will be seen. (b) With the eye at a considerable distance an enlarged inverted real image may be seen.

While the law is absolute that real images are formed only when the object is without the principal focal distance, and virtual images only when the object is within the focus, the above experiments show most conclusively that the eye is a part of the optical

arrangement when the microscope is actually used for observation, and that the microscope with the eye is a different apparatus from the microscope considered by itself.

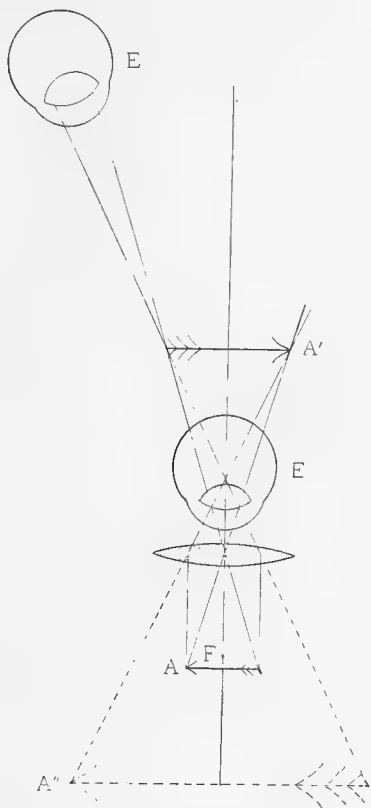

FIG. 18. *Figure to show that with a simple microscope if the object is slightly beyond the principal focus (F) a real image will be formed at A' which can be seen by an eye at E, and that if a normal or hyperopic eye is at E' a virtual image can be seen without changing the position of the simple microscope. The long-sighted eye can see this image best as it naturally focuses converging rays on the retina. The myopic eye either sees no image at all, or a mere blur, depending upon the amount of myopia. A. object; A.' real image above the magnifier; A.'' virtual image which can be seen below the lens by an eye at E'; E. eye in position to see a real image; E.' eye in position to see A'' a virtual image; F. principal focus of the magnifier.*



FIG. 19. *Tripod Magnifier*

The diagrams, Figs. 17, 18, are introduced to show under what conditions both a virtual and a real image may be seen without changing the position of the magnifier or the object.

Simple microscopes are very convenient when only a small magnification (Ch. IV) is desired, as for dissecting. Achromatic triplets are excellent and convenient for the pocket. For use in conjunction with a compound microscope, the tripod magnifier (Fig. 19) is one of the best forms. For many purposes a special mechanical mounting is to be preferred.

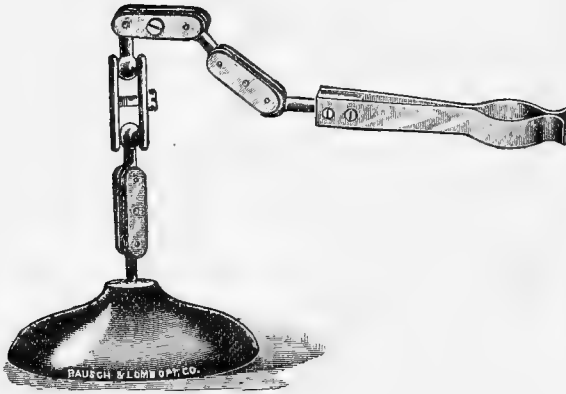

FIG. 20 *Lens-holder.*

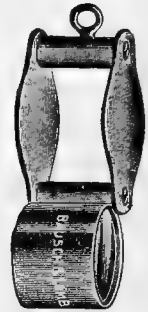

FIG. 21. *The Hastings Triplet.*

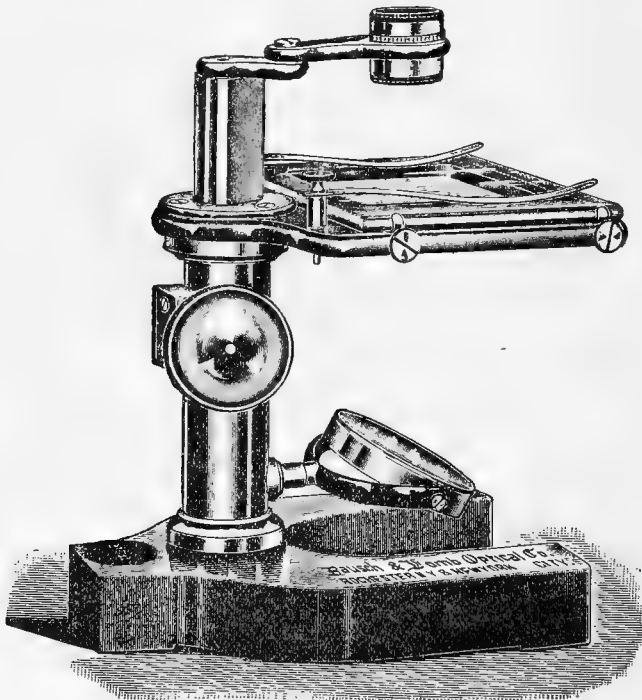
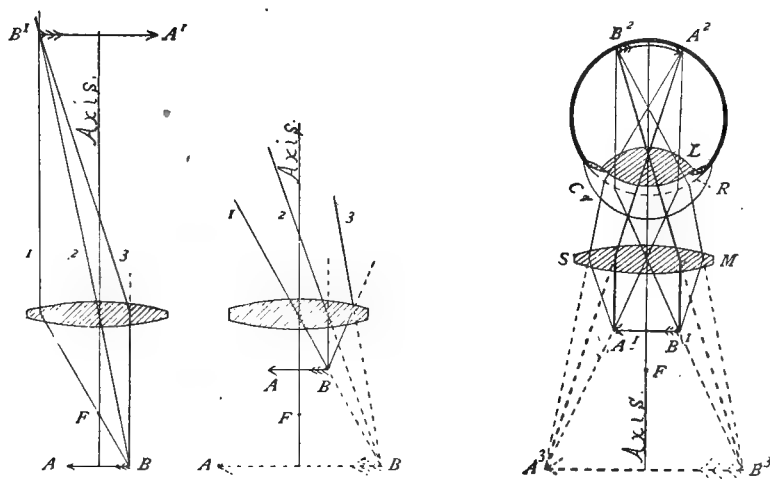

FIG. 22. *Dissecting Microscope.*



FIGS. 23, 24, 25. Diagrams showing the formation of real and of virtual images and of the retinal image in using the simple microscope. See the explanation of Figs. 14, 15, 16.

COMPOUND MICROSCOPE

§ 15. **A Compound Microscope.**—This enables one to see an enlarged, inverted image. It always consists of two optical parts—an *objective*, to produce an enlarged, inverted, real image of the object, and an *ocular* acting in general like a simple microscope to magnify this real image (Fig. 26). There is also usually present a mirror, or both a mirror and some form of condenser or illuminator for lighting the object. The stand of the microscope consists of certain mechanical arrangements for holding the optical parts and for the more satisfactory use of them. (See frontispiece.)

§ 16. **The Mechanical Parts** of a laboratory, compound microscope are shown in the frontispiece, and are described in the explanation of that figure. The student should study the figure with a microscope before him and become thoroughly familiar with the names of all the parts.

OPTICAL PARTS

§ 17. **Microscopic Objective.**—This consists of a converging lens or of one or more converging lens-systems, which give an enlarged, inverted, real image of the object (Figs. 14, 26). And as for the formation of real images in all cases, the object must be placed outside the principal focus, instead of within it, as for the simple microscope. (See §§ 12, 60, Figs. 16, 26.)

Modern microscopic objectives usually consist of two or more systems or

combinations of lenses, the one next the object being called the *front combination* or lens, the one farthest from the object and nearest the ocular, the *back combination* or system. There may be also one or more intermediate systems.

Each combination is, in general, composed of a convex and a concave lens. The combined action of the system serves to produce an image free from color and from spherical distortion. In the ordinary achromatic objectives of the older period the convex lenses are of crown and the concave lenses of flint glass. In the best modern achromatic objectives the new Jena glass is used for a part or all of the lenses. (Figs. 27, 28.)

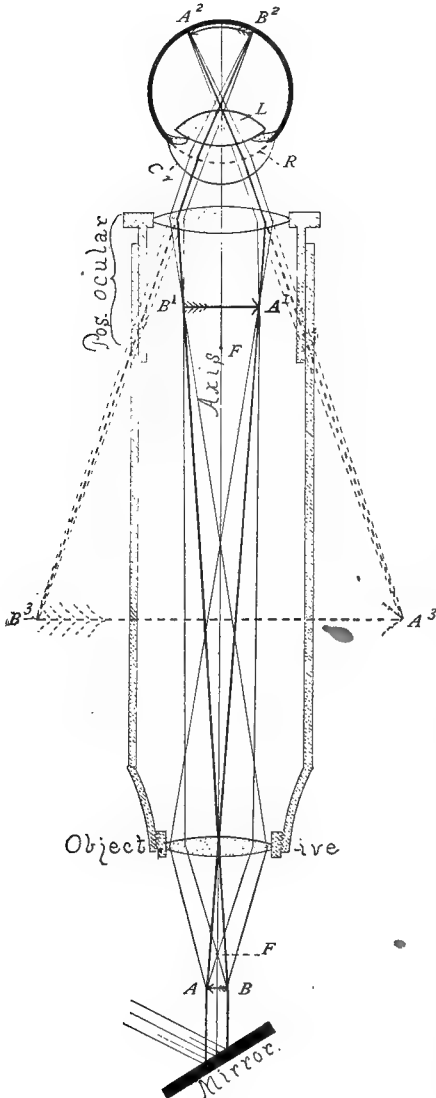

FIG. 26. Diagram showing the principle of a compound microscope with the course of the rays from the object (AB) through the objective to the real image ($B'A'$), thence through the ocular and into the eye to the retinal image (A^2B^2), and the projection of the retinal image into the field of vision as the virtual image (B^3A^3).

AB . The object. A^2B^2 . The retinal image of the inverted real image, ($B'A'$), formed by the objective. B^3A^3 . The inverted virtual image, a projection of the retinal image.

Axis. The principal optic axis of the microscope and of the eye.

Cr. Cornea of the eye. *L.* Crystalline lens of the eye. *R.* Single, ideal, refracting surface at which all the refractions of the eye may be assumed to take place.

F. F. The principal focus of the positive ocular and of the objective.

Mirror. The mirror reflecting parallel rays to the object. The light is central. See Ch. II.

Pos. Ocular. An ocular in which the real image is formed outside the ocular. Compare the positive ocular with the simple microscope (Fig. 16).

NOMENCLATURE OR TERMINOLOGY OF OBJECTIVES

§ 18. **Equivalent Focus.**—In America, England, and now also on the Continent, objectives are designated by their equivalent focal length. This length is given either in inches (usually contracted to in.) or in millimeters (mm.) Thus: An objective designated $\frac{1}{2}$ in. or 2 mm., indicates that the objective produces a real image of the same size as is produced by a simple converging lens whose principal focal distance is $\frac{1}{2}$ inch or 2 millimeters (Fig. 11). An objective marked 3 in. or 75 mm., produces approximately the same sized real image as a simple converging lens of 3 inches or 75 millimeters focal length. And in accordance with the law that the relative size of object and image vary directly as their distance from the center of the lens (Figs. 14, 15, see Ch. IV,) it follows that the less the focal distance of the simple lens or of the equivalent focal distance of the objective, the greater is the size of the real image, as the tube-length remains constant and the image in all cases is formed at 160 or 250 mm. from the objective.

§ 19. **Numbering or Lettering Objectives.**—Instead of designating objectives by their equivalent focus, many Continental opticians use letters or figures for this purpose; in most cases, however, the equivalent focus is also

FIG. 27. Section of a dry objective showing working distance and lighting by reflected light.

Axis. The principal optic axis of the objective.

B. C. Back Combination, composed of a plano-concave lens of flint glass (F), and a double convex lens of crown glass (c).

F. C. Front Combination.

C, O, sl. The cover-glass, object and slide.

Mirror. The mirror is represented as above the stage, and as reflecting parallel rays from its plane face upon the object.

Stage. Section of the stage of the microscope.

W. The Working Distance, that is the distance from the front of the objective to the object when the objective is in focus.

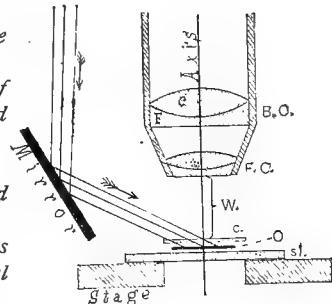

given. With this method the smaller the number, or the earlier in the alphabet the letter, the lower is the power of the objective. (See further in Ch. IV, for the power or magnification of objectives.) This method is entirely arbitrary.

trary and does not, like the one above, give direct information concerning the objective.

§ 20. **Air or Dry Objectives.**—These are objectives in which the space between the front of the objective and the object or cover-glass is filled with air (Fig. 27). Most objectives of low and medium power (*i. e.*, $\frac{1}{8}$ in. or 3 mm. and lower powers) are dry.

§ 21. **Immersion Objectives.**—An immersion objective is one with which there is some liquid placed between the front of the objective and the object or cover-glass. The most common immersion objectives are those (A) in which water is used as the immersion fluid, and (B) where some liquid is used having the same refractive and dispersive power as the front lens of the objective. Such a liquid is called homogeneous, as it is optically homogeneous with the front glass of the objective. It may consist of thickened cedar wood oil or glycerin containing some salt, as stannous chlorid in solution. When oil is used as the immersion fluid the objectives are frequently called oil immersion objectives. The disturbing effect of the cover-glass (Fig. 64) is almost wholly eliminated by the use of homogeneous immersion objectives, as the rays undergo very little or no refraction on passing from the cover-glass through the immersion medium and into the objective; and when the object is mounted in balsam there is practically no refraction in the ray from the time it leaves the balsam till it enters the objective.

FIG. 28. *Sectional view of an Immersion, Adjustable Objective, and the object lighted with axial or central and with oblique light.*

Axis. The principal optic axis of the objective.

B C, M C, F C. The back, middle and front combination of the objective. In this case the front is not a combination, but a single plano-convex lens.

A, B. Parallel rays reflected by the mirror axially or centrally upon the object.

C. Ray reflected to the object obliquely.

I. Immersion fluid between the front of the objective and the cover glass or object (O).

Mirror. The mirror of the microscope.

O. Object. It is represented without a cover-glass. Ordinarily objects are covered whether examined with immersion or with dry objectives.

Stage. Section of the stage of the microscope.

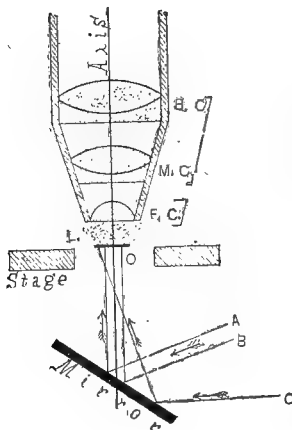

§ 22. **Non-Achromatic or Chromatic Objectives.**—These are objectives in which the chromatic aberration is not corrected, and the image produced is bordered by colored fringes. They show also spherical aberration and are used only on very cheap microscopes. (§§ 8, 9, Figs. 12, 13.)

§ 23. **Achromatic Objectives.**—In these the chromatic and the spherical aberration are both largely eliminated by combining concave and convex lenses of different kinds of glass “so disposed that their opposite aberrations shall correct each other.” All the better forms of objectives are achromatic and also aplanatic. That is, enough of the various spectral colors come approximately to the same focus to give white light. (See also under apochromatics, § 25.)

§ 24. **Aplanatic Objectives, etc.**—These are objectives or other pieces of optical apparatus (oculars, illuminators, etc.), in which the spherical distortion is wholly or nearly eliminated, and the curvatures are so made that the central and marginal parts of the objective focus rays at the same point or level. Such pieces of apparatus are usually achromatic also.

§ 25. **Apochromatic Objectives.**—A term used by Abbe to designate a form of objective made by combining new kinds of glass with a natural mineral (Calcium fluorid, Fluorite, or Fluor spar 1886*). The name, Apochromatic, is used to indicate the higher kind of achromatism in which rays of three spectral colors are combined at one focus, instead of rays of two colors as in the ordinary achromatic objectives. Some of the early apochromatics deteriorated rather quickly in hot moist climates. Those now made are quite permanent.

The special characteristics of these objectives, when used with the “compensating oculars” are as follows:

(1) *Three rays* of different color are brought to one focus, leaving a small tertiary spectrum only, while with objectives as formerly made from crown and flint glass, only *two* different colors could be brought to the same focus.

(2) In these objectives the correction of the spherical aberration is obtained for *two* different colors in the brightest part of the spectrum, and the objective shows the same degree of chromatic correction for the marginal as for the central part of the aperture. In the old objectives, correction of the spherical aberration was confined to rays of *one* color, the correction being made for the central part of the spectrum, the objective remaining *under-corrected* spherically for the red rays and *over-corrected* for the blue rays (§ 10).

(3) The optical and chemical foci are identical, and the image formed by the chemical rays is much more perfect than with the old objectives, hence the new objectives are well adapted to photography.

(4) These objectives admit of the use of very high oculars, and seem to be a considerable improvement over those made in the old way with crown and flint glass. According to Dippel (*Z. w. M.* 1886, p. 300) dry apochromatic objectives give as clear images as the same power water immersion objectives of the old form.

*According to F. J. Keeley (*Proc. Acad. Nat. Sci. Philadelphia*, lvi (1904) p. 475; *Jour. Roy. Micr. Soc.* 1905, p. 103) a $\frac{1}{4}$ in. objective made by Chas. A. Spencer in 1860 contained a fluorite lens in one of the combinations.

§ 26. **Non-Adjustable or Unadjustable Objectives.**—Objectives in which the lenses or lens systems are permanently fixed in their mounting so that their relative position always remains the same. Lower power objectives and those with homogenous immersion are mostly non-adjustable. For beginners and those unskilled in manipulating adjustable objectives (§ 27), non-adjustable ones are more satisfactory, as the optician has put the lenses in such a position that the most satisfactory results may be obtained when the proper thickness of cover-glass and tube-length are employed. (See table of tube-length and thickness of cover-glass below (§ 34).

§ 27. **Adjustable Objectives.**—An adjustable objective is one in which the distance between the systems of lenses (usually the front and the back systems) may be changed by the observer at pleasure. The object of this adjustment is to correct or compensate for the displacement of the rays of light produced by the mounting medium and the cover-glass after the rays have left the object. It is also to compensate for variations in "tube-length". See § 32. As the displacement of the rays by the cover-glass is the most constant and important, these objectives are usually designated as having cover-glass adjustment or correction. (Fig. 28. See also practical work with adjustable objectives, Ch. II.)

§ 28. **Parachromatic, Pantachromatic and Semi-apochromatic Objectives.**—These are trade names for objectives, most of them containing one or more lenses of the new glass (§ 25). They are said to approximate much more closely to the apochromatics than to the ordinary objectives.

§ 29. **Variable Objective.**—This is a low power objective of 36 to 26 mm. equivalent focus, depending upon the position of the combinations. By means of a screw collar the combinations may be separated, diminishing the power, or approximated and thereby increasing it.



FIG. 29. *An objective in section, showing the different combinations formed of concave and convex lenses. Cut loaned by Voigtländer & Sohn, A. G.*

§ 30. **Projection Objectives.**—These are designed especially for projecting an image on a screen and for photo-micrography. They are characterized by having a flat, sharp field brilliantly lighted. (See Ch. IV, IX.)

§ 31. **Illuminating or Vertical Illuminating Objectives.**—These are designed for the study of opaque objects with good reflecting surfaces, like the rulings on metal bars and broken or polished and etched surfaces of metals employed in micro-metallography. The light enters the side of the tube or objective and is reflected vertically downward through the objective and thereby is concentrated upon the object. The object reflects part of the light back into the microscope thus enabling one to see a clear image. For a figure see Ch. VIII.

§ 32. **Tube-length.**—"In the construction of microscopic objectives, the corrections must be made for the formation of the image at a definite distance, or in other words the tube of the microscope on which the objective is to be used must have a definite length. Consequently the microscopist must know and use this distance or 'microscopical tube-length' to obtain the best results in using any objective in practical work." Unfortunately different opticians have selected different tube-lengths and also different points between which the distance is measured, so that one must know what is meant by the tube-length of each optician whose objectives are used. See table, § 34.

§ 33. **The Thickness of Cover-glass** used on an object (See Ch. VII, on mounting), except with homogeneous immersion objectives, has a marked effect on the light passing from the object (Fig. 64). To compensate for this the position of the systems composing the objective are closer together than they would be if the object were uncovered. Consequently in non-adjustable objectives some standard thickness of cover-glass is chosen by each optician and the position of the systems arranged accordingly. With such an objective the image of an uncovered object would be less distinct than a covered one, and the same result would follow the use of a cover-glass much too thick.

§ 34. In the following tables tube-length *b-d* of the diagram greatly preponderates, and a large majority of unadjustable objectives are corrected for a thickness of cover-glass falling between fifteen and twenty hundredths of a millimeter (0.15-0.20 mm.).

* The information contained in the tables on the following page was very kindly furnished by the opticians named, or obtained by consulting catalogs. In most of the later catalogs the information is definite, and many makers now not only put their names and the equivalent focal length on their objectives, but they add the numerical aperture (§ 36) and the tube-length for which the objective is corrected. This is in accordance with the recommendations of the author in the original paper on "tube-length," (Proc. Amer. Soc. Micr., Vol. IX., p. 168, also by Edward Bausch, Vol. XII., p. 43). If the table in this edition is compared with the original table or with that in the previous editions of this book some differences will be noted, the changes being in the direction of uniformity and in general in the direction recommended by the writer and Mr. Edward Bausch and the committee of the American Microscopical Society. The recommendations of the committee were published in the Proceedings, Vol. XII. p. 250.

Length in Millimeters and Parts included in the "Tube-Length" by Various Opticians.

Pts. included in "Tube- Length." See Diagram.	"Tube-Length" in Millimeters.
	Chas. Baker, London, England 150 or 250 mm. The Bausch & Lomb Optical Co., Rochester, N. Y. 160 mm. R. & J. Beck, London, England 160 or 220 mm. Bézu, Hausser & Cie, Paris, France 180 mm. Klönne und Müller, Berlin, Germany 160 or 250 mm. Queen & Co., Incorporated, Phila., Pa. 170 mm. Ross, Ltd, London, England 160 or 254 mm. W. und H. Seibert, Wetzlar, Germany 170 mm. Swift & Son, London, England 160 or 228 mm. Voigtländer und Sohn, A. G. 160 mm. Watson & Sons, London, England 160 or 250 mm. R. Winkel, Goettingen, Germany 192 mm. Carl Zeiss, Jena, Germany 160 or 250 mm.
	Ernst Leitz, Wetzlar, Germany 170 mm. Nachtet et Fils, Paris, France 160 mm. Powell & Lealand, London, England 254 mm. C. Reichert, Vienna, Austria 160-180 mm. Spencer Lens Company, Buffalo, N. Y. 160 mm.
	E. Hartnack, Potsdam, Germany 160 mm. Dollond & Co., London, England 165, 240 mm. Véric (Stiassnie) Paris, France 160-200 mm. P. Wächter, Berlin-Friedenau, Germany 160 mm. J. Zentmayer, Philadelphia, Pa. 160 or 235 mm.

FIG. 30

Thickness of Cover-Glass for Which Non-Adjustable Objectives are Corrected by Various Opticians.

0.18 mm.	{ The Bausch & Lomb Optical Co., Rochester, N. Y. { Klönne und Müller, Berlin, Germany. { Queen & Co., Incorporated, Philadelphia, Pa. { The Spencer Lens Co., Buffalo, N. Y. { Voigtländer und Sohn, A. G. Brunswick, Germany.
0.17 mm.	{ Ernst Leitz, Wetzlar, Germany. { P. Wächter, Berlin-Friedenau, Germany. { R. Winkel, Goettingen, Germany.
0.15 mm.	{ Chas. Baker, London, England. { R. & J. Beck, Ltd., London, England. { W. und H. Seibert, Wetzlar, Germany.
0.15-0.18 mm.	{ E. Hartnack, Potsdam, Germany. { C. Reichert, Vienna, Austria.
0.15-0.20 mm.	{ Ross, Ltd., London, England. { Véric (Stiassnie), Paris, France. { Carl Zeiss, Jena, Germany.
0.12-0.17 mm.	{ J. Zentmayer, Philadelphia, Pa.
0.10-0.15 mm.	{ Dollond & Co., London, England. { Nachtet et Fils, Paris, France.
0.10-0.12 mm.	{ Bézu Hausser & Cie, Paris, France.
0.10 mm.	{ Powell & Lealand, London, England. { Swift & Son, London, England.
0.20 mm.	{ Watson & Sons, London, England.

§ 35. **Aperture of Objectives.**—The angular aperture or angle of aperture of an objective is the “angle contained, in each case, between the most diverging of the rays issuing from the axial point of an object [*i. e.*, a point in the object situated on the optic axis of the microscope], that can enter the objective and take part in the formation of an image.” (Carpenter.)

In general the angle increases with the size of the lenses forming the objective and the shortness of the equivalent focal distance (§ 18). If all

FIG. 31. *The tube of a microscope with ocular micrometer and nose piece in position to show that in measuring tube-length one must measure from the eye lens to the place where the objective is attached.* (Zeiss' Catalog.)

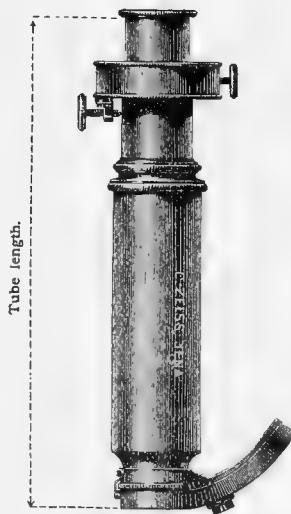

objectives were dry or all water or all homogeneous immersion a comparison of the angular aperture would give one a good idea of the relative number of image forming rays transmitted by different objectives; but as some are dry, others water and still others homogeneous immersion, one can see at a glance that, other things being equal, the dry objective (Fig 33) receives less light

FIG. 32. *Diagram illustrating the angular aperture of a microscopic objective. Only the front lens of the objective is shown.*

Axis. The principal optic axis of the objective.

BA, BC, the most divergent rays that can enter the objective, they mark the angular aperture. *ABD* or *CBD* half the angular aperture. This is designated by *u* in making Numerical Aperture computations. See the table, (§ 39).

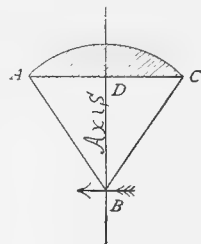

than the water immersion, and the water immersion (Fig. 34) less than the homogeneous immersion (Fig. 35). In order to render comparison accurate between different kinds of objectives, Professor Abbe takes into consideration

the rays actually passing from the back combination of the objectives to form the real image; he thus takes into account the medium in front of the objective as well as the angular aperture. The term "*Numerical Aperture*," (*N. A.*) was introduced by Abbe to indicate the capacity of an optical instrument "for receiving rays from the object and transmitting them to the image".

§ 36. **Numerical Aperture** (abbreviated *N. A.*), as now employed for microscope objectives, is the ratio of the semi-diameter of the emergent pencil to the focal length of the lens. Or as the factors are more readily obtainable it is simpler to utilize the relationship shown in the La Grange-Helmholtz-Abbe formula, and indicate the aperture by the expression: $N. A. = n \sin u$. In this formula n is the index of refraction of the medium in front of the objective (air, water or homogeneous liquid), $\sin u$ is the sine of half the angle of aperture (Fig. 32, D B A). For the mathematical discussion showing that the expressions

$\frac{\text{semi-diameter of emergent pencil}}{\text{focal length of the lens}} = n \sin u$, the student is referred to the *Journal of the Royal Microscopical Society*, 1881, pp. 392-395, 1898, p. 363.

§ 37. **Comparison of Dry and Immersion Objectives.**—For example, take three objectives each of 3 mm. equivalent focus, one being a dry, one a water immersion, and one a homogeneous immersion. Suppose that the dry objective has an angular aperture of 106° , the water immersion of 94° and the homogeneous immersion of 90° . Simply compared as to their angular aperture, without regard to the medium in front of the objective, it would look as if the dry objective would actually take in and transmit a wider pencil of light than either of the others. However, if the medium in front of the objective is considered, that is to say, if the numerical instead of the angular apertures are compared, the results would be as follows: Numerical Aperture of a dry objective of 106° , $N. A. = n \sin u$. In the case of dry objectives the medium in front of the objective being air, the index of refraction is unity, whence $n = 1$. Half the angular aperture is $\frac{1}{2}106^\circ = 53^\circ$. By consulting a table of natural sines it will be found that the sine of 53° is 0.799, whence $N. A. = n$ or $1 \times \sin u$ or $0.799 = 0.799$.*

*§ 38. **Interpolation.**—In practice, as in solving problems similar to those on the following pages and those in refraction if one cannot find a sine exactly corresponding to a given angle; or if one has an angle which does not correspond to any sine or angle given in the table, the sine or angle may be closely approximated by the method of interpolation, as follows: Find the sine in the table nearest the sine whose angle is to be determined. Get the difference of the sines of the angles greater and less than the sine whose angle is to be determined. That will give the increase of sine for that region of the arc for 15 minutes. Divide this increase by 15 and it will give with approximate accuracy the increase for 1 minute. Now get the difference between the sine whose angle is to be determined and the sine just below it in value. Divide this difference by the amount found necessary for an increase in angle of 1 minute and the quotient will give the number of minutes the sine is greater than the

FIGS. 33, 34, 35 are somewhat modified from *Ellenberger*, and are introduced to illustrate the relative amount of utilized light, with dry, water immersion and homogeneous immersion objectives of the same equivalent focus. The point from which the rays emanate is in air in each case. If Canada balsam were beneath the cover-glass in place of the air there would be practically no refraction of the rays on entering the cover-glass (§ 21).

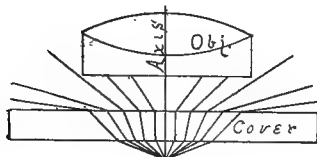

FIG. 33. Showing the course of the rays passing through a cover-glass from an axial point of the object, and the number that finally enter the front of a dry objective.

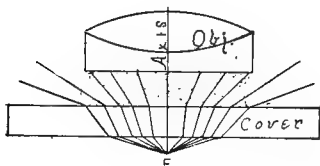

FIG. 34. Rays from the axial point of the object traversing a cover of the same thickness as in Fig. 33, and entering the front lens of a water immersion objective.

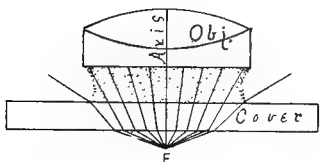

FIG. 35. Rays from an axial point of the object traversing a cover-glass and entering the front of a homogeneous immersion objective.

next lower sine whose angle is known. Add this number of minutes to the angle of the next lower sine and the sum will represent the desired angle. Or if the sine whose angle is to be found is nearer in size to the sine just greater, proceed exactly as before, getting the difference in the sines, but subtract the number of minutes of difference and the result will give the angle sought. For example take the case in Section 108 where the sine of the angle of $28^{\circ} 54'$ is given as 0.48327. If one consults the table the nearest sines found are 0.48099, the sine of $28^{\circ} 45'$, and 0.48481, the sine of 29° . Evidently then the angle sought must lie between $28^{\circ} 45'$, and 29° . If the difference between 0.48481 and 0.48099 is obtained, $0.48481 - 0.48099 = 0.00382$, and if this increase for 15' be divided by 15 it will give the increase for 1 minute; $0.00382 \div 15 = 0.000254$. Now the difference between the sine whose angle is to be found and the next lower sine is $0.48327 - 0.48099 = 0.00228$. If this difference be divided by the amount found necessary for 1 minute it will give the total minutes above $28^{\circ} 45'$, $0.00228 \div 0.000254 = 9$. That is, the angle sought is 9 minutes greater than $28^{\circ} 45' = 28^{\circ} 54'$.

With the water immersion objective the medium in front is water, and its index of refraction is 1.33, whence $n=1.33$. Half the angular aperture is $\frac{92}{2}^\circ=47^\circ$, and by the table the sine of 47° is found to be 0.731, *i. e.*, $\sin u=0.731$, whence N. A. $=n$ or $1.33 \times \sin u$ or $0.731=0.972$.

With the oil immersion in the same way N. A. $=n \sin u$; n or the index of refraction of the homogeneous fluid in front of the objective is 1.52, and the semi-angle of aperture is $\frac{90}{2}^\circ=45^\circ$. The sine of 45° is 0.707, whence N. A. $=n$ or $1.52 \times \sin u$ or $0.707=1.074$.

By comparing these numerical apertures: Dry 0.799, water 0.972, homogeneous immersion 1.074, the same idea of the real light efficiency and image power of the different objectives is obtained, as in the graphic representations shown in Figs. 33-35.

If one knows the numerical aperture (N. A.) of an objective the angular aperture is readily determined from the formula; and one can determine the equivalent angles of objectives used in different media (*i. e.*, dry or immersion). For example, suppose each of three objectives has a numerical aperture (N. A.) of 0.80, what is the angular aperture of each? Using the formula of N. A. $=n \sin u$, one has N. A. $=0.80$ for all the objectives. For the dry objective $n=1$ (Refractive index of air).

For the water immersion objective $n=1.33$ (Refractive index of water).

For the homogeneous immersion objective $n=1.52$ (Refractive index of homogeneous liquid). And $2u$ is to be found in each case.

For the dry objective, substituting the known values the formula becomes $0.80=1 \sin u$, or $\sin u=0.80$. By inspecting the table of natural sines (3d page of cover) it will be found that 0.80 is the sine of 53 degrees and 8 minutes. As this is half the angle the entire angular aperture of the dry objective must be $53^\circ 8' \times 2=106^\circ 16'$.

For the water immersion objective, substituting the known values in the formula as before: $0.80=1.33 \sin u$, or $\sin u=\frac{0.80}{1.33}=0.6015$.

Consulting the table of sines as before, it will be found that 0.6015 is the sine of $36^\circ 59'$ whence the angular aperture (water angle) is $36^\circ 59' \times 2=73^\circ 58'$.

For the homogeneous immersion objective, substituting the known values, the formula becomes: $0.80=1.52 \sin u$ whence $\sin u=\frac{0.80}{1.52}=0.5263$. And by

consulting the table of sines it will be found that this is the sine of $31^\circ 45\frac{1}{2}'$ whence $2u$ or the entire angle (balsam or oil angle) is $63^\circ 31'$.

That is, three objectives of equal resolving powers, each with a numerical aperture of 0.80 would have an angular aperture of $106^\circ 16'$ in air, $73^\circ 58'$ in water and $63^\circ 31'$ in homogeneous immersion liquid.

For the apparatus and method of determining aperture, see Ch. X.

‡ 39. Table of a group of Objectives with the Numerical Aperture (N. A.) and the method of obtaining it. Half the angular aperture is designated by u and the index of refraction of the medium in front of the objective by n . For

dry objectives this is air and $n=1$, for water immersions $n=1.33$, and for homogeneous immersions $n=1.52$. (For a table of natural sines, see third page of cover.)

OBJECTIVE	Angular Aperture ($2n$)	NATURAL SINE of half the angular aperture ($\sin u.$)	Index of Refraction of the medium in front of the objective (n)	NUMERICAL APERTURE (N. A.)= $n \sin u$
25 mm. Dry.	20°	$\text{Sin} \frac{20}{2} = 0.1736$	$n=1$	N. A. = $1 \times 0.1736 = 0.173$
25 mm. Dry.	40°	$\text{Sin} \frac{40}{2} = 0.3420$	$n=1$	N. A. = $1 \times 0.3420 = 0.342$
12½ mm. Dry.	42°	$\text{Sin} \frac{42}{2} = 0.3584$	$n=1$	N. A. = $1 \times 0.3583 = 0.358$
12½ mm. Dry.	100°	$\text{Sin} \frac{100}{2} = 0.7660$	$n=1$	N. A. = $1 \times 0.7660 = 0.766$
6 mm. Dry.	75°	$\text{Sin} \frac{75}{2} = 0.6087$	$n=1$	N. A. = $1 \times 0.6087 = 0.609$
6 mm. Dry.	136°	$\text{Sin} \frac{136}{2} = 0.9272$	$n=1$	N. A. = $1 \times 0.9272 = 0.927$
3 mm. Dry.	115°	$\text{Sin} \frac{115}{2} = 0.8434$	$n=1$	N. A. = $1 \times 0.8434 = 0.843$
3 mm. Dry.	163°	$\text{Sin} \frac{163}{2} = 0.9890$	$n=1$	N. A. = $1 \times 0.9890 = 0.989$
2 mm. Water Immersion	96° 12'	$\text{Sin} \frac{96^{\circ} 12'}{2} = 0.7443$	$n=1.33$	N. A. = $1.33 \times 0.7443 = 0.99$
2 mm. Homogeneous Immersion	110° 38'	$\text{Sin} \frac{110^{\circ} 38'}{2} = 0.8223$	$n=1.52$	N. A. = $1.52 \times 0.8223 = 1.25$
2 mm. Homogeneous Immersion	134° 10'	$\text{Sin} \frac{134^{\circ} 10'}{2} = 0.9211$	$n=1.52$	N. A. = $1.52 \times 0.9210 = 1.40$

§ 40. **Significance of Aperture.**—As to the real significance of aperture in microscopic objectives, it is now an accepted doctrine that—the corrections in spherical and chromatic aberration being the same—(1) Objectives vary

directly as their numerical aperture in their ability to define or make clearly visible minute details (resolving power). For example an objective of 4 mm. equivalent focus and a numerical aperture of 0.50 would define or resolve only half as many lines to the millimeter or inch as a similar objective of 1.00 N.A. So also an objective of 2 mm. focus and 1.40 N.A. would resolve only twice as many lines to the millimeter as a 4 mm. objective of 0.70 N.A. Thus it is seen that defining power is not a result of magnification but of aperture, otherwise the 2 mm. objective would resolve far more than twice as many lines as the 4 mm. objective.

Taking the results of the researches of Abbe as a guide to visibility with the microscope, one has the general formula $2\lambda \times \text{N.A.}$ That is twice the number of wave lengths of the light used multiplied by the numerical aperture of the objective. From this general statement it will be seen that the shorter the wave lengths of the light, the more there will be in an inch or centimeter and therefore the greater the number of lines visible in a given space. That is the kind of light used is one element and the objective the other in determining the number of lines visible under the microscope.

Following Mr. E. M. Nelson (Jour. Roy. Micr. Soc., 1893, p. 15, and 1906, p. 521) it is believed that not more than $\frac{3}{4}$ of the numerical aperture of an objective is really available for microscopic study, with a central, solid cone of light. To determine the number of lines visible in a given space with a given light the formula would become $2\lambda \times \frac{3}{4} \text{N.A.} = 3/2\lambda \text{N.A.}$ To determine the working-resolving power of any objective it is only necessary to know the number of light waves in a given space, say an inch or a centimeter and to multiply this number by $3/2 \text{N.A.}$ For example suppose one uses ordinary daylight and assumes the average wave length is $1/46666$ in., then there must be 46,666 per inch and $46,666 \times 3/2 = 70,000$ approximately. If the N.A. is 1, then the objective will resolve or make visible 70,000 lines to the inch, or approximately 28,000 to the centimeter. If blue light were used the number would be 32,000 per centimeter, or 80,000 per inch. It will be seen that the number of lines here given is smaller than that in the table of Carpenter-Dallinger, because in the latter the full aperture is supposed to be employed and the light is of the greatest available obliquity, while here only $\frac{3}{4}$ of the aperture is assumed to be available.

(2) The illuminating power of an objective of a given focus is found to vary directly as the square of the numerical aperture (N.A.)². Thus if two 4 mm. objectives of N.A. 0.20 and N.A. 0.40 were compared as to their illuminating power it would be found from the above that they would vary as $0.20^2 : 0.40^2 = 0.0400 : 0.1600$ or 1 : 4. That is the objective of 0.20 N.A. would have but $\frac{1}{4}$ the illuminating power of the one of 0.40 N.A.

(3) The penetrating power, that is the power to see more than one plane, is found to vary as the reciprocal of the numerical aperture $\frac{1}{\text{N. A.}}$ so that in an objective of a given focus the greater the aperture the less the penetrating power.

Of course when equivalent focus and numerical aperture both differ the problem becomes more complex.

While all microscopists are agreed that the fineness of detail which can be seen depends directly on the numerical aperture of the objective used, the general theory of microscopic vision has two interpretations:

(A) That it is as with the unaided eye, the telescope and the photographic camera. This is the original view and the one which many are favoring at the present day (see Mercer, Proceedings of the Amer. Micr. Soc. 1896, pp. 321-396; Wright, Gordon and Beck).

(B) The other view originated with Professor Abbe, and in the words of Carpenter-Dallinger, pp. 62, 43: "What this is becomes explicable by the researches of Abbe. It is demonstrated that microscopic vision is *sui generis*. There is and can be, *no* comparison between microscopic and macroscopic vision. The images of minute objects are not delineated microscopically by means of the ordinary laws of refraction; they are not *dioptrical* results, but depend entirely on the laws of *diffraction*. These come within the scope of and demonstrate the undulatory theory of light, and involve a characteristic change which material particles or fine structural details, in proportion to their minuteness, effect in transmitted rays of light. The change consists generally in the breaking up of an incident ray into a group of rays with large angular dispersion within the range of which periodic alternations of dark and light occur."

For a consideration of the aperture question, its history and significance, see J. D. Cox, Proc. Amer. Micr. Soc., 1884, pp. 5-39; Jour. Roy. Micr. Soc., 1881, pp. 303, 348, 365, 388; 1882, pp. 300, 460; 1883, p. 790; 1884, p. 20; 1896, p. 681; 1897, p. 71; 1898, pp. 354, 362, 592; Mercer, Proceedings Amer. Micr. Soc., 1896, pp. 321-396; Lewis Wright, Philos. Mag., June, 1898, pp. 480-503; Carpenter-Dallinger, Chapter II; Nelson, Jour. Quekett Micr. Club, VI, pp. 14-38; Jour. Roy. Micr. Soc., 1906, pp. 521-531; A. E. Wright's Principles of Microscopy; Conrad Beck, Theory of the Microscope. Gordon, Jour. Roy. Micr. Soc., 1902.

THE OCULAR

§ 41. A Microscopic Ocular or Eye-Piece consists of one or more converging lenses or lens systems, the combined action of which is, like that of a simple microscope, to magnify the real image formed by the objective.

Depending upon the relation and action of the different lenses forming oculars, they are divided into two great groups, *negative* and *positive*.

§ 42. **Negative Oculars** are those in which the real, inverted image is formed within the ocular, the lower or field-lens serving to collect the image-forming rays somewhat, so that the real image is smaller than as if the field-lens were absent (Fig. 26). As the field-lens of the ocular aids in the formation of the real image it is considered by some to form a part of the objective rather than of the ocular. The upper or eye-lens of the ocular magnifies the real image.

‡ 43. **Positive Oculars** are those in which the real, inverted image of the object is formed outside the ocular, and the entire system of ocular lenses magnifies the real image like a simple microscope (Fig. 16).

Positive and negative oculars may be readily distinguished, as the diaphragm is below the ocular lenses with the positive ocular and between the lenses in the negative ocular (Figs. 36-37).

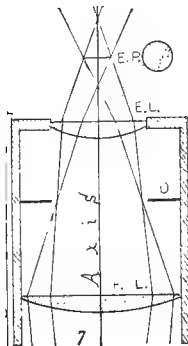

FIG. 36. Sectional view of a Huygenian ocular to show the formation of the Eye-Point.

Axis. Optic axis of the ocular. D. Diaphragm of the ocular. E. L. Eye-Lens. F. L. Field-Lens.

E. P. Eye-Point. As seen in section, it appears something like an hour-glass. When seen as looking into the ocular, i. e., in transection, it appears as a circle of light. It is at the point where the most rays cross.

TABLE OF OCULARS

‡ 44. In works and catalogs concerning the microscope and microscopic apparatus, and in articles upon the microscope in periodicals, various forms of oculars or eye-pieces are so frequently mentioned, without explanation or definition, that it seems worth while to give a list, with the French and German equivalents, and a brief statement of their character.

Achromatic Ocular; Fr. Oculaire achromatique; Ger. achromatisches Okular. Oculars in which chromatic aberration is wholly or nearly eliminated.—*Aplanatic Ocular*; Fr. Oculaire aplanatique; Ger. aplanatisches Okular (see ‡ 24).—*Binocular, stereoscopic Ocular*; Fr. Oculaire binoculaire stereoscopique; Ger. stereoskopisches Doppel-Okular. An ocular consisting of two oculars about as far apart as the two eyes. These are connected with a single tube which fits a monocular microscope. By an arrangement of prisms the image forming rays are divided, half being sent to each eye. The most satisfactory form was worked out by Tolles and is constructed on true stereotomic principles, both fields, being equally illuminated. His ocular is also erecting.—*Campani's Ocular* (see Huygenian Ocular).—*Compound Ocular*; Fr. Oculaire composé; Ger. zusammengesetztes Okular. An ocular of two or more lenses, e. g., the Huygenian (see Fig. 36).—*Continental Ocular*. An ocular mounted in a tube of uniform diameter as in Fig. 37.—*Deep Ocular*, see high ocular.—*Erecting Ocular*; Fr. Oculaire redresseur; Ger. bildumkehrendes Okular. An ocular with which an erecting prism is connected so that the image is erect as with the simple microscope. Such oculars are most common on dissecting microscopes.—*Filar micrometer Ocular*; Screw m. o., Cobweb m. o., Ger. Okular-Schraubenmikrometer. A modification of Ramsden's Telescopic Cobweb micrometer ocular.—*Goniometer Ocular*; Fr. Oculaire à goniomètre; Ger.

Goniometer-Okular. An ocular with goniometer for measuring the angles of minute crystals.—*High* Ocular, sometimes called a deep ocular. One that magnifies the real image considerably, *i. e.*, 10 to 20 fold.—*Huygenian* Ocular, Huygens' O., Campani's O., Airy's O.; Fr. Oculaire d'Huygens, o. de Campani; Ger. Huygens'sches Okular, Campanisches Okular, see § 45.—*Index* Ocular; Ger. Spitzen-O. An ocular with a minute pointer or two pointers at the level of the real image. The points are movable and serve for indicators and also, although not satisfactorily, for micrometry.—*Kellner's* Ocular, see orthoscopic ocular—*Low* ocular, also called shallow ocular. An ocular which magnifies the real image only moderately, *i. e.*, 2 to 8 fold.—*Micrometer* or *micrometric* Ocular; Fr. Oculaire micrométrique ou à micromètre; Ger. Mikrometer-Okular, Mess Okular Bénéches O., Jackson m. o., see § 48.—*Microscopic* Ocular; Fr. Oculaire microscopique; Ger. mikroskopisches Okular. An ocular for the microscope instead of one for a telescope.—*Negative* Ocular, see § 42.—*Nelson's* screw-micrometer ocular. A modification of the Ramsden's screw or cob-web micrometer in which positive compensating oculars may be used.—*Orthoscopic* Oculars; also called Kellner's Ocular; Fr. Oculaire orthoscopique; Ger. Kellner'sches oder orthoskopisches Okular. An ocular with an eye-lens like one of the combinations of an objective (Figs. 27, 29) and a double convex field-lens. The field-lens is in the focus of the eye-lens and there is no diaphragm present. The field is large and flat.—*Par-focal* Oculars, a series of oculars so arranged that the microscope remains in focus when the oculars are interchanged (Pennock, Micr. Bulletin, vol. iii, p. 9, 31, 1886).—*Periscopic* Ocular; Fr. Oculaire periscopique; Ger. periskopisches Okular. A positive ocular devised by Gundlach. It consists of a double convex field-lens and a triplet eye-lens. It gives a large, flat field.—*Positive* Ocular, see § 43.—*Projection* Ocular; Fr. Oculaire de projection; Ger. Projections-Okular, see § 47.—*Ramsden's* Ocular; Fr. Oculaire de Ramsden; Ger. Ramsden'sches Okular. A positive ocular devised by Ramsden. It consists of two plano-convex lenses placed close together with the convex surfaces facing each other. Only the central part of the field is clear. *Searching* Ocular; Fr. Oculaire d'orientation; Ger. Sucher-Okular, see § 46. *Shallow* Ocular, see low ocular.—*Solid* Ocular, *holosteric* O.; Fr. Oculaire holostère; Ger. holosterisches Okular, Vollglass-Okular. A negative eye-piece devised by Tolles. It consists of a solid piece of glass with a moderate curvature at one end for a field-lens, and the other end with a much greater curvature for an eye-lens. For a diaphragm, a groove is cut at a proper level and filled with black pigment. It is especially excellent where a high ocular is desired.—*Spectral* or *spectroscopic* Ocular; Fr. Oculaire spectroscopique; Ger. Spectral-Okular, see Microspectroscope, Ch. VI.—*Stauroscopic* Ocular; Fr. Oculaire Stauroscopique; Ger. Stauroskop-Okular. An ocular with a Bertrand's quartz plate for mineralogical purposes—*Working* Ocular; Fr. Oculaire de travail; Ger. Arbeits-Okular, see § 46.

§ 45. *Huygenian* Ocular.—A negative ocular designed by Huygens for the telescope, but adapted also to the microscope. It is the one now most commonly employed. It consists of a field-lens or collective (Fig. 36.), aid-

ing the objective in forming the real image, and an eye-lens which magnifies the real image. While the field-lens aids the objective in the formation of the real, inverted image, and increases the field of view, it also combines with the eye-lens in rendering the image achromatic.

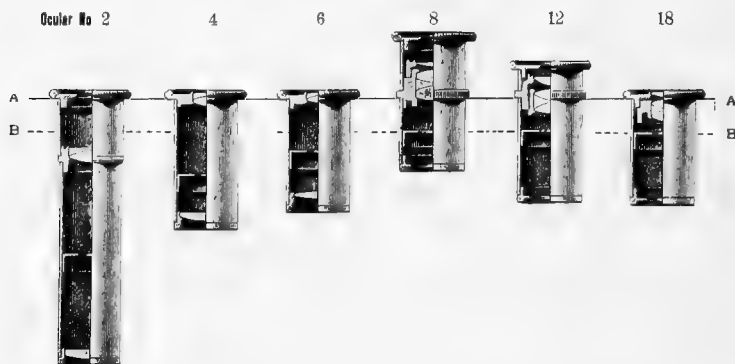

FIG. 37. *Compensating Oculars of Zeiss, with section removed to show the construction. The line A-A is at the level of the upper end of the tube of the microscope while B-B represents the lower focal points. It will be seen that the mounting is so arranged that the lower focal points in all are in the same plane and therefore the microscope remains in focus upon changing oculars. (The oculars are par-focal.) The lower oculars 2, 4 and 6 are negative, and the higher ones, 8, 12, 18, are positive. The numbers 2, 4, 6, 8, 12, 18, indicate the magnification of the ocular. From Zeiss' Catalog.*

§ 46. **Compensating Oculars.**—These are oculars specially constructed for use with the apochromatic objectives. They compensate for aberrations outside the axis which could not be so readily eliminated in the objective itself. An ocular of this kind, magnifying but twice, is made for use with high powers, for the sake of the large field in finding objects; it is called a *searching ocular*; those ordinarily used for observation are in contradistinction called *working oculars*. Part of the compensating oculars are positive and part negative. (Fig. 37.)

§ 47. **Projection Oculars.**—These are oculars especially designed for projecting a microscopic image on the screen for class demonstrations, or for photographing with the microscope. While they are specially adapted for use with apochromatic objectives, they may also be used with ordinary achromatic objectives of large numerical aperture. The projection oculars (Fig. 38) consist of a collective lens or field lens and of a carefully corrected system for the eye lens. The eye lens is movable so that a sharp image of the diaphragm between the field and eye lens may be projected upon the screen at different screen distances.

§ 48. **Micrometer Ocular.**—This is an ocular connected with an ocular

micrometer. The micrometer may be removable, or it may be permanently in connection with the ocular, and arranged with spring and screw, by which it may be moved back and forth across the field. (See Ch. IV.)

§ 49. **Spectral or Spectroscopic Ocular.**—(See Micro-Spectroscope, Ch. VI.)

DESIGNATION OF OCULARS

§ 50. **Equivalent Focus.**—As with objectives, some opticians designate the oculars by their equivalent focus (§ 15). With this method the power of

FIG. 38. *Projection Oculars with section removed to show the construction. Below are shown the upper ends with graduated circle to indicate the amount of rotation found necessary to focus the diaphragm on the screen. No. 2, No. 4. The numbers indicate the amount the ocular magnifies the image formed by the objective as with the compensation oculars. (Zeiss' Catalog.)*

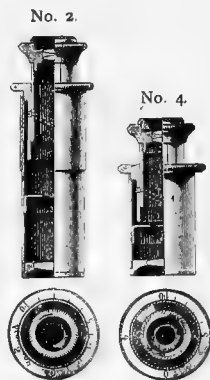

the ocular, as with objectives, varies inversely as the equivalent focal length, and therefore the greater the equivalent focal length the less the magnification. This seems as desirable a mode for oculars as for objectives and is coming more and more into use by the most progressive opticians. It is the method of designation advocated by Dr. R. H. Ward for many years, and was recommended by the committee of the American Microscopical Society, (Proc. Amer. Micr. Soc., 1883, p. 175, 1884, p. 228).

§ 51. **Numbering and Lettering.**—Oculars like objectives may be numbered or lettered arbitrarily. When so designated, the smaller the number, or the earlier the letter in the alphabet, the lower the power of the ocular.

§ 52. **Magnification.**—The compensation oculars and the Huygenian oculars of some makers are marked with the amount they magnify the real image. Thus oculars marked $\times 4$, $\times 8$, indicate that the real image of the objective is magnified four or eight fold by the ocular.

The projection oculars are designated simply by the amount they multiply the real image of the objective. Thus for the short or 160 mm. tube-length they are, $\times 2$, $\times 4$; and for the long or 250 mm. tube, they are $\times 3$ and $\times 6$. That is, the final image on the screen or the ground glass of the photographic camera will be 2, 3, 4, or 6 times greater than it would be if no ocular were used. See Ch. VIII.

§ 53. **Standard Size Oculars.**—The Royal Microscopical Society of London took a very important step (Dec. 20, 1899) in establishing standard sizes for oculars and sub-stage condensers. To quote from the Journal of the Royal Microscopical Society for 1900, p. 147 :

Resolved, "That the standard size for the inside diameter of the substage

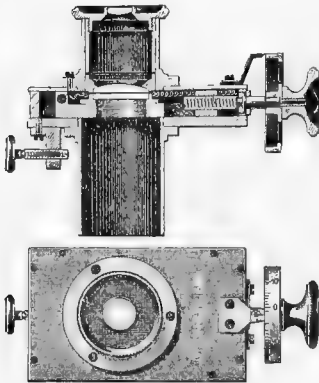

FIG. 39. *Ocular Screw-Micrometer with compensation ocular 6.* The upper figure shows a sectional view of the ocular and the screw for moving the micrometer at the right. At the left is shown a clamping screw to fasten the ocular to the upper part of the microscope tube. Below is a face view, showing the graduation on the wheel. An ocular micrometer like this is in general like the cob-web micrometer and may be used for measuring objects of varying sizes very accurately. With the ordinary ocular micrometer very small objects frequently fill but a part of an interval of the micrometer, but with this the movable cross lines traverse the object (or rather its real image) regardless of the minuteness of the object. (Zeiss' Catalog.) See also Ch. IV.

fitting be 1.527 in. = 38.786 mm. That the gauges for standardizing eye-pieces be the internal diameters of the draw-tubes, the tightness of the fit being left to the discretion of the manufacturers."

The sizes for oculars are four in number, 1 and 2 being most common.

- (1) 0.9173 inch = 23.300 mm. This is the Continental size.
- (2) 1.04 inch = 26.416 mm. This is the size used by the English opticians for student and small microscopes.
- (3) 1.27 inch = 32.258 mm. Medium size binoculars (English).
- (4) 1.41 inch = 35.814 mm. Long tube binoculars.

For the history of the Huygenian Ocular, and a discussion of formulæ for its construction, see Nelson, J. R. M. S., 1900, p. 162-169.

EXPERIMENTS

§ 54. **Putting an Objective in Position and Removing it.**—Elevate the tube of the microscope by means of the coarse adjustment, (frontispiece) so that there may be plenty of room between its lower end and the stage. Grasp the objective lightly near its lower end with two fingers of the left hand, and hold it against the nut at the lower end of the tube or the revolving nose piece.

With two fingers of the right hand take hold of the milled ring near the back or upper end of the objective and screw it into the tube of the microscope or nose piece. Reverse this operation for removing the objective. By following this method the danger of dropping the objective will be avoided.

§ 55. **Putting an Ocular in Position and Removing it.**—Elevate the body of the microscope with the coarse adjustment so that the objective will be 2 cm. or more from the object—grasp the ocular by the milled ring next the eye-lens (Fig. 37,) and the coarse adjustment or the tube of the microscope and gently force the ocular into position. In removing the ocular, reverse the operation. If the above precautions are not taken, and the oculars fit

FIG. 40. *Triple nose-piece or revolver for quickly changing objectives.*

This covered or dust proof form was originally devised by Winkel of Goettingen; it is now furnished by nearly all microscope makers. (Cut loaned by Voigtländer & Sohn, A. G.)



Microscope makers usually construct the double or triple nose-pieces and the length of the objective mounting so that in turning from one objective to another all will be approximately in focus. The objectives are then said to be par-focal.

snugly, there is danger in inserting them of forcing the tube of the microscope downward and the objective upon the object.

§ 56. **Putting an Object Under the Microscope.**—This is so placing an object under the simple microscope, or on the stage of the compound microscope, that it will be in the field of view when the microscope is in focus (§ 57).

With low powers, it is not difficult to get an object under the microscope. The difficulty increases, however, with the power of the microscope and the smallness of the object. It is usually necessary to move the object in various directions while looking into the microscope, in order to get it into the field. Time is usually saved

by getting the object in the center of the field with a low objective before putting the high objective in position. This is greatly facilitated by using a nose-piece, or revolver. (See Fig. 40 and the pictures of microscopes, Ch. II.)

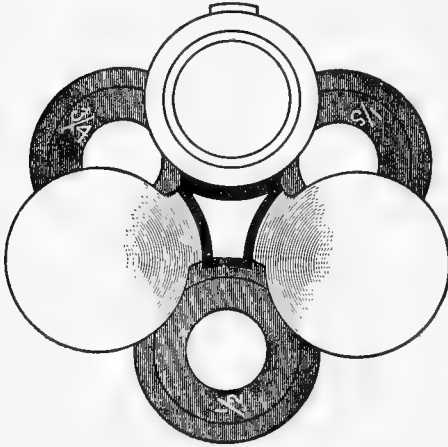

FIG. 41. *Krauss' Method of Marking Objectives on a Revolving Nose-piece.*

As seen in the figure, the equivalent focus of the objective is engraved on the diaphragm above the back lens and may be very readily seen in rotating the nose-piece. This is of great advantage, as one can see what objective is coming into place without trouble. It is also an advantage in showing where each objective belongs when the microscope comes from the manufacturers. The method is coming into general use.

§ 57. **Field or Field of View of a Microscope.**—This is the area visible through a microscope when it is in focus. When properly lighted and there is no object under the microscope, the field appears as a circle of light. When examining an object it appears within the light circle, and by moving the object, if it is sufficient size, different parts are brought successively into the field of view.

In general, the greater the magnification of the entire microscope, whether the magnification is produced mainly by the objective, the ocular, or by increasing the tube length, or by a combination of all three (see Ch. IV, under magnification), the smaller is the field.

The size of the field is also dependent, in part, without regard to magnification, upon the size of the opening in the ocular diaphragm. Some oculars, as the orthoscopic and periscopic, are so constructed as to eliminate the ocular diaphragm, and in consequence, although this is not the sole cause, the field is considerably increased. The exact size of the field may be read off directly by putting a stage micrometer under the microscope and noting the number of spaces required to measure the diameter of the light circle.

§ 58. The Size of the Field of the microscope as projected into the field of vision of the normal human eye (*i. e.*, the virtual image) may be determined by the use of the camera lucida with the drawing surface placed at the standard distance of 250 millimeters (Ch. IV.)

§ 59. Table showing the actual size in millimeters of the field of a group of commonly used objectives and oculars. Compare with the graphic representation in Fig. 42. See also § 57.

Equivalent Focus and N. A. of Objective	Diameter of Field in mm.	Equivalent Focus of Ocular	Kind of Ocular
85 mm. -----	15.4	37½ mm.	Huygenian
	10.6	25 "	
	8.3	12½ "	
45 mm. -----	7.0	37½ mm.	Huygenian
	5.0	25 "	
	4.0	12½ "	
17 mm. -----	3.0	37½ mm.	Huygenian
	2.0	25 "	
	1.6	12½ "	
N. A.=0.25	5.7	180 mm.	Compensation
	2.8	45 "	
	1.4	15 "	
	0.97	10 "	
5 mm. -----	0.541	37½ mm.	Huygenian
	0.371	25 "	
	0.290	12½ "	
N. A.=0.92	0.850	180 mm.	Compensation
	0.501	45 "	
	0.250	15 "	
	0.173	10 "	
2 mm. -----	0.270	37½ mm.	Huygenian
	0.186	25 "	
	0.147	12½ "	
N. A.=1.25	0.450	180 mm.	Compensation
	0.251	45 "	
	0.125	15 "	
	0.088	10 "	

FUNCTION OF AN OBJECTIVE

§ 60. Put a 50 mm. objective on the microscope or screw off the front combination of a 16 mm., ($\frac{2}{3}$ -in), and put the back combination on the microscope for a low objective.

Place some printed letters or figures under the microscope, and



FIG. 42. Figures showing approximately the actual size of the field with objectives of 85 mm., 45 mm., 17 mm., 5 mm. and 2 mm., equivalent focus, and an ocular of $37\frac{1}{2}$ mm. equivalent focus in each case. This figure shows graphically what is also very clearly indicated in the table (§ 59).

light well. In place of an ocular put a screen of ground glass, or a piece of lens paper, over the upper end of the tube of the microscope*

Lower the tube of the microscope by means of the coarse adjustment until the objective is within 2 to 3 cm. of the object on the stage. Look at the screen on the top of the tube, holding the head about as far from it as for ordinary reading, and slowly elevate the tube by means of the coarse adjustment until the image of the letter appears on the screen.

The image can be more clearly seen if the object is in a strong light and the screen in a moderate light, *i. e.*, if the top of the microscope is shaded.

The letters will appear as if printed on the ground glass or paper, but will be inverted (Fig. 26).

If the objective is not raised sufficiently, and the head is held too near the microscope, the objective will act as a simple microscope. If the letters are erect, and appear to be down in the microscope and not on the screen, hold the head farther from it, shade the

*§ 61. Ground Glass may be very easily prepared by placing some fine emery or carborundum between two pieces of glass, wetting it with water and then rubbing the glasses together for a few minutes. If the glass becomes too opaque, it may be rendered more translucent by rubbing some oil upon it.

screen, and raise the tube of the microscope until the letters do appear on the ground glass.

To demonstrate that the object must be outside the principal focus with the compound microscope, remove the screen and turn the tube of the microscope directly toward the sun. Move the tube of the microscope with the coarse adjustment until the burning or focal point is found (§ 7, 13). Measure the distance from the paper object on the stage to the objective, and it will represent approximately the principal focal distance (Figs. 10, 11). Replace the screen over the top of the tube, no image can be seen. Slowly raise the tube of the microscope and the image will finally appear. If the distance between the object and the objective is now taken, it will be found considerably greater than the principal focal distance (compare § 12).

§ 62 **Aerial Image.**—After seeing the real image on the ground-glass, or paper, use the lens paper over about half of the opening of the tube of the microscope. Hold the eye about 250 mm. from the microscope as before and shade the top of the tube by holding the hand between it and the light, or in some other way. The real image can be seen in part as if on the paper and in part in the air. Move the paper so that the image of half a letter will be on the paper and half in the air. Another striking experiment is to have a small hole in the paper placed over the center of the tube opening, then if a printed word extends entirely across the diameter of the tube its central part may be seen in the air, the lateral parts on the paper. The advantage of the paper over part of the opening is to enable one to accommodate the eyes for the right distance. If the paper is absent the eyes adjust themselves for the light circle at the back of the objective, and the aerial image appears low in the tube. Furthermore it is more difficult to see the aerial image in space than to see the image on the ground-glass or paper, for the eye must be held in the right position to receive the rays projected from the real image, while the granular surface of the glass and the delicate fibres of the paper reflect the rays irregularly, so that the image may be seen at almost any angle, as if the letters were actually printed on the paper or glass.

§ 63 **The Function of an Objective,** as seen from these experiments, is to form an enlarged, inverted, real image of an object,

this image being formed on the opposite side of the objective from the object (Fig. 26).

FUNCTION OF AN OCULAR

§ 64. Using the same objective as for § 53, get as clear an image of the letters as possible on the lens paper or ground-glass screen. Look at the image with a simple microscope (Fig. 19, 21) as if the image were an object.

Observe that the image seen through the simple microscope is merely an enlargement of the one on the screen, and that the letters remain inverted, that is they appear as with the naked eye (§ 12). Remove the screen and observe the aerial image with the tripod.

Put a 50 mm. (A, No. 1 or 2 in.), ocular *i. e.*, an ocular of low magnification in position (§ 55). Hold the eye about 10 to 20 millimeters from the eye-lens and look into the microscope. The letters will appear as when the simple microscope was used (see

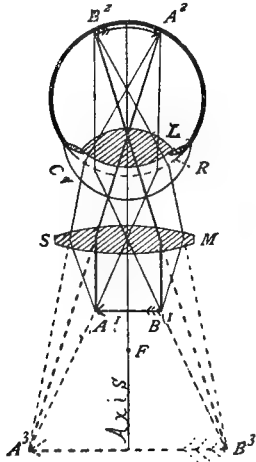

FIG. 43. *Diagram of the simple microscope showing the course of the rays and all the images, and that the eye forms an integral part of it.*

A¹ B¹. The object within the principal focus. A³ B³. The virtual image on the same side of the lens as the object. It is indicated by dotted lines, as it has no actual existence.

B² A². Retinal image of the object (A¹ B¹). The virtual image is simply a projection of the retinal image into the field of vision.

Axis. The principal optic axis of the microscope and of the eye. Cr. Cornea of the eye. L. Crystalline lens of the eye. R. Ideal refracting surface at which all the refractions of the eye may be assumed to take place.

above), the image will become more distinct by slightly raising the tube of the microscope with the coarse adjustment.

§ 65. **The Function of the Ocular**, as seen from the above, is that of a simple microscope, *viz.*: It magnifies the real image formed by the objective as if that image were an object. Compare the image formed by the ocular (Fig. 26), and that formed by a simple microscope (Fig. 43).

It should be borne in mind, however, that the rays from an object as usually examined with a simple microscope, extend from the object in all directions, and no matter at what angle the simple microscope is held, provided it is sufficiently near and points toward the object, an image may be seen. The rays from a real image, however, are continued in certain definite lines and not in all directions; hence, in order to see this aerial image with an ocular or simple microscope, or in order to see the aerial image with the unaided eye, the simple microscope, ocular or eye must be in the path of the rays (Fig. 26).

§ 66. **The field-lens** of a Huygenian ocular makes the real image smaller and consequently increases the size of the field; it also makes the image brighter by contracting the area of the real image. (Fig. 36.) Demonstrate this by screwing off the field-lens and using the eye-lens alone as an ocular, refocusing if necessary. Note that the image is bordered by a colored haze (§ 8).

When looking into the ocular with the field-lens removed, the eye should not be held so close to the ocular, as the eye-point is considerably farther away than when the field-lens is in place.

§ 67. **The eye-point.**—This is the point above the ocular or simple microscope where the greatest number of emerging rays cross. Seen in profile, it may be likened to the narrowest part of an hour glass. Seen in section (Fig. 36), it is the smallest and brightest light circle above the ocular. This is called the eye-point, for if the pupil of the eye is placed at this level, it will receive the greatest number of rays from the microscope, and consequently see the largest field.*

Demonstrate the eye-point by having in position an objective and ocular as above (§ 60). Light the object brightly, focus the microscope, shade the ocular, then hold some ground-glass or a piece of the lens paper above the ocular and slowly raise and lower it until the smallest circle of light is found. By using different oculars it will be seen that the eye-point is nearer the eye-lens in high than in low oculars, that is the eye-point is nearer the eye-lens for an ocular of small equivalent focus than for one of greater focal length.

* The bright circle above the ocular is sometimes called the Ramsden Circle or Disc. See Carpenter-Dallinger, p. 106; Spitta, 114-118; Wright p. 157; Beck, p. 14.

REFERENCES FOR CHAPTER I

In chapter X will be given a bibliography, with full titles, of the works and periodicals referred to.

For the subjects considered in this chapter, general works on the microscope may be consulted with great advantage for different or more exhaustive treatment. The most satisfactory work in English is Carpenter-Dallinger, 8th Ed. For the history of the microscope, Mayall's Cantor Lectures on the microscope are very satisfactory. For a continuation of the history begun by Mayall in the Cantor Lectures see Nelson, Journal of the Queckett Micr. Club, and the Jour. Roy. Micr. Soc., 1897-1901+. Carpenter-Dallinger, 8th Ed. Petri, Das Mikroskop.

The following special articles in periodicals may be examined with advantage:

Apochromatic Objectives, etc. Dippel in Zeit. wiss. Mikr., 1886, p. 303; also in the Jour. Roy. Micr. Soc., 1886, pp. 316, 849, 1110; same, 1890, p. 480, Zeit. f. Instrumentenk., 1890, pp. 1-6; Micr. Bullt., 1891, pp. 6-7.

Tube-length, etc. Gage, Proc. Amer. Soc. Micrs., 1887, pp. 168-172; also in the Microscope, the Jour. Roy. Micr. Soc., and in Zeit. wiss. Mikr., 1887-8. Bausch, Proc. Amer. Soc. Micrs., 1890, pp. 43-49; also in the Microscope, 1890; pp. 289-296.

Aperture. J. D. Cox, Presidential Address, Proc. Amer. Soc. Micrs., 1884, pp. 5-39, Jour. Roy. Micr. Soc., 1881, pp. 303, 348, 365, 388; 1882, pp. 300, 460; 1883, p. 790; 1884, p. 20. Czapski, Theorie der optischen Instrumente nach Abbe.

Theory of Microscopic vision, Wright, Jour. Roy. Micr. Soc. 1905 p. 1, Biography of Abbe, same, p. 156. See also the references to § 40.

CHAPTER II

LIGHTING AND FOCUSING; MANIPULATION OF DRY, ADJUSTABLE AND IMMERSION OBJECTIVES; CARE OF THE MICROSCOPE AND OF THE EYES; LABORATORY MICROSCOPES

APPARATUS AND MATERIAL FOR THIS CHAPTER

Microscope supplied with plane and concave mirror, achromatic and Abbe condensers, dry, adjustable and immersion objectives, oculars, triple nose-piece. Microscope lamp and movable condenser (bull's eye or other form, Fig. 60); Homogeneous immersion liquid, xylene, alcohol, distilled water; Mounted preparation of fly's wing (§ 79); Mounted preparation of *Pleurosigma* (§ 88, 89); Stage or ocular micrometer (§ 103); Glass slides and cover-glasses (Ch. VII); 10 per ct. solution of salicylic acid in 95 per ct. alcohol (§ 103); Preparation of stained bacteria (§ 119); Vial of equal parts olive or cotton seed oil or liquid vaselin and xylene (§ 123); Eye shade (Fig. 67); Screen for whole microscope (Fig. 66, 68).

FOCUSING

§ 68. **Focusing** is mutually arranging an object and the microscope so that a clear image may be seen.

With a simple microscope (§ 12) either the object or the microscope or both may be moved in order to see the image clearly, but with the compound microscope the object more conveniently remains stationary on the stage, and the tube or body of the microscope is raised or lowered (frontispiece).

In general, the higher the power of the whole microscope whether simple or compound, the nearer together must the object and objective be brought. With the compound microscope, the higher the objective, and the longer the tube of the microscope, the nearer together must the object and the objective be brought. If the oculars are not par-focal, the higher the magnification of the ocular, the nearer must the object and objective be brought.

§ 69. **Working Distance.**—By this is meant the space between the simple microscope and the object, or between the front lens of the compound microscope and the object, when the microscope is in focus. This working distance is always considerably less than the equivalent focal length of the objective. For example, the front-lens of a 6 mm. or $\frac{1}{4}$ in. objective would not be 6

millimeters or $\frac{1}{4}$ inch from the object when the microscope is in focus, but considerably less than that distance. If there were no other reason than the limited working distance of high objectives, it would be necessary to use a very thin cover-glass over the object. (See § 27, 33.) If too thick covers are used it may be impossible to get an objective near enough an object to get it in focus. For objects that admit of examination with high powers it is always better to use thin covers.

§ 70. **Free Working Distance**—In the microscope catalog of Zeiss there is given a table of the size of the field and also of the "free working-distance." This free working-distance is the space between the lower end of the objective and the cover glass of $\frac{1.5}{100}$ mm. thickness, when the objective is in focus on an object immediately under the cover. This is exceedingly practical information for a possessor of a microscope, and it is hoped that the other opticians will adopt the suggestion. Naturally, however, the free working-distance for each optician should be reckoned from the top of the cover for which his unadjustable objectives are corrected. If, for example, the thickness of cover for which an objective is corrected is $\frac{2.5}{100}$ mm. then the free working-distance should be that between the top of this and the objective when the objective is in focus on an object under the cover. (See the table of cover-glass thickness, § 33).

LIGHTING WITH DAYLIGHT

§ 71. Unmodified sunlight should not be employed except in special cases. North light is best and most uniform. When the sky is covered with white clouds the light is most favorable. To avoid the shadows produced by the hands in manipulating the mirror, etc., it is better to face the light; but to protect the eyes and to shade the stage of the microscope some kind of screen should be used. The one figured in (Fig. 66) is cheap and efficient. If one dislikes to face the window or lamp it is better to sit so that the light will come from the left as in reading.

It is of the greatest importance and advantage for one who is to use the microscope for serious work that he should comprehend and appreciate thoroughly the various methods of illumination, and the special appearances due to different kinds of illumination.

Depending on whether the light illuminating an object traverses the object or is reflected upon it, and also whether the object is symmetrically lighted, or lighted more on one side than the other, light used in microscopy is designated as *reflected and transmitted, axial and oblique*.

§ 72. **Reflected, Incident or Direct Light**.—By this is meant light reflected upon the object in some way and then irregularly reflected from the object to the microscope. By this kind of light objects are ordinarily seen by the unaided eye, and the objects are mostly opaque. In Vertebrate Histology, reflected light is but little used; but in the study of opaque objects, like whole insects, etc., it is used a great deal. For low powers, ordinary daylight that naturally falls upon the object, or is reflected or condensed upon it with a mirror or condensing lens, answers very well. For high powers and for

special purposes, special illuminating apparatus has been devised (§ 31). (See also Carpenter-Dallinger, Ch. IV.)

§ 73. **Transmitted Light.**—By this is meant light which passes through an object from the opposite side. The details of a photographic negative

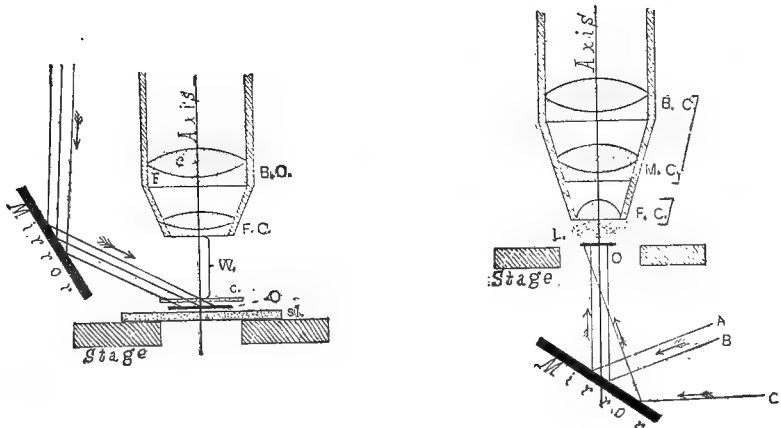

44

45

FIGS. 44-45. For full explanation see Figs. 27 and 28.

are in many cases only seen or best seen by transmitted light, while the print made from it is best seen by reflected light.

Almost all objects studied in Vertebrate Histology are lighted by transmitted light, and they are in some way rendered transparent or semi-transparent. The light traversing and serving to illuminate the object in working with a compound microscope is usually reflected from a plane or concave mirror, or from a mirror to a condenser (§ 99), and thence transmitted to the object from below (Figs. 54-57).

§ 74.—**Axial or Central Light.**—By this is understood light reaching the object, the rays of light being parallel to each other and to the optic axis of the microscope, or a diverging or a converging cone of light whose axial ray is coincident with the optic axis of the microscope. In either case the object is symmetrically illuminated.

§ 75. **Oblique Light.**—This is light in which parallel rays from a plane mirror form an angle with the optic axis of the microscope (Fig. 45). Or if a concave mirror or a condenser is used, the light is oblique when the axial ray of the cone of light forms an angle with the optic axis (Fig. 45).

DIAPHRAGMS

§ 76. **Diaphragms and their Proper Employment.**—Diaphragms are opaque disks with openings of various sizes, which are placed between the source of light or mirror and the object. In some cases an iris diaphragm is used, and then the same one is capable of giving a large range of openings. The object of a diaphragm in general, is to cut off all adventitious light and thus enable one to light the object in such a way that the light finally reaching the microscope shall all come from the object or its immediate vicinity. The diaphragms of a condenser serve to vary its aperture to the needs of each object and each objective.

§ 77. **Size and Position of Diaphragm Opening.**—When no condenser is used the size of the opening in the diaphragm should be about that of the front lens of the objective. For some objects and some objectives this rule may be quite widely departed from; one must learn by trial.

When lighting with a mirror the diaphragm should be as close as possible to the object in order, (a) that it may exclude all adventitious light from the object; (b) that it may not interfere with the most efficient illumination from the mirror by cutting off a part of the illuminating pencil. If the diaphragm is a considerable distance below the object, (1) it allows considerable adventitious light to reach the object and thus injures the distinctness of the microscope image; (2) it prevents the use of very oblique light unless it swings with the mirror; (3) it cuts off a part of the illuminating cone from a concave mirror. On the other hand, even with a small diaphragm, the whole field will be lighted.

With an illuminator or condenser (Figs. 47, 54), the diaphragm serves to narrow the pencil to be transmitted through the condenser, and thus to limit the aperture (see § 95). Furthermore, by making the diaphragm opening eccentric, oblique light may be used, or by using a diaphragm with a slit around the edge (central stop diaphragm), the center remaining opaque, the object may be lighted with a hollow cone of light, all of the rays having great obliquity. In this way the so-called dark-ground illumination may be produced (§ 103; Fig. 57).

ARTIFICIAL ILLUMINATION

§ 78. For evening work and for certain special purposes, artificial illumination is employed. A good petroleum (kerosene) lamp with flat wick has been found very satisfactory, also an incandescent electric or Welsbach light, but for brilliancy and for the actinic power necessary for very rapid photomicrography (see Ch. VIII) the electric arc lamp or an acetylene lamp serves well. Whatever source of artificial light is employed, the light should be brilliant and steady.

LIGHTING EXPERIMENTS

§ 79. **Lighting with a Mirror.**—As the following experi-

ments are for mirror lighting only, remove the substage condenser if present (see § 90, for condenser). Place a mounted fly's wing under the microscope, put the 16 mm. ($\frac{2}{3}$ in.) or other low objective in position, also a low ocular. With the coarse adjustment lower the tube of the microscope to within about 1 cm. of the object. Use an opening in the diaphragm about as large as the front lens of the objective; then with the plane mirror try to reflect light up through the diaphragm upon the object. One can tell when the field (§ 57) is illuminated, by looking at the object on the stage, but more satisfactorily by looking into the microscope. It sometimes requires considerable manipulation to light the field well. After using the plane side of the mirror turn the concave side into position and light the field with it. As the concave mirror condenses the light, the field will look brighter with it than with the plane mirror. It is especially desirable to remember that the excellence of lighting depends in part on the position of the diaphragm (§ 77). If the greatest illumination is to be obtained from the concave mirror, its position must be such that its focus will be at the level of the object. This distance can be very easily determined by finding the focal point of the mirror in full sunlight.

§ 80. **Use of the Plane and of the Concave Mirror.**—The mirror should be freely movable, and have a plane and a concave face. The concave face is used when a large amount of light is needed, the plane face when a moderate amount is needed or when it is necessary to have parallel rays or to know the direction of the rays.

FOCUSING EXPERIMENTS*

§ 81. **Focusing with Low Objectives.**—Place a mounted

§ 82. ***Par-Focal Oculars.**—By this is meant oculars of different power in which the microscope remains in focus on changing the oculars.

As originally constructed the microscope had to be focused every time the oculars were changed. Mr. Edward Pennock in seeking to overcome this inconvenience wrote to Professor Abbe for advice in 1881. After successfully producing oculars of different powers for the Acme microscopes of Jas. W. Queen & Co., according to the directions given by Professor Abbe, Mr. Pennock as editor of the *Microscopical Bulletin and Science News* published in Vol. III, 1886, pp. 9-10, the following with Professor Abbe's letter: "Changing Eyepieces without altering focus, etc. Some years ago the writer in looking up certain questions in connection with eyepieces took occasion to

fly's wing under the microscope; put the 16 mm. ($\frac{2}{3}$ in.) objective in position, and also the lowest ocular. Select the proper opening in the diaphragm and light the object well with transmitted light (§ 73, 77).

Hold the head at about the level of the stage, look toward the window, and between the object and the front of the objective; with the coarse adjustment lower the tube until the objective is within about half a centimeter of the object. Then look into the microscope and slowly elevate the tube with the coarse adjustment. The image will appear dimly at first, but will become very distinct by raising the tube still higher. If the tube is raised too high the image will become indistinct, and finally disappear. It will again appear if the tube is lowered the proper distance.

When the microscope is well focused try both the concave and the plane mirrors in various positions and note the effect. Put a high ocular in place of the low one (§ 50). If the oculars are not par-focal it will be necessary to lower the tube somewhat to get the microscope in focus.

Pull out the draw-tube 4 to 6 cm., thus lengthening the body of the microscope; it will be found necessary to lower the tube of the microscope somewhat. (For reason, see Fig. 65.)

§ 83. **Pushing in the Draw-Tube.**—To push in the draw-tube, grasp the large milled ring of the ocular with one hand, and the milled head of the coarse adjustment with the other, and grad-

write to Professor Abbe, and his reply, kindly given, is so clear and to the point, and of such interest and value, that we take the liberty of publishing it for the benefit of our readers."

"Jena, June 25th, 1881. Dear Sir: The question which you ask admits of a simple answer: In order to change the oculars of a microscope without changing the focus of the objective, neither the diaphragm nor the field lens must come to the same place in the microscope tube, but the anterior (lower) focal points of the ocular systems must do this. In the case of a Huygenian eyepiece, the said anterior focus is a virtual one situated above the field lens at a place D^* , which is more distant from the field lens than the diaphragm D . The level of D^* is the place where the virtual image of the diaphragm appears to an observer looking through the field lens. Rays which are required to emerge from the eye lens as parallel rays (or nearly parallel) must of course enter into the ocular converging to the point D^* . Consequently if different oculars are inserted successively in such a way that the point D^* comes to the same place of the tube always, the conjugate foci of object and image in the objective remain unaltered."

ually push the draw-tube into the tube. If this were done without these precautions the objective might be forced against the object and the ocular thrown out by the compressed air.

§ 84. **Focusing with High Objectives.**—Employ the same object as before, elevate the tube of the microscope and, if no revolving nose-piece is present, remove the 16 mm. ($\frac{2}{3}$ in.) objective as indicated. Put a 4 or 3 mm. ($\frac{1}{8}$ or $\frac{1}{6}$ in.) or a higher objective in place, and use a low ocular.

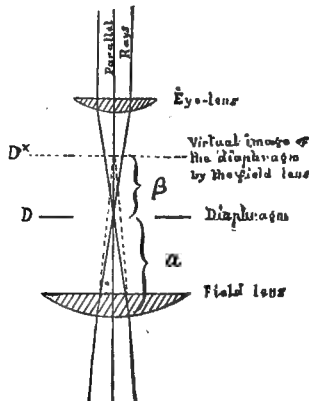

FIG. 46

" This arrangement and no other one fulfills at the same time the other request that the amplification of the microscope with different oculars should be in exact inverse proportion of the equivalent focal length of the oculars."

" The position of the point D^* may be easily calculated for every ocular. If A is the distance of the diaphragm from the field lens and X the focal length of that lens, the distance of the focus D^* above the diaphragm (*i. e.* the distance from D to D^*) will be: $\beta = \frac{A^2}{X-A}$. Hoping that these explanations

will be found satisfactory for your aim, I remain yours sincerely,

DR. E. ABBE."

On p. 31 of the Bulletin is the following: " Par-focal Eye-pieces. Referring to the article in the April issue of the Bulletin, on changing eye-pieces without altering focus, etc., we announce that we are prepared to furnish eye-pieces as there described with our Acme microscopes at a slight additional expense.

We have named these eye-pieces PAR-FOCAL, meaning of equal focus, from the Latin *par* (equal) and *focus*."

Light well, and employ the proper opening in the diaphragm, etc. (§ 77.) Look between the front of the objective and the object as before (§ 81), and lower the tube with the coarse adjustment till the objective almost touches the cover-glass over the object. Look into the microscope, and with the coarse adjustment, raise the tube very slowly until the image begins to appear, then turn the milled head of the fine adjustment (frontispiece), first one way and then the other, if necessary, until the image is sharply defined.

In practice it is found of great advantage to move the preparation slightly while focusing. This enables one to determine the approach to the focal point either from the shadow or the color, if the object is colored. With high powers and scattered objects there might be no object in the small field (see § 57 Fig. 42 for size of field). By moving the preparation an object will be moved across the field and its shadow gives one the hint that the objective is approaching the focal point. It is sometimes desirable to focus on the edge of the cement ring or on the little ring made by the marker (see Figs. 70-75.)

Note that this high objective must be brought nearer the object than the low one, and that by changing to a higher ocular (if the oculars are not par-focal) or lengthening the tube of the microscope it will be found necessary to bring the objective still nearer the object, as with the low objective. (For reason see Fig. 65.)

§ 86. **Always Focus Up**, as directed above. If one lowers the tube only when looking at the end of the objective as directed

§ 85. **Par-Focal Objectives.**—By this is meant that the objectives are so mounted that when changed on the microscope the object will remain approximately in focus for all if it is in focus for any one. The expression is applicable especially to a group of objectives on a revolving nose-piece. The tube-length of the microscope must remain constant, for only a slight change in length (10 to 15 mm.) will destroy the parfocalization. In case the objectives on a revolving nose-piece are somewhat out of parfocalization one may correct it by getting one in exact focus, and then noting when the others are rotated in place whether the microscope must be focused up or down to bring the objective in focus.

If one winds a piece of string around the objective that is up too high it will prevent it entering the nut of the nose-piece so far and hold it down at the right level.

It is not known by the writer who first thought of arranging the objectives so that the different powers would be in focus when in position. It is a recent improvement, coming in as a necessary consequence of parfocalizing the oculars.

above, there will be no danger of bringing the objective in contact with the object, as may be done if one looks into the microscope and focuses down.

When the instrument is well focused, move the object around in order to bring different parts into the field. It may be necessary to re-focus with the fine adjustment every time a different part is brought into the field. In practical work one hand is kept on the fine adjustment constantly, and the focus is continually varied.

§ 87. **Determination of Working Distance.** As stated in § 69, this is the distance between the front lens of the objective and the object when the objective is in focus. It is always less than the equivalent focal length of the objective.

Make a wooden wedge 10 cm. long which shall be exceedingly thin at one end and about 20 mm. thick at the other. Place a slide on the stage and some dust on the slide. Do not use a cover-glass. Focus the dust carefully first with the low then with the high objective. When the objective is in focus push the wedge under the objective on the slide until it touches the objective. Mark the place of contact with a pencil and then measure the thickness of the wedge with a rule opposite the point of contact. This thickness will represent very closely the working distance. For measuring the thickness of the wedge at the point of contact for the high objective use a steel scale ruled in $\frac{1}{5}$ mm. and the tripod to see the divisions. Or one may use a cover-glass measure (Ch. VIII) for determining the thickness of the wedge.

For the higher powers if one has a microscope in which the fine adjustment is graduated, the working distance may be readily determined when the thickness of the cover-glass over the specimen is known, as follows: Get the object in focus, lower the tube of the microscope, until the front of the objective just touches the cover-glass. Note the position of the micrometer screw and slowly focus up with the fine adjustment until the object is in focus. The distance the objective was raised plus the thickness of the cover-glass represents the working distance. For example, a 3 mm. objective after being brought in contact with the cover-glass was raised by the fine adjustment a distance represented by 16 of the divisions on the head of the micrometer screw. Each division represented 0.01 mm., consequently the objective was raised 0.16 mm.

As the cover-glass on the specimen used was 0.15 mm. the total working distance is $0.16 + 0.15 = 0.31$ mm.

CENTRAL AND OBLIQUE LIGHT WITH A MIRROR

§ 88. **Axial or Central Light** (§ 74).—Remove the condenser or any diaphragm from the substage, then place a preparation containing minute air bubbles under the microscope. The preparation may be easily made by beating a drop of mucilage on the slide and covering it (see Ch. III). Use a 4 or 3 mm., ($\frac{1}{8}$ in.) or No. 7 objective and a medium ocular. Focus the microscope and select a very small bubble, one whose image appears about 1 mm. in diameter, then arrange the plane mirror so that the light spot in the bubble appears exactly in the center. Without changing the position of the mirror in the least, replace the air bubble preparation by one of *Pleurosigma angulatum* or some other finely marked diatom. Study the appearance very carefully.

§ 89. **Oblique Light** (§ 75).—Swing the mirror far to one side so that the rays reaching the object may be very oblique to the optic axis of the microscope. Study carefully the appearance of the diatom with the oblique light. Compare the appearance with that where central light is used. The effect of oblique light is not so striking with histological preparations as with diatoms.

It should be especially noted in §§ 88, 89, that one cannot determine the exact direction of the rays by the position of the mirror. This is especially true for axial light (§ 88). To be certain the light is axial some such test as that given in § 88 should be applied. (See also Ch. III, under Air-bubbles.)

CONDENSERS OR ILLUMINATORS*

§ 90. These are lenses or lens-systems for the purpose of

*No one has stated more clearly, or appreciated more truly the value of correct illumination and the methods of obtaining it than Sir David Brewster, 1820, 1831. He says of illumination in general: "The art of illuminating microscopic objects is not of less importance than that of preparing them for observation." "The eye should be protected from all extraneous light, and should not receive any of the light which proceeds from the illuminating center, excepting that portion of it which is transmitted through or reflected from the object." So likewise the value and character of the substage con-

illuminating with transmitted light the object to be studied with the microscope.

For the highest kind of investigation their value cannot be over-estimated. They may be used either with natural or artificial light, and should be of sufficient numerical aperture to satisfy objectives of the widest angle.

It is of the greatest advantage to have the sub-stage condenser mounted so that it may be easily moved up or down under the stage. The iris diaphragm is so convenient that it should be furnished in all cases, and there should be marks indicating the N. A. (§ 36) of the condenser utilized with different openings. Finally the condenser should be supplied with central stops for dark-ground illumination (§ 103) and with blue and neutral tint glasses to soften the glare when artificial light is used (§ 100, 104).

Condensers or Illuminators fall into two great groups, the **Achromatic**, giving a large aplanatic cone, and **Non-achromatic**, giving much light, but a relatively small aplanatic cone of light.

§ 91. **Achromatic Condenser.**—It is still believed by all expert microscopists that the contention of Brewster was right, and the condenser to give the greatest aid in elucidating microscopic structure must approach in excellence the best objectives. That is, it should be as free as possible from spherical and chromatic aberration, and therefore would transmit to the object a very large aplanatic cone of light. Such condensers are especially recommended for photo-micrography by all, and those who believe in getting the best possible image in every case are equally strenuous that achromatic condensers should be used for all work. Unfortunately good condensers like good objectives are expensive, and student microscopes as well as many others are usually supplied with the non-achromatic condensers or with none.

Many excellent achromatic condensers have been made, but the

denser was thoroughly understood and pointed out by him as follows: "I have no hesitation in saying that the apparatus for illumination requires to be as perfect as the apparatus for vision, and on this account I would recommend that the illuminating lens should be perfectly free of chromatic and spherical aberration, and the greatest care be taken to exclude all extraneous light both from the object and from the eye of the observer." See Sir David Brewster's treatise on the Microscope, 1837, pp. 136, 138, 146, and the *Edinburgh Journal of Science*, new series, No. 11 (1831) p. 83.

most perfect of all seems to be the apochromatic of Powell and Lealand (Carpenter-Dallinger, p. 302). To attain the best that was possible many workers have adopted the plan of using objectives as condensers. A special substage fitting is provided with the proper screw and the objective is put into position, the front lens being next the object. As will be seen below (§ 94, 95), the full aperture of an objective can rarely be used, and for histological preparations perhaps never, so that an objective of greater equivalent focus, *i. e.*, lower power, is used for the condenser than the one on the microscope. It is much more convenient, however, to have a special condenser with iris diaphragm or special diaphragms so that one may use any aperture at will, and thus satisfy the conditions necessary for lighting different objects for the same objective and for lighting with objectives of different apertures. An excellent condenser of this form has been produced by Zeiss (Fig. 47). It has a total numerical aperture of 1.00, and an aplanatic aperture of 0.65.

FIG. 47. *Zeiss' Achromatic Condenser. c. s. c. s.* Centering screws for changing the position of the condenser and making its axis continuous with that of the microscope. A segment of the condenser is cut away to show the combination of lenses. For very low powers the upper lens is sometimes screwed off. There is an iris diaphragm between the middle and lower combinations. (Zeiss' Catalog.)

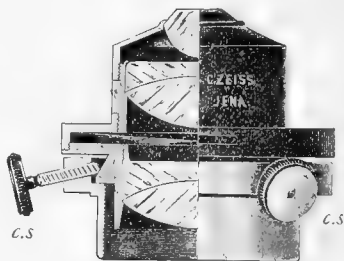

§ 92. **Centering the Condenser.**—To get the best possible illumination for bringing out in the clearest manner the minute details of a microscopic object two conditions are necessary, *viz.*: The principal optic axis of the condenser must be continuous with that of the microscope (see frontispiece) and the object must be in the focus of the condenser, *i. e.*, at the apex of the cone of light given by the condenser.

The centering is most conveniently accomplished as follows although daylight may be used with almost equal facility. A very small diaphragm is put below the condenser. (If the Zeiss achromatic condenser is used, the diaphragm of the Abbe illuminator serves for this. If there is no pin-hole diaphragm one can be made

of stiff, black paper. Care must be taken, however, to make the opening exactly central. This is best accomplished by putting the paper disc over the iris or metal diaphragms and then making the hole in the center of the small circle uncovered by the metal diaphragm (For the hole a fine needle is best). Light well and lower the objective so that it is at about its working-distance from the top of the condenser. If now the condenser is lowered or racked away from the objective the image of the diaphragm will appear. If the opening is not central it should be made so by using the centering screws of the condenser.

A better plan than to lower the condenser to focus the image of the diaphragm, is to raise the body of the microscope slowly with the coarse adjustment. It is almost impossible to make apparatus so accurate that two parts like the body of the microscope and the substage, each working on different sliding surfaces, shall continue in exactly the same plane. So one will find that if the condenser be accurately centered with the condenser lowered, and then the condenser be racked up close to the stage and the image of the diaphragm opening brought again into focus by racking up the body of the microscope, it will not be accurately centered in most cases. For this reason it is advised that the condenser be left in position close to the stage and the tube of the microscope be used to focus the diaphragm exactly as in ordinary work.

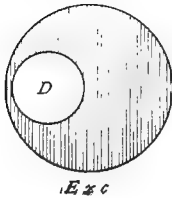

FIG. 48

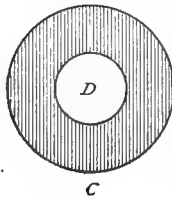

FIG. 49

FIG. 48. Shows that the optic axis of the condenser does not coincide with that of the microscope. (D). Image of the diaphragm of the condenser shown at one side of the field of view.

FIG. 49. Shows the image of the diaphragm (D) in the center of the field of the microscope, and thus the coincidence of the axis of the condenser with that of the microscope.

§ 93. **Centering the Image of the Source of Illumination.**—For the best results it is not only necessary that the condenser be properly centered, but that the object to be studied should be in the image of the source of illumination and that this should also be centered (Figs. 50, 51). After the condenser itself is centered the iris diaphragm is opened to its full extent or the diaphragm carrier

turned wholly aside. A transparent specimen like the fly's wing is put under the microscope and focused. The condenser is then turned up and down until the image of the flame is apparently on the specimen. If this cannot be accomplished the relative position of the lamp and condenser is not correct and should be so changed that the image of the edge of the flame is sharply defined. This image must also be centered. This is easily accomplished by manipulation of the mirror or, if a lamp is used, by changing the position of the lamp or of the bull's eye (Fig. 60).

§ 94. **Proper Numerical Aperture of the Condenser.**—As stated above, the aperture of the condenser should have a range by means of properly selected diaphragms to meet the requirements of all objectives from the lowest to those of the highest aperture. It is found in practice that for diatoms, etc., the best images are obtained when the object is lighted with a cone which fills about three-fourths of the diameter of the back lens of the objective with light, but for histological and other preparations of lower refractive power only one-half or one-third the aperture often gives the most satisfactory images (§ 40).

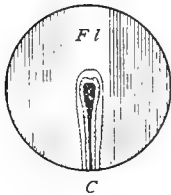

FIG. 50

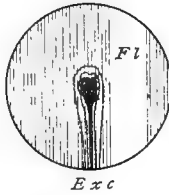

FIG. 51

FIG. 50. Shows the image of the flame (Fl.) in the center (C) of the field of the microscope and illuminating the object.

FIG. 51. Shows the image of the flame (Fl.) at one side of the center (Exc.) and not properly illuminating the object.

To determine this in any case focus upon some very transparent object, take out the ocular, look down the tube at the back lens. If less than three-fourths of the back lens is lighted, increase the opening in the diaphragm—if more than three-fourths diminish it. For some objects it is advantageous to use less than three-fourths of the aperture. Experience will teach the best lighting for special cases.

§ 95. **Aperture of the Illuminating Cone and the Field.**—It is to be remarked that with a very small source of light the entire aperture of the objective may be filled if a proper illuminator or condenser is used. The aperture depends on the diaphragm used

with the condenser. And the size of the diaphragm must be directly as the aperture of the objective. That is, it is just the reverse of the rule for diaphragms where no condenser is used (§ 76); for there the diaphragm is made large for low powers, and consequently low apertures, while with the condenser the diaphragm is made small for low and large for high powers as the aperture is



FIG. 52



FIG. 53



FIGS. 52-53. *Figures showing the dependence of the objective upon the illuminating cone of the condenser (Nelson).*

FIG. 52 (A). *The illuminating cone from the condenser (Illum.). This is seen to be just sufficient to fill the objective (Obj.).*

(B.) *The back lens of the objective entirely filled with light, showing that the numerical aperture of the illuminator is equal to that of the objective.*

FIG. 53 (A). *In this figure the illuminating cone from the condenser (Illum.) is seen to be sufficient to fill the objective (Obj.).*

(B.) *The back lens of the objective only partly filled with light, due to the restricted aperture of the illuminator.*

greater in the high powers of a given series of objectives. It is very instructive to demonstrate this by using a 16 mm. objective and opening the diaphragm of the condenser till the back lens is just filled with light. Then if one uses a 3 or 4 mm. objective it will be seen that the back lens of the higher objective is only partly filled with light and to fill it the diaphragm must be much more widely opened.

With a condenser, then, the diaphragm has simply to regulate the aperture of the illuminating cone, and has nothing to do with lighting a large or a small field.

With the condenser there are two conditions that must be fulfilled,—the proper aperture must be used, and that is determined by the diaphragm, and secondly the whole field must be lighted. The latter is accomplished by using a larger source of light, as the face instead of the edge of a lamp flame, or by lowering or raising

the condenser so that the object is not in the focus of the condenser, but above or below it, and therefore lighted by a converging or diverging beam where the light is spread over a greater area (Figs. 54-57, § 99).

§ 96. **Non-Achromatic Condensers.**—Of the non-achromatic condensers or illuminators, the Abbe condenser or illuminator is the one most generally used. From its cheapness it is also much more commonly used than the achromatic condenser. It consists of two or three very large lenses and transmits a cone of light of 1.20 N.A. to 1.40 N.A., Figs. 58-59, but the aberrations, both spherical and chromatic, are very great in both forms. Indeed, so great are they that in the best form with three lenses and an illuminating cone of 1.40 N. A., the aplanatic cone transmitted is only 0.5, and it is the aplanatic cone which is of real use in microscopic illumination where details are to be studied. There is no doubt, however, that the results obtained with a non-achromatic condenser like the Abbe are much more satisfactory than with no condenser. The highest results cannot be attained with it, however. (Carpenter-Dallinger, p. 309.)

§ 97. **Position of the Condenser.**—The proper position of the illuminator for high objectives is one in which the beam of light traversing it is brought to a focus on the object. If parallel rays are reflected from the plane mirror to it, they will be focused only a few millimeters above the upper lens of the condenser; consequently the illuminator should be about on the level of the top of the stage and therefore almost in contact with the lower surface of the slide. For some purposes when it is desirable to avoid the loss of light by reflection or refraction, a drop of water or homogenous immersion fluid is put between the slide and condenser, forming the so-called immersion illuminator. This is necessary only with objectives of high power and large aperture or for dark-ground illumination.

§ 98. **Centering the Condenser.**—The illuminator should be centered to the optic axis of the microscope, that is the optic axis of the condenser and of the microscope should coincide. Unfortunately there is extreme difficulty in determining when the Abbe illuminator is centered. Centering is approximated as follows: Put a pin-hole diaphragm—that is a diaphragm with a small central hole—over the end of the condenser (Fig. 58), the central opening should appear to be in the middle of the field of the microscope. If

it does not the condenser should be moved from side to side by loosening the centering screws until it is in the center of the field. In case no pin-hole diaphragm accompanies the condenser, one may put a very small drop of ink, as from a pen-point, on the center of the upper lens and look at it with a microscope to see if it is in the center of the field. If it is not, the condenser should be adjusted until it is. When the condenser is centered as nearly as possible remove the pin-hole diaphragm or the spot of ink. The microscope and illuminator axes may not be entirely coincident even when the center of the upper lens appears in the center of the field, as there may be some lateral tilting of the condenser, but the above is the best the ordinary worker can do, and unless the mechanical arrangements of the illuminator are deficient, it will be very nearly centered.

It is to be hoped that the opticians will devise some kind of mounting for this the most commonly used condenser whereby it may be centered as described for the achromatic condenser instead of by the crude methods described above. If the condenser mounting regularly possessed centering screws as in the microscope of Watson & Sons and there were a centering diaphragm in the proper position so that its image could be projected into the field of view, the operation would be very simple. If, further, the condensers of Powell and Lealand were selected as models the condensers need not be so bulky, and would still retain all their efficiency.

Fortunately the Royal Microscopical Society of London, which has done so much toward standardizing microscopical apparatus, has proposed a standard size for the substage fitting for the condenser of 1.527 in. = 38.786 mm. (see § 53).

§ 99. **Mirror and Light for the Abbe Condenser.**—It is best to use light with parallel rays. The rays of daylight are practically parallel; it is best therefore to employ the plane mirror for all but the lowest powers. If low powers are used the whole field might not be illuminated with the plane mirror when the condenser is close to the object; furthermore, the image of the window frame, objects outside the building, as trees, etc., would appear with unpleasant distinctness in the field of the microscope. To overcome these defects one can lower the condenser and thus light the object with a diverging cone of light, or use the concave mirror and attain the same end when the condenser is close to the object (Fig. 54).

§ 100. **Artificial Light.**—If one uses lamp light, it is recommended that a large bull's eye be placed in such a position between the light and the mirror that parallel rays fall upon the mirror or in some cases an image of the lamp flame. If one does not have a bull's eye the concave mirror may be used to render the rays less divergent. It may be necessary to lower the condenser somewhat in order to illuminate the object in its focus.

ABBE CONDENSER: EXPERIMENTS

§ 101. **Abbe Condenser, Axial and Oblique Light.**—Use a diaphragm a little larger than the front lens of the 3 mm. ($\frac{1}{8}$ in) objective, have the illuminator on the level, or nearly on the level of the upper surface of the stage, and use the plane mirror. Be sure that the diaphragm carrier is in the notch indicating that it is central in position. Use the *Pleurosigma* as object. Study carefully the appearance of the diatom with this central light, then make the diaphragm eccentric so as to light with oblique light (§ 89). The differences in appearance will probably be even more striking than with the mirror alone.

§ 102. **Lateral Swaying of the Image.**—Frequently in studying an object, especially with a high power, it will appear to sway from side to side in focusing up or down. A glass stage micrometer or fly's wing is an excellent object. Make the light central or axial and focus up and down and notice that the lines simply disappear or grow dim. Now make the light oblique, either by making the diaphragm opening eccentric or if simply a mirror is used, by swinging the mirror sidewise. On focusing up and down, the lines will sway from side to side. What is the direction of apparent movement in focusing down with reference to the illuminating ray? What in focusing up? If one understands the experiment it may sometimes save a great deal of confusion. (See under testing the microscope for swaying with central light § 130.)

§ 103. **Dark-Ground Illumination.**—When an object is lighted with rays of a greater obliquity than can get into the front lens of the objective, the field will appear dark (Fig. 57). If now the object is composed of fine particles, or is semi-transparent, it will refract or reflect the light which meets it, in such a way that a

part of the very oblique rays will pass into the objective, hence as light reaches the objective only from the object, all the surrounding field will be dark and the object will appear like a self-luminous one on a dark back-ground. This form of illumination is most

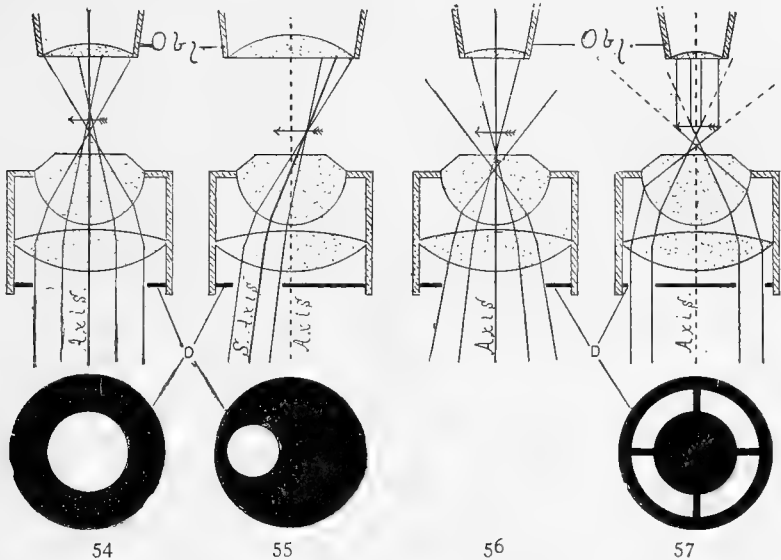

FIGS. 54-57. Sectional views of the Abbe Illuminator of 1.20 N.A. showing various methods of illumination (§ 101). FIG. 54, axial light with parallel rays. FIG. 55, oblique light. FIG. 56, axial light with converging beam. FIG. 57, dark-ground illumination with a central stop diaphragm.

Axis. The optic axis of the illuminator and of the microscope. The illuminator is centered, that is its optic axis is a prolongation of the optic axis of the microscope.

S. Axis. Secondary axis. In oblique light the central ray passes along a secondary axis of the illuminator, and is therefore oblique to the principal axis.

D. D. Diaphragms. These are placed in sectional and in face views. The diaphragm is placed between the mirror and the illuminator. In FIG. 55 the opening is eccentric for oblique light, and in FIG. 57 the opening is a narrow ring, the central part being stopped out, thus giving rise to dark-ground illumination (§ 103).

Obj. Obj. The front of the objective.

successful with low powers. It is well to make the illuminator immersion for this experiment, (see § 116).

(A) *With the Mirror.*—Remove all the diaphragms so that

very oblique light may be used, employ a stage micrometer in which the lines have been filled with graphite, use a 16 mm. ($\frac{2}{3}$ in.) objective, and when the light is sufficiently oblique the lines will appear something like streaks of silver on a black background. A specimen like that described below in (B) may also be used.

(B) *With the Abbe Condenser.*—Have the illuminator so that the light is focused on the object (see § 97) and use a diaphragm

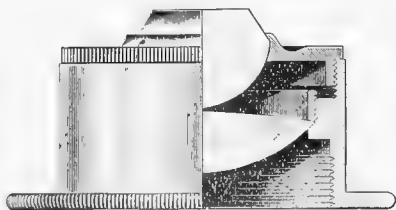

FIG. 58. *Abbe Condenser of 1.20 N.A. in section.*

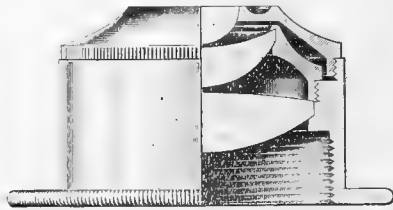

FIG. 59. *Abbe Condenser of 1.40 N.A. in section.*

Cuts loaned by Voigtländer & Sohn, A.G.

with the annular opening (Fig. 57); employ the same objective as in (A). For object place a drop of 10 % solution of salicylic acid in 95 % alcohol on the middle of a slide; it will crystallize. The crystals will appear brilliantly lighted on a dark background. Put in an ordinary diaphragm and make the light oblique by making the diaphragm eccentric. The same specimen may also be tried with a mirror and oblique light. In order to appreciate the difference between this dark-ground and ordinary transmitted-light illumination, use a central diaphragm and observe the crystals.

A striking and instructive experiment may be made by adding a very small drop of the solution to the dried preparation, putting it under the microscope quickly, lighting for dark-ground illumination and then watching the crystallization.

§ 103a. **Dark-Ground Illumination for High Powers.**—There are two methods for making objects appear as if self luminous in a black field: (1) To light the objects by rays so oblique that none of them will enter the objective unless they are deflected by some object in the field. This method was employed above for low powers. For high powers very wide apertures must be used for the condenser. No rays below 1.00 N. A. can be successfully

utilized. To accomplish this, Siedentopf and Beck employ a parabolic reflector instead of a condenser of the usual type. Others used condensers specially modified. That of Reichert is conical and silvered on the conical surface; that of Leitz makes use of two internal reflections. By all these pieces of apparatus a hollow cone of light of an aperture greater than 1.00 N. A. is concentrated upon the field, hence high powers as well as low ones can be used provided a sufficiently brilliant source of light is employed (sunlight, arc lamp, etc.).

Ultramicroscopy.—In 1903 Siedentopf and Zsigmondy published a method by which a further evolution of dark-ground illumination was attained according to the general principle just considered. By their method the field is illuminated by a very brilliant cone or wedge of light from the side, *i. e.*, at right angles to the axis of the microscope. It is evident that none of the rays can enter the microscope with even the widest apertured objectives unless the light is deflected by something in the field. The brilliant light so used renders minute particles luminous something as sunlight entering a small hole in a darkened room renders particles of dust luminous. As this method of lighting rendered particles luminous and therefore visible that were invisible with the microscope as ordinarily used, the use of the microscope with this lighting has come to be called *Ultramicroscopy*.

(2) The second method was used by Töppler, 1867, and has been revived by Gordon, (J. R. M. S. 1906) and others. In this method the object is lighted by a solid cone of light from the condenser as usual, but the aperture of the condenser must only fill the middle part of the aperture of the objective. In the first method the aperture of the condenser must be great and that of the objective moderate, while in this the reverse is the case, and the objective should have a large aperture and the condenser a moderate aperture. The solid cone of light used for illumination has some of its rays deflected by objects in the field so that they enter the marginal zones of the objective. To secure dark-ground illumination in this manner only these marginal rays are utilized for the image, and the central, solid cone of light entering the objective must be eliminated. This is accomplished by placing a diaphragm or stop on the back lens of the objective of just the right size to cut out the central solid cone and allow the marginal rays to pass on to form the image.

This gives fairly good results with all powers. The same may also be accomplished, as shown by Gordon, 1906, by using a stop in the eye-point or Ramsden circle (§ 67).

For a discussion of dark-ground illumination and ultramicroscopy see: A. E. Wright, *Principles of Microscopy*, Ch. XIV; Siedentopf, *Jour. Roy. Micr. Soc.* 1903, p. 573, 1907, p. 733; Gordon, 1906, p. 167; Beck, 1908, p. 238; Reichert, 1908, p. 374; Leitz, 1905, p. 502 and Catalog No. 42, and special catalog. Töpler, *Poggendorff's Annalen*, 1867, p. 33; Beck's *Cantor Lectures*, 1907; Zeiss special catalog on Ultramicroscopy and dark-ground illumination, 1907, gives the apparatus needed, the methods and application, also bibliography; Cotton et Mouton, *Les Ultramicroscopes*, Paris, 1906.

ARTIFICIAL ILLUMINATION

§ 104. For evening work and for regions where daylight is not sufficiently brilliant, artificial illumination must be employed. Furthermore, for the the most critical investigation of bodies with fine markings like diatoms, artificial light has been found superior to daylight.

A petroleum (kerosene) lamp with flat wick gives a satisfactory light. It is recommended that instead of the ordinary glass chimney one made of metal with a slit-opening covered with an oblong cover-glass is more satisfactory, as the source of light is more restricted. Very excellent results may be obtained, however, with the ordinary bed-room lamp furnished with the usual glass chimney.

The acetylene light promises to be excellent for microscopic observation and for photo-micrography. (See under photo-micrography.) See also § 103a.

Whenever possible the edge of the flame is turned toward the microscope, the advantage of this arrangement is the great brilliancy, due to the greater thickness of the flame in this direction.

§ 105. **Mutual Arrangement of Lamp, Bull's Eye and Microscope.**—To fulfil the conditions given above, namely, that the object be illuminated by the image of the source of illumination the lamp must be in such a position that the condenser projects a sharp image of the flame upon the object (Fig. 60), and only by trial can this position be determined. In some cases it is found ad-

vantageous to discard the mirror and allow the light from the bull's eye to pass directly into the condenser. In most cases no bull's eye need be used. The proper distance of the lamp from the mirror and the proper elevation of the condenser give the required results. The position of lamp and condenser can be determined by trial in each case.

§ 106. **Illuminating the Entire Field.**—With low objectives and large objects, the entire object might not be illuminated if the

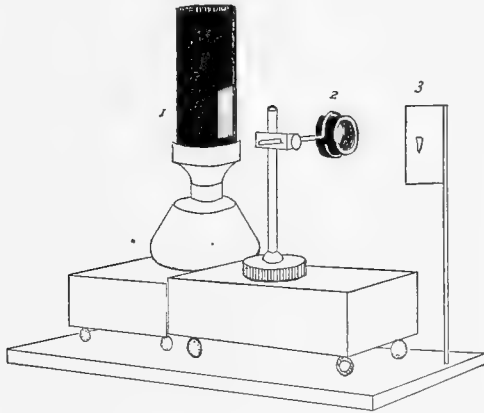

FIG. 60. 1. *Lamp with slit-opening in metal chimney.* 2. *Bull's eye on separate stand.* 3. *Screen showing image of flame.*

above method were strictly followed ; in this case turn the lamp so that the flame is oblique, or if that is not sufficient, continue to turn the lamp until the full width of the flame is used. If necessary the condenser may be lowered, and the concave mirror used. (See also § 95.)

REFRACTION AND COLOR IMAGES

§ 107. **Refraction Images** are those mostly seen in studying microscopic objects. They are the appearances produced by the refraction of the light on entering and on leaving an object. They therefore depend (a) on the form of the object, (b) on the relative refractive powers of object and mounting medium. With such images the diaphragm should not be too large (see § 94).

If the color and refractive index of the object were exactly like the mounting medium it could not be seen. In most cases both refractive index and color differ somewhat, there is then a combination of color and refraction

images which is a great advantage. This combination is generally taken advantage of in histology. The air bubble in § 151 is an example of a purely refractive image.

§ 103. **Refraction.**—Lying at the basis of microscopical optics is refraction, which is illustrated by the above figures. It means that light passing from one medium to another is bent in its course. Thus in Fig. 61 light passing from air into water does not continue in a straight line but is bent *toward* the normal $N-N'$, the bending taking place at the point of contact of the air

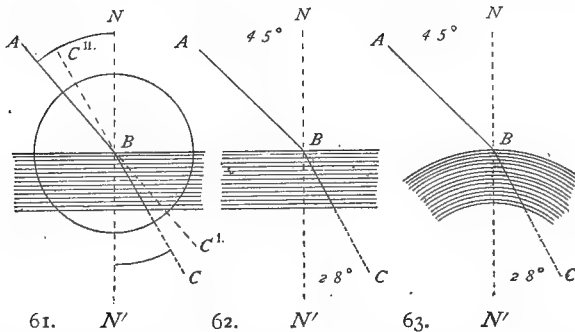

FIGS. 61-63. *Diagrams illustrating refraction in different media and at plane and curved surfaces. In each case the denser medium is represented by line shading and the perpendicular or normal to the refracting surface is represented by the dotted line $N-N'$, the refracted ray by the bent line $A C$.*

and water; that is, the ray of light $A B$ entering the water at B is bent out of its course, extending to C instead of C' .

Conversely, if the ray of light is passing from water into air, on reaching the air it is bent *from* the normal, the ray $C B$ passing to A and not in a straight line to C'' . By comparing Figs. 62-63 in which the denser medium is crown glass instead of water, the bending of the rays is seen to be greater as crown glass is denser than water.

It has been found by physicists that there is a constant relation between the angle taken by the ray in the rarer medium and that taken by the ray in the denser medium. The relationship is expressed thus: Sine of the angle of incidence divided by the sine of the angle of refraction equals the *index of refraction*. In the figures,

$$\frac{\sin ABN}{\sin CBN'} = \text{index of refraction.}$$

Worked out completely in Fig. 61, $ABN=40^\circ$, $CBN'=28^\circ 54'$ and $\frac{\sin 40^\circ}{\sin 28^\circ 54'} = \frac{0.6427}{0.48327} = 1.33$, *i. e.*, the index of refraction from air to water is 1.33. (See § 39.) In Figs. 62-63, illustrating refraction in crown glass, the angles being given, the problem is easily solved as just illustrated. (For table of natural sines see third page of cover; for interpolation, § 38.)

§ 109. **Absolute Index of Refraction.**—This is the index of refraction ob-

tained when the incident ray passes from a vacuum into a given medium. As the index of the vacuum is taken as unity, the absolute index of any substance is always greater than unity. For many purposes, as for the object of this book, air is treated as if it were a vacuum, and its index is called unity, but in reality the index of refraction of air is about 3 ten-thousandths greater than unity. Whenever the refractive index of a substance is given, the absolute index is meant unless otherwise stated. For example, when the index of refraction of water is said to be 1.33, and of crown glass 1.52, etc., these figures represent the absolute index, and the incident ray is supposed to be in a vacuum.

§ 110. **Relative Index of Refraction.**—This is the index of refraction between two contiguous media, as for example between glass and diamond, water and glass, etc. It is obtained by dividing the absolute index of refraction of the substance containing the refracted ray, by the absolute index of the substance transmitting the incident ray. For example, the relative index from water to glass is 1.52 divided by 1.33. If the light passed from glass to water it would be, 1.33 divided by 1.52.

By a study of the figures showing refraction, it will be seen that the greater the refraction the less the angle and consequently the less the sine of the angle, and as the refraction between two media is the ratio of the sines of the angles of incidence and refraction $\left(\frac{\sin i}{\sin r}\right)$, it will be seen that whenever the sine of the angle of refraction is increased by being in a less refractive medium, the index of refraction will show a corresponding decrease and vice versa. That is the ratio of the sines of the angles of incidence and refraction of any two contiguous substances is inversely as the refractive indices of those substances. The formula is:

$$\left(\frac{\text{Sine of angle of incident ray}}{\text{Sine of angle of refracted ray}}\right) = \left(\frac{\text{Index of refraction of refracting medium}}{\text{Index of refraction of incident medium}}\right)$$

Abbreviated $\left(\frac{\sin i}{\sin r}\right) = \left(\frac{\text{index } r}{\text{index } i}\right)$. By means of this general formula one can solve any problem in refraction whenever three factors of the problem are known. The universality of the law may be illustrated by the following cases:

(A) Light incident in a vacuum or in air, and entering some denser medium, as water, glass, diamond, etc.

$$\left(\frac{\text{Sine of angle made by the ray in air}}{\text{Sine of angle made by ray in denser med.}}\right) = \left(\frac{\text{Index of ref. of denser med}}{\text{Index of ref. of air (1)}}\right)$$

If the dense substance were glass $\left(\frac{\sin i}{\sin r}\right) = \left(\frac{1.52}{1}\right)$. If the two media were water and glass, the incident light being in water the formula would be;

$$\left(\frac{\sin i}{\sin r}\right) = \left(\frac{1.52}{1.33}\right). \text{ If the incident ray were glass and the refracted ray}$$

in water: $\left(\frac{\sin i}{\sin r}\right) = \left(\frac{1.33}{1.52}\right)$. And similarly for any two media; and as stated above if any three of the factors are given the fourth may be readily found.

§ III. **Critical Angle and Total Reflection.**—In order to understand the Wollaston camera lucida (Ch. IV) and other totally reflecting apparatus, it is necessary briefly to consider the critical angle.

The *critical angle* is the greatest angle that a ray of light in the denser of two contiguous media can make with the normal and still emerge into the less refractive medium. On emerging it will form an angle of 90° with the normal, and if the substances are liquids, the refracted ray will be parallel with the surface of the denser medium.

Total Reflection.—In case the incident ray in the denser medium is at an angle with the normal greater than the *critical angle*, it will be *totally reflected* at the surface of the denser medium, that surface acting as a perfect mirror. By consulting the figures it will be seen that there is no such thing as a critical angle and total reflection in the rarer of two contiguous media.

To find the critical angle in the denser of two contiguous media:—

Make the angle of refraction (*i. e.*, the angle in the rarer of the two media) 90° and solve the general equation: $\left(\frac{\sin i}{\sin r}\right) = \left(\frac{\text{index } r}{\text{index } i}\right)$. Let the two substances be water and air, then the sine of $r(90^\circ)$ is 1, and the index of air is 1, that of water 1.33, whence $\left(\frac{\sin i}{1}\right) = \left(\frac{1}{1.33}\right)$ or $\sin i = .751+$. This is the sine of $48^\circ+$, and whenever the ray in the water is at an angle of more than 48° it will not emerge into the air, but be totally reflected back into the water.

The case of a ray passing from crown glass into the water:

$$\left(\frac{\sin i}{\sin r(\sin 90^\circ = 1)}\right) = \left(\frac{\text{index water (1.33)}}{\text{index glass (1.52)}}\right) \text{ or } \left(\frac{\sin i}{1}\right) = \left(\frac{1.33}{1.52}\right).$$

whence $\sin i = .875$ sine of critical angle in glass covered with water. The corresponding angle is approximately 61° .

§ II2. **Color Images.** These are images of objects which are strongly colored and lighted with so wide an aperture that the refraction images are drowned in the light. Such images are obtained by removing the diaphragm or by using a larger opening. This method of illumination is especially applicable to the study of deeply stained bacteria. (See below § II9.)

ADJUSTABLE, WATER AND HOMOGENEOUS OBJECTIVES:

EXPERIMENTS

§ II3. **Adjustment for Objectives.** As stated above (§ 27), the aberration produced by the cover-glass (Fig. 64), is compensated for by giving the combinations in the objective a different relative position than they would have if the objective were to be used on uncovered objects. Although this relative position cannot be changed in unadjustable objectives, one can secure the best results of which the objective is capable by selecting covers of the thickness for which the objective was corrected. (See table § 33.) Adjustment may be made also by *increasing* the tube-length for covers *thinner* than the

standard and by *shortening* the tube-length for covers *thicker* than the standard (Fig. 65).

In learning to adjust objectives, it is best for the student to choose some object whose structure is well agreed upon, and then to practice lighting it, shading the stage and adjusting the objective, until the proper appearance is obtained. The adjustment is made by turning a ring or collar which acts on a screw and increases or diminishes the distance between the systems of lenses, usually the front and the back systems (Fig. 45).

FIG. 64. *Effect of the cover-glass on the rays from the object to the objective (Ross).*

Axis. The projection of the optic axis of the microscope.

F. Focal or axial point of the objective.

F' and *F''.* Points on the axis where rays 2 and 3 appear to originate if traced backward after emerging from the upper side of the cover-glass.

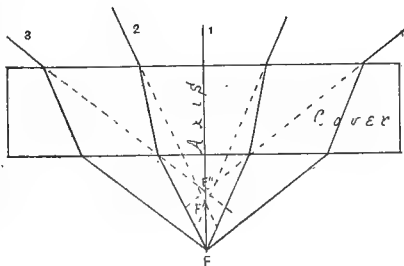

§ 114. **Directions for Adjustment.**—(A) The thinner the cover-glass, the further must the systems be separated, *i. e.*, the adjusting collar is turned nearer the zero or the mark “uncovered,” and conversely; (B) the thicker the cover-glass the closer together are the systems brought by turning the adjusting collar *from* the zero mark. This also increases the magnification of the objective (Ch. IV).

The following specific directions for making the cover-glass adjustment are given by Mr. Wenham (Carpenter, 7th Ed., p. 166). “Select any dark speck or opaque portion of the object, and bring the outline into perfect focus; then lay the finger on the milled-head of the fine motion, and move it briskly backwards and forwards in both directions from the first position. Observe the expansion of the dark outline of the object, both when within and when without the focus. If the greater expansion or coma is when the object is *without* the focus, or farthest from the objective [*i. e.*, in focusing up], the lenses must be placed further asunder, or toward the mark uncovered [the adjusting collar is turned toward the zero mark as the cover-glass is too thin for the present adjustment]. If the greater expansion is when the object is within the focus, or nearest the objective [*i. e.*, in focusing down], the lenses must be brought

closer together, or toward the mark covered [*i. e.*, the adjusting collar should be turned away from the zero mark, the cover-glass being too thick for the present adjustment].” *In most objectives the collar is graduated arbitrarily, the zero (O) mark representing the position for uncovered objects. Other objectives have the collar graduated to correspond to the various thickness of cover-glasses for which the objective may be adjusted. This seems to be an admirable plan; then if one knows the thickness of the cover-glass on the preparation (Ch. VIII) the adjusting collar may be set at a corresponding mark, and one will feel confident that the adjustment will be approximately correct. It is then only necessary for the observer to make the slight adjustment to compensate for the mounting medium or any variation from the standard length of the tube of the microscope.* In adjusting for variations of the length of the tube from the standard it should be remember that: (A) If the tube of the microscope is longer than the standard for which the objective was corrected, the effect is approximately the same as thickening the cover-glass, and therefore the systems of the objective must be brought closer together, *i. e.*, the adjusting collar must be turned *away from* the zero mark. (B) If the tube is shorter than the standard for which the objective is corrected, the effect is approximately the same as diminishing the thickness of the cover-glass, and the systems must therefore be separated (Fig. 45).

In using the tube-length for cover correction **Shorten** the tube for too **thick** covers and **Lengthen** the tube for too **thin** covers.

Furthermore, whatever the interpretation by different opticians of what should be included in “tube-length,” and the exact length in millimeters, its importance is very great; for each objective gives the most perfect image of which it is capable with the “tube-length” for which it is corrected, and the more perfect the objective the greater the ill-effects on the image of varying the “tube-length” from the standard. The plan of designating exactly what is meant by “tube-length,” and engraving on each objective the “tube-length for which it is corrected, is to be commended, for it is manifestly difficult for each worker with the microscope to find out for himself for what “tube-length” each of his objectives was corrected. (See Ch. X.)

§ 115. **Water Immersion Objectives.**—Put a water immersion objective in position (§ 54) and the fly’s wing for object under

the microscope. Place a drop of distilled water on the cover-glass, and with the coarse adjustment lower the tube till the objective dips into the water, then light the field well and turn the fine adjustment one way and another till the image is clear. Water immersions are exceedingly convenient in studying the circulation of the blood, and for many other purposes where aqueous liquids are

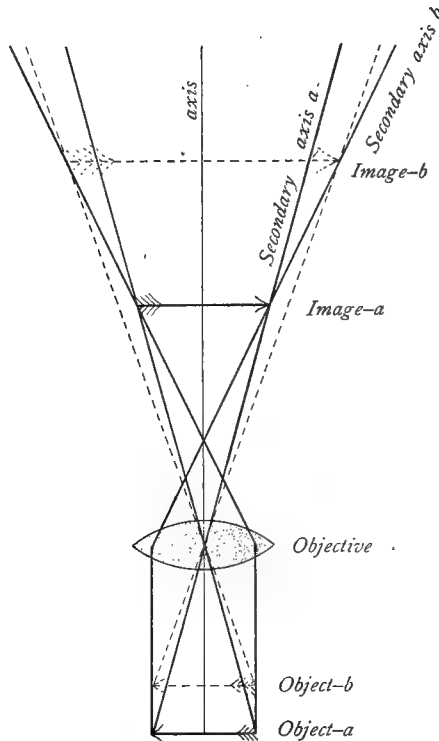

FIG. 65. Figure to show that in lengthening the tube of the microscope the object must be brought nearer the principal focus or center of the lens. It will be seen by consulting the figure that in shortening the tube of the microscope the object must be removed farther from the center of the lens. By consulting the figure showing the effect of the cover-glass (Fig. 64) it will be seen that the effect of the cover-glass is to bring the object nearer the objective, and the thicker the cover the nearer is the object brought to the objective. As shortening the tube serves to remove the object, it neutralizes the effect of the thick cover, and if the cover is so thin that it does not elevate the object enough for the corrections of the objective, then an increase in the tube-length will correct the defect.

liable to get on the cover-glass. If the objective is adjustable, follow the directions given in § 114.

When one is through using a water immersion objective, remove it from the microscope and with some lens paper wipe all the water from the front lens. Unless this is done dust collects and sooner or later the front lens will be clouded. It is better to use distilled water to avoid the gritty substances that are liable to be present in natural waters, as these gritty particles might scratch the front lens.

HOMOGENEOUS IMMERSION OBJECTIVES: EXPERIMENTS

§ 116. As stated above, these are objectives in which a liquid of the same refractive index as the front lens of the objective is placed between the front lens and the cover-glass.

§ 117. **Tester for Homogeneous Liquid.**—In order that full advantage be derived from the homogeneous immersion principle, the liquid employed must be truly homogeneous. To be sure that such is the case, one may use a tester like that constructed by the Gundlach Optical Co., then if the liquid is too dense it may be properly diluted and *vice versa*. For the cedar oil immersion liquid, the density may be diminished by the addition of pure cedar wood oil. The density may be increased by allowing it to thicken by evaporation. (See H. L. Smith, Proc. Amer. Soc. Micr., 1885, p. 83, and Ch. X.)

§ 118. **Refraction Images.**—Put a 2 mm. ($\frac{1}{12}$ in.) homogeneous immersion objective in position, employ an illuminator. Use some histological specimen like a muscular fiber as object, make the diaphragm opening about 9 mm. in diameter, add a drop of the homogeneous immersion liquid and focus as directed in § 83. The object will be clearly seen in all details by the unequal refraction of the light traversing it. The difference in color between it and the surrounding medium will also increase the sharpness of the outline. If an air bubble preparation (§ 88) were used, one would get pure, refraction images.

§ 119. **Color Images.**—Use some stained bacteria as *Bacillus tuberculosis* for object. Put a drop of the immersion liquid on the cover-glass or the front lens of the homogeneous objective. Re-

move the diaphragms from the illuminator or in case the iris diaphragm is used, open to its greatest extent. Focus the objective down so that the immersion fluid is in contact with both the front lens and the cover-glass, then with the fine adjustment get the bacteria in focus. They will stand out as clearly defined colored objects on a bright field.

FIG. 66. *Screen for shading the microscope and the face of the observer. This is very readily constructed as shown in the figure by supporting a wire in a disc of lead, iron, or heavy wood. The screen is then completed by hanging over the bent wire, black cloth or paper 30 x 40 cm. The lower edge of the screen should be a little below the stage of the microscope and the upper edge high enough to screen the eyes of the observer.*

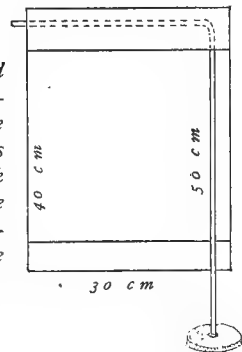

§ 120. **Shading the Object.**—To get the clearest image of an object no light should reach the eye except from the object. A handkerchief or a dark cloth wound around the objective will serve the purpose. Often the proper effect may be obtained by simply shading the top of the stage with the hand or with a piece of bristol board. Unless one has a very favorable light the shading of the object is of the greatest advantage, especially with homogeneous immersion objectives. The screen (Fig. 66) is the most satisfactory means for this purpose, as the entire microscope above the illuminating apparatus is shaded.

§ 121. **Cleaning Homogeneous Objectives.**—After one is through with a homogeneous objective, it should be carefully cleaned as follows: Wipe off the homogeneous liquid with a piece of the lens paper (§ 125), then if the fluid is cedar oil, wet one corner of a fresh piece in xylene or chloroform and wipe the front lens with it. Immediately afterward wipe with a dry part of the paper. The cover-glass of the preparation can be cleaned in the same way. If the homogeneous liquid is a glycerin mixture proceed as above, but use water to remove the last traces of glycerin.

CARE OF THE MICROSCOPE

§ 122. The microscope should be handled carefully and kept perfectly clean. The oculars and objectives should never be allowed to fall.

When not in use keep it in a place as free as possible from dust.

All parts of the microscope should be kept free from liquids, especially from acids, alkalies, alcohol, xylene, turpentine and chloroform.

§ 123. **Care of the Mechanical Parts.**—To clean the mechanical parts put a small quantity of some fine oil (olive oil or liquid vaselin and gasoline or xylene, equal parts), on a piece of chamois leather or on the lens paper, and rub the parts well, then with a clean dry piece of the chamois or paper wipe off most of the oil. If the mechanical parts are kept clean in this way a lubricator is rarely needed. When opposed brass surfaces "cut," *i. e.*, when from the introduction of some gritty material, minute grooves are worn in the opposing surfaces, giving a harsh movement, the opposing parts should be separated, carefully cleaned as described above and any ridges or prominences scraped down with a knife. Where the tendency to "cut" is marked, a very slight application of equal parts of beeswax and tallow, well melted together, serves a good purpose.

In cleaning lacquered parts, xylene alone answers well, but it should be quickly wiped off with a clean piece of the lens paper. Do not use alcohol as it dissolves the lacquer.

§ 124. **Care of the Optical Parts.**—These must be kept scrupulously clean in order that the best results may be obtained.

Glass surfaces should never be touched with the fingers, for that will soil them.

The glass of which the lenses are made is quite soft, consequently it is necessary that only soft, clean cloth or paper be used in wiping them.

Whenever an objective is left in position on a microscope, or when several are attached by means of a revolving nose-piece, an ocular should be left in the upper end of the tube to prevent dust from falling down upon the back lens of the objective.

§ 125. **Lens Paper.**—The so-called Japanese filter paper, which from its use with the microscope, I have designated lens paper,

has been used in the author's laboratory since 1885 for cleaning the lenses of oculars and objectives, and especially for removing the fluid used with immersion objectives. Whenever a piece is used once it is thrown away. It has proved more satisfactory than cloth or chamois, because dust or sand is not present; and from its bibulous character it is very efficient in removing liquid or semi-liquid substances.

§ 126. **Removal of Dust.**—*Dust* may be removed with a camel's hair brush, or by wiping with the lens paper.

Cloudiness may be removed from the glass surfaces by breathing on them, then wiping quickly with a soft cloth or the lens paper.

Cloudiness on the inner surfaces of the ocular lenses may be removed by unscrewing them and wiping as directed above. A high objective should never be taken apart by an inexperienced person.

If the cloudiness cannot be removed as directed above, moisten one corner of the cloth or paper with 95 per cent alcohol, wipe the glass first with this, then with the dry cloth or the paper.

Water may be removed with soft cloth or the paper.

Glycerin may be removed with cloth or paper saturated with distilled water; remove the water as above.

Blood or other albuminous material may be removed while fresh with a moist cloth or paper, the same as glycerin. If the material has dried on the glass, it may be removed more readily by adding a small quantity of ammonia to the water in which the cloth is moistened, (water 100 cc., ammonia 1 cc).

Canada Balsam, damar, paraffin, or any oily substance may be removed with a cloth or paper wet with chloroform, gasoline or xylene. The application of these liquids and their removal with a soft dry cloth or paper should be as rapid as possible, so that none of the liquid will have time to soften the setting of the lenses.

Shellac Cement may be removed by the paper or a cloth moistened in 95 per cent. alcohol.

Brunswick Black, Gold Size, and all other substances soluble in chloroform, etc., may be removed as directed for balsam and damar.

In general, use a solvent of the substance on the glass and wipe it off quickly with a fresh piece of the lens paper.

It frequently happens that the upper surface of the back combination of the objective becomes dusty. This may be removed in part by a brush, but more satisfactorily by using a piece of the soft paper loosely twisted. When most of the dust is removed some of the paper may be put over the end of a pine stick (like a match stick) and the glass surfaces carefully wiped.

CARE OF THE EYES

§ 127. Keep both eyes open, using the eye-screen if necessary (Fig. 67); and divide the labor between the two eyes, *i. e.* use one eye for observing the image awhile and then the other. In the beginning it is not advisable to look into the microscope continuously for more than half an hour at a time. One never should work with the microscope after the eyes feel fatigued. After one

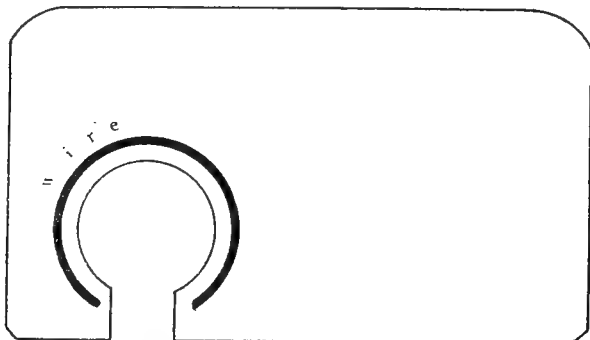

FIG. 67. *Adjusting Eye-Shade.* This is prepared by covering a card about 6 x 12 centimeters with black velveteen. A copper wire about 3 mm. ($\frac{1}{8}$ in.) and of the right length is curved as shown in the figure. Its ends are rounded, and finally it is put under the cloth and sewed carefully all around. The card and cloth are then cut as shown. The flexible wire makes it possible to put the screen on the tube at any level.

becomes accustomed to microscopic observation he can work for several hours with the microscope without fatiguing the eyes. This is due to the fact that the eyes become inured to labor like the other organs of the body by judicious exercise. It is also due to the fact that but very slight accommodation is required of the eyes, the eyes remaining nearly in a condition of rest as for distant objects. The

fatigue incident upon using the microscope at first is due partly at least to the constant effort on the part of the observer to remedy the defects of focusing the microscope by accommodation of the eyes. This should be avoided and the fine adjustment of the microscope used instead of the muscles of accommodation. With a microscope of the best quality, and suitable light—that is light which is steady and not so bright as to dazzle the eyes nor so dim as to strain them in determining details—microscopic work should improve rather than injure the sight.



LABORATORY TABLE

FIG. 68. *Laboratory Table with adjustable stool.*

§ 128. Position and Character of the Work Table.—

The work-table should be very firm and large (60 x 120 cm.; 24 x 48 in.), so that the necessary apparatus and material for work may not be too crowded. The table should also be of the right height to make work by it comfortable. An adjustable stool, something like a piano stool is convenient, then one may vary the height corres-

ponding to the necessities of special cases. It is a great advantage to sit facing the window if daylight is used, then the hands do not constantly interfere with the illumination. To avoid the discomfort of facing the light a screen like that shown here and in Fig. 66 is very useful (see also under lighting, § 71).

TESTING THE MICROSCOPE

§ 129. *Testing the Microscope.*—To be of real value this must be accomplished by a person with both theoretical and practical knowledge, and also with an unprejudiced mind. Such a person is not common, and when found does not show over anxiety to pass judgement. Those most ready to offer advice should as a rule be avoided, for in most cases they simply “have an ax to grind,” and are sure to commend only those instruments that conform to the “fad” of the day. From the writer’s experience it seems safe to say that the

inexperienced can do no better than to state clearly what he wishes to do with a microscope and then trust to the judgement of one of the optical companies. The makers of microscopes and objectives guard with jealous care the excellence of both the mechanical and optical part of their work, and send out only instruments that have been carefully tested and found to conform to the standard. This would be done as a matter of business prudence on their part, but it is believed by the writer that microscope makers are artists first and take an artist's pride in their work; they therefore have a stimulus to excellence greater than business prudence alone could give.

§ 130. **Mechanical Parts.**—All of the parts should be firm, and not too easily shaken. Bearings should work smoothly. The mirror should remain in any position in which it is placed.

Focusing Adjustments.—The coarse or rapid adjustment should be by rack and pinion, and work so smoothly that even the highest power can be easily focused with it. In no case should it work so easily that the body of the microscope is liable to run down and plunge the objective into the object. If any of the above defects appear in a microscope that has been used for some time, a person with moderate mechanical instinct will be able to tighten the proper screw, etc.

The Fine Adjustment is more difficult to deal with. From the nature of its purpose unless it is approximately perfect, it would be better off the microscope entirely. It has been much improved recently.

It should work smoothly and be so balanced that one cannot tell by the feeling when using it whether the screw is going up or down. Then there should be absolutely no motion except in the direction of the optic axis, otherwise the image will appear to sway even with central light. Compare the appearance when using the coarse and when using the fine adjustment. There should be no swaying of the image with either if the light is central (§ 88).

§ 131. **Testing the Optical Parts.**—As stated in the beginning, this can be done satisfactorily only by an expert judge. It would be of very great advantage to the student if he could have the help of such a person. *In no case is a microscope to be condemned by an inexperienced person.* If the beginner will bear in mind that his failures are due mostly to his own lack of knowledge and lack of skill; and will truly endeavor to learn and apply the principles laid down in this and in the standard works referred to, he will learn after a while to estimate at their true value all the pieces of his microscope. (See Ch. X).

LABORATORY AND HIGH-SCHOOL COMPOUND MICROSCOPES

§ 132. **Optical Parts.**—A great deal of beginning work with the microscope in biological laboratories is done with simple and inexpensive apparatus.

Indeed if one contemplates the large classes in the high schools, the universities and medical schools, it can be readily understood that microscopes costing from \$25 to 50 each and magnifying from 25 to 500 diameters, are all that can be expected. But for the purpose of modern histological investigation and of advanced microscopical work in general, a microscope should have something like the following character: Its optical outfit should comprise, (a) dry objectives of 50 mm. (2 in.), 16–18 mm. ($\frac{3}{4}$ in.) and 3 mm. ($\frac{1}{8}$ in.) equivalent focus. There should be present also a 2 mm. ($\frac{1}{2}$ in.) or 1.5 mm. ($\frac{1}{16}$ in.) homogeneous immersion objective. Of oculars there should be several of different power. A centering substage condenser, and an Abbe camera lucida are also necessities, and a micro-spectroscope and a micro-polarizer are very desirable.

Even in case all the optical parts cannot be obtained in the beginning, it is wise to secure a stand upon which all may be used when they are finally secured.

As to the objectives. The best that can be afforded should be obtained. Certainly at the present, the apochromatics stand at the head, although the best achromatic objectives approach them very closely.

§ 133. Mechanical Parts or Stand.—The stand should be low enough so that it can be used in a vertical position on an ordinary table without inconvenience; it should have a jointed (flexible) pillar for inclination at any angle to the horizontal. The adjustments for focusing should be two,—a coarse adjustment or rapid movement with rack and pinion, and a fine adjustment by means of a micrometer screw. Both adjustments should move the entire tube of the microscope. The body or tube should be short enough for objectives corrected for the short or 160 millimeter tube-length. It is an advantage to have the draw-tube graduated in centimeters and millimeters. The lower end of the draw tube and of the tube should each possess a standard screw for objectives (frontispiece). The stage should be quite large for the examination of slides with serial sections and other large objects. The substage fittings should be so arranged as to enable one to use the condenser or to dispense entirely with diaphragms. The condenser mounting should allow up and down motion.

§ 134. Quality and Cost.—In order that teachers and students may get a good general idea of the appearance of microscopes of various makers for high school and advanced laboratory work a few pictures are appended of the microscopes most used in the United States. This has been rendered possible by the courtesy of the manufacturers or importers. The microscopes are arranged in alphabetical order of the makers.

Laboratory microscopes which will answer nearly all the requirements for work in Biology, including Histology, Embryology, Pathology and Bacteriology, are listed in the makers catalogs at about \$75.00. The less expensive microscopes shown are listed at \$25 to \$45. Fortunately in the State of New York the State pays half for high school apparatus, so that there is no reason why every high school should not be properly equipped with microscopes of a good grade. To avoid misunderstanding it should be added that the quality of the oculars and objectives on the high school microscopes figured is the same as

for the best laboratory microscopes. The mechanical work also is of excellent quality.

During the last few years great vigor has been shown in the microscopical world. This has been stimulated largely by the activity in biological science and the widespread appreciation of the microscope, not only as a desirable, but as a necessary instrument for study and research. The production of the new kinds of glass, (Jena glass), and the apochromatic objectives has been a no less potent factor in promoting progress. The student is advised to write to one or more of the opticians for complete catalogs. (See list, p. 2 of cover).

STANDARD SIZES RECOMMENDED BY THE ROYAL MICROSCOPICAL SOCIETY

§ 135. **Society Screw.**—Owing to the lack of uniformity in screws for microscope objectives, the Royal Microscopical Society of London, in 1857, made an earnest effort to introduce a standard size.

In order to facilitate the introduction of this universal screw, or as it soon came to be called "*The Society Screw*," the Royal Microscopical Society undertook to supply standard taps. From the mechanical difficulty in making these taps perfect there soon came to be considerable difference in the "Society Screws," and the object of the society in providing a universal screw was partly defeated. (See Edward Bausch, *Trans. Amer. Micr. Soc.*, 1884, p. 153.)

In 1884 the American Microscopical Society appointed Mr. Edward Bausch and Prof. William A. Rogers upon a committee to correspond with the Royal Microscopical Society, with a view to perfecting the standard "Society Screw," or of adopting another standard and of perfecting methods by which the screws of all makers might be truly uniform. Although this matter was earnestly considered at the time by the Royal Microscopical Society, the mechanical difficulties were so great that the improvements were abandoned.

Fortunately, however, during the year 1896 that society again took hold of the matter in earnest, and the "Society Screw" is now accurate, and facilities for obtaining the standard are so good that there is a reasonable certainty that the universal screw for microscopic objectives may be realized. It is astonishing to see how widely the "Society Screw" has been adopted. Indeed there is not a maker of first-class microscopes in the world who does not supply the objectives and stands with the "Society Screw," and an objective in England or America which does not have this screw should be looked upon with suspicion. That is, it is either old, cheap, or not the product of one of the great opticians. For the Standard, or "Society Screw," see: *Trans. Roy. Micr. Soc.*, 1857, pp. 39-41; 1859, pp. 92-97; 1860, pp. 103-104. (All to be found in *Quar. Jour. Micr. Sci.*, o. s., vols. VI, VII, VIII). *Proc. Amer. Micr. Soc.* 1884, p. 274; 1886, p. 199; 1893, p. 38. *Journal of the Royal Microscopical Society*, August, 1896.

In this last paper of four pages the matter is very carefully gone over and full specifications of the new screw given. It conforms almost exactly with the original standard adopted by the society, but means have been devised by which it may be kept standard.

This paper is of so much importance historically and practically that it deserves to appear in every work on the modern microscope. It is therefore here repeated entire :

FROM THE JOURNAL OF THE ROYAL MICROSCOPICAL SOCIETY

AUGUST, 1896

"The Royal Microscopical Society's Standard Screw-Thread for Nose-piece and Object-Glasses of Microscopes."

"Being the report of a sub-committee of the Council, drawn up by Conrad Beck, F.R.M.S., Secretary to the Sub-Committee. Read June 17th, 1896."

"The so-called Standard Screw-Thread of the Royal Microscopical Society has been but an imperfect standard, and has not ensured that interchangeability which it originally promised. It has been our duty to investigate the causes of this state of affairs, and to formulate a plan by which such an inconvenience should be remedied in the future."

"Without going too closely into the entire history of the subject, we propose to briefly explain the reasons why the original standard was not efficient for practical purposes, and then to state the plan which the Council of the Royal Microscopical Society has now adopted for the future."

The specification of the original standard screw was as follows :

§ 136. Form of Thread.—"Whitworth thread, *i. e.*, a V-shaped thread, sides of thread inclined at an angle of 55° to each other, one-sixth of the V depth of the thread being rounded off at the top of the thread, and one-sixth of the thread being rounded off at the bottom of the thread."

"Pitch of Screw, 36 to the inch.

Length of Thread on Object-Glass, 0.125 in.

Plain Fitting above Thread of Object-Glass 0.15 in. long, to be about the size of the bottom of male thread.

Length of Thread of Nose-Piece not less than 0.125 in.

Diameter of the Object-Glass Screw at the bottom of the screw, 0.7626 in.

Diameter of the Nose-Piece Screw at the bottom of the thread, 0.8 in."

"When the exact form of the Whitworth screw-thread is calculated it will be found that this allows a difference between the male and female screw of 0.0018 in., which is in itself quite sufficient margin of looseness to make an easy fit."

"The society had two plug and ring gauges, one 0.8 in., and the other 0.7626 in., made by Whitworth as standards for the use of the Society, and it has been shown that if an adjustable tap and die (as recommended by the late Mr. Richard Beck in a paper printed in the "Transactions of the Microscopical Society," 1859, p. 92) be made which could be accurately adjusted to these standard sizes so that the tap exactly fitted the 0.8 in. ring size, and the die

exactly fitted the 0.7626 in. plug, the exact standard screw as originally suggested could be adhered to. These adjustable taps and dies were not used for cutting the thread, but for passing over each thread after it had been cut to approximately the right size. That this method will work satisfactorily, is evidenced by the fact that in the late Mr. Richard Beck's firm the method has been in successful operation ever since."

"The use, however, of such a system involved the necessity of every maker being provided with adjustable tap and die, and also the two pairs of plug and ring Whitworth sizes, together with a means of accurately sharpening the adjustable tap and die. And it was found in practice that microscope makers were not universally prepared to go to such an outlay for a matter which at that time did not appear to be of such importance as has since proved to be the case."

"Therefore the Society issued solid taps, and finding that, as is well known to be the case, a solid tap could not be made to an exactly accurate size owing to the alteration of the steel during the process of hardening and tempering, they had them made somewhat larger than the standard 0.8 in. gauge. An additional reason for their being larger was to allow for the slight wearing of the tap after prolonged use."

"Here, however, there was no record of the amount larger which the taps were made, and although the first set appear to have been carefully manufactured, those which were from time to time obtained were less and less like the original, and in this manner a discrepancy arose which the arrangements now adopted by the Council are intended to correct for the future."

"Beyond the fact that the Council specify that the diameter of the plain fitting of the object-glass should be as near as possible to, but not exceeding 0.759 in., and that the length of this fitting has been reduced to 0.1 in., the original specification of the standard screw is only altered as to the exact diameters of the screw itself."

"The original specification of these diameters allowed only 0.0018 for clearance between the male and female screw."

"If absolutely exact sizing taps and dies could be made which should not wear, the original diameters might have been adhered to, but as has been previously pointed out, adjustable dies in connection with gauges, etc., are requisite for this."

"The Council has been able to obtain taps and dies which are guaranteed not to vary more than $1/1000$ of an inch larger or smaller than the nominal size. And they are therefore having manufactured a series of taps of the nominal diameter on the top of the screw-thread of 0.8015 in. which will not vary more than from 0.8005 in. to 0.8025 in. To insure this the Council has ordered a Whitworth plug and ring, size 0.803 in. in diameter, and no tap will be allowed to be stamped with the Society's stamp unless it will pass easily through this 0.803 in. ring, and unless it is of such a size that it will not enter the 0.8 in. standard gauge already in the Society's possession."

"They are also having made a series of dies of the nominal inside diameter on the top of the thread of 0.7611 in., which will not vary more than from 0.7601 to 0.7621. To test this the Council has ordered a Whitworth plug and

ring, size 0.7596 in. diameter, and no die will be allowed to be stamped with the Society's stamp unless it will pass easily over the 0.7596 in. plug and will not pass over the 0.7626 in. plug."

"These taps and dies will be for sale almost immediately, at cost price, 2*l.* 15*s.* for each pair of tap and dies, and it is earnestly requested that every maker of Microscopes will possess himself of a pair of these sizing gauges."

"The Council believe that at such time as these sizing taps and dies have come into universal use the standard screw-thread will have been put upon a permanent basis, and complete interchangeability of all object-glasses will have been established."

§ 137. New Specification of the Royal Microscopical Society Standard Screw.

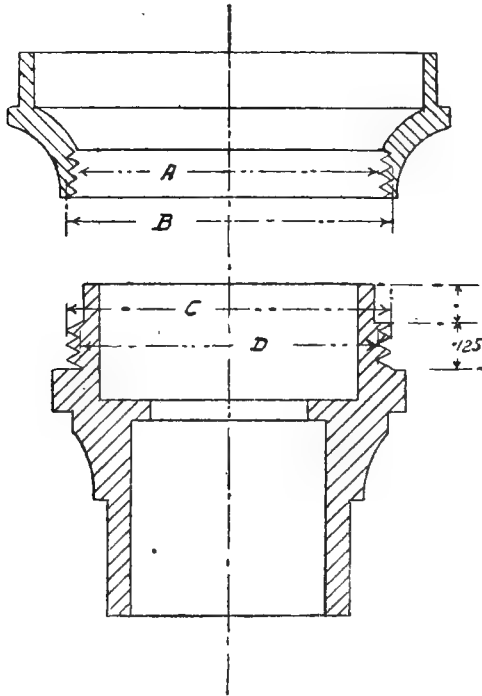

FIG. 69

"Thread.—Whitworth screw, *i. e.*, a V-shaped thread, sides of thread inclined at an angle of 55° to each other, one-sixth of the V depth being rounded off at the top and the bottom of the thread.

Pitch.—36 to the inch.

Length of Thread on Object-Glass 0.125 in.

Plain Fitting above Thread of Object-Glass 0.1 in. long, not to exceed 0.759 in. in diameter.

Diameter (C) of Thread on Object-Glass at top of thread not to exceed 0.7982 in., or to be less than 0.7952 in.

Diameter (D) of Thread on Object-Glass at bottom of thread not to exceed 0.7626 in., or to be less than 0.7596 in.

Length of Screw of Nose-Piece to be not less than 0.125 in.

Diameter of Screw of Nose-Piece (A) at top of thread not to exceed 0.7674 in., or be less than 0.7644 in.

Diameter of Screw of Nose-Piece (B) at bottom of thread not to exceed 0.803 in., or be less than 0.8 in."

§ 138. **Standard Size Oculars and Substage Condensers.**—For a consideration of these, with measurements, see § 53, 98.

MARKERS AND MECHANICAL STAGES

Markers are devices to facilitate the finding of some object or part which it is especially desired to refer to again or to demonstrate to a class. The mechanical stage makes it much easier to follow out a series of objects, to move the slide when using high powers, and for complete exploration of a preparation. Most of the mechanical stages have scales or scales and verniers by which an object once recorded may be readily found again.

§ 139. **Marker for Preparations.** (Figs. 70-72).—This instrument consists of an objective-like attachment which may be screwed into the nose-piece of the microscope. It bears on its lower end a small brush and the brush can be made more or less eccentric and can be rotated, thus making a larger or smaller circle. In using the marker the brush is dipped in colored shellac or other cement and when the part of the preparation to be marked is found and put exactly in the middle of the field the objective is turned aside and the marker turned into position. The brush is brought carefully in contact with the cover-glass and rotated. This will make a delicate ring of the colored cement around the object. Within this very small area the desired object can be easily found on any microscope. The brush of the marker should be cleaned with 95% alcohol after it is used. (Proc. Amer. Micr. Soc., 1894, pp. 112-118.)

§ 140. **Pointer in the Ocular.**—The Germans have a pointer ocular (Spitzen-Okular), an ocular with one or two delicate rods or pointers at the level of the real image, that is, at the level of the diaphragm (Figs. 26, 36, D). For the purposes of demonstrating any particular structure or object in the field, a temporary pointer may be easily inserted in any ocular as follows: Remove the eye-lens and with a little mucilage or Canada Balsam fasten a hair from a camel's hair or other fine brush to the upper surface of the

diaphragm (Fig. 36D) so that it will project about half way across the opening. If one uses this ocular, the pointer will appear in the field and one can place the specimen so that the pointer indicates it exactly, as in using a pointer on a diagram or on the black-board. It is not known to the author who devised this method. It is certainly of the greatest advantage in demonstrating objects like amoebas or white blood corpuscles to persons not familiar with them, as the field is liable to have in it many other objects which are more easily seen.

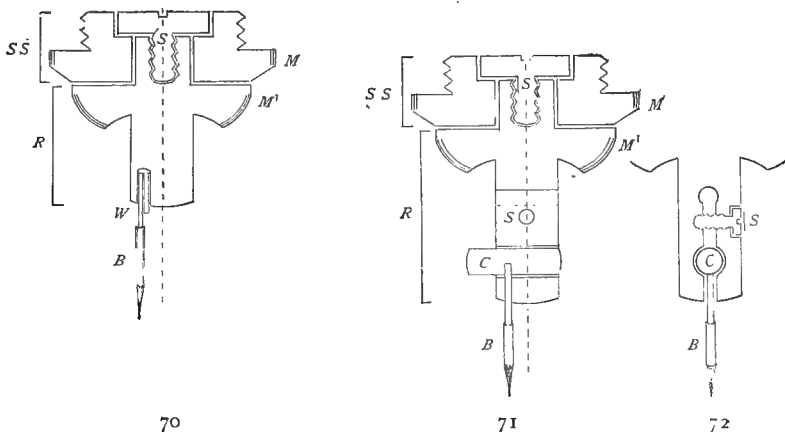

FIGS. 70-72. Sectional Views of the two Forms of the Marker.

FIG. 70. *The simplest form of marker. It consists of the part SS with the milled edge (M). This part bears the society or objective screw for attaching the marker to the microscope. R. Rotating part of the marker. This bears the eccentric brush (B) at its lower end. The brush is on the wire (W). This wire is eccentric, and may be made more or less so by bending the wire. The central dotted line coincides with the axis of the microscope. The revolving part is connected with the "Society Screw" by the small screw (S).*

FIG. 71. *SS, R, and B. All parts same as with Fig. 70, except that the brush is carried by a sliding cylinder the end view being indicated in Fig. 72.*

§ 141. **Mechanical Stage.**—For High School and ordinary laboratory work a mechanical stage is not needed; but for much work, especially where high objectives are used a mechanical stage is of great advantage. It is also advantageous if the mechanical stage can be easily removed.

The one found on the most expensive American and English microscopes for the last twenty years and the one now present on the larger continental microscopes, is excellent for high powers and preparations of moderate dimensions, but for the study of serial sections and large sections or preparations in general, mechanical stages like those shown in Figs. 79-89 are more useful. This form of mechanical stage has the advantage of giving great lateral and forward and

backward motion. It is a modification of the mechanical stage of Tolles. The modification consists in doing away with the thin plate and having a clamp to catch the ends of the glass slide. The slide is then moved on the face of the stage proper. This modification was first made by Mayall. It has since been modified by Reichert, Zeiss, Leitz, and others in Europe and by the Bausch & Lomb Optical Co., Queen & Co., and the Spencer Lens Co., in America.—*Jour. Roy. Micr. Soc.*, 1885, p. 122. See also *Zeit. Wiss. Mikroskopie* (II) 1885, pp. 289-295; 1887 (IV, pp. 25-30).

Those figured below have the great advantage of ready removal from the stage of the microscope, thus leaving it free. They have also the very excellent feature that with them one can explore an entire slide full of serial sections, as the sections are ordinarily mounted, *i.e.*, under a cover-glass 24×50 mm.

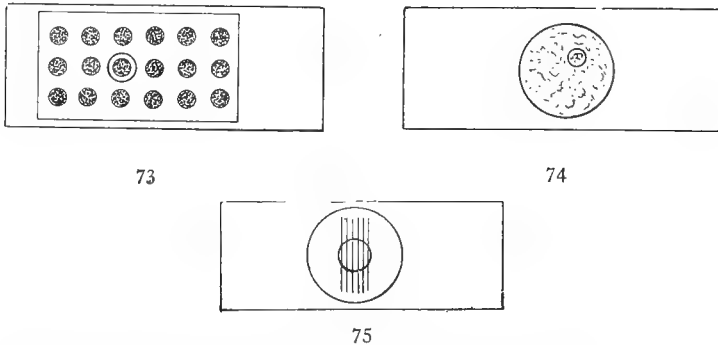

FIGS. 73-75. *Specimens Showing the Use of the Marker.*

In Fig. 73 a section of a series is marked to indicate that this section shows something especially well. In Fig. 74 some blood corpuscles showing ingested carbon very satisfactorily are surrounded by a minute ring, and in Fig. 75 the lines of a micrometer are ringed to facilitate finding the lines.

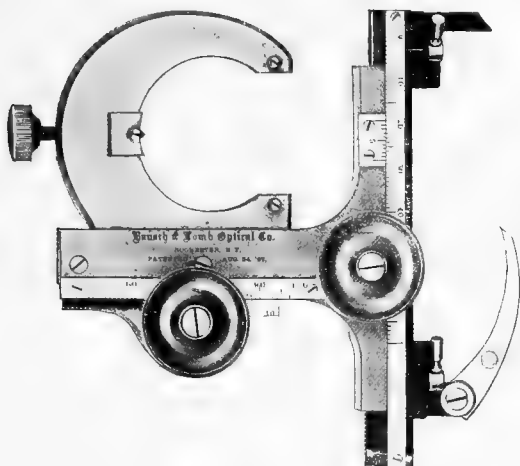

FIG. 76. *The Bausch & Lomb Optical Co's Detachable Mechanical Stage.*

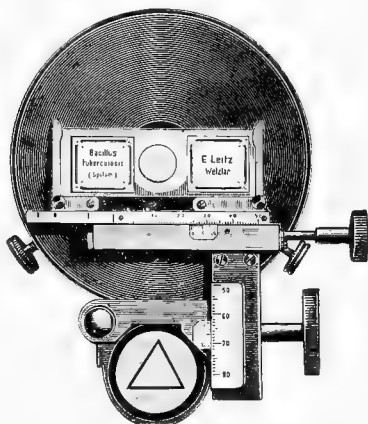

FIG. 77. *The Detachable Mechanical Stage of Leitz.*

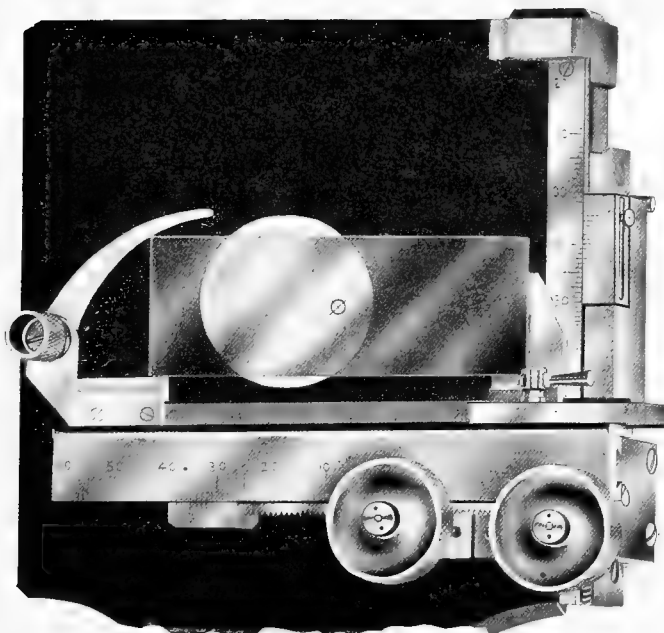

FIG. 78. *The Spencer Lens Co's Detachable Mechanical Stage of Great Range.*

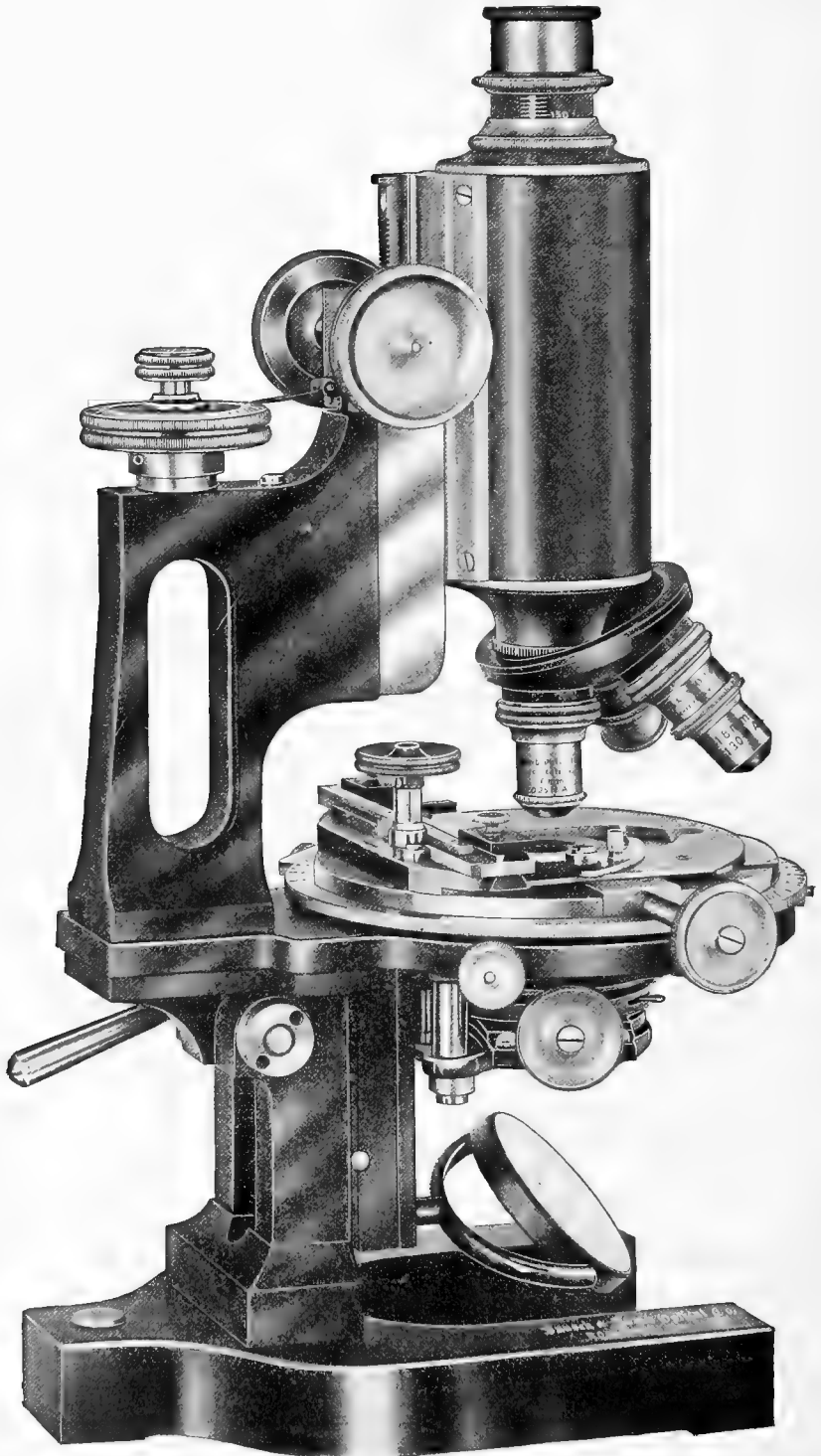

FIG. 79. *The Bausch & Lomb Optical Co's New Model DDH Microscope.*

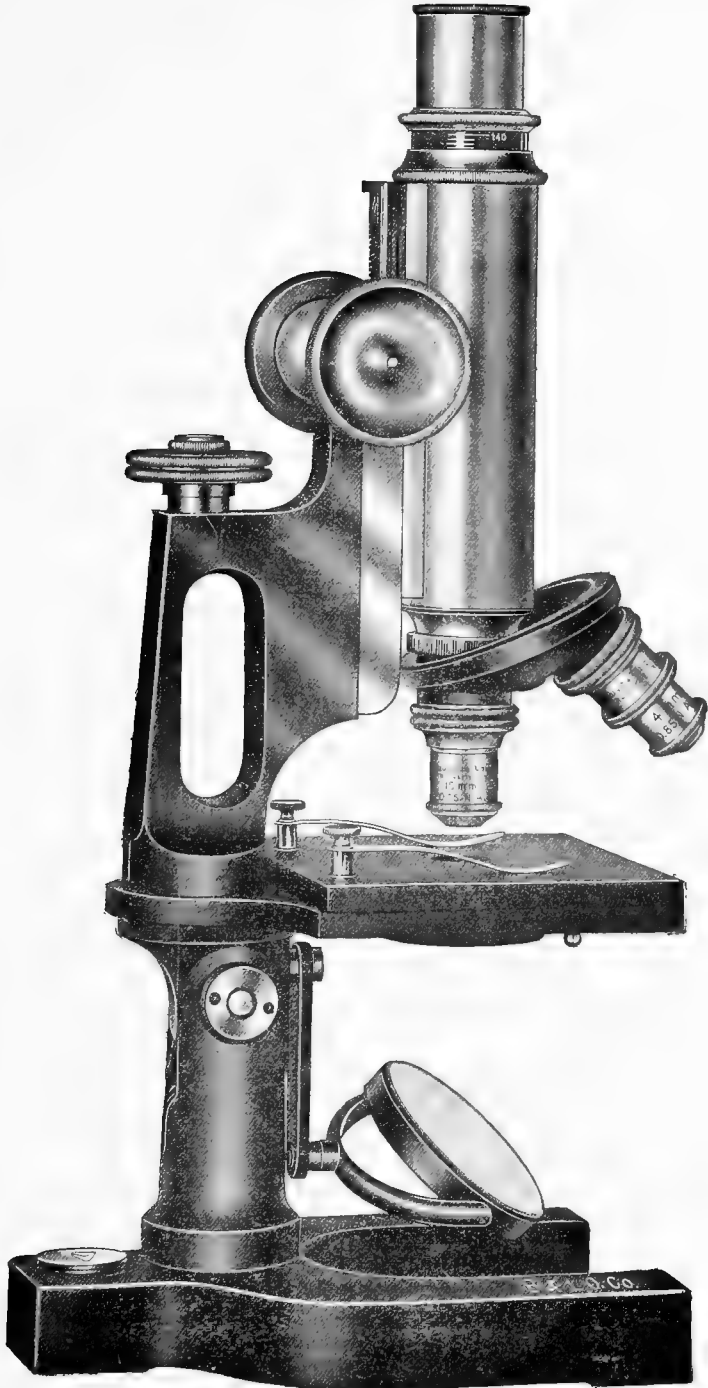

FIG. 80. *The Bausch & Lomb Optical Co's Microscope BH. Handle Type.*

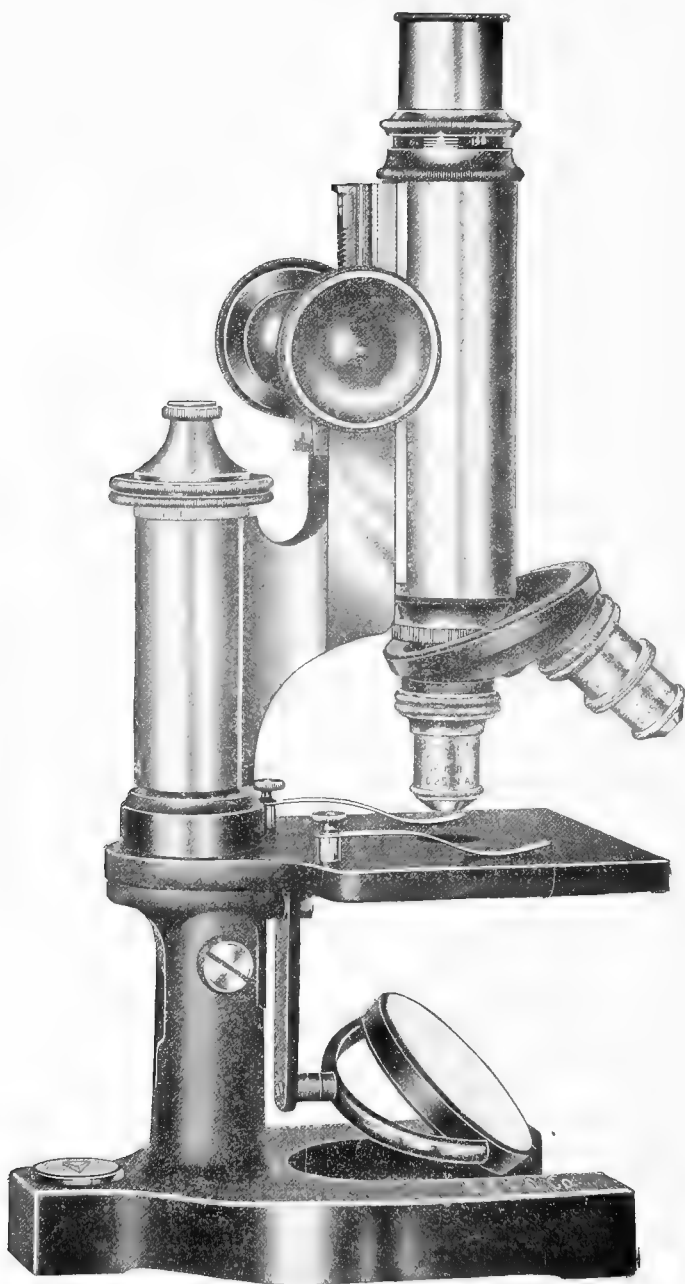

FIG. 81. *The Bausch & Lomb Optical Co's Microscope B without Handle.*

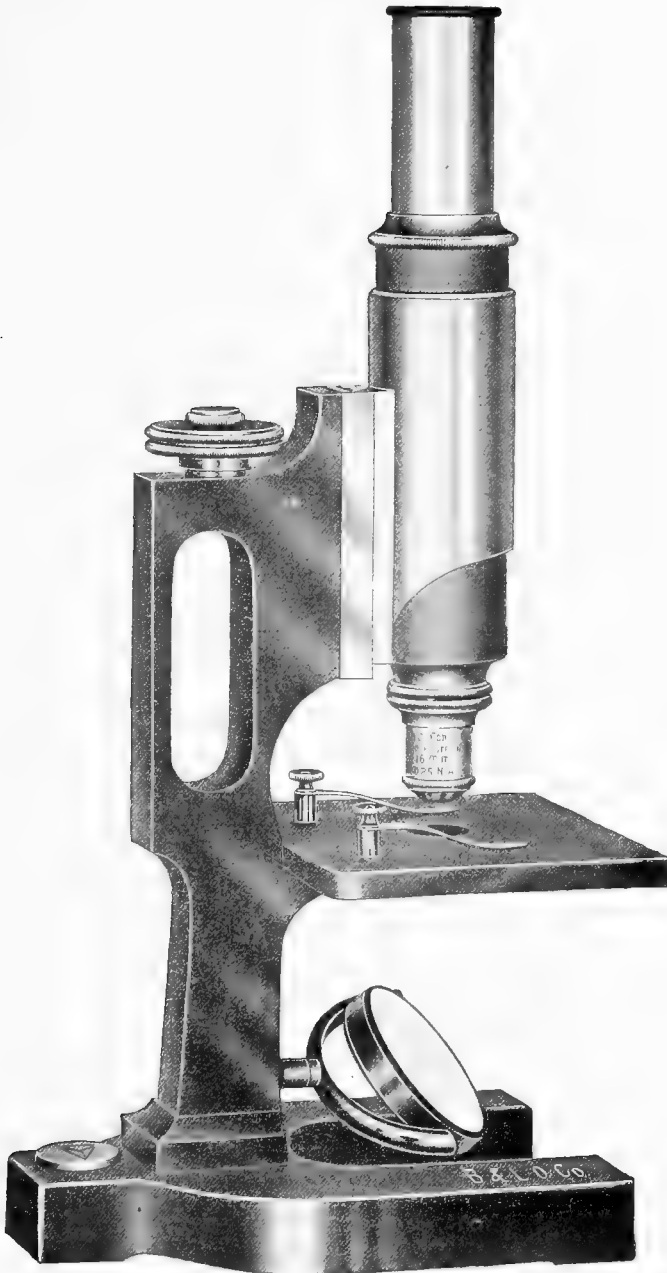

FIG. 82. *The Bausch & Lomb Optical Co's Model A H Microscope, Handle Type. The coarse adjustment is by a sliding tube, and the pillar is not jointed. See also Fig. 140 on p. 178.*

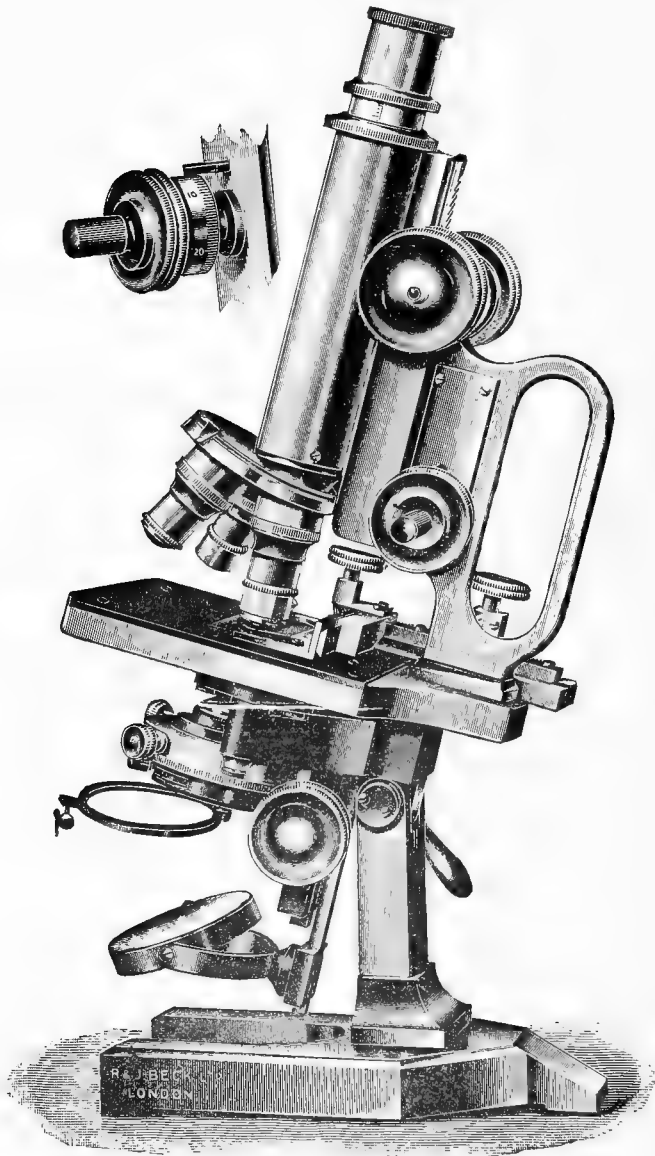

FIG. 83. *Beck's London Microscope, Regents Model, with Handle and New Fine Adjustment. See also Fig. 155.*

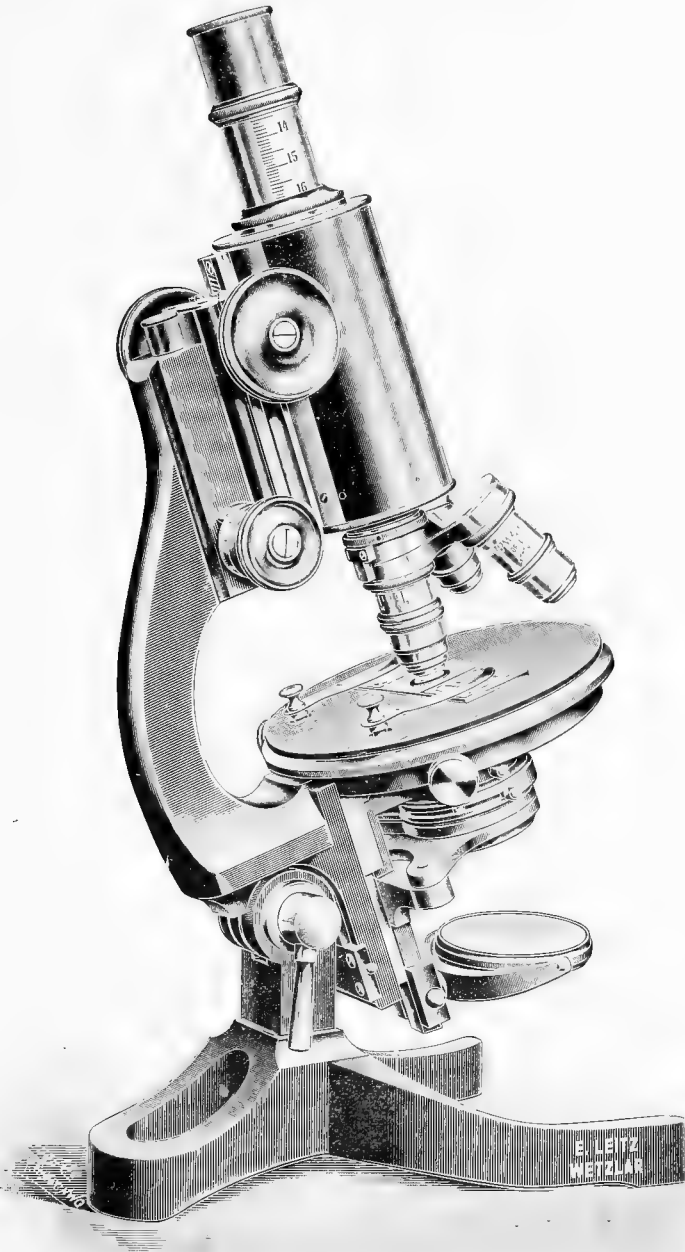
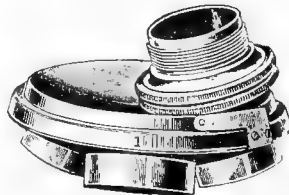
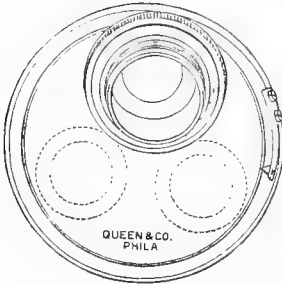
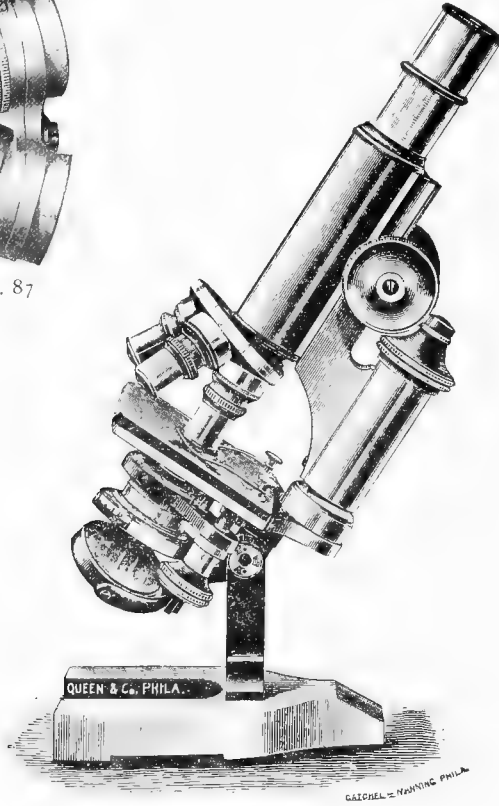

FIG. 84. *Leitz Universal Microscope, Stand A with Large Tube and Special Fine Adjustment. See also Figs. 142, 150.*



FIG. 87



FIGS. 85, 86. *Queen & Co's Continental Microscope, No. II. Dust-proof, triple nose-piece. The difference between this and the ordinary form can be seen by comparing with Fig. 87. This form of revolving nose-piece has been made for many years by Winkel of Göttingen. See legend of Fig. 40.*



FIG. 88. *Reichert's Laboratory Microscope with Handle. This handle is so attached that it does not preclude the ordinary means for fine adjustment.*



FIG. 89. *The Spencer Lens Co's New Model No. 10 Microscope especially for Photo-Micrography.*

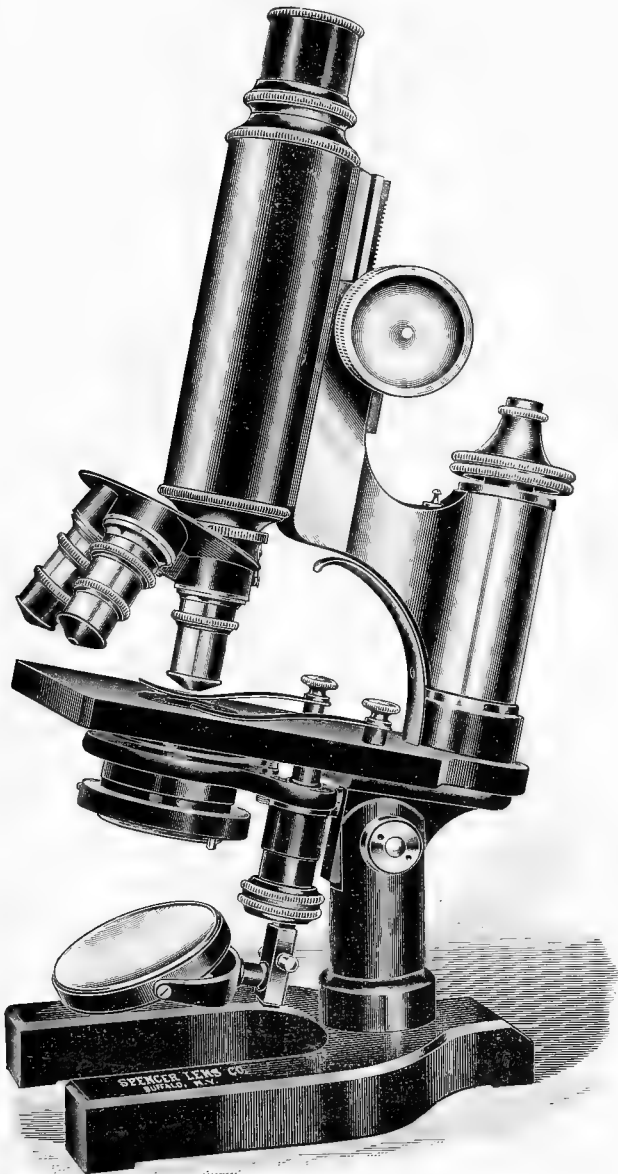

FIG. 90. *The Spencer Lens Co's Microscope No. 40 with curved Spring inside the Arm and Pillar so that they may be safely used as a Handle.*



FIG. 91. *The Spencer Lens Co's Microscope No. 36 with an extra large Stage.*

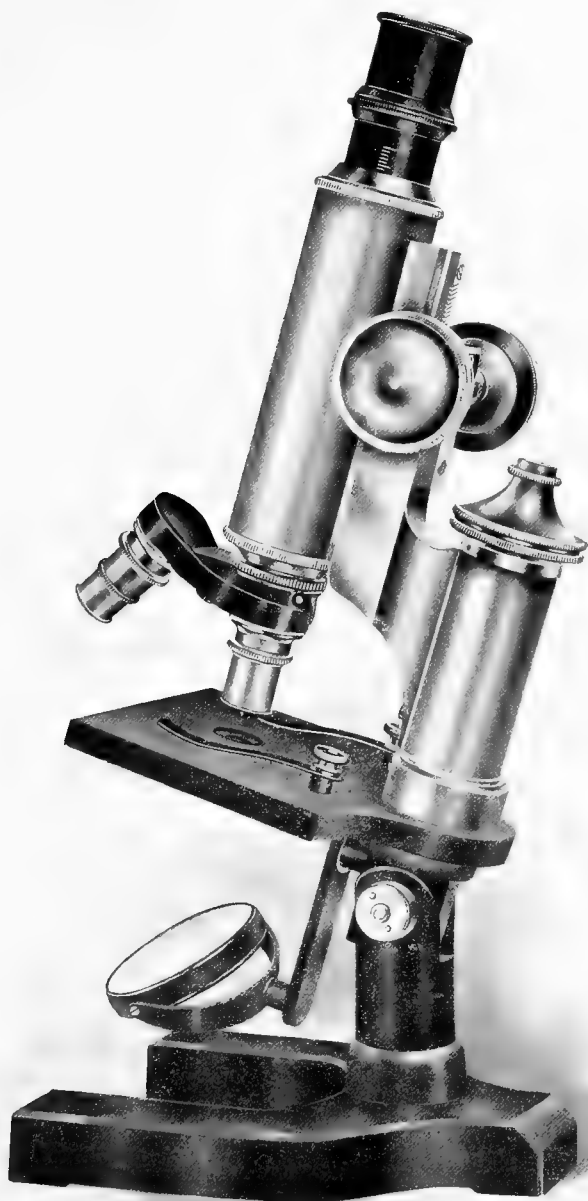

FIG. 92. *The Spencer Lens Co's Microscope No. 70 with double Nose-Piece and no Condenser.*

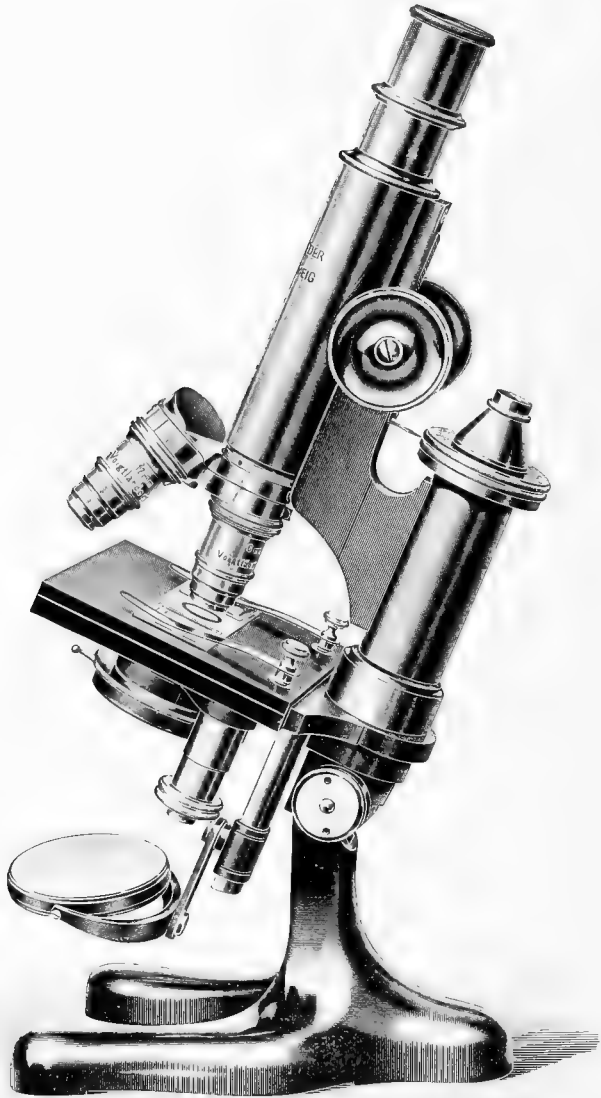

FIG. 93. *Voigtländer & Sohn's Laboratory Microscope No. IV.*
For their large Stand, see Fig. 179.

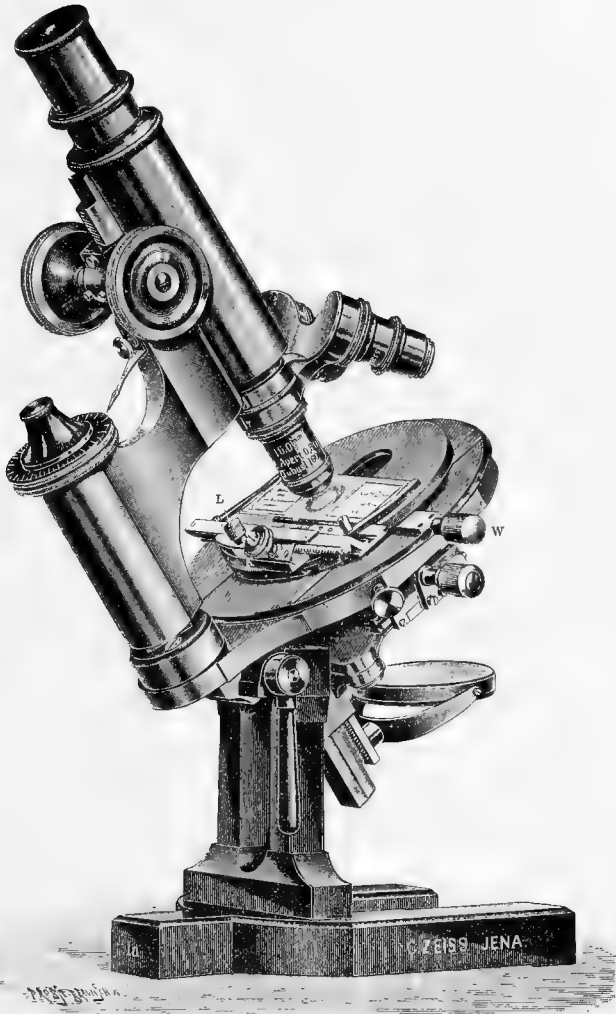

FIG 94. *Zeiss Microscope 1st with Mechanical Stage. This figure from Zeiss' Catalog No. 30, represents the Continental Model of Microscope in its most perfect form.*

K. Milled head of the screw for the lateral movements of the stage.

L. Screw for fixing the laterally moving mechanism of the stage. By unscrewing this the laterally moving part may be removed, leaving the plain stage.

W. Screw for moving the stage forward and backward.

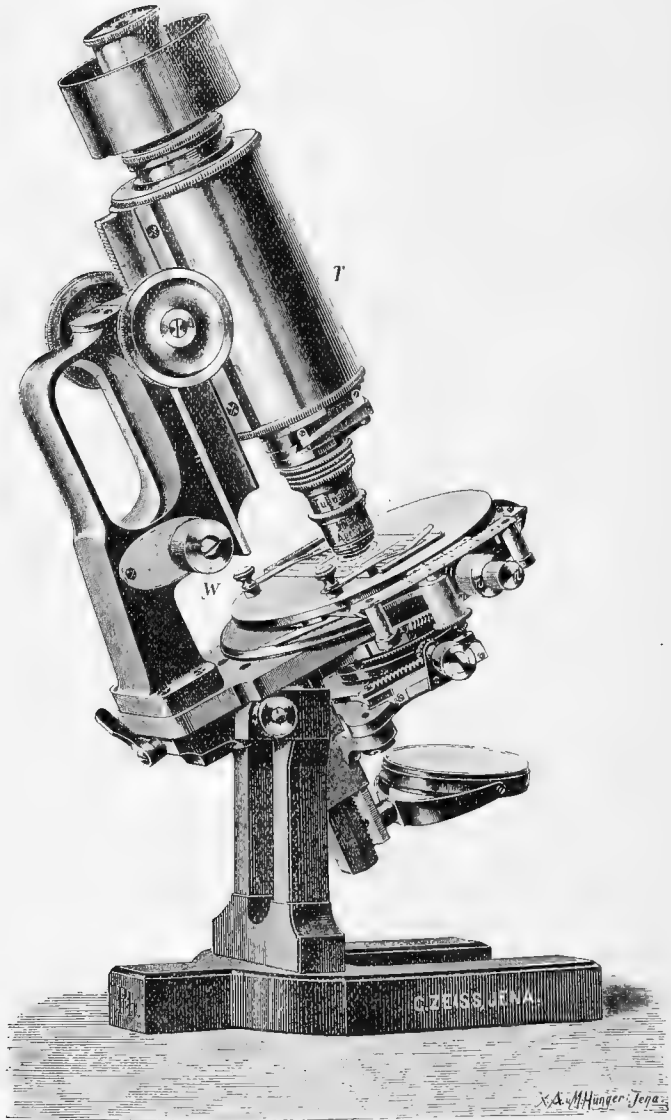

FIG. 95. *Zeiss Stand 1° for Photo-Micrography*

CHAPTER III

INTERPRETATION OF APPEARANCES

APPARATUS AND MATERIAL FOR CHAPTER III

A laboratory, compound microscope (§ 132); Preparation of fly's wing, 50 per cent glycerin; Slides and covers; Preparation of letters in stairs (Fig. 96). Mucilage for air-bubbles and olive or clove oil for oil-globules (§ 149-152). Solid glass rod; and glass tube (§ 157-159); Collodion (§ 159); Carmine, India ink, or lamp black (§ 161-163); Frog, castor oil and micro-polariscope (§ 164).

INTERPRETATION OF APPEARANCES UNDER THE MICROSCOPE

§ 142. **General Remarks.**—The experiments in this chapter are given secondarily for drill in manipulation, but primarily so that the student may not be led into error or be puzzled by appearances which are constantly met with in microscopical investigation. Anyone can look into a microscope, but it is quite another matter to interpret correctly the meaning of the appearances seen.

It is especially important to remember that the more of the relations of any object are known, the truer is the comprehension of the object. In microscopical investigation every object should be scrutinized from all sides and under all conditions in which it is likely to occur in nature and in microscopical investigation. It is best also to begin with objects of considerable size whose character is well known, to look at them carefully with the unaided eye so as to see them as wholes and in their natural setting; then a low power is used, and so on, step by step until the highest power available has been employed. One will in this way see less and less of the object as a whole, but every increase in magnification will give increased prominence to detail, detail which might be meaningless when taken alone and independent of the object as a whole. The pertinence of this advice will be appreciated when the student undertakes to solve the problems of histology; for even after all the years of incessant labor spent in trying to make out the structure of man

and the lower animals, many details are still in doubt, the same visual appearances being quite differently interpreted by eminent observers.

Appearances which seem perfectly unmistakable with a low power may be found erroneous or very inadequate, for details of structure that were undistinguishable with the low power may become perfectly evident with a higher power or a more perfect objective. Indeed the problems of microscopic structure appear to become ever more complex, for difficulties overcome by improvements in the microscope simply give place to new difficulties, which in some cases render the subject more obscure than it appeared to be with the less perfect appliances.

The need of the most careful observation and constant watchfulness lest the appearances may be deceptive are thus admirably stated by Dallinger (see Carpenter-Dallinger, p. 427): "The correctness of the conclusions which the microscopist will draw regarding the nature of any object from the visual appearances which it presents to him when examined in the various modes now specified will necessarily depend in a great degree upon his previous experience in microscopic observation and upon his knowledge of the class of bodies to which the particular specimen may belong. Not only are observations of *any* kind liable to certain fallacies arising out of the previous notions which the observer may entertain in regard to the constitution of the objects or the nature of the actions to which his attention is directed, but even the most practiced observer is apt to take no note of such phenomena as his mind is not prepared to appreciate. Errors and imperfections of this kind can only be corrected, it is obvious, by general advance in scientific knowledge; but the history of them affords a useful warning against hasty conclusions drawn from a too cursory examination. If the history of almost any scientific investigation were fully made known it would generally appear that the stability and completeness of the conclusions finally arrived at had been only attained after many modifications, or even entire alterations, of doctrine. And it is therefore of such great importance as to be almost essential to the correctness of our conclusions that they should not be finally formed and announced until they have been tested in every conceivable mode. It is due to science that it should be burdened with as few false facts [artifacts] and false doctrines as possible. It is due to other truth-seekers

that they should not be misled, to the great waste of their time and pains, by our errors. And it is due to ourselves that we should not commit our reputation to the chance of impairment by the premature formation and publication of conclusions which may be at once reversed by other observers better informed than ourselves, or may be proved fallacious at some future time, perhaps even by our own more extended and careful researches. *The suspension of the judgment whenever there seems room for doubt* is a lesson inculcated by all those philosophers who have gained the highest repute for practical wisdom; and it is one which the microscopist cannot too soon learn or too constantly practice.''

For these experiments no condenser is to be used except where specifically indicated.

§ 143. **Dust or Cloudiness on the Ocular.**—Employ the 16 mm. ($\frac{2}{3}$ in.) objective, low ocular, and fly's wing as object.

Unscrew the field-lens and put some particles of lint from dark cloth on its upper surface. Replace the field-lens and put the ocular in position (§ 55). Light the field well and focus sharply. The image will be clear, but part of the field will be obscured by the irregular outline of the particles of lint. Move the object to make sure this appearance is not due to it.

Grasp the ocular by the milled ring, just above the tube of the microscope, and rotate it. The irregular objects will rotate with the ocular. Cloudiness or particles of dust on any part of the ocular may be detected in this way.

§ 144. **Dust or Cloudiness on the Objective.**—Employ the same ocular and objective as before and the fly's wing as object. Focus and light well, and observe carefully the appearance. Rub glycerin on one side of a slide near the end. Hold the clean side of this end close against the objective. The image will be obscured, and cannot be made clear by focusing. Then use a clean slide and the image may be made clear by elevating the tube slightly. The obscurity produced in this way is like that caused by clouding the front-lens of the objective. Dust would make a dark patch on the image that would remain stationary while the object or ocular is moved.

If a small diaphragm is employed and it is close to the object, only the central part of the field will be illuminated, and around the

small light circle will be seen a dark ring (Fig. 49). If the diaphragm is lowered or a sufficiently large one employed the entire field will be lighted.

§ 145. **Relative Position of Objects or parts of the same object.** The general rule is that objects highest up come into focus *last* in focusing up, *first* in focusing down.

§ 146. **Objects having Plane or Irregular Outlines.**—As object use three printed letters in stairs mounted in Canada balsam (Fig. 96). The first letter is placed directly upon the slide, and covered with a small piece of glass about as thick as a slide. The second letter is placed upon this and covered in like manner. The third letter is placed upon the second thick cover and covered with an ordinary cover-glass. The letters should be as near together as possible, but not over-lapping. Employ the same ocular and objective as above (§ 143).



FIG. 96. *Letters mounted in stairs to show the order of coming into focus.*

a, b, c, d. The various letters indicated by the oblique row of black

marks in sectional view. Slide. The glass slide on which the letters are mounted.

Lower the tube till the objective almost touches the top letter, then look into the microscope, and slowly focus up. The lowest letter will first appear and then, as it disappears, the middle one will appear, and so on. Focus down, and the top letter will first appear, then the middle one, etc. The relative position of objects is determined exactly in this way in practical work.

For example, if one has a micrometer ruled on a cover-glass 15–25 hundredths mm. thick, it is not easy to determine with the naked eye which is the ruled surface. But if one puts the micrometer under a microscope and uses a 3 mm. ($\frac{1}{8}$ in.) objective, it is easily determined. The cover should be laid on a slide and focused till the lines are sharp. Now, without changing the focus in the least turn the cover over. If it is necessary to focus up to get the lines of the micrometer sharp, the lines are on the upper side. If one must focus down, the lines are on the under surface. With a thin cover and delicate lines this method of determining the position of the rulings is of considerable practical importance.

§ 147. **Determination of the Form of Objects.**—The procedure is exactly as for the determination of the form of large objects. That is, one must examine the various aspects. For example, if one were placed in front of a wall of some kind he could not tell whether it was a simple wall or whether it was one side of a building unless in some way he could see more than the face of the wall. In other words, in order to get a correct notion of any body, one must examine more than one dimension,—two for plane surfaces, three for solids. So for microscopic objects, one must in some way examine more than one face. To do this with small bodies in a liquid the bodies may be made to roll over by pressing on one edge of the cover-glass. And in rolling over the various aspects are presented to the observer. With solid bodies, like the various organs, correct notions of the form of the elements can be determined by studying sections cut at right angles to each other. The methods of getting the elements to roll over, and of sectioning in different planes are in constant use in Histology, and the microscopist who neglects to see all sides of the tissue elements has a very inadequate and often a very erroneous conception of their true form.

§ 148. **Transparent Objects having Curved Outlines.**—The success of these experiments will depend entirely upon the care and skill used in preparing the objects, in lighting, and in focusing.

Employ a 3 mm. ($\frac{1}{8}$ in.) or higher objective and a high ocular for all the experiments. It may be necessary to shade the object (§ 120) to get satisfactory results. When a diaphragm is used the opening should be small and it should be close to the object.

§ 149. **Air Bubbles.**—Prepare these by placing a drop of thin mucilage on the center of a slide and beating it with a scalpel blade until the mucilage looks milky from the inclusion of air bubbles. Put on a cover-glass but do not press it down.

FIG. 97. *Diagram showing how to place a cover-glass upon an object with the forceps.*

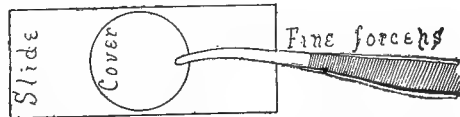

§ 150. **Air Bubbles with Central Illumination.**—Shade the object; and with the plane mirror, light the field with central light (Fig. 28).

Search the preparation until an air bubble is found appearing about 1 mm. in diameter, get it into the center of the field, and if the light is central the air bubble will appear with a wide, dark, circular margin and a small bright center. If the bright spot is not in the center, adjust the mirror until it is.

This is one of the simplest and surest methods of telling when the light is central or axial when no condenser is used (§ 74).

Focus both up and down, noting that, in focusing up, the central spot becomes very clear and the black ring very sharp. On elevating the tube of the microscope still more the center becomes dim, and the whole bubble loses its sharpness of outline.

§ 151. **Air Bubbles with Oblique Illumination.**—Remove the sub-stage of the microscope and all the diaphragms. Swing the mirror so that the rays may be sent very obliquely upon the object (Fig. 28, C). The bright spot will appear no longer in the center but on the side *away from* the mirror (Fig. 98, A).

§ 152. **Oil Globules.**—Prepare these by beating a small drop of clove oil with mucilage on a slide and covering as directed for air bubbles (§ 150), or use a drop of milk.

§ 153. **Oil Globules with Central Illumination.**—Use the same diaphragm and light as above (§ 150). Find an oil globule appearing about 1 mm. in diameter. If the light is central a bright spot will appear in the center as with air. Focus up and down as with air, and note that the bright center of the oil globules is clear-est *last* in focusing up.

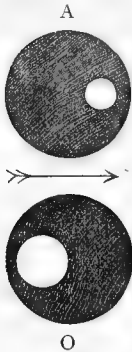

FIG. 98. *Very small Globules of Oil (O) and an Air Bubbles (A) seen by Oblique Light. Surface view. The arrow indicates the direction of the light rays.*

§ 154. **Oil Globules with Oblique Illumination.**—Remove the sub-stage, etc., as above, and swing the mirror to one side and

light with oblique light. The bright spot will be eccentric, and will appear to be on the *same* side as the mirror (Fig. 98,O).

§ 155. **Oil and Air Together.**—Make a preparation exactly as described for air bubbles (§ 149), and add at one edge a little of the mixture of oil and mucilage (§ 152); cover and examine.

The sub-stage need not be used in this experiment. Search the preparation until an air bubble and an oil globule, each appearing about 1 mm. in diameter, are found in the same field of view. Light first with central light, and note that, in focusing up, the air bubble comes into focus first and that the central spot is smaller than that of the oil globule. Then, of course, the black ring will be wider in the air bubble than in the oil globule. Make the light oblique. The bright spot in the air bubble will move *away from* the mirror while that in the oil globule will move *toward it*. See Fig. 91.*

§ 156. **Air and Oil by Reflected Light.**—Cover the diaphragm or mirror so that no transmitted light (§ 73) can reach the preparation, using the same preparation as in § 155. The oil and air will appear like globules of silver on a dark ground. The part that was darkest in each with transmitted light will be lighted, and the bright central spot will be somewhat dark.†

§ 157. **Distinctness of Outline.**—In refraction images this depends on the difference between the refractive power of a body and that of the medium which surrounds it. The oil and air were very distinct in outline as both differ greatly in refractive power from the medium which surrounds them, the oil being more refractive than the mucilage and the air less. (Figs. 61-63.)

Place a fragment of a cover-glass on a clean slide, and cover it

* It should be remembered that the image in the compound microscope is inverted (Fig. 26), hence the bright spot really moves toward the mirror for air, and away from it for oil.

† It is possible to distinguish oil and air optically, as described above, only when quite high powers are used and very small bubbles are selected for observation. If a 16 mm. ($\frac{2}{3}$ in.) is used instead of a 3 mm. ($\frac{1}{8}$ in.) objective, the appearances will vary considerably from that given above for the higher power. It is well to use a low as well as a high power. Marked differences will also be seen in the appearances with objectives of small and of large aperture.

(see under mounting). The outline will be distinct with the unaided eye. Use it as object and employ the 16 mm. ($\frac{2}{3}$ in.) objective and high ocular. Light with central light. The fragment will be outlined by a dark band. Put a drop of water at the edge of the cover-glass. It will run in and immerse the fragment. The outline will remain distinct, but the dark band will be somewhat narrower. Remove the cover-glass, wipe it dry, and wipe the fragment and slide dry also. Put a drop of 50% glycerin on the middle of the slide and mount the fragment of cover-glass in that. The dark contour will be much narrower than before.

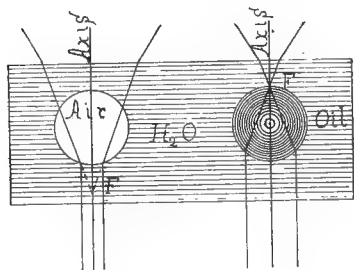

is virtual and below for the air bubble; real and above for the oil globule. H_2O . Water or a mixture of water and gum arabic serving as a mounting medium (§ 149).

FIG. 99. Section of an air bubble and an oil globule in water (H_2O). The air bubble although spherical in form gives only a virtual focus, indicated by the dotted lines below the bubble. As it is surrounded by a denser medium it acts like a concave lens in air (Fig. 10). The focus of the oil globule is real as it is denser than the surrounding medium. Axis,—the principal axis. F, principal focus. It

Draw a solid glass rod out to a fine thread. Mount one piece in air, and the other in 50% glycerin. Put a cover-glass on each. Employ the same optical arrangement as before. Examine the one in air first. There will be seen a narrow, bright band, with a wide, dark band on each side (Fig. 100, a).



a. Mounted in air. b. Mounted in 50 per cent glycerin.

FIG. 100. Solid glass rod showing the appearance when viewed with transmitted, central light, and with an objective of medium aperture.

The one in glycerin will show a much wider bright central band, with the dark borders correspondingly narrow (Fig. 100, b). The dark contour depends also on the numerical aperture of the objective—being wider with low apertures. This can be readily understood when it is remembered that the greater the aperture the more oblique the rays of light that can be received, and the dark

band simply represents an area in which the rays are so greatly bent or refracted (Figs. 61-63) that they cannot enter the objective and contribute to the formation of the image; the edges are dark simply because no light from them reaches the observer.

If the glass rod or any other object were mounted in a medium of the same color and refractive power, it could not be distinguished from the medium. *

A very striking and satisfactory demonstration may be made by painting a zone or band of eosin or other transparent color on a solid glass rod, and immersing the rod in a test tube or vial of cedar oil, clove oil or turpentine. Above the liquid the glass rod is very evident, as it is also at the colored zone, but at other levels it can hardly be seen in the liquid.

§ 158. **Highly Refractive.**—This expression is often used in describing microscopic objects, (medullated nerve fibers, for example), and means that object will appear to be bordered by a wide, dark margin when it is viewed by transmitted light. And from the above (§ 157), it would be known that the refractive power of the object, and the medium in which it was mounted must differ considerably.

FIG. 101. *Solid glass rod coated with collodion to show a double contour. Toward one end the collodion had gathered in a fusiform drop.*

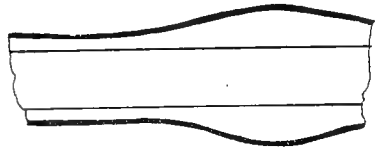

§ 159. **Doubly Contoured.**—This means that the object is bounded by two, usually parallel dark lines with a lighter band between them. In other words, the object is bordered by (1) a dark line, (2) a light band, and (3) a second dark line (Fig. 101).

This may be demonstrated by coating a fine glass rod (§ 157) with one or more coats of collodion or celloidin and allowing it to dry, and then mounting in 50% glycerin as above. Employ a 3 mm. ($\frac{1}{8}$ in.) or higher objective, light with transmitted light, and it will be seen that where the glycerin touches the collodion coating

* Some of the rods have air bubbles in them, and then there results a capillary tube when they are drawn out. It is well to draw out a glass tube into a fine thread and examine it as described. The central cavity makes the experiment much more complex.

there is a dark line—next this is a light band, and finally there is a second dark line where the collodion is in contact with the glass rod.* (Fig. 101).

§ 160. **Optional Section.**—This is the appearance obtained in examining transparent or nearly transparent objects with a microscope when some plane below the upper surface of the object is in focus. The upper part of the object which is out of focus obscures the image but slightly. By changing the position of the objective or object, a different plane will be in focus and a different optical section obtained. The most satisfactory optical sections are obtained with high objectives having large aperture.

Nearly all the transparent objects studied may be viewed in optical section. A striking example will be found in studying mammalian red blood-corpuscles on edge. The experiments with the solid glass rods (Fig. 100) furnish excellent and striking examples of optical sections.

§ 161. **Currents in Liquids.**—Employ the 16 mm. ($\frac{3}{8}$ in.) objective, and as object put a few particles of carmine on the middle of a slide, and add a drop of water. Grind the carmine well with a scalpel blade, and then cover it. If the microscope is inclined, a current will be produced in the water, and the particles of carmine will be carried along by it. Note that the particles seem to flow up instead of down—why is this?

Lamp-black rubbed in water containing a little mucilage answers well for this experiment.

§ 162. **Velocity Under the Microscope.**—In studying currents or the movement of living things under the microscope, one should not forget that the apparent velocity is as unlike the real velocity as the apparent size is unlike the real size. If one consults Fig. 42 it will be seen that the actual size of the field of the microscope with the different objectives and oculars is inversely as the magnification. That is, with great magnification only a small area can be seen. The field appears to be large, however, and if any

* The collodion used is a 6% solution of gun cotton in equal parts of sulphuric ether and 95% alcohol. It is well to dip the rod two or three times in the collodion and to hold it vertically while drying. The collodion will gather in drops, and one will see the difference between a thick and a thin membranous covering (Fig. 101).

object moves across the field it may appear to move with great rapidity, whereas if one measures the actual distance passed and notes the time, it will be seen that the actual motion is quite slow. One should keep this in mind in studying the circulation of the blood. The truth of what has just been said can be easily demonstrated in studying the circulation in the gills of *Necturus*, or in the frog's foot, by using first a low power in which the field is actually of considerable diameter (Fig. 42, Table, § 58) and then using a high power. With the high power the apparent motion will appear much more rapid. For spiral, serpentine and other forms of motion, see Carpenter-Dallinger, p. 433.

§ 163. **Pedesis or Brownian Movement.**—Employ the same object as above, but a 3 mm. ($\frac{1}{8}$ in.) or higher objective in place of the 16 mm. Make the body of the microscope vertical, so that there may be no currents produced. Use a small diaphragm and light the field well. Focus and there will be seen in the field large motionless masses, and between them small masses in constant motion. This is an indefinite, dancing or oscillating motion.

This indefinite but continuous motion of small particles in a liquid is called *Pē-dē'sis* or *Brownian movement*. Also, but improperly, molecular movement, from the smallness of the particles.

The motion is increased by adding a little gum arabic solution or a slight amount of silicate of soda or soap; sulphuric acid and various saline compounds retard or check the motion. One of the best objects is lamp-black ground up with a little gum arabic. Carmine prepared in the same way, or simply in water, is excellent; and very finely powdered pumice-stone in water has for many years been a favorite object.

Pedesis is exhibited by all solid matter if it is finely enough divided and in a suitable liquid. In the minds of most, no adequate explanation has yet been offered.

Compare the pedetic motion with that of a current by slightly inclining the tube of the microscope. The small particles will continue their independent leaping movements while they are carried along by the current. The pedetic motion makes it difficult to obtain good photographs of milk globules and other small particles. The difficulty may be overcome by mixing the milk with a very weak solution of gelatin and allowing it to cool (see Ch. IX).

§ 164. **Demonstration of Pedesis with the Polarizing Microscope.**—(Ch. VI.) The following demonstration shows conclusively that the pedetic motion is real and not illusive. (Ranvier, p. 173.)

Open the abdomen of a dead frog (an alcoholic or formalin specimen is satisfactory). Turn the viscera to one side and observe the small, whitish masses at the emergence of the spinal nerves. With fine forceps remove one of these and place it on the middle of a clean slide. Add a drop of water, or of water containing a little gum arabic. Rub the white mass around in the drop of liquid and soon the liquid will have a milky appearance. Remove the white mass, place a cover-glass on the milky liquid and seal the cover by painting a ring of castor oil all around it, half the ring being on the slide and half on the cover-glass. This is to avoid the production of currents by evaporation.

Put the preparation under the microscope and examine with, first a low power then a high power (3 mm. or $\frac{1}{8}$ in.). In the field will be seen multitudes of crystals of carbonate of lime; the larger crystals are motionless but the smallest ones exhibit marked pedetic movement.

Use the micro-polariscope, light with great care and exclude all adventitious light from the microscope by shading the object (§ 120) and also by shading the eye. Focus sharply and observe the pedetic motion of the small particles, then cross the polarizer and analyzer, that is, turn one or the other until the field is dark. Part of the large motionless crystals will shine continuously and a part will remain dark, but small crystals between the large ones will shine for an instant, then disappear, only to appear again the next instant. This demonstration is believed to furnish absolute proof that the pedetic movement is real and not illusory.

§ 165. **Muscae Volitantes.**—These specks or filaments in the eyes due to minute shreds or opacities of the vitreous sometimes appear as part of the object as they are projected into the field of vision. They may be seen by looking into the well lighted microscope when there is no object under the microscope. They may also be seen by looking at brightly illuminated snow or other white surface. By studying them carefully it will be seen that they are somewhat movable and float across the field of vision, and thus do not remain in one position as do the objects under observation. Further-

more, one may, by taking a little pains, familiarize himself with the special forms in his own eyes so that the more conspicuous at least may be instantly recognized.

§ 166. **Miscellaneous Observations.**—In addition to the above experiments it is very strongly recommended that the student follow the advice of Beale, p. 248, and examine first with a low then with a higher power, mounted dry, then in water, lighted with reflected light, then with transmitted light, the following: Potato, wheat, rice and corn starch, easily obtained by scraping the potato and the grains mentioned; bread crumbs; portions of feather. Portions of feather accidentally present in histological preparations have been mistaken for lymphatic vessels (Beale, 288). Fibers of cotton, linen and silk. Textile fibers accidentally present have been considered nerve fibers, etc. Human and animal hairs. Study with especial care hairs from various parts of the body of the animals used for dissection in the laboratory where you work. These are liable to be present in histological preparations, and unless their character is understood there is chance for much confusion and erroneous interpretation. The scales of butterflies and moths, especially the common clothes moths. The dust swept from carpeted and wood floors. Tea leaves and coffee grounds. Dust found in living rooms and places not frequently dusted. In the last will be found a regular museum of objects.

If it is necessary to see all sides of an ordinary gross object, and to observe it with varying illumination and under various conditions of temperature, moisture, etc., in order to obtain a fairly accurate and satisfactory knowledge of it, so much the more is it necessary not to be satisfied it microscopical observation until every means of investigation and verification has been called into service, and then of the image that falls upon the retina, only such details will be noted as the brain behind the eye is ready to appreciate.

§ 167. **Summary for Proper Interpretation.**—To summarize this chapter and leave with the beginning student the result of the experience of many eminent workers:

1. Get all the information possible with the unaided eye. See the whole object and all sides of it, so far as possible.
2. Examine the preparation with a simple microscope in the same thorough way for additional detail.

3. Use a low power of the compound microscope.
4. Use a higher power.
5. Use the highest power available and applicable. In this way one sees the object as a whole and progressively more and more details. Then as the object is viewed from two or more aspects, something like a correct notion may be gained of its form and structure.

§ 168. **Zeiss-Greenough Binocular, Erecting Microscope.**—As shown in figure 102 this consists of a microscope stage with two tubes mounted side by side and moving on the same rack and pinion. Either tube can be used without the other. The oculars are capable of greater or less separation to suit the eyes of different observers. In the large cylinder near the top is placed a Porro prism which erects the image. This microscope gives most perfect stereoscopic images and also erect ones, and therefore is especially adapted for dissection and for studying objects of considerable thickness, like injected preparations etc. It is interesting to note that the binocular microscope constructed by Cherubin D'Orleans, 1677, was composed in like manner of two microscopes side by side. It of course had no erecting prisms (For statement and figure of this early binocular, see Mayall, p. 17, 18).

§ 169. **Wenham's Binocular Microscope.**—This is illustrated in Figs. 103-104. There is but a single objective. The light from this is divided by a prism, a part of it passing to the right and a part to the left eye. That to the right eye passes directly, that to the left is twice internally reflected by the prism to give it the right inclination.

In order to get the stereoscopic effect with the binocular there must be an image in both eyes, and to ensure this the oculars must be separable so that the eye-points are the same width as the pupils of the eyes of the observer.

One can tell whether there is binocular vision in his first trials by closing first one eye and then the other. If an image is seen without moving the head whichever eye is closed then of course both eyes are seeing an image and one should get the appearance of relief characteristic of stereoscopic images. If one does not see with both eyes the eye-points are too close or too far separated for his pupils. The tubes should be separated or approximated until each

eye sees the image. After one is used to the stereoscopic appearance when seeing with both eyes he can tell instantly whether the

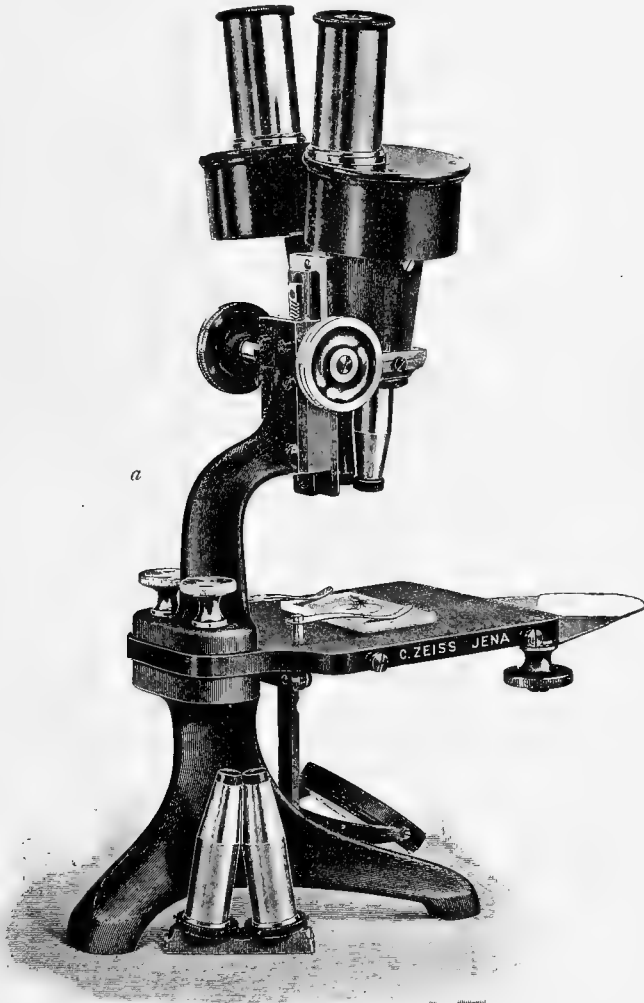
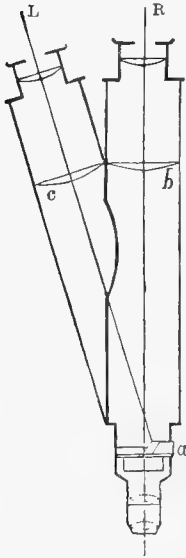
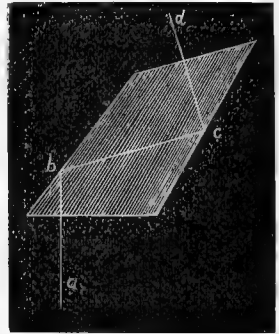

FIG. 102. *Greenough's Erecting Binocular Microscope.* This consists of two microscope tubes mounted side by side. The oculars may be approximated or separated for the eyes of different observers. The images are erected by the Porro prisms in the large rounded part of the tube. (Zeiss' Catalog.)

binocular is properly adjusted for his eyes. (See Carpenter-Dallinger for fuller discussion of Binoculars.)



103



104

FIG. 103. *Sectional View of Wenham's Binocular Microscope.* *a.* The prism which extends partly across the field and directs about half of the light to the left eye (L). A part of the light extends directly to the right eye (R). *c, b.* Field lenses of the right and the left oculars.

FIG. 104. *An enlargement of the Prism used in the Wenham Binocular Microscope.* *a, b, c, d* Represent the course of the ray for the left eye. It is internally reflected at the points *b, c,* and given the proper direction to enter the left eye.

REFERENCES FOR CHAPTER III.

For general discussions: Carpenter-Dallinger, A. E. Wright, Principles of Microscopy, Ch. V.; Beale; Spitta, Microscopy, Ch. xviii.; Beck's Cantor Lectures, lect. IV.

For pedesis see Carpenter-Dallinger, p. 431; Beale, p. 195; Jevons in *Quart. Jour. Science*, n. s., Vol. VIII (1878), p. 167.

For the original account of this see Robert Brown, "Botanical appendix to Captain King's voyage to Australia," Vol. II, p. 534 (1826).

See also Dr. C. Aug. Sigm. Schultze, "Mikroskopische Untersuchungen

über des Herren Robert Brown Entdeckung lebender, selbst im Feuer unzerstörbarer Theilchen in allen Körpern." From "Die Gesellschaft für Beförderung der Naturwissenschaften zu Frieberg." (1828.)

For overcoming pedesis for photography see Gage, The use of a solution of gelatin to obviate pedesis in photographing milk globules and other minute objects in water. Transactions Amer. Micr. Soc., Vol. XXIV., 1902, p. 21.

For figures (photo-micrographs, etc.) of the various forms of starch, see Bulletin No. 13 of the Chemical Division of the U. S. Department of Agriculture. For Hair and Wool, see Bulletin of the National Association of Wool Growers, 1875, p. 470, Proc. Amer. Micr. Soc., 1884, pp. 65-68. Herzfeld, translated by Salter.—The technical testing of yarns and textile fabrics, London, 1898. See also the Bibliography at the end for works relating to adulteration of foods, etc., for further discussions of the elements used in foods and drugs.

For different appearances due to the illuminator, see Nelson, in Jour. Roy. Micr. Soc., 1891, pp. 90-105; and for the illusory appearances due to diffraction phenomena, see Carpenter-Dallinger, p. 434. Mercer. Trans. Amer. Micr. Soc., pp. 321-396. Also, A. E. Wright's Principles of Microscopy; Conrad Beck.

For the Binocular see Carpenter-Dallinger; Mayall; Spitta.

1. Positive ocular.
2. Draw-tube.
3. Main tube or body.
- 4-5. Society screws in the draw-tube and body.
6. Objective in position.
7. Stage.
8. Spring for holding slides.
9. Sub-stage condenser.
10. Iris diaphragm.
11. Plane and concave mirror.
12. Horse-shoe base.
13. Rack and pinion for condenser.
14. Flexible pilar.
15. Spiral spring of fine adjustment.
16. Fine adjustment.
17. Coarse adjustment.

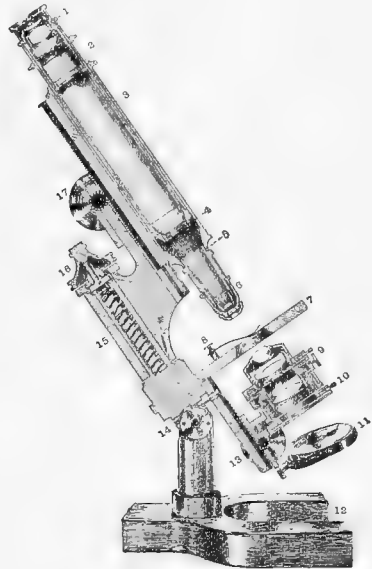

THE MICROSCOPE IN SECTION

CHAPTER IV

MAGNIFICATION AND MICROMETRY

APPARATUS AND MATERIAL FOR THIS CHAPTER

Simple and compound microscope (§ 172, 174); Steel scale or rule divided to millimeters and $\frac{1}{2}$; Block for magnifier and compound microscope (§ 172, 176); Dividers (§ 172, 176); Stage micrometer (§ 175); Wollaston camera lucida (§ 176); Ocular screw-micrometers (Figs. 118-120); Abbe camera lucida (Fig. 114). Necturus red blood corpuscles (§ 184). Eikonometer (§ 195).

§ 170. **The Magnification, Amplification or Magnifying Power** of a simple or compound microscope is the ratio between the real and the apparent size of the object examined. The apparent size is obtained by measuring the virtual image (Figs. 26, 43). For determining magnification the object must be of known length and is designated a *micrometer* (§ 175). In practice a virtual image is measured by the aid of some form of camera lucida (Figs. 108, 114), or by double vision (§ 172). As the length of the object is known, the magnification is easily determined by dividing the apparent size of the image by the actual size of the object. For example, if the virtual image measures 40 mm. and the object magnified, 2 mm., the amplification is $40 \div 2 = 20$, that is, the apparent size is 20 fold greater than the real size.

Magnification is expressed in diameters or times linear, that is but one dimension is considered. In giving a scale at which a microscopical or histological drawing is made, the word magnification is frequently indicated by the sign of multiplication thus : $\times 450$, upon a drawing means that the figure or drawing is 450 times as large as the object.

§ 171. **Magnification of Real Images.**—In this case the magnification is the ratio between the size of the real image and the size of the object, and the size of the real image can be measured directly. By recalling the work on the function of an objective

(§ 60), it will be remembered that it forms a real image on the ground glass placed on the top of the tube, and that this real image could be looked at with the eye or measured as if it were an actual object. For example, suppose the object were three millimeters long and its image on the ground glass measured 15 mm., then the magnification is $15 \div 3 = 5$, that is, the real image is 5 times as long as the object. The real images seen in photography are mostly smaller than the objects, but the magnification is designated in the same way by dividing the size of the real image measured on the ground glass by the size of the object. For example, if the object is 400 millimeters long and its image on the ground glass is 25 mm. long the ratio is $25 \div 400 = \frac{1}{16}$. That is, the image is $\frac{1}{16}$ as long as the object and is not magnified but reduced. In marking negatives, as with drawings, the sign of multiplication is put before the ratio, and in the example the designation is $\times \frac{1}{16}$. In photography (Ch. VIII) and when using the magic lantern and the projection microscope the images are real, and may be measured on the screen as if real pictures.

MAGNIFICATION OF A SIMPLE MICROSCOPE

§ 172. **The Magnification of a Simple Microscope** is the ratio between the object magnified (Fig. 16, A^1B^1), and the virtual



FIG. 105. *Tripod Magnifier*

image (A^3B^3). To obtain the size of this virtual image place the tripod magnifier near the edge of a support of such a height that the distance from the upper surface of the magnifier to the table is 250 millimeters.

As object, place a scale of some kind ruled in millimeters on the support under the magnifier. Put some white paper on the table at the base of the support and on the side facing the light.

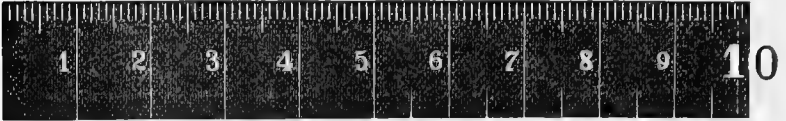

FIG. 106. *Ten Centimeter Rule. The upper edge is divided into millimeters, the lower into centimeters at the left and half centimeters at the right.*

Close one eye, and hold the head so that the other will be near the upper surface of the lens. Focus if necessary to make the image clear (§ 12). Open the closed eye and the image of the rule will appear as if on the paper at the base of the support. Hold the head very still, and with dividers get the distance between any two lines of the image. This is the so-called method of double vision in which the microscope image is seen with one eye and the dividers with the others, the two images appearing to be fused in a single visual field.

§ 173. **Measuring the Spread of Dividers.**—This should be done on a steel scale divided to millimeters and $\frac{1}{5}$.

As $\frac{1}{5}$ mm. cannot be seen plainly by the unaided eye, place one arm of the dividers at a centimeter line, and with the tripod magnifier count the number of spaces on the rule included between the points of the dividers. The magnifier simply makes it easy to count the spaces on the rule included between the points of the dividers—it does not, of course, increase the number of spaces or change their value.

As the distance between any two lines of the image of the scale gives the size of the virtual image (Fig. 16, $A^3 B^3$), and as the size of the object is known, the magnification is determined by dividing the size of the image by the size of the object. Thus, suppose the distance between the two lines of the image is measured by the dividers and found on the steel scale to be 15 millimeters, and the actual size of the space between the two lines of the object is 2 millimeters, then the magnification is $15 \div 2 = 7\frac{1}{2}$, that is the image is $7\frac{1}{2}$ times as long or wide as the object. In this case the image is said to be magnified $7\frac{1}{2}$ diameters, or $7\frac{1}{2}$ times linear.

The magnification of any simple magnifier may be determined experimentally in the way described for the tripod; but this method is of course only possible when the observer has two good eyes. If he has but one eye then the magnification may be determined by the aid of a camera lucida (§ 176) or the eikonometer (§ 196).

MAGNIFICATION OF A COMPOUND MICROSCOPE

§ 174. **The Magnification of a Compound Microscope** is the ratio between the final or virtual image (Fig. 26, B^3A^3), and the object magnified ($A B$).

The determination of the magnification of a compound microscope may be made as with a simple microscope (§ 172), but this is fatiguing and unsatisfactory.

§ 175. **Stage, Object or Objective Micrometer.**—For determining the magnification of a compound microscope and for the purpose of micrometry, it is necessary to have a finely divided scale or rule on glass or on metal. Such a finely divided scale is called a micrometer, and for ordinary work one mounted on a glass slide (1×3 in., 25×76 mm.) is most convenient.

The spaces between the lines should be $\frac{1}{10}$ and $\frac{1}{100}$ mm. (or if in inches, $\frac{1}{100}$ and $\frac{1}{1000}$ in.). Micrometers are sometimes ruled on the slide, but more satisfactorily on a cover-glass of known thickness, preferably 0.15—0.18 mm. The covers should be perfectly clean before the ruling, and afterwards simply dusted off with a camel's hair duster, and then mounted, lines downward over a shellac or other good cell. (See Ch. VII.) If one rubs the lines the edges of the furrow made by the diamond are liable to be rounded and the sharpness of the micrometer is lost. If the lines are on the slide and uncovered one cannot use the micrometer with an oil immersion, as the oil obliterates the lines. Cleaning the slide makes the lines less sharp as stated. If the lines are coarse, it is an advantage to fill them with plumbago. This may be done with some very fine plumbago on the end of a soft cork, or by using a soft lead pencil. Lines properly filled may be covered with balsam and a cover-glass as in ordinary balsam mounting (Ch. VII).

§ 176. **Determination of Magnification.**—This is most readily accomplished by the use of some form of camera lucida (Ch. V), that of Wollaston being most convenient as it may be

used for all powers, and the determination of the *standard distance of 250 millimeters* at which to measure the images is readily determined (Fig. 108, § 178).

Employ the 16 mm. ($\frac{2}{3}$ in.) objective and a 37 mm. ($\times 8$) ocular with a stage micrometer as object. For this power the $\frac{1}{10}$ mm. spaces of the micrometer should be used as object. Focus sharply.

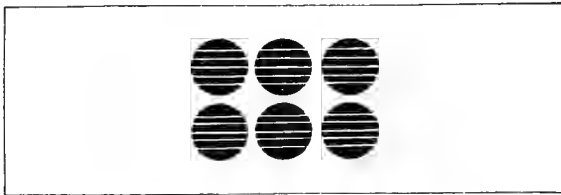

FIG. 107. *Abbe's Test Plate to show the enclosure of the micrometer lines by small rings. See also Fig. 75.*

It is somewhat difficult to find the micrometer lines. To avoid this it is well to have a small ring enclosing some of the micrometer lines (Fig. 107). The light must also be carefully regulated. If too much light is used, *i. e.*, too large an aperture, the lines will be drowned in the light. In focusing with the high powers be very careful. Remember the micrometers are expensive, and one cannot afford to break them. As suggested in § 83, focus on the edge of the cement ring enclosing the lines, then in focusing down to find the lines, move the preparation very slightly, back and forth.

After the lines are sharply focused, and the slide clamped in position make the tube of the microscope horizontal, by bending the flexible pillar, being careful not to bring any strain upon the fine adjustment (frontispiece).

Put a Wollaston camera lucida (Fig. 108 and Ch. V) in position, and turn the ocular around if necessary so that the broad flat surface may face directly upward, as shown in the figure. Elevate the microscope by putting a block under the base, so that the perpendicular distance from the upper surface of the camera lucida to the table is 250 mm. (§ 178). Place some white paper on the work-table beneath the camera lucida.

Close one eye, and hold the head so that the other may be very close to the camera lucida. Look directly down. The image will

appear to be on the table. It may be necessary to readjust the focus after the camera lucida is in position. If there is difficulty in seeing dividers and image consult Ch. V. Measure the image with dividers and obtain the power exactly as above (§ 172-173).

FIG. 108. *Wollaston's Camera Lucida, showing the rays from the microscope and from the drawing surface, also the position of the pupil of the eye.*

Axis, Axis. Axial rays from the microscope and from the drawing surface (Ch. V).

Camera Lucida. A section of the quadrangular prism showing the course of the rays in the prism from the microscope to the eye. As the rays are twice reflected, they have the same relation on entering the eye that they would have by looking directly into the ocular.

A. B. The lateral rays from the microscope and their projection upon the drawing surface.

C. D. Rays from the drawing surface to the eye.

A. D. A' D'. Overlapping portions of the two fields, where both the microscopic image and the drawing surface, pencil, etc., can be seen. It is represented by the shaded part of the overlapping circles at the right.

Ocular. The ocular of the microscope.

P. The drawing pencil. Its point is shown in the overlapping fields.

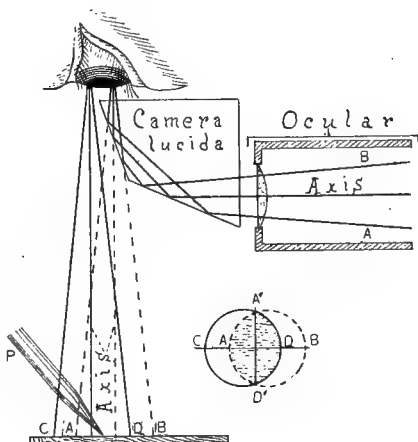

108

Thus: Suppose two of the $\frac{1}{10}$ mm., spaces were taken as object, and the image is measured by the dividers, and the spread of the dividers is found on the steel rule to be $9\frac{2}{5}$ millimeters. If the object is $\frac{2}{10}$ of a millimeter and the magnified image is $9\frac{2}{5}$ millimeters, the magnification (which is the ratio between size of object and image) is $9\frac{2}{5} \div \frac{2}{10} = 47$. That is, the magnification is 47 diameters, or 47 times linear. If the fractional numbers in the above example trouble the student, both may be reduced to the same denomination, thus: If the size of the image is found to be $9\frac{2}{5}$ mm. this number may be reduced to tenths mm., so it will be of the same denomination as the object. In 9 mm. there are 90 tenths, and in $\frac{2}{5}$ there are 4 tenths, then the whole length of the image is $90 \div 4 = 22\frac{1}{2}$ tenths

of a millimeter. The object is 2 tenths of a millimeter, then there must have been a magnification of $94 \div 2 = 47$ diameters in order to produce an image 94 tenths of a millimeter long.

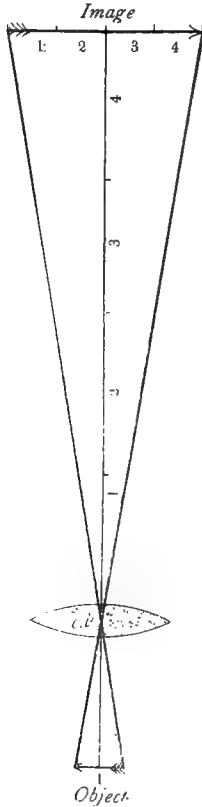

FIG. 109

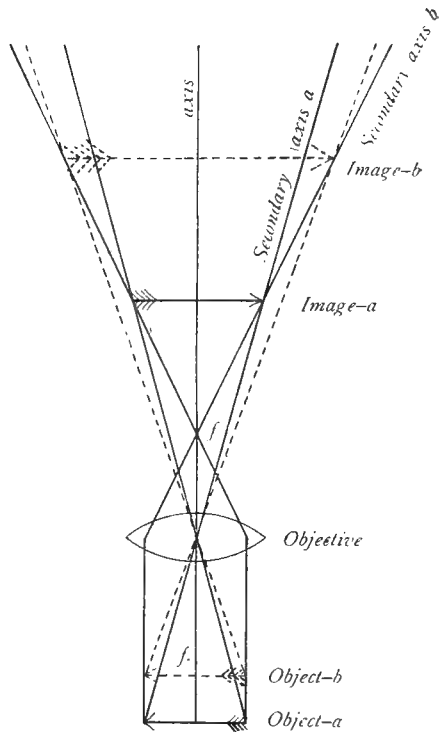

FIG. 110

Fig. 109-110. Figures showing that the size of object and image vary directly as their distance from the center of the lens. In Fig. 110 one can also see why it is necessary to focus down, i. e. bring the object and objectives nearer together when the tube is lengthened. See also Fig. 66.

Put the 25 mm. (1 in., C, or $\times 12$) ocular in place of one of 37 mm. focus, and then put the camera lucida in position. Measure the size of the image with dividers and a rule as before. The power will be considerably greater than when the low ocular was used. This is because the virtual image (Fig. 26, B³ A³) seen with the

high ocular is larger than the one seen with the low one. The real image (Fig. 26 A¹ B¹) remains nearly the same, and would be just the same if positive, par-focal oculars (§ 43, 82, note) were used.

Lengthen the tube of the microscope 50–60 mm. by pulling out the draw-tube. Remove the camera lucida, and focus, then replace the camera and obtain the magnification. It is greater than with the shorter tube. This is because the real image (Fig. 110) is formed farther from the objective when the tube is lengthened, and the objective must be brought nearer the object. The law is: *The size of object and image varies directly as their distance from the center of the lens.* The truth of this statement is illustrated by Figs. 109 and 110.

§ 177. **Varying the Magnification of a Compound Microscope.**—It is seen from the above experiments (§ 176) that independently of the distance at which the microscopic image is measured (§ 178), there are three ways of varying the power of a compound microscope. These are named below in the order of desirability.

- (1) *By using a higher or lower objective.*
- (2) *By using a higher or lower ocular.*
- (3) *By lengthening or shortening the tube of the microscope* (Fig. 110).*

§ 178. **Standard Distance of 250 Millimeters at which the Virtual Image is Measured.**—For obtaining the magnification of both the simple and the compound microscope the directions were to measure the virtual image at a distance of 250 millimeters. This is not that the image could not be seen and measured at any other distance, but because some standard must be selected, and this is the most common one. The necessity for the adoption of some common standard will be seen at a glance in Fig. 111, where is repre-

***Amplifier.**—In addition to the methods of varying the magnification given in § 177, the magnification is sometimes increased by the use of an amplifier, that is a diverging lens or combination placed between the objective and ocular and serving to give the image-forming rays from the objective an increased divergence. An effective form of this accessory was made by Tolles, who made it as a small achromatic concavo-convex lens to be screwed into the lower end of the draw-tube (frontispiece) and thus but a short distance above the objective. The divergence given to the rays increases the size of the real image about two-fold.

sented graphically the fact that the size of the virtual image depends directly on the distance at which it is projected, and this size is directly proportional to the vertical distance from the apex of the

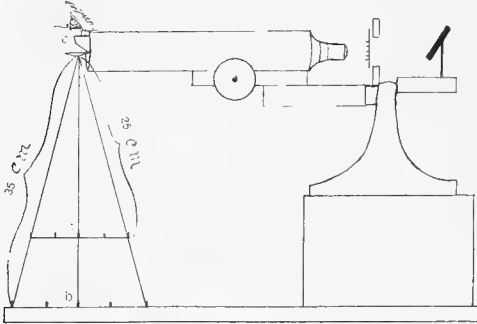

FIG. 111. Figure showing the position of the microscope, the camera lucida, the eye, and the difference in size of the image depending upon the distance at which it is projected from the eye. (a) The size at 25 cm.; (b) at 35 cm., ($\frac{7}{6}$ 178).

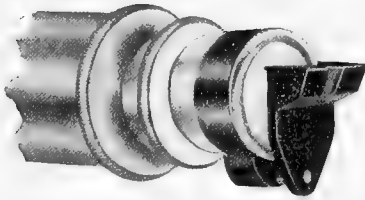

FIG. 112. Wollaston's camera lucida in position on the upper end of the tube of the microscope. (Cut loaned by the Spencer Lens Co.)



FIG. 113. Simple microscope mechanically supported by a lens holder. One may obtain the magnifying power of a simple microscope by the use of a camera lucida as with the compound microscope. (Cut loaned by the Spencer Lens Co.)

triangle, of which it forms a base. The distance of 250 millimeters has been chosen on the supposition that it is the distance of most distinct vision for the normal human eye.

Demonstrate the difference in magnification due to the distance at which the image is projected, by raising the microscope so that the distance will be 350 millimeters, then lowering to 150 millimeters.

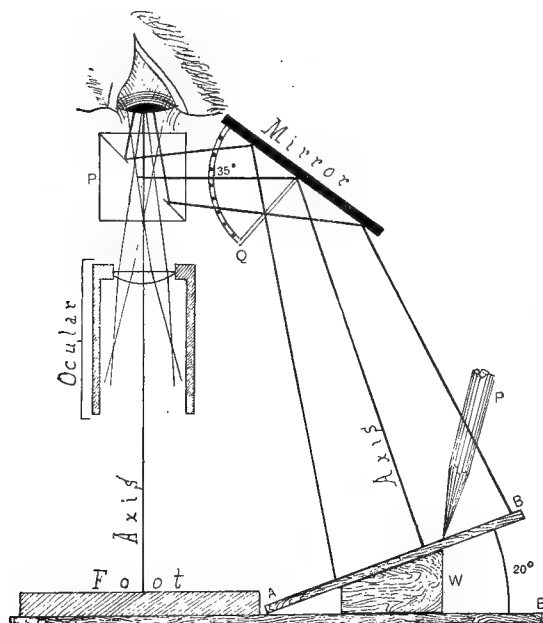

FIG. 114. Sectional view of the Abbe Camera Lucida to show that in measuring the standard distance of 250 millimeters, one must measure along the axis from the point P, at the left of the prism, to the mirror, and from the mirror to the drawing surface. For a full explanation of this camera lucida, see next chapter.

In preparing drawings it is often of great convenience to make them at a distance somewhat less or somewhat greater than the standard. In such a case the magnification must be determined for the special distance. (See the next chapter, § 207.)

For discussion of the magnification of the microscope, see: Beale, pp. 41, 355; Carpenter-Dallinger, p. 288; Nägeli and Schwendener, p. 176; Ranvier, p. 29; Robin, p. 126; Amer. Soc. Micrs., 1884, p. 183; 1889, p. 22; Amer. Jour. Arts and Sciences, 1890, p. 50; Jour. Roy. Micr. Soc., 1888, 1889; 1904, pp. 261, 279; A. E. Wright, Practical Microscopy, pp. 129, 145, 163.

§ 179. Table of Magnification and of the Valuations of

the Ocular Micrometer.—*The table should be filled out by each student. In using it for Micrometry and Drawing it is necessary to keep clearly in mind the exact conditions under which the determinations were made, and also the ways in which variations in magnification and the valuation of the ocular micrometer may be produced (§ 177, 178, 188, 195.*

OBJECTIVE.	OCULAR 37 or 50 mm.		OCULAR 25 mm.		OCULAR MICROMETER VALUATION.	
	TUBE IN	TUBE OUT —MM.	TUBE IN	TUBE OUT —MM.	TUBE IN.	OUT—MM.
	×	×	×	×		
	×	×	×	×		
	×	×	×	×		
	×	×	×	×		
	×	×	×	×		
	×	×	×	×		
SIMPLE MICROSCOPE.		×				

FIG. 115

MICROMETRY

§ 180. **Micrometry** is the determination of the size of objects by the aid of a microscope.

MICROMETRY WITH THE SIMPLE MICROSCOPE

§ 181. With a simple microscope (A), the easiest and best way is to use dividers and then with the simple microscope deter-

mine when the points of the dividers exactly include the object. The spread of the dividers is then obtained as above (§ 173). This amount will be the actual size of the object, as the microscope was only used in helping to see when the divider points exactly enclosed the object, and then for reading the divisions on the rule in getting the spread of the dividers.

(B) One may put the object under the simple microscope and then, as in determining the power (§ 172), measure the image at the standard distance. If the size of the image so measured is divided by the magnification of the simple microscope, the quotient give the actual size of the object. One might use the eikonometer also (§ 196).

Use a fly's wing or some other object of about that size, and try to determine the width in the two ways described above. If all the work is accurately done the results will agree.

MICROMETRY WITH THE COMPOUND MICROSCOPE

There are several ways of varying excellence for obtaining the size of objects with the compound microscope, the method with the ocular micrometer (§ 189-193) being most accurate.

§ 182. **Unit of Measure in Micrometry.**—As most of the objects measured with the compound microscope are smaller than any of the originally named divisions of the meter, and the common or decimal fractions necessary to express the size are liable to be unnecessarily cumbersome, *Harting*, in his work on the microscope (1859), proposed the one thousandth of a millimeter ($\frac{1}{1000}$ mm. or 0.001 mm.) or one millionth of a meter ($\frac{1}{1000000}$ or 0.000001 meter) as the unit. He named this unit micro-millimeter and designated it mmm. In 1869, *Listing* (Carl's Repetorium für Experimental-Physik, Bd, X, p. 5) favored the thousandth of a millimeter as unit and introduced the name **Mikron** or *micrum*. In English it is most often written *Micron* (plural *micra* or *microns*, pronunciation Mik'rön or Mik'rön). By universal consent the sign or abbreviation used to designate it is the Greek μ . Adopting this unit and sign, one would express five thousandths of a millimeter ($\frac{5}{1000}$ or 0.005 mm.) thus, 5μ .*

* The term micromillimeter, abbreviation mmm., is very cumbersome, and besides is entirely inappropriate since the adoption of the definite mean-

§ 183. *Micrometry by the use of a stage micrometer on which to mount the object.*—In this method the object is mounted on a micrometer and then put under the microscope, and the number of spaces covered by the object is read off directly. It is exactly like putting any large object on a rule and seeing how many spaces of the rule it covers. The defect in the method is that it is impossible to properly arrange objects on the micrometer. Unless the objects are circular in outline they are liable to be oblique in position, and in every case the end or edges of the object may be in the middle of a space instead of against one of the lines, consequently the size must be estimated or guessed at rather than really measured.

§ 184. *Micrometry by dividing the size of the image by the magnification of the microscope.*—For example, employ the 3 mm. ($\frac{1}{8}$ in.) objective, 25 mm. (1 in.) ocular, and a Necturus' red blood-corpuscule preparation as object. Obtain the size of the image of the long and short axes of three corpuscles with the camera lucida and dividers, exactly as in obtaining the magnification of the microscope (§ 176). Divide the size of the image in each case by the magnification, and the result gives the actual size of the blood-corpuscules. Thus, suppose the image of the long axis of the corpuscle is 18 mm. and the magnification of the microscope 400 diameters (§ 170), then the actual length of this long axis of the corpuscle is $18 \text{ mm.} \div 400 = 0.045 \text{ mm.}$ or 45μ (§ 182).

FIG. 116. *Preparation of blood with a ring around a group of blood corpuscles.*

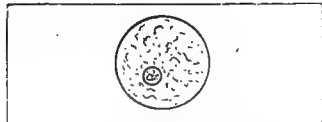

As the same three blood-corpuscules are to be measured in three ways, it is an advantage to put a delicate ring around a group of three or more corpuscles, and make a sketch of the whole enclosed group, marking on the sketch the corpuscles measured (Figs. 70, 75). The different corpuscles vary considerably in size, so that accurate comparison of different methods of measurement can only

ings for the prefixes *micro* and *mega*, meaning respectively one-millionth and one million times the unit before which it is placed. A micromillimeter would then mean one-millionth of a millimeter, not one-thousandth. The term micron has been adopted by the great microscopical societies, the international commission on weights and measures, and by original investigators, and is, in the opinion of the writer, the best term to employ. Jour. Roy. Micr. Soc., 1888, p. 502; Nature, Vol. XXXVII (1888), p. 388.

be made when the same corpuscles are measured in each of the ways.

§ 185. *Micrometry by the use of a Stage Micrometer and a Camera Lucida.*—Employ the same object, objective and ocular as before. Put the camera lucida in position, and with a lead pencil make dots on the paper at the limits of the image of the blood-corpuscles. Measure the same three that were measured in § 184.

Remove the object, place the stage micrometer under the microscope, focus well, and draw the lines of the stage micrometer so as to include the dots representing the limits of the part of the image to be measured. As the value of the spaces on the stage micrometer is known, the size of the object is determined by the number of spaces of the micrometer required to include it.

This simply enables one to put the image of a fine rule on the image of a microscopic object. It is theoretically an excellent method, and nearly the same as measuring the spread of the dividers with a simple microscope (§ 173, 197).

OCULAR MICROMETER

§ 186. *Ocular Micrometer, Eye-Piece Micrometer.*—This, as the name implies, is a micrometer to be used with the ocular. It is a micrometer on glass, and the lines are sufficiently coarse to be clearly seen by the ocular. The lines should be equidistant and $\frac{1}{10}$ or $\frac{1}{20}$ mm. apart, every fifth line should be longer and heavier to facilitate counting. If the micrometer is ruled in squares (*net micrometer*) it will be very convenient for many purposes.

The ocular micrometer is placed in the ocular, no matter what the form of the ocular (*i. e.*, whether positive or negative) at the level at which the real image is formed by the objective, and the image appears to be immediately upon or under the ocular micrometer, and hence the number of spaces on the ocular micrometer required to measure the real image may be read off directly. This, however, is measuring the size of the real image, and the actual size of the object can only be determined by determining the ratio between the size of the real image and the object. In other words, it is necessary to get the *valuation of the ocular micrometer* in terms of a stage micrometer.

§ 187. **Valuation of the Ocular Micrometer.**—This is the value of the divisions of the ocular micrometer for the purposes of micrometry, and is entirely relative, depending on the magnification of the real image formed by the objective, consequently it changes with every change in the magnification of the real image, and must be especially determined for every optical combination (*i. e.*, objective and ocular), and for every change in the length of the tube of the microscope. That is, it is necessary to determine the ocular micrometer valuation for every condition modifying the real image of the microscope (§ 177).

Any Huygenian ocular (Fig. 117) may, however, be used as a micrometer ocular by placing the ocular micrometer at the level of the ocular diaphragm, where the real image is formed. If there is a slit in the side of the ocular, and the ocular micrometer is mounted in some way it may be introduced through the opening at the side. When no side opening exists the mounting of the eye-lens may be unscrewed and the ocular micrometer, if on a cover-glass can be laid on the upper side of the ocular diaphragm.

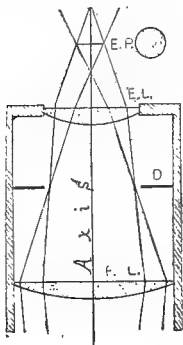

FIG. 117. *Sectional view of a Huygenian ocular.*

Axis. Optic axis of the ocular. *D.* Diaphragm of the ocular. *E. L.* Eye-Lens. *F. L.* Field-Lens.

E. P. Eye-point. In micrometry the ocular micrometer with a Huygenian ocular must be placed at the level of the diaphragm where the real image is formed. In a positive ocular it would be placed below the ocular lenses.

§ 188. **Obtaining the Ocular Micrometer Valuation for an Ocular Micrometer with fixed Lines.**—Use the stage micrometer as object. Light the field well and look into the microscope. The lines of the ocular micrometer should be very sharply defined. If they are not, raise or lower the eye-lens to make them so; that is, focus as with the simple magnifier.

When the lines of the ocular micrometer are distinct, focus the microscope (§ 81, 84) for the stage micrometer. The image of the stage micrometer appears to be directly under or upon the ocular micrometer.

Make the lines of the two micrometers parallel by rotating the

ocular or changing the position of the stage micrometer or both if necessary, and then make any two lines of the stage micrometer coincide with any two on the ocular micrometer. To do this it may be necessary to pull out the draw-tube a greater or less distance. See how many spaces are included in each of the micrometers.

Divide the value of the included space or spaces on the stage micrometer by the number of divisions on the ocular micrometer required to include them, and the quotient so obtained will give the valuation of the ocular micrometer in fractions of the unit of measure of the stage micrometer. For example, suppose the millimeter is taken as the unit for the stage micrometer and this unit is divided into spaces of $\frac{1}{10}$ and $\frac{1}{100}$ millimeters. If with a given optical combination and tube-length it requires 10 spaces on the ocular micrometer to include the real image of $\frac{1}{10}$ millimeter on the stage micrometer, obviously one space on the ocular micrometer includes only one-tenth as much, or $\frac{1}{10}$ mm. $\div 10 = \frac{1}{100}$ mm. That is, each space on the ocular micrometer includes $\frac{1}{100}$ of a millimeter on the stage micrometer, or $\frac{1}{100}$ millimeter of the length of any object under the microscope, the conditions remaining the same. Or, in other words, it requires 100 spaces on the ocular micrometer to include 1 millimeter on the stage micrometer, then as before, 1 space of the ocular micrometer would have a valuation of $\frac{1}{100}$ millimeter for the purposes of micrometry. The size of any minute object may be determined by multiplying this valuation of one space by the number of spaces required to include it. For example, suppose the fly's wing or some part of it covered 8 spaces on the ocular micrometer, it would be known that the real size of the part measured is $\frac{1}{100}$ mm. $\times 8 = \frac{8}{100}$ mm. or 80 μ (§ 182). See Mark, Jour. Applied Microscopy, Vol. I, p. 4.

§ 189. **Micrometry with the Ocular Micrometer.**—Use the 3 mm. ($\frac{1}{8}$ in.) objective with the preparation of Necturus blood-corpuscles as object. Make certain that the tube of the microscope is of the same length as when determining the ocular micrometer valuation. In a word, be sure that all the conditions are exactly as when the valuation was determined, then put the preparation under the microscope and find the same three red corpuscles that were measured in the other ways (§ 184–185).

Count the divisions on the ocular micrometer required to enclose or measure the long and the short axis of each of the three cor-

puscles, multiply the number of spaces in both cases by the valuation of the ocular micrometer for this objective, tube-length and ocular, and the results will represent the actual length of the axes of the corpuscles in each case.

The same corpuscle is, of course, of the same actual size; when measured in each of the three ways, so that if the methods are correct and the work carefully enough done, the same results should be obtained by each method. (§ 197.)*

* There are three ways of using the ocular micrometer, or of arriving at the size of the objects measured with it :

(A) By finding the value of a division of the ocular micrometer for each optical combination and tube-length used, and employing this valuation as a multiplier. This is the method given in the text, and the one most frequently employed. Thus, suppose with a given optical combination and tube-length it required five divisions on the ocular micrometer to include the image of $\frac{1}{10}$ millimeter of the stage micrometer, then obviously one space on the ocular micrometer would include $\frac{1}{5}$ of $\frac{1}{10}$ mm. or $\frac{1}{25}$ mm.; the size of any unknown object under the microscope would be obtained by multiplying the number of divisions on the ocular micrometer required to include its image by the value of one space, or in this case, $\frac{1}{25}$ mm. Suppose some object, as the fly's wing, required 15 spaces of the ocular micrometer to include some part of it, then the actual size of this part of the wing would be $15 \times \frac{1}{25} = \frac{3}{5}$, or 0.6 mm.

(B) By finding the number of divisions on the ocular micrometer required to include the image of an entire millimeter of the stage micrometer, and using this number as a divisor. This number is also sometimes called the *ocular micrometer ratio*. Taking the same case as in (A), suppose five divisions of the ocular micrometer are required to include the image of $\frac{1}{10}$ mm., on the stage micrometer, then evidently it would require $5 \div \frac{1}{10} = 25$ divisions on the ocular micrometer to include a whole millimeter on the stage micrometer, and the number of divisions of the ocular micrometer required to measure an object divided by 25 would give the actual size of the object in millimeters or in a fraction of a millimeter. Thus, suppose it required 15 divisions of the ocular micrometer to include the image of some part of the fly's wing, the actual size of the part included would be $15 \div 25 = \frac{3}{5}$ or 0.6 mm. This method is really exactly like the one in (A), for dividing by 25 is the same as multiplying by $\frac{1}{25}$.

(C) By having the ocular micrometer ruled in millimeters and divisions of a millimeter, and then getting the size of the real image in millimeters. In employing this method a stage micrometer is used as object and the size of the image of one or more divisions is measured by the ocular micrometer, thus: Suppose the stage micrometer is ruled $\frac{1}{10}$ and $\frac{1}{100}$ mm. and the ocular micrometer is ruled in millimeters and $\frac{1}{10}$ mm. Taking $\frac{1}{10}$ mm. on the stage micrometer as object, as in the other cases, suppose it requires 10 of the $\frac{1}{10}$ mm. spaces or 1 mm. to measure the real image, then the real image

§ 190. **Obtaining the Valuation of the Filar Micrometer.**—This micrometer (Figs. 118-120) usually consists of a Ramsden's ocular and cross lines. As seen in Fig. 119 *A* there are three lines. The horizontal and one vertical line are fixed. One vertical line may be moved by the screw back and forth across the field.

For obtaining the valuation of this ocular micrometer an ac-

FIG. 118. *Ocular Screw-Micrometer with compensation ocular $\times 6$. The upper figure shows a sectional view of the ocular and the screw for moving the micrometer at the right. At the left is shown a clamping screw to fasten the ocular to the upper part of the microscope tube. Below is a face view, showing the graduation on the wheel. An ocular micrometer like this is in general like the cob-web micrometer and may be used for measuring objects of varying sizes very accurately. With the ordinary ocular micrometer very small objects frequently fill but a part of an interval of the micrometer, but with this the movable cross lines traverse the object (or rather its real image) regardless of the minuteness of the object. (Zeiss' Catalog.)*

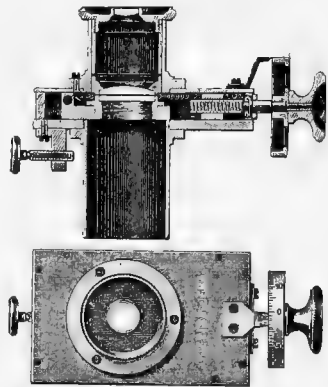

must be magnified $\frac{10}{10} \div \frac{2}{10} = 5$ diameters, that is, the real image is five times as great in length as the object, and the size of an object may be determined by putting it under the microscope and getting the size of the real image in millimeters with the ocular micrometer and dividing it by the magnification of the real image, which in this case is 5 diameters.

Use the fly's wing as object, as in the other cases, and measure the image of the same part. Suppose that it required 30 of the $\frac{1}{10}$ mm. divisions = $\frac{30}{10}$ mm. or 3 mm. to include the image of the part measured, then evidently the actual size of the part measured is 3 mm. $\div 5 = \frac{3}{5}$ mm., the same result as in the other cases. See also § 195-196 on the Eikonometer.

In comparing these methods it will be seen that in the first two (A and B) the ocular micrometer may be simply ruled with equidistant lines without regard to the absolute size in millimeters or inches of the spaces. In the last method the ocular micrometer must have its spaces some known division of a millimeter or inch. In the first two methods only one standard of measure is required, viz.: the stage micrometer; in the last method two standards must be used,—a stage micrometer and an ocular micrometer. Of course, the ocular micrometer in the first two cases must have the lines equidistant as well as in the last case, but ruling lines equidistant is quite a different matter from getting them an exact division of a millimeter or of an inch apart.

curate stage micrometer must be used. Carefully focus the $\frac{1}{100}$ mm. spaces. The lines of the ocular micrometer should also be sharp. If they are not focus them by moving the top of the ocular up or down (§ 188). Make the vertical lines of the filar micrometer parallel with the lines of the stage micrometer. Take the precautions regarding the width of the stage micrometer lines given in § 197 (see also Fig. 123). Note the position of the graduated wheel and of the teeth of the recording comb, and then rotate the wheel until the movable line traverses one space on the stage micrometer. Each tooth of the recording comb indicates a total revolution of the wheel, and by noting the number of teeth required and the graduations on the wheel, the revolutions and part of a revolution required to measure the $\frac{1}{100}$ mm. of the stage micrometer

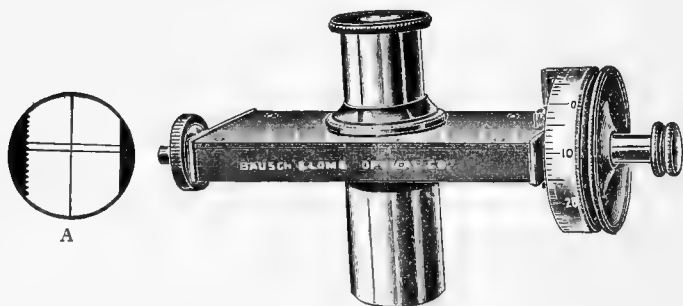

FIG. 119. *Filar Micrometer Ocular.* This filar micrometer ocular is of the Ramsden type and consists of a positive ocular with a moveable hair line and two reference lines at right angles to each other as shown in A. The moveable line must be carried over the entire length of the object to be measured by rotating the drum.

A. Field of the filar micrometer showing the moveable and the cross lines, and the comb. The teeth serve to measure the total revolutions of the drum. (Cut loaned by the Bausch & Lomb Optical Co.)

can be easily noted. Measure in like manner 4 or 5 spaces and get the average. Suppose this average is $1\frac{3}{4}$ revolutions or 125 graduations on the wheel, to measure the $\frac{1}{100}$ mm. or 10μ (see § 182), then one of the graduations on the wheel would measure 10μ divided by $125 = .08\mu$. In using this valuation for actual measurement, the tube of the microscope and the objective must be exactly as when obtaining the valuation (see § 187, 194).

§ 191. **Example of Measurement.**—Suppose one uses the red blood corpuscles of a dog or monkey, etc., every condition being as when the valuation was determined, one notes very accurately how many of the graduations on the wheel are required to make the movable line traverse the object from edge to edge. Suppose it requires 94 of the graduations to measure the diameter, the actual size of the corpuscle would be $94 \times .08 \mu = 7.52 \mu$.

The advantage of the filar micrometer is that the valuation of one graduation being so small, even the smallest object to be measured would require several graduations to measure it. In ocular micrometers with fixed lines, small objects like bacteria might not fill even one space, therefore estimations, not measurements, must be made. For large objects, like most of the tissue elements, the ocular micrometers with fixed lines answer very well, for the part which must be estimated is relatively small and the chance of error is correspondingly small.

§ 192. **Obtaining the Valuation of the Combined Ocular Micrometer** (Fig. 120).—To obtain the valuation of this ocular micrometer one proceeds exactly as for the micrometer with fixed lines (§ 188), except that a partial stage micrometer space can be measured by rotating the drum until the ocular micrometer exactly coincides with the stage micrometer. One can then count up the number of spaces on the ocular micrometer required to measure one or more spaces on the stage micrometer. To this is then added the 100 hundredths of a space indicated on the drum. For example suppose that it required 7 complete spaces of the ocular micrometer and the drum showed 50 hundredths to measure 3 spaces (3 hundredths mm.) on the stage micrometer, then each space on the ocular micrometer would be equal to $0.03 \text{ mm.} \div 7.50 = 0.004 \text{ mm.}$ or 4μ . One of the spaces on the drum which represents one hundredth of an interval on the ocular micrometer would have a valuation under these conditions of only 0.04μ . This gives a clear notion of the minuteness of the objects which can be measured and of the smallness of the error in measuring large objects even if one should get the object a few of the drum divisions too small or too large.

§ 193. **Example of Measurement with the Combined Ocular Micrometer.**—Select an oval corpuscle of some lower

animal (frog, hen, turtle, etc.). Arrange the micrometer ocular so that the long axis of the corpuscle will coincide with the cross line in the micrometer scale (Fig. 121). Get one end of the corpuscle exactly level with one end of the micrometer scale. Note the position of the drum, and then rotate it until the other end of the corpuscle is exactly against the nearest line of the micrometer. Count up the entire intervals required and the partial interval on the drum. Suppose it requires 5 entire and 0.60 intervals (see explanation of Fig. 121) then the whole corpuscle must be 5.60 intervals multiplied by 4μ , the value of one interval: $5.60 \times 4 = 22.4\mu$.

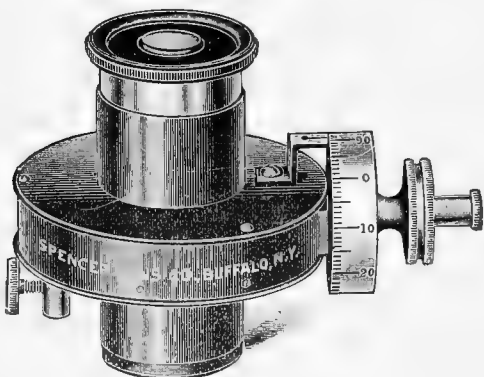

FIG. 120. *Screw Ocular Micrometer with moveable scale. This is a Huygenian ocular with a 5 mm. scale divided into 20 $\frac{1}{4}$ mm. intervals. The pitch of the screw moving the scale is $\frac{1}{4}$ mm. therefore one complete revolution of the drum moves the scale one interval or $\frac{1}{4}$ mm. The drum is divided into 100 graduations thus enabling one to measure 100th of an interval on the micrometer scale.*

This ocular micrometer combines the advantages of the ocular micrometer with fixed scale and the filar micrometer. To complete the measurement of an object not exactly between any two of the micrometer lines the drum need be revolved only partly around. (Cut loaned by the Spencer Lens Co.)

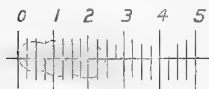

FIG. 121. *Figure of the scale of the screw ocular micrometer, showing the divisions and the cross line. At the left is shown an object on the scale not quite filling 10 of the intervals. To measure this the drum need be revolved only sufficiently to measure the part of the interval filled by the object being measured.*

Originally the scale was divided in 50 $\frac{1}{10}$ mm. spaces, and no cross line was present. In 1905 the present form of scale was specially prepared from the writer's specifications, and has since that time been regularly supplied.

(Cut loaned by the Spencer Lens Co.)

§ 194. **Varying the Ocular Micrometer Valuation.**—Any change in the objective, the ocular or the tube-length of the microscope, that is to say, any change in the size of the real image, pro-

duces a corresponding change in the ocular micrometer valuation (§ 177, 187, 197).

§ 195. **Eikonometer for Magnification and Micrometry.**—The eikonometer is something like an eye. It has a converging lens serving in place of the crystalline lens to focus the rays from the eye-piece of the compound microscope, or from the simple microscope upon a micrometer scale, the scale taking the place of the retina in the eye (Fig. 16). This scale is ruled in $\frac{1}{10}$ mms. Above the scale is a Ramsden's ocular of 25 mm. equivalent focus, giving a magnification of 10. The eikonometer scale therefore is a millimeter scale when seen at the distance of 250 mm. in the visual field of the normal human eye, and it enables one to put a millimeter scale on the image of any object studied.

To use it for magnification a stage micrometer is put under the microscope and carefully focused. Then the eikonometer is put in place over the ocular. The microscopic image of the stage micrometer and the scale of the eikonometer will then appear in the same field as with the ordinary ocular micrometer (§ 188). The two sets of lines should be made parallel. See how many divisions of the eikonometer millimeter scale are required to measure one or more of the divisions of the image of the stage micrometer. Suppose it requires 6 intervals or millimeters of the eikonometer scale to measure the image of $\frac{3}{100}$ mm. on the stage micrometer. The size of the object is then $\frac{3}{100}$ mm. and of its image 6 mm. The magnification is therefore (§ 170) $6 \text{ mm.} \div \frac{3}{100} = 200$.

For determining the magnification of a simple microscope the eikonometer is placed over the simple microscope as it was over the ocular above. With this instrument as with the camera lucida only one eye is used (§ 176).

§ 196. **Micrometry with the Eikonometer.**—In the first place the magnification of the microscope must be determined as described in the preceding section; and one must keep in mind the factors which will vary the magnification (§ 177). The object to be measured is put under the microscope and focused and the eikonometer put in position. The virtual image is then measured in millimeters by the eikonometer mm. scale. The size of this virtual image is then divided by the magnification and the result will be the actual size of the object as in (§ 184).

For example suppose the long axis of a Necturus' red blood corpuscle measures 9 mm. on the eikonometer scale. If the magnification of the microscope is 200 as found above then the actual length of the corpuscle is $9 \text{ mm.} \div 200 = 0.045 \text{ mm.}$, or 45μ . (See A. E. Wright, Jour. Roy. Micr. Soc., 1904, pp. 261, 279; Principles of Microscopy, pp. 145, 163.)

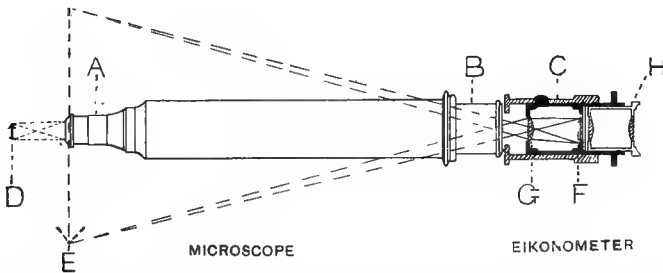

FIG. 122. *Wright's Eikonometer for Magnification and Micrometry* — (From Beck's Catalog.)

A. Objective; B. Ocular; D. The object; E. Virtual image of the microscope; C. The Eikonometer placed over the ocular. The lens G, produces a real image on the eikonometer scale at F. This scale and real image are then viewed through the Ramsden ocular of 25 mm. equivalent focus, H.

§ 197. **Remarks on Micrometry.**—In using adjustable objectives (§ 27, 114), the magnification of the objective varies with the position of the adjusting collar, being greater when the adjustment is closed as for thick cover-glasses than when open, as for thin ones. This variation in the magnification of the objective produces a corresponding change in the magnification of the entire microscope, and the ocular micrometer valuation—therefore it is necessary to determine the magnification and ocular micrometer valuation for each position of the adjusting collar.

While the principles of micrometry are simple, it is very difficult to get the exact size of microscopic objects. This is due to the lack of perfection and uniformity of micrometers, and the difficulty of determining the exact limits of the object to be measured. Hence, all microscopic measurements are only approximately correct, the error lessening with the increasing perfection of the apparatus and the skill of the observer.

A difficulty when one is using high powers is the width of the lines of the micrometer. If the micrometer is perfectly accurate half the width of each line belongs to the contiguous spaces, hence one should measure the image of the space from the centers of the lines bordering the space, or as this is somewhat difficult in using the ocular micrometer, one may measure

from the inside of one bordering line and from the outside of the other. If the lines are of equal width this is as accurate as measuring from the center of the lines. Evidently it would not be right to measure from either the inside or the outside of both lines (Fig. 123).

It is also necessary in micrometry to use an objective of sufficient power to enable one to see all the details of an object with great distinctness. The necessity of using sufficient amplification in micrometry has been especially remarked upon by Richardson, *Monthly Micr. Jour.*, 1874, 1875; Rogers, *Proc. Amer. Soc. Microscopists*, 1882, p. 239; Ewell, *North American Pract.*, 1890, pp. 97, 173.

FIG. 123. *The appearance of the coarse stage micrometer and of the fine ocular micrometer lines when using a high objective.*

(A). *The method of measuring the spaces by putting the fine ocular micrometer lines opposite the center of the coarse stage micrometer lines.*

(B). *Method of measuring the spaces of the stage micrometer by one line of the ocular micrometer (o. m.) at the inside and one at the outside of the coarse stage micrometer lines (s. m.).*

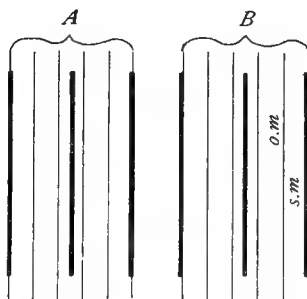

As to the limit of accuracy in micrometry, one who has justly earned the right to speak with authority expresses himself as follows: "*I assume that 0.2 μ is the limit of precision in microscopic measures beyond which it is impossible to go with certainty.*" W. A. Rogers *Proc. Amer. Soc. Micrs.*, 1883, p. 198.

In comparing the methods of micrometry with the compound microscope given above (§ 183, 184, 185, 189, 191, 193, 196), the one given in § 183 is impracticable, that given in § 184 is open to the objection that two standards are required,—the stage micrometer, and the steel rule; it is open to the further objection that several different operations are necessary, each operation adding to the probability of error. Theoretically the method given in § 185 is good, but it is open to the very serious objection in practice that it requires so many operations which are especially liable to introduce errors. The method that experience has found most safe and expeditious, and applicable to all objects, is the method with the ocular micrometer. If the valuation of the ocular micrometer has been accurately determined, then the only difficulty is in deciding on the exact limits of the objects to be measured and so arranging the ocular micrometer that these limits are inclosed by some divisions of the micrometer. Where the object is not exactly included by whole spaces on the ocular micrometer, the chance of error comes in, in estimating just how far into a space the object reaches on the side not in contact with one of the micrometer lines. If the ocular micrometer has some quite narrow spaces, and

others considerably larger, one can nearly always manage to exactly include the object by some two lines. The ocular screw micrometers (Figs. 118-120) obviate this entirely as the cross hair or lines traverse the object or its real image, and whether this distance be great or small it can be read off on the graduated wheel, and no estimation or guess work is necessary.

The new method by means of Wright's Eikonometer (§§ 195-6) is spoken of very favorably by experts who have employed it. For those especially interested in micrometry, as in its relation to medical jurisprudence, the following references are recommended. These articles consider the problem in a scientific as well as a practical spirit: The papers of Prof. Wm. A. Rogers on micrometers and micrometry, in the *Amer. Quar. Micr. Jour.*, Vol. I. pp. 97, 208; *Proceedings Amer. Soc. Microscopists*, 1882, 1883, 1887. Dr. M. D. Ewell, *Proc. Amer. Soc. Micrs.*, 1890; *The Microscope*, 1889, pp. 43-45; *North Amer. Pract.*, 1890, pp. 97, 173. Dr. J. J. Woodward, *Amer. Jour. of the Med. Sci.*, 1875. M. C. White, Article "Blood-stains," *Ref. Hand-book Med. Sciences*, 1885. *Medico-Legal Journal*, Vol. XII. For the change in magnification due to a change in the adjustment of adjustable objectives, see *Jour. Roy. Micr. Soc.* 1880, p. 702; *Amer. Monthly Micr. Jour.*, 1880, p. 67. Carpenter-Dallinger, p. 270 and end of § 196.

If one consults the medico-legal journals; the microscopical journals, the *Index Medicus*, and the *Index Catalog* of the Library of the Surgeon General's Office, under Micrometry, Blood, and Jurisprudence, he can get on track of the main work which has been and is being done.



10 CENTIMETER RULE

The upper edge is in millimeters, the lower in centimeters, and half centimeters.

THE METRIC SYSTEM

UNITS.

The most commonly used divisions and multiples

THE METER FOR	{	<i>Centimeter</i> (c. m.), 1-100th Meter; <i>Millimeter</i> (m. m.), 1-1000th Meter;
LENGTH . . .		<i>Micron</i> (μ), 1-1000th Millimeter; the <i>Micron</i> is the unit in <i>Micrometry</i> (§166). <i>Kilometer</i> , 1000 Meters; used in measuring roads and other long distances.
THE GRAM FOR	{	<i>Milligram</i> (m. g.), 1-1000th Gram.
WEIGHT . . .		<i>Kilogram</i> , 1000 Grams, used for ordinary masses, like groceries, etc.
THE LITER FOR	{	<i>Cubic Centimeter</i> (c. c.), 1-1000th Liter. This is more common than the
CAPACITY . . .		correct form, <i>Milliliter</i> .

Divisions of the Units are indicated by the Latin prefixes; *deci*, 1-10th; *centi*, 1-100th; *Milli*, 1-1000th; *Micro*, 1-1,000,000th of any unit.

Multiples are designated by Greek prefixes: *deka*, 10 times *hecto*, 100 times; *kilo*, 1000 times; *myria* 10,000 times; *Mega*, 1,000,000 times any unit.

CHAPTER V

DRAWING WITH THE MICROSCOPE

APPARATUS AND MATERIAL FOR THIS CHAPTER

Microscope, Abbe and Wollaston's camera lucidas, drawing board, thumb tacks, pencils, paper, and microscope screen, (Fig. 66), microscopic preparations.

DRAWING MICROSCOPIC OBJECTS

§ 198. Microscopic objects may be drawn free-hand directly from the microscope, but in this way a picture giving only the general appearance and relations of parts is obtained. For pictures which shall have all the parts of the object in true proportions and relations, it is necessary to obtain an exact outline of the image of the object, and to locate in this outline all the principal details of structure. It is then possible to complete the picture free-hand from the appearance of the object under the microscope. The appliance used in obtaining outlines, etc., of the microscope image is known as a *camera lucida*.

§ 199. **Camera Lucida.**—This is an optical apparatus for enabling one to see objects in greatly different situations, as if in one field of vision, and with the same eye. In other words it is an optical device for superimposing or combining two fields of view in one eye.

As applied to the microscope, it causes the magnified virtual image of the object under the microscope to appear as if projected upon the table or drawing board, where it is visible with the drawing paper, pencil, dividers, etc., by the same eye, and in the same field of vision. The microscopic image appears like a picture on the drawing paper (see note to § 202). This is accomplished in two distinct ways:

(A) By a camera lucida reflecting the rays from the microscope so that their direction when they reach the eye coincides with that

of the rays from the drawing paper, pencil, etc. In some of the camera lucidas from this group (Wollaston's, Figs. 108, 112), the rays are reflected twice, and the image appears as when looking

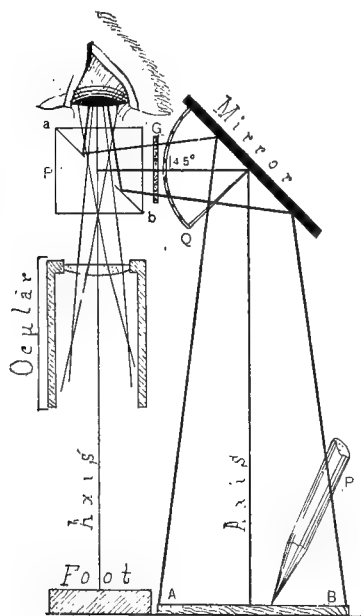

FIG. 124

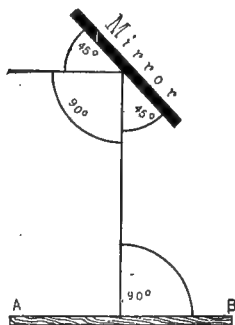

FIG. 125

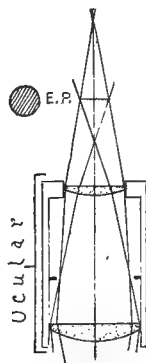

FIG. 126

FIG. 124. *Abbe Camera Lucida with the mirror at 45°, the drawing surface horizontal, and the microscope vertical.*

Axis, Axis. Axial ray from the microscope and from the drawing surface. *A, B.* Marginal rays of the field on the drawing surface. *a, b.*

Sectional view of the silvered surface on the upper of the triangular prisms composing the cubical prism (P). The silvered surface is shown as incomplete in the center, thus giving passage to the rays from the microscope.

Foot. Foot or base of the microscope.

G. Smoked glass seen in section. It is placed between the mirror and the prism to reduce the light from the drawing surface.

Mirror. The mirror of the camera lucida. A Quadrant (Q) has been added to indicate the angle of inclination of the mirror, which in this case is 45°.

Ocular. Ocular of the microscope over which the prism of the camera lucida is placed.

P, P. Drawing pencil and the cubical prism over the ocular.

FIG. 125. Geometrical figure showing the angles made by the axial ray with the drawing surface and the mirror.

A, B. The drawing surface.

FIG. 126. Ocular showing eye-point, *E. P.* It is at this point both horizontally and vertically that the hole in the silvered surface should be placed (§ 203).

directly into the microscope. In others the rays are reflected but once, and the image has the inversion produced by a plane mirror. For drawing purposes this inversion is a great objection, as it is necessary to similarly invert all the details added free-hand.

(B) By a camera lucida reflecting the rays of light from the drawing paper, etc., so that their direction when they reach the eye coincides with the direction of the rays from the microscope (Fig. 65, 124). In all of the camera lucidas of this group, the rays from the paper are twice reflected and no inversion appears.

The better forms of camera lucidas (Wollaston's, Grunow's, Abbe's, etc.), may be used for drawing both with low and with high powers. Some require the microscope to be inclined (Fig. 111) while others are designed to be used on the microscope in a vertical position. As in biological work, it is often necessary to have the microscope vertical, the form for a vertical microscope is to be preferred; but see Fig. 130.

§ 200. **Avoidance of Distortion.**—*In order that the picture drawn by the aid of a camera lucida may not be distorted, it is necessary that the axial ray from the image on the drawing surface shall be at right angles to the drawing surface (Figs. 127, 129).*

§ 201. **Wollaston's Camera Lucida.**—This is a quadrangular prism of glass put in the path of the rays from the microscope, and it serves to change the direction of the axial ray 90 degrees. In using it the microscope is made horizontal, and the rays from the microscope enter one-half of the pupil while rays from the drawing surface enter the other half of the pupil. As seen in figure 127, the fields partly overlap, and where they do so overlap, pencil or dividers and microscopic image can be seen together.

In drawing or using the dividers with the Wollaston camera lucida it is necessary to have the field of the microscope and the drawing surface about equally lighted. If the drawing surface is too brilliantly lighted the pencil or dividers may be seen very clearly, but the microscopic image will be obscure. On the other hand, if the field of the microscope has too much light the microscopic image will be very definite, but the pencil or dividers will not be visible. It is necessary, as with the Abbe camera lucida (§ 203), to have the Wollaston prism properly arranged with reference to the axis of the microscope and the eye-point. If it is not, one will be unable to see the image well, and may be entirely unable to see the pencil and the image at the same time. Again, as rays from the microscope and from the drawing surface must enter independent parts of the pupil of the same eye, one must hold the eye so that the pupil is partly over the camera lucida and partly over the drawing surface. One can tell the proper position by trial. This is not a very satisfactory camera to draw with, but it is a very good form to measure the vertical dis-

tance of 250 mm. at which the drawing surface should be placed when determining magnification (§ 178).

§ 202. ***Abbe Camera Lucida.**—This consists of a cube of glass cut into two triangular prisms and silvered on the cut surface of the upper one. A small oval hole is then cut out of the center of the silvered surface and the two prisms are cemented together in the form of the original cube with a perforated 45 degree mirror within it (Fig. 124, a b). The upper surface of the cube is covered by a perforated metal plate. This cube is placed over the ocular in such a way that the light from the microscope passes through the hole in the silvered face and thence directly to the eye. Light from the drawing surface is reflected by a mirror to the silvered surface of the prism and reflected by this surface to the eye in company with the rays from the microscope, so that the two fields appear as one, and the image is seen as if on the drawing surface (Figs. 124, 129). It is designed for use with a vertical microscope. [Compare § 205.]

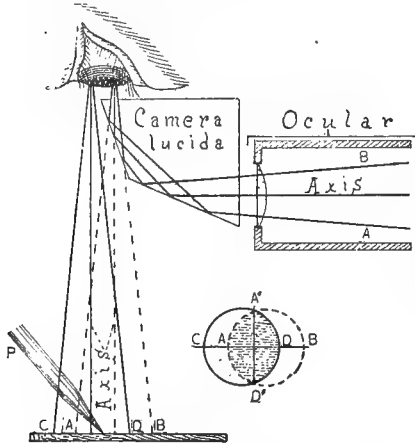

FIG. 127. *Wollaston's Camera Lucida, showing the rays from the microscope and from the drawing surface, and the position of the pupil of the eye. See also Fig. 112.*

For full explanation see Fig. 108

*For some persons the image and drawing surface, pencil, etc., do not appear on the drawing board as stated above, but under the microscope, according to the general principle that "objects appear in space where they could be touched along a perpendicular to the retinal surface stimulated,"—that is in the line of rays entering the eye. This is always the case with the Wollaston camera lucida. The explanation of the apparent location of the image, etc., on the drawing board with the Abbe camera lucida is that the attention is concentrated upon the drawing surface rather than upon the object under the microscope (Dr. W. B. Pillsbury).

§ 203. **Arrangement of the Camera Lucida Prism.**—In placing this camera lucida over the ocular for drawing or the determination of magnification, the center of the hole in the silvered surface is placed in the optic axis of the microscope. This is done by properly arranging the centering screws that clamp the camera to the microscope tube or ocular. The perforation in the silvered surface must also be at the level of the eye-point. In other words the prism must be so arranged vertically and horizontally that the hole in the silvered surface is in the axis of the microscope and coin-

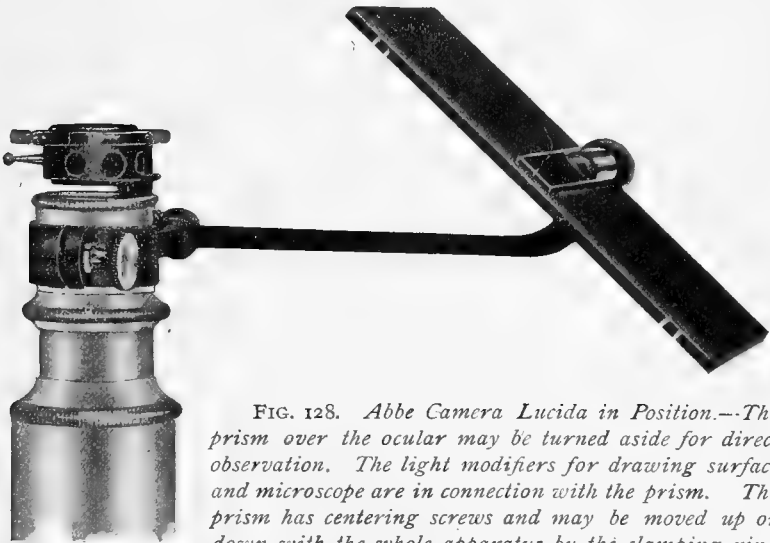

FIG. 128. *Abbe Camera Lucida in Position.*—The prism over the ocular may be turned aside for direct observation. The light modifiers for drawing surface and microscope are in connection with the prism. The prism has centering screws and may be moved up or down with the whole apparatus by the clamping ring around the top of the draw-tube. This serves to place the prism at the proper vertical level for the eye-point of different oculars. (Cut loaned by the Spencer Lens Co.)

cident with the eye-point of the ocular. If it is above or below, or to one side of the eye-point, part or all of the field of the microscope will be cut off. As stated above, the centering screws are for the proper horizontal arrangement of the prism. The prism is set at the right height by the makers for the eye-point of a medium ocular. If one desires to use an ocular with the eye-point farther away or nearer, as in using high or low oculars the position of the eye-point may be determined as directed in § 67 and the prism loosened and

raised or lowered to the proper level ; but in doing this one should avoid setting the prism obliquely to the mirror.

In the latest and best forms of this camera lucida special arrangements have been made for raising or lowering the prism so that it may be used with equal satisfaction on oculars with the eye-point at different levels, and the prism is hinged to turn aside without disturbing the mirror (Figs. 128, 132).

One can determine when the camera is in a proper position by looking into the microscope through it. If the field of the microscope appears as a circle and of about the same size as without the camera lucida, then the prism is in a proper position. If one side of the field is dark, then the prism is to one side of the center ; if the field is considerably smaller than when the prism is turned off the ocular, it indicates that it is not at the correct level, *i. e.*, it is above or below the eye-point.

§ 204. **Arrangement of the Mirror and the Drawing Surface.**—The Abbe camera lucida was designed for use with a vertical microscope (Fig. 124). On a vertical microscope if the mirror is set at an angle of 45° , the axial ray is at right angles with the table top or a drawing board which is horizontal, and a drawing made under these conditions is in true proportion and not distorted. The stage of most microscopes, however, extends out so far at the sides that with a 45° mirror the image appears in part on the stage of the microscope. In order to avoid this the mirror may be depressed to some point below 45° , say at 40° or 35° (Fig. 129). But as the axial ray from the mirror to the prism must still be reflected horizontally, it follows that the axial ray no longer forms an angle of 90 degrees with the drawing surface, but a greater angle. If the mirror is depressed to 35° , then the axial ray takes an angle of 110° with a horizontal drawing surface (see the geometrical figure Fig. 129 A). To make the angle 90° again, so that there shall be no distortion, the drawing board must be raised toward the microscope 20° . The general rule is to raise the drawing board twice as many degrees toward the microscope as the mirror is depressed below 45° . Practically the field for drawing can always be made free of the stage of the microscope, at 45° , at 40° , or at 35° . In the first case (45° mirror) the drawing surface should be horizontal, in the second case (40° mirror) the drawing surface should be elevated 10° , and in the third case (35° mirror) the draw-

ing board should be elevated 20° toward the microscope. Furthermore it is necessary in using an elevated drawing board to have the mirror bar project directly laterally so that the edges of the mirror are in planes parallel with the edges of the drawing board, otherwise there will be front to back distortion, although the elevation of the drawing board avoids right to left distortion. If one has a micrometer ruled in squares (*net micrometer*) the distortion produced by not having the axial ray at right angles with the drawing surface may be very strikingly shown. For example, set the mirror at 35° and use a horizontal drawing board. With a pencil make dots at the corners of some of the squares, and then with a straight edge connect the dots. The figures will be considerably longer from right to left than from front to back. Circles in the object appear as ellipses in the drawings, the major axis being from right to left.

The angle of the mirror may be determined with a protractor, but that is troublesome. It is much more satisfactory to have a quadrant attached to the mirror and an indicator on the projecting arm of the mirror. If the quadrant is graduated throughout its entire extent, or preferably at three points, 45° , 40° and 35° , one can set the mirror at a known angle in a moment, then the drawing board can be hinged and the elevation of 10° and 20° determined with a protractor. The drawing board is very conveniently held up by a broad wedge. By marking the position of the wedge for 10° and 20° the protractor need be used but once, then the wedge may be put into position at any time for the proper elevation.

§ 205. **Abbe Camera and Inclined Microscope.**—It is very fatiguing to draw continuously with a vertical microscope, and many mounted objects admit of an inclination of the microscope, when one can sit and work in a more comfortable position. The Abbe camera is as perfectly adapted to use with an inclined as with a vertical microscope. All that is requisite is to be sure that the fundamental law is observed regarding the axial ray of the image and the drawing surface, viz., that they should be at right angles. This is very easily accomplished as follows: The drawing board is raised toward the microscope twice as many degrees as the mirror is depressed below 45° (§ 204), then it is raised exactly as many degrees as the microscope is inclined, and in the same direction, that is, so the end of the drawing board shall be in a plane parallel with the

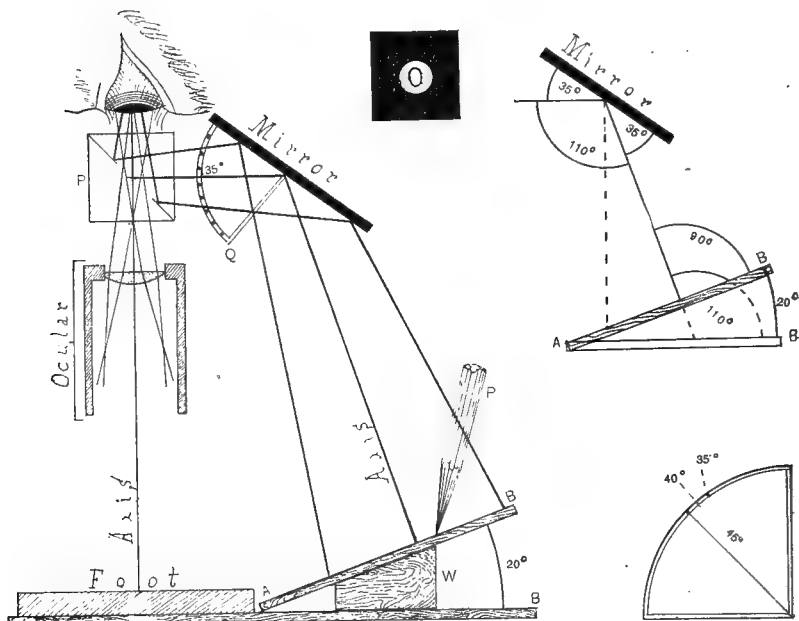

FIG. 129

Abbe Camera Lucida in position to avoid distortion.

FIG. 129. The Abbe Camera Lucida with the mirror at 35° .

Axis, Axis. Axial ray from the microscope and from the drawing surface.

A. B. Drawing surface raised toward the microscope 20° .

Foot. The foot or base of the microscope.

Mirror with quadrant (Q). The mirror is seen to be at an angle of 35° .
Ocular. Ocular of the Microscope.

P. P. Drawing pencil and the cubical prism over the ocular.

W. Wedge to support the drawing board.

A. Geometrical figure of the preceding, showing the angles made by the axial ray with the mirror and the necessary elevation of the drawing board to avoid distortion. From the equality of opposite angles, the angle of the axial ray reflected at 35° makes an angle of 110° with a horizontal drawing board. The board must then be elevated toward the microscope 20° in order that the axial ray may be perpendicular to it, and thus fulfil the requirements necessary to avoid distortion (§ 200, 204).

B. Upper view of the prism of the camera lucida. A considerable portion of the face of the prism is covered, and the opening in the silvered surface appears oval.

C. Quadrant to be attached to the mirror of the Abbe Camera Lucida to indicate the angle of the mirror. As the angle is nearly always 45° , 40° or 35° , only those angles are shown.

stage of the microscope. The mirror must have its edges in planes parallel with the edges of the drawing board also (Fig. 130.)

§ 206. **Drawing with the Abbe Camera Lucida.**—(A) The light from the microscope and from the drawing surface should be of nearly equal intensity, so that the image and the drawing pencil can be seen with about equal distinctness. This may be accomplished

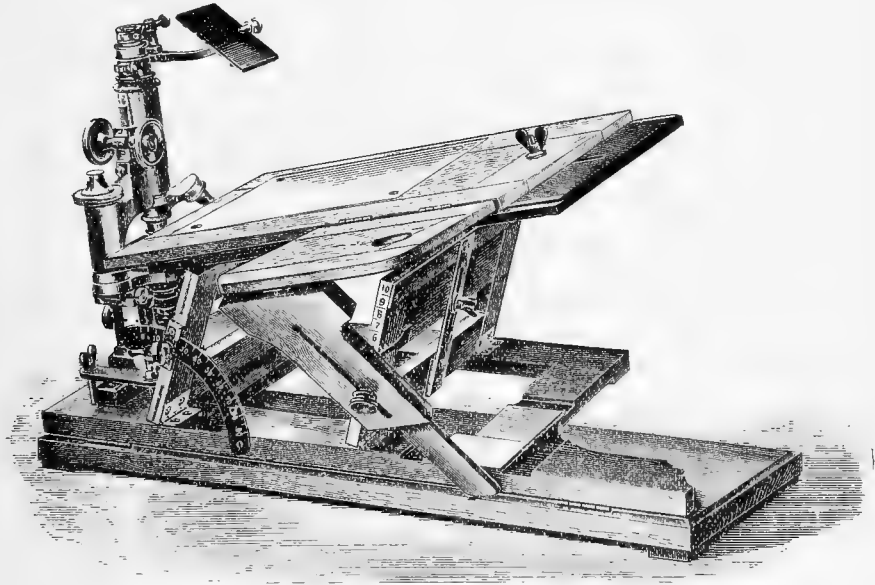

FIG. 130. *Bernhard's Drawing Board for the Abbe Camera Lucida.*—This drawing board is adjustable vertically, and the board may be inclined to prevent distortion. It is also arranged for use with an inclined microscope, having the base board hinged, Microscope and drawing surface are then inclined together. (*Zeit. wiss. Mikroskopie*, vol. VII., 1894, p. 298.) (*Zeiss Catalog.*)

with very low powers (16 mm. and lower objectives) by covering the mirror of the microscope with white paper when transparent objects are to be drawn. For high powers it is best to use a substage condenser. Often the light may be balanced by using a larger or smaller opening in the diaphragm. One can tell which field is excessively illuminated, for it is the one in which objects are most distinctly seen. If it is the microscopic, then the image of the micro-

scopic object is very distinct and the pencil is invisible or very indistinct. If the drawing surface is too brilliantly lighted the pencil can be seen clearly, but the microscopic image is obscure.

When opaque objects, that is objects which must be lighted with reflected light (§ 72), like dark colored insects, etc., are to be drawn the light must usually be concentrated upon the object in some way. The microscope may be placed in a very strong light and the drawing board shaded or the light may be concentrated upon the object by means of a concave mirror or a bull's eye condenser (Fig. 60).

If the drawing surface is too brilliantly illuminated, it may be shaded by placing a book or a ground glass screen between it and the window, also by putting one or more smoked glasses in the path of the rays from the mirror (Fig. 124 G). If the light in the microscope is too intense, it may be lessened by using white paper over the mirror, or by a ground glass screen between the microscope mirror and the source of light (Piersol, Amer. M. M. Jour., 1888, p. 103). It is also an excellent plan to blacken the end of the drawing pencil with carbon ink. Sometimes it is easier to draw on a black surface, using a white pencil or style. The carbon paper used in manifolding letters, etc., may be used, or ordinary black paper may be lightly rubbed on one side with a moderately soft lead pencil. Place the black paper over white paper and trace the outlines with a pointed style of ivory or bone. A corresponding dark line will appear on the white paper beneath. (Jour. Roy. Micr. Soc., 1883, p. 423).

(A) It is desirable to have the drawing paper fastened with thumb tacks, or in some other way. (B) The lines made while using the camera lucida should be very light, as they are liable to be irregular. (C) Only outlines are drawn and parts located with a camera lucida. Details are put in free-hand. (D) It is sometimes desirable to draw the outline of an object with a moderate power and add the details with a higher power. If this is done it should always be clearly stated. It is advisable to do this only with objects in which the same structure is many times duplicated, as a nerve or a muscle. In such an object all the different structures can be shown, and by omitting some of the fibers the others may be made plainer without an undesirable enlargement of the entire figure.

(E) If a drawing of a given size is desired and it cannot be obtained by any combination of oculars, objectives and lengths of the tube of the microscope, the distance between the camera lucida and the table may be increased or diminished until the image is of the desired size. This distance is easily changed by the use of a book or a block, but more conveniently if one has a drawing board with adjustable drawing surface like that shown in Fig. 130.

(F) It is of the greatest advantage, as suggested by Heinsius (*Zeit. w. Mikr.*, 1889, p. 367), to have the camera lucida hinged so that the prism may be turned off the ocular for a moment's glance at the preparation, and then returned in place without the necessity of loosening screws and readjusting the camera. This form is now made by several opticians, and a quadrant is added by some. (Fig. 128, 132.) Any skilled mechanic can add the quadrant.

§ 207. **Magnification of the Microscope and size of Drawings with the Abbe Camera Lucida.**—In determining the standard distance of 250 millimeters at which to measure the image in getting the magnification of the microscope, it is necessary to measure from the point marked P on the prism (Fig. 124) to the axis of the mirror and then vertically to the drawing board.

In getting the scale to which a drawing is enlarged the best way is to remove the preparation and put in its place a stage micrometer, and to trace a few (5 or 10) of its lines upon one corner of the drawing. The value of the spaces of the micrometer being given, thus:



FIG. 131. *Showing the method of indicating the scale at which a drawing was made.*

The enlargement of the figure can then be accurately determined at any time by measuring with a steel scale the length of the image of the micrometer spaces and dividing it by their known size.

Thus, suppose the 5 spaces of the scale of enlargement given with a drawing were found to measure 25 millimeters and the spaces on the micrometer were $\frac{1}{10}$ millimeter, then the enlargement is $25 \div \frac{5}{10} = 500$. That is, the image was drawn at a magnification of 500 diameters.

If the micrometer scale is added to every drawing, there is no need of troubling one's self about the exact distance at which the drawing is made, convenience may settle that, as the special magnification in each case may be determined from the scale accompanying the picture. It should be remembered, however, that the conditions when the scale is drawn must be exactly as when the drawing was made.

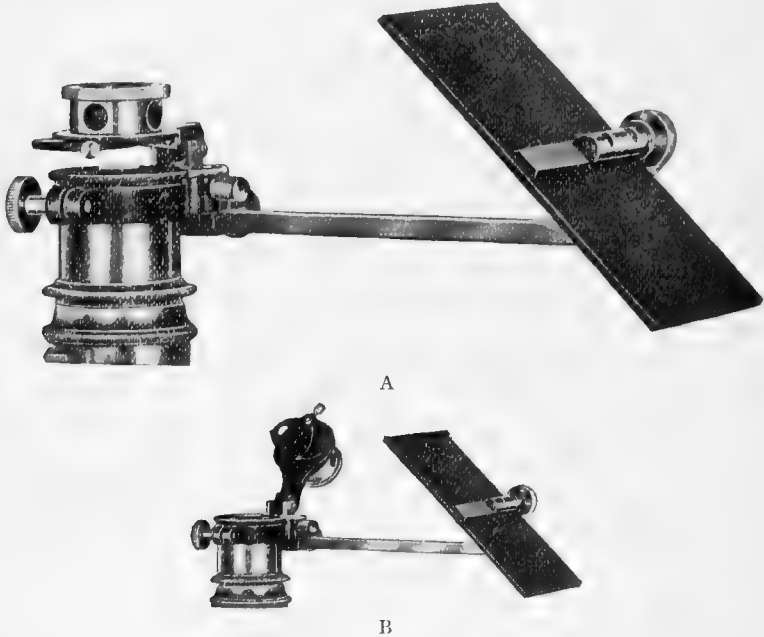

FIG. 132 A. B. *Abbe Camera Lucida.* (A.) In this figure the camera lucida is in position for drawing. The ring or collar supporting the mirror is graduated so that the angle of the mirror may be exactly determined. Smoked glasses serve to modify the light from the microscope or from the drawing surface as needed. By means of a clamping ring the instrument may be raised or lowered to accommodate the eye-point in different oculars.

(B.) In this figure the camera lucida prism is turned back so that one may look directly into the ocular. (Cuts loaned by the Bausch & Lomb Optical Co.)

§ 208. **Drawing at Slight Magnification.**—Some objects are of considerable size and for drawings should be enlarged but a few diameters,—5 to 20. By using sufficiently low objectives and different oculars a great range may be obtained. Frequently, however,

the range must be still further increased. For a moderate increase in size the drawing surface may be put farther off or, as one more commonly needs less rather than greater magnification, the drawing surface may be brought nearer the mirror of the camera lucida by piling books or other objects on the drawing board. If one takes the precaution to draw a scale on the figure under the same conditions, its enlargement can be readily determined (§ 207).

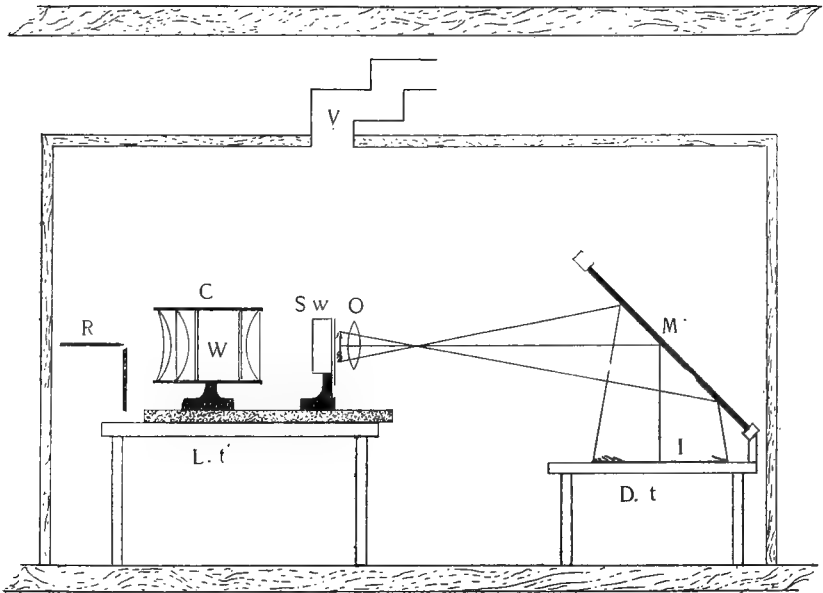

FIG. 133. *Room and Apparatus for Drawing with the Projection Microscope.* R. Radiant, an arc lamp with carbons at a right angle; L. t. Lamp and microscope table; C. Condenser with W. a large water bath between the lenses to absorb the heat rays; S. w. Stage and stage water bath on which rests the object and keeps the object cool by radiation as well as by absorption; O. The objective representing the microscope; M. Mirror at 45° on a drawing table, (Dt.). As the microscope is horizontal so that the axial ray is reflected downward at right angles by the 45° mirror there is no distortion. The scale of the drawing is added exactly as described in § 207.

A very satisfactory way to draw at low magnifications is to use a simple microscope and arrange a camera lucida over it as over the ocular. In this way one may get drawings at almost any low magnification.

If one has many large objects to draw at a low magnification, then some form of embryograph is very convenient. (Jour. Roy. Micr., Soc., 1899, p. 223.) The writer has made use of a photographic camera and different photographic objectives for the purpose. The object is illuminated as if for a photograph and in place of the ground glass a plain glass is used and on this some tracing paper is stretched. Nothing is then easier than to trace the outlines of the object. See also Ch. VIII.

§ 209. **Drawing with the Projection Microscope.**—Except for the highest powers and for details of cell structure the projection microscope furnishes the most satisfactory means of making drawings. With it one can draw large diagrams or small figures directly from the objects; and if the apparatus is properly constructed one may make diagrams from objects 60 to 70 mm. in diameter down to those of half a millimeter or less. This method was much in vogue and highly commended by the older microscopists who used the solar microscope (Baker, Adams and Goring). Since the general introduction of electric lighting drawing with the projection microscope has become once more common and is the most satisfactory method known especially for the numerous drawings necessary for the preparation of models in wax or blotting paper. See Ch. X.

REFERENCES FOR CHAPTER V

Beale, 31, 355; Behrens, Kossel and Schiefferdecker, 77; Carpenter-Dallinger, 278; Van Heurck, 91; American Naturalist, 1886, p. 1071, 1887, pp. 1040-1043; Amer. Monthly Micr. Jour., 1888, p. 103; 1890, p. 94; Jour. Roy. Micr. Soc., 1881, p. 819, 1882, p. 402, 1883, pp. 283, 560, 1884, p. 115, 1886, p. 516, 1888, pp. 113, 809, 798; Zeit. wiss. Mikroskopie, 1884, pp. 1-21, 1889, p. 367, 1893, pp. 289-295. Here is described an excellent apparatus made by Winkel. Greenman Anat. Record No. 7, 1907, pp. 170-178. Gage, Origin and Development of the Projection Microscope. Transactions of the Amer. Micr. Soc., Vol. XXVIII, 1906. Consult also the latest catalogs of the opticians.

CHAPTER VI

MICRO-SPECTROSCOPE AND POLARISCOPE, MICRO-CHEMISTRY, MICRO-METALLOGRAPHY, TEXTILE FIBERS

APPARATUS AND MATERIAL REQUIRED FOR THIS CHAPTER

Compound microscope; Micro-spectroscope (§ 210); Watch-glasses and shell vials, slides and covers (§ 229); Various substances for examination (as blood and ammonium sulphide, permanganate of potash, chlorophyll, some colored fruit, etc., (§ 230-239), Micro-polarizer (§ 240); Selenite plate (§ 250); Various doubly refracting objects, as crystals, textile fibers, starch, section of bone; Various chemicals, metals, etc.

MICRO-SPECTROSCOPE

§ 210. A Micro-Spectroscope, Spectroscopic or Spectral Ocular, is a direct vision spectroscope in connection with a microscope ocular. The one devised by Abbe and made by Zeiss consists of a direct vision spectroscope prism of the Amici pattern, and of considerable dispersion, placed over the ocular of the microscope. This direct vision or Amici prism consists of a single triangular prism of heavy flint glass in the middle and one of crown glass on each side, the edge of the crown glass prisms pointing toward the base of the flint glass prism, *i. e.*, the edge of the crown and flint glass prisms point in opposite directions. The flint glass prism serves to give the dispersion or separation into colors, while the crown glass prisms serve to make the emergent rays approximately parallel with the incident rays, so that one looks directly into the prism along the axis of the microscope.

The Amici prism is in a special tube which is hinged to the ocular and held in position by a spring. It may be swung free of the ocular. In connection with the ocular is the slit mechanism and a prism for reflecting horizontal rays vertically for the purpose of obtaining a comparison spectrum (§ 223). Finally near the top is a lateral tube with mirror for the purpose of projecting an Angström scale of wave lengths upon the spectrum (§ 224, Fig. 134-135).

§ 211. Apparent Reversal of the Position of the Colors in a Direct Vision Spectroscope.—In accordance with the statements in § 210 the dispersion or separation into colors is given by the flint glass prism or prisms and in ac-

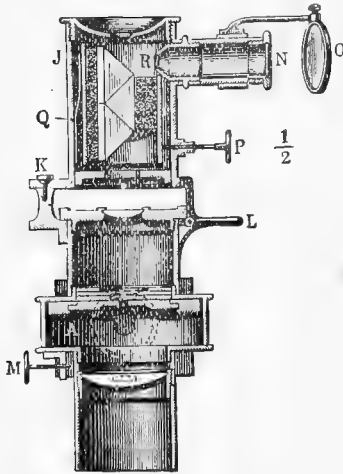

FIG. 134
Longitudinal Section of
the whole instrument.
($\frac{1}{2}$ Full size.)

Abbe's Micro-spectroscope.

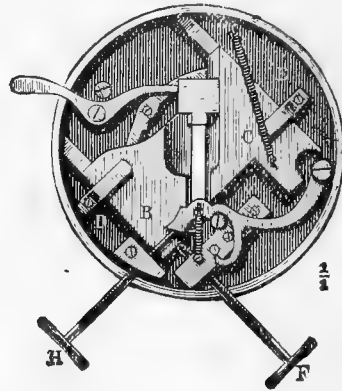

FIG. 135.
Slit Mechanism separately.
(Plan view, Full size.)

"The eye lens is adjustable so as to accurately focus on the slit situated between the lenses. The mechanism for contracting and expanding the slit is actuated by the screw *F* and causes the laminae to move symmetrically (Merz's movement). The slit may be made sufficiently wide so as to include the whole visual field. The slit may be made sufficiently wide so as to include the whole visual field. The screw *H* serves to limit the length of the slit so as to completely fill the latter with the image of the object under investigation when the comparison prism is inserted. The comparison prism is provided with a lateral frame and clips to hold the object and the illuminating mirror. All these parts are encased in a drum on the ocular."

"Above the eye-piece is placed an Amici prism of great dispersion which may be turned aside about the pivot *K*, so as to allow of the adjustment of the object. The prism is retained in its axial position by the spring catch *L*. A scale is projected on the spectrum by means of a scale tube and mirror attached to the prism casing. The divisions of the scale indicate in decimals of a micron the wave length of the respective section of the spectrum. The screw *P* serves to adjust the scale relative to the spectrum."

"The instrument is inserted in the tube in place of the ordinary eye-piece and is clamped to the former by means of the screw *M* in such a position that the mirrors *A* and *O*, which respectively serve to illuminate the comparison prism and the scale of wave lengths are simultaneously illuminated." (From Zeiss' Catalog.)

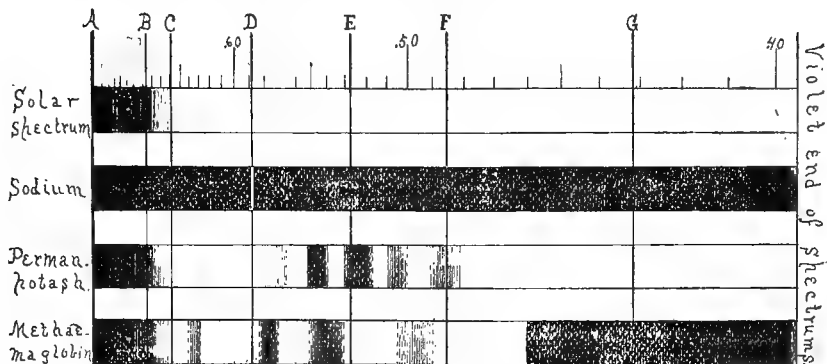

FIG. 136. *Various Spectra.*—All except that of sodium were obtained by diffused day-light with the slit of such a width as gave the most distinct Fraunhofer lines.

It frequently occurs that with a substance giving several absorption bands (e. g., chlorophyll) the density or thickness of the solution must be varied to show all the different bands clearly.

Solar Spectrum.—With diffused day-light and a narrow slit the spectrum is not visible much beyond the fixed line B. In order to extend the visible spectrum in the red to the line A, one should use direct sunlight and a piece of ruby glass in place of the watch-glass in Fig. 138.

Sodium Spectrum.—The line spectrum (§ 213) of sodium obtained by lighting the microscope with a Bunsen or alcohol flame in which some salt of sodium is glowing. With the micro-spectroscope the sodium line seen in the solar spectrum and with the incandescent sodium appears single, except under very favorable circumstances (§ 214). By using a comparison spectrum of day-light with the sodium spectrum the light and dark D-lines will be seen to be continuous as here shown.

Permanganate of Potash.—This spectrum is characterized by the presence of five absorption bands in the middle of the spectrum and is best shown by using a $\frac{1}{10}$ per cent. solution of permanganate in water in a watch-glass as in Fig. 138.

Met-hemoglobin.—The absorption spectrum of met-hemoglobin is characterized by a considerable darkening of the blue end of the spectrum and of four absorption bands, one in the red near the line C and two between D and E nearly in the place of the two bands of oxy-hemoglobin; finally there is a somewhat faint, wide, band near F. Such a met-hemoglobin spectrum is best obtained by making a solution of blood in water of such a concentration that the two oxy-hemoglobin bands run together (§ 233), and then adding three or four drops of a $\frac{1}{10}$ per cent. aqueous solution of permanganate of potash or a few drops of hydrogen dioxid (H_2O_2). Soon the bright red will change to a brownish color, when it may be examined.

cordance with the general law that the waves of shortest length, blue, etc., will be bent most, the colors have the position indicated in the top of Fig. 138, also above Fig. 134. But if one looks into the direct vision spectroscopy or holds the eye close to the single prism (Fig. 139), the colors will appear reversed as if the red were more bent. The explanation of this is shown in Fig. 139, where it can be readily seen that if the eye is placed at E, close to the prism, the different colored rays appear in the direction from which they reach the eye and consequently are crossed in being projected into the field of vision and the real position is inverted. The same is true in looking into the micro-spectroscope. The actual position of the different colors may be determined by placing some ground glass or some of the lens-paper near the prism and observing with the eye at the distance of distinct vision.*

VARIOUS KINDS OF SPECTRA

By a spectrum is meant the colored bands appearing when the light traverses a dispersing prism or a diffraction grating, or is affected in any way to separate the different wave lengths of light into groups. When daylight or some good artificial light is thus dispersed one gets the appearance so familiar in the rainbow.

§ 212. **Continuous Spectrum.**—In case a good artificial light as the electric light is used the various rainbow or spectral colors merge gradually into one another in passing from end to end of the spectrum. There are no breaks or gaps.

§ 213. **Line Spectrum.**—If a gas is made incandescent, the spectrum it produces consists, not of the various rainbow colors, but of sharp, narrow, bright lines, the color depending on the substance. All the rest of the spectrum is dark. These line spectra are very strikingly shown by various metals heated to incandescence.

§ 214. **Absorption Spectrum.**—By this is meant a spectrum in which there are dark lines or bands in the spectrum. The most striking and interesting of the absorption spectra is the *Solar Spectrum*, or spectrum of sunlight. If this is examined by a good spectroscopy it will be found to be crossed by dark lines, the appearance being as if one were to draw pen marks across a continuous spectrum at various levels, sometimes apparently between the colors and sometimes in the midst of a color. These dark lines are the so-called Fraunhofer Lines. Some of the principal ones have been lettered with Roman capitals, A, B, C, D, E, F, G, H, commencing at the red end. The meaning of these lines was for a long time enigmatical, but it is now known that they correspond with the bright lines of a line spectrum (§ 213). For example, if sodium is put in the flame of a spirit or Bunsen lamp it will vaporize and become luminous. If this light is examined there will be seen one or two bright yellow bands corresponding in position with D of the solar

*The author wishes to acknowledge the aid rendered by Professor E. L. Nichols in giving the explanation offered in this section.

spectrum (Fig. 136). If now the spirit-lamp flame, colored by the incandescent sodium, is placed in the path of the electric light, and it is examined as before, there will be a continuous spectrum, except for dark lines in place of the bright sodium lines. That is, the comparatively cool yellow light of the spirit lamp cuts off or absorbs the intensely hot yellow light of the electric light; and although the spirit flame sends a yellow light to the spectro-scope it is so faint in comparison with the electric light that the sodium lines appear dark. It is believed that in the sun's atmosphere there are incandescent metal vapors (sodium, iron, etc.), but that they are so cool in comparison with the rays of their wave length in the sun that the cooler light of the incandescent metallic vapors absorb the light of corresponding wave length, and are, like the spirit lamp-flame, unable to make up the loss, and therefore the presence of the dark lines.

§ 215. **Absorption Spectra from Colored Substances.**—While the solar spectrum is an absorption spectrum, the term is more commonly applied to the spectra obtained with light which has passed through or has been reflected from colored objects which are not self-luminous.

It is the special purpose of the micro-spectroscope to investigate the spectra of colored objects which are not self-luminous, *i. e.*, blood and other liquids, various minerals, as monazite, etc. The spectra obtained by examining the light reflected from these colored bodies or transmitted through them, possess, like the solar spectrum dark lines or bands, but the bands are usually much wider and less sharply defined. Their number and position depend on the substance or its constitution (Fig. 137), and their width, in part, upon the thickness of the body. With some colored bodies, no definite bands are present. The spectrum is simply restricted at one or both ends and various of the other colors are considerably lessened in intensity. This is true of many colored fruits.

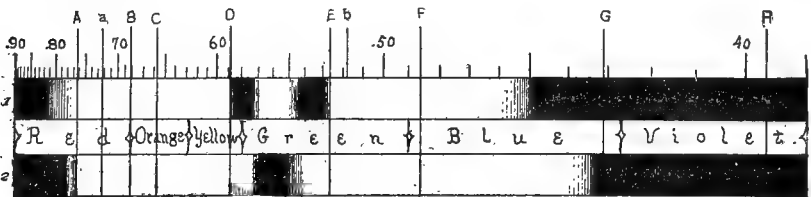

FIG. 137. *Absorption spectrum of Oxy-hemoglobin or arterial blood (1) and of Hemoglobin or venous blood (2). (From Gamgee and McMunn.)*

A, B, C, D, E, F, G, H. Some of the Principal Fraunhofer lines of the solar spectrum (§ 192).

.90, .80, .70, .60, .50, .40. Wave lengths in microns, as shown in Angström's scale (§ 224). It will be seen that the wave lengths increase toward the red and decrease toward the violet end of the spectrum.

Red, Yellow, Orange, etc. Color regions of the spectrum. Indigo should come between the blue and the violet to complete the seven colors usually given. It was omitted through inadvertence.

§ 216. **Angström and Stokes' Law of Absorption Spectra**—The waves of light absorbed by a body when light is transmitted through some of its substance are precisely the waves radiated from it when it becomes self-luminous. For example, a piece of glass that is yellow when cool, gives out blue light when it is hot enough to be self-luminous. Sodium vapor absorbs two bands of yellow light (D lines); but when light is not sent through it, but itself is luminous and examined as a source of light its spectrum gives bright sodium lines, all the rest of the spectrum being dark (Fig. 136).

§ 217. **Law of Color**.—The light reaching the eye from a colored, solid, liquid or gaseous body lighted with white light, will be that due to white light less the light waves that have been absorbed by the colored body. Or in other words, it will be due to the wave lengths of light that finally reach the eye from the object. For example, a thin layer of blood under the microscope will appear yellowish green, but a thick layer will appear pure red. If now these two layers are examined with a micro-spectroscope, the thin layer will show all the colors, but the red end will be slightly, and the blue end considerably restricted, and some of the colors will appear considerably lessened in intensity. Finally there may appear two shadow-like bands, or if the layer is thick enough, two well-defined dark bands in the green (§ 232).

If the thick layer is examined in the same way, the spectrum will show only red with a little orange light, all the rest being absorbed. Thus the spectroscopist shows which colors remain, in part or wholly, and it is the mixture of this remaining or unabsorbed light that gives color to the object.

§ 218. **Complementary Spectra**.—While it is believed that Angström's law (§ 216) is correct, there are many bodies on which it cannot be tested, as they change in chemical or molecular constitution before reaching a sufficiently high temperature to become luminous. There are compounds, however, like those of didymium, erbium and terbium, which do not change with the heat necessary to render them luminous, and with them the incandescence and absorption spectra are mutually complementary, the one presenting bright lines where the other presents dark ones (Daniell).

ADJUSTING THE MICRO-SPECTROSCOPE

§ 219. The micro-spectroscope, or spectroscopic ocular, is put in the place of the ordinary ocular in the microscope, and clamped to the top of the tube by means of a screw for the purpose.

§ 220. **Adjustment of the Slit**.—In place of the ordinary diaphragm with circular opening, the spectral ocular has a diaphragm composed of two movable knife edges by which a slit-like opening of greater or less width and length may be obtained at will by the use of screws for the purpose. To adjust the slit, depress the lever holding the prism-tube in position over the ocular, and

swing the prism aside. One can then look into the ocular. The lateral screw should be used and the knife edges approached till they appear about half a millimeter apart. If now the Amici prism is put back in place and the microscope well lighted, one will see a spectrum by looking into the upper end of the spectroscope. If the slit is too wide, the colors will overlap in the middle of the spectrum and be pure only at the red and blue ends; and the Fraunhofer or other bands in the spectrum will be faint or invisible. Dust on the edges of the slit gives the appearance of longitudinal streaks on the spectrum.

§ 221. **Mutual Arrangement of Slit and Prism.**—In order that the spectrum may appear as if made up of colored bands going directly across the long axis of the spectrum, the slit must be parallel with the refracting edge of the prism. If the slit and prism are not thus mutually arranged, the colored bands will appear oblique, and the whole spectrum may be greatly narrowed. If the colored bands are oblique, grasp the prism tube and slowly rotate it to the right or to the left until the various colored bands extend directly across the spectrum.

§ 222. **Focusing the Slit.**—In order that the lines or bands in the spectrum shall be sharply defined, the eye-lens of the ocular should be accurately focused on the slit. The eye-lens is movable, and when the prism is swung aside it is very easy to focus the slit as one focused for the ocular micrometer (§ 172). If one now uses daylight there will be seen in the spectrum the dark Fraunhofer lines (Fig. 136 E. F., etc.).

To show the necessity of focusing the slit, move the eye-lens down or up as far as possible, and the Fraunhofer lines cannot be seen. While looking into the spectroscope move the ocular lens up or down, and when it is focused the Fraunhofer lines will reappear. As the different colors of the spectrum have different wave lengths, it is necessary to focus the slit for each color if the sharpest possible pictures are desired.

It will be found that the eye-lens of the ocular must be farther from the slit for the sharpest focus of the red end than for the sharpest focus of the lines at the blue end. This is because the wave length of red is markedly greater than for blue light.

Longitudinal dark lines of the spectrum may be due to irregu-

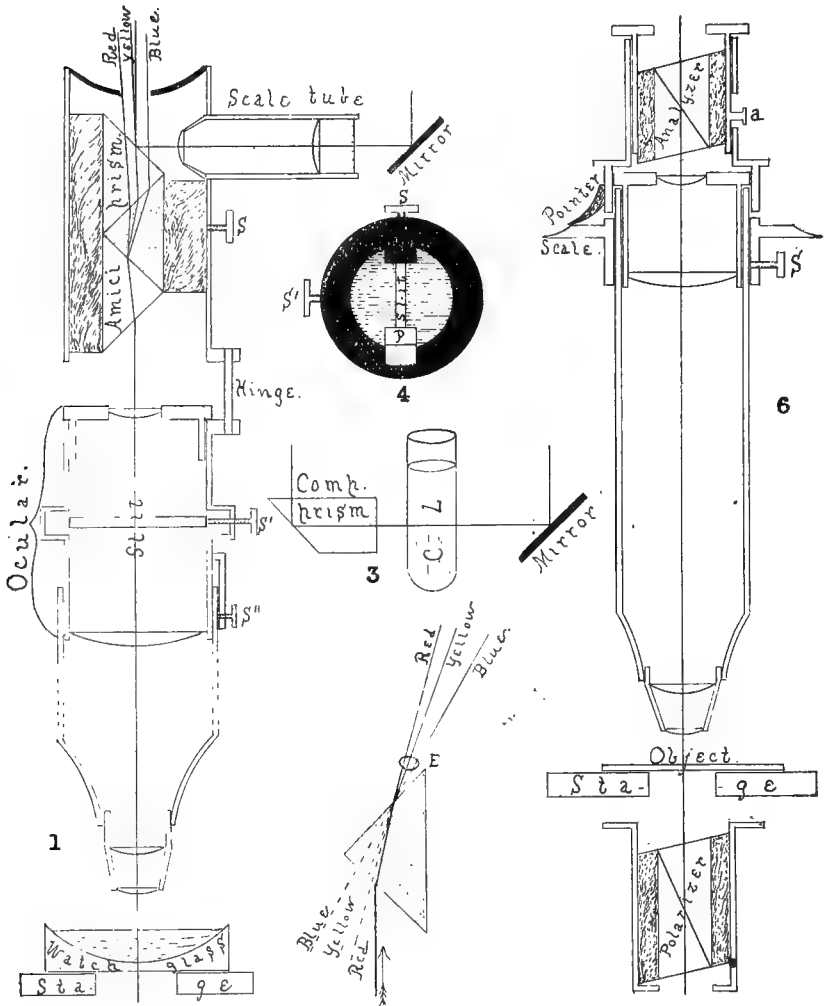

FIG. 138

FIG. 139

FIG. 140

FIG. 138. (I). Section of the tube and stage of the microscope with the spectral ocular or micro-spectroscope in position.

Amici Prism (§ 210).—The direct vision prism of Amici in which the central shaded prism of flint glass gives the dispersion or separation into colors, while the end prisms of crown glass cause the rays to emerge approximately parallel with the axis of the microscope. A single ray is represented as entering the prism and this is divided into three groups (Red, Yellow, Blue), which

emerge from the prism, the red being least and the blue most bent toward the base of the flint prism (see Fig. 139).

Hinge.—The hinge on which the prism tube turns when it is swung off the ocular.

Ocular (§ 210)—The ocular in which the slit mechanism takes the place of the diaphragm (§220). The eye-lens is movable as in a micrometer ocular, so that the slit may be accurately focused for the different colors (§ 222).

S. Screw for setting the scale of wave lengths (§224).

S'. Screw for regulating the width of slit (§220).

S''. Screw for clamping the micro-spectroscope to the tube of the microscope.

Scale Tube.—The tube near the upper end containing the Angström scale and the lenses for projecting the image upon the upper face of the Amici prism, whence it is reflected upward to the eye with the different colored rays. At the right is a special mirror for lighting the scale.

Slit.—The linear opening between the knife edges. Through the slit the light passes to the prism. It must be arranged parallel with the refracting edge of the prism, and of such a width that the Fraunhofer or Fixed Lines are very clearly and sharply defined when the eye-lens is properly focused (§ 220-222).

Stage.—The stage of the microscope. This supports a watch-glass with sloping sides for containing the colored liquid to be examined.

(3) *Comparison Prism with tube for colored liquid (C. L.), and mirror.* The prism reflects horizontal rays vertically, so that when the prism is made to cover part of the slit two parallel spectra may be seen, one from light sent directly through the entire microscope and one from the light reflected upward from the comparison prism.

(4) *View of the slit mechanism from below.*—Slit, the linear space between the knife edges through which the light passes.

P. Comparison prism beneath the slit and covering part of it at will.

S. S'. Screws for regulating the length and width of the slit.

FIG. 139. Flint-Glass Prism showing the separation or dispersion of white light into the three groups of colored rays (Red, Yellow, Blue), the blue rays being bent the most from the refracting edge (§ 211).

FIG. 140. Sectional view of a Microscope with the Polariscope in position (§ 240-242).

Analyzer and Polarizer.—They are represented with corresponding faces parallel so that the polarized beam could traverse freely the analyzer. If either Nicol were rotated 90° they would be crossed and no light would traverse the analyzer unless some polarizing substance were used as object. (a) Slot in the analyzer tube so that the analyzer may be raised or lowered to adjust it for difference of level of the eye point in different oculars (§ 67, 222).

Pointer and Scale.—The pointer attached to the analyzer and the scale or divided circle clamped (by the screw *S*) to the tube of the microscope. The pointer and scale enable one to determine the exact amount of rotation of the analyzer (§ 242).

Object.—The object whose character is to be investigated by polarized light.

larity of the edge of the slit or to the presence of dust. They are most troublesome with a very narrow slit.

§ 223. **Comparison or Double Spectrum.**—In order to compare the spectra of two different substances it is desirable to be able to examine their spectra side by side. This is provided for in the better forms of micro-spectroscopes by a prism just below the slit, so placed that the light entering it from a mirror at the side of the drum shall be totally reflected in a vertical direction, and thus parallel with the rays from the microscope. The two spectra will be side by side with a narrow dark line separating them. If now the slit is well focused and daylight be sent through the microscope and into the side to the reflecting or comparison prism, the colored bands and the Fraunhofer dark lines will appear directly continuous across the two spectra. The prism for the comparison spectrum is movable and may be thrown entirely out of the field if desired. When it is to be used, it is moved about half way across the field so that the two spectra shall have about the same width.

§ 224. **Scale of Wave Lengths.**—In the Abbe micro-spectroscope the scale is in a separate tube near the top of the prism and at right angles to the prism-tube. A special mirror serves to light the scale, which is projected upon the spectrum by a lens in the scale-tube. This scale is of the Angström form, and the wave lengths of any part of the spectrum may be read off directly, after the scale is once set in the proper position, that is, when it is set so that any given wave length on the scale is opposite the part of the spectrum known by previous investigation to have that particular wave length. The point most often selected for setting the scale is opposite the sodium line where the wave length is, according to Angström, 0.5892μ . In adjusting the scale, one may focus very sharply the dark sodium line of the solar spectrum and set the scale so that the number 0.589 is opposite the sodium or D line, or a method that is frequently used and serves to illustrate § 213-214, is to sprinkle some salt of sodium (carbonate of sodium is good) in a Bunsen or alcohol lamp flame and to examine this flame. If this is done in a darkened place with a spectroscope, a narrow bright band will be seen in the yellow part of the spectrum. If now ordinary daylight is sent through the comparison prism, the bright line of the sodium will be seen to be directly continuous with the dark line

at D in the solar spectrum (Fig. 136). By reflecting light into the scale-tube the image of the scale will appear on the spectrum, and by a screw just under the scale-tube but within the prism-tube, the proper point on the scale (0.589μ) can be brought opposite the sodium band. All the scale will then give the wave lengths directly. Sometimes the scale is oblique to the spectrum. This may be remedied by turning the prism-tube slightly one way or the other. It may be due to the wrong position of the scale itself. If so, grasp the milled ring at the distal end of the scale-tube and, while looking into the spectroscope, rotate the tube until the lines of the scale are parallel with the Fraunhofer lines. It is necessary in adjusting the scale to be sure that the larger number, 0.70, is at the red end of the spectrum.

The numbers on the scale should be very clearly defined. If they do not so appear, the scale-tube must be focused by gasping the outer tube of the scale-tube and moving it toward or from the prism-tube until the scale is distinct. In focusing the scale, grasp the outer scale-tube with one hand and the prism-tube with the other, and push or pull in opposite directions. In this way one will be less liable to injure the spectroscope.

§ 225. **Designation of Wave Length.**—Wave lengths of light are designated by the Greek letter λ , followed by the number indicating the wave length in some fraction of a meter. With the Abbe microspectroscope the micron is taken as the unit as with other microscopical measurements (§ 182). Various units are in use, as the one hundred thousandth of a millimeter, millionths or ten millionths of a millimeter. If these smaller units are taken, the wave lengths will be indicated either as a decimal fraction of a millimeter or as whole numbers. Thus, according to Angström, the wave length of sodium light is 5892 tenth meters or Angström units, or 5892 ten millionths mm., or 589.2 millionths, or 58.92 one hundred thousandths, or 0.5892 one thousandth mm., or 0.5892 μ . The last would be indicated thus, $\lambda D=0.5892\mu$.

§ 226 **Lighting for the Micro-spectroscope.**—For opaque objects a strong light should be thrown on them either with a concave mirror or condensing lens. For transparent objects the amount of the substance and the depth of color must be considered. As a general rule it is well to use plenty of light, as that from an Abbe

illuminator with a large opening in the diaphragm or with the diaphragm entirely open. For very small objects and thin layers of liquids it may be better to use less light. One must try both methods in a given case, and learn by experience.

The direct and the comparison spectra should be about equally illuminated. One can manage this by putting the object requiring the greater amount of illumination on the stage of the microscope and lighting it with the Abbe illuminator. In lighting it is found in general that for red or yellow objects, lamp-light gives very satisfactory results. For the examination of blood and blood crystals the light from a petroleum lamp is excellent. For objects with much blue or violet, daylight or artificial light rich in blue light is best.

Furthermore, one should be on his guard against confusing the ordinary absorption bands with the Fraunhofer lines when daylight is used. With lamp-light the Fraunhofer lines are absent and, therefore, not a source of possible confusion.

§ 227. **Objective to Use with the Micro-spectroscope.**—

If the material is of considerable bulk, a low objective (16 to 50 mm.) is to be preferred. This depends on the nature of the object under examination, however. In case of individual crystals one should use sufficient magnification to make the real image of the crystal entirely fill the width of the slit. The length of the slit may then be regulated by the screw on the side of the drum, and also by the comparison prism. If the object does not fill the whole slit the white light entering the spectroscope with the light from the object might obscure the absorption bands. For opaque objects illuminating objectives are useful (Fig. 143, 144).

In using high objectives with the micro-spectroscope one must very carefully regulate the light (Ch. II) and sometimes shade the object.

§ 228. **Focusing the Objective.**—For focusing the objective the prism-tube is swung aside, and then the slit made wide by turning the adjusting screw at the side. If the slit is open one can see objects when the microscope is focused as with an ordinary ocular (§ 220). After an object is focused, it may be put exactly in position to fill the slit of the spectroscope, then the knife edges are brought together till the slit is of the right width ; if the slit is then

too long it may be shortened by using one of the mechanism screws on the side, or if that is not sufficient, by bringing the comparison prism farther over the field. If one now replaces the Amici prism and looks into the microscope, the spectrum is liable to have longitudinal shimmering lines. To get rid of these focus up or down a little so that the microscope will be slightly out of focus.

§ 229. **Amount of Material Necessary for Absorption Spectra and its Proper Manipulation.**—The amount of material necessary to give an absorption spectrum varies greatly with different substances, and can be determined only by trial. If a transparent solid is under investigation it is well to have it in the form of a wedge, then successive thicknesses can be brought under the microscope. If a liquid substance is being examined, a watch glass with sloping sides forms an excellent vessel to contain it, then successive thicknesses of the liquid can be brought into the field as with the wedge-shaped solid. Frequently only a very weak solution is obtainable; in this case it can be placed in a homœopathic vial, or in some glass tubing sealed at the end, then one can look lengthwise through the liquid and get the effect of a more concentrated solution. For minute bodies like crystals or blood corpuscles, one may proceed as described in the previous section.

MICRO-SPECTROSCOPE—EXPERIMENTS*

§ 230. Put the micro-spectroscope in position, arrange the slit and the Amici prism so that the spectrum will show the various spectral colors going directly across it (§ 220, 221) and focus the slit. This may be done either by swinging the prism-tube aside and proceeding as for the ocular micrometer (§ 188), or by moving the eye-lens of the ocular up and down while looking into the micro-spectroscope until the dark lines of the solar spectrum are distinct. If they cannot be made distinct by focusing the slit, then the light is too feeble or the slit is too wide (§ 220). With the lever move the comparison prism across half the field so that the two spectra shall be of about equal width. For lighting, see § 226.

*If one does not possess a micro-spectroscope, quite satisfactory results may be obtained by using a microscope with a 16 to 12 mm. objective and a pocket, direct vision spectroscope in place of the eye-piece. (Bleile, *Trans. Amer. Micr. Soc.* 1900, p. 8).

§ 231. **Absorption Spectrum of Permanganate of Potash.**—Make a solution of permanganate of potash in water of such a strength that a stratum 3 or 4 mm. thick is transparent. Put this solution in a watch-glass with sloping sides, and put it under the microscope. Use a 50 mm. or 16 mm. objective, and the full opening of the illuminator. Light strongly. Look into the spectroscope and slowly move the watch-glass into the field. Note carefully the appearance with the thin stratum of liquid at the edge and then as it gradually thickens on moving the watch-glass still farther along. Count the absorption bands and note particularly the red and blue ends. Compare carefully with the comparison spectrum (Figs. 136, 137). For strength of solution see § 229.

§ 232. **Absorption Spectrum of Blood.**—Obtain blood from a recently killed animal, or flame a needle, and after it is cool prick the finger two or three times in a small area, then wind a handkerchief or a rubber tube around the base of the finger, and squeeze the finger with the other hand. Some blood will ooze out of the pricks. Rinse this off into a watch-glass partly filled with water. Continue to add the blood until the water is quite red. Place the watch-glass of diluted blood under the microscope in place of the permanganate, using the same objective, etc. Note carefully the spectrum. It would be advantageous to determine the wave length opposite the center of the dark bands. This may easily be done by setting the scale properly as described in § 224. Make another preparation, but use a homeopathic vial instead of a watch-glass. Cork the vial and lay it down upon the stage of the microscope. Observe the spectrum. It will be like that in the watch-glass. Remove the cork and look through the whole length of the vial. The bands will be much darker, and if the solution is thick enough only red and a little orange will appear. Re-insert the cork and incline the vial so that the light traverses a very thin layer, then gradually elevate the vial and the effect of a thicker and thicker layer may be seen. Note especially that the two characteristic bands unite and form one wide band as the stratum of liquid thickens. Compare with the following :

Add to the vial of diluted blood a drop or two of ammonium sulphide, such as is used for a reducing agent in chemical laboratories. Shake the bottle gently and then allow it to stand for ten or fifteen minutes. Examine it and the two bands will have been

replaced by a single, less clearly defined band in about the same position. The blood will also appear somewhat purple. Remove the cork to admit fresh air then shake the vial vigorously and the color will change to the bright red of fresh blood. Examine it again with the spectroscope and the two bands will be visible. After five or ten minutes another examination will show but a single band. Incline the bottle so that a thin stratum may be examined. Note that the stratum of liquid must be considerably thicker to show the absorption band than was necessary to show the two bands in the first experiment. Furthermore, while the single band may be made quite black on thickening the stratum, it will not separate into two bands with a thinner stratum. In this experiment it is very instructive to have the watch-glass of arterial blood under the microscope and the vial of blood to which has been added the ammonium sulphide in position for a comparison spectrum.

The two banded spectrum is that of *oxy-hemoglobin*, or arterial blood, the single banded spectrum of *hemoglobin* (sometimes called reduced hemoglobin) or venous blood, that is, the respiratory oxygen is present in the two banded spectrum but absent from the single banded spectrum. When the bottle was shaken the hemoglobin took up oxygen from the air and became oxy-hemoglobin, as occurs in the lungs, but soon the ammonium sulphide took away the respiratory oxygen, thus reducing the oxy-hemoglobin to hemoglobin. This may be repeated many times (Fig. 137).

§ 233. **Met-Hemoglobin.**—The absorption spectrum of met-hemoglobin is characterized by a considerable darkening of the blue end of the spectrum and of four absorption bands, one in the red near the line C and two between D and E, nearly in the place of the two bands of oxy-hemoglobin; finally there is a somewhat faint, wide band near F. Such a met-hemoglobin spectrum is best obtained by making a solution of blood in water of such a concentration that the two oxy-hemoglobin bands run together, and then adding three or four drops of a $\frac{1}{10}$ per cent aqueous solution of permanganate of potash. Soon the bright red will change to a brownish color, when it may be examined (Fig. 136). Instead of the permanganate one may use hydrogen dioxide (H_2O_2).

§ 234. **Carbon Monoxide Hemoglobin (CO-Hemoglobin).**—

To obtain this, kill an animal in illuminating gas, or one may allow illuminating gas to bubble through some blood already taken from the body. The gas should bubble through a minute or two. The oxygen will be displaced by carbon monoxide. This forms quite a stable compound with hemoglobin, and is of a bright cherry-red color. Its spectrum is nearly like that of oxy-hemoglobin, but the bands are farther toward the blue. Add several drops of ammonium sulphide and allow the blood to stand some time. No reduction will take place, thus forming a marked contrast to solutions of oxy-hemoglobin. By the addition of a few drops of glacial acetic acid a dark brownish red color is produced.

§ 235. **Carmine Solution.**—Make a solution of carmine by putting $\frac{1}{10}$ gram of carmine in 100 cc. of water and adding 10 drops of strong ammonia. Put some of this in a watch-glass or in a small vial and compare the spectrum with that of oxy-hemoglobin or carbon monoxide hemoglobin. It has two bands in nearly the same position, thus giving the spectrum a striking similarity to blood. If now several drops, 15 or 20, of glacial acetic acid are added to the carmine, the bands remain and the color is not markedly changed, while with either oxy-hemoglobin or CO-hemoglobin the color is decidedly changed from the bright red to a dull reddish brown, and the spectrum, if any can be seen, is markedly different. Carmine and O-hemoglobin can be distinguished by the use of ammonium sulphide, the carmine remaining practically unchanged while the blood shows the single band of hemoglobin (§ 232). The acetic acid serves to differentiate the CO-hemoglobin as well as the O-hemoglobin.

§ 236. **Colored Bodies not giving Distinctly Banded Absorption Spectra.**—Some quite brilliantly colored objects, like the skin of a red apple, do not give a banded spectrum. Take the skin of a red apple, mount it on a slide, put on a cover-glass and add a drop of water at the edge of the cover. Put the preparation under the microscope and observe the spectrum. Although no bands will appear, in some cases at least, yet the ends of the spectrum will be restricted and various regions of the spectrum will not be so bright as the comparison spectrum. Here the red color arises from the mixture of the unabsorbed waves, as occurs with other colored objects. In this case, however, not all the light of a given wave length is absorbed, consequently there are no clearly defined dark

bands, the light is simply less brilliant in certain regions and the red rays so predominate that they give the prevailing color.

§ 237. **Nearly Colorless Bodies with Clearly Marked Absorption Spectra.**—In contradistinction to the brightly colored objects with no distinct absorption bands are those nearly colorless bodies and solutions which give as sharply defined absorption bands as could be desired. The best examples of this are afforded by solutions of the rare earths, didymium, etc. These in solutions that give hardly a trace of color to the eye give absorption bands that almost rival the Fraunhofer lines in sharpness.

§ 238. **Absorption Spectra of Minerals.**—As example take some monazite sand on a slide and either mount it in balsam (see Ch. IX), or cover and add a drop of water. The examination may be made also with the dry sand, but it is less satisfactory. Light well with transmitted light, and move the preparation slowly around. Absorption bands will appear occasionally. Swing the prism tube off the ocular, open the slit and focus the sand. Get the image of one or more grains directly in the slit, then narrow and shorten the slit so that no light can reach the spectroscope that has not traversed the grain of sand. The spectrum will be satisfactory under such conditions. It is frequently of great service in determining the character of unknown mineral sands to compare the spectra with known minerals. If the absorption bands are identical, it is strong evidence in favor of the identity of the minerals. For proper lighting see § 226.

§ 239. While the study of absorption spectra gives one a great deal of accurate information, great caution must be exercised in drawing conclusions as to the identity or even the close relationship of bodies giving approximately the same absorption spectra. The rule followed by the best workers is to have a known body as control and to treat the unknown body and known body with the same reagents, and to dissolve them in the same medium. If all the reactions are identical then the presumption is strong that the bodies are identical or very closely related. For example, while one might be in doubt between a solution of oxy- or CO-hemoglobin and carmine, the addition of ammonium sulphide serves to change the double to a single band in the O-hemoglobin, and glacial acetic acid enables one to distinguish between the CO-blood and the car-

mine, although the ammonium sulphide would not enable one to make the distinction. Furthermore it is unsafe to compare objects dissolved in different media. Different objects as "cyanine and aniline blue dissolved in alcohol give a very similar spectrum, but in water a totally different one." "Totally different bodies show absorption bands in exactly the same position (solid nitrate of uranium and permanganate of potash in the blue)." (MacMunn). The rule given by MacMunn is a good one: "The recognition of a body becomes more certain if its spectrum consists of several absorption bands, but even the coincidence of these bands with those of another body is not sufficient to enable us to infer chemical identity; what enables us to do so with certainty is the fact: *that the two solutions give bands of equal intensities in the same parts of the spectrum which undergo analogous changes on the addition of the same reagent.*"

REFERENCES TO THE MICRO-SPECTROSCOPE AND

SPECTRUM ANALYSIS

The micro-spectroscope is playing an ever-increasingly important role in the spectrum analysis of animal and vegetable pigments, and of colored mineral and chemical substances, therefore a somewhat extended reference to literature is given. Full titles of the books and periodicals will be found in the Bibliography at the end.

Angström, Recherches sur le spectre solaire, etc. Also various papers in periodicals. See Royal Soc's Cat'l Scientific Papers; Anthony & Brackett; Beale, p. 269; Behrens, p. 139; Kossel und Schiefferdecker, p. 63; Carpenter, p. 323; Browning, How to Work with the Spectroscope, and in Monthly Micr. Jour., II, p. 65; Daniell, Principles of Physics. The general principles of spectrum analysis are especially well stated in this work, pp. 435-455; Davis, p. 342; Dippel, p. 277; Frey; Gamgee, p. 91; Halliburton; Hogg, p. 122; also in Monthly Micr. Jour., Vol. II, on colors of flowers; Jour. Roy. Micr. Soc., 1880, 1883, and in various other vols.; Kraus; Lockyer; M'Kendrick; MacMunn; and also in Philos. Trans. R. S., 1886; various vols. of Jour. Physiol.; Nägeli und Schwendener; Proctor; Ref. Hand-Book Med. Science, Vol. I, p. 577, VI, p. 516, VII, p. 426; Roscoe; Schellen; Sorby, in Beale, p. 269; also Proc. R. S., 1874, p. 31, 1867, p. 433; see also in the Scientific Review, Vol. V, p. 66, Vol. II, p. 419; Landauer, Spectrum Analysis. The larger works on Physiology, Chemistry and Physics may also be consulted with profit.

Vogel, Spectrum analysis; also in Nature, Vol. xix, p. 495, on absorption spectra. The bibliography in MacMunn is excellent and extended.

For hemochromogen in medico-legal cases see Bleile, Trans. Amer. Micr. Soc., 1900, p. 9.

MICRO-POLARISCOPE

§ 240. The micro-polariscope, or polarizer, is a polariscope used in connection with a microscope.

The most common and typical form consists of two Nicol prisms, that is, two somewhat elongated rhombs of Iceland spar cut diagonally and cemented together with Canada balsam. These Nicol prisms are then mounted in such a way that the light passes through them lengthwise, and in passing is divided into two rays of plane polarized light. The one of these rays obeying the ordinary law of refraction is called the *ordinary ray*, the one departing from the law is called the *extra-ordinary ray*. These two rays are polarized in planes at right angles to each other. The Nicol prism totally reflects the ordinary ray at the cemented surface as it meets that surface at an angle greater than the critical angle, and only the less refracted extraordinary ray is transmitted.

§ 241. *Polarizer and Analyzer.*—The polarizer is one of the Nicol prisms. It is placed beneath the object and in this way the object is illuminated with polarized light. The analyzer is the other Nicol and is placed at some level above the object, very conveniently above the ocular.

When the corresponding faces of the polarizer and analyzer are parallel *i. e.*, when the faces through which the oblique section passes are parallel, light passes freely through the analyzer to the eye. If these corresponding faces are at right angles, that is, if the Nicols are crossed, then the light is entirely cut off and the two transparent prisms become opaque to ordinary light. There are then, in the complete revolution of the analyzer, two points at 0° and 180° , where the corresponding faces are parallel and where light freely traverses the analyzer. There are also two crossing points of the Nicols, at 90° and 270° , where the light is extinguished. In the intermediate points there is a sort of twilight.

§ 242. *Putting the Polarizer and Analyzer in Position.*—Swing the diaphragm carrier of the Abbe illuminator out from under the illuminator, remove the disk diaphragm or open widely the iris diaphragm and place the analyzer in the diaphragm carrier, then swing it back under the illuminator. Remove the ocular, put the graduated ring on the top of the tube and then replace the ocular and put the analyzer over the ocular and ring. Arrange the graduated ring so that the indicator shall stand at 0° when the field is lightest. This may be done by turning the tube down so that the objective is near the illuminator, then shading the stage so that none but polarized light shall enter the microscope. Rotate the analyzer until the lightest possible point is found, then rotate the graduated ring till the index stands at 0° . The ring may then be clamped to the tube by the side screw for the purpose. Or, more easily, one may set the index at 0° , clamp the ring to the microscope, then rotate the draw-tube of the microscope till the field is lightest.

§ 243. *Adjustment of the Analyzer.*—The analyzer should be capable of moving up and down on its mounting, so that it can be adjusted to the eye-

point of the ocular with which it is used. If on looking into the analyzer with parallel Nicols the edge of the field is not sharp, or if it is colored, the analyzer is not in proper position with reference to the eye point, and should be raised or lowered till the edge of the field is perfectly sharp and as free from color as the ocular itself is when the analyzer is removed.

§ 244. Objectives to Use with the Polariscope.—Objectives of all powers may be used, including the homogenous immersion. In general, however, the lower powers are somewhat more satisfactory. A good rule to follow in this case is the general rule in all microscopic work,—*use the power that most clearly and satisfactorily shows the object under investigation.*

§ 245. Lighting for Micro-Polariscope Work.—Follow the general directions given in Chapter II. It is especially necessary to shade the object so that no unpolarized light can enter the objective, otherwise the field cannot be sufficiently darkened. No diaphragm is used over the polarizer for most examinations. Direct sunlight may be used to advantage with some objects, and the object should be as transparent as possible.

§ 246. Mounting Objects for the Polariscope.—So far as possible objects should be mounted in balsam to render them transparent. In many cases objects mounted in water do not give satisfactory appearances with the polariscope. For example, if starch is mounted dry in water, the appearances are not so striking as if mounted in balsam (Davis; p. 337; Suffolk).

§ 247. Purpose of a Micro-Polariscope.—(A) To determine whether a microscopic object is singly or doubly refractive. i. e. isotropic or anisotropic. (B) To determine whether or not a body shows pleochroism. (C) To show whether an object rotates the plane of polarization, as with sugar. (D) To give beautiful colors.

For petrological and mineralogical investigations the microscope should possess a graduated, rotating stage so that the object can be rotated, and the exact angle of rotation determined. It is also found of advantage in investigating objects with polarized light where colors appear, to combine a polariscope and spectroscope (Spectro-Polariscope).

MICRO-POLARISCOPE—EXPERIMENTS

§ 248. Arrange the polarizer and analyzer as directed above (§ 242) and use a 16 mm. objective except when otherwise directed.

(A) **Isotropic or Singly Refracting Objects.**—Light the microscope well and cross the Nicols, shade the stage and make the field as dark as possible (§ 241). For an isotropic substance, put an ordinary glass slide under the microscope. The field will remain dark. As an example of crystals belonging to the cubical system and hence isotropic, make a strong solution of common salt (sodium chlorid) put a drop on a slide and allow it to crystallize,

put it under the microscope, remove the analyzer, focus the crystals and then replace the analyzer and cross the Nicols. The field and the crystals will remain dark.

(B) **Anisotropic or Doubly Refracting Objects.**—Make a fresh preparation of carbonate of lime crystals like that described for pedesis (§ 164), or use a preparation in which the crystals have dried to the slide, use a 5 or 3 mm. objective, shade the object well, remove the analyzer and focus the crystals, then replace the analyzer. Cross the Nicols. In the dark field will be seen multitudes of shining crystals, and if the preparation is a fresh one in water, part of the smaller crystals will alternately flash and disappear. By observing carefully, some of the larger crystals will be found to remain dark with crossed Nicols, others will shine continuously. If the crystals are in such a position that the light passes through them parallel with the optic axis,* the crystals are isotropic like salt crystals and remain dark. If, however, the light traverses them in any other direction the ray from the polarizer is divided into two constituents vibrating in planes at right angles to each other, and one of these will traverse the analyzer, hence such crystals will appear as if self-luminous in a dark field. The experiment with these crystals from the frog succeeds well with a 2 mm. homogeneous immersion.

As a further illustration of anisotropic objects, mount some cotton fibers in balsam (Ch. IX), also some of the lens paper (§ 125). These furnish excellent examples of vegetable fibers; Striated muscle fibers are also very well adapted for polarizing objects.

(C) *Pleochroism.*—This is the exhibition of different tints as the analyzer is rotated. An excellent subject for this will be found in blood crystals.

§ 249. **Starch.**—One of the important uses of a polariscope is for the study of starch. Starch gives a characteristic black cross which rotates as the analyzer is rotated. Make a thin slice of fresh raw

*The optic axis of doubly refracting crystals is the axis along which the crystal is not doubly refracting, but isotropic like glass. When there is but one such axis, the crystal is said to be uniaxial, if there are two such axes the crystal is said to be bi-axial.

The crystals of carbonate of lime from the frog (see § 164) are uniaxial crystals. Borax crystals are bi-axial.

potato with a razor or other sharp knife and mount it in water. Use first a 16 mm. and then a higher power. The starch grains many of them will be found in the potato cells. They have the general appearance of a clam shell. The black cross is strikingly exhibited by the polariscope. Starch grains of other plants show the same, but the grains are smaller generally and therefore do not bring out the structural features so clearly.

§ 250. **Production of Colors.**—For the production of gorgeous colors, a selenite plate is placed anywhere between the polarizer and the analyzer. If properly mounted the selenite is very conveniently placed on the diaphragm carrier of the Abbe illuminator, just above the polarizer; an unmounted selenite may be placed over the ocular. A thin plate or film of mica also answers well.

It is not necessary to use selenite or mica for the production of vivid colors in many objects. One of the most beautiful preparations, and one of the most instructive also, may be prepared as follows: Heat some xylene balsam on a slide until the xylene is nearly evaporated. Add some crystals of the medicine, sulphonal and warm till the sulphonal is melted and mixes with the balsam. While the balsam is still melted put on a cover-glass. If one gets perfect crystals there will be shown beautiful colors and the black cross. (Clark.)

It is very instructive and interesting to examine many organic and inorganic substances with a micro polarizer.

REFERENCES TO THE POLARISCOPE AND TO THE USE OF POLARIZED LIGHT

Anthony & Brackett, 133; Behrens; Behrens, Kossel und Schiefferdecker; Carnoy, 61; Carpenter-Dallinger, 317, 1097; Clark; Daniel, 494; Davis; v. Ebener, Gamgee; Halliburton, 36, 272; Hogg, 133, 729; Lehmann; M'Kendrick; Nägeli und Schwendener, 299; Quekett; Suffolk, 125; Valentin; Physical Review, I., p. 127. Daniell, Physics for Medical Students. Nichols, Physics.

MICRO-CHEMISTRY

§ 251. During the last decade the microscope has become one of the necessities of the expert chemist, and the signs of the times

indicate that in every research laboratory of chemistry the microscope will become as familiar as it now is in research laboratories of biology. Its proper place in chemistry has been admirably stated by Chamot:

“It is rather remarkable how slow American chemists have been in realizing the importance of the microscope as an adjunct to every chemical laboratory. This is, perhaps, largely due to the fact that few of our students in chemistry become familiar with the construction and manipulation of this instrument, just as few of them become sufficiently familiar with the spectroscope and its manifold uses; and doubtless also because of the prevailing impression that a microscope is primarily an instrument for the biologist and is of necessity a most expensive luxury. The fact is, however, that this instrument is now far from being a luxury to the chemist, and the time is not far distant when it will be conceded to be as much a necessity in every analytical laboratory as is the balance.

“Nor is the apprenticeship to its use in chemical work long or intricate.

“Micro-chemical analysis should appeal to every chemist because of its neatness, wonderful delicacy, in which it is not excelled even by the spectroscope, and the expedition with which an analysis can be made. A complete analysis, intricate though it may be, is a matter of a few minutes rather than of a few hours.

“While there is no good reason to believe, as do some enthusiasts, that this new system is to displace the old analysis in the wet way, every chemist should, nevertheless, familiarize himself with the microscope, its accessories, and the elegant and time-saving methods of micro-analysis, thus enabling him to examine qualitatively the most minute amounts of material with a rapidity and accuracy which is truly marvelous; not to speak of the many substances for which no other method of identification is known.

“At present the greatest bar to its general use is the absence of any well defined scheme, and the absolute necessity of being well grounded in general chemistry. There are no tables which can be followed in a mechanical way by the student, but on the contrary he is obliged to exercise his knowledge and judgment at every step. For this very reason the introduction of this subject into the list of those now taught is greatly to be desired.”

The microscope is used by the chemist to follow reactions in minute quantities of material. This is done by examining the crystals which separate on the addition of a drop of reagent to a drop of solution containing the unknown substance.

§ 252. **Experiment.**—To a drop of distilled water on the corner of a slide add a piece of calcium chlorid about half a millimeter in diameter. When it is dissolved place a minute drop of dilute sulphuric acid (about 10%) near the drop of solution. With

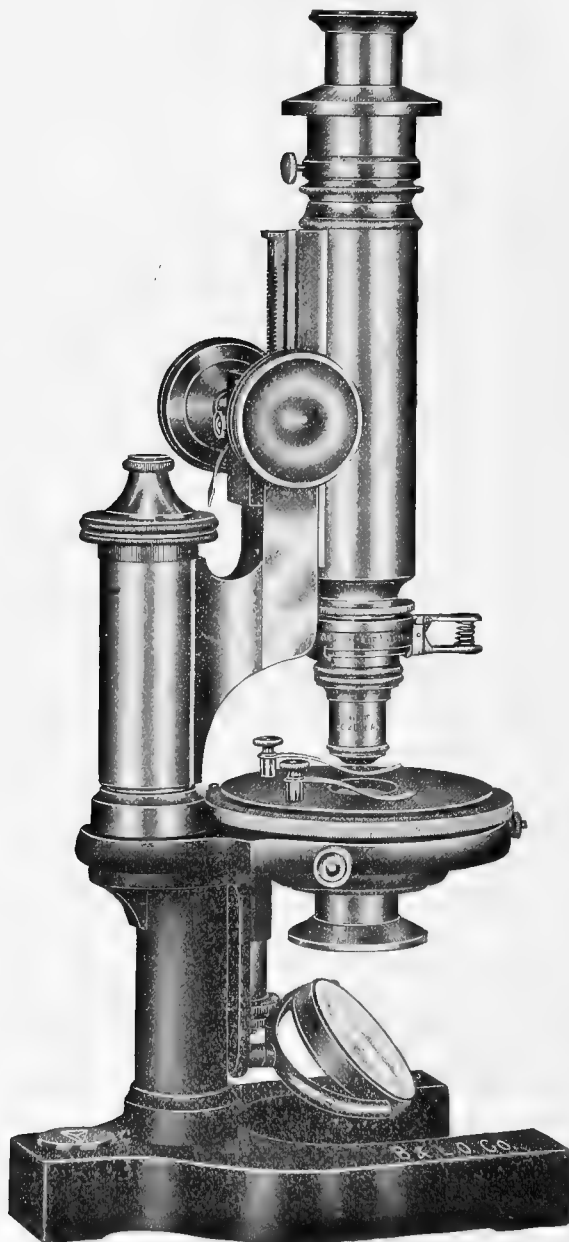

Fig. 140. Chamot Chemical Microscope (Bausch & Lomb Opt. Co.).

a fine glass rod push the two drops together. Shortly bundles of needle-like crystals of $\text{CaSO}_4 \cdot 2\text{H}_2\text{O}$ will appear. This is characteristic of calcium.

Lead nitrate, strontium or barium chloride treated in the same way will yield fine amorphous precipitates. The lead sulphate will, however, slowly recrystallize in characteristic forms.

For this examination a 16 mm. objective and low ocular should be employed. No cover glass is used.

§ 253. **Slides for Microchemistry and their Preparation.**—These are the regular 1×3 in. slides cut in half. The work is done on one corner to avoid breaking when the slide is heated. It is very important to have the slides clean. The slides are prepared by leaving them over night in cleaning mixture (Ch IX), and then rinsing very thoroughly in distilled water. The slides are then left in distilled water until ready for use. They are then wiped with a clean glass-towel or with a double thickness of gauze. During the whole process the end of the slide to be used must not be touched by the fingers. A drop of water placed on the slide should flatten out and flow evenly over the surface. If it heaps up in a round mass the slide is not clean.

§ 254. The Micro-chemist should be familiar with the appearance of the different crystal forms under the microscope. He should be especially familiar with the appearance of crystals of the chlorids, nitrates, and sulfates of Sodium, Potassium, and ammonium; since some of these salts are sure to appear in almost every test drop examined. The following list of substances have been suggested by Dr. Chamot as giving definite and easily obtained results. To obtain good crystals dissolve a fragment of the substance in a small drop of water or other solvent and let it evaporate spontaneously until crystals appear. It is better to make the microscopic examination before the drying is complete. Do not use a cover-glass. If one does not obtain good crystals, "seed" the solution with some of the crust which forms at the edge of the drop by pushing some of the crust into the middle of the drop. This usually starts the crystallization.

Frequently a chemically pure salt cannot be made to yield satisfactory crystals on the evaporation of its solution, but beautifully formed crystals will result when in the presence of other compounds. A striking example is found in Ammonium chlorid. This salt fails to yield other than dendritic masses when preparations are made from the pure salt, but if formed by metathesis and especially if in the presence of a difficultly crystallizable salt, well formed isometric crystals (cubes) are seen.

EXAMPLES ILLUSTRATING THE CRYSTAL SYSTEMS

“Isometric.

Sodium chlorid, potassium chlorid potassium iodid. Strontium nitrate. Barium nitrate. Lead nitrate. Potassium bromid. Sodium bromid.

Alums crystallize in octahedra, cubes or combinations of the two. It is well to recall that the alums have the general formula, $M_2(RO_4)_3 \cdot N_2RO_4 \cdot 24 H_2O$, where M- can be Al, Cr, Mn, Fe, In, Ga, Tl, R; -N- Na, K, Rb, Cs, NH_4 , Ag, or Tl and -R- S or Se. All alums are isomorphous.

Tetragonal.

Potassium copper chlorid. Ammonium copper chlorid. Urea.

Nickel sulfate $6H_2O$. This salt is dimorphic, crystallizing also in the monoclinic system. Nickel sulfate $7H_2O$ is orthorhombic.

Orthorhombic.

Asparagin. Picric acid. Acetanilid. Resorcin.

Mercuric chlorid. Silver nitrate. Potassium sulfate. Potassium nitrate.

Magnesium sulfate $7H_2O$. Potassium chromate. Sodium nitrate (also Hexagonal).

Monoclinic.

Lactose. Napthalene. Potassium ferric oxalate. Sodium ferric oxalate.

Potassium chlorate (sodium chlorate is Isomet. or Tetrag.)

Lead acetate. Copper acetate H_2O . Oxalic acid.

Ferrous sulfate, this salt forms normally with $7 H_2O$ and is then Monoclinic, but in presence of zinc sulfate becomes Orthorhombic, and in presence of copper sulfate, triclinic. Sodium Sulfate $10H_2O$. Borax. Potassium ferricyanid.

Triclinic.

Copper sulfate $5H_2O$. Boric acid. Potassium dichromate.

Hexagonal.

Lead iodid (according to Behrens PbI_2 is probably orthorhombic).

Sodium nitrate (also Orthorhombic). Bromoform. Iodoform.

AN EXERCISE FOR PRACTICE

“Take a fragment of ammonium chlorid, dissolve in a tiny drop of water on a slide and try to obtain distinct well formed crystals. Neither slow nor rapid evaporation nor recrystallization by breathing on the preparation will yield satisfactory crystals.”

Place a small drop of water on a glass slide, add Ferric chlorid until the drop is distinctly yellow. Stir. At the center of the drop add two or three tiny fragments of Ammonium acetate. The preparation must not be warmed.

There is formed Ferric acetate, Ammonium chlorid and double chlorids of ammonium and iron. Study the preparation and observe the following points.

1. Tendency toward formation of double salt. 2. That the type crystal of NH_4Cl is a cube. 3. Cubes may so grow as to present the appearance of a rectangular prism. 4. In certain positions cubes have the appearance of a pyramid. 5. In other positions they exhibit a hexagonal outline, thus simulating a polyhedron of many faces. 6. There is scarcely any tendency in this case toward the formation of the dendritic masses observed in the first experiment. 7. The crystals often develop fastest along the diagonal planes so that the regular faces are replaced by pyramidal depressions."

FIG. 141. *Czapski's Ocular Iris-diaphragm with cross hairs for examining and accurately determining the axial images of small crystals. The iris diaphragm enables the observer to make the field as large or small as desired.*

A. Longitudinal Section.

B. Transection, showing the cross lines and the iris diaphragm with the projecting part at the left, by which the diaphragm is opened and closed. (Zeiss' Catalog.)

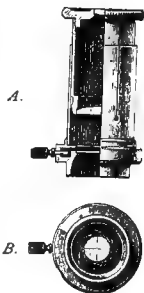

For directions and hints in micro-chemical work and crystallography, consult the various volumes of the Journal of the Roy. Micr. Soc.; Zeitschrift für physiologische Chemie, and other chemical journals; Wormly; Klément & Renard; Carpenter-Dallinger; Hogg; Behrens, Kossel und Schiefferdecker; Frey; Dana, and other works on mineralogy; Davis, Behrens, T. H.—Anleitung zur micro-chemischen Analyse der wichtigsten organischen Verbindungen. Hamburg, 1895-1897. Microchemische Technik, 2d edition, Hamburg, 1900. A manual of microchemical analysis with an introductory chapter by J. W. Judd, London. 1894.

Especial attention is also called to the articles of Dr. E. M. Chamot in the Journal of Applied Microscopy beginning with vol ii. p. 502, and continued in vol iii. and iv.

TEXTILE, FIBERS, FOOD AND PHARMACOLOGICAL PRODUCTS

§ 255. *Textile Fibers.*—The microscope is coming more and more into use for the determination of the character of textile fibers, both in the raw state and after manufacture. As the textile fibers have distinctive characters it is not difficult to determine mixtures in fabrics of various kinds. The student is advised to study carefully known fibers, as of cotton, wool, linen, silk, jute etc., so that he is certain of the appearances, and then to determine of what fibers different fabrics are composed. He will be astonished at the amount of "Alabama wool" in supposedly all wool goods.

§ 256. Food and Drugs.—From the nature of food and pharmacological products adulterations are in many cases most accurately and easily determined by microscopic examination. The student will find constant reference to the microscopical characters of the genuine and spurious substances in medicines and other pharmacological products in works on pharmacy or pharmacology; also in pharmacological journals and in druggists reports.

For works and articles upon textile fibers see: Herzfeld, J. Translated by Salter. The technical testing of yarns and textile fabrics with reference to official specifications. London, 1898. E. A. Posselt—The structure of fibers

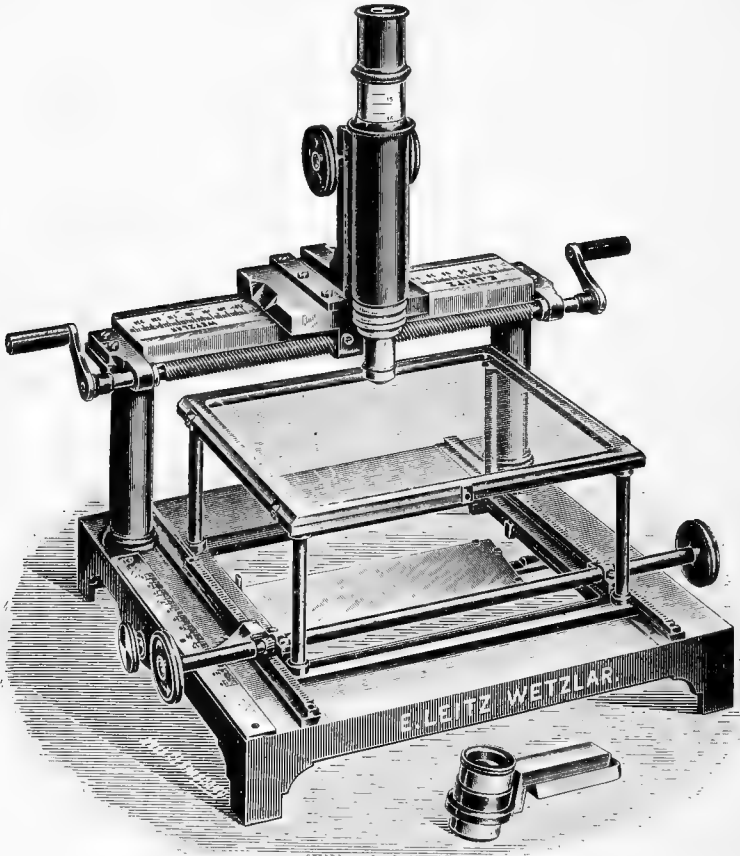

FIG. 142. Nebelthau's Traversing Microscope. This instrument makes it possible to go over carefully very large objects, entire brain sections, or to scrutinize carefully a large amount of a substance as in examinations for adulterations of foods or drugs. (From Leitz' Catalog.)

yarns and fabrics. Philadelphia and London, 1891. Dr. C. Rougier—Des filements végétaux employés dans l'industrie. Paris, 1873. Wm. P. Wilson and E. Fahrng—, The conditioning of wool and other fabrics in the technological laboratories of the Philadelphia Commercial Museum. *Journal of Applied Microscopy*, Vol. II, (1899) pp. 290-292, 457-460. *Bulletin of the National Association of Wool Growers*, 1875, p. 470. *Proceedings of the Amer. Micr. Soc.*, 1884, pp. 65-68. Hanausek and Winton. *The Microscopy of Technical Products*; Winslow, *Elements of Applied Microscopy*, excellent on foods, drugs, textile fibers, paper. Besides these references one is liable to find pictures and discussions of various fibers in general works on the microscope, and in technical and general cyclopædias.

The microscopical Journals also contain occasional articles bearing upon this subject. See also Food Products in bulletins of the U. S. Dep't Agr. Macé, E.—Les substances alimentaire, etc., Paris, 1891. Schimper, A. F. W. *Anleitung*, etc. Jena, 1900. Hugh Galt,—*The Microscopy of the starches*, illustrated by photo-micrographs, London, 1900. Winton and Moeller, *The Microscopy of Vegetable Foods*. Greenish, *Micr. Ex. Food and Drugs.*; Wiley, *Foods and their Adulterations*. (See also the other works in the Bibliography at the end.)

THE MICROSCOPE IN METALLOGRAPHY

§ 257. In the modern investigation of metals and alloys much light has been thrown upon the structural peculiarities which render some mixtures satisfactory and others unsatisfactory. There are two great methods: First, that of studying fractured surfaces without recourse to any reagents. Second, to polish a metallic surface carefully with emery or carborundum and finally with rouge or diamantine and then etch it with some acid for a longer or shorter time. For either method reflected light must be used. For low powers that obtained at a good window or by a lamp or a lamp and bulls eye are good. The illuminating objectives (§ 31), *i. e.* objectives in which a prism or reflector in the objective reflects light down through the lenses which act as a condenser, are preferable for most work and indeed necessary if one uses high powers.

Elaborate arrangements have been devised for holding the piece of metal on the stage, but some beeswax, or some clay made plastic with glycerin answers well. For pictures of the appearances seen in studying metallic surfaces, see the journals of engineering and metallurgy, especially the *Metallographist*, a quarterly publication devoted to the study of metals with special reference to their physics and micro-structure, etc. In twenty-five or more of the great metal manufacturing establishments special laboratories for microscopic examination and investigation have been established. This is an illustration of what has frequently occurred—great manufacturing interests have outrun the universities in the appreciation and application of methods of research. Fortunately, however, laboratories are already springing up in connection with the universities, and probably within a few years every great technical school will have its laboratory of micro-metallography where students

will have opportunity to perfect themselves in the preparation, photography and microscopic study of the metals and alloys.

Beside the sources of information given above, see Dr. H. Ost und Dr. Fr. Kolbeck, *Lehrbuch der chemischen Technologie mit einem Schlussabschnitt "Metallurgie."* Hannover, 1901. Behrens, T. H.—*Das mikroskopische Gefüge der Metalle*, etc. Hamburg, 1894. For an excellent bibliography of 188 titles; see the *Metallographist*, Vol. I, 1898, and appended to the special papers in all the volumes. Also in *Iron Age*, Jan. 27, 1898. Carpenter-Dalinger, p. 264; and every number of the *Journal of the Royal Microscopical Society* and *Zeit wiss Mikroskopie*.

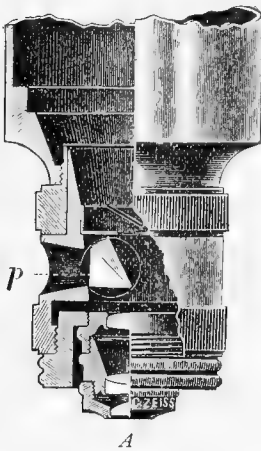

A
143

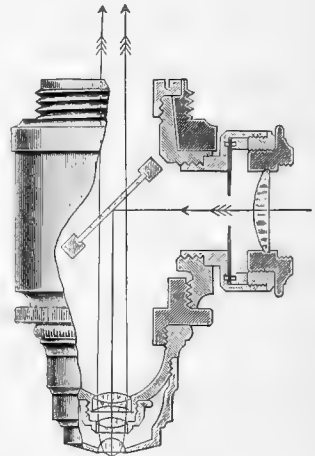

144

FIG. 143. *Zeiss' Illuminating Objective.* Light at right angles to the axis of the microscope is reflected by a prism down through the lenses of the objective upon the object. This lights the object, and rays from it pass up through the objective to form the image (*Zeiss' Catalog*).

FIG. 144. *Leitz' Illuminating Objective.* The general principle is the same as for Fig. 143. (§ 31.)

CHAPTER VII

THE ABBE TEST PLATE AND APERTOMETER; EQUIVA- LENT FOCUS OF OBJECTIVES AND OCULARS; CLASS DEMONSTRATION IN HISTOLOGY AND EMBRYOLOGY

APPARATUS AND MATERIAL FOR THIS CHAPTER

Abbe test-plate (§ 258); Apertometer (§ 259); Tester for immersion liquid (§ 260); Microscope with 250 mm. tube and objectives (§ 262); Stage micrometer (§ 262); Filar micrometer with positive ocular (§ 262); Oculars (§ 264).

Demonstration microscopes and dissecting microscope (Figs. 147-149); Traveling microscope (Figs. 150-151); Indicator or pointer oculars (Figs. 152-154); Compound microscope (Fig. 155); Projection microscope (Figs. 158-160).

TEST PLATE AND APERTOMETER

§ 258. On the Method of Using Abbe's Test-Plate.—This test-plate is intended for the examination of objectives with reference to their corrections for spherical and chromatic aberration and for estimating the thickness of the cover-glass for which the spherical aberration is best corrected.

“The test-plate consists of a series of cover-glasses ranging in thickness from 0.09 mm. to 0.24 mm., silvered on the under surface and cemented side by side on a slide. The thickness of each is written on the silver film. Groups of parallel lines are cut through the film and these are so coarsely ruled that they are easily resolved by the lowest powers, yet from the extreme thinness of the silver they form a very delicate test for objectives of even the highest power and widest aperture. To examine an objective of large aperture the plates are to be focused in succession observing each time the quality of the image in the center of the field and the variation produced by using alternately central and very oblique illumination. When the objective is perfectly corrected for spherical aberration for the particular thickness of cover-glass under examination, the contour of the lines in the center of the field will be perfectly sharp by oblique illumination without any nebulous doubling or indistinctness of the minute irregularities of the edges. If after exactly adjusting the objective for oblique light, central illumination is used no alteration of the adjustment should be necessary to show the contours with equal sharpness.”

“If an objective fulfills these conditions with any one of the plates it is free from spherical aberration when used with cover-glasses of that thickness; on the other hand if every plate shows nebulous doubling or an indistinct appearance of the edges of the silver lines, with oblique illumination, or if the objective requires a different adjustment to get equal sharpness with central as with oblique light, then the spherical correction is more or less imperfect.”

“Nebulous doubling with oblique illumination indicates overcorrection of the marginal zone, want of the edges without marked nebulosity indicates undercorrection of this zone; an alteration of the adjustment for oblique and central illumination, that is, a difference of plane between the image in the peripheral and central portions of the objective points to an absence of concurrent action of the separate zones, which may be due to either an average under or overcorrection or to irregularity in the convergence of the rays.”

“The test of chromatic correction is based on the character of the color bands, which are visible by oblique illumination. With good correction the edges of the silver lines in the center of the field should show but narrow color bands in the complementary colors of the secondary spectrum, namely, on one side yellow-green to apple-green on the other violet to rose. The more perfect the correction of the spherical aberration the clearer this color band appears.”

“To obtain obliquity of illumination extending to the marginal zone of the objective and a rapid interchange from oblique to central light Abbe's illuminating apparatus is very efficient, as it is only necessary to move the diaphragm in use nearer to or further from the axis by the rack and pinion provided for the purpose. For the examination of immersion objectives, whose aperture as a rule is greater than 180° in air and those homogeneous immersion objectives, which considerably exceed this, it will be necessary to bring the under surface of the Test-plate into contact with the upper lens of the illuminator by means of a drop of water, glycerin or oil.”

“In this case the change from central to oblique light may be easily effected by the ordinary concave mirror but with immersion lenses of large aperture it is impossible to reach the marginal zone by this method, and the best effect has to be searched for after each alteration of the direction of the mirror.”

“For the examination of objectives of smaller aperture (less than 40° – 50°) we may obtain all the necessary data for the estimation of the spherical and chromatic corrections by placing the concave mirror so far laterally, that its edge is nearly in the line of the optic axis the incident cone of rays then only filling one-half of the aperture of the objective. The sharpness of the contours and the character of the color bands can be easily estimated. Differences in the thickness of the cover-glass within the ordinary limits are scarcely noticeable with such objectives.”

“It is of fundamental importance in employing the test as above described to have brilliant illumination and to use an eye-piece of high power.”

“When from practice the eye has learnt to recognize the finer differences in the quality of the contour images this method of investigation gives very

trustworthy results. Differences in the thickness of cover-glasses of 0.01 or 0.02 mm. can be recognized with objectives of 2 or 3 mm. focus.

"With oblique illumination the light must always be thrown perpendicularly to the direction of the lines."

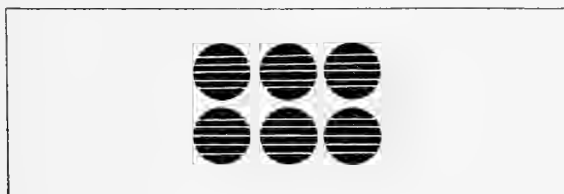

FIG. 145. *The Abbe Test Plate, lines covered by cover-glasses ranging in thickness from 0.09 to 0.24 mm.*

"The quality of the image outside the axis is not dependent on spherical and chromatic correction in the strict sense of the term. Indistinctness of the contours toward the borders of the field of view arises as a rule, from unequal magnification of the different zones of the objective; color bands in the peripheral portion (with good color correction in the middle) are caused by unequal magnification of the different colored images."

"Imperfections of this kind, improperly called "curvature of the field," are shown to a greater or less extent in the best objectives, where the aperture is considerable."

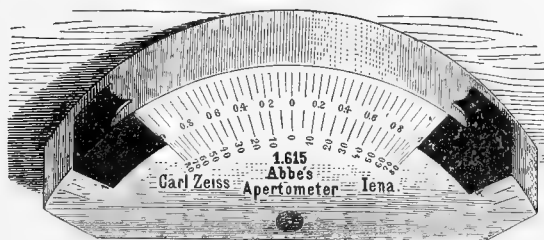

FIG. 146. *Abbe Apertometer.*

§ 259. **Determination of the Aperture of Objectives with an Apertometer.**—Excellent directions for using the Abbe Apertometer may be found in the *Jour. Roy. Micr. Soc.*, 1878, p. 19, and 1880, p. 20; in Dippel, Zimmerman, Czapski and Spitta, Ch. XIV. The following directions are but slightly modified from Carpenter-Dallinger, pp. 394-396. The Abbe apertometer involves the same principle as that of Tolles, but it is carried out in a simpler manner; it is shown in Fig. 146. As seen by this figure it consists of a semi-circular plate of glass. Along the straight edge or chord the glass is beveled at 45°, and near this straight edge is a small, perforated circle, the perforation being in

the center of the circle. To use the apertometer the microscope is placed in a vertical position, and the perforated circle is put under the microscope and accurately focused. The circular edge of the apertometer is turned toward a window or plenty of artificial light so that the whole edge is lighted. When the objective is carefully focused on the perforated circle the draw-tube is removed and in its lower end is inserted the special objective which accompanies the apertometer. This objective and the ocular form a low power compound microscope, and with it the back lens of the objective, whose aperture is to be measured, is observed. The draw-tube is inserted and lowered until the back lens of the objective is in focus. "In the image of the back lens will be seen stretched across, as it were, the image of the circular part of the apertometer. It will appear as a bright band, because the light which enters normally at the surface is reflected by the bevel part of the chord in a vertical direction so that in reality a fan of 180° in air is formed. There are two sliding screens seen on either side of the apertometer; they slide on the vertical circular portion of the instrument. The images of these screens can be seen in the image of the bright band. *These screens should now be moved so that their edges just touch the periphery of the back lens.* They act, as it were, as a diaphragm to cut the fan and reduce it, so that its angle just equals the aperture of the objective and no more." "This angle is now determined by the arc of glass between the screens; thus we get an angle in glass the exact equivalent of the aperture of the objective. As the numerical apertures of these arcs are engraved on the apertometer they can be read off by inspection. Nevertheless a difficulty is experienced, from the fact that it is not easy to determine the exact point at which the edge of the screen touches the periphery of the back lens, or as we prefer to designate it, *the limit of aperture*, for curious as the expression may appear we have found at times that the back lens of the objective is *larger* than the *aperture* of the objective *requires*. In that case the edges of the screen refuse to touch the periphery."

In determining the aperture of homogeneous immersion objectives the proper immersion fluid should be used as in ordinary observation. So, also, with glycerin or water immersion objectives.

‡ 260. **Testing Homogeneous Immersion Liquid.**—In order that one may realize the full benefit of the homogeneous immersion principle it is necessary that the homogeneous immersion liquid shall be truly homogeneous. In order that the ordinary worker may be able to test the liquid used by him, Professor Hamilton L. Smith devised a tester composed of a slip of glass in which was ground accurately a small concavity and another perfectly plain slip to act as cover. (See Proc. Amer. Micr. Soc.; 1885, p. 83.) It is readily seen that this concavity, if filled with air or any liquid of less refractive index than glass, acts as a concave or dispersing lens. If filled with a liquid of greater refractive index than glass, the concavity acts like a convex lens, but if filled with a liquid of the same refractive index as glass, that is, liquid optically homogeneous with glass, then there is no effect whatever.

In using this tester the liquid is placed in the concavity and the cover put on. This is best applied by sliding it over the glass with the concavity. A small amount of the liquid will run between the two slips, making optical

contact on both surfaces. One should be careful not to include air bubbles in the concavity. The surfaces of the glass are carefully wiped so that the image will not be obscured. An adapter with society screw is put on the microscope and the objective is attached to its lower end. In this adapter a slot is cut out of the right width and depth to receive the tester which is just above the objective. As object it is well to employ a stage micrometer and to measure carefully the diameter of the field without the tester, then with the tester far enough inserted to permit of the passage of rays through the glass but not through the concavity, and finally the concavity is brought directly over the back lens of the objective. This can be easily determined by removing the ocular and looking down the tube.

Following Professor Smith's directions it is a good plan to mark in some way the exact position of the tube of the microscope when the micrometer is in focus without the tester, then with the tester pushed in just far enough to allow the light to pass through the plane glass and finally when the light traverses the concavity. The size of the field should be noted also in the three conditions (§ 57-58).

It is seen by glancing at the following table that whenever the liquid in the tester is of lower index than glass, the concavity with the liquid acts as a concave lens, or in other words like an amplifier (p. 123), and the field is smaller than when no tester is used. It is also seen that as the liquid in the concavity approaches the glass in refractive index, the field approaches the size when no tester is present. It is also plainly shown by the table that the greater the difference in refractive index of the substance in the concavity and the glass, the more must the tube of the microscope be raised to restore the focus.

If a substance of greater refraction than glass is used in the tester the field is larger, *i. e.*, the magnification less, and one would have to turn the tube down instead of up to restore the focus.

The table given below indicates the changes when using a tester prepared by the Gundlach Optical Co., and used with a 16 mm. apochromatic objective of Zeiss, $\times 4$ compensation ocular, achromatic condenser, 1.00 N. A. (Fig. 47):

Tester and Liquid in the Concavity	Size of the Field	Elevation of the Tube necessary to Restore the Focus
No tester used	1.825 mm.	Standard position --
Whole thickness of the tester at one end, not over the cavity	1.85 mm.	No change of focus.
Tester with water	1.075 mm.	Tube raised $3\frac{1}{2}$ mm.
Tester with 95% alcohol	1.15 mm. 3 mm.
Tester with kerosene	1.4 mm. 2 mm.
Tester with Gundlach Opt. Co's hom. liquid	1.825 mm. $\frac{1.0}{100}$ mm.
Bausch & Lomb Opt. Co's hom. liquid	1.825 mm. $\frac{2.0}{100}$ mm.
Leitz' hom. liquid	1.825 mm. $\frac{2.0}{100}$ mm.
Zeiss' hom. liquid	1.825 mm. $\frac{2.0}{100}$ mm.

§ 261. Equivalent Focus of Objectives and Oculars.—To work out in proper mathematical form or to ascertain experimentally the equivalent foci

of these complex parts with real accuracy would require an amount of knowledge and of apparatus possessed only by an optician or a physicist. The work may be done, however, with sufficient accuracy to supply most of the needs of the working microscopist. The optical law on which the following is based is:—"The size of object and image varies directly as their distance from the center of the lens."

By referring to Figs. 14, 16, 26, it will be seen that this law holds good. When one considers compound lens systems the problem becomes involved, as the center of the lens system is not easily ascertainable hence it is not attempted, and only an approximately accurate result is sought.

§ 262. **Determination of the Equivalent Focus of Objectives.**—Look into the objective to be tested and locate the position of the back lens. Indicate this on the outside of the objective mount. This is not usually at the optical center, but a near enough approximation for this experiment. Put the objective in position on a microscope whose draw-tube may be extended 250 mm. *i. e.*: sufficiently to give a tube-length of 250 mm. If the draw-tube is not of sufficient length put on an extension piece.

Select a positive ocular. One of the Filar micrometers is very satisfactory (Fig. 119). A Huygenian ocular is not satisfactory for this purpose. Use a stage micrometer as object. With extension piece and draw-tube make the distance between the back lens of the objective and the position of the cross lines of the filar micrometer 250 mm. This is so that the image distance shall be 250 mm.

Arrange the filar micrometer so that its movable line shall be parallel with one of the lines of the stage micrometer, and then proceed to measure the space, making several measurements and taking the average as directed in § 190. But in this case it is necessary to know the size of the real image in millimeters. The pitch of the screw we will suppose is $\frac{1}{2}$ mm. as in the one figured (Fig. 119) then the whole revolution will move the traversing line $\frac{1}{2}$ mm., and the partial revolutions may be read on the graduated drum each graduation representing a movement of 0.005 mm. or 5μ . Suppose it requires 2.50 revolutions of the drum to pass the movable line over $\frac{1}{10}$ of a millimeter on the stage micrometer. Then the size of the real image of $\frac{1}{10}$ mm. is two and one-half revolutions multiplied by the value of one revolution or the pitch of the screw which is one-half of a millimeter thus: $2.50 \times 0.5 = 1.25$ mm. Now if the object is $\frac{1}{10}$ mm. and the real image is 1.25 mm. the magnifica-

tion of the real image is $1.25 \div 0.1 = 12.5$ or the real image is $12\frac{1}{2}$ times as large as the object (Figs. 26, 109.)

To find the equivalent focus of this objective knowing its magnification at 250 mm. one has simply to apply the law as shown graphically in Fig. 109, viz; The size of object and image are directly as their distances from the center of the lens: The distance of the object from the lens is with the microscope very nearly the principal focal distance and is designed by f . The formula is then written: the object is to the image as the principal focal distance is to the image distance (250 mm.) or $0.1::f:250$ mm. In this case all the factors are known except f . Then $1.25:0.1::f:250$ whence $f=20$. Or as the magnification of the real image is known to be 12.5 the formula may read $12.5:1::f:250$ whence $f=20$ as before. By referring to figures 109 it is seen that if the simple lens had a principal focal distance of 20 mm. and the image distance is 250 mm. then the real image is 12.5 times the length of the object, since the distances from the center of the lens to the object (20 mm) and image (250 mm.) are in the proportion of 1 to 12.5.

§ 263 **Determination of Initial or Independent Magnification of the Objective.**—The Initial magnification means simply the magnification of the real image (A^1B^1 , Fig. 26, also Fig 109) unaffected by the ocular. It may be determined experimentally exactly as described in § 262. For example, the image of the object ($\frac{1}{10}$ mm.) measured by the ocular micrometer, at a distance of 250 mm. is 1.25., *i. e.*, it is 12.5 times magnified, hence the initial magnification of the 20 mm. objective is 12.5.

Knowing the equivalent focus of an objective, one can determine its initial magnification by dividing 250 mm. by the equivalent focus in millimeters. Thus the initial magnification of a 5 mm. objective is $\frac{250}{5} = 50$; of a 3 mm., $\frac{250}{3} = 83.3$; of a 2 mm., $\frac{250}{2} = 125$.

§ 264. **Determining the Equivalent Focus of an Ocular.**—If one knows the initial magnification of the objective (§ 263) the approximate equivalent focus of the ocular can be determined as follows :

The distance between the position of the real image, a position indicated in the ocular by a diaphragm, and the back lens of the objective should be made 250 mm., as described in § 262-263, then by the aid of Wollaston's camera lucida the magnification of the

whole microscope is obtained as described in § 176. As the initial power of the objective is known, the power of the whole microscope must be due to that initial power multiplied by the power of the ocular, the ocular acting like a simple microscope to magnify the real image (Fig 26).

Suppose one has a 50 mm. objective; its initial power will be approximately 5. If with this objective and an ocular of unknown equivalent focus the magnification of the whole microscope is 50, then the real image or initial power of the objective must have been multiplied 10 fold. Now if the ocular multiplies the real image 10 fold it has the same multiplying power as a simple lens of 25 mm. focus, for, using the same formula as before: $(o; i :: f: 250 \text{ mm.})$ $5:50 :: f:250$. Whence $f=25$, the equivalent focus of the ocular.

For a discussion of the equivalent focus of compound lens-systems, see modern works on physics; see also C. R. Cross, on the Focal Length of Microscopic Objectives, Franklin Institute Jour., 1870, pp. 401-402; Monthly Micr. Jour., 1870, pp. 149-159. J. J. Woodward on the Nomenclature of Achromatic Objectives, Amer. Jour. Science, 1872, pp. 406-414; Monthly Micr. Jour., 1872, pp. 66-74. W. S. Franklin, Method of determining focal lengths of microscope lenses. Physical Review, Vol. I, 1893, p. 142. See pp. 1119-1131 of Carpenter-Dallinger for mathematical formulæ; also Daniell, Physics for medical students; Czapski, Theorie der optischen Instrumente; Dippell, Nägeli und Schwendener, Zimmermann. E. M. Nelson, J. R. M. S. 1898, p. 362, 1900, pp. 162-169. Jour. Quekett Micr. Club, vol. V. pp. 456, 462. A. E. Wright, Principles of Microscopy, and in Jour. Roy. Micr. Soc., 1904, p. 279; Spitta, Microscopy; Edser, Light for Students; Conrad Beck, Cantor Lectures.

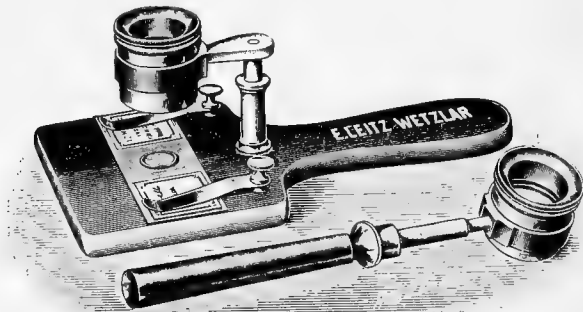
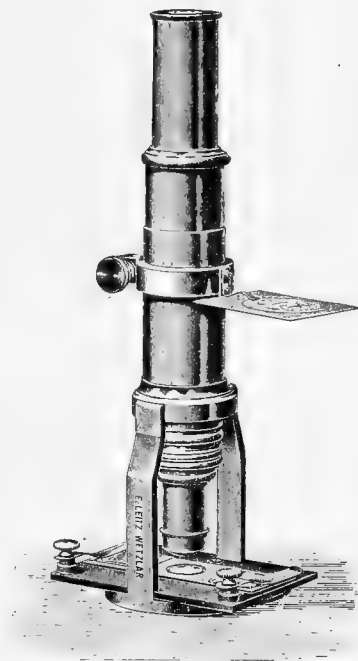

FIG. 147. *Simple Demonstration Microscopes.* The upper figure has a kind of stage with clips to hold the specimen. The lens may be focused up and down by sliding it on the standard. For observation it is held between the eye and the source of light. In the lower figure the lens is supported by a handle and may be used something as a reading glass. (From Leitz' Catalog.)

DEMONSTRATION MICROSCOPES AND INDICATORS

§ 265. **Simple Microscope.**—Holding the simple microscope in one hand and the specimen in the other, has always been used for demonstration, but for class demonstration it is necessary to have microscope and specimen together or the part to be observed by the class is frequently missed. Originally blocks of various kinds to hold both microscope and specimen were devised, but within the last few years excellent pieces of apparatus have been devised by several opticians for the purpose. The accompanying figure shows one of the best forms.

FIG. 148. *Demonstration compound microscope of Leitz. Leitz now furnishes a fine adjustment in the form of an intermediate piece between the objective and the tube. This has in it a screw which is turned by a milled ring. For the objectives employed it makes an efficient fine adjustment and renders it possible for each person to adjust the microscope slightly without endangering the loss of field.*



§ 266. **Compound Demonstration Microscope.**—This was originally called a clinical or pocket microscope. It is thus described by Mayall in his *Canton Lectures on the history of the microscope*: “A small microscope was devised by Tolles for clinical purposes which seems to me so good in every way that I must ask special attention for it. The objective is screwed into a sliding

tube, and for roughly focusing the sliding motion suffices; for fine adjustment, the sheath is made to turn on a fine screw thread on a cylindrical tube, which serves also as a socket carrier for the stage. The compound microscope is here reduced to the simplest form I have met with to be a really servicable instrument for the purpose in view; and the mechanism is of thoroughly substantial character. I commend this model to the notice of our opticians."

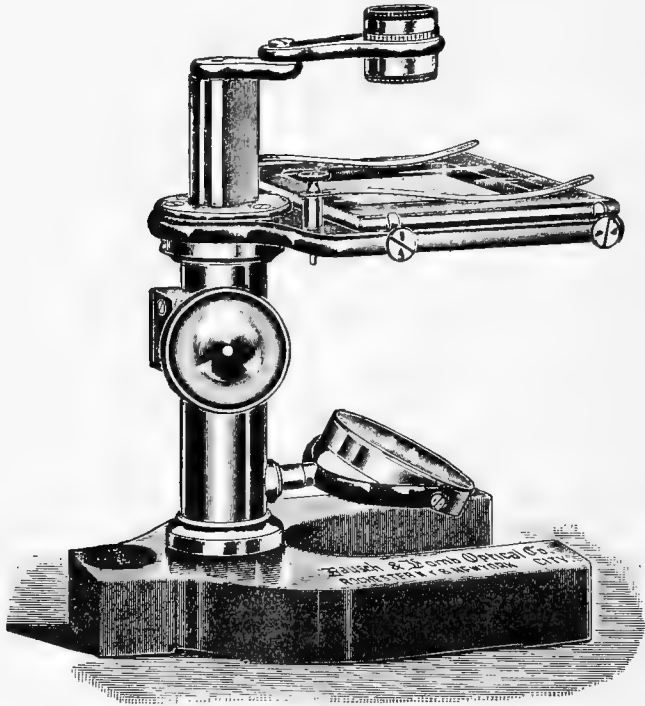

FIG. 149. *Dissecting microscope. This is convenient for demonstrations of rather large objects. If they are transparent then the mirror is used. If the objects are opaque they must be lighted by a mirror above the stage or by a bull's eye condenser. In this one the focusing is done by a rack and pinion. (Cut loaned by the Bausch & Lomb Optical Co.)*

Since its introduction by Tolles many opticians have produced excellent demonstration microscopes of this type, but most of them have not preserved a special mechanism for fine adjustment. With it one can demonstrate with an objective of 6 mm. satisfactorily. It

has a lock so that once the specimen is in the right position and the instrument focused it may be passed around the class. For observation it is only necessary for each student to point the microscope toward a window or a lamp.

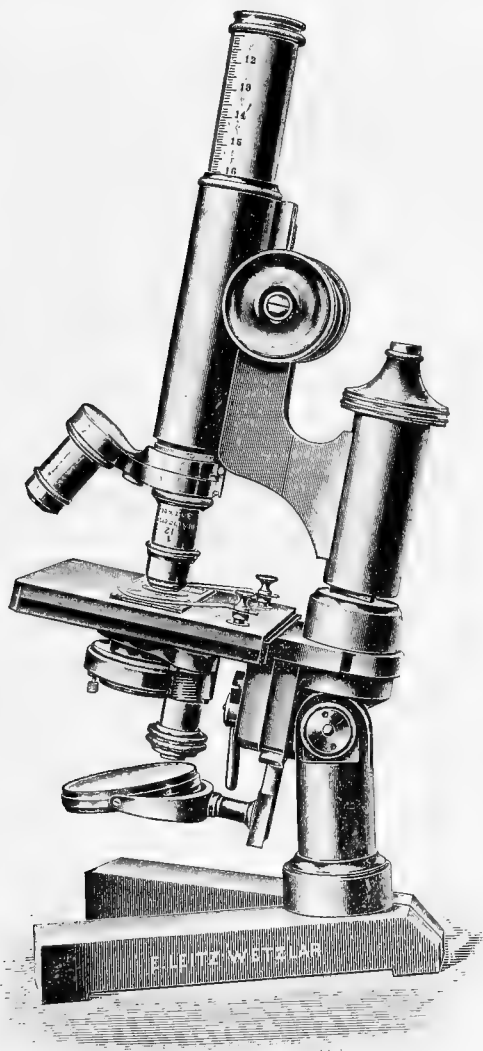

FIG. 150. *Traveling microscope set up for work (From Leitz' Catalog.)*

A modification of this clinical microscope was made by Zentmayer in which the microscope was mounted on a board and a lamp for illuminating the object was placed at the right position.

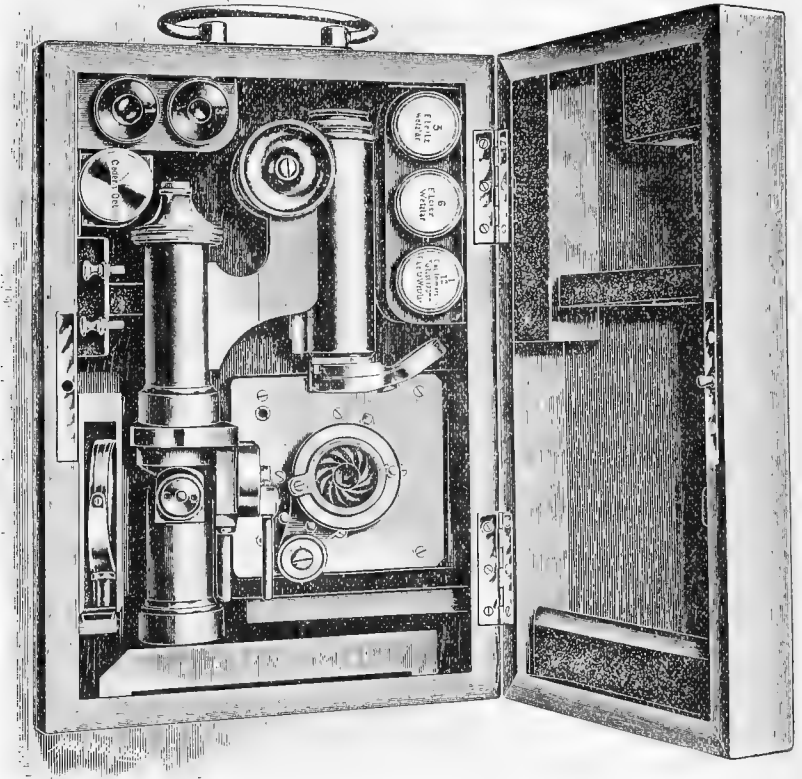

FIG. 151. *Traveling microscope folded up and in its case. (From Leitz Catalog.)*

§ 267. **Traveling Microscope.**—For many years the French opticians have produced most excellent traveling microscopes. The opticians of other countries have also brought out serviceable instruments. In the one here figured Mr. Leitz has combined in an admirable way a traveling microscope and a laboratory instrument. For the needs of the pathologist and sanitary inspector a microscope must possess compactness and also the qualities which render

it usable for nearly all the purposes required in a laboratory. This instrument is a type of such apparatus which has grown up with the needs of advancing knowledge.

§ 268. **Indicator or Pointer Ocular.**—This is an ocular in which a delicate pointer of some kind is placed at the level where the real image of the microscope is produced. It is placed at the same level as the ocular micrometer, and the pointer like the micrometer is magnified with the real image and appears as a part of the projected image (Fig. 154). By rotating the ocular or the pointer any part of the real image may be pointed out as one uses a pointer on a wall or blackboard diagram. By means of the indicator eyepiece one can be certain that the student sees the desired object, and is not confused by the multitude of other things present in the field. This device has been invented many times. It illustrates

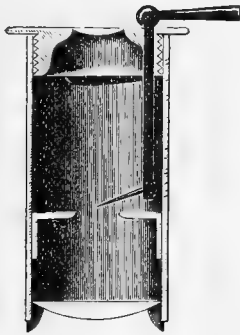

FIG. 152

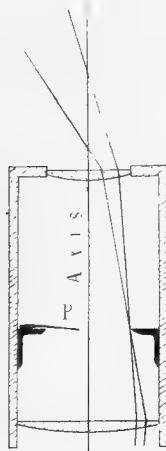

FIG. 153

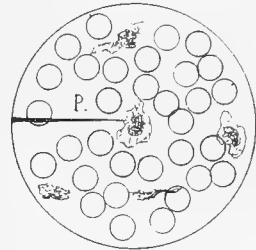

FIG. 154

FIG. 152. *Indicator ocular with metal pointer like the one devised by Quekett (Leitz' catalog).*

FIG. 153. *Indicator ocular with a fine hair from a camel's hair brush on the ocular diaphragm to serve as a pointer (P). This projects about half way across the diaphragm opening. On the opposite side are shown two rays from the microscope to indicate that the real image is formed at the level of the ocular diaphragm.*

FIG. 154. *Field of the microscope with a mammalian blood preparation to show the use of the indicator (P) for pointing out a white blood corpuscle.*

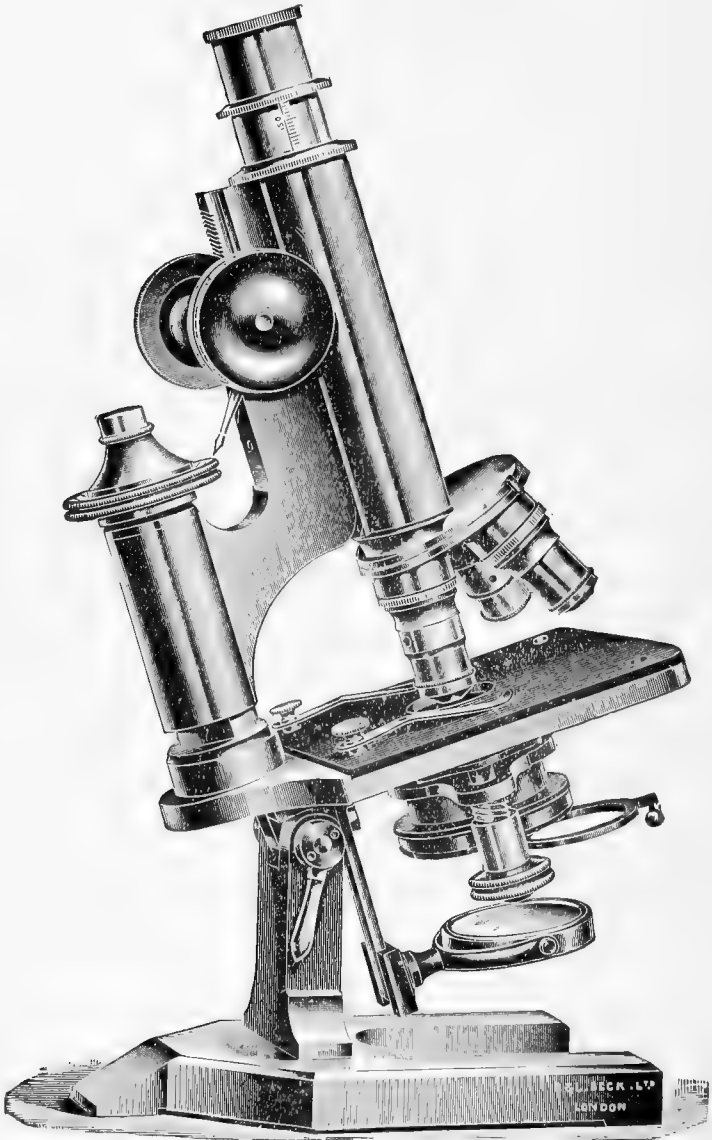

FIG. 155. *Compound Microscope with triple nose-piece and objectives and ocular in position. The ring below the condenser is drawn to one side. This ring is for blue glass or for a central-stop to use in dark-ground illumination ($\frac{1}{2}$ 103). In demonstrations it is a great advantage to have a fine hair in the ocular as shown in Figs. 153-154. (Cut loaned by Williams, Brown & Earle, Phila.)*

well the adage: "necessity is the mother of invention," for what teacher has not been in despair many times when trying to make a student see a definite object and neglect the numerous other objects in the field. So far as the writer has been able to learn, Quekett was the first to introduce an indicator ocular with a metal pointer which was adjustable and could be turned to any part of the field or wholly out of the field. See Fig. 152, § 140.

It is not known who adopted the simple device of putting a fine hair on the diaphragm of the ocular as shown in Fig. 153. This may be done with any ocular, positive or negative. One may use a little mucilage, Canada balsam or any other cement to stick the hair on the upper face of the diaphragm so that it projects about half way across the opening. When the eye-lens of the Huygenian ocular is screwed back in place the hair should be in focus. If it is not screw the eye-lens out a little and look again. If it is not now sharp, the hair is a little too high and should be depressed a little. If it is less distinct on screwing out the ocular it is too low and should be elevated. One can soon get it in exact focus. Of course it may be removed at any time.

§ 269. **Marking the Position of Objects.**—In order that one may prepare a demonstration easily and certainly in a short time the specimens to be shown must be marked in some way. An efficient and simple method is to put rings of black or colored shellac around the part to be demonstrated. For this the Marker, Figs. 70-72, is employed. For temporary marking an ink line may be put on with a pen.

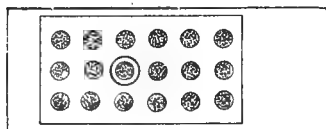

FIG. 156

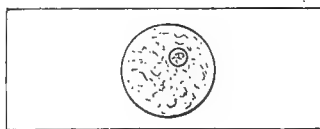

FIG. 157

FIG. 156. *Ring around one of the sections of a series for demonstrating some organ especially well.*

FIG. 157. *Figure of a microscopic preparation with a ring around a small part to show the position of some structural feature.*

THE PROJECTION MICROSCOPE

§ 270. **Projection Microscope.**—One of the most useful and satisfactory means at the disposal of the teacher of Microscopic Anatomy and Embryology for class demonstrations is the Projection Microscope. With it he can show hundreds of students as well as one, the objects which come within the range of the instrument.

It is far more satisfactory than microscopic demonstrations, for with the projection microscope the teacher can point out on the screen exactly the structural features and organs which he wishes to demonstrate, and he can thus be certain that the students know exactly what is to be studied. Unless one employs a pointer ocular (Fig. 153), there is no certainty that the student selects from the multitude of things in the microscopic field the one which is meant by the teacher. Like all other means, however, the projection

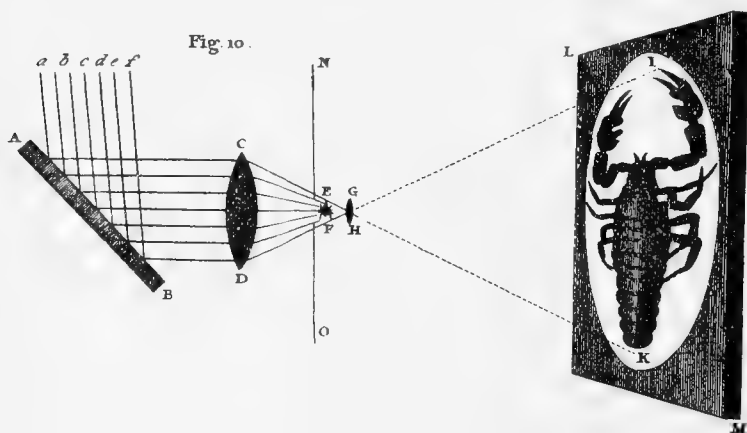

FIG. 158. *Diagram of Adams' Solar Microscope. This illustrates well the advantage of some form of projection microscope for demonstration purposes.*

a, b, c, d, e, f. Rays from the sun striking the mirror A-B, and being reflected horizontally to the condensing lens C-D. The condensing lens concentrates the light upon the object E-F. From the object the light passes to the objective G-H. The objective then projects an enlarged image I-K upon the screen at L-M. N-O opening in the shutter.

The action is exactly like that of a magic lantern except that an object is used instead of a lantern slide, and the objective gives a greater magnification than the one used on a magic lantern. (From George Adams Essays, 1787.)

microscope is limited. With it one can show organs both adult and embryonic, and the general morphology. For the accurate demonstration of cells and cell structure the microscope itself must be used. As a general statement concerning the use of the projection microscope for demonstration purposes, it may be said that it is entirely satisfactory for objects and details which show under the microscope with objectives up to 16 mm. equivalent focus. For objects and details requiring objectives higher than 16 mm. focus in ordinary microscopic observations, the projection microscope is unsatisfactory with large classes.

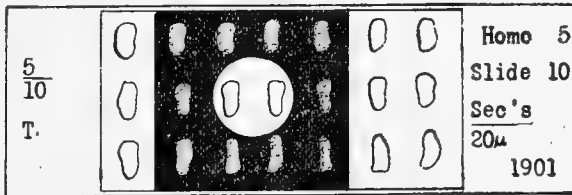

FIG. 159. Slide of several sections with a black mask. The mask is perforated over the sections to be demonstrated with the microscope or the projection microscope. It is put on the back of the slide and not on the cover-glass.

Unless one has a mask something like this the light is so dazzling that it is almost impossible to find the proper sections. It is easily removed by placing the slide on wet blotting paper.

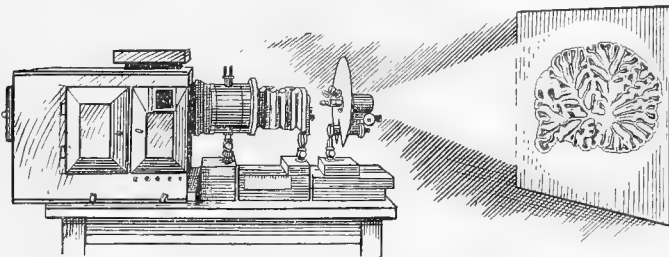

FIG. 160. Projection Microscope. This figure illustrates a modern projection microscope with an arc light for radiant. Such a projection microscope is available whenever there is an electric current; and is of the greatest use in projecting microscopic objects ranging from 60 mm. to $\frac{1}{10}$ of a millimeter so that a large class can see all the details. Its use in drawing was pointed out in § 209. (From Gage, *Origin and Development of the Projection Microscope.*)

The microscope for the individual student and the projection microscope for the teacher furnish most efficient aids in getting back to nature in the study of minute structure and morphology. Models and diagrams are very desirable aids in study and teaching, but the real things should never be made secondary to models and diagrams.*

* For a full consideration of the Projection Microscope see : Gage : Part I., The Origin and Development of the Projection Microscope ; Part II., Modern Projection with directions for installation and use.



FIG. 160a. *Watson & Sons' Edinburgh Students' Microscope (Stand G).*

CHAPTER VIII

PHOTOGRAPHING OBJECTS WITH A VERTICAL CAMERA; PHOTOGRAPHING LARGE TRANSPARENT OBJECTS; PHOTOGRAPHING WITH A MICROSCOPE (A) TRANSPARENT OBJECTS; (B) OPAQUE OBJECTS AND THE SURFACES OF METALS AND ALLOYS; ENLARGEMENTS; LANTERN SLIDES; BACTERIAL CULTURES.

APPARATUS AND MATERIAL FOR THIS CHAPTER

Vertical camera with photographic objectives (Fig. 161), small vertical camera with special microscope stand for embryos, etc. (Fig. 165); arrangement of camera for large transparent objects (Fig. 169), photo-micrographic camera (Fig. 172); photographic objectives for gross and microscopic work (Figs. 162, 166-168); microscope, microscopic objectives and projection oculars (Figs. 174-175); color screens, lamps, dry plates and the chemicals and apparatus necessary for developing, printing, etc.

§ 271. Nothing would seem more natural than that the camera, fitted with a photographic objective or with a microscopic objective, should be called into the service of science to delineate with all their complexity of detail, the myriads of forms studied.

For photographing many objects in nature the camera remains horizontal or approximately so, but for a great many of those studied in botany, zoology, mineralogy and in anatomy the specimens cannot be safely or conveniently put in the vertical position necessary for a horizontal camera. This difficulty has been overcome by using a mirror or a 45-degree prism. These are practically alike and have the defect of producing a picture with the inversion of a plane mirror.

VERTICAL CAMERA*

*Papers on this subject were given by the writer at the meeting of the American Association for the Advancement of Science in 1879, and at the meeting of the Society of Naturalists of the eastern United States in 1883; and in *Science* Vol. III, pp. 443, 444.

§ 272. To meet all the difficulties the object may be left in a horizontal position and the camera made vertical (Fig. 161).

Since 1879 such a camera has been in use in the Anatomical Department of Cornell University for photographing all kinds of specimens; among these, fresh brains and hardened brains have been photographed without the slightest injury to them. Furthermore, as many specimens are so delicate that they will not support their own weight, they may be photographed under alcohol or water with a vertical camera and the result will be satisfactory as a photograph and harmless to the specimen.

A great field is also open for obtaining life-like portraits of water animals. Freshly killed or etherized animals are put into a vessel of water with a contrasting back-ground and arranged as desired, then photographed. Fins have something of their natural appearance and gills of branchiate salamanders float out in the water in a natural way. In case the fish tends to float in the water a little mercury injected into the abdomen or intestine will serve as ballast.

The photographs obtainable in water are almost if not quite as sharp as those made in air. Even the corrugations on the scales of such fishes as the sucker (*Catostomus teres*) show with great clearness. Indeed so good are the results that excellent half tone plates may be produced from the pictures thus made, also excellent photogravures. In those cases, as in anatomical preparations, where a photograph rarely answers the requirements of a scientific figure, still it serves as a most admirable basis for such a figure. The photograph is made of the desired size and all the parts are in correct proportion and in the correct relative position. From this photographic picture may be traced all the outlines upon the drawing paper, and the artist can devote his whole time and energy to giving the proper expression without the tedious labor of making measurements.

"While the use of photography for outlines as bases for figures diminishes the labor of artists about one-half it increases that of the preparator; and herein lies one of its chief merits. The photographs being exact images of the preparations, the tendency will be to make them with greater care and delicacy, and the result will be less imagination and more reality in published scientific figures; and the objects prepared with such care will be preserved for future reference."

"In the use of photography for figures several considerations arise: (1) The avoidance of distortion; (2) The adjustment of the camera to obtain an image of the desired size; (3) Focusing; (4) Lighting and centering the object.

(1). While the camera delineates rapidly, the image is liable to distortion. I believe opticians are agreed, that, in order to obtain correct photographic images, the objective must be properly made, and the plane of the object must be parallel to the plane of the ground glass. Furthermore, as most of the objects in natural history have not plane surfaces, but are situated in several planes at different levels, the whole object may be made distinct by using in the objective a diaphragm with a small opening.

§ 273. Scale of Sizes and Focusing.—(2). By placing the camera on a long table and a scale of some kind against the wall, the exact position of the

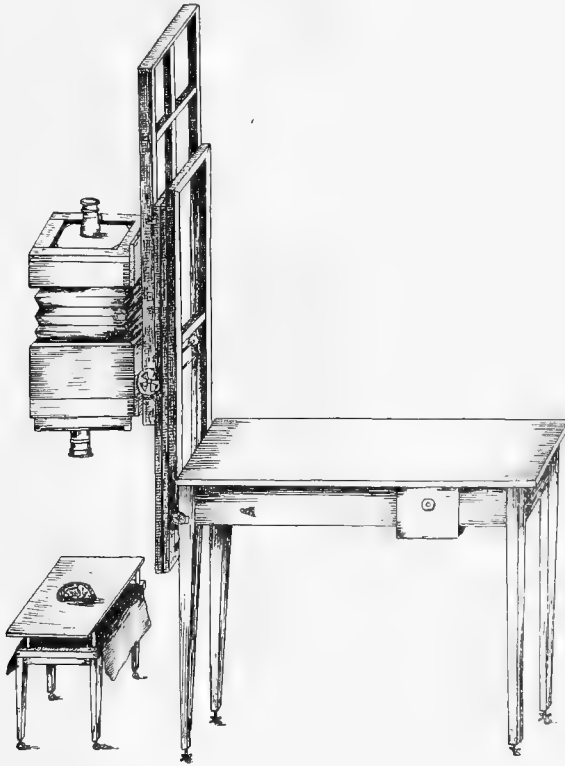

Fig. 161. *Vertical Camera for photographing objects in a horizontal position.* The camera is attached to a double frame connected by bent metal pieces fastened to the lower frame and sliding in a groove in the upper. The two frames can then slide over each other without separating. For moving the outer frame a rack work is put on the lower or inner frame and a pinion with a toothed wheel on the outer one. This is turned by the wheel shown. To prevent the camera running down in the vertical position a pawl is held in place by a spring. This may be released by a smaller wheel than that serving to move the pinion. This rack and pinion are fine enough for focusing with the photographic objectives employed.

The camera bed is graduated in centimeters so that the exact extent of the bellows can be determined by inspection.

The support on which the specimen rests is of heavy glass on vertical rods about 10 centimeters long. The background is placed on the table top about 10 cm. below. This arrangement of support and background serves to avoid the dense shadows which make it difficult to determine exactly the limits of the specimen. To make the apparatus steady the right hand end of the camera table is heavily weighted. The tables have leveling screws in the legs.

ground glass for various sizes may be determined once for all, and these positions noted in some way.

In the camera here figured, the camera bed is ruled in centimeters so that the position of the ground glass can be determined with accuracy and noted. It takes but a moment to set the ground glass or focusing screen at the right level to give any desired size. In practice it is convenient to have attached to the camera a table giving the position of the ground glass for various sizes,

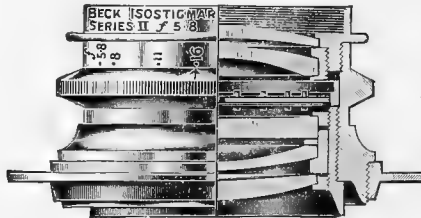

Fig. 162 *Beck's Isostigmat Objective.* "The lenses are ground with shallow curvature and mounted with air spaces instead of cement between the individual elements" (Cut loaned by Williams, Brown & Earle, Phila).

and also the distance of the objective from the object in each case. By having this information it takes but a moment to set the camera and to place it so that it will be approximately in focus. The final focusing is then accomplished by the use of the rack and pinion movement. It is an advantage to use a focusing glass and a clear focusing screen or the transparent part of the ordinary screen (Fig. 163), for the final focusing. Since many objects have no sharp details which one can focus on, it is helpful to focus on some printed letters put on the part to be brought out with the greatest sharpness. Of course these are removed before the exposure is made.

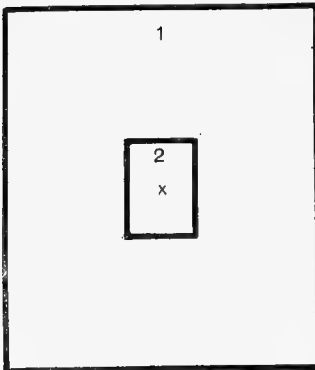

Fig. 163. *Ground-glass focusing screen with central transparent area for exact focusing with a focusing glass when one does not possess a clear focusing screen.*

(1) The ground surface; (2) Central part with oblong cover-glass over Canada balsam on the ground surface to render it transparent. X. The central point in the entire focusing screen; It is made with a black lead pencil on the ground surface. The focusing glass is focused on this cross, then when the image is in focus it will be at the level of the sensitive coating of the plate.

‡ 274. In Lighting the object one should take pains to so arrange it with reference to the light that the details will show with the greatest clearness.

Naturally for the vertical camera the light will come from the side and not from a skylight, although good results are obtained with a skylight if one so places the camera that it does not cast objectionable shadows.

As shown in Figs. 161, 165, the object is placed upon a glass support and the background is quite a distance below the support. For a dark object the background should be light, and for a light one dark. Black velveteen is excellent for a back-ground. The advantage of the glass support is that the shadows in the background which often make it difficult to tell just where the specimen ends and the background begins, are wholly done away with, and that too without at all affecting the proper light and shade of the object itself. (Method of W. E. Rumsey, Canadian Entomologist 1896, p. 84).



Fig 164. Tripod magnifier as a focusing glass. This is carefully focused on a scratch or pencil mark on the lower or ground surface of the focusing screen. Then whenever the object is sharply focused the focal plane will be at the level of the sensitive surface.

§ 275. Prints.—If the photographic prints are to be used solely for outlines, the well-known blue prints so much used in engineering and architecture may be made. If, however, light and shade and fine details are to be brought out with great distinctness, either an aristotype, velox, platinotype or bromide print is preferable.

§ 276. Recording, Storing and Labeling Negatives.—In order to get the greatest benefit from past experience it is necessary to make the results available by means of a careful record. For this purpose the table (§ 316) has been prepared. If one gives the information called for in this table, whether the result is successful or not, one can after a time work with great exactness, for the elements of success and failure will stand out clearly in the table.

§ 277. Labeling Negatives.—After a negative is dry the labeling can be done on the gelatin side with carbon ink. Enough data should be given to enable the certain identification of the negative at any future time.

§ 278. Storing Negatives.—This is satisfactorily done by putting each into an envelope and writing a duplicate label on the upper edge, and then the negatives may be placed in drawers in

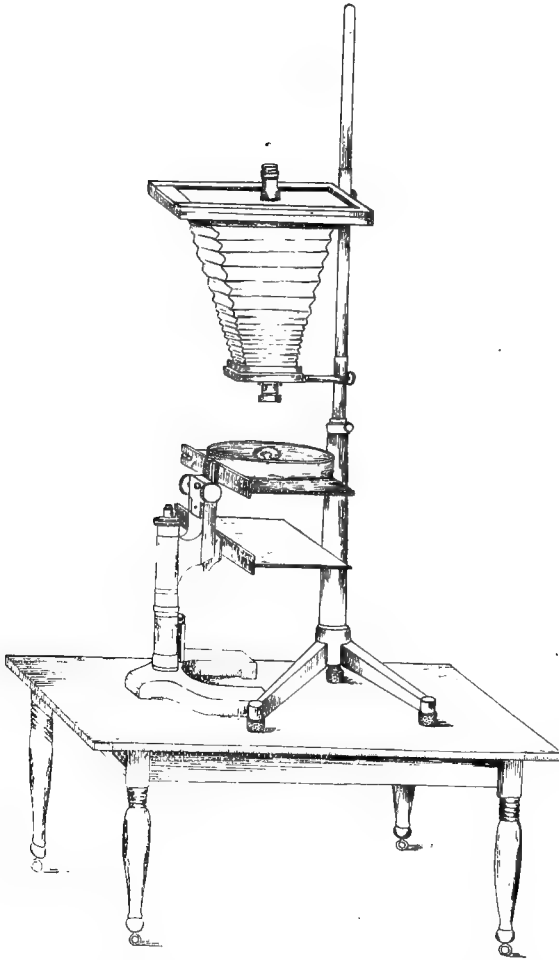

FIG. 165. *Vertical Camera and special microscope stand for photographing embryos and other small specimens in liquids and for photographing large sections. The camera rests on a low table and the operator can stand on the floor while performing all the manipulations.*

The stage of the microscope is attached to the arm in the place of the tube. This stage has two stories. The specimen is shown on the upper and the background on the lower story. In focusing, the coarse and fine adjustment of the special microscope stand are used. The extension of the camera for a definite size of picture is discussed in § 273.

alphabetical order as are the catalog cards of books in a library. One can then find any negative with the same facility that the title of a book can be found in a card catalog.

PHOTOGRAPHING EMBRYOS

For photographing embryos and many other small specimens it is more convenient to use a smaller apparatus than the vertical camera just described. It is necessary also to have a more delicate method of focusing.

§ 279. **Camera for Embryos.**—This is a vertical camera for photographing with the microscope, and with a photographic objective in the end of the camera as for an ordinary camera. This is readily accomplished by having a society screw adapter, and also adapters for the micro-planars or other objectives which one desires to use. The magnification usually required varies from natural size ($\times 1$) to five times natural size ($\times 5$) up to $\times 20$. As with the large camera the position of the ground glass for each magnification and for each objective is determined once for all by using a scale in millimeters. The various positions are accurately noted, then one can set the camera almost instantly for the desired magnification. The supporting rod is divided to half centimeters and therefore the exact position is easily recorded (Fig. 172).

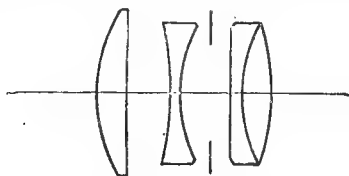

FIG. 166. *Diagram of the general construction of the Micro-Tessar objectives of the Bausch & Lomb Optical Co.*

§ 280. **Special Microscope Stand.**—For the accurate focusing necessary for embryos one should possess a special microscope stand with the stage in two stories and attached to the arm in place of the tube of the microscope. The stage proper is absent. This arrangement of the stage permits the use of the coarse and fine adjustment of the microscope to be used for focusing. The position of the camera on a low table (45 to 50 cm. high) makes it possible for the operator to stand on the floor while making all the adjustments of the embryo and for focusing; and all the parts are within reach (Fig. 165).

§ 281. **Arranging the Embryos.**—As usually prepared the embryos are white and therefore require a dark background. This may be attained either by placing the embryos in a dark dish or on some paper blackened with water-proof India ink, or by putting them in a glass vessel like a Petri dish with a piece of black velveteen on the stage below. Black glass on the bottom of the dish containing the embryos etc., forms one of the best dark backgrounds. The specimens will of course be in a liquid, usually alcohol.

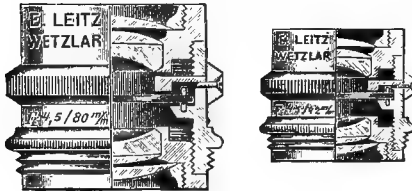

FIG. 167-178. *Leitz Microsummar Objectives of 64 and 42 mm. focus. (Cuts from Leitz Photomicrographic catalog).*

If several embryos are to be taken at once, they are arranged in rows something as the words on a line. Arrange them in even vertical as well as horizontal rows so that when the print is made it will be easy to cut them apart. When the embryos are arranged, one should be certain that the light brings out the details most desired. For example, if one is photographing an embryo which shows the branchial pockets well, great pains should be taken to so arrange the embryo with reference to the light that the proper shading will be given to bring out the gill pockets most emphatically. One can learn to do this only by practice. It is advantageous to have an assistant, then while the operator is looking into the camera the assistant can turn the embryo in various directions until the appearance is most satisfactory.

§ 282. **Focusing.**—For getting a general focus, and for the general arrangement the ground glass screen is used, but for the final focusing it is desirable to use a focusing glass.

The tripod microscope answers fairly well for a focusing glass, but several are now made with much more perfect corrections and for photo-micrography it is desirable to have as good apparatus as can be obtained. For using the focusing glass one may have a clear glass screen and set the focusing glass upon it. There should be a diamond cross in the middle of the screen on the under side where the ground surface usually is and this surface of the glass like that

of the ground surface must be exactly at the level where the sensitive film of the plate is in taking the picture. Focus the focusing glass accurately upon the diamond scratch and fix the glass so that it will remain at exactly that distance from the diamond scratch. Then when an object is to be focused if the image is perfectly sharp under the focusing glass its real image will be at the proper level for taking the picture.

A still more satisfactory method for the final focusing is to have one of the better forms of focusing glass mounted in a board screen, then one looks at the aerial image formed by the objective exactly as in looking into a microscope. One must take especial pains in setting the focusing glass in the board screen so that the real image will be at the right level. One can do this by placing a ground glass in the plate holder and putting it in position on the camera and then focusing some printed letters as sharply as possible. This will get the real image at exactly the right level for the plate holder to be used in making the picture. Then the board screen with the focusing glass is put in place of the plate holder and the focusing glass moved up and down until the image is as sharp as possible. The focusing glass is then fixed in position, and any object focused with it should be equally in focus on the sensitive film for making the picture.

This method has the great advantage that there is nothing between the focusing glass and the aerial image, and one can focus as easily and certainly in this way as with a compound microscope. For this final focusing it is better to have the diaphragm opening as it is to be in taking the picture, although for getting the general focus and arranging the object when the ground glass is in position the full opening of the objective may be used for the greater illumination.

§ 283. **Exposure.**—In daylight with white embryos and a dark ground 30 to 40 seconds is usually sufficient exposure. One must learn this also by trial and it facilitates the obtaining of exact data to make a record of every negative made, whether the negative is good or bad. A table is given in § 316 to facilitate the record taking. In a short time one can learn to make the correct exposure. If the result is unsatisfactory, try again. The rule adhered to by all first rate workers is to stick to it until the result is satisfactory.

§ 284. **Records of Embryos.**—Each specimen or group of

specimens will have its own label giving date and method of preparation. It is an advantage to write this label with water-proof carbon ink, then one can put the label in the dish with the embryos and it will form a part of the picture and serve as a record.

After the picture is satisfactorily made it is wise to number the embryos on the back of the negative with a wax crayon, and later when the negative is dry number on the front with carbon ink. The embryos are placed in separate bottles each with a copy of the original label and the number corresponding with that put on the negative. This is easily accomplished if the embryos are arranged in definite rows as advised in § 281.

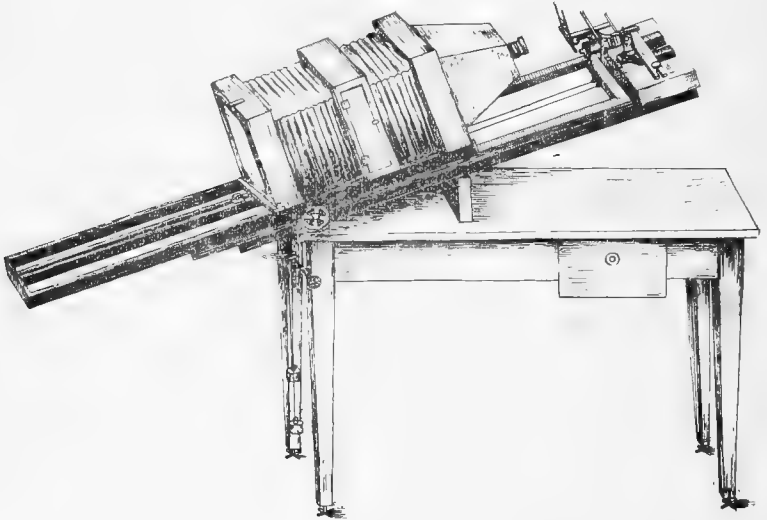

FIG. 169. Camera and special microscope stand for photographing large transparent sections. For this the vertical camera is used (Fig. 161) with the camera reversed on the sliding frame. This frame is elevated sufficiently to utilize the sky as background and illuminant. The special microscope stand is inclined to the horizontal and placed on the fixed frame supporting the camera; the specimen placed on the stage. For objective one of those objectives shown in Figs. 162, 166-168 is used. The objective is screwed into an adapter in place of the ordinary photographic objective. The focusing is performed roughly by the rack and pinion, and then with great exactness with the focusing glass. For manipulating the fine adjustment of the special microscope the well known device of a cord over the head of the micrometer screw is used. (See also Fig. 165.) (Trans. Amer. Micr. Soc., 1901.)

Finally when the embryo is cut into serial sections and mounted, a picture of the whole embryo should accompany the series.

§ 285. **Size of the Pictures.**—For all embryos it is well to make one picture natural size ($\times 1$) and then for the smallest ones a magnification of at least five times natural size ($\times 5$). Here, as with the magnification of the microscope, linear magnification is always meant (§ 170, 171).

§ 286. **Objectives.**—For making pictures from one to five times natural size objectives of 60 to 100 mm. focus answer well (Figs. 166-167). Short focus (75 to 100 mm. equivalent focus), wide angle photographic objectives are also admirable for this work.

§ 287. **Record of Negatives.**—As indicated in § 276-278 each negative should have a record, see record blank (§ 316). On the negative itself should be also written the main facts with carbon ink. The name and magnification, date and any other details which may be thought desirable can be put on the envelope containing the negative and then stored like a catalog card as described above (§ 278).

§ 288. **Photographing Large Transparent Objects.**—There are many large transparent objects which it is desirable to photograph, *e. g.*, chick embryos mounted whole, large sections of organs like the brain, etc. These must be photographed at a low magnification.

Successful photographs require an even lighting and an objective which has sufficient field to take in the whole object. The camera used for embryos (Fig. 182) may be used in connection with the projection microscope condenser. For very large objects or for large pictures the vertical camera (Figs. 161, 169) is reversed in position on the supporting frames, and elevated only sufficiently to make a sky back-ground; or a 45 degree reflector of white cloth or paper of sufficient size must be used for a horizontal camera. If one has the earth for back-ground the light will be dull and uneven and a very long exposure is necessary, and the final results unsatisfactory.

§ 289. **Use of the Special Microscope Stand.**—In order to hold the specimen in position and to focus it accurately, it is put on the stage of the special microscope stand (Fig. 165), which is

inclined, and fastened to the fixed part of the frame supporting the camera. As the stage of this microscope is moved by the coarse or the fine adjustment, the focusing can be accomplished with the same accuracy as the microscope itself. For the general arrangement of the specimen and the rough focusing the ground glass is used, then this is replaced by a clear-glass focusing screen, and by the aid of a focusing glass the specimen is put in perfect focus. (See also § 282.) As one cannot reach the fine adjustment while focusing, the well known device of a cord over the head of the micrometer screw is resorted to. The two ends of the cord should be weighted with about 50 or a hundred grams to keep the cord taut, then whichever one is pulled, the micrometer screw will respond at once. To cut off the light a piece of black velveteen is hung over the end of the objective. This can be removed without jarring the apparatus. An exposure of a few seconds (3 to 10 seconds), will suffice for many preparations, unless a color screen is used. The color screen increases the time of exposure (§ 291).

COLOR-CORRECT PHOTOGRAPHY

From the fact that the different wave lengths of light affect the photographic plate with different degrees of vigor, the ordinary photographic print of many-colored objects or landscapes is not satisfactory. All objects whose light is of short wave lengths, as blue, etc., will appear too light and those with greater wave lengths as red, yellow and green will be too dark relatively. To obviate this difficulty two methods have been adopted, and for the most complete success they must be combined.

(A) The use of ortho- or iso-chromatic plates and (B) the use of a color screen or light filter.

‡ 290. **Orthochromatic or Isochromatic Plates.**—These are plates which have been rendered much more sensitive than ordinary plates to the long waves of red, orange, yellow and green, they therefore give a much more natural rendering to many-colored objects than ordinary plates. While color-sensitizing has been carried to a considerable stage of perfection and there is a large choice of plates now on the market for special purposes, it should be remembered that no matter for what color or colors a plate has been sensitized *it remains more sensitive to the short waves (violet end of spectrum) than to the long waves (red end of spectrum)*. Therefore to obtain a correct rendering of variously colored objects by photography, a color screen is necessary as well as a color sensitive plate (§ 291).

These color-correct plates are not very enduring, and must be used while they are fresh, or only weak, foggy negatives will result; and as they are sensitive to orange, etc., one must be very careful in exposing them in the dark

room even to the light of the developing lantern. The more nearly the plate can be kept from all the light, except that acting during the exposure in the camera, the more satisfactory will be the resulting negative.

§ 291. Requirements for Successful Photo-Micrography.—Successful visual images may be obtained in two ways, (§ § 118-119, 157-159), viz: by mounting the object in a medium whose refractive index differs markedly from the object; or by staining the object so that it has a markedly different color from the mounting medium. When the two methods are combined and the object differs both in refractive index and in color from the mounting medium the visual images obtained through the microscope are most satisfactory.

In photography the difference in refractive index between object and surrounding medium is of the same importance as for ordinary observation, and as with the eye, the greater the difference the bolder the outline (§ 157). But difference in color of object and mounting medium does not ensure a good photographic image. This is because the wave lengths of light producing the different colors are not all equally effective in producing a photograph. The visually brilliant long waves of red, orange, yellow and green are far less effective in producing a picture than the shorter waves of blue, indigo and violet. In a word the end of the spectrum brightest to the eye is least effective for producing a photograph, *i.e.* the sensitiveness of the eye and the photographic plate are inverted or complementary.

As stated above (§ 290) color sensitized plates have been produced to meet a part of the difficulty. To further perfect the photographic image and make it correspond more closely with the light effects of the visual image, color-screens or filters have been devised whereby the light transmitted by the specimen is partly or wholly eliminated from the light illuminating it. If the color screen wholly eliminates the light which the object transmits then of course its color to the eye is eliminated and the object appears black, no matter how brilliant the illumination. It is also black to the photographic plate, and shows as a black object in the picture.

The dyes used in staining microscopic preparations differ not only in the wave length of light they allow to pass through the object, but they also differ in the amount of opacity to all light which they give to the specimen. This is a valuable feature for photography. For example hematoxylin transmits much actinic light, but it also renders the object more or less opaque to all light and hence specimens well stained in hematoxylin usually give good photographs. Carmine stained specimens also give good photographs because they are rendered slightly opaque to all light, but principally because the red stain is especially opaque to the short waves. If one could select stains for all objects which would greatly lessen the passage of all light, the amount cut out depending on the density of the specimen in different parts, and also eliminate the greater number of the short waves, it would be easy to produce good photo-micrographs. Where stains with the above qualities cannot be employed it is necessary not only to use isochromatic plates but a proper color-screen.

§ 292. Color Screens.—For the intelligent use of color-screens it must be borne in mind that colored objects appear colored to the eye because they

transmit certain wave lengths of light and absorb others. If the color is a pure orange for example all the other colors of the spectrum have been absorbed by the object (§ 214-217). Usually, however a greater or less number of waves of other colors are transmitted also.

If one wishes to get the greatest possible contrast in photographing an object stained with pure orange a color screen is used transmitting all the other colors except orange. Then as the object can transmit only orange light it absorbs all the light sent to it while on all sides of the object light of all the other wave lengths will reach the photographic plate and affect it, hence in the photograph the orange object appears black in a light field.

Although objects seen in the microscope may appear of a certain color they usually transmit also wave lengths of other colors so that there is a certain amount of detail shown in the picture due to the different amounts of effective light waves which are transmitted in different parts depending upon the varying density of the object.

Where there is no detail as with many bacteria, the blacker the object appears in the picture the better, hence in such cases a monochromatic color screen complementary to the color transmitted by the bacteria or other objects would give the most satisfactory results.

Proper choice of a color filter is greatly aided by studying the object to be photographed with a micro-spectroscope to see what wave lengths and the proportion of each are actually transmitted by the specimen. Then if one studies the color-screens available he will be able to select the one most nearly complementary to the object to be photographed. As stated above, it is desirable in histologic preparations with structural detail to show such detail. This is partly determined by the different refractive index of the different parts, and it can be greatly accentuated by selecting a color screen which eliminates the excess of the short waves from the light. For many objects stained with dyes giving strong contrast etc. as hematoxylin and carmine, good pictures may be obtained without a color screen if isochromatic plates are employed and a kerosene lamp is used for illumination. The kerosene light is very rich in the waves near the middle of the spectrum, but rather poor in the short waves.

§ 293. *Composition and Preparation of Color Screens.*—In recent years as the principles for the proper selection and use of color screens have become more fully understood the range has been greatly increased of the appropriate color-sensitive plates. While color screens of solutions are still used, perhaps the majority of screens now employed are made of variously colored glass or of glass coated with variously stained gelatin or collodion.

By recalling the work with the spectroscope (§ 217), it will be remembered that the light transmitted through a colored object depends upon the thickness of the object and also upon the intensity of the illumination. This being true the same color screen may be made to give greater or less contrast in the photograph by varying the intensity of the illumination. If one studies the spectrum of solutions of the various dyes used in microscopy, like aurantia, methyl green, etc., he can select colors for his color screen which give contrast for the specimens he has to photograph, remembering always

that the screen should cut out much of the blue end of the spectrum and also the special color transmitted by the object.

Alcoholic solutions of the dye chosen may then be used to stain collodion (see Ch. IX) or either alcoholic or aqueous solutions may be used for staining glass plates coated with 20% to 30% gelatin.

‡ 294. Position and Exposure with Color-Screens.—It does not make much difference where the color screen is placed provided no light reaches the plate which has not passed through it. The most convenient position is between the source of light and the object. If one uses a glass screen or screens of stained collodion or gelatin on glass, the most convenient position is in the holder for the central stop diaphragms just under the condenser.

The length of exposure required when color screens are used is ordinarily considerably increased. For color sensitive plates the increase is greatly lessened if screen and plate are mutually adapted.

PHOTOGRAPHING WITH A MICROSCOPE*

‡ 295. The first pictures made on white paper and white leather, sensitized by silver nitrate, were made by the aid of a solar microscope (1802). The pictures were made by Wedgwood and Davy, and Davy says: "I have found that images of small objects produced by means of the solar microscope may be copied without difficulty on prepared paper."†

*Considerable confusion exists as to the proper nomenclature of photography with the microscope. In German and French the term micro-photography is very common, while in English photo-micrography and micro-photography mean different things. Thus: A *photo-micrograph* is a photograph of a small or microscopic object usually made with a microscope and of sufficient size for observation with the unaided eye; while a *micro-photograph* is a small or microscopic photograph of an object, usually a large object, like a man or woman and is designed to be looked at with a microscope.

Dr. A. C. Mercer, in an article in the Proc. Amer. Micr. Soc., 1886, p. 131, says that Mr. George Shadbolt made this distinction. See the Liverpool and Manchester *Photographic Journal* (now *British Journal of Photography*), Aug. 15, 1858, p. 203; also Sutton's Photographic Notes, Vol. III, 1858, pp. 205-208. On p. 208 of the last, Shadbolt's word "Photomicrography" appears. Dr. Mercer puts the case very neatly as follows: "A *Photo-Micrograph* is a *macroscopic* photograph of a *microscopic* object; a *micro-photograph* is a *microscopic* photograph of a *macroscopic* object. See also *Medical News*, Jan. 27, 1894, p. 108.

† In a most interesting paper by A. C. Mercer on "The Indebtedness of Photography to Microscopy," *Photographic Times Almanac*, 1887, it is shown that: "To briefly recapitulate, photography is apparently somewhat indebted to microscopy for the first fleeting pictures of Wedgwood and Davy [1802], the first methods of producing permanent paper prints [Reede, 1837-1839], the first offering of prints for sale, the first plates engraved after photographs

Thus among the very first of the experiments in photography the microscope was called into requisition. And naturally plants and motionless objects were photographed in the beginnings of the art when the time of exposure required was very great.

At the present time photography is used to an almost inconceivable degree in all the arts and sciences and in pure art. Even astronomy finds it of the greatest assistance.

It has also accomplished marvels in the production of colored plates for book illustrations, especially in natural history. For an example see Comstock's *Insect Life*, 2d edition.

Although first in the field, Photo-Micrography has been least successful of the branches of photography. This is due to several causes. In the first place, microscopic objectives have been naturally constructed to give the clearest image to the eye, that is the visual image as it is sometimes called, is for microscopic observation, of prime importance. The actinic or photographic image, on the other hand, is of prime importance for photography. For the majority of microscopic objects transmitted light (§ 73) must be used, not reflected light as in ordinary vision. Finally, from the shortness of focus and the smallness of the lenses, the proper illumination of the object is accomplished with some difficulty, and the fact of the lack of sharpness over the whole field with any but the lower powers, have combined to make photo-micrography less successful than ordinary macro-photography. So tireless, however, have been the efforts of those who believed in the ultimate success of photo-micrography, that now the ordinary achromatic objectives with ortho-chromatic or isochromatic plates and a color screen or petroleum light give good results, while the apochromatic objectives with projection oculars give excellent results, even in hands not especially skilled. The problem of illumination has also been solved by the construction of achromatic and apochromatic condensers and by the electric and other powerful lights now available. There still remains the difficulty of transmitted light and of so preparing the object that structural details stand out with sufficient clearness to make a picture which approaches in definiteness the drawing of a skilled artist.

The writer would advise all who wish to undertake photo-micrography seriously, to study samples of the best work that has been produced. Among those who showed the possibilities of photo-micrographs was Col. Woodward of the U. S. Army Medical Museum. The photo-micrographs made by him and exhibited at the Centennial Celebration at Philadelphia in 1876, serve still as models, and no one could do better than to study them and try to equal them in clearness and general excellence. According to the writer's observation no photo-micrographs of histologic objects have ever exceeded those

for the purpose of book illustration [Donné & Foucault, 1845], the photographic use of collodion [Archer & Diamond, 1851], and finally, wholly indebted for the origin of the gelatino-bromide process, greatest achievement of them all [Dr. R. L. Maddox, 1871]. See further for the history of Photo-micrography, Neuhauss, also Bousfield.

made by Woodward, and most of them are vastly inferior. It is gratifying to state, however, that at the present time many original papers are partly or wholly illustrated by photo-micrographs, and no country has produced works with photo-micrographic illustrations superior to those in "Wilson's Atlas of Fertilization and Karyokinesis" and "Starr's Atlas of Nerve Cells," issued by the Columbia University Press.—

In passing the writer would like to pay a tribute to Mr. W. H. Walmsley who has labored in advancing photo-micrography for the last twenty years. His convenient apparatus and abundant experience have been placed freely at the command of every interested worker, and many a beginner has been helped over difficulties by him. His last contribution in "International Clinics," vol. i. ser. 11, 12, is encouraging in the highest degree both for its matter and for the illustrations.

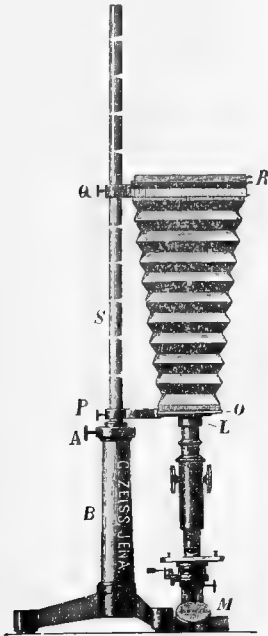

FIG. 170. Zeiss' Vertical Photo-micrographic Camera. A. Set screw holding the rod (S) in any desired position. P. Q. Set screws by which the bellows are held in place. B. Stand with tripod base in which the supporting rod (S) is held. This rod is now graduated in centimeters and is a ready means of determining the length of the camera. M. Mirror of the microscope. L. The sleeve serving to make a light-tight connection between the camera and microscope. O. The lower end of the camera. R. The upper end of the camera where the focusing screen and plate holder are situated. (From Zeiss' Photo-micrographic Catalog.)

As the difficulties of photo-micrography are so much greater than of ordinary photography, the advice is almost universal that no one should try to learn photography and photo-micrography at the same time, but that one should learn the processes of photography by making portraits, landscapes, copying drawings, etc., and then when the principles are learned one can take up the more difficult subject of photo-micrography with some hope of success.

The advice of Sternberg is so pertinent and judicious that it is reproduced :

“Those who have had no experience in making photo-micrographs are apt to expect too much and to underestimate the technical difficulties. Objects which under the microscope give a beautiful picture, which we desire to reproduce by photography may be entirely unsuited for the purpose. In photographing with high powers it is necessary that the objects to be photographed be in a single plane and not crowded together and overlying each other. For this reason photographing bacteria in sections presents special difficulties and satisfactory results can only be obtained when the sections are extremely thin and the bacteria well stained. Even with the best preparations of this kind much care must be taken in selecting a field for photography. It must be remembered that the expert microscopist, in examining a section with high powers, has his finger on the fine adjustment screw and focuses up and down to bring different planes into view. He is in the habit of fixing his attention on the part of the field which is in focus and discarding the rest. But in a photograph the part of the field not in focus appears in a prominent way which mars the beauty of the picture.”

APPARATUS FOR PHOTO-MICROGRAPHY

§ 296. *Camera*.—For the best results with the least expenditure of time one of the cameras especially designed for photo-micrography is desirable but is not by any means indispensable for doing good work. An ordinary photographic camera, especially the kind known as a copying camera, will enable one to get good results, but the trouble is increased, and the difficulties are so great at best, that one would do well to avoid as many as possible and have as good an outfit as can be afforded (Fig. 170).

The first thing to do is to test the camera for the coincidence of the plane occupied by the sensitive plate and the ground glass or focusing screen. Cameras even from the best makers are not always correctly adjusted. By using a straight edge of some kind, one can measure the distance from the inside or ground side of the focusing screen to the surface of the frame. This should be done all around to see if the focusing screen is equally distant at all points from the surface of the frame. If it is not it should be made so. When the focusing screen has been examined, an old plate, but one that is perfectly flat, should be put into the plate holder and the slide pulled out and the distance from the surface of the plate holder determined exactly as for the focusing screen. If the distance is not the same the position of the focusing screen must be changed to correspond with that of the glass in the plate holder, for unless the sensitive surface occupies exactly the position of the focusing screen the picture will not be sharp, no matter how accurately one may focus. Indeed, so necessary is the coincidence of the plane of the focusing screen and sensitive surface that some photo-micrographers put the focusing screen in the plate holder, focus the image and then put the sensitive plate in the holder and make the exposure (Cox). This would be possible with the older forms of plate holders, but not with the double plate holders mostly used at the present day.

§ 297. **Size of Camera.**—The majority of photo-micrographs do not exceed 8 centimeters in diameter and are made on plates 8x11, 10x13 or 13x18 centimeters ($3\frac{1}{4}\times 4\frac{1}{4}$ in., 4x5 in., or 5x7 in.). Most of the vertical cameras are for plates not exceeding 10x13 centimeters (4x5 in.) but Zeiss' new form will take plates 21x21 centimeters ($8\frac{1}{4}\times 8\frac{1}{4}$ in.).

§ 298. **Work Room.**—It is almost self-evident that the camera must be in some place free from vibration. A basement room where the camera table may rest directly on the cement floor or on a pier is excellent. Such a place is almost necessary for the best work with high powers. For those living in cities, a time must also be chosen when there are no heavy vehicles moving in the streets. For less difficult work an ordinary room in a quiet part of the house or laboratory building will suffice.

§ 299. **Arrangement and Position of the Camera and the Microscope.**—For much photo-micrography a vertical camera and microscope are to be preferred (Fig. 170). Excellent arrangements were perfected long ago, especially by the French. (See Moitessier.)

Vertical photo-micrographic cameras are now commonly made, and by some firms only vertical cameras are produced. They are exceedingly convenient, and do not require so great a disarrangement of the microscope to make the picture as do the horizontal ones. The variation in size of the picture in this case is mostly obtained by the objective and the projection ocular rather than by length of bellows (see below Fig. 170). It must not be forgotten, however, that penetration varies inversely as the *square* of the power, and only inversely as the numerical aperture (§ 40), consequently there is a real advantage in using a low power of great aperture and a long bellows rather than an objective of higher power with a short bellows. A horizontal camera is more convenient for use with the electric light also (Fig. 180).

For convenience and rapidity of work a microscope with mechanical stage is desirable. It is also an advantage to have a tube of large diameter so that the field will not be too greatly restricted (Fig. 176). In some microscopes the tube is removable almost to the nose-piece to avoid interfering with the size of the image. The substage condenser should be movable on a rack and pinion. The microscope should have a flexible pillar for work in a horizontal position. While it is desirable in all cases to have the best and most convenient apparatus that is made, it is not by any means necessary for the production of excellent work. A simple stand with flexible pillar and good fine adjustment will answer.

§ 300. **Objectives and Oculars for Photo-Micrography.**—The belief is almost universal that the apochromatic objectives are most satisfactory for photography. They are employed for this purpose with a special projection ocular. Two low powers are used without any ocular (Fig. 183). Some of the best work that has ever been done, however, was done with achromatic objectives (work of Woodward and others). One need not desist from undertaking photo-micrography if he has good achromatic objectives. From a somewhat extended series of experiments with the objectives of many makers the good

modern achromatic objectives were found to give excellent results when used without an ocular. Most of them also gave good results with projection oculars. It must be said however, that the best results were obtained with the apochromatic objectives and projection oculars. It does not seem to require

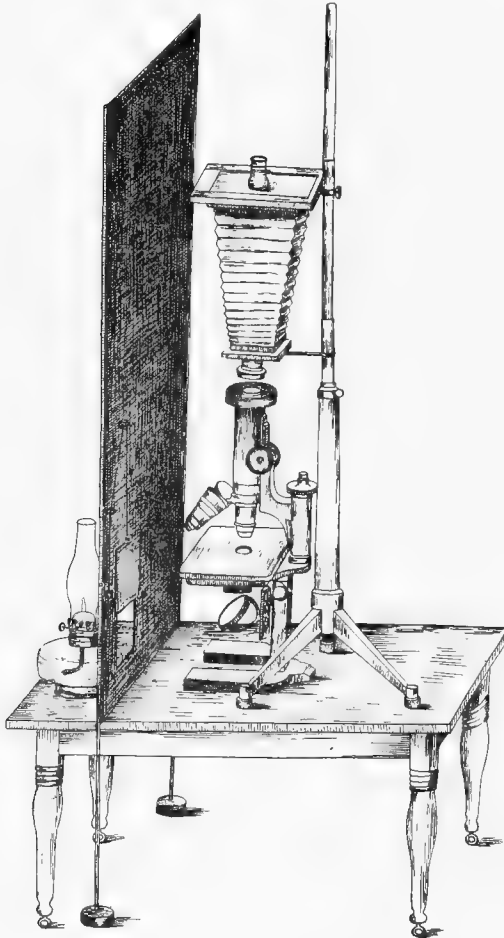

FIG. 171.—*Vertical photo-micrographic camera, screen and small table* The table is about 45 centimeters high and in the legs are large screw eyes for leveling screws. The operator can stand on the floor and perform all the necessary operations, and in adjusting the microscope can sit on a low stool.

The screen is of zinc and has two heavy lead feet to hold it steady. Near the lower left hand corner of the screen is an aperture for the light to shine through upon the mirror. This opening is closed by a black slide which is just balanced so that it stays in any position. In making the exposure it is raised sufficiently to admit the light to the mirror, but the stage is left in shadow. This screen shades the microscope and the face of the operator. (*Trans. Amer. Mic. Soc. 1901.*)

so much skill to get good results with apochromatics as with achromatic objectives. The majority of photo-micrographers do not use the Huygenian oculars in photography, although excellent results have been obtained with them. An amplifier is sometimes used in place of an ocular. Considerable experience is necessary in getting the proper mutual position of objective and

amplifier. The introduction of oculars especially designed for projection, has led to the discarding of ordinary oculars and of amplifiers. Oculars restrict the field very greatly, hence the necessity of using the objective alone for large specimens.*

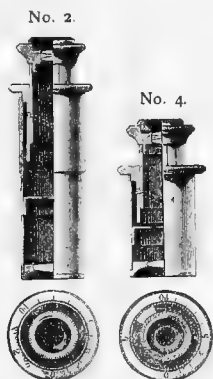

FIG. 172. *Projection Oculars with section removed to show the construction. Below are shown the upper end with graduated circle to indicate the amount of rotation found necessary to focus the diaphragm on the screen. No. 2, No. 4. The numbers indicate the amount the ocular magnifies the image formed by the objective as with the compensation oculars, (Zeiss' Catalog.)*

§ 301. **Difference of Visual and Actinic Foci.**—Formerly there was much difficulty experienced in photo-micrographing on account of the difference in actinic and visual foci. Modern objectives are less faulty in this respect and the apochromatics are practically free from it. Since the introduction of orthochromatic or isochromatic plates and, in many cases the use of colored screens, but little trouble has arisen from differences in the foci. This is especially true when mono-chromatic light and even when petroleum light is used. In case an objective has its visual and actinic foci at markedly different levels it would be better to discard it for photography altogether, for the estimation of the proper position of the sensitive plate after focusing is only guess work and the result is mere chance. If sharp pictures cannot be obtained with an objective when petroleum light and orthochromatic plates are used the fault may not rest with the objective but with the plate holder and focusing screen. They should be very carefully tested to see if there is coincidence in position of the focusing screen and the sensitive film as described in § 296.

§ 302. **Apparatus for Lighting.**—For low power work (35 mm. and longer focus) and for large objects, some form of bull's eye condenser is desirable although fairly good work may be done with diffused light or lamp-light reflected by a mirror. If a bull's eye is used it should be as nearly achromatic as possible. The engraving glass shown in Fig. 175 answers well for large

*A comparative study both with projection oculars, and without an ocular was made with the achromatic objective 25 mm. (1 inch), 18 mm. ($\frac{3}{4}$ inch), 5 mm. ($\frac{1}{2}$ to $\frac{1}{8}$ inch) and 2 mm. ($\frac{1}{16}$ inch) homogeneous immersion of the Bausch & Lomb Optical Co.; Gundlach Optical Co.; Leitz; Reichert; Winkel, Zeiss and the Spencer Lens Co. Good results were obtained with all of these objectives both with and without projection oculars.

objects. For smaller objects a Steinheil lens combination gives a more brilliant light and one also more nearly achromatic. For high power work all are agreed that nothing will take the place of an achromatic condenser. This may be simply an achromatic condenser, but preferably it should be an *apochromatic* condenser. Whatever the form of the condenser it should possess dia-

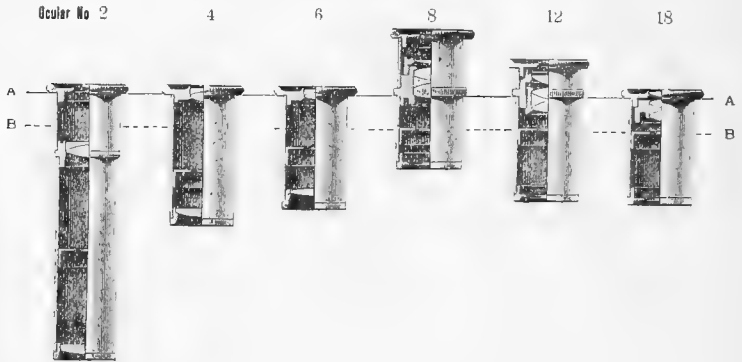

FIG. 173. *Compensation Oculars of Zeiss, with section removed to show the construction. The line A-A is at the level of the upper end of the tube of the microscope while B-B represents the lower focal points. Zeiss recommends the use of the compensation oculars if one desires a greater magnification than the projection oculars give.*

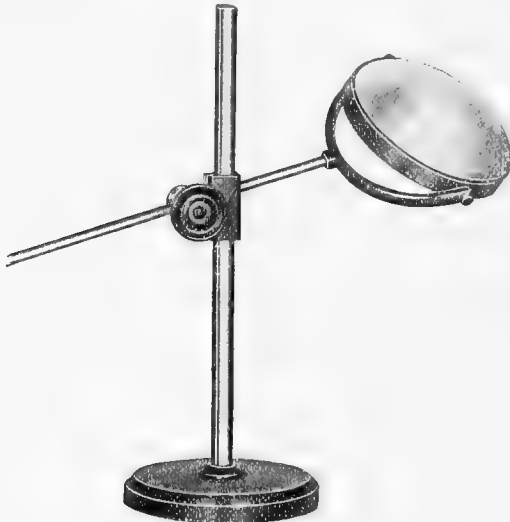

FIG. 174. *Bull's eye lens and holder. (Bausch & Lomb Opt. Co.)*

phragms so that the aperture of the condenser may be varied depending upon the aperture of the objective. For a long time objectives have been used as achromatic condensers, and they are very satisfactory, although less convenient than a special condenser whose aperture is great enough for the highest powers and capable of being reduced by means of diaphragms to the capacity of the lower objectives. It should also be capable of accurate centering. (§ 92).

§ 303. **Objects Suitable for Photo-micrographs.**—While almost any large object may be photographed well with the ordinary camera and photographic objective, only a small part of the objects mounted for microscopic study can be photo-micrographed satisfactorily. Many objects that can be clearly seen by constant focusing with the fine adjustment, appear almost without detail on the screen of the photo-micrographic camera and in the photo-micrograph.

FIG. 175. *Engraving glass to serve as a condenser and for a dissecting lens. (Bausch & Lomb Opt. Co.)*



If one examines a series of photo-micrographs the chances are that the greater number will be of diatoms, plant sections or preparations of insects. That is, they are of objects having sharp details and definite outlines, so that contrast and definiteness may be readily obtained (§ 107, 118, 157). Stained microbes also furnish favorable objects when mounted as cover-glass preparations, but these give color images (§ 107, 119) and require a color screen (§ 291).

For success with preparations of animal tissue they must approximate as nearly as possible to the conditions more easily obtained with vegetable preparations. That is, they must be made so thin and be so prepared that the cell outlines have something of the definiteness of vegetable tissue. It is useless to expect to get a clear photograph of a section in which the details are seen with difficulty when studying it under the microscope in the ordinary way.

Many sections which are unsatisfactory as wholes, may nevertheless have parts in which the structural details show with satisfactory clearness. In such a case the part of the section showing details satisfactorily should be surrounded by a delicate ring by means of a marker (see Figs. 70, 72). If one's preparations have been carefully studied and the special points in them thus indicated, they will be found far more valuable both for ordinary demonstration and for photography. The amount of time saved by marking one's specimens can hardly be overestimated. The most satisfactory material for making the rings is shellac colored with lampblack.

Ten years ago many histologic preparations could not be satisfactorily photographed. Now with improved section cutters, better staining and mounting methods, and with the color screens (§ 291) and isochromatic plates

(§ 290) almost any preparation which shows the elements clearly when looking into the microscope can be satisfactorily photographed. Good photographs cannot, however, be obtained from poor preparations.

§ 304. **Light.**—The strongest light is sunlight. That has the defect of not always being available, and of differing greatly in intensity from hour to hour, day to day and season to season. The sun does not shine in the evening when many workers find the only opportunity for work. Following the sunlight the electric light is the most intense of the available lights. Then come magnesium, acetylene, the lime light, the gas-glow or Wellsbach light and petroleum light. The last is excellent for the majority of low and moderate power work. And even for 2 mm. homogeneous immersion objectives, the time of exposure is not excessive for many specimens (40 seconds to 3 minutes). This light is cheap and easily obtained. It has the advantage of being somewhat yellow, and therefore in many cases makes the use of a color screen unnecessary if one uses isochromatic plates.

A lamp with flat wick about 40 mm. ($1\frac{3}{4}$ in.) wide has been found most generally serviceable. For large objects and low powers the flame may be made large and the face turned toward the mirror. This will light a large field. For high powers the edge toward the mirror gives an intense light. The ordinary glass chimney answers well, especially where a metal screen is used as shown in Fig. 171.

EXPERIMENTS IN PHOTO-MICROGRAPHY

§ 305. The following experiments are introduced to show practically just how one would proceed to make photo-micrographs with various powers, and be reasonably certain of fair success. If one consults prints or the published figures made directly from photo-micrographs it will be seen that, excepting diatoms and bacteria, the magnification ranges mostly between 10 and 150 diameters.

§ 306. **Focusing in Photo-Micrography.**—For rough focusing and as a guide for the proper arrangement of the object one uses a ground-glass screen as in gross photography. With the ground-glass screen one can judge of the brilliancy and evenness of the illumination more accurately than in any other way. For final and exact focusing two principal methods are employed :

(A). A focusing glass is used either with a clear screen or in a board screen as described above (§ 282). The latter method is like focusing with the compound microscope and a positive ocular. If the focusing glass is set properly the focus should be easily and accurately determined.

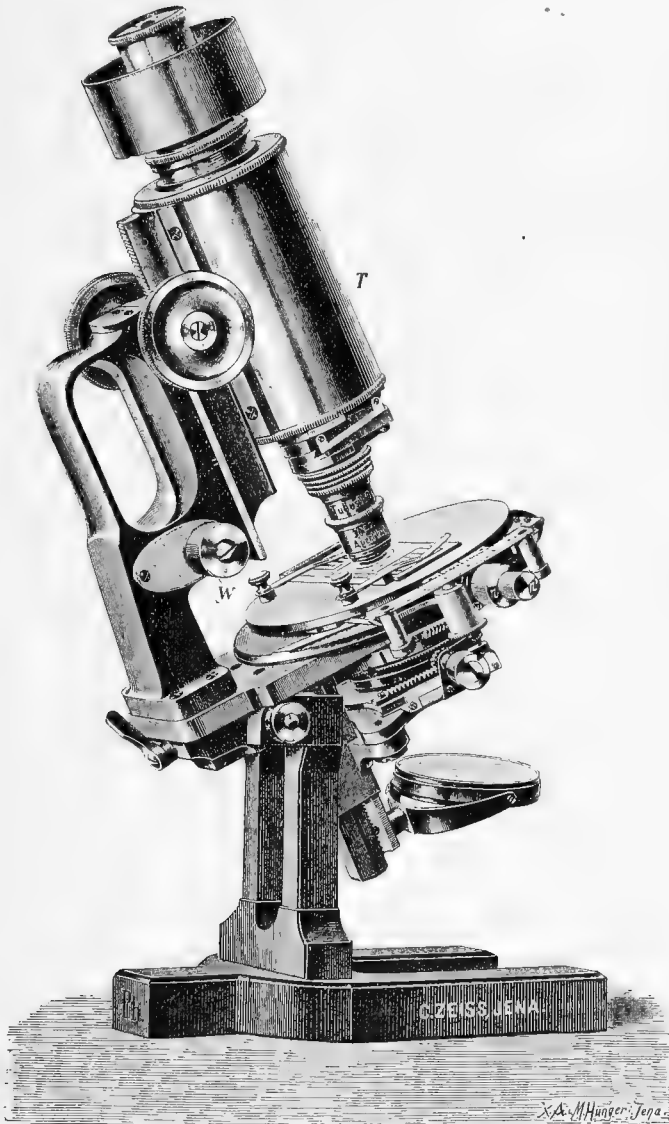

FIG. 176. Zeiss' special photo-micrographic stand. This is the parent form of photomicrographic stands with large tube (T), handle in the pillar and a special fine adjustment at the side (W). At the top is half of the light excluding sleeve. (Zeiss' Catalog).

(B). To enable the operator by looking directly into the microscope to focus correctly for any distance of the photographic plate (length of bellows), Foot and Strobell introduced the use of concave spectacle lenses ranging from—1 D to—10 D. (—1 to—10 diopters).

They have produced some of the best photo-micrographs of recent years by their method. (See for the full account, *Zeit. wiss. Mikroskopie*, Bd. 18, pp. 421-426; *Jour. Ap. Microscopy*, Vol. V. 1902, p. 2082).

In whatever way one focuses for photo-micrography a difficulty often appears. No matter how perfect the focus of the microscope the picture may be out of focus. This may be due to either of two things: (1) the focusing screen or focusing glass may not be in the right position to make the image sharp on the sensitive plate (§ 282, 296). (2) The microscope may get out of focus while the picture is being made. The reason for this change may be the gradual settling down of the tube of the microscope. This may be a fault of the fine or of the coarse adjustment. It is a good plan to focus the object carefully and after 10 or 15 minutes to see if the focus is still good. If the microscope will not stay in focus one cannot get a good picture. In that case it is necessary to study the apparatus and see which part of the mechanism is at fault.

§ 307. **Photo-micrographs of 20 to 50 Diameters.**—For pictures under 15 or 20 diameters it is better to use the camera for embryos with the objective in the end of the camera, and the special microscope stand for focusing (Fig. 165).

For pictures at 25 to 50 diameters one may use the microscope with a low objective, 25 to 35 mm. equivalent focus, and no ocular (Fig. 180). The object is placed on the stage of the microscope, and focused as in ordinary observation. If a vertical microscope is used the light from the petroleum lamp or other artificial light, is reflected upward by the mirror. It may take some time to get the whole field lighted evenly. Refer back to § 106 for directions. In some cases it may be advisable to discard the condenser and use the mirror only. For some purposes one will get a better light by placing the bull's eye or other condenser between the lamp and the mirror to make the rays parallel or even to make a sharp image of the lamp flame on the mirror. Remember also that in many cases it is necessary to have a color screen between the source of light and the object (§ 291).

For a horizontal camera it is frequently better to swing the mirror entirely out of the way and allow the light to enter the condenser directly or after traversing the bull's eye (Fig. 174). If the object is small an achromatic combination like a Steinheil magnifier or an engraving glass is excellent (Fig. 175). When the light is satisfactory as seen through an ordinary ocular, remove the ocular.

(A) *Photographing without an Ocular.*—After the removal of the ocular put in the end of the tube a lining of black velvet to avoid reflections. Connect the microscope with the camera, making a light-tight joint and focus the image on the focusing screen. One may make a light-tight connection by the use of black velveteen or more conveniently by the Zeiss' double metal hood which slips over the end of the tube of the microscope, and into which fits a metal cylinder on the lower end of the camera (Figs. 170, 176). In the first figure the connection has been made:

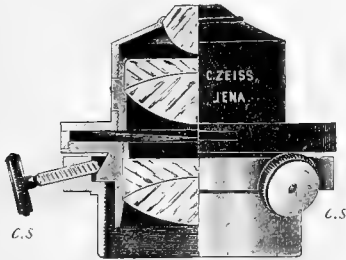

FIG. 177. Zeiss' Achromatic Condenser. *c. s. c. s.* Centering screws for changing the position of the condenser and making its axis continuous with that of the microscope. A segment of the condenser is cut away to show the combinations of lenses. For very low powers the upper lens is sometimes screwed off. There is an iris diaphragm between the middle and lower combinations. (Zeiss' Catalog.)

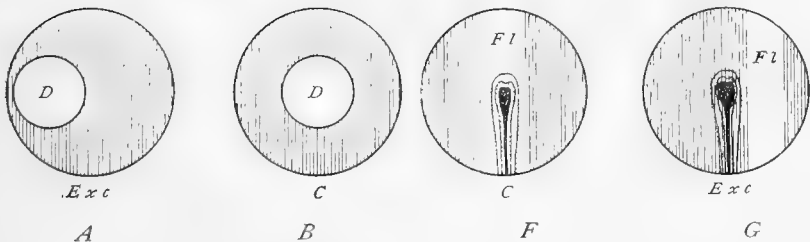

FIG. 178. A. Shows that the condenser is not centered. B. That it is centered. (D-D) Image of diaphragm formed by condenser.

F. G. Shows that the flame (Fl) illuminating the condenser is not central. In that case the lamp or the mirror must be changed in position until the image of the flame is exactly central. (See also ¶ 92-93.)

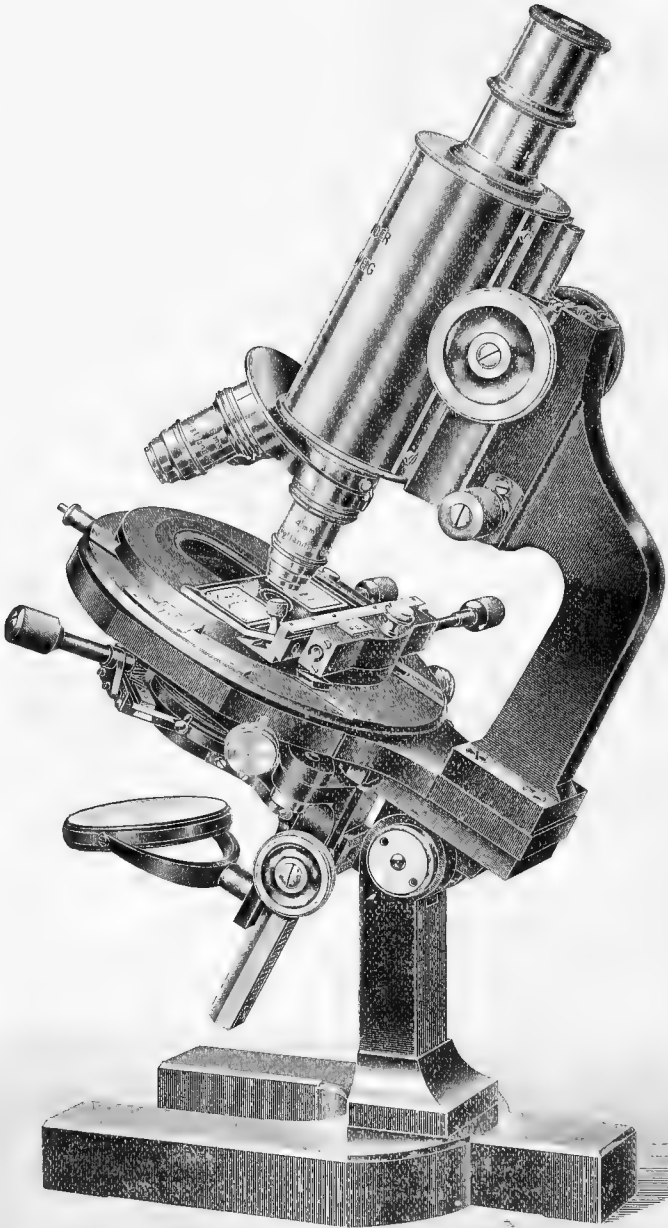

FIG. 179. *Microscope of Voigtländer & Sohn with large tube delicate fine adjustment and mechanical stage suitable for photo-micrography. See also Figs. 79, 84, 89, 95. (Cut loaned by Voigtländer & Sohn.)*

It will be necessary to focus down considerably to make the image clear. Lengthen or shorten the bellows to make the image of the desired size, then focus with the utmost care. In case the field is too much restricted on account of the tube of the microscope, remove the draw-tube. When all is in readiness it is well to wait for three to five minutes and then to see if the image is still sharply focused. If it has become out of focus simply by standing, a sharp picture could not be obtained. If it does not remain in focus, something is faulty. When the image remains sharp after focusing make the exposure. From 20 to 60 seconds will usually be sufficient time with medium plates and light as described. If a color screen is used it will require 50-300 seconds, *i. e.*, 2 to 5 times as long, for a proper exposure (§ 294).

B. *Photographing with a Projection Ocular.*—If the object is small enough to be included in the field of a projection ocular (Fig. 172) use that for making the negative as follows: Swing the camera around so that it will leave the microscope free. Use an ordinary ocular, focus and light the object, then insert a projection ocular in place of the ordinary one, and swing the camera back over the microscope. It is not necessary to use an ordinary ocular for the first focusing, but as its field is larger it is easier to find the part to be photographed. The first step is then to focus the diaphragm of the projection ocular sharply on the focusing screen. Bring the camera up close to the microscope and then screw out the eye-lens of the ocular a short distance. Observe the circle of light on the focusing screen to see if its edges are perfectly sharp. If not, continue to screw out the eye lens until it is. If it cannot be made sharp by screwing it out reverse the operation. Unless the edge of the light circle, *i. e.*, the diaphragm of the ocular, is sharp, the resulting picture will not be satisfactory.

It should be stated that for the $\times 2$ projection ocular the bellows of the camera must be extended about 30 or 40 centimeters or the diaphragm cannot be satisfactorily focused on the screen. The $\times 4$ projection ocular can be focused with the bellows much shorter. For either projection ocular the screen distance can be extended almost indefinitely.

When the diaphragm is sharply focused on the screen, the microscope is focused as though no ocular were present, that is, first with the unaided eye then with the focusing glass, The exposure

is also made in the same way, although one must have regard to the greater magnification produced by the projection ocular and increase the time accordingly ; thus when the $\times 4$ ocular is used, the time should be at least doubled over that when no ocular is employed. The time will be still further increased if a color screen is used (§ 294).

Zeiss recommends that when the bellows have sufficient length the lower projection oculars be used, but with a short bellows, the higher ones. It is also sometimes desirable to limit the size of the field by putting a smaller diaphragm over the eye lens. This also aids in making the field uniformly sharp.

§ 308. **Determination of the Magnification of the Photo-Micrograph.**—After a successful negative has been made, it is desirable and important to know the magnification. This is easily determined by removing the object and putting in its place a stage micrometer. If the distance between two or more of the lines of the image on the focusing screen is obtained with dividers and the distance measured on one of the steel rules, the magnification is found by dividing the size of the image by the known size of the object (§ 170). If now the length of the bellows from the tube of the microscope is noted, say on a record table like that in section 316, one can get a close approximation to the power at some other time by using the same optical combination and length of bellows.

For obtaining the magnification at which negatives are made it is a great advantage to have one micrometer in half millimeters ruled with coarse lines for use with the lower powers, and one in 0.1 and 0.01 millimeter ruled with fine lines for the higher powers.

§ 309. **Photo-Micrographs at a Magnification of 100 to 150 Diameters.**—For this, the simple arrangements given in the preceding section will answer, but the objectives must be of shorter focus, 8 to 3 mm. It is better, however, to use an achromatic condenser instead of the engraving glass or the Steinheil lens.

§ 310. **Lighting for Photo-Micrography with Moderate and High Powers.**—(100 to 2,500 diameters). No matter how good one's apparatus, successful photo-micrographs cannot be made unless the object to be photographed is properly illuminated. The beginner can do nothing better than to go over with the greatest care the directions for centering the condenser, for centering the

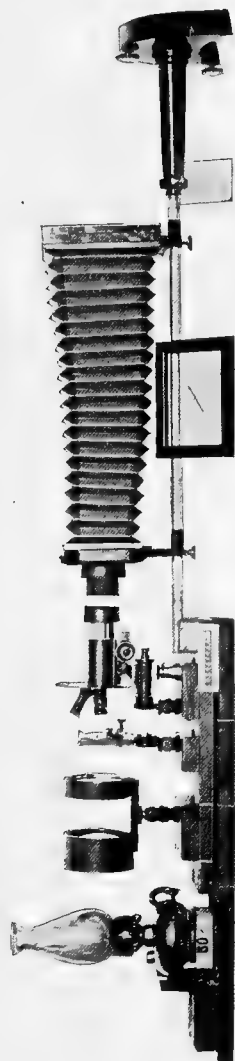

FIG. 180. *About 1-12 Nat. Size*

The projection apparatus (Fig. 160) with a petroleum lamp for radiant. This is used for photographing from 5 to 250 diameters. The advantage of the petroleum lamp is that the light is yellowish and therefore no color screen is necessary with isochromatic plates. It is also sufficiently rapid, requiring only from 5 to 50 seconds exposure. If the pictures one desires to make are to be magnified more than 250 diameters the vertical camera is more convenient, (Fig. 173). If the horizontal camera is employed for the higher powers the electric radiant is more satisfactory.

Objects 50 to 60 mm. in diameter may be fully illuminated with the face of the flame, the lamp flame being 5 to 7 centimeters from the condenser. For powers of 100 to 150 diameters the flame is turned obliquely or edgewise, and placed 5 to 10 centimeters from the condenser. The position shown in the picture above is for such high power work. No water bath or specimen cooler is needed. Compare Fig. 160.

As this camera is not jointed, the bellows have been reversed on the rod and the whole camera turned down to the horizontal position. A light tight connection is made with the large tube of the microscope by a double sleeve like that employed by Zeiss for the microscope. With low magnifications no ocular is used, and with the lowest the objective is placed in the end of the camera as in Fig. 165. If one desires to make pictures of a size above the capacity of the photographic camera it is possible to use the ordinary camera, (Fig. 161), then even quite large objects, 50 to 60 mm. long, can be magnified considerably. The petroleum lamp has some advantages over daylight as the lamp gives an illumination of constant intensity. It is available during the entire 24 hours of the day, and in all seasons.

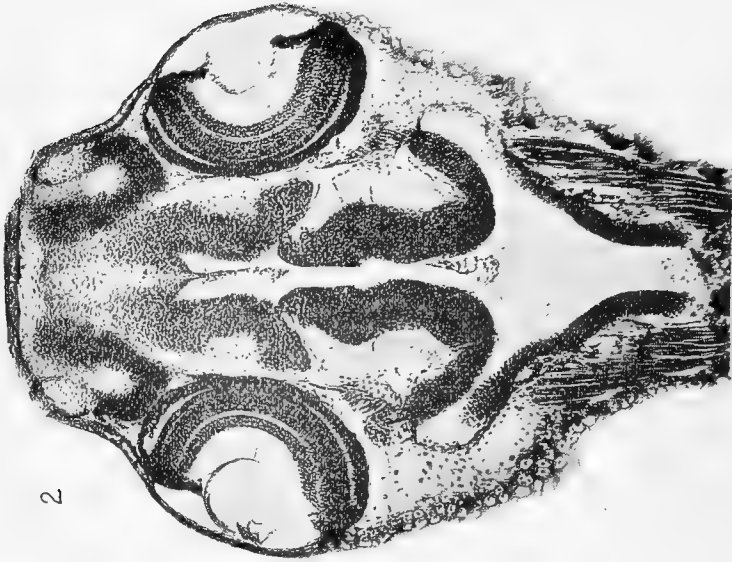

FIG. 182

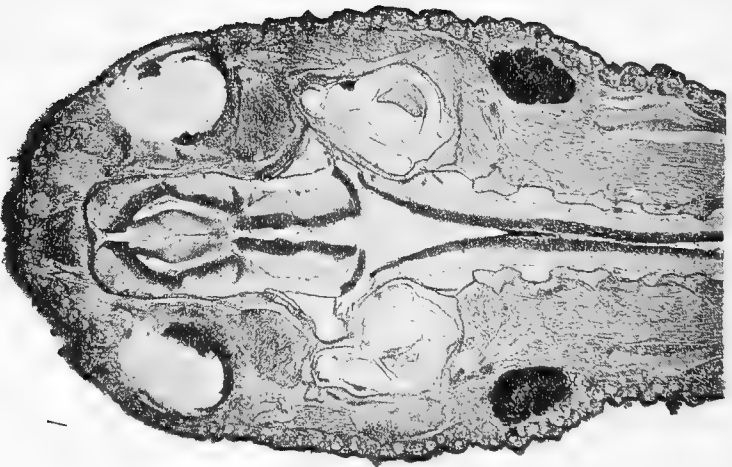

FIG. 181

From photo-micrographs of a large red and of a larval *Diemyctylus*. Fig. 181 is magnified 10, and Fig. 182, 50 diameters. (Susanna Phelps Gage, the Wilder Quarter Century v. Book.)

source of illumination, and the discussion of the proper cone of light and lighting the whole field, as given in § 94, 106. Then for each picture the photographer must take the necessary pains to light the object properly. An achromatic condenser is almost a necessity (§ 91). Whether a color-screen should be used depends upon judgment and that can be attained only by experience. In the beginning one may try without a screen, and with different screens and compare results.

A plan used by many skilled workers is to light the object and the field around it well and then to place a metal diaphragm of the proper size in the camera very close to the plate holder. This will insure a clean, sharp margin to the picture. This metal diaphragm must be removed while focusing the diaphragm of the projection ocular, as the diaphragm opening is smaller than the image of the ocular diaphragm.

If the young photo-micrographer will be careful to select for his first trials, objects of which really good photo-micrographs have already been made, and then persists with each one until fairly good results are attained, his progress will be far more rapid than as if poor pictures of many different things were made. He should, of course, begin with low magnifications.

§ 311. **Adjusting the Objective for Cover-Glass.**—After the object is properly lighted, the objective, if adjustable, must be corrected for the thickness of cover. If one knows the exact thickness of the cover and the objective is marked for different thicknesses, it is easy to get the adjustment approximately correct mechanically, then the final corrections depend on the skill and judgement of the worker. It is to be noted too that if the objective is to be used without a projection ocular the tube-length is practically extended to the focusing screen and as the effect of lengthening the tube is the same as thickening the cover-glass; the adjusting collar must be turned to a higher number than the actual thickness of the cover calls for (see § 113).

§ 312. **Photographing Without an Ocular.**—Proceed exactly as described for the lower power, but if the objective is adjustable make the proper adjustment for the increased tube-length (§ 113.)

§ 313. **Photographing with a Projection Ocular.**—Proceed

as described in § 307 B, only in this case the objective is not to be adjusted for the extra length of bellows. If it is corrected for the ordinary ocular, the projection ocular then projects this correct image upon the focusing screen.

§ 314. **Photo-Micrographs at a Magnification of 500 to 2000 Diameters.**—For this the homogeneous immersion objective is employed, and as it requires a long bellows to get the higher magnification with the objective alone, it is best to use the projection oculars.

For this work the directions given in § 307 B must be followed with great exactness. The edge of the petroleum lamp flame is sufficient to fill the field in most cases. With many objects the time required with good lamp light is not excessive; viz., 40 seconds to 3 minutes. The reason of this is that while the illumination diminishes directly as the square of the magnification, it increases with the increase in the numerical aperture, so that the illuminating power of the homogenous immersion is great in spite of the great magnification (§ 40).

For work with high powers a stronger light than the petroleum lamp is employed by those doing considerable photo-micrography. Good work may be done, however, with the petroleum lamp.

It may be well to recall the statement made in the beginning, that the specimen to be photographed must be of special excellence for all powers. No one will doubt the truth of the statement who undertakes to make photo-micrographs at a magnification of 500 to 2000 diameters.

If one has a complete outfit with electric arc light the time required for photographing objects is much reduced, *i. e.* ranging from 1 to 20 seconds even with the color screen. As the light is so intense with the arc light it is necessary to soften it greatly for focusing. Several thicknesses of ground glass placed between the lamp and the microscope will answer. These are removed before taking the negative. It is well also to have a water bath on the optical bench to absorb the heat rays. This should be in position constantly (see Fig. 133, 160).

§ 315. **Use of Oculars in Photo-Micrography.**—There is much diversity of opinion whether or not the ordinary oculars used

for observation should be used in photographing. Excellent results have been obtained with them and also without them.



FIG. 183. Zeiss' Apochromatic Projection Objective of 70 mm. equivalent focus, for photo-micrography. (Zeiss' Catalog.)

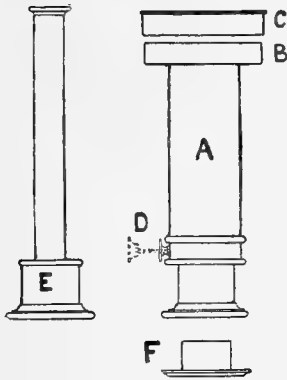

FIG. 184. Gordon's Photo-Micrographic Apparatus.—In this apparatus there is placed over the ocular of the microscope a tube containing a projection lens which focuses the image on the sensitive plate just as the eye focuses the image on the retina. A. The tube bearing the plate at the top. It is about 150 mm. long. B-C. Photographic plate about 40 mm. square, contained in a cap (C) on top of the tube D. Shutter for making the exposure; F. A flange fitting the draw-tube and supporting the camera (A); G. The microscope with a metal block which may be clamped in position to prevent the descent of the body of the microscope during the exposure; E. A focusing ocular of high power placed on the tube of the microscope to ensure a perfect focus. If one has perfectly normal eyes the focus with the ordinary ocular gives a sharp image.

With this apparatus the only change needed in the microscope is the addition of the camera (A) and the clamping of the metal block (G). Then the exposure may be made. The use of a color screen and properly sensitized plates apply here as with any apparatus. "One of the chief advantages of this extremely simple method of photomicrography is that the performance of the microscope is exactly the same as when it is used for visual observation." *Jour. Roy. Micr. Soc.*, 1905, p. 651.

For great magnification Zeiss recommends the use of the compensation oculars with the apochromatics.

The Zeiss projection oculars may be used with achromatic objectives of large aperture as well as with the apochromatics.

NEGATIVE RECORD

Name	No.	Location
Camera		Date
.....		Exposure
Objective		Developer
Ocular		Fixer
Condenser		Mag. \times
Diaphragm		Remarks
Object Stained with
Color Screen
Plate
Light and Hour
.....	

PHOTOGRAPHING OPAQUE OBJECTS AND METALLIC SURFACES WITH A MICROSCOPE

All of the objects considered in the first part of this chapter are opaque and some of them were to be photographed somewhat larger than natural size. To meet the needs of modern work, especially with metals and alloys one must be able to examine and photograph prepared surfaces at magnifications ranging from five or ten to five hundred or more diameters.

§ 317. **Microscope for Opaque Objects.**—If one does not need to magnify more than about 100 diameters, any good microscope will answer. For the higher powers it is far more convenient to employ a special microscope for metallography (micro-metalloscope.) (German, Metallmikroskop; French, Microscope pour l'étude des surfaces métalliques et des objets opaque).

Such a microscope has the following general characters: The stage is movable up and down with rack and pinion, it is rotary and more or less mechanical by means of centering screws. With some at least the stage may be removed entirely. No substage condenser is present, and a mirror is only necessary for occasional transparent objects. A revolving nose-piece is not so good as an objective changer. See Fig. 176.

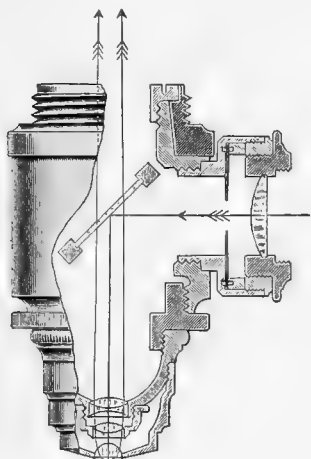

FIG. 185

FIG. 185. *Leitz' Vertical Illuminator.* (From *Leitz' Catalog.*)

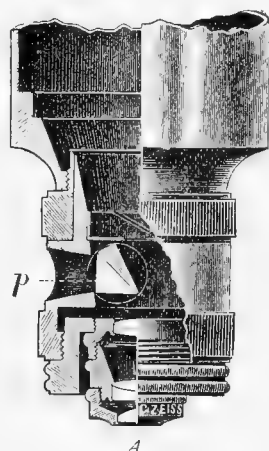

FIG. 186

FIG. 186. *Zeiss' Vertical Illuminator.* (From *Zeiss' Catalog.*)

§ 318. **Illumination of Opaque Objects.**—(A) for 25 to 100 diameters. The directions of Mr. Walmsley are excellent (*Trans. Amer. Micr. Soc.*, 1898, p. 191). "Altogether the best light for the purpose is diffused daylight. Proper lighting is more easily obtained with a vertical camera. An even illumination avoiding deep shadows is preferable in most cases and is more easily attained with the object in a horizontal position. For many objects it is better not to use a bull's eye or any form of condenser but for others the condenser may be needed, but when the condenser is used one must avoid too much glare. The now little used parabolic reflector and Lieberkühn serve well in many cases, but he adds "the majority yield better results under the most simple forms of illumination," *i. e.*, with the diffused light from the window. This has been the experience of the writer also.

In case diffused daylight is employed the camera should be near a good sized window, and the object should be somewhat below the window ledge so that the illumination is partly from above and from the side. (This is easily attained with the small table and vertical camera shown in Figs. 165, 170, 171). The vertical illuminator is advantageous for these powers also. See (B.).

(B) For 100 to 500 diameters,—For the magnification above 50 it is

desirable and for those above 100 it is necessary to use some form of "vertical illuminator," that is some arrangement by which the light is reflected down through the objective upon the object, the objective acting as a condenser, and from the object back through the objective and ocular to the eye of the observer. This is accomplished in two ways:

(1) By means of a small speculum-metal mirror in the tube of the microscope. This is set at an angle of 45 degrees and the light thrown into the tube upon it is reflected straight down through the objective upon the object. The speculum metal being opaque cuts out a part of the light. Instead of a metal mirror a circular disc of glass is now more frequently used. This allows the major part of the light reflected from the object to pass up through the objective, to reach the eye.

(2) By means of a small glass 45 degree prism inserted into the side of the objective or of a special adapter. The light is from the side of the microscope, and is reflected by the prism straight down through the objective upon the object as before.* See Figs. 185-186.

§ 319. **Light for the Vertical Illuminator.**—For moderate powers one may place the microscope in front of a window, or one may use a petroleum or gas lamp. For the higher powers acetylene or preferably the electric arc light is used. In either case it may be necessary to soften the light somewhat either by a color screen or by some ground glass. The light should be concentrated upon the exposed end of the prism or into the hole leading to the glass disc. Both the prism and the disc should be adjustable for different objectives and different specimens. The cone of light, especially with the electric arc lamp, should be enclosed in a hollow metal or asbestos cone to avoid the glare in the eyes of the operator, and it may

*The idea of the vertical illuminator apparently originated with Hamilton L. Smith. He used the metal reflector. Beck substituted a cover-glass and Powell and Lealand a disc of worked glass; *i. e.* glass that had been carefully polished and leveled on the two sides. Carpenter-Dallinger, pp. 336-338.

The use of the prism with the objective is due to Tolles (See Jour. Roy. Micr. Soc., vol. iii, 1880, pp. 526, 574).

In Zeiss' catalog the prism form is figured. In the catalog of Nachet both the glass disc and the prism forms are figured.

For both these devices uncovered objects are most successful or if the object is covered it must be in optical contact with the cover-glass. Naturally good reflecting surfaces like the rulings on polished metal bars give most satisfactory images, hence this method of illumination is especially adapted to micro-metallography. Indeed, without some such adequate method of illumination the study of metals and alloys with high powers would be impossible. So successful is it that oil immersion objectives may be used. (Carpenter-Dallinger, pp. 335-338).

be necessary to soften the light with ground glass before attempting to focus and arrange the specimen. This ground glass would in most cases be removed before making the exposure (§ 314.)

With the electric light and for long exposure or observation, a water bath to absorb the heat rays is necessary to avoid injuring the lenses.

As it is somewhat difficult to adjust the light in a way to give the best effect, one can see the advantage of the adjustment for raising and lowering the stage. This serves for all but the finest focusing, and thus avoids moving the focusing tube enough to throw the lighting out of adjustment. It might be advantageous to have a fine adjustment on the stage also.

§ 320. **Mounting of Objects.**—For observation only and with low powers, objects may be mounted either in a liquid or dry as seems best. There should be a black background for most objects, then light will reach the eye only from the object. A light background is sometimes desirable, especially where one cares only for outlines.

§ 321. **Preparation of Metallic Surfaces.**—In the first place a flat face is obtained by grinding or filing, and then this is polished. For polishing, finer and finer emery or other polishing powders are used, (rouge or diamantine, or specially prepared alumina, etc). The aim is to get rid of scratches so that the surface is smooth and free from lines.

§ 322. **Etching.** After the surface is polished it should be etched with some substance. This etching material corrodes the less resistant material, the edges of crystals, etc., so that the structure appears clearly. For etching, tincture of iodine, nitric acid in various degrees of strength, hydrochloric acid, etc., are used or one may use electricity, the metal being immersed in an indifferent liquid. See numerous articles in the *Metallographist* for methods and micrographs.

After etching, the surface should be washed well with water to remove the etcher. Le Chatelier recommends that the etched surface when dry be covered with a very thin coating of collodion to avoid tarnishing. The preparation will then last for several months untarnished.

§ 323. **Mounting Preparations of Metal.**—In order to get a satisfactory image the flat, polished and etched face should be at right angles to the optic axis. For preliminary observation one can approximate this by mounting the specimen on a piece of bees-wax. (Behrens). Very elaborate arrangements of the stage have also been devised (Reichert).

§ 324. **Photographing Opaque Objects.**—The general directions given in § 282 should be followed with the necessary modifications. The time of exposure is usually considerably greater with opaque objects than with transparent ones. Very few such objects can be photographed in less than 30

seconds, even with daylight. For metallic surfaces and magnifications of 100, 150, 250 to 500, with the electric arc light as illuminant the time required for favorable objects is 1, 2, 4 and 7 seconds; with the Wellsbach lamp the time is 5, 10, 30 and 60 minutes (Sauveur).

ENLARGEMENTS ; LANTERN SLIDES ; PHOTOGRAPHING

BACTERIAL CULTURES

§ 325. *Enlargements.* As a low power objective has greater depth of focus or penetration than a higher power (§ 40), it is desirable in many cases to make a negative of an object with considerable depth at a low magnification, and then to enlarge this picture to the desired size. As a rule negatives will not bear an enlargement of more than five diameters.

For this work the camera shown in Fig. 169 is excellent, and the special microscope stand shown in this figure and in Fig. 165 enables one to get an exact focus.

One must select an objective for the enlargement with a field of sufficient size to cover the part of the negative to be enlarged. An objective of 60 to 100 mm. focus will answer in most cases.

For the illumination the camera can be elevated against the sky, or artificial light may be used. It is not easy to light so large a surface evenly by artificial light.

(A) *Enlargement on Bromide Paper.*—For this the negative is put in place and by pulling out the bellows the proper amount, one gets the right magnification. Focus now as for any other object, using the fine adjustment and focusing glass.

For great exactness one must put a clear glass in the plate holder and focus on the surface away from the objective. Then place the bromide paper on this clear glass and put another over it to hold it flat against the first plate of glass. The sensitive surface will then be in the exact plane of the focus and the picture will be sharp.

For the development and subsequent treatment of the paper, follow the directions of the makers.

(B) *Enlargement on a Glass Plate.*—One may proceed in enlarging as for making lantern slides and make a positive on a glass plate. If it is then desired to get a negative for printing, place this positive on the microscope stand and make a negative from it as if it were an object. Or one may make a contact impression as is frequently done in lantern slide making. By this method one must make three separate pictures, (1) the original photo-micrographic negative; (2) the enlarged positive from this; (3) a negative from the enlarged positive. With this negative one may print as from the original negative.

§ 326. *Lantern Slides from Negatives.*—In preparing lantern slides from photo-micrographic or ordinary negatives one may use the contact method, or the camera. With the camera one can enlarge or reduce to suit the particular case. The camera and special microscope stand shown in Fig. 169 are admir-

able for the purpose. For lantern slide work a photographic objective is used and the cone for enlargement removed. One may put the objective in the front of the camera or in the middle segment, making use of the little side door.

§ 327. **Photographing Bacterial Cultures in Petri Dishes.**—For the successful photographing of these cultures dark ground illumination is employed on the principle stated in § 103. That is the preparation is illuminated with rays so oblique that none can enter the objective. These striking the culture are reflected into the objective. The clear gelatin around the growth or colonies does not reflect the light and therefore the space between the colonies is dark.

For supporting the Petri dishes a hole is made in a front board for the camera. This hole is slightly larger than the dish. Over it is then screwed or nailed a rubber ring slightly smaller than the Petri dish. This will stretch and receive the dish, and grasp it firmly so that it is in no danger of falling out when put in a vertical position. If the camera has two divisions like the one shown the board with the Petri dish is put in the front of the camera, and the objective in the middle division through the side door. Otherwise the board holding the Petri dish must be on a separate support.

The illumination is accomplished by the use of two electric lamps with conical shades. (The cheap tin shades with white enamel paint on the inside are good). The lamps are placed at the sides so that a bright light is thrown on the culture, but at such an angle that none of it enters the objective directly.

A piece of black velveteen is placed 10 to 20 cm. beyond the culture. This prevents any light from being reflected through the clear gelatin to the objective. Unless some such precaution were taken the background would be gray instead of black.

One may use daylight by putting the culture in a support just outside a window, leaving the camera in the room. The rays from the sky are so oblique that they do not enter the objective. One must use a black non-reflecting background some distance beyond the dish as in using artificial light (Atkinson).

§ 328. **Photographing Bacterial Cultures in Test-Tubes.**—Here the lighting is as in the preceding section, but a great difficulty is found in getting good results from the refraction and reflections of the curved surfaces. To overcome this one applies the principles discussed in § 157, and the test-tubes are immersed in a bath of water or water and glycerin. The bath must have plane surfaces. Behind it is the black velvet screen, and the light is in front as for the Petri dishes. As suggested by Spitta it is well to employ a bath sufficiently thick in order that streak cultures may be arranged so that the sloping surface will all be in focus at once by inclining the test-tube.

REFERENCES FOR CHAPTER VIII

See the works and journals dealing with photography.

For Photo-Micrography see Pringle, Bousfield, Neubauss, 3rd ed. Stern-

berg, Francotte, Spitta and the special catalogs on photo-micrography and projection issued by the great opticians. The Journal of the Royal Microscopical Society and of the Quekett Micr. Club; *Zeit. wiss. Mikroskopie*; the *Trans. Amer. Micr. Soc.*; the *Amer. Monthly Micr. Journal*; the *Journal of Applied Microscopy*.

For the photography of metallic surfaces, see the various journals of engineering and metallurgy, but especially Sauveur's journal, the *Metallographist*, begun in 1898; *Jour. Roy. Micr. Soc.*

See the works on photo-micrography and photography for the details of lantern slide making. See for the Petri dishes and test-tubes, Atkinson, *Botanical Gazette*, xviii (1893), p. 333; Spitta, *Photo-Micrography* (1899), p. 26.

For photography with ultra-violet light see Zeiss special catalogs. *Journal of the Royal Microscopical Society*, *Zeitschrift für wiss. Mikroskopie*; Dr. August Köhler, *Zeit. wiss. Mikr.* Bd. xxi, 1904, pp. 129-165, 273-304; six plates; Band 24, 1907, pp. 360-366. Dr. H. C. Ernst of the Harvard Medical School; *Jour. Med. Research N. S.* Vol. 9, 1905-6 pp. 463-468, plates.

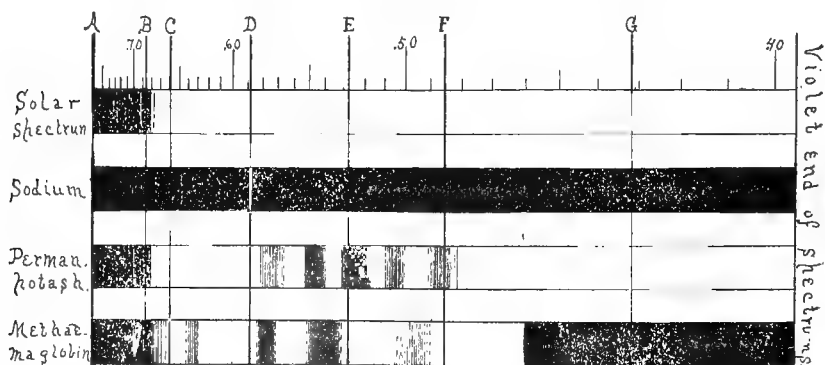

Various Spectra.—These spectra illustrate some of the points in the discussion of color screens (§ 291).

The Solar spectrum shows that all the wave lengths of light are present except for the very narrow dark lines (Fraunhofer lines, § 214).

The Sodium spectrum is an example of the spectrum of an incandescent gas; it is also an extreme example of monochromatic light. Sodium light is very brilliant, but the appearance of surrounding objects gives one a good idea of the changed appearance which the universe would assume if illuminated by monochromatic light.

The spectra of permanganate and methemoglobin illustrate well the absorption spectra of colored substances.

If one were to use permanganate for a color screen the object photographing most successfully would be one transmitting light in the E region of the spectrum.

Methemoglobin would answer well as a color screen for an object transmitting light at the violet end of the spectrum and between the lines DE.

CHAPTER IX

SLIDES AND COVER-GLASSES; MOUNTING; ISOLATION; LABELING AND STORING MICROSCOPIC PREPARATIONS; REAGENTS

SLIDES AND COVER-GLASSES

‡ 329. **Slides, Glass Slides or Slips, Microscopic Slides or Slips.**—These are strips of clear flat glass upon which microscopic specimens are usually mounted for preservation and ready examination. The size that has been almost universally adopted for ordinary preparations is 25×76 millimeters (1×3 inches). For rock sections, slides 25×45 mm. or 32×32 mm. are used; for serial sections, slides 25×76 mm., 50×76 mm. or 38×76 mm. are used. For special purposes, slides of the necessary size are employed without regard to any conventional standard.

Whatever size of slide is used, it should be made of clear glass and the edges should be ground. It is altogether false economy to mount microscopic objects on slides with unground edges. It is unsafe also as the unground edges are liable to wound the hands.

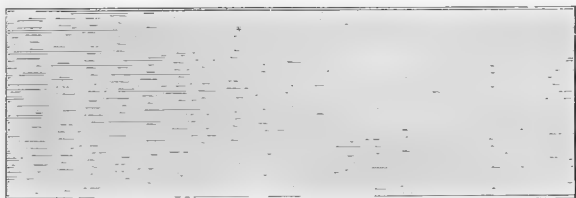

FIG. 187. *Glass slide or slip of the ordinary size for microscopic work (3 x 1 in., 76 x 25 mm.). (Cul loaned by the Spencer Lens Company).*

Thick slides are preferred by many to thin ones. For micro-chemical work Dr. Chamot recommends slides of half the length of those used in ordinary microscopic work. From the rapidity with which they are destroyed, he thinks the ground edges are unnecessarily expensive. He adds further: "It is a great misfortune that the colorless glass slips used in America and so excellent for ordinary microscopic work should be easily attacked by all liquids; even water extracts a relatively enormous amount of alkalis and alkaline

earths. The slips of greenish glass, while not as neat or desirable for general microscopy, seem to be decidedly more resistant, and are therefore preferable.* Transparent celluloid slides are recommended by Behrens for work where hydrofluoric acid and its derivatives are to be examined. (Chamot, Jour. Appl. Micr. vol. iii, p. 793).

§ 330. **Cleaning Slides for Ordinary Use.**—Place new slides that are to be wiped at one sitting in a glass vessel of distilled water containing 5% ammonia (Fig. 188-189). For wiping the slides use a so-called glass towel or other well washed linen towel. One may avoid large wash bills by using absorbent gauze.*

In handling the slides grasp them by the edges. Cover the fingers of the right hand with the wiping towel or the gauze and rub both faces with it. When wiped thoroughly dry, place the slide in a dry glass jar like that shown in Fig. 189, or for larger numbers use a museum jar (Fig. 190). Soap and water are also recommended for new slides.

§ 331. **Cleaning Used Slides.**—If only watery substances or glycerin or glycerin jelly have been used one may soak the slides over night in ammonia water, then changing the water for fresh and wiping as described in § 330.

When balsam or other resinous media (§ 353) have been used it is best to

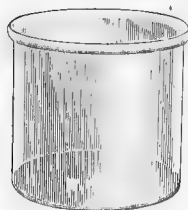

FIG. 188. *Round glass aquarium jar suited for an aquarium, for cleaning slides or for any other purpose where a wide open glass dish is needed.*

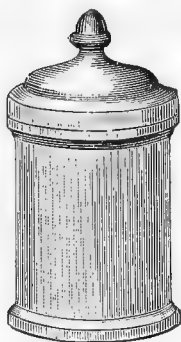

FIG. 189. *Covered glass dish known as an "ointment jar" of the right height to hold slides on end. (Cuts 146, 147 loaned by the Whitall Tatum Co.).*

* The gauze mentioned is No. 10, "Sterilized absorbent gauze", of the Griswoldville Mfg Co. of N.Y. It is sometimes called bleached cheese cloth. In the author's laboratory it is cut into pieces, $\frac{1}{4}$, $\frac{1}{8}$, $\frac{1}{16}$ of a yard. When a piece is soiled it is thrown away.

heat the slides over a Bunsen flame and remove the cover-glass. Place the cover in cleaning mixture (§ 339). The slide may also be placed in cleaning mixture or in some hot water containing 10% gold dust or other strong alkaline cleaner. When the metal basin—preferably an agate ware basin—is two thirds full of the slides, heat until the water comes to a boil. Then let it cool. Add fresh water and most of the slides may be wiped clean.

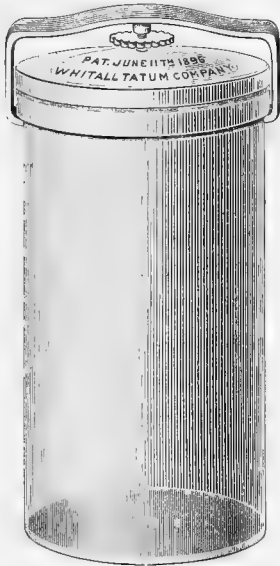

FIG. 190. *Museum jar with clamp top for storing cleaned slides and for preserving specimens. (Cut loaned by the Whitall Tatum Co.)*

If dichromate cleaning mixture is used the best method is to have a museum jar of it and drop the slides in as they are rejected, or a large number at once as is most convenient. It may require a week or more to clean the slides with cleaning mixture. As this is a very corrosive mixture for metals use only glass dishes in dipping into it. When the slides are freed from balsam etc. pour off the cleaning mixture into another glass vessel and allow a stream of water to flow over the slides until all the cleaning mixture has been washed away. Then add distilled water and wipe the slides from that. Any slides still not freed from the balsam should be put back into the cleaning mixture. Apparently the slides are not injured by a prolonged stay in the mixture.

§ 332. **Cleaning Slides for Special Uses.**—In making blood films, for micro-chemistry and whenever an even film is desired every particle of oily substance must be removed. The slides should be placed in the dichromate cleaning mixture (§ 329) one day or more, thoroughly washed with clean water and then in distilled water, or in 50% to 75% alcohol. They are taken from the water or alcohol and wiped dry as needed. In wiping keep two or more layers of the absorbent gauze over the fingers. Only one slide is wiped with each piece of gauze. The surface to touch the slides should never have

been touched by the hands for a minute amount of oily substance leaves a stratum on the slide which causes the liquids used to heap up instead of flowing out perfectly flat. That is, the slide is wet with difficulty and the liquid instead of forming a film tends to assume the spheroidal state. Sometimes new gauze or other cloth used may not be wholly free from oily substance, or the soap was not wholly eliminated in washing. Such wiping cloths will not make the slides ready for good films. Some workers soak the gauze in sulfuric ether to remove the last traces of oily substance. This is done more especially in cleaning cover-glasses for films, see below. Burnett, p. 22, in speaking of blood smears says: "The slides should be thoroughly clean. Unused slides may be cleaned in strong soap or "gold dust" solution, well rinsed in water, then placed in alcohol from which they are wiped and polished."

§ 333. **Cover-Glasses or Covering Glasses.**—These are circular or quadrangular pieces of thin glass used for covering and protecting microscopic objects. They should be very thin, 0.10 to 0.25 millimeter (see table, § 32-34). It is better never to use a cover-glass over 0.20 mm. thick, then the preparation may be studied with a 2 mm. oil immersion as well as with lower objectives. Except for objects wholly unsuited for high powers, it is a great mistake to use cover-glasses thicker than the working distance of a homogeneous objective (§ 69). Indeed, if one wishes to employ high powers, the thicker the section the thinner should be the cover-glass (see. § 337).

The cover-glass should always be considerably larger than the object over which it is placed.

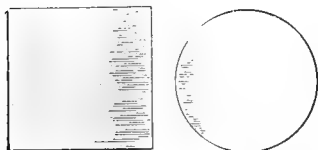

FIGS. 191-192. *Figures of square and of circular cover-glasses. (Cuts loaned by the Spencer Lens Co.)*

§ 334. **Cleaning Cover-Glasses for Ordinary Use.**—Covers may be cleaned well by placing them in 82% or 95% alcohol containing hydrochloric acid one per cent. They may be wiped almost immediately.

Remove a cover from the alcohol, grasping by the edge with the left thumb and index. Cover the right thumb and index with some clean gauze or other absorbent cloth; grasp the cover between the thumb and index and rub the surfaces keeping the thumb and index well opposed on directly opposite faces of the cover so that no strain will come on it, otherwise the cover is liable to be broken.

When a cover is dry hold it up and look through it toward some dark object. The cover will be seen partly by transmitted and partly by reflected light, and any cloudiness will be easily detected. If the cover does not look clear, breathe on the faces and wipe again. If it is not possible to get a cover clean in this way it should be put again into the cleaning mixture.

As the covers are wiped put them in a clean glass box or Petri dish.

Handle them always by their edges, or use fine forceps. Do not put the fingers on the faces of the covers, for that will surely cloud them.

§ 335. **Cleaning Cover-Glasses for Special Uses.**—As with slides, covers intended for films or other purposes where the last particles of oily substance must be removed, are best put one by one into dichromate cleaning mixture (§ 339). After a day or more this is poured off and a stream of fresh water allowed to run on the covers until all the cleaning mixture is removed. Then distilled water is added and allowed to stand a few minutes. This is poured off and S_2O_5 or 95% alcohol added. The covers remain in this until needed. In wiping use the precautions given with slides (§ 332).

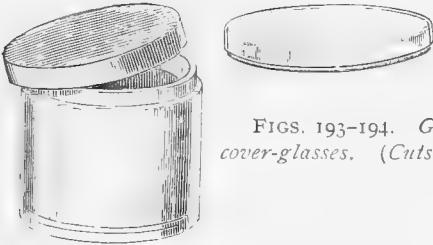

FIGS. 193-194. *Glass box and Petri dish for clean cover-glasses. (Cuts loaned by the Whitall Tatum Co.).*

§ 336. **Cleaning Large Cover-Glasses.**—For serial sections and especially large sections, large quadrangular covers are used. These are to be put one by one into a cleaning mixture as for the smaller covers and treated in every way the same. In wiping them one may proceed as for the small covers, but special care is necessary to avoid breaking them. It is desirable that these large covers should be thin—not over 0.15-0.20 mm. otherwise high objectives cannot be used in studying the preparations.

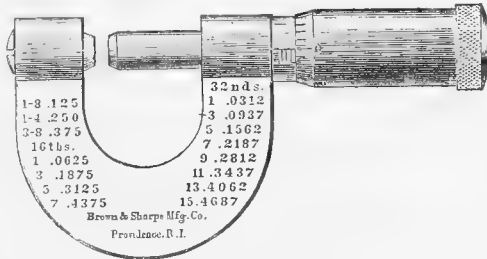

FIG. 195. *Micrometer Calipers (Brown and Sharpe). Pocket Calipers, graduated in inches or millimeters, and well adapted for measuring cover-glasses.*

§ 337. **Measuring the Thickness of Cover-Glasses.**—It is of great advantage to know the exact thickness of the cover-glass on an object; for, (a) in studying the preparation one would not try to use objectives of a shorter working distance than the thickness of the cover (§ 69); (b) In using adjustable objectives with the collar graduated for different thicknesses of cover, the

collar can be set at a favorable point without loss of time; (c) For unadjustable objectives the thickness of cover may be selected corresponding to that for which the objective was corrected (see table, § 33). Furthermore, if there is a variation from the standard, one may remedy it, in part at least, by lengthening the tube if the cover is thinner, and shortening it if the cover is thicker than the standard (§ 113).

Among the so called No. 1 cover-glasses of the dealers in microscopical supplies, the writer has found covers varying from 0.10 mm. to 0.35 mm. To use cover-glasses of so wide a variation in thickness without knowing whether one has a thick or thin one is simply to ignore the fundamental principles by which correct microscopic images are obtained.

It is then strongly recommended that every preparation shall be covered with a cover-glass whose thickness is known, and that this thickness be indicated in some way on the preparation.

§ 338. **Cover-Glass Measures, Testers or Gauges.**—For the purpose of measuring cover-glasses there are two very excellent pieces of apparatus. The micrometer calipers (Fig. 195) used chiefly in the mechanic arts, are convenient and from their size are easily carried in the pocket. The cover-glass measurer specially designed for the purpose is shown in Fig. 196 by which covers may be more rapidly measured than with the calipers.

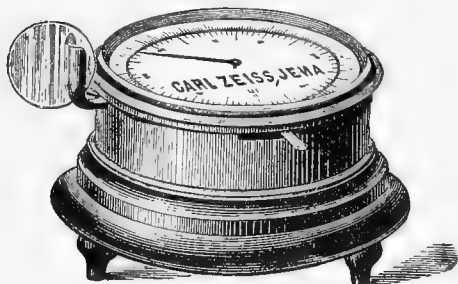

FIG. 196. *Zeiss' Cover-Glass Measurer.* With this the knife edge jaws are opened by means of a lever and the cover inserted. The thickness may then be read off on the face as the pointer indicates the thickness in hundredths millimeter in the outer circle and in thousandths inch on the inner circle.

With these measures or gauges one should be certain that the index stands at zero when at rest. If the index does not stand at zero it should be adjusted to that point, otherwise the readings will not be correct.

As the covers are measured, the different thicknesses should be put into different glass boxes and properly labeled. Unless one is striving for the most accurate possible results, cover-glasses not varying more than 0.06 mm. may be put in the same box. For example, if one takes 0.15 mm. as a standard, covers varying 0.03 mm. on each side may be put into the same box. In this case the box would contain covers of 0.12, 0.13, 0.14, **0.15**, 0.16, 0.17 and 0.18 mm.

§ 339. **Dichromate Cleaning Mixture for Glass.**—The cleaning mixture used for cleaning slides and cover-glasses is that commonly used in chemical laboratories: (Dr. G. C. Caldwell's Laboratory Guide in Chemistry).

Dichromate of potash ($K_2Cr_2O_7$)	-	-	-	-	200 grams
Water, distilled or ordinary	-	-	-	-	800 cc.
Sulphuric acid (H_2SO_4)	-	-	-	-	1200 cc.

Dissolve the dichromate in the water by the aid of heat, using an agate or other metal dish, then pour it into a heavy iron kettle lined with sheet lead (Trans. Amer. Micr. Soc., 1899, p. 107). Add the sulphuric acid to the dissolved dichromate in the kettle. The purpose of the lead lined kettle is to avoid breakage from the great heat developed upon the addition of the sulphuric acid. The lead is very slightly affected by the acid, iron would be corroded by it.

For making this mixture, ordinary water, commercial dichromate and strong commercial sulphuric acid may be used. It is not necessary to employ chemically pure materials.

This is an excellent cleaning mixture and is practically odorless. It is exceedingly corrosive and must be kept in glass vessels. It may be used more than once, but when the color changes markedly from that seen in the fresh mixture it should be thrown away. An indefinite sojourn of the slides and covers in the cleaner does not seem to injure them.

MOUNTING, AND PERMANENT PREPARATION OF MICROSCOPIC OBJECTS

§ 340. **Mounting a Microscopic Object** is so arranging it upon some suitable support (glass slide) and in some suitable mounting medium that it may be satisfactorily studied with the microscope.

The cover-glass on a permanent preparation should always be considerably larger than the object; and where several objects are put under one cover-glass it is false economy to crowd them too closely together.

§ 341. **Temporary Mounting.**—In a great many cases objects do not need to be preserved; they are then mounted in any way to enable one best to study them, and after the study the cover glass is removed, the slide cleaned for future use. In the study of living objects, of course only temporary preparations are possible. With amoebae, white blood corpuscles, and many other objects both animal and vegetable, the living phenomena can best be studied by mounting them in the natural medium. That is, for amoebae, in the water in which they are found; for the white blood corpuscles, a drop of blood is used and, as the blood soon coagulates, they are in the serum. Sometimes it is not easy or convenient to get the natural medium, then some liquid that has been found to serve in place of the natural medium is used. For many things, water with a little common salt (water 100 cc., common salt $\frac{1}{10}$ gram) is employed. This is the so-called normal salt or saline solution. For the ciliated cells from frogs and other amphibia, nothing has been found so good as human spittle. Whatever is used, the object is put on the middle of the slide and a drop of the mounting medium added, and then the cover-glass. The cover is best put on with fine forceps, as shown in Fig. 197. After the

cover is in place, if the preparation is to be studied for some time, it is better to avoid currents and evaporation by painting a ring of castor oil around the cover in such a way that part of the ring will be on the slide and part on the cover (Fig. 210).

FIG. 197. To show the method of putting a cover-glass upon a microscopic preparation. The cover is grasped by one edge, the opposite edge is then brought down to the slide, and the cover gradually lowered upon the object.

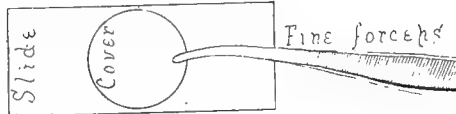

§ 342. **Permanent Mounting.**—There are three great methods of making permanent microscopic preparations. Special methods of procedure are necessary to mount objects successfully in each of these ways. The best mounting medium and the best method of mounting in a given case can only be determined by experiment. In most cases some previous observer has already made the necessary experiments and furnished the desired information.

The three methods are the following: (A) *Dry or in air* (§ 343); (B) *In some medium miscible with water, as glycerin or glycerin jelly* (§ 348); (C) *In some resinous medium like Canada Balsam* (§ 353).

§ 343. **Mounting Dry or in Air.**—The object should be thoroughly dry. If any moisture remains it is liable to cloud the cover-glass, and the specimen may deteriorate. As the specimen must be sealed, it is necessary to prepare a cell slightly deeper than the object is thick. This is to support the cover-glass, and also to prevent the running in by capillarity of the sealing mixture.

§ 344. **Order of Procedure in Mounting Objects Dry or in Air.**

1. A cell of some kind is prepared. It should be slightly deeper than the object is thick (§ 346).
2. The object is thoroughly dried (desiccated) either in dry air or by the aid of gentle heat.
3. If practicable the object is mounted on the cover-glass; if not it is placed in the bottom of the cell.
4. The slide is warmed till the cement forming the cell wall is somewhat sticky, or a very thin coat of fresh cement is added; the cover is warmed and put on the cell and pressed down all around till a shining ring indicates its adherence (§ 347).
5. The cover-glass is sealed.
6. The slide is labeled.
7. The preparation is cataloged and safely stored.

§ 345. **Example of Mounting Dry, or in Air.**—Prepare a shallow cell and dry it (§ 346). Select a clean cover-glass slightly larger than the cell. Pour upon the cover a drop of 10% solution of salicylic acid in 95% alcohol. Let it dry spontaneously. Warm the slide till the cement ring or cell is some-

what sticky, then warm the cover gently and put it on the cell, crystals down. Press on the cover all around the edge (§ 347) seal, label and catalog.

A preparation of mammalian red blood corpuscles may be satisfactorily made by spreading a very thin layer of fresh blood on a cover with the end of a slide. After it is dry, warm gently to remove the last traces of moisture and mount blood side down, precisely as for the crystals. One can get the blood as directed for the Micro-spectroscopic work (§ 232).

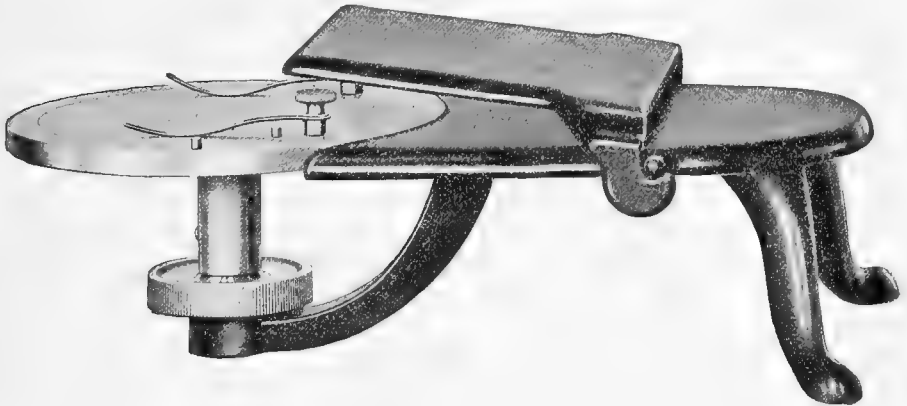

FIG. 198. *Turn-Table for sealing cover-glasses and making shallow mounting cells.* (Cut loaned by the Bausch & Lomb Opt. Co.).

§ 346. **Preparation of Mounting Cells.**—(A) *Thin cells.* These are most conveniently made of some of the cements used in microscopy. Shellac is one of the best and most generally applicable. To prepare a shellac cell place the slide on a turn-table (Fig. 198) and center it, that is, get the center of the slide over the center of the turn-table. Select a guide ring on the turn-table which is a little smaller than the cover-glass to be used, take the brush from the shellac, being sure that there is not enough cement adhering to it to drop. Whirl the turn-table and hold the brush lightly on the slide just over the guide ring selected. An even ring of cement should result. If it is uneven, the cement is too thick or too thin, or too much was on the brush. After a ring is thus prepared remove the slide and allow the cement to dry spontaneously, or heat the slide in some way. Before the slide is used for mounting, the cement should be so dry when it is cold that it does not dent when the finger nail is applied to it.

A cell of considerable depth may be made with the shellac by adding successive layers as the previous one dries.

(B) *Deep Cells* are sometimes made by building up cement cells, but more frequently, paper, wax, glass, hard rubber, or some metal is used for the main part of the cell. Paper rings, block tin or lead rings are easily cut out with gun punches. These rings are fastened to the slide by using some cement like the shellac.

§ 347. **Sealing the Cover-Glass for Dry Objects Mounted in Cells.**—When an object is mounted in a cell, the slide is warmed until the cement is slightly sticky or a very thin coat of fresh cement is put on. The cover-glass is warmed slightly also, both to make it stick to the cell more easily, and to expel any remaining moisture from the object. When the cover is put on, it is pressed down all around over the cell until a shining ring appears, showing that there is an intimate contact. In doing this the the convex part of the fine forceps or some other blunt, smooth object; it is also necessary to avoid pressing on the cover except immediately over the wall of the cell for fear of breaking the cover. When the cover is in contact with the wall of cement all around, the slide should be placed on the turn-table and carefully arranged so that the cover-glass and cell wall will be concentric with the guide rings of the turn-table. Then the turn-table is whirled and a ring of fresh cement is painted, half on the cover and half on the cell wall (Fig. 210). If the cover-glass is not in contact with the cell wall at any point and the cell is shallow, there will be great danger of the fresh cement running into the cell and injuring or spoiling the preparation. When the cover-glass is properly sealed, the preparation is put in a safe place for the drying of the cement. It is advisable to add a fresh coat of cement occasionally.

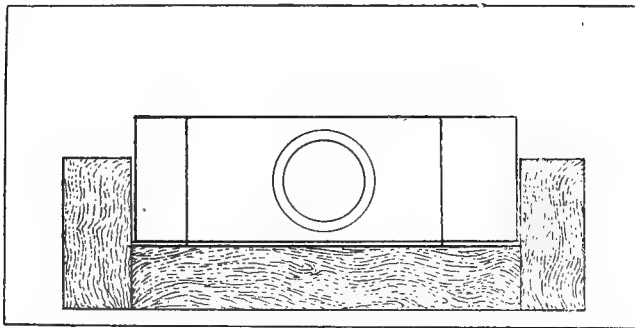

FIG. 199. *Centering Card.* A card with stops for the slide and circles in the position occupied by the center of the slide. If the slide is put upon such a card it is easy to arrange the object so that it will be approximately in the center of the slide. The position of the long cover used for serial sections is also shown. (From the *Microscope*, December, 1886).

§ 348. **Mounting Objects in Media Miscible with Water.**—Many objects are so greatly modified by drying that they must be mounted in some medium other than air. In some cases water with something in solution is used. Glycerin of various strengths, and glycerin jelly are also much employed. All these media keep the object moist and therefore in a condition resembling the natural one. The object is usually and properly treated with gradually increasing strengths of glycerin or fixed by some fixing agent before being permanently mounted in strong glycerin or either of the other media.

In all of these different methods, unless glycerin of increasing strengths has been used to prepare the tissue, the fixing agent is washed away with water before the object is finally and permanently mounted in either of the media.

For glycerin jelly no cell is necessary unless the object has a considerable thickness.

§ 349. Order of Procedure in Mounting Objects in Glycerin.

1. A cell must be prepared on the slide if the object is of considerable thickness (§ 346).
2. A suitably prepared object is placed on the center of a clean slide, and if no cell is required a centering card is used to facilitate the centering (Fig. 199).
3. A drop of pure glycerin is poured upon the object, or if a cell is used, enough to fill the cell and a little more.
4. In putting on the cover-glass it is grasped with fine forceps and the under side breathed on to slightly moisten it so that the glycerin will adhere, then one edge of the cover is put on the cell or slide and the cover gradually lowered upon the object (Fig. 197). The cover is then gently pressed down. If a cell is used, a fresh coat of cement is added before mounting.



FIG. 200. Slide and cover-glass showing method of anchoring a cover-glass with a glycerin preparation when no cell is used. A cover-glass so anchored is not liable to move when the cover is being sealed (§ 351).

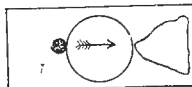

FIG. 201. Glass slide with cover-glass, a drop of reagent and a bit of absorbent paper to show method of irrigation.

5. The cover-glass is sealed.
6. The slide is labeled.
7. The preparation is cataloged and safely stored.

§ 350. Order of Procedure in Mounting Objects in Glycerin Jelly.

1. Unless the object is quite thick no cell is necessary with glycerin jelly.
2. A slide is gently warmed and placed on the centering card (Fig. 199) and a drop of warmed glycerin jelly is put on its center. The suitably prepared object is then arranged in the center of the slide.
3. A drop of the warm glycerin jelly is then put on the object, or if a cell is used it is filled with the medium.
4. The cover-glass is grasped with fine forceps, the lower side breathed on and then gradually lowered upon the object (Fig. 197) and gently pressed down.
5. After mounting, the preparation is left flat in some cool place till the glycerin jelly sets, then the superfluous amount is scraped and wiped away and the cover-glass sealed with shellac (§ 347).

6. The slide is labeled.
7. The preparation is cataloged and safely stored.

§ 351. **Sealing the Cover-Glass when no Cell is used.**—(A) *For glycerin mounted specimens.* The superfluous glycerin is wiped away as carefully as possible with a moist cloth, then four minute drops of cement are placed at the edge of the cover (Fig. 200), and allowed to harden for half an hour or more. These will anchor the cover-glass, then the preparation may be put on the turn-table and ringed with cement while whirling the turn-table.

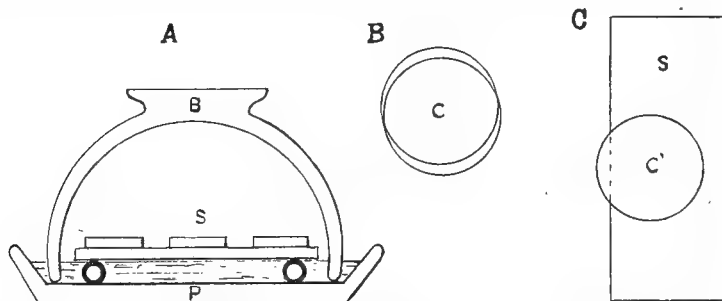

FIG. 202. A—Simple form of moist chamber made with a plate and bowl. B, bowl serving as a bell jar; P, plate containing the water and over which the bowl is inverted; S, slides on which are mounted preparations which are to be kept moist. These slides are seen endwise and rest upon a bench made by cementing short pieces of large glass tubing to a strip of glass of the desired length and width.

B—Two cover-glasses (C) made eccentric, so that they may be more easily separated by grasping the projecting edge.

C—Slide (S) with projecting cover-glass (C'). The projection of the cover enables one to grasp and raise it without danger of moving it on the slide and thus folding the substance under the cover. (From Proc. Amer. Micr. Soc., 1891).

(B) *For objects in glycerin jelly, Farrants' solution or a resinous medium.* The mounting medium is first allowed to harden, then the superfluous medium is scraped away as much as possible with a knife, and then removed with a cloth moistened with water for the glycerin jelly and Farrants' solution or with alcohol, chloroform or turpentine, etc., if a resinous medium is used. Then the slide is put on a turn-table and a ring of the shellac cement added. (C) *Balsam preparations* may be sealed with shellac as soon as they are prepared, but it is better to allow them to dry for a few days. One should never use a cement for sealing preparations in balsam or other resinous media if the solvent of the cement is also a solvent of the balsam, etc. Otherwise the cement will soften the balsam and finally run in and mix with it, and partly or wholly ruin the preparation. Shellac is an excellent cement for sealing balsam preparations, as it never runs in. Balsam preparations are rarely sealed.

§ 352. **Example of Mounting in Glycerin Jelly.**—For this select some stained and isolated muscular fibres or other suitably prepared objects. (See under isolation § 357). Arrange them on the middle of a slide, using the centering card, and mount in glycerin jelly as directed in § 350. Air bubbles are not easily removed from glycerin jelly preparations, so care should be taken to avoid them.

§ 353. **Mounting Objects in Resinous Media.**—While the media miscible with water offer many advantages for mounting animal and vegetable tissues the preparations so made are liable to deteriorate. In many cases, also, they do not produce sufficient transparency to enable one to use high enough powers for the demonstration of minute details.

By using sufficient care almost any tissue may be mounted in a resinous medium and retain all its details of structure.

For the successful mounting of an object in a resinous medium it must in some way be deprived of all water and all liquids not miscible with the resinous mounting medium. There are two methods of bringing this about: (A) By drying or desiccation (§ 355), and (B) by successive displacements (§ 356).

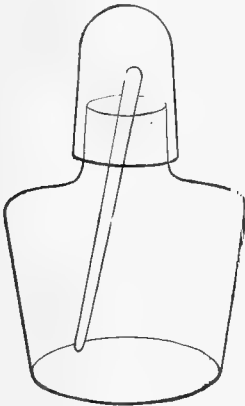

FIG. 203

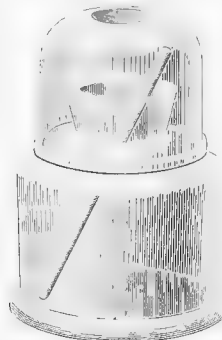

FIG. 204

FIG. 203. *Small spirit lamp modified into a balsam bottle, a glycerin or glycerin-jelly bottle, or a bottle for homogeneous immersion liquid. For all of these purposes it should contain a glass rod as shown in the figure. By adding a small brush, it answers well for a shellac bottle also.*

FIG. 204. *Capped balsam bottle. This form is more satisfactory than the preceding. (Cut loaned by the Whitall Tatum Co.)*

§ 354. **Order of Procedure in Mounting Objects in Resinous Media by Desiccation:**

I. The object suitable for the purpose (fly's wings, etc.) is thoroughly dried in dry air or by gentle heat.

2. The object is arranged as desired in the center of a clean slide on the centering card (Fig. 199).
3. A drop of the mounting medium is put directly upon the object or spread on a cover-glass.
4. The cover-glass is put on the specimen with fine forceps (Fig. 197), but in no case does one breathe on the cover as when media miscible with water are used.
5. The cover-glass is pressed down gently.
6. The slide is labeled.
7. The preparation is cataloged and safely stored (§ 367).

§ 355. **Example of Mounting in Balsam by Desiccation.**—Find a fresh fly, or if in winter, procure a dead one from a window sill or a spider's web. Remove the fly's wings, being especially careful to keep them the dorsal side up. With a camel's hair brush remove any dirt that may be clinging to them. Place a clean slide on the centering card, then with fine forceps put the two wings within one of the guide rings. Leave one dorsal side up, turn the other ventral side up. Spread some Canada balsam on the face of the cover-glass and with the fine forceps place the cover upon the wings (Fig. 197). Probably some air-bubbles will appear in the preparation, but if the slide is put in a warm place these will soon disappear. Label, catalog, etc.

§ 356. **Mounting in Resinous Media by a Series of Displacements.**—For examples of this see the procedure in the paraffin and in the collodion methods Ch. X. The first step in the series is *Dehydration*, that is, the water is displaced by some liquid which is miscible both with the water and the next liquid to be used. Strong alcohol (95% or stronger) is usually employed for this. Plenty of it must be used to displace the last trace of water. The tissue may be soaked in a dish of the alcohol, or alcohol from a pipette may be poured upon it. Dehydration usually occurs in the thin objects to be mounted in balsam in 5 to 15 minutes. If a dish of alcohol is used it must not be used too many times, as it loses in strength.

The second step is clearing. That is, some liquid which is miscible with the alcohol and also with the resinous medium is used. This liquid is highly refractive in most cases, and consequently this step is called *clearing* and the liquid a *clearer*. The clearer displaces the alcohol, and renders the object more or less translucent. In case the water was not all removed, a cloudiness will appear in parts or over the whole of the preparation. In this case the preparation must be returned to alcohol to complete the dehydration.

One can tell when a specimen is properly cleared by holding it over some dark object. If it is cleared it can be seen only with difficulty, as but little light is reflected from it. If it is held toward the window, however, it will appear translucent.

The third and final step is the displacement of the clearer by the resinous mounting medium.

The specimen is drained of clearer and allowed to stand for a short time till there appears the first sign of dullness from evaporation of the clearer from

the surface. Then a drop of the resinous medium is put on the object, and finally a cover-glass is placed over it, or a drop of the mounting medium is spread on the cover and it is then put on the object.

ISOLATION OF HISTOLOGIC ELEMENTS

§ 357. Isolation, General.—For a correct conception of the forms of the cells and fibers of the various organs of the body, one must see these elements isolated and thus be able to inspect them from all sides. It frequently occurs also that the isolation is not quite complete, and one can see in the clearest manner the relations of the cells or fibers to one another.

The chemical agents or solutions for isolating are, in general, the same as those used for hardening and fixing. But the solutions are only about one-tenth as strong as for fixing, and the action is very much shorter, that is, from one or two hours to as many days. In the weak solution the cell cement or connective tissue is softened so that the cells and fibers may be separated from one another, and at the same time the cells are preserved. In fixing and hardening, on the other hand, the cell cement, like the other parts of the tissue, is made firmer. In preparing the isolating solutions it is better to dilute the fixing agents with normal salt solution than merely with water (§ 399).



FIG. A.

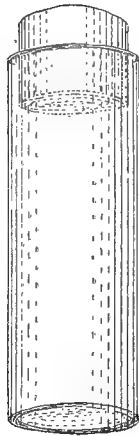

FIG. B.

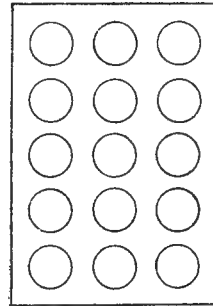

FIG. 206

FIG. 205 A. B. *Preparation Vials for Histology and Embryology.* This represents the two vials, natural size, that have been found most useful. They are kept in blocks with holes of the proper size.

Fig. 206: *Block with holes for containing shell vials.*

§ 359. **Example of Isolation.**—Place a piece of the trachea of a very recently killed animal, or the roof of a frog's mouth, in formaldehyde dissociator in a shell vial or glass box. After half an hour, up to two or three days, excellent preparations of ciliated cells may be obtained by scraping the trachea or roof of the mouth and mounting the scrapings on a slide. If one proceeds after one hour, probably most of the cells will cling together, and in the various clumps will appear cells on end showing the cilia or the bases of the cells, and other clumps will show the cells in profile. By tapping the cover gently with a needle holder or other light object the cells will separate from one another, and many fully isolated cells will be seen.

§ 358. **Isolation by Means of Formaldehyde.**—Formaldehyde in normal salt solution is one of the very best dissociating agents for brain tissue and all the forms of epithelium. It is prepared as follows: 2 cc. of formal, (that is, a 40% solution of formaldehyde) are mixed with 1000 cc. of normal salt solution. This acts quickly and preserves delicate structures like the cilia of ordinary epithelia, and also of the endymal cells of the brain. It is satisfactory for isolating the nerve cells of the brain. For the epithelium of the trachea, intestines, etc., the action is sufficient in half an hour; good preparations may also be obtained any time within two days or more. The action on nerve tissue of the brain and myel or spinal cord is about as rapid.

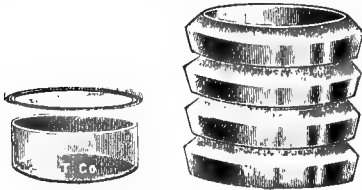

FIG. 207-208. *Slender dish and Syracuse watch glasses for use in making isolations etc. (Cuts loaned by the Whitall Tatum Co.)*

§ 360. **Staining the Cells.**—Almost any stain may be used for the formalin dissociated cells. For example, one may use eosin. This may be drawn under the cover of the already mounted preparation (Fig. 201), or a new preparation may be made and the scrapings mixed with a drop of eosin before putting on the cover-glass. It is an advantage to study unstained preparations, otherwise one might obtain the erroneous opinion that the structure cannot be seen unless it is stained. The stain makes the structural features somewhat plainer; it also accentuates some features and does not affect others so markedly. Congo red is excellent for most isolated cells.

§ 361. **Permanent Preparations of Isolated Cells.**—If one desires to make a permanent preparation of isolated cells it may be done by placing a drop of glycerin at the edge of the cover and allowing it to diffuse under the cover, or the diffusion may be hurried by using a piece of blotting paper, as shown in Fig. 201. One may also make a new preparation by mixing thoroughly some of the isolated material with congo-glycerin. After a few minutes the cover-glass may be put on and sealed (§ 351). If one adds congo-glycerin to a considerable amount of the isolated material it may be kept and used at any time.

§ 362. **Isolation of Muscular Fibers.**—For this the formal dissociator may be used (§ 358), but the nitric acid method is more successful (§ 420). The fresh muscle is placed in this in a glass vessel. At the ordinary temperature of a sitting room (20 degrees centigrade) the connective tissue will be so far gelatinized in from one to three days that it is easy to separate the fascicles and fibers either with needles or by shaking in a test tube or shell vial (Fig. 205) with water. It takes longer for some muscles to dissociate than others, even at the same temperature, so one must try occasionally to see if the action is sufficient. When it is, the acid is poured off and the muscles washed gently with water to remove the acid. If one is ready to make the preparations at once they may be isolated and mounted in water. If it is desired to keep the specimen indefinitely or several days, the water should be poured off and 2% formaldehyde added. The specimens may be mounted in glycerin, glycerin jelly or balsam. Glycerin jelly is the most satisfactory, however.

ARRANGING AND MOUNTING MINUTE OBJECTS

§ 363. Minute objects like diatoms or the scales of insects may be arranged in geometrical figures or in some fanciful way, either for ornament or more satisfactory study. To do this the cover-glass is placed over the guide. This guide for geometrical figures may be a net-micrometer or a series of concentric circles. In order that the objects may remain in place, however, they must be fastened to the cover-glass. As an adhesive substance, mucilage or liquid gelatin (§ 415) thinned with an equal volume of 50% acetic acid answers well. A very thin coating of this is spread on the cover with a needle, or in some other way and allowed to dry. The objects are then placed on the gelatinized side of the cover and carefully got into position with a mechanical finger, made by fastening a cat's whisker in a needle holder. For most of these objects a simple microscope with stand (Figs. 149, 164) will be found of great advantage. After the objects are arranged, one breathes very gently on the cover-glass to soften the mucilage or gelatin. It is then allowed to dry and if a suitable amount of gelatin has been used, and it has been properly moistened, the objects will be found firmly anchored. In mounting one may use Canada balsam or mount dry on a cell (§ 343, 353). See Newcomer, *Amer. Micr. Soc.'s Proc.*, 1886, p. 128; see also E. H. Griffith and H. L. Smith, *Amer. Jour. of Micros.*, iv, 102, v, 87; *Amer. Monthly Micr. Jour.*, i, 66, 107, 113. Cunningham, *The Microscope*, viii, 1888, p. 237.

LABELING, CATALOGING AND STORING MICROSCOPIC PREPARATIONS

§ 364. Every person possessing a microscopic preparation is interested in its proper management; but it is especially to the teacher and investigator that the labeling, cataloging and storing of microscopic preparations are of importance. "To the investigator, his specimens are the most precious of his possessions, for they contain the facts which he tries to interpret, and they

remain the same while his knowledge, and hence his power of interpretation, increase. They thus form the basis of further or more correct knowledge; but in order to be safe guides for the student, teacher, or investigator, it seems to the writer that every preparation should possess two things: viz, a label and a catalog or history. This catalog should indicate all that is known of a specimen at the time of its preparation, and all of the processes by which it is treated. It is only by the possession of such a complete knowledge of the entire history of a preparation that one is able to judge with certainty of the comparative excellence of methods, and thus to discard or improve those which are defective. The teacher, as well as the investigator, should have this information in an accessible form, so that not only he, but his students can obtain at any time, all necessary information concerning the preparations which serve him as illustrations and them as examples."

§ 365. **Labeling Ordinary Microscopic Preparations.**—The label should possess at least the following information.

The No. of the preparation, its name and date and the thickness of the sections and of the cover-glass.

NO.	540	c. 15
		s. 10 μ
Liver of Pig		
DATE.	Oct. 4/97	

FIG. 209. Example of a label of an ordinary histologic specimen. (See also Fig. 159 for serial sections)

§ 366. **Cataloging Preparations.**—It is believed from personal experience, and from the experience of others, that each preparation (each slide or each series) should be accompanied by a catalog containing at least the information suggested in the following formula. This formula is very flexible, so that the order may be changed, and numbers not applicable in a given case may be omitted. With many objects, especially embryos and small animals, the time of fixing and hardening may be months and even years earlier than the time of imbedding. So, too, an object may be sectioned a long time after it was imbedded, and finally the sections may not be mounted at the time they are cut. It would be well in such cases to give the date of fixing under 2, and under 5, 6 and 8, the dates at which the operations were performed if they differ from the original date and from one another. In brief, the more that is known about a preparation the greater its value.

§ 367. **General Formula for Cataloging Microscopic Preparations:**

1. The general name and source. Thickness of cover-glass and of section.
2. The number of the preparation and the date of obtaining and fixing the specimen; the name of the preparator.
3. The special name of the preparation and the common and scientific name of the object from which it is derived. Purpose of the preparation.
4. The age and condition of the object from which the preparation is

derived. Condition of rest or activity ; fasting or full fed at the time of death.

5. The chemical treatment,—the method of fixing, hardening, dissociating, etc., and the time required.

6. The mechanical treatment,—imbedded, sectioned, dissected with needles, etc. Date at which done.

7. The staining agent or agents and the time required for staining.

8. Dehydrating and clearing agent, mounting medium, cement used for sealing.

9. The objectives and other accessories (micro-spectroscope, polarizer, etc.,) for studying the preparation.

10. Remarks, including references to original papers, or to good figures and descriptions in books.

‡ 368. A Catalog Card Written According to this Formula :

Muscular Fibers. Cat.

C. 0.15 mm.

Fibers 20 to 40 μ thick.

2. No. 475. (Drr. IX) Oct. 1, 1891. S. H. G., Preparator.

3. Tendinous and intra-muscular terminations of striated muscular fibers from the *Sartorius* of the cat (*Felis domestica*).

4. Cat eight months old, healthy and well nourished. Fasting and quiet for 12 hours.

5. Muscle pinned on cork with vaselined pins and placed in 20 per cent nitric acid immediately after death by chloroform. Left 36 hours in the acid; temperature 20° C. In alum water ($\frac{1}{2}$ sat. aq. sol.) 1 day.

6. Fibers separated on the slide with needles, Oct. 3.

7. Stained 5 minutes with Delafield's hematoxylin.

8. Dehydrated with 95% alcohol 5 minutes, cleared 5 minutes with carbolturpentine, mounted in xylene balsam ; sealed with shellac.

9. Use a 16 mm. for the general appearance of the fibers, then a 2 or 3 mm. objective for the details of structure. Try the micro-polariscope (§ 240, 248).

10. The nuclei or muscle corpuscles are very large and numerous ; many of the intra-muscular ends are branched. See S. P. Gage, Proc. Amer. Micr. Soc., 1890, p. 132 ; Ref. Hand-book Med., Sci., Vol. V., p. 59.

‡ 369. General Remarks on Catalogs and Labels.—It is especially desirable that labels and catalogs shall be written with some imperishable ink. Some form of water-proof carbon ink is the most available and satisfactory. The water-proof India ink, or the engrossing carbon ink of Higgins, answers well. As purchased, the last is too thick for ordinary writing and should be diluted with one-third its volume of water and a few drops of strong ammonia added.

If one has a writing diamond it is a good plan to write a label with it on one end of the slide. It is best to have the paper label also, as it can be more easily read.

The author has found stiff cards, $12\frac{1}{2} \times 7\frac{1}{2}$ cm., like those used for cataloging books in public libraries, the most desirable form of catalog. A specimen that is for any cause discarded has its catalog card destroyed or stored apart from the regular catalog. New cards may then be added in alphabetical order as the preparations are made. In fact a catalog on cards has all the flexibility and advantage of the slip system of notes (See Wilder & Gage, p. 45).

Some workers prefer a book catalog. Very excellent book catalogs have been devised by Alling and by Ward (Jour. Roy. Micr. Soc., 1887, pp. 173, 348; Amer. Monthly Micr. Jour., 1890, p. 91; Amer. Micr. Soc. Proc., 1887, p. 233).

The fourth division has been added as there is coming to be a strong belief, practically amounting to a certainty, that there is a different structural appearance in many if not all of the tissue elements depending upon the age of the animal, upon its condition of rest or fatigue; and for the cells of the digestive organs, whether the animal is fasting or full fed. Indeed as *physiological histology* is recognized as the only true histology, there will be an effort to determine exact data concerning the animal from which the tissues are derived. (See Minot, Proc. Amer. Assoc. Adv. Science, 1890, pp. 271-289; Hodge, on nerve cells in rest and fatigue, Jour. Morph., vol. VII. (1892), pp. 95-168; Jour. Physiol., vol. XVII., pp. 129-134; Gage, The processes of life revealed by the microscope; a plea for physiological histology, Proc. Amer. Micr. Soc., vol. XVII. (1895), pp. 3-29; Science, vol. II., Aug. 23, 1895, pp. 209-218. Smithsonian Institution; Report for 1890, pp. 381-396.

CABINET FOR MICROSCOPIC PREPARATIONS

§ 370. While it is desirable that microscopic preparations should be properly labeled and cataloged, it is equally important that they should be protected from injury. During the last few years several forms of cabinets or slide holders have been devised. Some are very cheap and convenient where one has but a few slides. For a laboratory or for a private collection where the slides are numerous the following characters seem to the writer essential:

(1). The cabinet should allow the slides to lie flat, and exclude dust and light.

(2). Each slide or pair of slides should be in a separate compartment. At each end of the compartment should be a groove or bevel, so that upon depressing either end of the slide the other may be easily grasped (Fig. 210). It is also desirable to have the floor of the compartment grooved so that the slide rests only on two edges, thus preventing soiling the slide opposite the object.

(3). Each compartment or each space sufficient to contain one slide of the standard size should be numbered, preferably at each end. If the compartments are made of sufficient width to receive two slides, then the double slides so frequently used in mounting serial sections may be put into the cabinet in any place desired.

(4). The drawers of the cabinet should be entirely independent, so that

any drawer may be partly or wholly removed without disturbing any of the others.

FIG. 210. A part of a cabinet drawer seen from above. In compartment No. 96 is represented a slide lying flat. The label of the slide and the number of the compartment are so placed that the number of the compartment may be seen through the slide. The sealing cement is removed at one place to show that in sealing the cover-glass, the cement is put partly on the cover and partly on the slide.

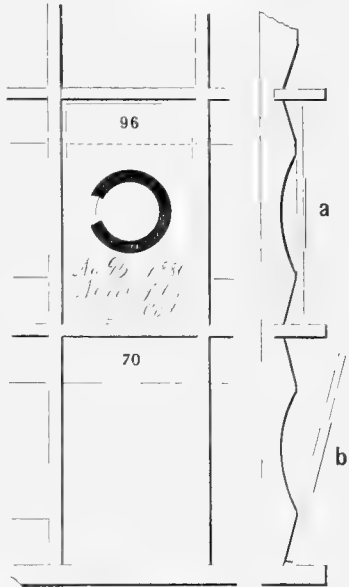

B.—This represents a section of the same part of the drawer. (a) Slide resting as in a. No. 96. The preparation is seen to be above a groove in the floor of the compartment. (b) One end of the slide is seen to be uplifted by depressing the other into the bevel.

FIG. 211. Cabinet for Microscopic Specimens, showing the method of arranging the drawers and indicating the number of the first and last compartment in each drawer. It is better to have the slides on which the drawers rest somewhat shorter, then the drawer front may be entire and not notched as here shown. (From Proc. Amer. Micr. Soc., 1883.)

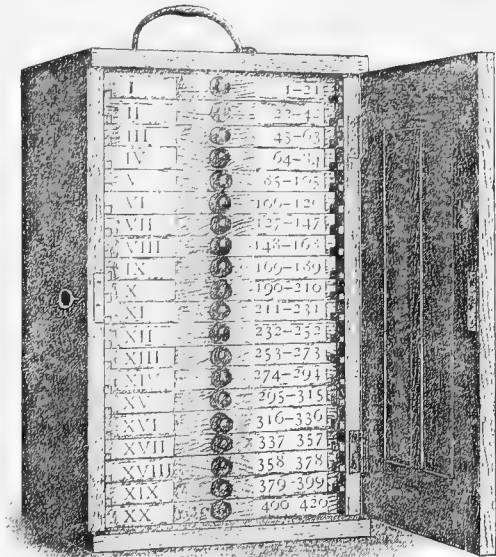

(5). On the front of each drawer should be the number of the drawer in Roman numerals, and the number of the first and last compartment in the drawer in Arabic numerals (Fig. 211).

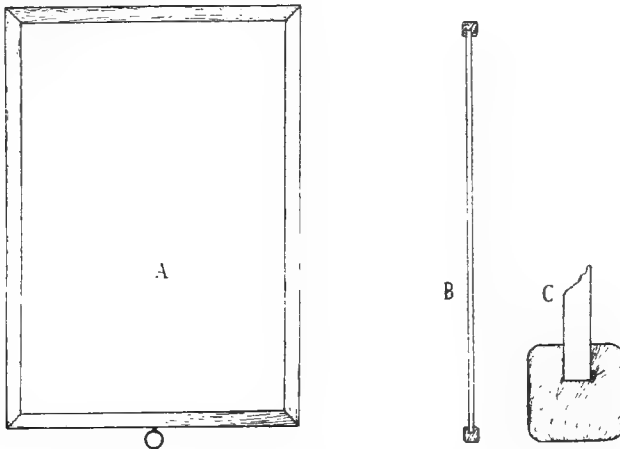

FIG. 212. *Trays for slides and for ribbons of sections. The figures show the construction. It is important to have the bordering frame with rounded corners so that the trays may be easily pulled out of a pile or reinserted. The screw eye shown in A makes it easy to pull out a single tray. For ribbons of sections a piece of paper is placed in the tray and the ribbons are placed on it. (A) Face view, (B) Sectional view of the whole tray, (C) Sectional view of one side (natural size) to show the construction more clearly. These trays are about 30 x 44 centimeters (11 3/4 x 17 1/4 in.), and hold 50 1 x 3 in. slides, i. e., 5 rows 10 in a row. Trays of this kind are so cheap (\$17.50 per hundred for those holding 50 to 60 slides), that a laboratory can have all that are needed. (Trans. Amer. Micr. Soc., 1899, p. 107.)*

§ 371. **Trays for Slides and Ribbons of Sections.**—Early in 1897 the writer devised the simple tray shown in Fig. 212. It was designed especially for the ribbons of sections in preparing embryologic series and for material for class work. As will be seen by the figure the two sides are alike and the tray is very shallow. It was soon found that the wood forming the bottom of the tray was too rough for ribbons of sections and smooth white paper was put in the tray before the ribbons were laid upon it.

These trays were soon used for the mounted preparations as well as for the ribbons of sections. They were made of a proper size to fit the laboratory lockers (Fig. 214); and naturally came to be used for storage instead of the expensive slide cabinets shown in Figs. 210-211. For this purpose five could be put in a single compartment of the locker or 35 in an entire locker. As each tray holds fifty slides 1 x 3 in.; 37, 1 1/2 x 3 and 25 slides 2 x 3 in., the saving of space was very great.

§ 372. **Slide Trays with Tongue and Groove.**—In the first trays the edges were square and sharp. These were rounded in later trays, but there still remained a defect, for if one wished to pile up five to twenty trays on the table, they would not stay in an even stack. To remedy this defect the long way of the frame was tongued on one side and grooved on the other as shown in Fig. 213. This is a great improvement as one can make even stacks of 25 or 50 trays, and they will stay in position. Furthermore it renders the groups of 5 trays stored in the locker compartments much easier to manage, as one can remove any of the five trays without getting the others disarranged as so often occurred with the old form, lacking tongue and groove.

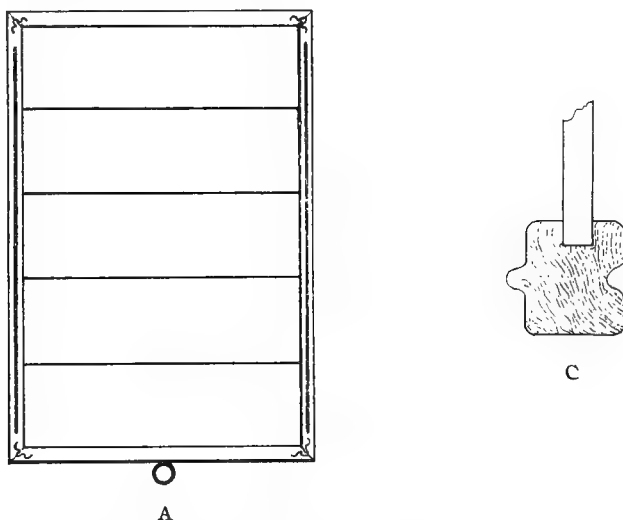

FIG. 213. *Slide Tray with Cross Pieces on one Face to retain the Slides in Rows.* (Dr. Greenman's improvement.) *A* tongue and groove serve to hold the trays in position when they are piled up. (*A*, about 1-8, and *C*, about natural size.) The corners of the tray frame are held in place by the corrugated pieces of iron used in the construction of picture frames.

§ 373. **Slide Trays with One Side Divided.**—A defect of the trays for storage is the ease with which the slides get disarranged unless the tray is entirely full. To avoid this defect Dr. M. J. Greenman of the Wistar Institute divides one face into rows of the right width for receiving the slides. Then while the slides in any single row might get displaced those of neighboring rows cannot become mixed (Fig. 213 A.). One side of this tray is smooth and can be used for ribbons of sections like the original tray. Dr. Greenman stores the trays in metal cabinets, each tray having a separate pair of "runs" as is shown in Fig. 211. The author of this book adds the cross pieces to divide the tray into rows and also has the frame grooved and tongued (§ 372). Thus

constructed the tray is very reasonable in price and most useful for the needs of a modern biologic laboratory.*

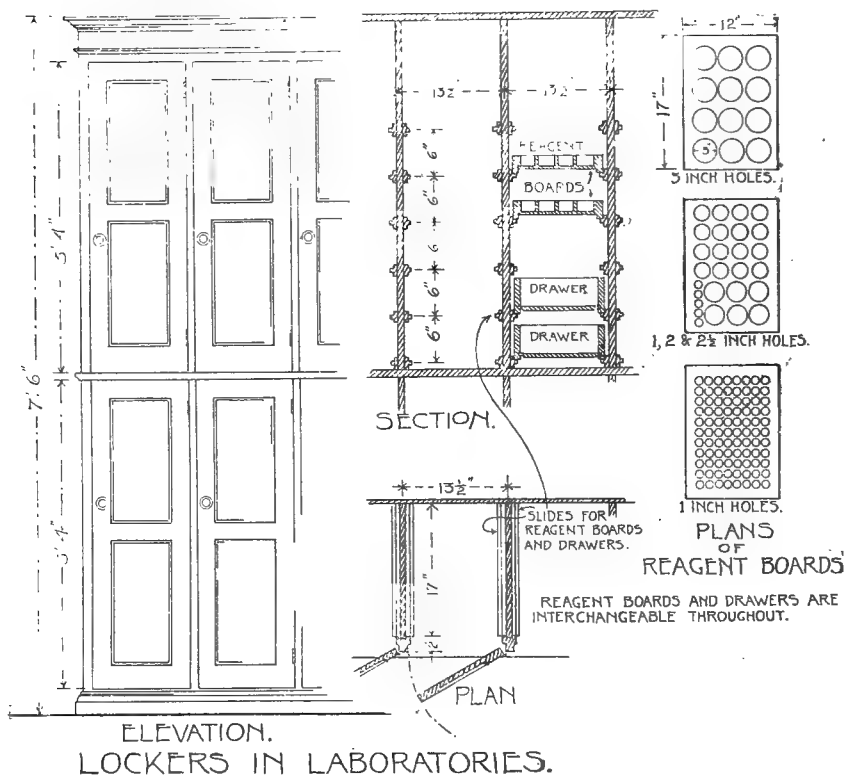

FIG. 214. Student Locker with trays and reagent boards.
(*Jour. Appl. Micr.* 1898, p. 127.)

PREPARATION OF REAGENTS

§ 374. **General on Preparation of Reagents.**—In preparing reagents both weights and measures are used. As a rule the amounts given are those which experience has shown to give good results. Variations in the proportions of the mixtures are sometimes advantageous, and in almost every case a slight change in the proportions makes no difference. Most laboratory reagents are

* In Ithaca, these trays are made and furnished by the H. J. Bool Furniture Co. The cost per 100 of the original form is \$17.50 (§ 371); for the form with tongue and groove, it is \$22.50; and for the form with tongue and groove and one side divided into rows (§ 373), the cost is \$30 per hundred.

like food, good even under quite diverse proportions and methods of preparation. With a few, however, it is necessary to have definite strengths.



FIGS. 215-217. *Graduates of various forms for measuring liquids.*
(Cuts loaned by the Whitall Tatum Co.)

By a *saturated solution* is meant one in which the liquid has dissolved all that it can of the substance added. This varies with the temperature. It is well to have an excess of the substance present then the liquid will be saturated at all temperatures usually found in the laboratory.

§ 375. **Solutions less than 10 per cent.**—In making solutions where dry substance is added to a liquid if the percentage is not over 10%, the custom is to take 100 cc. of the liquid and add to it the number of grams indicated by the per cent. That is for a 5% solution one would take 100 cc. of the liquid and 5 grams of the dry substance. This does not make a strictly 5% solution. For that one should take 95 cc. of liquid and 5 grams of the dry substance; or if the percentage must be exact then one should weigh out 95 grams of the liquid and add 5 grams of the dry substance.

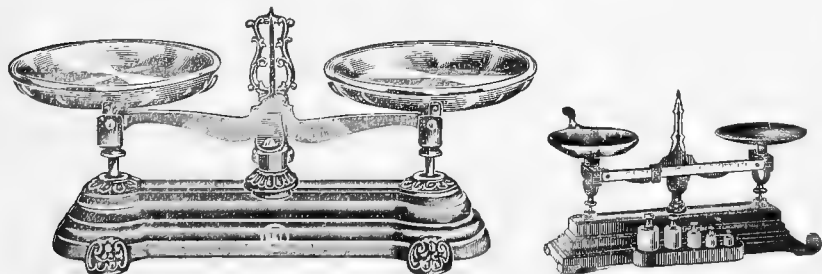

FIGS. 218-219. *Scales for weighing chemicals.* (Cuts loaned by the Bausch & Lomb Optical Company.)

§ 376. **Solutions of 10 per cent and more.**—When the percentage is 10% or

over it is better to weigh out the number of grams representing the percentage and add to it the right amount of liquid in cubic centimeters. For example if one were to make a 35% aqueous solution of caustic potash in water then one would add 35 grams of caustic potash to 65 cc. of water. If one wished to make a 10% alcoholic solution of caustic potash he would add 10 grams of caustic potash to 90 cc. of alcohol. But here is a case where the alcohol being of less specific gravity than water the mixture would not weigh 100 grams; and to make the mixture weigh 100 grams giving therefore an exact percentage, one should take 90 grams of alcohol and add to it 10 grams of caustic potash. In practice in making solutions of collodion or celloidin one usually mixes alcohol and 95% or absolute alcohol in equal volumes and then for a 10% solution 10 grams of the dry soluble cotton or celloidin are added to 90 cc. of the ether-alcohol mixture. But ether is much lighter than water and the alcohol somewhat lighter, so that the percentage in this case would be more than 10% because the 90 cc. of alcohol and ether would weigh considerably less than 90 grams.

‡ 377. **Mixtures of Liquids to Obtain a desired Percentage.**—It frequently happens that it is desired to obtain a lower percentage or strength of a liquid than the one in stock. This is very readily done according to the general formula: Divide the percentage of the strong solution by the percentage of the desired solution and the quotient will give the number of times too strong the solution is. To obtain the right strength take 1 of the strong solution, and of the diluting liquid one less than the quotient obtained by dividing the percentage of the strong solution by the percentage of the weak solution, thus; Suppose it is desired to obtain a 5% solution of formaldehyde. As the strong solution obtainable in the market is a 40% aqueous solution of formaldehyde gas it is 8 times too strong for the desired solution. To get the proper strength one takes 1 cc. of the 40% formaldehyde and adds to it 7 cc. of water and the resulting mixture will be only $\frac{1}{8}$ the strength of the original solution or 5% instead of 40%.

‡ 378. **Mixtures of Alcohol.**—For alcohol if one desires a 50% solution it is usually near enough correct to add equal parts of 95% alcohol and water, but this does not actually give a 50% solution. To find the real proportions according to the general formula: $95\% \div 50\% = 1.9$ *i. e.*, for every 1 cc. of 95% alcohol should be added 0.9 cc. of water or for each 100 cc. of 95% alcohol, 90 cc. of water. This even will not give an exact mixture of alcohol for a mixture of alcohol and water diminishes somewhat in volume. To get true percentages an alcoholometer for testing the specific gravity is used.

A simple method of getting approximately correct mixtures of alcohol is the following: Pour the strong alcohol into a graduate glass (Fig. 215-217) until the volume is the same as the desired percentage, then add water until the volume is the same as the original percentage of the alcohol. Example: To get 50% from 95% alcohol put 50 cc. of 95% into a graduate and fill the graduate to 95 cc. with water, and the resulting mixture will be 50% alcohol, and so with all other strengths. Here the shrinkage is eliminated from consideration because the water and alcohol are not measured separately and then mixed, but one is added to the other until a given volume is attained.

SOME OF THE MORE IMPORTANT REAGENTS USED IN MICROSCOPY

§ 379. **Albumen Fixative (Mayer's).**—This consists of equal parts of well-beaten white of egg and glycerin. To each 50 cc. of this 1 gram of salicylate of soda is added to prevent putrefactive changes. This must be carefully filtered. For method of use see Ch. X. § 448.

§ 380. **Alcohol (Ethyl), C_2H_5O .**—Ethyl or grain alcohol is mostly used for histologic purposes. (A) absolute alcohol (*i. e.*, alcohol of 99%) is recommended for many purposes, but if plenty of 95% alcohol is used it answers every purpose in histology, in a dry climate or in a warm, dry room. When it is damp, dehydration is greatly facilitated by the use of absolute alcohol.

(B) 82% alcohol made by mixing 5 parts of 95% alcohol with 1 part of water.

(C) 67% alcohol made by mixing 2 parts of 95% alcohol with 1 part of water. See also § 378-379.



FIG. 220. *Reagent bottle. (Cut loaned by the Whitall Tatum Co.)*

§ 381. **Alcohol (Methyl) $C-H_3O$.**—Methyl alcohol or wood alcohol is much cheaper than ethyl or grain alcohol on account of the revenue tax on ethyl alcohol. It answers well for many microscopic purposes. It has been refined so carefully in recent years that the disagreeable odor is not very noticeable.

§ 382. **Denatured Alcohol.**—This is Ethyl or grain alcohol rendered undrinkable by the addition of wood alcohol and benzine (Grain alcohol, 89½%; Methyl alcohol 10%, and Benzine ½%). In some cases the denaturing substances are somewhat different, but all render the alcohol unusable for drinking. It is then free from internal revenue tax.

In Great Britain "*Methylated Spirits*" consists of grain alcohol with 10% methyl alcohol. This is used very largely in microscopic work. In America the addition of the Benzine renders denatured alcohol also unfit for histological purposes if it is to be diluted. The addition of water makes it milky. If methyl alcohol alone or combined with pyridin or some other substance wholly

soluble in water were used as the denaturing substance, denatured alcohol could be used in microscopic work for all the grades. That denatured as indicated above can be used only in full strength or very slightly diluted.

For educational and other public institutions the U. S. government grants the privilege of using ethyl alcohol without paying the revenue tax, but for private institutions and for individuals it would be a great relief if the denatured alcohol could be mixed in all proportions with water without the formation of precipitates.

§ 383. **Balsam, Canada Balsam, Balsam of Fir.**—This is one of the oldest and most satisfactory of the resinous media used for mounting microscopic preparations.

The natural balsam is most often used; it has the advantage of being able to take up a small amount of water so that if sections are not quite dehydrated they will clear up after a time.

§ 384. **Xylene Balsam.**—This is Canada Balsam diluted or thinned with xylene (xylol of the Germans). It is recommended by many to evaporate the natural balsam to dryness and then dissolve it in xylene. For some purposes, *e. g.*: for mounting glycogen preparations, this is advantageous; but it is unnecessary for most purposes. Xylene balsam requires a very complete desiccation or dehydration of objects to be mounted in it for the xylene is immiscible with water.

§ 385. **Filtering Balsam.** Balsam is now furnished already filtered through filter paper. If xylene balsam is used it may be made thin and filtered without heat. For filtering balsam and all resinous and gummy materials, the writer has found a paper funnel the most satisfactory. It can be used once and then thrown away. Such a funnel may be easily made by rolling a sheet of thick writing paper in the form of a cone and cementing the paper where it overlaps, or winding a string several times around the lower part. Such a funnel is best used in one of the rings for holding funnels, so common in chemical laboratories. The filtering is most successfully done in a very warm place like an incubator or an incubator room.

§ 386. **Neutral Balsam.**—All the samples of balsam tested by the author have been found slightly acid. This is an advantage for carmine, and acid fuchsin stain or any other acid stain. Also for preparations injected with carmine or Berlin blue. In these cases the color would fade or diffuse if the medium were not slightly acid. For hematoxylin and many other stains the acid is detrimental. For example, the slight amount of acid in the balsam causes the delicate stain in the finest fibers of Weigert preparations to fade. To neutralize the balsam add some pure sodium carbonate, set the balsam in a warm place and shake it occasionally. After a month or so the soda will settle and the clear supernatant balsam will be found very slightly alkaline. Use this whenever an acid medium would fade the stain in the specimen.

§ 387. **Acid Balsam.**—As stated above all balsam is naturally somewhat acid, but for various stains it is desirable to increase the acidity. For example, specimens stained with picro-fuchsin, or injected with carmine or

Berlin blue are more satisfactory and last longer with full brilliancy if the balsam is made more acid than it naturally is. For this use 10 to 20 drops of glacial acetic or formic acid to 100 cc. of balsam.

‡ 388. **Borax Carmine for in Toto Staining.**—Borax 4 grams; Carmine 3 grams; water 100 cc. Shake frequently for several days and then filter and add 100 cc. of 67% alcohol. After 3 to 4 days it may be necessary to filter again. Good for *in toto* staining after almost any fixer. Put the object to be stained from alcohol into a vial with plenty of stain. After a day or two change the stain. Stain 4 to 5 days. Remove to 67% alcohol adding 4 drops of H Cl to each 100 cc. of alcohol. After one day remove to 82% alcohol. Change the alcohol till no more color comes away, then proceed to section. Remember that objects stained *in toto* may be mounted directly in balsam from de-paraffining xylene.

‡ 389. **Carmine for Mucus (Mucicarmin).**—One can buy the dry powder or preferably prepare the stain. To prepare it take 1 gram of Carmine No. 40 and ½ gram of pure dry ammonium chlorid. If the latter is slightly moist, dry it in an evaporating dish in a sand bath. Mix the ammonium chlorid and the carmine and add 2 cc. of water. Mix well and heat over a sand bath, constantly mixing with a glass rod. Continue the heating until the carmin colored mass becomes very dark red. It will take 3 to 10 minutes for this. The heat should not be too great.

Dissolve the dark red mixture in 100 cc. of 50% alcohol. For use, dilute five or tenfold with tap water. This stains best after mercuric fixers. One must not collodionize sections to be stained with this as the carmine stains the collodion very deeply. Stain the sections first with hematoxylin as usual then stain 1 to 5 hours or longer with the dilute mucicarmin. The mucus in goblet cells, in the mucous part of the salivary glands, etc., will be red. Nuclei will be stained with hematoxylin. Mount in balsam (‡ 383).

‡ 390. **Cedar-Wood Oil.**—This is used for oil immersion objectives and is quite thick.

For penetrating tissues and preparing them for infiltration with paraffin, thick oil is recommended by Lee. The writer has found, however, that any good cedar-wood oil gives excellent results in ordinary histologic and embryologic work. That known as Cedar-Wood Oil (Florida) is excellent, also that known as Cedar-Wood Oil (true Lebanon). These forms are far less expensive than that used for immersion objectives. The tissues should be thoroughly dehydrated before putting them into cedar-wood oil, and they should remain until they are translucent.

‡ 391. **Clarifier, Castor-Xylene Clarifier.**—This is composed of castor oil 1 part and xylene* 3 parts. (Trans. Amer. Micr. Soc., 1895, p. 361.)

* The hydrocarbon, xylene (C_8H_{10}) is called xylol in German. In English, members of the hydrocarbon series have the termination "ene" while members of the alcohol series terminate in "ol."

‡ 392. **Carbol-Xylene Clearer.**—Vasale recommends as a clearer, xylene 75 cc., carbolic acid (melted crystals) 25 cc.

‡ 393. **Carbol-Turpentine Clearer.**—A satisfactory and generally applicable clearer is carbol-turpentine, made by mixing carbolic acid crystals (*Acidum carbolicum. A. phenicum crystallizatum*) 40 cc. with rectified oil of turpentine (*Oleum terebinthinae rectificatum*) 60 cc. If the carbolic acid does not dissolve in the turpentine, increase the turpentine, thus: carbolic acid 30 cc., turpentine 70 cc.

This clearer is not so good as the preceding for mounting objects which have been stained with osmic acid as the hydrogen dioxid (H_2O_2) present fades the blackened osmic acid.

‡ 394. **Collodion.**—This is a solution of soluble cotton* or other form of pyroxylin in equal parts of sulfuric ether and 95% or absolute alcohol. Four solutions are used for infiltrating and imbedding.

(1) 1½% Collodion. 95% or absolute alcohol 100 cc.; soluble cotton 3 grams. Let the cotton soak well in the alcohol and then add 100 cc. of sulfuric ether.

(2) 3% Collodion. Soluble cotton 3 grams. 95% or absolute alcohol 50 cc. After the cotton has become well wet with the alcohol add 50 cc. of sulfuric ether.

(3) 6% Collodion. For this take 6 grams of soluble cotton and 50 cc. of absolute alcohol. Let the cotton remain in the alcohol over night and then add the 50 cc. of sulfuric ether.

(4) 8% Collodion. Take 8 grams of soluble cotton and 50 cc. of absolute alcohol. Leave the cotton in the alcohol over night or longer and then add 50 cc. of sulfuric ether.

* The substance used in preparing collodion goes by various names, soluble cotton or collodion cotton is perhaps best. This is cellulose nitrate, and consists of a mixture of cellulose tetranitrate $C_{12}H_{16}(NO_3)_4O_6$, and cellulose pentanitate, $C_{12}H_{15}(NO_3)_5O_7$. Besides the names soluble and collodion cotton, it is called gun cotton and pyroxylin. Pyroxylin is the more general term and includes several of the cellulose nitrates. Celloidin is a patent preparation of pyroxylin, more expensive than soluble cotton.

Soluble cotton should be kept in the dark to avoid decomposition. After it is in solution this decomposition is not so liable to occur. The decomposition of the dry cotton gives rise to nitrous acid, and hence it is best to keep it in a box loosely covered so that the nitrous acid may escape.

Cellulose nitrate is explosive under concussion and when heated to 150° centigrade. In the air, the loose soluble cotton burns without explosion. It is said not to injure the hand if held upon it during ignition and that it does not fire gun powder if burned upon it. So far as known to the writer, no accident has ever occurred from the use of soluble cotton for microscopic purposes. I wish to express my thanks to Professor W. R. Orndorff, organic chemist in Cornell University, for the above information. Proc. Amer. Micr. Soc., vol. XVII (1895), pp. 361-370.

All collodion solutions should be kept well corked or the ether will evaporate, also some of the alcohol, and leave the soluble cotton as a kind of jelly.

‡ 395. **Collodion for Cementing Sections to the Slide.**—This is a $\frac{3}{4}\%$ solution made by adding $\frac{3}{4}$ gram of soluble cotton to 50 cc. of 95% or absolute alcohol and 50 cc. of sulfuric ether. This may be used for spreading on the sections before deparaffining or preferably afterward. See ‡ 450.

‡ 396. **Congo Red.**—Water 100 cc., Congo red $\frac{1}{2}$ gram. This is a good counter stain for hematoxylin.

‡ 397. **Congo-Glycerin.**—For mixing with and staining isolation preparations (‡ 357–361) and for a mounting medium this is an excellent combination. It is particularly good for nerve cells.

‡ 398. **Decalcifier.**—For removing the salts of lime from bone etc. One must first fix and harden the tissue by some approved method. 67% Alcohol 100 cc.; strong nitric acid 3 cc. Change two or three times. It takes from 3 to 10 days depending on the object. One can tell when the decalcification is complete by inserting a needle. If there is no gritty feeling the work is done. Then wash a few minutes in water and transfer to 67% alcohol. Then after 24 hours use 82% alcohol. It is usually better to section by the collodion method. Tissue is liable to deteriorate after being decalcified, so section it soon.

‡ 399. **Dissociating Liquids.**—These liquids are for preserving the tissue elements or cells and for dissolving or softening the intercellular substance so that the cells may be readily separated from their neighbors. The separation is accomplished by (a) teasing with needles; (b) shaking in a liquid in a test tube; (c) scraping with a scalpel and crushing with the flat of the blade; (d) by tapping sharply on the cover-glass after the object is mounted. One may find it desirable to use (d) with all the methods.

(1) **Formaldehyde Dissociator.**—Strong formalin (40% formaldehyde gas in water) 2 cc. Normal salt solution 1000 cc. One can begin work within $\frac{1}{2}$ hour and good results may be obtained after 2 to 3 days immersion. Excellent for epithelia and for nerve cells.

(2) **Müller's Fluid Dissociator.**—Müller's Fluid 1 cc. Normal salt solution 9 cc. It usually requires from 1 to 5 days for epithelia to dissociate in this. The action is more rapid in a warm place.

(3) **Nitric Acid Dissociator.**—Nitric Acid 20 cc. Water 80 cc. This is used especially for muscular tissue. It takes from one to 3 days depending on the temperature. The nitric acid gelatinizes the connective tissue. Wash out the acid with water. Preserve in 2% formaldehyde.

‡ 400. **Elastic Stain.**—For staining elastic substance the Resorcin basic-fuchsin-Iron-Chlorid of Weigert is available. The stain is prepared as follows.

Basic Fuchsin 2 grams. Resorcin 4 grams. Water 200 cc. Boil for several minutes (5 to 10). Add to the boiling mixture 25 cc. of a 30% aqueous solution of chlorid of iron (Fe Cl 6). Boil for 3 to 10 minutes then add a saturated solution of iron chlorid until the color is all precipitated. Try the

liquid occasionally by letting a few drops run down the side of the glass beaker used for the boiling. If the color is precipitated it appears as fine granules and the liquid is almost uncolored or slightly yellow.

Allow the liquid to cool. If there is plenty of time let it stand over night. Then either pour off the supernatant liquid or if the precipitate has not settled filter through filter paper. Then either scrape off the precipitate from the filter paper or cut off the lower end of the filter containing the precipitate and put it in the beaker. Add 200 cc. of 95% alcohol and heat over a water bath till the alcohol boils. Continue the boiling 5 minutes or more and stir up the filter paper so that all the precipitate may be dissolved. After boiling 5 minutes or more filter the hot alcoholic solution into a warmed bottle. After this alcoholic solution is cool add 5 cc. of strong hydrochloric acid.

Stain sections in this solution 1 hour sometimes less. Wash off the stain with 95% alcohol.

This works well on sections by the paraffin or the collodion method and for tissues hardened in any manner.

§ 401. **Eosin.**—This is used mostly as a contrast stain with hematoxylin, which is an almost purely nuclear stain. It serves to stain the cell-body, ground substance, etc., which would be too transparent and invisible with hematoxylin alone. If eosin is used alone it gives a decided color to the tissue and thus aids in its study. Eosin is used in alcoholic and in aqueous solutions. A very satisfactory stain is made as follows: 50 cc. of water and 50 cc. of 95% alcohol are mixed and 1-10 of a gram of dry eosin added. 1% aqueous eosin is also good.

§ 402. **Eosin in 95 per cent Alcohol.**—For staining embryos and tissues so that the tissue in the ribbons of sections may be easily seen a saturated solution of alcoholic eosin is made. This is also used for staining with methylene blue (see § 471).

§ 403. **Ether, Ether-Alcohol.**—Sulfuric ether is meant when ether is mentioned in this book. Wherever ether-alcohol is mentioned it means a mixture of equal volumes of sulfuric ether and 95% or absolute alcohol.

§ 404. **Farrant's Solution.**—Take 25 grams of clean, dry, gum arabic, 25 cc. of a saturated aqueous solution of arsenious acid; 25 cc. of glycerin. The gum arabic is soaked for several days in the arsenic water, then the glycerin is added and carefully mixed with the dissolved or softened gum arabic.

This medium retains air bubbles with great tenacity. It is much easier to avoid than to get rid of them in mounting.

§ 405. **Flemming's Fluid.**—Water 19 cc.; 1% osmic acid 10 cc.; 10% chromic acid 3 cc.; Glacial acetic acid 2 cc. This osmic fixer is good for very small pieces, 1 to 5 millimeter pieces; thickness not over 2 to 3 mm. Wash out with water 10 to 24 hours. Then 67% alcohol. Also 82% and 95%.

§ 406. **Formaldehyde (H. CHO or OCH₂).**—This is found in the market under the name of "formalin," etc., and consists of a 40% solution of formaldehyde gas in water.

For fixing tissues and embryos a 5% solution is good (Formalin 1 cc., water 7 cc., § 377). A common fixer is 10 cc. formalin, 90 cc. water. This is frequently called 10% formalin, it is however only 4% formaldehyde.

Tissues may stay in this indefinitely. Small pieces are fixed within an hour. Before hardening in alcohol and imbedding, wash out the formalin in running water half an hour, then harden a day or more in 67% and 82% alcohol.

For preserving nitric acid dissociated muscle a 2% formaldehyde solution is good. (Formalin 1 cc., water 19 cc. § 377.) See also § 399 (1) for the formaldehyde dissociator.

§ 407. Glycerin.—(A.) One should have pure glycerin for a mounting medium. It needs no preparation, unless it contains dust when it should be filtered through filter paper or absorbent cotton.

To prepare objects for final mounting, glycerin 50 cc., water 50 cc., forms a good mixture. For many purposes the final mounting in glycerin is made in an acid medium, viz., Glycerin 99 cc., Glacial acetic or formic acid, 1 cc.

By extreme care in mounting and by occasionally adding a fresh coat to the sealing of the cover-glass, glycerin preparations last a long time. They are liable to be disappointing, however. In mounting in glycerin care should be taken to avoid air-bubbles, as they are difficult to get rid of. A specimen need not be discarded, however, unless the air-bubbles are large and numerous. See also Congo glycerin § 397.

§ 408. Glycerin Jelly for Microscopic Specimens.—Soak 25 grams of the best dry gelatin in cold water in a small agate-ware dish. Allow the water to remain until the gelatin is softened. It usually takes about half an hour. When softened, as may be readily determined by taking a little in the fingers, pour off the superfluous water and drain well to get rid of all the water that has not been imbibed by the gelatin. Warm the softened gelatin over a water bath and it will melt in the water it has absorbed. Add about 5 cc. of egg albumen, white of egg; stir it well and then heat the gelatin in the water bath for about half an hour. Do not heat above 75° or 80° C., for if the gelatin is heated too hot it will be transformed into meta-gelatin and will not set when cold. Heat coagulates the albumen and it forms a kind of flocculent precipitate which seems to gather all fine particles of dust, etc., leaving the gelatin perfectly clear. After the gelatin is clarified, filter through a hot flannel filter and mix with an equal volume of glycerin and 5 grams of chloral hydrate and shake thoroughly. If it is allowed to remain in a warm place (*i. e.*, in a place where the gelatin remains melted) the air-bubbles will rise and disappear.

In case the glycerin jelly remains fluid or semi-fluid at the ordinary temperature (18°–20° C.), the gelatin has either been transformed into meta-gelatin by too high a temperature or it contains too much water. The amount of water may be lessened by heating at a moderate temperature over a water bath in an open vessel. This is an excellent mounting medium. Air-bubbles should be avoided in mounting as they do not disappear.

§ 409. Glycerin Jelly for Anatomic Preparations.—Specimens prepared by the Kaiserling method or other satisfactory way may be permanently pre-

served in glycerin jelly prepared as follows: Best clear gelatin, 200 grams. Kaiserling's No. 4 solution, 3000 cc. (Potassium acetate, 100 grams; glycerin, 200 cc.; water, 1000 cc.) Put the gelatin in the potassium-acetate-glycerin-water, mixture in an agate pail and heat over a gas or other stove. Stir. When the temperature is about 55° centigrade add the whites of three eggs well beaten, and stir them in vigorously. Make markedly acid by acetic acid. Continue the heating until the mixture just boils, and then filter through filter paper into fruit jars. It is best to put over the filter paper two thicknesses of gauze (§ 330). A piece of thymol in the top of each jar will prevent the growth of fungi, or one can add 5% chloral hydrate. Specimens are mounted in this jelly directly from the No. 4 Kaiserlings, or alcoholic specimens can be soaked in water an hour or more and then kept in some of the melted jelly until well soaked, then mount permanently in the glycerin jelly. At the time of mounting the gelatin is liquified over a water bath, and for every 20 cc. of the gelatin used one drop of strong formalin is added. This is to prevent the liquifaction of the gelatin after the specimen is mounted. Let the gelatin cool gradually after the specimen is in place, then add some melted gelatin to make the vessel over full and slide a glass cover on it. This excludes all air. The cover may then be sealed with the clear gelatin or glue used for gluing wood, or the cement used in mending crockery. Finally one can seal with rubber cement if desired. (See W. H. Watters, N. Y. Med. Record, Dec. 22, 1906.)

§ 410. **Chloral Hematoxylin.**—Potash alum 4 grams. Distilled water 125 cc.; Hematoxylin crystals $\frac{1}{10}$ gram. Boil 5 to 10 minutes in an agate dish. After cooling, add 3 grams of chloral hydrate and put into a bottle. This will stain more rapidly after a week or two if the bottle is left uncorked. It takes from 1 to 5 minutes to stain sections. Sometimes a long time. Use after any method of fixation.

It may be prepared for work at once by the addition of a small amount of hydrogen dioxid (H_2O_2).

If the stain is too concentrated it may be diluted with freshly distilled water or with a mixture of water, alum and chloral. If the stain is not sufficiently concentrated, more hematoxylin may be added. Proc. Amer. Micr. Soc., 1892, pp. 125-127).

§ 411. **Hematein.** This is used instead of hematoxylin, as it is believed to give more satisfactory results. Prepare as follows: Put a 5% solution of potash alum in distilled water and boil or leave in a steam sterilizer an hour or two. While warm add 1 per cent of hematein dissolved in a small quantity of alcohol. After the fluid has cooled add 2 grams of chloral for each 100 cc. of solution. (Freeborn, Jour. Ap. Micr., 1900, p. 1056.)

§ 412. **Iodin Stain for Glycogen.**—Iodin $1\frac{1}{2}$ gram; iodid of potassium 3 grams; sodium chlorid $1\frac{1}{2}$ grams; water 300 cc. For very soluble glycogen one can use 50% alcohol 300 cc. instead of water. The iodine stain is the most precise and differential for glycogen. For sectioning tissues or embryos are fixed and hardened in 95% or absolute alcohol. Sectioned by the paraffin method, or by the collodion method, but for permanent preparations the

paraffin method is best (see Ch. X). In spreading the sections use this iodine stain instead of water. Glycogen in the sections stains a mahogany red, and the stain remains for two or more years in the spread paraffin sections. Spread sections may be stained or restained by immersing the slide in iodine stain.

Before mounting permanently deparaffin with xylene, and mount in melted yellow vaseline. Press the cover down gently. Seal with shellac or balsam. (Gage, *Trans. Amer. Micr. Soc.*, 1906.)

§ 413. **Iodin in Alcohol.**—Iodin 10 grams; 95% alcohol 90 cc. This is the strong, stock solution.

For removing the pin-like or granular mercuric crystals from sections of objects fixed in any fixer containing mercury *e. g.*, Zenker's fluid, etc., take 95% alcohol 500 cc. and the 10% iodine solution 5 cc. In some cases where the amount of mercury in the tissue is great one may use 10 or even 15 cc. of the strong stock solution. Rinse the slide well in pure 95% alcohol to remove the iodine after all the crystals have dissolved ($\frac{1}{2}$ an hour or more).

For embryos and tissues fixed in a mercuric fixer one can add several drops of the stock solution to the alcohol containing the tissue and then by changing the alcohol occasionally the mercury will be mostly removed before sectioning. It is readily removed from the sections as just described.

§ 414. **Lamp-Black for Ingestion by Leucocytes.**—Lamp-black, 2 grams; sodium chlorid, 1 gram; gum acacia (gum Arabic), 1 gram; distilled water, 100 cc. Mix all thoroughly in a mortar. The gum arabic is to aid in getting an emulsion of the lamp-black. Filter through one thickness of gauze and one of lens paper. If for a mammal sterilize by boiling. If some of this mixture is injected into an animal, the leucocytes will ingest the carbon particles. Carmine may be used instead of lamp-black, but it is not as good because not so enduring as lamp-black.

§ 415. **Liquid Gelatin.**—Gelatin or clear glue, 75 to 100 grams. Commercial acetic acid (No. 8) 100 cc., water 100 cc., or glacial acetic acid 40 cc. and water 160 cc., 95% alcohol 100 cc., glycerin 15 to 30 cc. Crush the glue and put it into a bottle with the acid, set in a warm place and shake occasionally. After three or more days add the other ingredients. This solution is excellent for fastening paper to glass, wood or paper. The brush must be mounted in a quill or wooden handle. For labels, it is best to use linen paper of moderate thickness. This should be coated with liquid gelatin and allowed to dry. The labels may be cut of any desired size and attached by simply moistening them, as in using postage stamps.

Very excellent blank labels are now furnished by dealers in microscopic supplies, so that it is unnecessary to prepare them one's self, except for special purposes. Those like that shown in Fig. 209 may be had for about \$3 for 10,000.

§ 416. **Mercuric Chlorid (HgCl_2).**—Mercuric chlorid $7\frac{1}{2}$ grams; sodium chlorid 1 gram; water 100 cc. The solution is facilitated by heating in an agate dish. Fix fresh tissue in this 2 to 24 hours. Then transfer to 67% alcohol a day or more and then to 82% alcohol. Tissues fixed in mercuric

chlorid deteriorate, hence it is better to imbed them soon after they are fixed. Crystals of mercury are removed from the sections by the use of iodized alcohol (§ 413).

§ 417. **Alkaline Methylene Blue.**—Methylene blue 2 grams; 95% or absolute alcohol 50 cc.; distilled water 450 cc.; 1% aqueous caustic potash 5 cc. This stain works best after a mercuric fixer or a fixer containing mercuric chlorid, like Zenker's fluid.

§ 418. **Müller's Fluid.**—Potassium dichromate $2\frac{1}{2}$ grams; sodium sulphate, 1 gram; water 100 cc. This is one of the oldest fixers. It must act a long time, two weeks to 10 or 12 weeks. This longer time is for nervous tissue to be stained for the myelin. Lately this fixer has been combined with mercury (see Zenker's fluid below). Before putting the tissue into 67% alcohol it is washed out in running water for 24 hours.

Müller's Fluid 10 cc; normal salt solution 90 cc., forms an excellent dissociator for epithelia, etc. (§ 399).

§ 419. **Neutral Red.**—This is used especially for staining living animals. It is used in very weak solutions: $\frac{1}{10}$ gram red; 1000 cc. of water. Put a few cubic centimeters of this solution into the vessel containing the live animal, or animals. Infusoria stain quickly 10 to 20 minutes or less. Vertebrates may require a few days. Try it on infusoria by adding a drop of the red to several drops of the infusion containing the infusoria. Be sure that there are many animals present. Watch them under the microscope and the color will be seen appearing in the granules of the infusoria. Then one may cover and study with a high power.

§ 420. **Nitric Acid, H-NO₃.**—This is employed for dissociation (Nitric acid Dissociator, Water 80 cc.; Nitric acid 20 cc.); as a fixer, especially for chick embryos in the early stages (Water 90 cc.; Nitric acid, 10 cc.), and as a decalcifier (Nitric acid 3 cc.; 67% alcohol 100 cc.).

§ 421. **Normal Liquids.**—A normal liquid or fluid is one which does not injure or change a fresh tissue put into it. The perfect normal fluids for the tissues of any animal are the fluids of the body (lymph and plasma) of the animal from which the tissue is taken. The lymph or serum of one species of animal may be far from normal for the tissues of another animal.

The commonly used artificial normal fluid is a solution of common salt (sodium Chlorid) in water, the strength varying from $\frac{1}{10}$ to $\frac{9}{10}$ per cent. As indicated above, this normal salt or saline solution is employed in diluting dissociating liquids (§ 399).

§ 422. **Paraffin Wax.**—A histologic laboratory requires two grades of paraffin for ordinary work. These are hard paraffin, melting at about 54° centigrade, and a softer paraffin melting at about 43° centigrade. Usually a mixture of equal parts answers very well. It is economical for a laboratory to buy the paraffin wax in cases of about 200 pounds.

All paraffin for imbedding and sectioning should be filtered through two thicknesses of filter paper. For this, use a metal funnel, heat the paraffin very

hot in a water bath and then heat the funnel occasionally with a Bunsen flame. The warmer the room the easier to filter paraffin.

Filter the paraffin into small porcelain pitchers. If the paraffin oven has a compartment large enough, it is well to keep one of the pitchers in the oven, then the paraffin remains melted and is ready for use at any time.

§ 423. **Picric-Alcohol.**—This is an excellent hardener and fixer for almost all tissues and organs. It is composed of 500 cc. of water and 500 cc. of 95% alcohol, to which 2 grams of picric acid have been added. (It is a $\frac{1}{2}$ % solution of picric acid in 50% alcohol). It acts quickly, in from one to three days. (Proc. Amer. Micr. Soc., Vol. XII, (1890), pp. 120-122).

§ 424. **Picro-Fuchsin.**—10 cc. of a 1% aqueous solution of acid fuchsin; 75 cc. of a saturated aqueous solution of picric acid. Stain deeply with hematoxylin first, then use the picro-fuchsin. Wash off the picro-fuchsin with distilled water. Mount in non-neutralized balsam or better in acid balsam (Balsam 50 cc. glacial acetic acid 5 drops). If the white connective tissue is not red enough increase the amount of acid fuchsin.

§ 425. **Shellac Cement.**—Shellac cement for sealing preparations and for making shallow cells is prepared by adding scale or bleached shellac to 95% alcohol. The bottle should be filled about half full of dry shellac then enough 95% alcohol added to fill the bottle nearly full. The bottle is shaken occasionally and then allowed to stand until a clear stratum of liquid appears on the top. This clear, supernatant liquid is then filtered through filter paper or absorbent cotton, using a paper funnel (§ 358), into an open dish or a wide-mouth bottle. To every 100 cc. of filtered shellac 2 cc. of Venetian turpentine may be added to render it less brittle. The filtered shellac will be too thin, and must be allowed to evaporate till it is of the consistency of thin syrup. It is then put into a capped bottle, and for use, into a small spirit lamp (Fig. 203). In case the cement gets too thick add a small amount of 95% alcohol or some thin shellac. The solution of shellac almost always remains muddy, and in most cases it takes a long time for the flocculent substance to settle. One can quickly obtain a clear solution as follows: When the shellac has had time to thoroughly dissolve, *i. e.*, in a week or two in a warm place, or in less time if the bottle is frequently shaken, a part of the dissolved shellac is poured into a bottle and about one-fourth as much gasolin or benzin added and the two well shaken. After twenty-four hours or so the flocculent, undissolved substance will separate from the shellac solution and rise with the gasolin to the top. The clear solution may then be siphoned off or drawn off from the bottom if one has an aspirating bottle. (R. Hitchcock, Amer. Monthly Micr. Jour., July, 1884, p. 131).

If one desires to color the shellac, the addition of a strong alcoholic solution of some of the coal tar colors is good, but is liable to dissolve in the mounting medium when shellac is used for sealing, A small amount of lamp-black well rubbed up in very thin shellac and filtered, is good to darken the shellac.

§ 426. **Silvering.**—Intercellular substance stains brown or black with nitrate of silver. Use $\frac{1}{4}$ or $\frac{1}{2}$ % aq. sol. on fresh tissue. Stain in the silver

for 1 to 2 minutes then expose to light in water till brown. One may stain afterward with hematoxylin for the nuclei; mount in glycerin, glycerin jelly or in balsam.

§ 427. **Sudan III for Fat.**—Sudan III or azo-benzene-azo- β -naphthol, was introduced by Daddi into histology in 1896 (*Arch. Ital de Biologie*, t. 26. p. 142), as a specific stain for fat. As it is soluble in all forms of fat and oils and in xylene, alcohol, etc., it is impossible to mount specimens in balsam after staining. As the fat of tissues is removed by the reagents used in the paraffin and collodion methods (see Ch. X), only teased, free-hand or frozen sectioned material fresh or fixed in some non-fat dissolving fixer can be used (Müller's fluid and 5% formaldehyde are excellent). The tissues cut free-hand or with the freezing microtome or teased can then be stained with a saturated alcoholic solution of the Sudan. It stains all fat a brilliant red. Preparations can be preserved in glycerin or glycerin jelly. This stain is largely used in Pathology.

Daddi used the substance to feed animals and thus to stain the fat which was laid down in the body while the Sudan was fed.

The fat in the body already deposited remains unstained. This substance then serves to record the deposit of fat in a given period. In 1907 Dr. Oscar Riddle fed Sudan to laying hens, and the fat in the layers of yolk laid down during the feeding was stained red (*Science*, XXVII, 1908, p. 945). For staining the yolks of hens eggs the hen may be fed doses of 20 to 25 milligrams of the Sudan. Eggs so colored hatch as usual, and the chick in utilizing the colored yolk stains its body-fat pink (Susanna P. Gage).

§ 428. **Table Black.**—During the last few years an excellent method of dyeing wood with anilin black has been devised. This black is lustreless, and it is indestructible. It can be removed only by scraping off the wood to a point deeper than the stain has penetrated.

It must be applied to unwaxed or unvarnished wood. If wax, paint or varnish has been used on the tables, that must be first removed by the use of caustic potash or soda or by scraping or planing. Two solutions are needed:

SOLUTION A

Copper sulphate	125 grams
Potassium chlorate or permanganate	125 grams
Water	1000 cc.

Boil these ingredients in an iron kettle until they are dissolved. Apply two coats of the hot solution. Let the first coat dry before applying the second.

SOLUTION B

Anilin oil	120 cc.
Hydrochloric acid	180 cc.
Water	1000 cc.

Mix these in a glass vessel putting in the water first. Apply two coats without heating, but allow the first coat to dry before adding the second.

When the second coat is dry, sand paper the wood and dust off the excess chemicals. Then wash the wood well with water. When dry, sand paper the surface and then rub thoroughly with a mixture of equal parts turpentine and linseed oil. The wood may appear a dirty green at first but it will soon become ebony black. If the excess chemicals are not removed the table will crock. An occasional rubbing with linseed oil and turpentine or with turpentine alone will clean the surface. This is sometimes called the Danish method, Denmark black or finish. See *Jour. Ap. Micr.*, Vol. I, p. 145; *Bot. Zeit.*, Vol. 54, p. 326, *Bot. Gazette*, Vol. 24, p. 66, *Dr. P. A. Fish, Jour. Ap. Micr.*, Vol. VI., pp. 211-212.

§ 429. *Zenker's Fluid*.—*Müller's Fluid*, (§ 418), 100 cc.; mercuric chlorid 5 grams. Just before using add 5 cc. of glacial acetic acid to each 100 cc. of the above. Fix fresh tissue 5 to 24 hours. Wash out with running water 24 hours. Then place in 67% alcohol 1 day or more and finally preserve in 82% alcohol. Tissue fixed in *Zenker's* has mercuric crystals. They may be removed from the tissue by long treatment with iodine, or by putting the slide bearing the sections in iodized alcohol for half an hour or more (§ 413).

This is an excellent fixer, combining the good qualities of mercuric chlorid and of the chromium compounds. Tissues fixed with this show well the red blood corpuscles.

REFERENCES FOR CHAPTER IX

For information concerning this chapter the reader is first of all advised to consult the microscopical periodicals, especially the *Journal of the Royal Microscopical Society* and the *Zeitschrift für wissenschaftliche Mikroskopie und für mikroskopische Technik*. The smaller journals and the proceedings of microscopical societies frequently have excellent articles bearing upon the subjects of this chapter. This is especially true of the *Journal of Applied Microscopy and Laboratory Methods*, and the *Transactions of the American Microscopical Society*.

Among modern books, *Lee's Microtomists' Vade Mecum*, *Mann's Physiological Histology* and *Ehrlich's Encyclopaedie der mikroskopischen Technik* are indispensable in a laboratory. For the history of staining see *Mann*, pp. 190-195.

CHAPTER X

FIXING ; MICROTOMES AND SECTION KNIVES ; IMBED- DING ; SECTIONING, STAINING AND MOUNT- ING ; SERIES ; MODELS

FIXING TISSUES, ORGANS AND EMBRYOS ; MECHANICAL PREPARA- TION FOR STUDY

§ 430. **Fixation.**—By fixing or fixation in histology is meant the preparation of fresh tissues, organs, embryos or small adult animals usually by means of some chemical mixture, called a “fixer” so that the organ etc. as a whole and the elements or cells composing it shall retain as nearly as possible the morphologic characters present during life. The more perfect the fixer the nearer will be the preservation of all structural details.

Unfortunately no single “fixer” preserves with equal excellence all the structural details, and therefore it is necessary to prepare the fresh tissue in several different ways and to make a composite of the structural appearances found, thereby approximating the actual structure present in the living body. Changes are so rapid after death that the fixation should begin as soon as possible. For the most perfect fixation the living tissue must be put into the fixer.

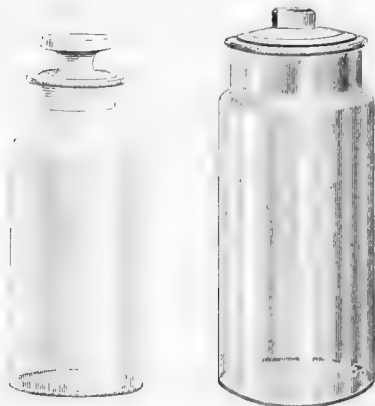

FIGS. 221-222. *Glass stoppered jars for fixing and storing tissues for histology. (Cuts loaned by the Whittall Tatum Co.)*

With one of the larger animals where the whole animal is to be used for microscopic study it is a great advantage to bring the fixer in contact with all

parts of the body quickly, and that is done by washing out the vascular system with normal salt solution and then filling the vascular system with the fixer. This method of "*fixation by injection*" is of great importance in the histology of animals which are large enough to inject.

If the animal is too small for injection or one wishes only a small part of a larger animal, then the pieces for fixation should be small, say one to three cubic centimeters. Often as for Flemming's fluid (§ 405) and for several others it is better to use pieces 2 to 5 cubic millimeters.

Large, solid organs, must be cut into several pieces if the whole is needed. For hollow organs the cavity may be filled with the fixer and the organ placed in a vessel of the same.

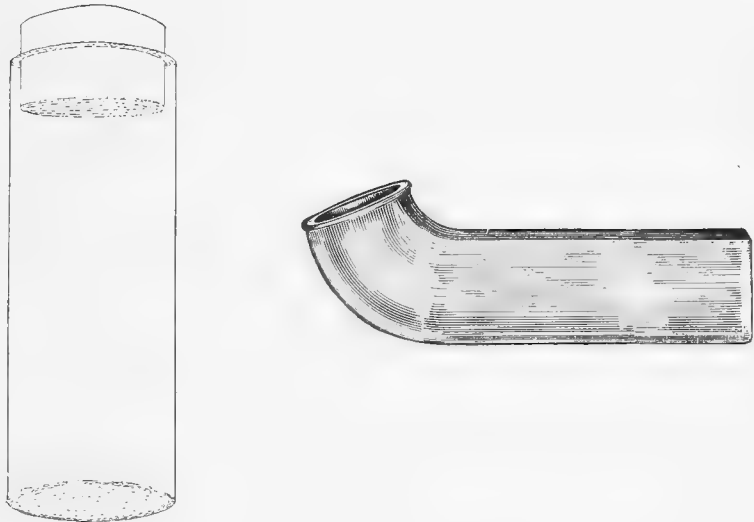

FIGS. 223-224. *Shell vial and a Comstock bent-neck vial for fixing and storing material for histology. The Comstock bent-neck vial is especially designed for elongated objects like fish embryos, insects, etc., which are liable to become bent in a vertical bottle. (Cut of the bent-neck, from the Whitall Tatum Co.)*

The amount of fixer should be 10 to 50 times that of the piece of tissue.

Of the fixers given under "Preparation of Reagents," Picric alcohol, Formaldehyde and Zenker's fluid are suitable for almost every tissue and organ. Formalin has the advantage of having strong penetration, hence it preserves whole animals fairly by immersing after filling the abdominal and thoracic cavities. Formaldehyde is excellent where a study of fat is in question, and it is much used as a fixer where frozen sections are desired (§ 438). Remember the necessity of removing mercury from sections of tissues fixed with a mercuric fixer (§ 413, 477).

§ 431. **Mechanical Preparation of Tissues etc. for Microscopic Study.**—A limited number of objects in nature are small enough and transparent

enough, and a limited number of the parts of higher animals are suitable for microscopic study without mechanical preparation except merely mounting them on a microscopic slide. Usually the parts of animals are so large and so opaque that the histologic elements or cells and their arrangement in organs can only be satisfactorily studied with a microscope after the tissue, organ, etc., have been teased apart with needles, (§ 357) or sectioned into thin layers.

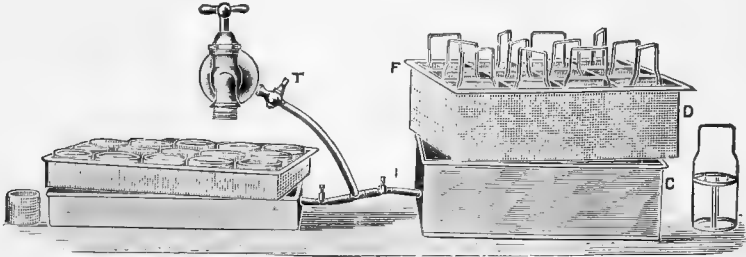

FIG. 225

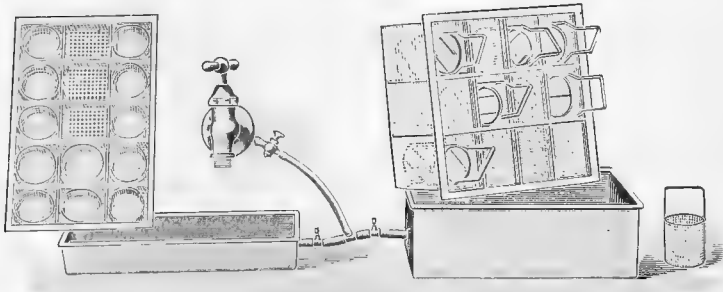

FIG. 226

FIGS. 225-226. *Washing apparatus for tissues fixed in osmic and chromium mixtures. As shown in the figures the apparatus is connected with the water pipe by a small side cock. It is composed of a double vessel, the inner one being made of perforated brass. There are special perforated dishes to insert in the little compartments. For ova and other small objects a piece of gauze is used in the compartment. This apparatus is convenient for washing cover-glasses, for the washing out for iron hematoxylin, etc. The deeper box at the right answers for the slide baskets or holders (Fig. 244).*

MICROTOMES AND SECTION KNIVES

§ 432. The older histologists, those who laid the foundations and whose understanding of the finer structure of the body was in many ways superior to the knowledge possessed by workers at the present time, did their mechanical

preparation with needles and with sharp knives held in the hand. They dealt also with fresh tissue more largely than we do at the present day, and learned also to distinguish tissues by their structure rather than by their artificial coloration.

It was not, however, on account of the lack of elaborate mechanical devices for sectioning and complicated staining methods of the present day, but because they put intelligence and zeal into their work that made them so successful. Only those who were "called" made for themselves a laboratory and saw with their brain. Now many are "sent," but few who use the central organ of sight.

If the reader is interested in the mechanical means for sectioning he is referred to Dr. C. S. Minot's papers on the history of the microtome in the *Journal of Applied Microscopy*, Vol. VI. In a word, it is now possible with the almost perfect automatic microtomes to make thousands of perfect sections where in 1860 only occasionally could the most expert get tens with his hand sectioning.

‡ 433. **Types of Microtomes.**—There are two great types: (1) The early type in which the preparation to be sectioned is held mechanically and moved up by a screw, the section knife being held in the hand and moved across the object usually with a drawing motion as in whittling (Fig. 228).

(2) The mechanical type in which both specimen and knife are mechanically held and guided, and the operator simply supplies power to the machine.

In the highest types of the second class—*automatic microtomes*—the operator only needs to put the knife and specimen in position and supply the power and sections of any thickness and any number may be produced in a short time. A skilled and experienced person can get better results here as well as with free-hand sectioning or the hand microtome. Even automatic machines work better for skilled workmen.

As is seen by the accompanying cuts, sometimes the knife is fixed in position and the object to be sectioned moves, while in other forms the object to be sectioned remains fixed and the knife moves. Furthermore for sectioning paraffin, the knife meets the object like a plane (straight cut), while for colodion sectioning the knife is set obliquely and there results an oblique or drawing cut as in whittling.

‡ 434. **Section Knives.**—A section knife should have the following characters. (1) The steel should be good. (2) The blade should be slightly hollow ground on both sides. Why some makers persist in grinding one side flat is a mystery. (3) The edge of the knife should be straight, not curved as in a shaving razor. (4) The back should be parallel with the edge. (5) The blade should be long, 12 to 15 centimeters, as it takes no more time or skill to sharpen a large than a small knife. (6) The blade should be heavy. There was formerly a fashion of making very thin bladed section knives, but that is a great mistake, for the thin blade bends and vibrates in cutting firm tissue and large pieces. There is no possible advantage in a thin bladed section knife for microtome work, but much disadvantage from the lack of rigidity.

The microtome knives shown on the various instruments figured in this chapter illustrate well the proper form of section knives. (Figs. 227, 238.)



FIG. 227. Section knife with the honing back in position (Cut loaned by the Spencer Lens Co.)

§ 435. **Sharpening Section Knives ; Hones and Stropps.**— Perhaps it should be taken for granted that any one would appreciate the impossibility of making good sections with a dull section knife, but experience teaches the contrary. Students are prone to believe that with one of the elaborate automatic microtomes, good sections may be made with any kind of an edge on the knife. It is forgotten that *the knife is the most important part*, all the other mechanism is simply its servant.

For sharpening, select a fine, yellow Belgian hone, and a very fine Arkansas hone. As a rule hones from the factory are not sufficiently plane. They may be flattened by rubbing them on a piece of plate glass covered with moderately fine emory or carborundum wet with water. Round the corners and edges of the hones on the plate glass or on a grindstone. In using the Belgian hone for sharpening knives, wet the surface well with a moderately thick solution of soap. With the Arkansas stone use some thin oil—xylene or kerosene mixed with a little olive oil or machine oil.

Honing. Before honing a section knife, make sure that the edge is smooth, that is that it is free from nicks. Test this by shaving off the surface of a block of paraffin. If nicks are present the cut surface will show scratches. It is advisable also to look at the edge of the knife with a magnifier and with a low power (50 mm.) objective. If nicks are present remove them by drawing the edge along a very fine Arkansas hone.

A saw edge may be all right for rough cutting and for shaving razors, but if one wishes to get perfect sections 2 to 10μ in thickness a saw edge will not do. In removing the nicks one should of course bear on very lightly. The weight of the knife is usually enough.

In honing use both hands, draw the knife, edge foremost, along the hone with a broad curved motion. In turning the knife for the return stroke, turn the edge up, not down. Continue the honing until the hairs on the arm, wrist or hand can be cut easily or until a hair from the head can be cut within 5 mm. from the point where it is held. The sharper the knife becomes the lighter must one bear on. One should also use the finest stone for finishing. If one bears on too hard toward the end of sharpening, the edge will be filled with nicks.

In honing and stropping large section knives, there has come into use during the last few years the so called "honing backs". These elevate the razor slightly so that the wedge is blunter and one does not have to grind away so much steel, (Fig. 227).

Strop. A good strop may be made from a piece of leather (horse hide) about 50 cm. long and 5 to 6 cm. wide, fastened to a board of about the same size.

The strop is prepared for use by rubbing into the smooth surface some carborundum powder, *i. e.* 60 minute carborundum, that which is so fine that it remains in suspension in water for 60 minutes, or one may use diamantine or Jewelers' rouge.

Stropping. With the back foremost draw the knife length-wise of the strop with a broad sweep. For the return stroke turn the edge up as in honing. Continue the stropping until a hair can be cut 1 to 2 centimeters from where it is held.

§ 436. **Free-Hand Sectioning.**—To do this one grasps the section knife in the right hand and the object in the left. Let the end to be cut project up between the thumb and index finger. One can let the knife rest on the thumb or index finger nail and with a drawing cut make the section across the end of the piece of tissue. By practice one learns to make excellent sections this way. If the whole section is not sufficiently thin, very often a part will be and one can get the information needed.

§ 437. **Sectioning with a Hand or Table Microtome.**—

The tissue is held by the microtome and moved up by means of a screw. The knife rests on the top of the microtome and is moved across the tissue by the hand. Microtomes of this kind are excellent. No one need wait for expensive automatic microtomes to do good sectioning. With a good table microtome the knife being guided by the hand or hands of the operator, he can make straight cuts as for paraffin sectioning, or drawing cuts as for collodion work. (Figs. 228-229).

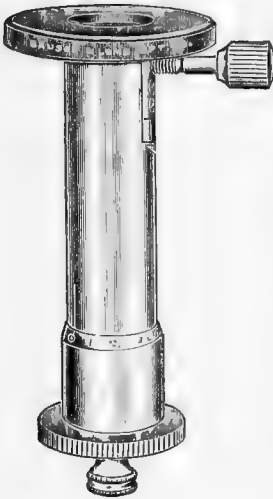

FIG. 228

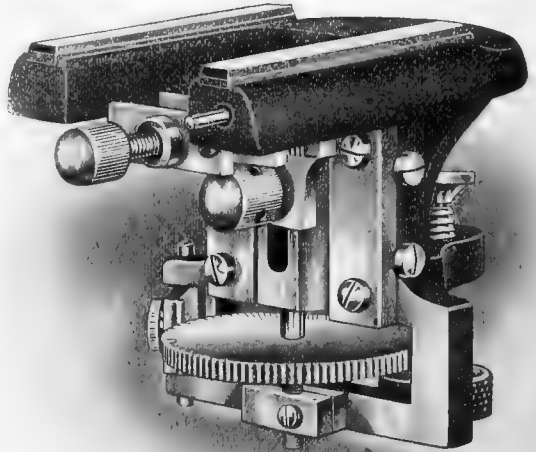

FIG. 229

FIGS. 228-229. *Hand and table microtomes. Both have a screw for elevating the object to be cut and a surface on which to rest the section knife. 228 is held in the hand, 229 is fastened to a table. The knife is held and moved by the hand in both cases. (Cuts loaned by the Bauch & Lomb Optical Co).*

§ 438. **Sectioning with a Freezing Microtome.**—In this method of sectioning the tissue is rendered firm by freezing and the sections are cut rapidly by a planing motion as with paraffin. Now the most usual freezing microtome is one in which the freezing is done with escaping liquid carbon dioxide. The microtome is in general like the one shown in Fig. 229. The knife should be very rigid. A plane blade is often made use of. The tissue may be either fresh or fixed. If alcohol has been used it must be soaked out of the tissue by placing it in water. Sometimes tissues are

infiltrated a day or two in thick mucilage before freezing. Drop a little thick mucilage on the top of the freezer, put the tissue in the mucilage and turn on a small amount of carbon dioxide. It will soon freeze the mucilage and the tissue as shown by the white appearance. When frozen, cut the tissue rapidly. It is well to have an assistant turn the feed screw up while the sections are cut. When 20 or 30 sections are cut place them in water or normal salt solution. The staining and mounting of the sections will be considered in § 461-471. This is a rapid method of getting sections much used in pathology where quick diagnoses are demanded. In normal histology the freezing microtome is used mostly for organs or parts of greatly varying density. For example if one wishes sections of the finger and finger nail, this apparatus offers about the only means of getting good sections. In that case the bone is decalcified before trying to make the sections (§ 398).

THE PARAFFIN METHOD OF SECTIONING

§ 439. **Object of the Paraffin.**—In the early periods in histology great difficulty was encountered in making good sections of organs and parts of organs because the different tissues were very unlike in density. At first tallow and beeswax, elder pith, liver and various other substances were used to enclose or surround the object to be cut. This gave support on all sides, but did not render the object homogeneous. In the early sectioning, a great effort was made to keep all imbedding material from becoming entangled in the meshes of the tissue. This was guarded against by coating the object with mucilage, and hardening it in alcohol. This mucilage jacket kept the tissue free from infiltration by the imbedding mass and itself was easily gotten rid of by soaking the sections in water.

A great advance was made when it was found that the imbedding mass could be made to fill all the spaces between the tissue elements and surround every part, the tissue assuming a nearly homogeneous consistency, and cutting almost like the clear imbedding mass. Coco butter was one of the first substances to be used for thus "infiltrating" the tissues. The imbedding mass must be removed before the staining and mounting processes.

§ 440. **Infiltration of the Tissue with Imbedding Mass.**—

The tissue to be cut in this way is first fixed by one of the fixers used for histology. Several good ones are given in sections 406, 416, 423, 429.

(A) The tissue is then thoroughly dehydrated by means of 95% and absolute alcohol. For most objects, especially embryos and other colorless objects it is best, during the dehydration, first to use alcoholic eosin (§ 402), as the most delicate part shows when one cuts the sections. Leave the piece of tissue to be cut over night in alcoholic eosin, and a few hours in uncolored 95% alcohol using 20 times as much alcohol as tissue. For the final dehydration it should be left in absolute alcohol four or five hours or over night, depending on the size of the object.

(B) Remove the alcohol by a solvent of the imbedding mass, that is by some substance which is miscible with both alcohol and the imbedding mass (§ 422, 441). Cedar wood oil is most generally used (§ 390). Leave the tissue in cedar oil until the tissue sinks and the thin parts of the specimen become translucent. If the tissue does not sink after a time it means that the tissue was not dehydrated. Of course this does not apply to lung or other spongy tissue containing much air. It is well to change the cedar oil once. The used cedar oil may be left in an open bottle for the evaporation of alcohol and used over and over again.

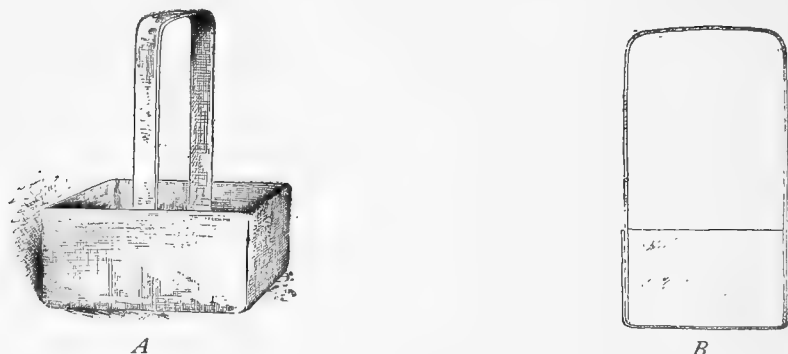

FIG. 230. Paraffin dish for infiltrating in the Lillie oven. It is made of copper and as shown has a handle for ease in transference. A, the whole dish, B, the dish in section. (*Jour. Appl. Micr.* 1899, p. 266.)

(C). Displace the cedar oil by melted paraffin wax. When the tissue is saturated with the oil, transfer it to an infiltrating dish

(Fig. 230), containing melted paraffin. Place in a paraffin oven (Fig. 231) and keep the paraffin melted for from two hours to three days depending on the size and character of the piece to be imbedded. If the tissue was thoroughly dehydrated and well saturated with cedar oil the melted paraffin permeates the whole piece.

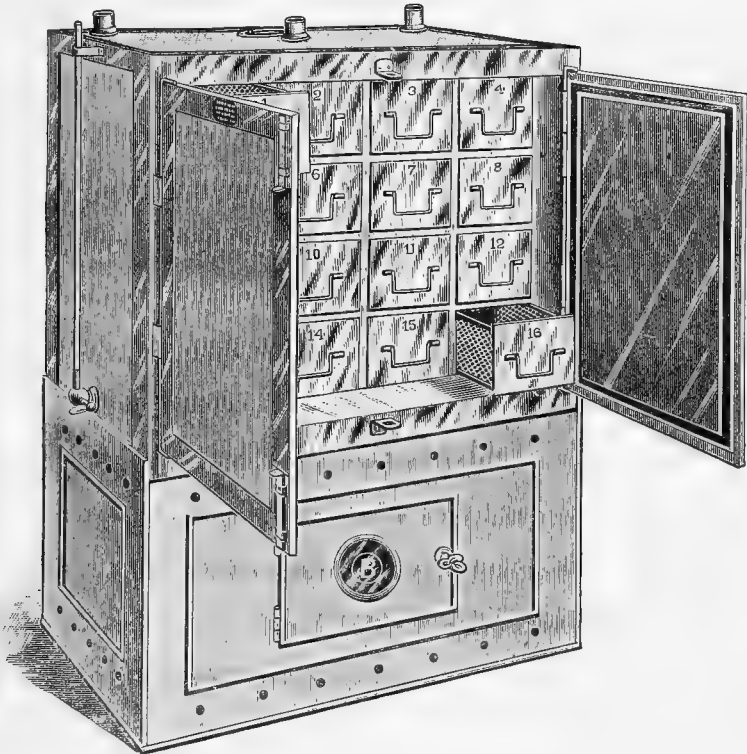

FIG. 231. *The Lillie compartment, paraffin oven for infiltrating tissues with paraffin. Various sizes of this are made (8, 16 and 24 compartments). Except for the largest laboratories the one with 16 compartments and trays will be found of sufficient capacity. Dr. Lillie has recently omitted a part of the trays and thus gained compartments for receiving dishes in which paraffin is kept melted and ready for use. (Cut loaned by the Spencer Lens Co.)*

§ 441. **Imbedding in Paraffin Wax.**—When the object is thoroughly infiltrated imbed as follows: Make of strong writing paper a box considerably larger than the piece to be imbedded.

Nearly fill the box with paraffin wax, place on a copper heater (Fig. 241) and allow to remain until bubbles appear in it. Put the box on cold water until a thin stratum of paraffin solidifies on the bottom. Take the piece of tissue from the melted paraffin (Fig. 230) and arrange in the box for making sections in a definite direction. Add hot paraffin if necessary, and then place the box on cold water. The more rapid the cooling the more homogeneous will be the block containing the tissue to be cut. For the best imbedding it is well to drop 95% alcohol on the surface as soon as a film has formed in cooling. In warm climates where cold water is not easy to procure for cooling the blocks, one may float the paper box on 95% alcohol and with a pipette (Fig. 240) drop strong alcohol on the sides of the box and on the top of the paraffin as soon as a surface film has formed.

It is very desirable to mark on the box the name of the imbedded object and to indicate which end or face is to be cut. See also under serial sectioning (§ 472-473).



FIG. 232. *Various forms of scalpels. The one at the left is especially excellent for cutting the ribbons of sections of the proper length for mounting. The large one with straight edge is the best form for trimming the paraffin block square for sectioning. (Cut loaned by the Bausch & Lomb Optical Co.)*

§ 442. **Fastening the Block to a Holder.**—Use one of the block holders or object discs furnished with the microtome, or a short stove bolt (Figs. 233-236). Heat the larger end and press the paraffin block against the hot metal until it melts the paraffin. Hold the two together while cold water flows over them. When cold the block is firmly cemented to the holder. Pains should be taken to have the axis of the block parallel with the long axis of the holder; and one should not cut the block so short that the holder comes in contact with the tissue when the two are cemented together.

A clamp is sometimes used for holding the paraffin block (Figs. 229, 246-247).

§ 443. **Trimming the End of the Block for Sectioning.**—Sharpen the end to be cut in a pyramidal form, being sure to leave 2 millimeters or more of paraffin over the tissue at the end as well as on the sides. The block is trimmed in a pyramidal form so that it will be rigid. Take particular pains that the opposite faces at the end of the block are parallel, and all the corners right angles.

§ 444. **Making Paraffin Sections.**—Put the paraffin block or the metal holder in the clamp of the microtome. Arrange the block so that one side of the pyramidal end is parallel with the edge of the knife, then tighten the clamp, and if an automatic microtome is used make sure that the section knife is also tightly clamped by the proper set screws. It is well to have the knife lean slightly toward the paraffin block (Fig. 239).

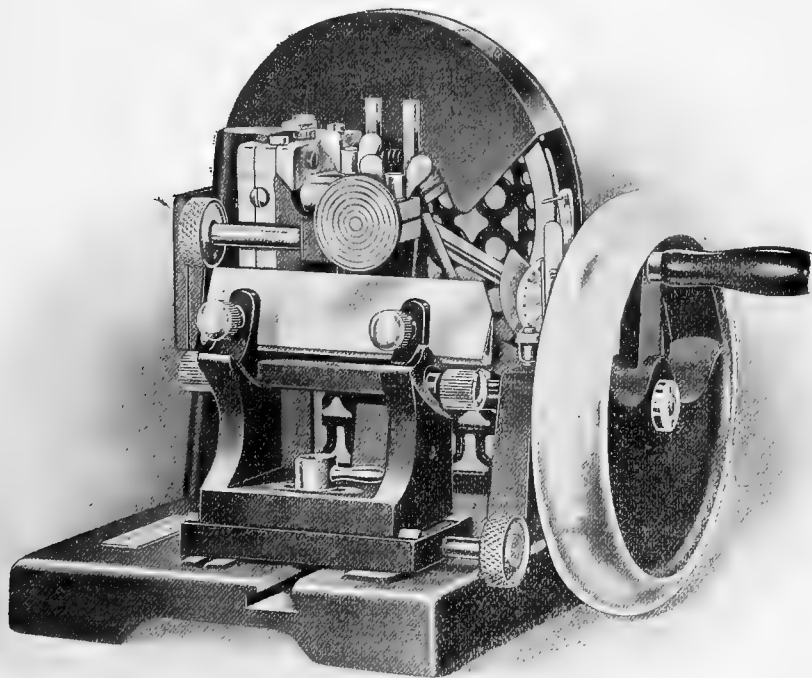

FIG. 233. *The Minot automatic rotary microtome for paraffin sectioning (Sections from 1 μ to 25 μ may be cut on this instrument.) (Cut loaned by the Bausch & Lomb Optical Co.).*

The knife edge meets the paraffin squarely as in planing. The thickness of section is provided for in the automatic microtome by the indicator which may be set for any desired thickness, or one can turn up the screw by hand in the table microtome. (Fig. 229). The paraffin and its contained tissue are cut in a thin shaving. If the tissue was stained in toto with eosin as suggested in § 440 A, it is marked out with great clearness in the containing paraffin.

As succeeding sections are cut they push along the previous sections, and if the hardness of the paraffin is adapted to the temperature where the sectioning is done the edges of the successive sections will be soldered as they strike. This produces a ribbon as it is called, and if the paraffin block has been properly trimmed at the end the ribbon will be straight and even (Fig. 234). If the ribbon is curved sideways it indicates that one side of the block is thicker than the other and the sections are slightly wedge shaped.

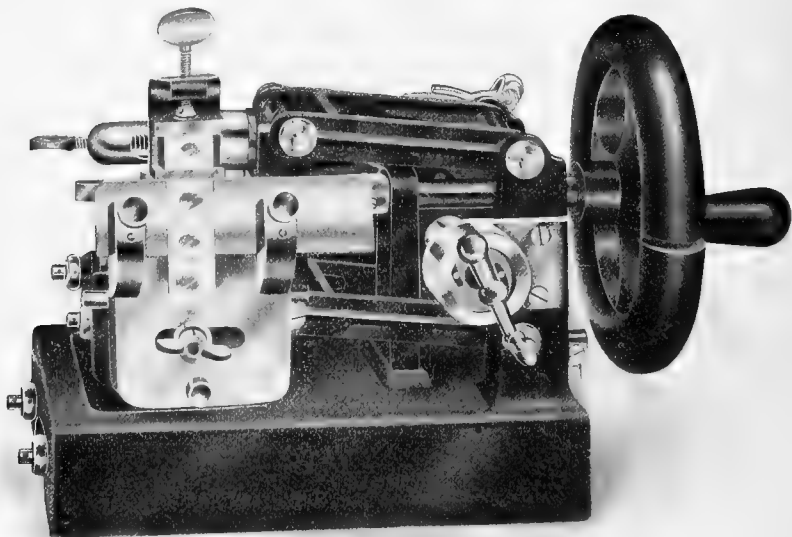

FIG. 234. *Automatic rotary microtome for paraffin sectioning. Sections from 1 μ to 100 μ may be cut on this instrument. (Cut loaned by the Spencer Lens Co.)*

If the paraffin is too hard for the room temperature and for a given thickness of section the sections will curl; if it is too soft the sections will crumple.

The thinner the sections the harder should be the paraffin or the cooler the sectioning room; and the thicker the sections and the larger the object to be cut, the softer can be the paraffin and the higher the temperature. If then the sections do not ribbon, make thinner sections or work in a warmer place. If the sections crumple, make thicker sections or work in a cooler room. Of course one can reimbed in a more suitable hardness of paraffin.

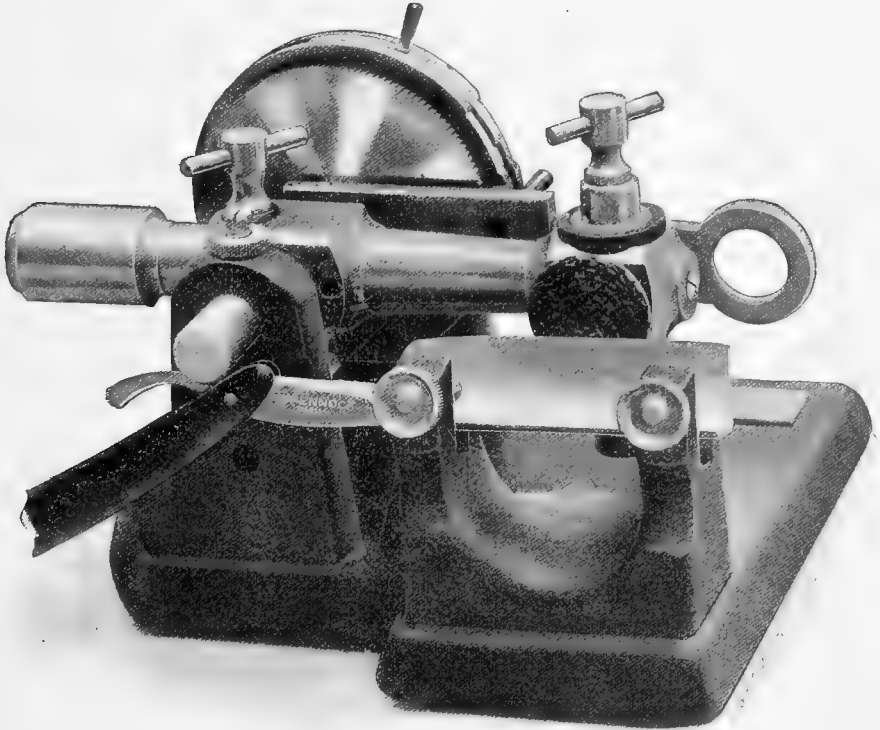

FIG. 235. *The Conklin-Pietzsch automatic lever microlome for paraffin sectioning. This is a modified Ryder microlome and is simpler and therefore cheaper than most paraffin instruments. It is designed for sections from 1-300 to 10-300 mm. (3 1-3 to 33 1-3 μ). By means of a special attachment, sections of 2 μ may be made. (Cut loaned by Edward Pennock, Philadelphia.)*

In the season when steam radiators are used one can get almost any desired temperature by sectioning nearer or farther from the radiator.

In the winter it is a good plan to warm the microtome and section knife before sectioning. This can be very easily done by putting a cloth over the radiator and the microtome something like a tent.

§ 445. **Electrification of the Paraffin Ribbons.**—Some days there is such an accumulation of static electricity in cutting the ribbons that they jump toward anything brought near them. This is very annoying and liable to be so destructive to many of the sections that serial work (§ 472) can not be done with safety.

Many devices have been tried to overcome this difficulty, like burning a gas jet near the microtome, boiling water near the apparatus etc., but the safest way is to wait for more favorable conditions.

To overcome this electrification, Dixon, (*Jour. Roy. Micr. Soc.*, 1904, p. 590), recommends fastening a 5 milligram tube of radium bromide on the knife near where the sectioning is done. The radium ionizes the air and renders it a good conductor, and then the static electricity cannot accumulate. I have not been able to try this method.

§ 446. **Storing Paraffin Ribbons.**—The most convenient method for caring for the ribbons as they are cut is to place them on a tray (Fig. 212) lined with a sheet of white paper. It is important to write on the paper full data, giving the name of the tissue, the thickness of the sections, the date etc. It is well also to number the ribbons and to indicate clearly the position of the first section or the beginning of the ribbon.

Ribbons on trays should be covered by another tray if one wishes to carry them to another room. The slightest gust of air sends them flying.

Ribbons on trays may be kept a long time, three or four years at least, if they are stored in a cool place. The sections do not flatten out quite as well after standing a long time as they do soon after they are made.

§ 447. **Spreading the Sections.**—Paraffin sections are almost invariably slightly wrinkled or folded in cutting. To remove the wrinkles one takes advantage of the expansion of paraffin when it is warmed. The sections may be floated on warm water when they will straighten out and become smooth, or the usual method is to stretch them on the slide upon which they are to be finally mounted.

§ 448. **Spreading Sections on a Slide.**—A double operation is performed in this way, viz; the sections are made smooth and they are also fastened to the slide. Put a minute drop of albumen fixative on the middle of a slide (Fig. 187) and with the ball of one finger spread it over the slide, making a thin even layer. It cannot be too thin. It is liable to stain if it is too thick.

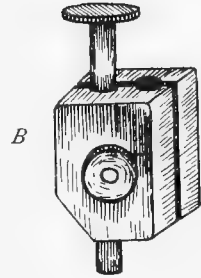
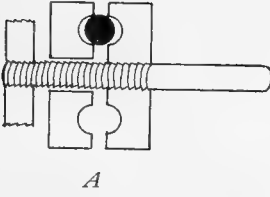

FIG. 236



FIG. 237 A

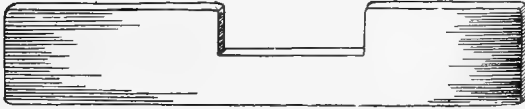

FIG. 237 B



FIG. 238

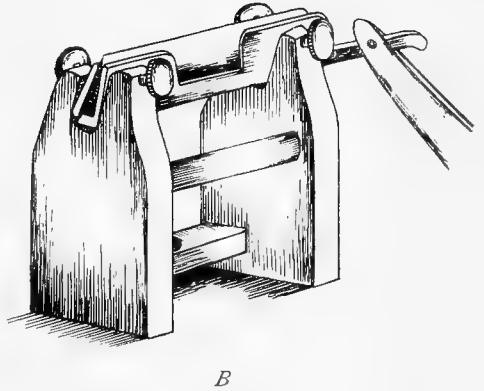
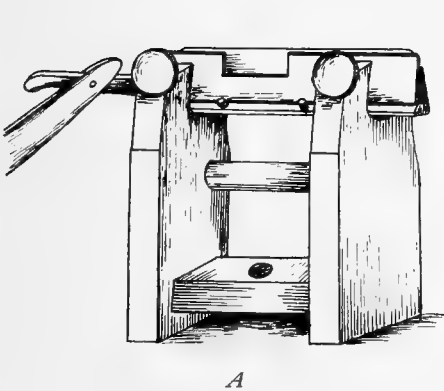

FIG. 239

FIG. 236 A B. A paraffin holder clamp and a razor support for the Minot Microtome for utilizing most of the cutting edge. (*Trans. Amer. Micr. Soc.*, 1901.)

Clamp for the paraffin block holder. In A it is shown in section, in a side view. With this clamp one can use stove bolts as well as the expensive paraffin holders furnished with the instrument. A laboratory can have as many paraffin block holders as necessary without undue expense.

FIG. 237 A B. Razor Support and Razor.

(A) Support with heavy base and vertical piece. The base should be capable of moving endwise one or two centimeters to bring the opening in the vertical part opposite the paraffin block. (B) Front piece to the razor.

FIG. 238. Razor with straight back and edge. By moving this back and forth on the support nearly the entire cutting edge can be utilized.

FIG. 239 A B. The knife support of the microtome with the razor support and razor in position.

(A) Front view; (B) Back view, in which the inclination of the knife toward the paraffin block is shown.

With a pipette (Fig. 240) put several drops of water on the slide and then place a piece of a ribbon on the water; or put the sections on the albumenized slide and add the water afterward. Heat

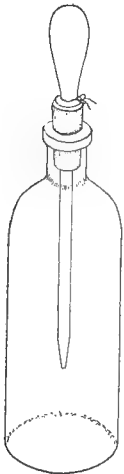

FIG. 240. Reagent bottle with combined cork and pipette (This is made by taking a cork of the proper size and making in it a hole with a cork borer for the glass tube. It is advantageous to have a string tied tightly around the rubber bulb as shown).

the slide carefully over a spirit lamp or gas flame, being sure not to melt the paraffin. As the water warms the paraffin expands and stretches the sections out smooth. A copper heating plate also, Fig. 241, is excellent for spreading sections.

After the sections are spread, drain off most of the water, arrange the sections with a needle or scalpel and place the slide in one of the trays (Fig. 212). Allow it to remain over night or preferably longer. The longer the drying in air the more surely do the sections adhere to the glass slide.

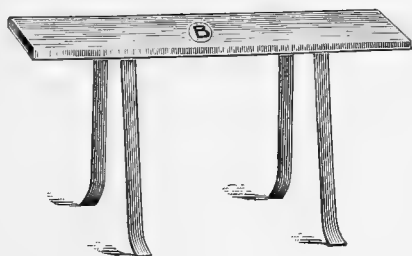

FIG. 241

FIG. 241. *Copper warming plate on legs. An alcohol or small Bunsen lamp is used with this. It is more satisfactory to spread sections by warming the slides on this plate than to heat them directly over the flame. (Cut loaned by the Spencer Lens Co).*

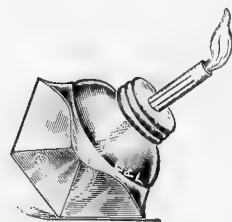

FIG. 242

FIG. 242. *Spirit lamp. This is of glass and has the sides flattened so that the lamp rests on one of the sides if it is overturned. (Cut loaned by the Bausch & Lomb Optical Co.).*

If one is in haste to take the succeeding steps in the preparation, the slide may be dried by putting it into a drying oven at 38° to 40° C. for half an hour or more. The slower drying in air is better if one has plenty of time.

Some tissues are very difficult to get perfectly smooth as just described. If fine wrinkles persist one can sometimes overcome the difficulty by letting the slide cool and then covering with a piece of fine tissue paper slightly moistened; press down firmly with the ball of the finger on the sections. Then take hold of the edge of the paper and roll it off the sections. Unless one is careful the sections are liable to come away with the paper instead of adhering to the slide.

As the water dries out the spread sections come in very close contact with the glass and adhere quite firmly to it. The thinner the sections the more tightly do they stick. This makes it possible to perform the rest of the operations on the slide. One has to be careful not to let strong currents strike the sections.

§ 449. **Deparaffining in Xylene.**—This is accomplished by using a solvent of paraffin. The best and safest one to use in a laboratory is xylene. Benzine, gasoline, and even kerosene are used, but xylene is a powerful solvent of paraffin, does not injure the tissue, and is not very inflammable, due to the large amount of carbon in its molecule (see § 392).

It requires only a few minutes to dissolve paraffin from the sections, but a day or more in the xylene does no harm.

When the paraffin is removed the staining and other operations necessary for a completed preparation may be undertaken (See for these § 461-471).

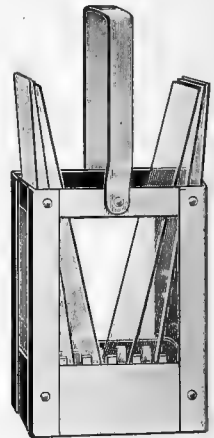
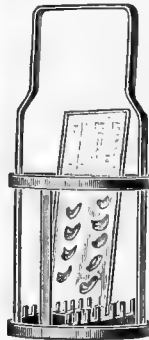

FIG. 243

FIG. 244

FIG. 243. Slide basket or holder and a glass stoppered bottle to contain the same. Xylene is safer than benzine for deparaffining. The slide basket was devised by Dr. A. B. Mix in the author's laboratory in 1898. It is cylindrical and has an unjointed handle or bail. (*Jour. Ap. Micr.*, vol. i, 1898, p. 169).

FIG. 244. Square slide basket with hinged bail or handle so that it may be turned down in inserting or removing the slides. In 1900 the hinged bail was added to the round slide baskets, and in 1902 the form was changed from round to square. The square form is more convenient, and suitable for all sizes of slides. (Cut loaned by the Spencer Lens Co.).

§ 450. **Collodionizing the Sections.**—Except for carmine stains and perhaps some others, collodion remains practically colorless. While the sections remain quite firmly attached to the slide after they have been spread and dried, thick sections are liable to

come off in the many processes of staining, and if one has many sections on a slide some of them may become loosened. To avoid this the sections are covered with a delicate layer of collodion, which holds them down to the slide. The early method was to use a soft brush and paint a thin film over the dried sections before they were deparaffined. Now the sections are deparaffined, and then after draining the xylene from the slide, 10-15 seconds, it is put into a bottle containing ¾% collodion (§ 395). In a minute or more the collodion displaces the xylene and penetrates the sections and forms a delicate veil over their free surface. No harm is done by leaving the sections in the collodion a considerable time, but a minute or two is sufficient. The slide is removed, allowed to drain for half a minute, and then put into a jar of 67% alcohol (Fig. 222). The alcohol fixes the collodion and removes the ether. As the 67% alcohol does not hurt the tissue it may stay in the jar a day or more if desired, but half an hour suffices.

Steps in Order for the Paraffin Method.—§ 439, 450, 461-471.

Name	No.
Animal.....	Absl. alc. Cedar oil.....
Date	Infil.
Fixer	Temp. bath..... Imbed. in.....
Time of fix.....	Sections cut.....µ's.....
Washed in water.....	Temp. room.....
67% alc. 82% alc.....	Stains
Decalc. § 398..... 67, 82% alc.....
In toto stain.....	Mtd. in.....
Washed in	Remarks
67% alc. 82% alc.....
95% alc. and eosin.....

The sections are now ready for the subsequent staining and other operations to make a finished slide. One has to remember that if mucicarmin (§ 389) is to be used in staining, the preparation must not be collodionized as carmin stains collodion.

THE COLLODION OR CELLOIDIN METHOD OF SECTIONING

§ 451. **Collodion Method.**—In this method the tissue is thoroughly permeated with a solution of collodion which is afterward hardened. Unlike the paraffin of the paraffin method, the collodion is not subsequently removed from the tissue, but always stays in the sections. It is transparent and does no harm.

The fixing and dehydration with 95% alcohol is the same as for the paraffin method (§§ 430, 440).

The paraffin method gives thinner sections than the collodion method and for series and large numbers of sections is superior.

The collodion method requires no heat for infiltration, and it does not render the firmer forms of connective tissue so hard and difficult to cut. It is especially adapted for making sections of large pieces of tissue or organs and when thick sections are desired. It is not easy to cut sections less than $10\ \mu$ with collodion, while with paraffin it is possible to make good ribbons of small objects of delicate texture $2\ \mu$ to $3\ \mu$ in thickness. With a very sharp knife and small delicate object, and one of the better forms of microtomes one can cut short series in $1\ \mu$ sections and get perfect ribbons.

Collodion sectioning is sometimes denominated the "*wet method*" as the tissue and sections must always be wet with some liquid, while the paraffin method is called the "*dry method*" as the tissue once infiltrated with paraffin keeps in the air indefinitely and in cutting the sections no liquid is used.

§ 452. **Infiltration with Ether Alcohol.**—Transfer the piece of tissue to be cut from 95% alcohol to a mixture of equal parts of sulfuric ether and 95% alcohol and leave in this for a few hours or a day or more as is most convenient. This is to soak the tissue full of a solvent of the collodion.

§ 453. **Infiltration with $1\frac{1}{2}\%$ Collodion.**—Pour off the ether-alcohol from the tissue and add $1\frac{1}{2}\%$ collodion. Leave in this over night or longer if the piece of tissue is large.

§ 454. **Infiltration with 3% Collodion.**—Pour off the 1½% collodion and put in its place 3% collodion. Leave the tissue in this half a day or longer.

§ 455. **Infiltration with 6% Collodion.**—Pour off the 3% and add 6% collodion to the piece of tissue. For complete infiltration with this thick collodion leave the tissue in it for one day at least. If the object is large it is advantageous to leave it in for a week or two.

FIG. 245. *Slender dish for hardening the collodion in chloroform or in alcohol. (Cut loaned by the Whitall, Tatum Co.).*



§ 456. **Infiltration and Imbedding in 8% Collodion.**—Pour off the 6% and add 8% collodion. Leave the tissue in this at least one day, and as much longer as possible up to two or three weeks if the piece of tissue is large.

(A) For imbedding small pieces use a piece of wood, (deck plug), vitrified fiber, glass or a good cork for a holder and cover the end with 6% collodion and let it get well set in the air, then put the piece of tissue on the holder and drop 8% collodion upon it at intervals until it is well covered all around. If one takes considerable time for this the collodion thickens greatly in the air. This is an advantage for it gives a denser block for sectioning. After the collodion is pretty well set, place holder and tissue in a vessel with chloroform to harden. One can put the preparation into the chloroform or if the vessel is tight it may be above the chloroform, the vapor then acting as the hardener.

(B) Imbedding in a box.—If the object is of considerable size it is best to use a paper box for imbedding as with paraffin. If a very small amount of vaseline is rubbed on the inside of the box it prevents the collodion from sticking to the paper.

Put first some of the 8% collodion in the box and let it remain in the air until nearly solid, 2 to 3 minutes. Then arrange the specimen to be cut as for imbedding in paraffin, and add gradually 8% collodion until the object is well covered. Let the box stand for a few minutes in air, then place it in a dish like a Stender dish (Fig. 245) and pour some chloroform on the bottom of the dish. Cover and the collodion will harden partly by the chloroform vapor

and partly by that which soaks through the paper. It is well to change the chloroform at least once. The used chloroform will contain some ether-alcohol, but is good for killing animals.

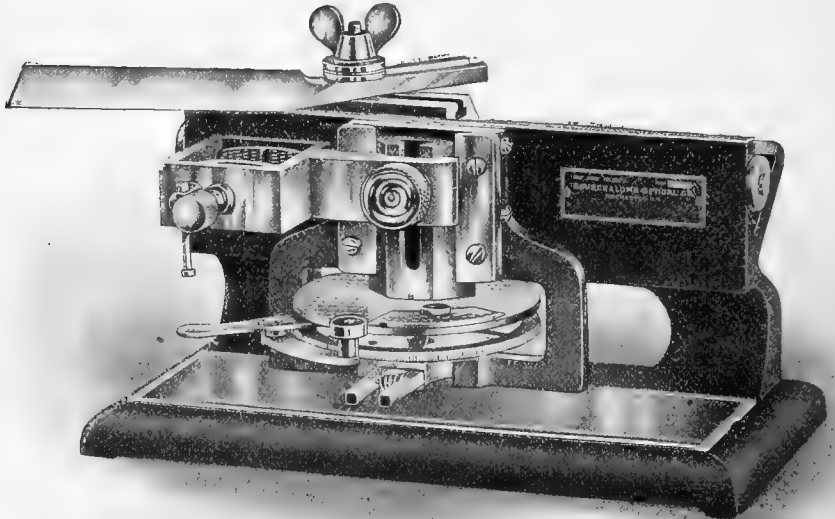

FIG. 246. *Microtome for collodion sectioning. A microtome of this form may also be used for paraffin sectioning. In that case the knife is set at right angles in order to cut the block square across instead of with a drawing cut as for collodion. (Cut loaned by the Bausch & Lomb Optical Co.).*

After 24 or 48 hours the collodion should be firm all through. Then it is placed in 67% alcohol where it may be left a day or more. If it is to be left an indefinite time the 67% alcohol should be changed for 82%.

§ 457. **Sectioning by the Collodion Method.**—For this one can use a table microtome (Fig. 229) or one of the sliding microtomes (Figs. 246, 247). The sections are made with a knife set obliquely and hence with a drawing cut.

The holder with the small piece of tissue is clamped in the microtome and arranged as desired, then the sections are made with an oblique knife which is kept wet with 82% alcohol. The best way to keep the knife wet is to have a dropping bottle over the

object, the drops falling about every two seconds. As the sections are cut they are drawn up towards the back of the section knife with a soft brush. They can be kept in order in this way and not interfere with succeeding sections.

Some operators in drawing the knife across the tissue use a slight sawing motion. However one proceeds, the knife is drawn rather slowly, not rapidly as with paraffin work.

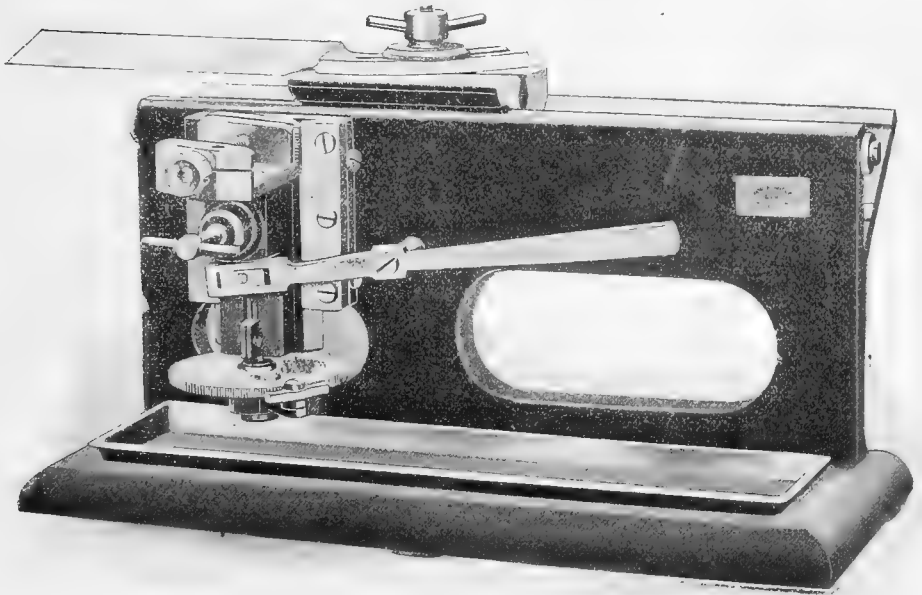

FIG. 247. *Pietzsch microtome, University of Pennsylvania model. The knife is set very obliquely for collodion sectioning. For paraffin sectioning the knife would be at right angles to the clamp. (Cut loaned by Edward Pen-nock, Philadelphia.)*

If the imbedding was done in a paper box, remove the box and trim the collodion block suitably. Dry the end away from the tissue, wet it with 3% collodion. Use a piece of wood, a cork or other holder of suitable size. Put some 6% collodion on the holder and let it dry for a minute or so, then press the collodion block down on the holder. Leave in the air for a minute or two and then put into 67% alcohol to harden the cementing collodion.

After 15 minutes, or longer if convenient, put the mounted specimen into the clamp of the microtome and cut as above.

Sometimes when the imbedded object is of sufficient size and the collodion block is firm, the block itself is put into the microtome clamp, no wood or cork holder being used.

§ 458. **Transferring Sections from the Knife to the Slide.**—When one has cut the number of sections for one slide they should be transferred to the slide as follows: Take a piece of white tissue paper about 3x6 centimeters in size and lay it on the knife over the sections. Press down slightly so the paper is in contact with all the sections. Take hold of the paper beyond the edge of the knife and gradually pull it down off the knife.

If there is the right amount of alcohol on the knife the sections adhere to the paper and move with it. This transfers the sections from the knife to a piece of tissue paper. Place the tissue paper with the sections down on the middle of an albumenized slide. Cover with another piece of paper and press down gently. This presses the sections against the slide and absorbs a part of the alcohol. Take hold of one edge of the paper and lift it with a rolling motion from the slide. The sections should stay on the slide.*

§ 459. **Fastening the Sections to the Slide.**—With a pipette, drop 95% alcohol on the slide of sections, then use a pipette full of absolute alcohol if it is at hand. Drain most of the alcohol away and add a few drops of ether-alcohol. The collodion should melt and settle down closely on the slide. If the collodion does not melt the dehydration was not sufficient and more alcohol must be used. After the collodion has melted down upon the slide let the slide remain a minute or two in the air, and then transfer the slide to a jar of 67% alcohol. (Figs. 243, 251.)

After half an hour or longer the preparation is ready to stain, etc. See below for directions (§ § 461-471).

* Various forms of paper have been used to handle the collodion sections. It should be moderately strong, fine meshed and not liable to shed lint, and fairly absorbent. One of the first and most successful papers recommended is "closet or toilet paper." Cigarette paper is also excellent. In my own work the heavy white tissue paper has been found almost perfect for the purpose. Ordinary lens paper or thin blotting paper for absorbing the alcohol or oil may be used with it.



FIG. 248. Waste bowl with rack for supporting slides and a small funnel in which the slides stand while draining. This outfit is easily made by any tinsmith. The rack is composed of two brass rods about 4 mm. in diameter. The bent end pieces are sheet lead. The funnel is made of tin, copper or brass. Either copper or brass is preferable to tin. A glass dish like that shown in Figs. 188, 251 is better than a bowl, as it can be more readily and thoroughly cleaned. (Cut loaned by Wm Wood & Co.)

§ 460. **The Castor-Xylene Method of Sectioning.**—The preparation of the tissue is the same as described in § 451-456, except that when the collodion is hardened in chloroform it is transferred, not to alcohol, but the block is placed

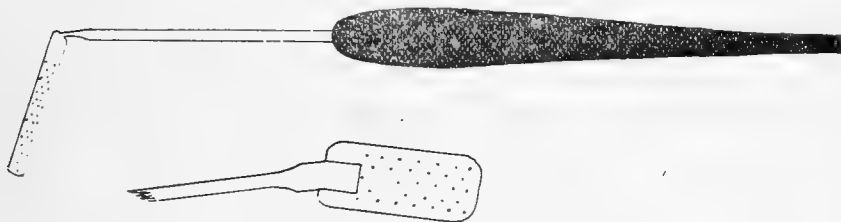

FIG. 249. Perforated section lifter. This is easily made by soldering a wire to some very thin sheet brass or copper, and then perforating this with a coarse needle or fine awl. Any roughness must be removed by using a fine oil stone.

in Castor-Xylene (§ 392). In a few days the collodion gets as transparent as glass and one can see the tissue within with great clearness. It can remain in the castor-xylene indefinitely.

In cutting one proceeds exactly as in § 457 except that the block is kept wet with castor-xylene and not with alcohol. The sections are arranged on the knife and transferred to the slide in the same way as for alcohol sectioning (§ 457-458).

For fastening the sections to the slide, as no water is present, one can add the ether-alcohol at once. It is advantageous here to have a mixture of ether 2 parts and absolute alcohol one part for melting the collodion in these oil sections.

Allow the slide to remain in the air till the collodion begins to look dull, then the slide may be transferred to a jar of xylene to remove the oil. From the xylene it is transferred to 95% alcohol and then the slide is ready to be stained, etc. as described below (§ 461-471).

Steps in Order for the Collodion Method.—§ 451-460, 461-471.

Name	No.
Animal.....	95% alc.....
Date.....	Ether-alc.....
Fixer.....	1½% col..... 3% col.....
Time of fix.....	6% col..... 8% col.....
Washed in water.....	Imbedded.....
67% alc..... 82% alc.....	Chloroform..... 67% alc.....
Decalc. § 398.....	Or castor-xylene.....
67% alc..... 82% alc.....	Sections cut..... μ's.....
In toto stain.....	Stains.....
Washed in.....	Mounted in.....
67% alc..... 82% alc.....	Remarks.....

STAINING AND PERMANENT MOUNTING

§ 461. Generalities on Stains.—From the standpoint of the object to be stained, dyes may be divided into two great groups:

(1) (a) Those which select out or differentiate certain parts of the tissue and make them prominent. Such dyes are called then *differential* or *selective*. If the nucleus is the part selected, the dye is frequently called a *nuclear dye*.

(b) *General or counter stains*. These stain all parts of the tissue, and are

usually contrasting in color; blue or purple and bright red are frequent combinations, *e. g.* hematoxylin and eosin.

(2) From the standpoint of the solvent used in preparing the stains they are called (a) *Aqueous*, and (b) *alcoholic*.

If one uses an aqueous stain the object must be well wet with water before the stain is applied, and afterward well washed with water before put again into alcohol. If an alcoholic stain is used the object to be stained should be from alcohol of the same strength as that used in making the dye. The dye is also washed away from the tissue with the same strength of alcohol; it may then be put into the stronger alcohols for dehydration.

For other classifications of dyes consult the larger works, Lee, Mann, Ehrlich, and the microscopical journals.



FIG. 250. *Pipette with large rubber bulb for adding liquids to preparations. (Cut loaned by the Bausch & Lomb Optical Co.)*

§ 462. **Generalities on Mounting.**—For permanent preparations one can use a medium like glycerin or glycerin jelly etc. which mixes with water. The method of procedure is given in § 407, 408.

For the most permanent mounting resinous media are used, and of these resinous media Canada balsam (§ 383) has been longest, and is now most used.

In mounting in balsam one must remember the fundamental principles: (1) the object to be mounted in balsam must not contain water. It must then be dried or desiccated, or it must be rendered anhydrous by some liquid which mixes with water. As all tissues and organs contain much water, to mount them in balsam without drying in the air, which would spoil them in most cases, one must take the following steps (1) Dehydrate by alcohol which mixes with and displaces the water; (2) Displace the alcohol by some liquid which mixes with it and is also miscible with balsam, *e. g.* xylene, etc. (§ 392). (3) As the liquid used just before the balsam usually makes the tissue more or less translucent it is often called a “*clearer*”. Finally displace the xylene etc. by balsam. If all the water is not removed in some way, the specimen will look turbid. If there is but a trace of water present and one uses natural balsam (§ 383) for mounting the small amount of water will finally disappear; but it is better to dehydrate the tissue thoroughly before adding the balsam.

HEMATOXYLIN WITHOUT AND WITH COUNTERSTAINING

§ 463. **Staining with Hematoxylin.**—Take a slide of sections prepared by the paraffin or the collodion method (§ 450, 459) from the jar of alcohol and plunge it into a vessel of water to remove the alcohol. For staining put the slide of sections into a jar or shell

vial of the hematoxylin solution (Figs. 243, 251) or one can lay the slide flat on the staining rack or some other support and add the stain to the sections (Fig. 248). It usually takes from 2 to 10 minutes to stain sufficiently with hematoxylin. A good plan when one is learning the process is to wash off the stain after 1 minute either with a pipette (Fig. 250) or by putting the slide in a dish of water. Wipe off the bottom of the slide and put it under the microscope. Light well, use a low power and one can see the nuclei stained a bluish or purple color as hematoxylin is a nuclear dye. If the color is faint, continue the staining until the nuclei stand out boldly. Sometimes it takes a long time to stain well with hematoxylin. In such a case the jar of stain may be put into the paraffin oven and the heat will accelerate the staining. One may also heat the individual slides as for spreading sections, but one must be careful not to let the stain dry on the sections. As the stain evaporates add fresh stain with a pipette.



FIG. 251. Apparatus and reagents with which the slide holders are used. With this apparatus it is easy to prepare specimens in large numbers very expeditiously. After the sections are fastened to the slide and placed in the holder, the slides need not be touched during all the operations until they are finally ready to be mounted in balsam. Each holder contains from 12 to 14 slides. The bottles for the reagents are glass stoppered specimen or museum bottles. (*Mix, Jour. Ap. Micr.* 1898, p. 171.)

When the sections are well stained with hematoxylin, wash off the hematoxylin with water. If the slide is allowed to stand some time in ordinary water the color is likely to be brighter. This is due to the action of the alkali (ammonia, etc.) usually present in

natural waters. One could use distilled water, adding a few drops of a saturated solution of lithium carbonate.

Dehydrate in 95% alcohol and absolute if necessary; clear and mount in balsam as described in the next section (§ 464).

Hematoxylin is so nearly a pure nuclear stain for most tissues and organs that the cell bodies are not very evident with this alone, hence some counter stain is generally used also.

§ 464. **Counterstaining with Eosin.**—One of the solutions of eosin (§ 401) is dropped upon the sections after the hematoxylin has been washed away with water. This stains almost instantly. One rarely needs to stain with eosin over 10 or 30 seconds. The excess stain is then washed away with a pipette or by dipping the slide into water.

§ 465. **Dehydrating, Clearing and Mounting.**—Put the slide directly into 95% alcohol after it is rinsed with water.* Leave it in the alcohol a short time and transfer to fresh 95% alcohol or to absolute alcohol a few seconds, 10-20. One must not leave the sections too long in the alcohol or the eosin will all dissolve out.

Remove the slide from the alcohol and put it into a jar of clearer (§ 392) or put it on the rack (Fig. 248, 251) and add enough clearer to cover the sections. Soon the clearer will displace the alcohol and make the sections translucent. It usually requires only half a minute or so. The clearer is drained off and balsam put on the sections, and then a clean cover-glass is added. One soon learns to use the right amount of balsam. It is better to use too much than too little. It is usually better to press the cover down very gently. With some delicate objects like embryos in the early stages this is

*In the past the plan for changing sections from 95% alcohol to water, for example, has been to run them down gradually, using 75, 50 and 35% alcohol, successively. Each percentage may vary, but the principle of a gradual passing from strong alcohol to water was advocated. On the other hand I have found that the safest method is to plunge the slide directly into water from the 95% alcohol. The diffusion currents are almost or quite avoided in this way. There is no time for the alcohol and water to mix, the alcohol is washed away almost instantly by the flood of water. So in dehydrating after the use of watery stains, the slide is plunged quickly into a jar of 95% alcohol. The diffusion currents are avoided in the same way, for the water is removed by the flood of the alcohol. This plan has been submitted to the severe test of laboratory work, and has proved itself perfectly satisfactory (1895-1908).

not safe. A safe method for all objects is to add a slight weight, and put the slide in a warm place.

After the balsam is quite dry the excess may be scraped off the slide with a knife and then the slide and cover cleaned from the remaining balsam by a piece of gauze wet with xylene. Finally the slide should be labeled and stored.



FIG. 252. *Copley's staining dish.*
A. The entire dish; B. The dish in cross section. This is made of glass and is a very neat piece of apparatus. With it ten slides may be stained at once. (Cut loaned by the Whitall Tatum Co.)

CROSS-SECTION
 SHOWING SLIDES
 IN POSITION.

§ 466. **Counterstaining with the Eosin in the Clearer.**—With this method the eosin is dissolved in the carbol-xylene clearer, and the hematoxylin stained sections are dehydrated with 95% alcohol and absolute alcohol if necessary and then placed in the clearer. The sections are cleared and stained in eosin at the same time. It usually takes half a minute or more for the double process. When the sections are clear and sufficiently red, the slide is removed and the clearer drained off by holding in the forceps or in the draining funnel (Figs. 248, 251). Then the balsam is added, and covered as described above.

It is a good plan to rinse off the stained clearer by pure xylene before adding the balsam. This is not absolutely necessary, however.

§ 467. **Hematoxylin and Picro-Fuchsin.**—Picro-fuchsin is so selective in its general staining that it is frequently used after hematoxylin. The hematoxylin staining should be intense and after the hematoxylin is washed away add the picro-fuchsin (§ 424). It takes only a few seconds for it to act, 10 to 30 seconds. Wash with distilled water, or natural water very faintly acidulated. The acid fuchsin is very sensitive to alkalis and fades easily.

Dehydrate in 95% and absolute alcohol, clear and mount in acid balsam. Acid balsam injures hematoxylin, but is necessary for the red in the picro-fuchsin.

Look out for mercuric chlorid crystals in the sections (§ 413, 477).

§ 468. **Hematoxylin and Mucicarmin.**—Tissues and organs are best fixed in Zenker's or mercuric chlorid. Small intestine is one of the most striking and instructive organs for this double stain. Make the sections by the paraffin method, but do not fasten them to the slide with collodion, for collodion stains with mucicarmin (§ 389).

Stain 1 to 24 hours in mucicarmin. Wash off the stain with water and then stain with hematoxylin. Do not stain too deeply. Wash with water, dehydrate, clear and mount in natural balsam. Nuclei will be bluish or purple and the cells containing mucus will be rose red. The goblet cells of the villi stand out like small red goblets, and if any mucus is streaming out of them it will be red.

WEIGERT'S ELASTIC STAIN, WITH PICO-FUCHSIN
AND MUCICARMIN

§ 469. **Elastic Stain.**—Take a slide of sections made either by the paraffin or the collodion method (§ § 439, 451) from alcohol and put the slide into a jar or a shell vial of the stain. This is an alcoholic stain (§ 461) hence the sections should not be washed in water. Allow the stain to act from $\frac{1}{2}$ hour to an hour. Wash off the superfluous stain with 95% alcohol from a pipette or by rinsing in a jar of 95% alcohol. It is better in either case to use the pipette and clean alcohol for the final washing.

This stain alone gives a bluish tone to the entire tissue, the elastic tissue being stained a very deep blue. For greater contrast and to bring out the white fibrous tissue, muscle, etc., counter-stain with picro-fuchsin of $\frac{1}{4}$ the strength given in the regular stain (§ 424, *i. e.*, picro-fuchsin 1 part, distilled water 3 parts).

Dip the slide of sections into distilled water, and then into a shell vial of the stain. Stain 15 to 30 seconds on the average. Wash in distilled water and dehydrate in 95% alcohol and absolute if necessary, then clear in carbol-xylene and mount in acid balsam (§ 387). The elastic tissue should be almost black; white fibrous

tissue red, muscle, blood and epithelia yellow or yellowish. Arteries are excellent for this combination.

§ 470. **Combined Elastic, Mucicarmin and Picro-Fuchsin Stain.**—For this, one should take some object that is known to contain elastic tissue, mucus, white fibrous tissue and muscle. (The non-cartilaginous part of the trachea is excellent.) The organ should have been fixed in mercuric chlorid or Zenker's fluid (§ § 416, 429) for this preparation. The sections should be made by the paraffin method (§ 439) and no collodion should be used for fastening the sections to the slide (§ 450) for collodion is stained by mucicarmin.

(1) Stain first in the elastic stain 1 hour. Wash well with 95% alcohol and then with water.

(2) Stain in a shell vial or jar of mucicarmin (§ 389) from 1 to 24 hours. Wash well with water, but one must be careful in treating these sections as they have no collodion mantle to protect them.

(3) Stain 15 to 30 seconds with picro-fuchsin of $\frac{1}{4}$ strength (§ 469). Dehydrate with 95% and if necessary absolute alcohol. Clear in carbol-xylene and mount in acid balsam (§ 387). The elastic tissue will be black or blue black. Mucus will be carmin or rose red, white fibrous tissue will be magenta red, muscle, epithelium and blood will be yellow.

EOSIN METHYLENE BLUE STAINING

§ 471. **Eosin Methylene Blue.**—One of the best objects for this stain is a hemolymph gland. Such a gland is easily and surely found by a beginner if he takes the heart and lungs of a veal. In the fat around the heart and behind the pleura will be found red bodies looking almost like blood clots. Remove carefully, fix in Zenker's fluid or mercuric chlorid, (§ § 416, 429). Section by the paraffin method, make the sections 5μ and 10μ thick. Use collodion for ensuring the fixation to the slide (§ 450). Stain the sections 5 minutes in alcoholic eosin (§ 402). Wash off the eosin stain with water. (This is an exception to the generalization in § 461, 2.)

Stain in methylene blue (§ 417) $\frac{1}{2}$ to 5 minutes. Rinse well in tap water. Dehydrate with neutral 95% alcohol (§ 380) and

with absolute alcohol. Work rapidly with only one slide at once. Clear with pure xylene, mount in neutral balsam (§ 386). All nuclei should be blue and all red blood corpuscles, bright eosin red. If one is successful this is a most striking and instructive preparation. Spleen is also very instructive.

Eosin-methylene blue staining is also excellent for demonstrating mucus (§ 468).

Do not forget that mercury is liable to be present in sections of tissue fixed with any mercuric fixer. Remove them with iodized alcohol (§ 413). This should be done before the staining. One can tell whether the tissues contain mercury by looking at the unstained sections. The mercury looks black by transmitted light, white by reflected light. The substance is often in the form of delicate black pins.

MAKING SERIES; SERIAL SECTIONING

§ 472. **General on Series.**—It is coming to be appreciated more and more that in histology as well as in embryology one can only get a complete knowledge of structure by having the entire organ cut in microscopic sections and each section mounted in order. Furthermore it is necessary to have the organ cut in three different planes. In this way one can see every aspect of the structural elements and their arrangement in the organs.

In single sections one gets only a partial view. For example, how many students have any other idea of a ciliated cell than that it is a cell with triangular outline with a brush of cilia at the broad end. Probably many would be puzzled if they had a top view of the ciliated end; and the attached end would be even more puzzling.

It may not be possible for every worker to make serial sections of all the organs in all the three planes, but every one who is working seriously in histology can make all his preparations serial, that is the sections which are mounted can be in serial order, then a puzzling appearance in one section may be perfectly intelligible in one a little farther along.

To get the greatest benefit from serial as indeed also from single sections, the sections should be made in a definite manner, that is, they should be exactly across the long axis of an organ or parallel with the long axis (*Transections*, and *Longisections*).

Or with such an organ as the liver, the skin, etc., the sections may be parallel with the surface, (*Surface Sections*) or at right angles to the surface (*Vertical Sections*).

ORDER OF THE SECTIONS IN A SERIES

§ 473. **Order of Serial Sections.**—Some plan must be adopted in arranging the series or only confusion will result. An excellent plan is to arrange the short pieces of ribbons for a given slide as the words on a page are arranged. That is, section No. 1 is at the upper left hand corner. The next row of sections begins where the first row left off, etc., (Fig. 253).

As the paraffin stretches considerably one must cut the ribbons into pieces considerably shorter than the cover-glass to be used.

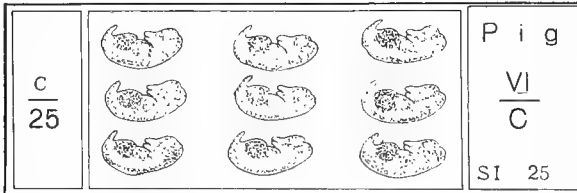

FIG. 253. Slide of an embryologic series showing the method of arranging a sagittal series. This is the 25th slide of the series. The sections are arranged like the words and lines in a book, i. e., from left to right. (From "Guide to Histology and Embryology in Cornell University.")

Both the paraffin and collodion methods are adapted to the preparation of series. The paraffin ribbons are easier to manage and easier to make than the serial sections in collodion.

By arranging the collodion sections as they are cut on the knife in collodion sectioning (§ 457), one can put them on the slide in perfect series by the tissue paper method (§ 458).

If the sections are large, as in cutting serial sections of the central nervous system, the series can be kept in order in a small dish by putting a piece of tissue paper over each section and piling them up. If the vessel is small enough the papers and sections will not shift and get out of order. Or one might put a single section in a Syracuse watch glass and pile them up in series (Fig. 208). Then in mounting the sections can be taken in order.

§ 474. **Numbering the Serial slides.**—For temporary numbering a fine pen with Higgins' waterproof carbon ink serves well. If the slide is clean one can write on it as well as on paper. When the ink is dry it should be coated with thin shellac or with thin xylene balsam. Sometimes thin collodion is used. It is also important to write the number of the slide with a writing diamond. The double marking is desirable because with wet slides the diamond number is hard to see, while the ink marks are clearly visible. One is not so liable to wipe off the sections if the ink mark is present.

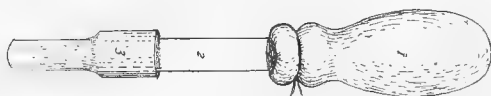
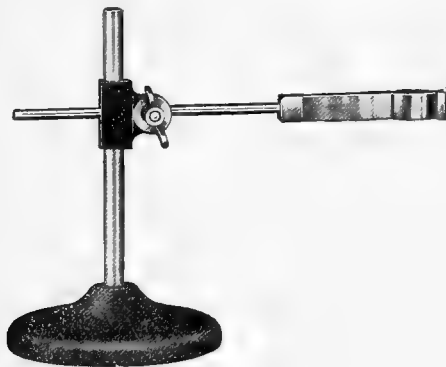

FIG. 254. *Egg pipette.* This is made by putting a short piece of soft rubber tubing over the end of a glass pipette with rubber bulb. With this one can handle the eggs both fresh and hardened without any danger of injury. (*Jour. Appl. Micr.* 1898, p. 129.)



(Cut loaned by the Bausch & Lomb Opt. Co.)

FIG. 255. *Lens holder.* A lens in such a holder is very convenient for sorting and orienting small eggs or embryos in imbedding. One can have the eggs in a watch-glass of melted paraffin on a copper warming plate (Fig. 241) and arrange the eggs or embryos under a lens in such a lens holder. Then if cold water is poured on the plate around the watch-glass the paraffin will cool and hold them in place.

FIXING AND STAINING FOR SERIES

§ 475. **Fixing.**—The two most used fixers for embryos are Zenker's fluid and Formaldehyde (§ 406, 429). For those unskilled in microscopic technic, or for one who is exceedingly busy the best results are obtained by putting the embryos in formaldehyde, (10 parts of formalin, the formalin of the pharmacy, and 90 parts water answers well). If there is plenty of this the embryos are likely to

be well preserved even though they are left in the membranes, and that is far the best way for small embryos.

§ 476. **Fastening the Sections to the Slide.**—For all serial work it is especially desirable to fasten the sections to the slide with collodion (§ 450). This should always be done unless some stain like carmin is to be used on the slide after the sections are fastened. With thin sections, if one is careful enough, an entire series can be carried through without losing a section, but with thick sections (15μ and thicker) some are almost sure to separate from the slide.

§ 477. **Removal of Mercuric Chlorid from Sections.**—It should be remembered that if a fixer containing mercuric chlorid is used the sections are almost sure to contain mercury. By transmitted light the mercury appears dark. Often the appearance is as if a multitude of delicate black pins were in the section. Sometimes the mercury is in rounded masses. This should be removed by putting the slides of sections into alcoholic iodine (§ 413). After half an hour or an hour wash off the iodized alcohol with pure 95% alcohol and the sections are ready for staining.

If the embryo was stained in toto and contains mercury, the sections should be passed from the deparaffining xylene to the iodized alcohol (§ 413). After half an hour or more the slides are passed through pure 95% alcohol, and back to the xylene or to carbol-xylene. Then they can be mounted in balsam.

§ 478. **Staining for Series.**—There is a great advantage in point of time and safety in staining the entire embryo in some good stain like borax carmin (§ 388). Carmin is a very permanent stain also. For bringing out special structural details the sections are stained on the slide as described in § 461-471. The slide baskets are almost a necessity for serial work (Fig. 244, 251), as the slides are handled individually only twice, (1) when they are spread and dried and put into the baskets, and (2) after all the processes are complete and the sections are to be mounted in balsam.

The sections are mounted in balsam directly from the deparaffining xylene. No alcohol is used unless it is necessary to remove crystals of mercuric chlorid (§ 477).

SERIAL SECTIONS OF EMBRYOS

§ 479. **Serial Sectioning Embryos and Minute Animals.**—

Serial sections of these should be made in the three cardinal sectional planes, viz; Transections; Frontal Sections; Sagittal Sections.

If models are to be constructed from the sections it may be more conveniently done if the sections are one of the following thicknesses: 5μ , 10μ , 15μ , 20μ , 30μ , 40μ , 50μ , 60μ , 80μ .

§ 480. **Transections**, that is sections across the long axis of the embryo or animal.

Imbed the embryo with the right side down, taking the precaution to have a layer of paraffin between the embryo and bottom of the box (§ 441).

(1) Mount the block of paraffin containing the embryo so that the tail end is next the microtome holder. The head is then cut first.

(2) Place in the microtome so that the right side of the embryo meets the edge of the knife.

(3) Mount as a printed line and the first or cephalic section is at the upper left hand corner, and the dorsal aspect of the embryo is toward the upper edge of the slide.

Under the microscope the rights and lefts appear as in the observer's own body, also the dorsal and ventral aspects so that he can easily locate parts by comparing them with his own body.

§ 481. **Frontal Sections**, that is sections lengthwise of the embryo or animal and from right to left (dextral and sinistral), so that the embryo is divided into equal or unequal dorsal and ventral parts.

Imbed the embryo with the right side down in the imbedding box as before.

(1) Mount the paraffin block so that the ventral side of the embryo is next the microtome holder. The dorsal side is then cut first.

(2) Let the right side of the embryo meet the edge of the knife.

(3) Mount the first section on the left end of the slides as before so that the sections are crosswise on the slides, the tail toward the upper edge. Under the compound microscope the head appears toward the upper edge and the rights and lefts are as in the observer's own body.

(4) If the sections are too long to mount crosswise of the slide, cut the sections apart and mount with the head to the right.

§ 482. **Sagittal Sections**, that is sections lengthwise of the embryo or animal and from the ventral to the dorsal side, thus dividing the body into equal or unequal right and left parts.

For these sections imbed the embryo with the right side down as before.

(1) Put the right side of the embryo next the microtome holder, then the left side is cut first.

(2) Let the caudal end meet the knife edge if the embryo is small.

(3) Put the first section in the upper left hand part of the slide as in the other cases. The sections will be lengthwise of the slide. This brings the ventral side up and the head to the right on the slide. Under the microscope the head appears at the left and the dorsal side away from the observer (Fig. 253).

(4) For large or long embryos place the right side next the microtome holder as above, but let either dorsal or ventral aspect meet the knife. Cut the sections apart and mount as in (3).

§ 483. **Axes for Sections.**—For transections cut across the longest straight line from head to tail.

For sagittal sections select the straightest embryo and cut parallel with the longest axis dorso-ventral.

For frontal sections cut parallel with the long axis, dextro-sinistral.

§ 484. For serial sections with collodion imbedded objects it is a great advantage to have the imbedding mass unsymmetrically trimmed, so that if a section is accidentally turned over it may be easily noticed and rectified.

Furthermore it is imperatively necessary that the object be so imbedded that the cardinal aspects, dextral and sinistral, dorsal and ventral, cephalic and caudal, shall be known with certainty.

§ 485. **Thickness of Cover-Glass for Serial Sections.**—It is a great advantage to use very thin cover-glasses (0.12-0.18 mm.) for serial sections, then the cover will not prevent the use of high powers. When the ordinary slides (25×76 mm., 1×3 inch) are used, cover-glasses 24×50 mm. may be advantageously employed.

The combined thickness of the sections on a slide is easily determined by multiplying the number of sections by the thickness of each.

§ 486. **Labeling Serial Sections.**—The label of a slide on which serial sections are mounted should contain at least the following:

The name of the embryo and the number of the series; the number of the slide of that series; the thickness of the sections, and the number of the first and last section on the slide; the date. It is also a convenience to have the information repeated in part on the left end.

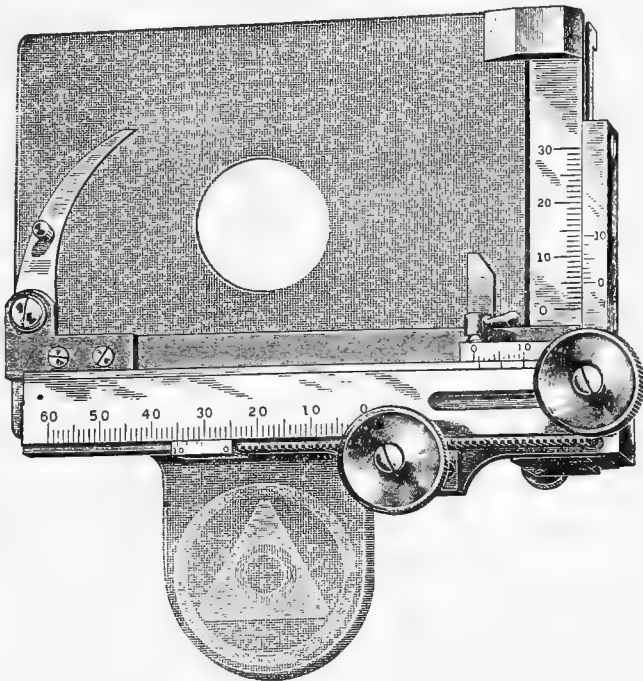

FIG. 256. *Removable mechanical stage. It fits any square stage and has the advantage of large motion in both directions making it especially useful for the study of serial sections. (Cut loaned by the Spencer Lens Co.)*

REFERENCES

For sectioning staining, etc., in the various ways see: Lee, Mann, Ehrlich, Mallory and Wright. *The Microscopic Journals.*

For the preparation of Embryos see Foster and Balfour's *Elements of Embryology.* Minot's *Laboratory Text-Book of Embryology.* Consult also the general Bibliography at the end.

DRAWINGS FOR PUBLICATION

‡ 487. **Preparation of Drawings.**—The inexpensive processes of reproducing drawings bring within the reach of every writer upon scientific subjects the possibility of presenting to the eye by diagrams and drawings the facts discussed in the text. Though artistic ability is necessary for perfect representation of an object, neatness and care will enable anyone to make a simple illustrative drawing, from which an exact copy can be obtained and a plate prepared for printing.

A careful study of the cuts or plates used to illustrate the same class of facts as one wishes to show will enable one to produce similar effects. Outlines which are transferred to the drawing paper may be obtained by the camera lucida, the projection microscope (Figs. 257–258), or from a photograph. The drawing should be made so that it can be reduced anywhere from one-eighth to one-half. For ordinary photo-engraving for such line drawings as are used to illustrate this book, use perfectly black carbon ink. A shaded or wash drawing can be reproduced by the half-tone process, also photographs as is illustrated by figures 79, 82, 89–92, 180–182. A crayon drawing on stipple paper with shadows re-enforced by ink lines and high lights scratched out with a sharp knife give admirable results for anatomic figures by the half-tone process. For examples see the various volumes of the *American Journal of Anatomy*. In vol. iv. pp. 409–443, and in vol. viii, pp. 17–47, one will find in the accompanying plates pure line drawings, half tones from photographs, and half tones from shaded drawings.

‡ 488. **The Lettering on Drawings.**—For half-tones this should be done directly on the drawing, as illustrated by the plates just referred to.

For photographic reproduction of line work, letters, numerals or words used to designate the different parts can be put on the drawings by pasting the printed letters etc. of the proper size in the right position. In preparing the block the engraver removes all shadows from the edge so that the letters look as if printed on the drawing. If tissue paper were used on which to print the letters the engraver would have less trouble in removing shadows around the edge of the paper.

Letters and figures should be distinct, but not so large that they are the most conspicuous feature of the drawing.

MODELS FROM SERIAL SECTIONS

‡ 489. **General Considerations on Modeling.**—Anatomists have for a long time produced models of gross anatomic specimens, and enlarged models for minute details.

Naturally after serial sections of embryos and organs came to be made with considerable accuracy and of known thickness, there was a desire to make enlarged models which should be exact representations of the original rather than the generalized approximations built up as an artist produces a statue.

Further the difficulty of getting a true conception of the object by studying only two dimensions in the sections is very great, hence a model giving all three dimensions becomes almost a necessity for the beginner in embryology, and is of enormous advantage to an investigator in working out the true form and relation of complex structures.

The principles involved in the construction of a model are exceedingly simple :—

1. It is necessary that the embryo or other object to be modeled should be cut into a series of sections of definite thickness.
2. The sheets of modeling material must be as much thicker than the sections as the model is to be larger than the original.
3. The sections must be drawn as much larger than the actual specimen as the model is to be larger than the object.
4. The drawings with the desired outlines must be made directly upon or transferred to the sheets of modeling material which are then cut out, following the lines of the drawing.
5. The different plates of modeling material representing all the sections are then piled up, in order, thus giving an enlarged model of the object with all its parts in proper position and in true proportions.

MODELS OF WAX

‡ 490. **Wax Models.**—For making wax models, bees-wax 820 grams, paraffin 270 grams, and resin 25 grams, are melted together and thoroughly mixed.

To get the sheets of wax of the proper thickness two methods are available :—

(1) The hot wax is poured into a vessel containing hot water. The wax spreads out into an even layer over the hot water and is allowed to cool. While it is solidifying it should be cut free from the edges of the vessel. Of course by calculation and experiment one can put in the right amount of wax to get a plate of a given thickness.

(2) One must have a wax-plate machine consisting of a flat surface—planed cast iron is good—with some means of obtaining raised edges. If these are adjustable by a micrometer screw it is simple to set them properly for the desired thickness of plate. Then there must be a hot roller. The hot wax is poured on the plate and with the hot roller resting on the raised edges, the wax is rolled out into a plate. It cools quickly and may be removed for another plate. This is the most rapid and satisfactory method of preparing the plates. By using a brush with turpentine the paper with the drawing can be wet and then with the hot roller cemented to the plate before that has been removed from the machine.

The wax plate is cut with a sharp instrument, following the outlines of the object which has been traced upon it by the aid of a camera lucida or the projection microscope. The sections are piled together, some line or lines obtained from a drawing or photograph of the specimen before it was imbedded

and sectioned being used as a guide by which the correct form of the pile of sections can be tested. Finally the whole is welded into one by the use of hot wax or a hot instrument. Models which illustrate complex internal structures are difficult to prepare, but numerous devices will occur to the worker, as the representation of blood vessels and nerves by strings or wires. A large model will need much support which can be given by wire gauze, wires, pins or paper according to the special needs.

A practical method for wax modeling was first published by G. Born, *Arch. f. Mikr. Anat.*, Bd. xxii, 1883, p. 584. The most detailed statements of improvements of the method have been published by Born (Böhm u. Opper) 1904, and by Dr. F. P. Mall and his assistants. See contributions to the *Science of Medicine*, pp. 926-1045. *Proceedings of the Amer. Assoc Anatomists*, 1901, 14th session (1900) p. 193. A. G. Pohlman, *Zeit. wiss Mikroskopie*, Bd. xxiii, 1906, p. 41.

To overcome the difficulty of cutting out the wax plates, Dr. E. L. Mark of Harvard University uses an electrically heated wire moved rapidly by a modified sewing machine (*Amer. Acad. Arts and Sciences*, March, 1907; *Science*, vol. xxv, 1907; *Anat. Record* April, 1907).

MODELS OF BLOTTING PAPER

§ 491. **Comparison of Wax and Paper Models.**—Wax has certain inherent defects for models: It is expensive, heavy and fragile. It is easily deformed by the temperature of summer, and the amount of time necessary for the preparation of the plates is great. A wax-plate machine is expensive and bulky.

It therefore seemed worth while to see if there was not some other material obtainable in the open market which would be more suitable and more generally available.

Blotting paper seemed promising, and an actual trial showed it to be admirably adapted for the purpose. Since making the first model in 1905 it has been constantly used in the laboratory of embryology in Cornell University. Models made from it were demonstrated before the Association of American Anatomists in 1905 and before the International Congress of Zoology in 1907.

“The advantages of blotting paper models are the ease and cleanliness of their production and the lightness and durability of the product. The models are broken with difficulty, are easily packed or transported, and when they cleave apart are easily repaired, thus contrasting with the weight and fragility of wax models and their deformation by heat.”

“By this process are secured for the original model reconstructed from microscopic sections, the same qualities which have

made the Auzoux models molded from papier-maché such useful and lasting additions to laboratory equipment ; and in the hands of Dr. Dwight and Mr. Emerton, of Harvard University, have aided so much in the demonstration of structure and form of special anatomic preparations. ”

§ 492. **Thickness of Blotting Paper.**—Blotting paper of a uniform thickness of 1 mm. $\frac{9}{10}$ mm. and $\frac{1}{2}$ mm. were found in the market. The 1 mm. is known as 140 lb. A. and costs about two cents for a sheet 61×48 centimeters (24×19 in.).*

The thickness is easily tested by cutting out 50 small pieces, piling them, dipping one end in melted paraffin and pressing them together. The whole pile should of course measure 50 mm. if the paper is millimeter paper.

§ 493. **Size of the Model.**—In deciding upon the size of the model to be made from a given series of sections one should select the largest section and with the projection microscope throw the image on the table (Fig. 258). By using different objectives and different distances from the microscope one can find a size which seems suitable. The magnification may be found by § 207. Then by multiplying the whole number of sections by the thickness of the sections and this by the magnification one can get the length or height of the model. One must take these preliminary steps and decide upon the magnification to be used or the model is liable to be too large to be manageable or too small to show well the necessary detail.

(1) Suppose the model is to be 100 times the size of the original object, and the object has been cut into a series of sections 10μ thick. Then each section must be represented by a plate or sheet 100 times as long, broad and thick as the object. As the sheets of blotting paper are so large (61×48 cm.) one need be solicitous only about the thickness.

As each section is actually 10μ thick and the model is to be 100 times enlarged, the thickness representing each section must be

*Book-stores, paper dealers and job printers are supplied by the paper manufacturers with samples of blotting paper. One can look these samples over, select and order the kinds desired. The millimeter blotting paper mentioned in the text is one of the cheaper grades, costing by the package of 500 sheets about two cents a sheet (sheets 61×48 centimeters, 24×19 inches).

$10\mu \times 100 = 1000\mu$ or 1 millimeter. 1 millimeter blotting paper is used and every section of the series is drawn.

(2) If the blotting paper were only $\frac{9}{10}$ mm. thick it would be simpler to make the model 90 times the size of the original. If, however, one wished the magnification to be 100, it could be accomplished thus: Each section in the series should be represented by 1 mm. or 1000μ in thickness. But if one uses blotting paper of $\frac{9}{10}$ mm. thickness or 900μ , there is a loss of 100μ for each section and for 9 sections there would be a loss of 900μ or the thickness of a sheet of the blotting paper. To remedy this one uses 10 sheets of blotting paper for 9 sections. This keeps the model in true proportion. In practice each of the sections is drawn upon one sheet except one of them and for that two sheets of the blotting paper are united and the sections drawn upon the double sheet.

§ 494. **General Rule for the Use of Blotting Paper.**— Divide the thickness by which each section is to be represented in the model by the thickness of one sheet of the blotting paper available. The quotient shows the number of sheets or the fraction of a sheet required for each section.

If a quotient is a mixed number reduce it to a fraction. The numerator represents the number of sheets required and the denominator the number of sections to go with the sheets.

Examples: (a) With a series of 10μ sections to be modeled at 100 enlargement each section of the series must be represented in the model by a thickness of $10\mu \times 100 = 1000\mu$ or 1 millimeter. If one uses millimeter or 1000μ paper then $1000\mu \div 1000\mu = \frac{1}{1}$, and one must use 1 sheet for 1 section.

(b) With a series of 10μ sections to be made into a model 100 times enlarged, and with blotting paper of $\frac{9}{10}$ mm. or 900μ thickness, each section must be represented by $10\mu \times 100 = 1000\mu$. If the blotting paper is 900μ thick, then it requires for each section: $1000 \div 900 = 1\frac{1}{9}$ sheets of paper or $\frac{10}{9}$ sheets for one section or 10 sheets for 9 sections, that is a double sheet for one of the nine sections.

(c) With a series cut 15μ , for a 50 fold model. Each section is represented by a thickness of $15\mu \times 50 = 750\mu$. If one uses 1 mm. or 1000μ blotting paper then each section requires $750 \div 1000\mu = \frac{3}{4}$

of a sheet for one or 3 sheets for 4 sections. In this case one omits every fourth section in drawing, thus: 1st, 2d, and 3d sections would be drawn; then the 5th, 6th and 7th; 9th, 10th, 11th, etc., every fourth being omitted.

(d) If for the model just considered one had $\frac{9}{10}$ mm. or 900μ paper then $750 \div 900 = \frac{5}{6}$. That is there must be 5 sheets of the paper for each 6 sections. In that case every sixth section would be omitted in the drawing as every fourth section was omitted in (c).

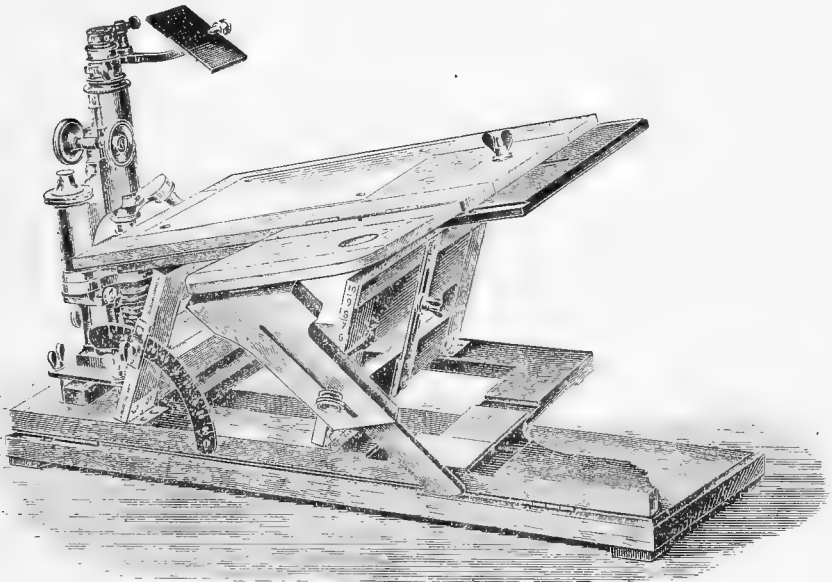

FIG. 257. *Abbe Camera Lucida in connection with Bernhard's drawing board. The drawing board is adjustable vertically for a greater or less image distance. It may also be elevated toward the microscope to prevent distortion (Fig. 129). The base board is hinged so that microscope and board may be inclined together (Zeiss' Catalog).*

It is of course best to use sheets of exactly the right thickness to represent the necessary thickness in the model, (a) but one can produce models with accuracy by duplicating one or more sheets for a group of sections (b) or by omitting certain sections of the series in drawing (c, d).

§ 495. **Drawings for Models.**—For drawing one may use the camera lucida (Figs. 128, 132, 257), taking the precautions to

avoid distortion (§ 204). For getting the exact magnification desired one has recourse to different oculars, objectives and distance of the drawing surfaces (§ 177, 206 E).

By far the most satisfactory means for making the numerous drawings of all sizes of object and all magnifications except the highest, is the projection microscope (Fig. 258).

One can draw directly upon blotting paper, but it is so important to have a drawing to refer back to that one or more duplicates should be made. This is easily accomplished by putting a sheet of carbon manifold paper on the blotting paper and a sheet of thin

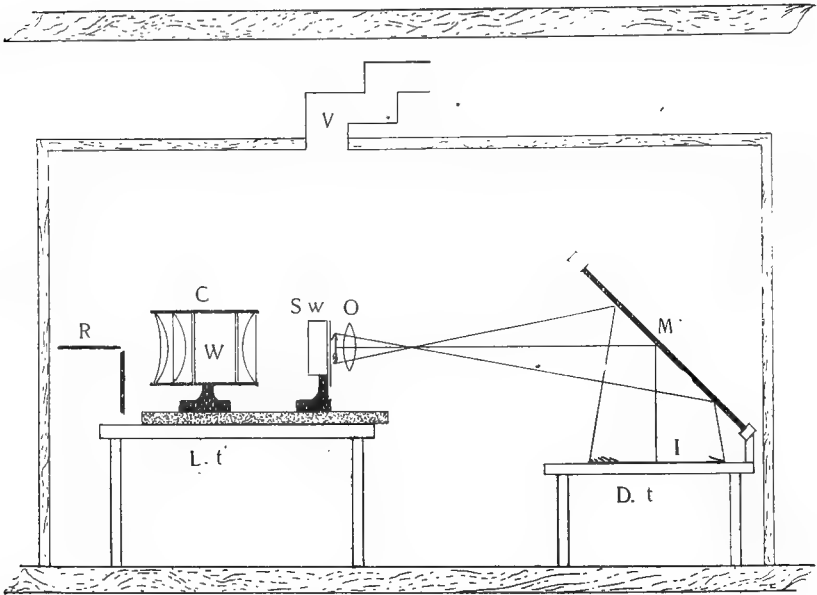

FIG. 258. *Room and Apparatus for Drawing with the Projection Microscope.* R. Radiant, an arc lamp with carbons at right angles; L. t. Lamp and microscope table; C. Condenser with W. a large water bath between the lenses to absorb the heat rays. S. w. Stage and stage water bath on which rests the object and keeps the object cool by radiation as well as by absorption; O. The objective representing the microscope; M. Mirror at 45° on a drawing table, (Dl.) As the microscope is horizontal so that the axial ray is reflected downward at right angles by the 45° mirror there is no distortion. The scale of the drawing is added exactly as described in § 207.

paper over the carbon paper using thumb tacks to hold the blotting paper and the duplicating sheets in position.

One should take the precaution to number each drawing as it is made then confusion in the later processes will be avoided.

§ 496. **Cutting out the Sheets for the Model.**—“With the blotting paper, if the drawings are small the cutting is easily done with scissors or a knife. When the drawings are large and especially when the model is to be made by representing each section by two or more thicknesses of blotting paper it has been found that an ordinary sewing-machine can be used to do the cutting. By setting the regulator for the shortest stitch an almost continuous cut is made and the parts are easily separated. If a large sewing-machine needle is sharpened in the form of a chisel, the cut becomes considerably smoother. It has been found advantageous when long continued or heavy work is to be done to attach to the machine an electric sewing-machine motor. Skill in guiding the work is soon acquired. There are some details of a complicated drawing which are more easily cut by the scissors or a knife after the main lines have been cut by the machine.”

§ 497. **Contrasting Colors for Marking Groups of Sections.**—“It is a great advantage in any working model to have sections at regular intervals in marked contrast with the body of the material. Blotting paper of a large variety of colors (black, red blue, pink) is easily obtained in the market. In the models made every tenth plate was a bright or light color and every rooth was black, rendering rapid numeration easy.”

§ 498. **Putting the Sheets together to Make the Model.**—“When the paper sections are thus prepared they are piled and repiled as is usual until the shape conforms to an outline predetermined from photographs, drawings, or measurements made before the specimen was cut.”

“It has been found that an easily prepared support and guide for the model in process of setting up, is made by cutting the outline to be followed from a block of four or five sheets of blotting paper, marking upon it the lines of direction of every tenth or twentieth section. The colored numerating plates must of course conform to the spacing and direction of these lines.”

“The preliminary shaping having been accomplished more

exact modeling is undertaken. The paper sections slide very easily upon one another. The most satisfactory means of fastening them together is by the use of ribbon pins, ordinary pins, or wire nails of various sizes, depending on the size of the model. No kind of paste or glue was found suitable for this purpose."

§ 499. **Finishing the Model.**—"When the model is well formed, inequalities are best removed by rubbing with the edge of a dull knife and smoothing with sand paper. Any dissections of the model for showing internal structures should be planned for at this stage for it is now more easily separated than later. It is also at this time that superfluous "bridges," which have been left in place to support detached parts, would better be removed."

"To finish the model it is held together firmly and coated with hot paraffin either by a camels hair brush or by dipping in paraffin and removing the superfluous coating by a hot instrument. One might use a thermo-cautery for this purpose."

"The paraffin renders the model almost of the toughness of wood without destroying the lightness of the paper."

§ 500. **Coloring the Surface; Dissecting the Model.**—"For coloring the surface of the model, it was found most desirable to use Japanese bibulous paper, lens paper (§ 125) which had been dipped in water color and dried. Any of the laboratory dyes or inks can be used, such as eosin, picric acid, methylene green, black ink, etc. The colored lens paper molds over the surface with ease and is held in place by painting with hot paraffin. All color and enumeration lines and fine modeling show through the transparent paper."

"When the model ceases to be a working model it can be covered with oil paints mixed with hot paraffin and rubbed to any degree of finish desired."

"One can dissect a model by a hot knife run along the planes of cleavage or cut across them by a saw."

For the literature of blotting paper models see: Susanna Phelps Gage, *Amer. Jour. Anat.*, vol. v, 1906, p. xxiii; Proceedings of the International Zoological Congress for 1907; *Anatomical Record*, Nov. 1907. (From this paper the above quotations were made). *Zeit. wiss. Mikroskopie*. Bd. xxv., 1908, pp. 73-75.

"Blotting paper models have also been made and demonstrated by Dr. J. H. Hathaway and by Dr. J. B. Johnston at the Association of American Anatomists held in New York, 1906 (*Proc. Assoc. Amer. Anatomists*, *Anat. Record* April 1, 1907).

BIBLIOGRAPHY

The books and periodicals named below in alphabetical order pertain wholly or in part to the microscope or microscopical methods. They are referred to in the text by recognizable abbreviations.

For current microscopical and histological literature, the *Journal of the Royal Microscopical Society*, the *Zoologischer Anzeiger*, and the *Zeitschrift für wissenschaftliche Mikroskopie*, *Anatomischer Anzeiger*, *Biologisches Centralblatt* and *Physiologisches Centralblatt*, the *Journal of Applied Microscopy* and *Laboratory methods* and the smaller microscopical journals taken together furnish nearly a complete record. See also the list of periodicals.

References to books and papers published in the past may be found in the periodicals just named, in the *Index Catalog of the Surgeon General's library*, in the *Royal Society's Catalog of Scientific Papers*, and in the bibliographical references given in special papers. A full list of periodicals may also be found in Vol. XVI of the *Index Catalog*, and in later volumes, the new ones are given.

BOOKS

Abbe, E.—*Gesammelte Abhandlungen*. Bd. II. Pp. 346. *Illust.* Jena, 1906. This volume deals with the microscope, etc. Edited by Dr. E. Wandersleb.

Adams, G.—*Micrographia illustrata, or the microscope explained*, etc. *Illust.* 4th ed., London, 1771.

Adams, George.—*Essays on the Microscope*. 4 to. *Illust.* London, 1787.

Angström.—*Recherches sur le spectre solaire, spectre normal du soleil*. Upsala, 1868.

Anthony, Wm. A., and Brackett, C. F.—*Elementary text-book of physics*. 8th ed. Pp. 524, 165 Figs. New York, 1897.

Auerbach, F.—*Das Zeiss-Werk und die Carl Zeiss-Stiftung in Jena, ihre wissenschaftliche, technische und soziale Entwicklung und Bedeutung*. 3d ed. Pp. 166. *Illust.* Jena, 1907.

Babcock, J. F.—*The medico-legal examination of Blood and other Stains, Hairs and Fibers*. New York, 1894.

Bagshaw, W.—*Elementary Photomicrography*. Pp. 70. *Illust.* London, 1902.

Baily, Frederick R.—*A text-book of histology*. 2d revised ed. Pp. 497. *Illust.* New York, 1906.

Baker, Henry.—*Of Microscopes and the discoveries made thereby*. Illustrated by many copper plates. 2 vols. London, 1742-3, 1785.

Barker.—*Physics*. Advanced course. Pp. 902, 380 Figs. New York, 1892.

Bausch, E.—*Manipulation of the Microscope*. A manual for the work table and a text-book for beginners in the use of the microscope. Pp. 200. *Illust.* New ed. Rochester, N. Y., 1901.

Bausch, Edward.—*Use and care of the Microscope (Extracts from Manipulation of the Microscope)*. Rochester, 1902. This booklet should be in the hands of every beginner in microscopy. It is furnished free to laboratory teachers, and is supplied with each microscope.

Bayley, R. Child.—*The complete photographer*. Pp. 410. *Illust.* London and New York, 1907.

Bayon, P. G.—*Die histologischen Untersuchungs-methoden des Nervensystems*. Pp. 187. *Illust.* Würzburg, 1905.

Beale, L. S.—*How to work with the Microscope*. 5th ed. Pp. 518. *Illust.* London, 1880. Structure and methods.

Beauregard, H., et Galippe, V.—*Guide de l'élève et du praticien pour les travaux pratiques de micographie, comprenant la technique et les applications du microscope à l'histologie végétale, à la physiologie, à la clinique, à la hygiène et à la médecine légale*. Pp. 904, 570 Figs. Paris, 1880.

- Beck and Andrews.—Photographic lenses. 2d ed. London, 1903. Many illustrations showing various forms of photographic objectives and the work for which they are adapted.
- Beck, Conrad.—The Theory of the Microscope. Cantor Lectures delivered before the Royal Society of Arts, Nov.-Dec., 1907. Pp. 59. Illust. London, 1908.
- Behrens, H.—Mikrochemische Technik. 2d ed. Pp. 68. Hamburg, 1900.
- Behrens, H.—Anleitung zur microchemischen Analyse der wichtigsten organischen Verbindungen. Hamburg, 1895-1897.
- Behrens, H.—Transl. by J. W. Judd. A manual of microchemical analysis with an introductory chapter by J. W. Judd. London, 1894.
- Behrens, W.—The microscope in botany. A guide for the microscopical investigation of vegetable substances. Translated and edited by Hervey and Ward. Pp. 466. Illust. Boston, 1885.
- Behrens, W.—Tabellen zum Gebrauch, bei mikroskopischen Arbeiten. 3d revised ed. Pp. 237. Braunschweig, 1898.
- Behrens, W., Kossel, A., und Schiefferdecker, F.—Das Mikroskop und die Methoden der mikroskopischen Untersuchung. Pp. 315, 193 Figs. Braunschweig, 1889+.
- Bethe, A.—Allgemeine Anatomie und Physiologie des Nervensystems. Pp. 487. Illust. Leipzig, 1903.
- Boehm, A. A., und von Davidoff, M.—A text-book of Histology, including microscopic technique, from the 2d German edition. Translated by H. H. Cushing and edited by G. C. Huber. Pp. 528. Illust. 2d Amer. ed. Philadelphia and London, 1904.
- Boehm, A., und Oppel, A.—Taschenbuch der mikroskopischen Technik, 5th edition with directions by Born for making wax models. Pp. 277. München, 1904.
- Bousfield, E. C.—Guide to photo-micrography. 2d ed. Illust. London, 1892.
- Bottler.—Die animalischen und vegetabilischen Faserstoffe. Leipzig, 1902.
- Bowman, F. H.—The structure of the wool fiber, and its relation to technical applications. Illust. New York, 1908.
- Brewster, Sir David.—A treatise on the microscope. From the 7th edition of the Encyc. Brit., with additions. Illust. 1837.
- Brewster, Sir David.—A treatise on optics. New ed. London, 1853.
- Brooks, C. P.—Cotton. New York, 1898.
- Browning, J.—How to work with the micro-spectroscope. London, 1894.
- Burnett, Samuel Howard.—The clinical pathology of the blood of domesticated animals. Pp. 156. Illust. Ithaca, 1908.
- Cabot, R. C.—A guide to the clinical examination of the blood for diagnostic purposes. 5th ed. Illust. New York, 1904.
- Cajal, S. Ramon y.—Manuel de Histologia normal y de Tecnica micrografica. 4th ed. Pp. 643. Madrid, 1905.
- Carnoy, J. B. Le Chanoine.—La Biologie Cellulaire; Etude comparée de la cellule dans les deux regnes. Illust. (incomplete). Paris, 1884. Structure and methods.
- Carpenter, W. B.—The microscope and its revelations. 6th ed. Pp. 882, Illust. London and Philadelphia, 1881. Methods and structure.
- Carpenter-Dallinger.—The microscope and its revelations, by the late William B. Carpenter. 8th edition, in which the 1st seven and the 23d chapters have been entirely re-written, and the text throughout reconstructed, enlarged and revised by the Rev. W. H. Dallinger. 22 plates and nearly 900 wood engravings. Pp. 1181. London and Philadelphia, 1901.
- Chamberlain, C. J.—Methods in plant histology. 2d ed. Pp. 262, Illust. Chicago, 1905.
- Chevalier, Charles.—Des Microscopes et de leur usage. Illust. Paris, 1839.
- Clark, C. H.—Practical methods in microscopy. 2d ed. Illust. Boston, 1896.
- Cohn, A. O.—Tests and Reagents, chemical and microscopical. New York, 1903.
- Cole, Aaron, H.—Manual of biological projection and anesthesia of animals. Pp. 200, Illust. Chicago, 1907.
- Comstock, Anna Botsford.—Ways of the Six-Footed. Pp. 152 Boston, 1903. This is one of the most beautiful of the many beautiful books on Insects. Its illustrations are works of

art and its descriptions are not only entertaining in the highest degree, but make the reader *think* concerning the great problems of life.

Comstock, John Henry.- *Insect Life*, an introduction to Nature Study, and a guide for teachers, students, and others interested in out-of-door life. Engravings by Anna Botsford Comstock. Pp. 349. New York, 1902.

Comstock, John Henry and Anna Botsford.—*How to know the Butterflies*. A manual of the butterflies of the eastern United States. Pp. 311. Many colored illustrations. New York, 1904.

Comstock, John Henry and Anna Botsford.—*A Manual for the Study of Insects*. Pp. 701. 7th ed. Ithaca, 1907.

Comstock, John Henry, and Kellogg, V. L.—*The elements of insect anatomy, an outline for the use of students in entomological laboratories*. It gives methods of insect histology. 5th ed. Pp. 145. Ithaca, 1904.

Cooke, M. C.—*One thousand objects for the microscope*. Pp. 189. 500 figures and a brief description of pretty objects for the microscope. London, 1900.

Cotton, A. et Mouton, H.—*Les Ultramicroscopes et les objets ultramicroscopiques*. Pp. 232. Paris, 1906.

Crookshank, E. M.—*Photography of bacteria*. London and New York, 1887.

Cross, C. F., and Bevan, E. J.—*A text-book of Paper Making*. London, 1904.

Cross & Cole.—*Modern microscopy; a hand-book for beginners and students*. I. The microscope and instructions for its use. II. Microscopic objects: how prepared and mounted. 3d ed. revised and enlarged to which is added III. Microtomes: their choice and use. Illust. Chicago, 1903.

Czapski, S.—*Grundzüge der Theorie der optischen Instrumente nach Abbe*. 2 Aufl., unter Mitwirkung des Verfassers und mit Beiträgen von M. v. Rohr. Pp. 490. Illust. Leipzig, 1904.

DaCosta, John C., Jr.—*Clinical Hematology*. A practical guide to the examination of the blood by clinical methods, with reference to the diagnosis of disease. 2d ed. Pp. 591. Illust. Philadelphia, 1905.

Dahlgren, U. and Kepner, W. A.—*A text-book of the principles of animal histology*. Pp. 508. Illust. New York, 1907.

Dana, J. D.—*A system of mineralogy*. 6th ed. Illust. New York, 1892.

Daniell, A.—*A text-book of the principles of physics*. 3d ed. Illust. London, 1895.

Daniell, A.—*Physics for students of medicine*. Illust. London and New York, 1896.

Davies, T.—*Preparation and mounting of microscopic objects*. Edited by J. Matthews. New ed. Pp. 224. London, 1905.

Davis, G. H.—*Practical microscopy*. 3d ed. Pp. 436. Illust. London, 1895.

Dippel, L.—*Das Mikroskop und seine Anwendung*. Illust. Braunschweig, 1898.

Dodge, Charles Wright.—*Introduction to elementary practical biology; a laboratory guide for high school and college students*. New York, 1894.

Drude, Paul.—*Lehrbuch der Optik*. 2d Auflage. Pp. 538. Illust. Leipzig, 1906.

Dunham, Edward K.—*Normal Histology*. 3d ed. Pp. 334. Illust. Philadelphia, 1907.

Eberth, C. J.—*Friedlander's mikroskopische Technik zum gebrauch bei medicinischen und pathologische-anatomischen Untersuchungen*. Pp. 359. Illust. Berlin, 1900.

Ebner, V. V.—*Untersuchungen über die Ursachen der Anisotropie organischer Substanzen*. Leipzig, 1882. Large number of references.

Edser, Edwin.—*Light for Students*. Pp. 579. Illust. London and New York, 1904.

Ehrlich.—*Encyclopädie der Mikroskopischen Technik*. Herausgegeben von: Ehrlich, Krause, Moose, Rosin und Weigert. Pp. 1400. Berlin and Vienna, 1903.

Ellenberger, W., und Günther, G.—*Grundriss der vergleichenden Histologie der Haus-säugethiere*. 3d ed. Pp. 485. Berlin, 1901.

Ewing, James.—*Clinical Pathology of the Blood*. 2d ed. Pp. 495. Illust. Philadelphia, 1903.

Ferguson, J. S.—*Normal Histology and Microscopical Anatomy*. Pp. 738. Illust. New York, 1905.

- Fish Pierre A.—*Examination of the Urine of the Horse and Man*. Pp. 69. Ithaca, 1906.
- Fol, H.—*Lehrbuch der vergleichenden mikroskopischen Anatomie, mit Einschluss der vergleichenden Histologie und Histogenie*. Illust. (incomplete). Leipzig, 1884. Methods and structure.
- Foster, Frank P.—*An illustrated encyclopædic medical dictionary, being a dictionary of the technical terms used by writers on medicine and the collateral sciences in the Latin, English, French and German languages*. Illust., four quarto volumes. 1888-1893.
- Fraenkel und Pfeiffer.—*Atlas der Bacterien-Kunde*. Berlin, 1889-.
- Francotte, P.—*Manuel de technique microscopique*. Pp. 433, 110 Fig. Brussels, 1886.
- Francotte, P.—*Microphotographie appliquée à l'histologie, l'anatomie comparée et l'embryologie*. Brussels, 1886.
- Frazer, P.—*Bibliotecs or the study of documents*. Philadelphia, 1901.
- Frey, H.—*The microscope and microscopical technology*. Translated and edited by G. R. Cutter. 2d ed. Pp. 672., Illust. New York, 1880. Methods and structure. 8th, German edition, 1907.
- Gage, Simon Henry.—*A guide to Course 1 in Microscopy, Histology and Embryology in Cornell University, including the requirements for the course; an outline of the laboratory work and the laboratory reports, questions for recitations, a numbered list of the objects and sections to be studied; also a statement of the methods and facilities for conducting the course and a list of the other courses offered by the department*. Pp. 106. Illust. Ithaca, 1905-1906.
- Gage, Simon Henry.—*Part I: Origin and Development of the Projection Microscope. Part II: Modern Projection with the Microscope, the Magic Lantern and the Episcope. Installation and use of the necessary apparatus*. Fully illustrated. Ithaca, 1909.
- Galt, H.—*The microscopy of the starches illustrated by photomicrographs*. London, 1900.
- Gamgee, A.—*A text-book of the physiological chemistry of the animal body*. Part I, pp. 487, 63 Figs. London and New York, 1880. Part II, 1893.
- Garten, S.—*Leitfaden der Mikroskopie*, 2 Aufl. Pp. 262. Illust. Leipzig, 1904.
- Gaylord and Aschoff.—*The Principles of Pathological Histology*, Philadelphia, 1901. The illustrations are mostly photo-micrographs. Part I gives a resumé of microscopical technique. Part III is on the principles of optics and photomicrography.
- Gebhardt, W.—*Die mikrophotographische Aufnahme gefärbter Präparate*. Illust. München, 1899.
- Giltay, Dr. E.—*Sieben Objecte unter dem Mikroskop. Einführung in die Grundlehren Mikroskopie*. Leiden, 1893. This is also published in the Holland (Dutch) and French language.
- Gleichen, Alexander.—*Leitfaden der praktischen Optik*. Pp. 221. Illust. Leipzig, 1906.
- Goodale, G. L.—*Physiological botany*. Pp. 499+36. Illust. New York, 1885. Structure and methods.
- Goring, C. R., and Andrew Pritchard.—*Micrographia*. Illust. London, 1837.
- Gould, George M.—*Illustrated Dictionary of Medicine and Biology*. 5th ed. Pp. 1633. 1900. Supplement, pp. 571. Philadelphia, 1904.
- Greenish, H. G.—*Microscopical examinations of food and drugs*. Pp. 24 and 321. Illust. London and Philadelphia, 1903.
- Griffith and Henfrey.—*The Micrographic Dictionary; a guide to the examination and investigation of the structure and nature of microscopic objects*. 4th edition by Griffith, assisted by Berkeley and Jones. London, 1883.
- Guyer, M. F.—*Animal Micrology: practical exercises in microscopical methods*. Pp. 240. Chicago, 1906.
- Hager, H., Appel, Brandes und Lochte.—*Das mikroskop und Seine Anwendung*. 10th ed., revised and enlarged. Pp. 444. Illust. Berlin, 1908.
- Hall, W. J. and Herxheimer G.—*Methods of Morbid histology and clinical pathology*. Pp. 290. Edinburgh and London, 1905.
- Halliburton, W. D.—*A text-book of chemical physiology and pathology*. Pp. 874. 104 Illust. London and New York, 1891.

- Hanausek, T. F.—Lehrbuch der mikroskopischen Technik. Illust. Stuttgart, 1900.
- Hanausek, T. F.—Lehrbuch der technichén Mikroskopie. Stuttgart, 1901.
- Hanausek, T. F., A. L. Winton, Kate G. Barber.—The Microscopy of Technical Products. Pp. 471. Illust. New York and London, 1907.
- Hannan, W. I.—The textile fibers of commerce. London, 1902.
- Hardesty, Irving—Neurological Technique. Pp. 183. Chicago and London, 1902. Laboratory directions for the dissection of the central nervous system and *BNA* neurological nomenclature.
- Hardesty, Irving.—A Laboratory Guide for Histology, with a chapter on laboratory drawing, by A. W. Lee. Illust. Philadelphia, 1908.
- Harker, A.—Petrology for students; an introduction to the study of rocks under the microscope. 2d ed. Cambridge, 1897.
- Harting, P.—Theorie und allgemeine Beschreibung des Mikroskopes. 2d ed. 3 vols. Illust. Braunschweig, 1866.
- Hassack, C.—Wodurch unterscheiden sich die Textilfasern. Leipzig, 1899.
- Hastings, Charles Sheldon.—Light, a consideration of the more familiar phenomena of optics. Pp. 224. Illust. New York, 1901.
- Heisler, J. C.—A text-book of Embryology, for students of medicine. 3d revised ed. Pp. 432. Illust. Philadelphia, 1907.
- Hertwig, O., and Mark, Edward L.—Text-book of the embryology of Man and Mammals. From the 3d German edition. Pp. 670. Illust. London and New York, 1901.
- Herzberg, W.—Papierprüfung. Berlin, 1902.
- Herzfeld, T. J.—The technical testing of yarns and textile fabrics with reference to official specifications. Translated by C. Salter. Illust. London, 1898.
- Hill, Charles.—A manual of Normal Histology and Organography. Pp. 463. Illust. Philadelphia, 1906.
- Hioras, Arthur H.—Metallography, an introduction to the study of the structure of metals, chiefly by the aid of the microscope. Pp. 158. Illust. London, 1902.
- Hinrichs, C. G.—Microchemical Analysis. St. Louis, 1904.
- Höber, R.—Physikalische Chemie der Zelle und der Gewebe. 2d ed. Pp. 460. Leipzig, 1906.
- Hogg, J.—The microscope, its history, construction and application. 15th ed. Pp. 704. Illust. London and New York, 1898. Much attention paid to the polariscope.
- von Höhnel, F. R.—Die Mikroskopie der technisch-verwandten Fasserstoffe. Vienna, 1887.
- Hovestadt, Dr. H.—Translated by J. D. and Alice Everett. Jena Glass. Pp. xiv, and 419. Illust. London and New York, 1903.
- Huber, G. C.—Laboratory work in histology. 3d revised and enlarged ed. Pp. 204. Illust. Ann Arbor, 1900.
- Hyatt-Woolf, C.—Optical Dictionary. Pp. 77. London, 1905.
- James, F. L.—Elementary microscopical technology. Part I, the technical history of a slide from the crude material to the finished mount. Pp. 107. Illust. St. Louis, 1887.
- Jeserich, P.—Die mikrophotographie auf Bromsilbergelatine bei natürlichem und Künstlichem Lichte. Pp. 245. Figs. and Plates. Berlin, 1888.
- Johnston, J. B.—The Nervous System of Vertebrates. Pp. 370. Illust. Philadelphia, 1906.
- Jüptner, Hanns Freiherr von.—Grundzüge der Siderologie, Erster Teil, Leipzig, 1900. Full discussion of theory of solution, chemical constitution, micrography, etc., of iron alloys and slags. Illust. Bibliography very complete. Part II not yet issued. "Will deal with relation between chemical constitution, mechanical treatment, microscopic structure," etc.
- Jüptner v. Jonstorff, H.—Grundzüge der Siderologie. I. Die Konstitution der Eisenlegiern. u. Schlacken. II. Zusammenhang zwischen therm. u. mechan. Bearbeitg., Konstitution u. Eigenschaften der Eisenlegiern. III. 1. Die Wechselwirkgn. zwischen Eisen u. verschiedenen Agentien. III. 2. Die hüttenmann Prozesse. Berlin, 1900-1904.
- Kahlden, C. von.—Technik der histologischen Untersuchung pathologisch-anatomischer Präparate. 7th revised and enlarged ed. Pp. 209. Jena, 1904.

- Kaiser, W.—Die Technik des modernen Mikroskopes. 2d ed. Illust. Wien, 1906.
- Kaiserling, C.—Lehrbuch der Mikrophotographie nebst Bemerkungen über Vergrößerungen und Projection. Pp. 179. Illust. Berlin, 1903.
- Kayser, Heinrich.—Handbuch der Spectroscopie. 3d Band. Natürliche Farbstoffe, etc. Pp. 604. Illust. Leipzig, 1905.
- King, J.—The microscopist's companion. A popular manual of practical microscopy. Pp. 308. Illust. Cincinnati, 1859.
- Kingsbury, Benjamin Freeman, and Gage, S. H.—A Guide for Vertebrate Histology. Pp. 137. Ithaca, 1899-1900.
- Klément et Renard.—Réactions microchimiques à cristaux et leur application en analyse qualitative. Pp. 126. 8 Plates. Bruxelles, 1886.
- Klopstock, M und Kowarsky, A.—Practicum der klinischen, chemisch-mikroskopischen und bacteriologischen Untersuchungsmethoden. Pp. 296. Wien, 1904.
- König, J.—Die Menschlichen Nahrungs- und Genussmittel. Berlin, 1904.
- Koristka, Ditta F.—Di Microscopi ed accessori. Milano, 1902.
- Kraus, G.—Zur Kenntniss der Chlorophyllfarbstoffe. Stuttgart, 1872.
- Landauer, John.—Eng. ed. by J. Bishop Tingle—Spectrum Analysis. 2d ed. Pp. 236. Illust. New York and London, 1907.
- Langley, J. N.—Practical Histology. Pp. 340. Illust. London and New York, 1901.
- Lankaster, E.—Half-hours with the microscope: a popular guide to the use of the microscope as a means of amusement and instruction. New ed. Pp. 142. London, 1905.
- Latteux, P.—Manuel de technique microscopique. 3d ed. Paris, 1891.
- Leach, Albert E.—Food Inspection and Analysis. Pp. 787. Illust. New York, 1904.
- Lecomte, H.—Les textiles végétaux, leur examen microchimique. Paris, 1892.
- LeConte, Joseph.—Sight—an exposition of the principles of monocular and binocular vision. Pp. 275. Illust. New York, 1881.
- Lee, A. B.—The microtometist's vade-mecum. A handbook of the methods of microscopic anatomy. 6th ed. Pp. 538. London and Philadelphia, 1905.
- Lehmann, C. G.—Physiological chemistry. 2 vols. Pp. 648+547. Illust. Philadelphia, 1855.
- Lehmann, O.—Molekularphysik mit besonderer Berücksichtigung mikroskopischer Untersuchungen und Anleitung u. solchen, sowie einem Anhang über mikroskopische Analyse. 2 vols. Illust. Leipzig, 1888-1889.
- Lehmann, O.—Die Krystallanalyse. Leipzig, 1891.
- Leiss, C.—Die optischen Instrumente der Firma R. Fuess, deren Beschreibung. Justierung und Anwendung. Pp. 397. Illust. Leipzig, 1899.
- Lindner, P.—Atlas der mikroskopischen Grundlagen der Gärungskunde. Illust. Berlin, 1903.
- Lindner, P.—Mikroskopische Betriebskontrolle in den Gärungsgewerben. 4th ed. Berlin, 1905.
- Lockyer, J. N.—The spectroscope and its application. Pp. 117. Illust. London and New York, 1873.
- Lo Forte, Giac.—Il microscopio: manuale pratico per i primi esercizi di microscopia. Pp. 62. Illust. Milano, 1904.
- Luquer, L. M.—Minerals in rock sections. New York, 1898.
- Macé, E.—Les substances alimentaire étudiées au microscope surtout au point de vue de leurs altérations et de leur falsifications. Illust. Paris, 1891.
- Macdonald, J. D.—A guide to the microscopical examination of drinking water. Illust. London, 1875. Methods and descriptions.
- McKendrick, J. G.—A text-book of physiology. Vol. I, general physiology. Pp. 516. Illust. New York, 1888.
- MacMunn, C. A.—The spectroscope in medicine. Pp. 325. Illust. London, 1885.
- McMurrich, J. P.—The development of the Human Body. A manual of human embryology. 3d ed. Pp. 528. Illust. Philadelphia, 1907.
- Mallory, F. B., and Wright, J. H.—Pathological Technique. A practical manual for work-

- ers in pathological histology and bacteriology including directions for the performance of autopsies and for clinical diagnosis by laboratory methods. 3d revised ed. Pp. 469. Illust. Philadelphia, 1904.
- Mann, Gustav.—Physiological Histology. Methods and Theory. Pp. 488. Oxford, 1902.
- Manton, W. P.—Syllabus of Lectures on Human Embryology, and introduction to the study of obstetrics and gynaecology. For medical students and practitioners with a glossary of embryological terms. 3d revised and enlarged ed. Pp. 136. Illust. Philadelphia, 1906.
- Marktanner-Turneretscher, G.—Die Mikro-Photographie als Hilfsmittel naturwissenschaftlicher Forschung. Pp. 344. Illust. Halle, a, S., 1890.
- Martin, John H.—A manual of microscopic mounting with notes on the collection and examination of objects. 2d ed. Illust. London, 1878.
- Mason, John J.—Minute structure of the central nervous system of certain reptiles and batrachians of America. Illustrated by permanent photo-micrographs. Newport, 1879-1882.
- Matthews, C. G., and Lott, F. E.—The microscope in the brewery and the malt house. Illust. 2d ed. London, 1899.
- Matthews, J. M.—The textile fibers. 2d ed. Pp. 488. Illust. New York, 1907.
- Mayall, John, Jr.—Cantor lectures on the microscope, delivered before the society for the encouragement of arts, manufacturers and commerce. Nov.-Dec., 1885. History of the microscope, and figures of many of the forms used at various times.
- Mell, P. H.—Biological Laboratory Methods. Pp. 321. Illust. New York and London, 1902.
- Meyer, A.—Die Grundlagen und die Methoden für die mikroskopische Untersuchung von Pflanzenpulvern. Pp. 258. Illust. Jena, 1901.
- Minot, Charles S.—Human Embryology. Pp. 815. 463 Illust. New York, 1892.
- Minot, Charles S.—A laboratory text-book of Embryology. Pp. 280. Illust. Philadelphia, 1903. Full and satisfactory methods for Embryological work.
- Mitlacher, W.—Toxikologisch oder forensisch wichtige Pflanzen und vegetabilische Drogen mit besonderer Berücksichtigung ihrer mikroskopischen Verhältnisse. Pp. 200. Illust. Wien, 1904.
- Moeller, J.—Leitfaden zu mikroskopisch-pharmakognostischen Uebungen. Pp. 336. Illust. Wien, 1901.
- Moeller, J.—Mikroskopie der Nahrungs- und Genussmittel aus dem Pflanzenreich. Pp. 599. Illust. 2d ed. unter Mitwirkung A. L. Winton. Berlin, 1905.
- Moitessier, A.—La photographie appliquée aux recherches micrographiques. Paris, 1866.
- Molisch, H.—Grundriss einer Histochemie der Pflanzlichen Genussmittel. Jena, 1891.
- Moore, V. A.—Laboratory Directions for beginners in Bacteriology. 3d ed. Illust. Boston, 1905.
- Moore, Veranus Alva.—The Pathology and Differential Diagnosis of Infectious Diseases of Animals. 3d ed. Pp. 578. Illust. Ithaca, 1908.
- Morel et Soulié.—Manuel de technique microscopique. Paris, 1899.
- Nägeli und Schwendener.—Das Mikroskop, Theorie und Anwendung desselben. 2d ed. Pp. 647. Illust. Leipzig, 1877.
- Nelson, Edward M.—A bibliography of works (dated not later than 1700) dealing with the microscope and other optical subjects. Journal of the Royal Microscopical Society for the year 1902. Pp. 20-23.
- Neuhauss, R.—Lehrbuch der Mikro-photographie. Pp. 273. Illust. 3d ed. revised. Braunschweig, 1907.
- Nichols, E. L.—The outlines of physics. Illust. New York, 1897.
- Nichols, E. L. and Franklin W. S.—The Elements of Physics; Light and Sound. New ed. Illust. New York and London, 1903.
- Nichols, J. B. and Vale, F. P.—Histology and Pathology. Pp. 458. Illust. Philadelphia and New York, 1889.
- Oertel, T. E.—Medical Microscopy. Pp. 345. Illust. Philadelphia, 1902.
- Pappenheim, A.—Grundriss der Farbenchemie zum Gebrauch bei mikroskopischen Arbeiten. Pp. 476. Berlin, 1901.

- Petri, R. J.—Das Mikroskop von seinen Anfängen bis zur jetzigen Vervollkommung für alle Freunde dieses Instruments. Pp. 248. Illust. Berlin, 1896.
- Peter, K.—Die Methoden der Rekonstruktion. Pp. 140. Jena, 1906. Discusses models. See also Born in Böhm und Opperl.
- Phin, J.—Practical hints on the selection and use of the microscope for beginners. 6th ed. Illust. New York, 1891.
- Piersol, G. A.—Text-book of Normal Histology including an account of the development of the tissues and of the organs. Also technique. Pp. 439. Illust. Philadelphia, 1893-1899. Revised edition in preparation (1908).
- Poggendorff, J. C.—Gesichte der Physik. Pp. 937. Illust. Leipzig, 1879.
- Pollack, B.—Die Färbentechnik für das Nervensystem. 3d ed. Pp. 158. Berlin, 1905.
- Posselt, E. A.—The structure of fibres, yarns and fabrics. Illust. Philadelphia and London, 1891.
- Pozzi-Escot.—Analyse microchimique. Paris, 1899.
- Prenant, A., Bouin, P. et Maillard, L.—Traité d'Histologie. Pp. 977; 791 Figs. Paris, 1904.
- Preyer, W.—Die Blutkrystalle. Jena, 1871. Full bibliography to that date.
- Pringle, A.—Practical photo-micrography. Pp. 193. Illust. New York, 1890.
- Proctor, R. A.—The spectroscope and its work. London, 1882.
- Quekett, J.—A practical treatise on the use of the microscope, including the different methods of preparing and examining animal, vegetable and mineral structures. 2d ed. Pp. 515. 12 plates. London, 1852.
- Radasch, H. E.—Compend of Histology specially adapted for the use of medical students and physicians. Pp. 304. Illust. Philadelphia, 1905.
- Rafter, G. W.—The Microscopical Examination of Potable Water. Pp. 160. New York, 1892.
- Ranvier, L.—Traité technique d'histologie. Pp. 1109. Illust. Paris, 1875-1888. Structure and methods. Also German translation, 1888.
- Rawitz, B.—Lehrbuch der mikroskopischen Technik. Pp. 438. Illust. Leipzig, 1907.
- Reeves, J. E.—A hand-book of medical microscopy, including chapters on bacteriology neoplasms and urinary examination. Illust. Philadelphia, 1894.
- Reference hand-book of the medical sciences. Albert H. Buck, editor. 8 quarto vols. Illustrated with many plates and figures in the text. New York, 1885-1889, Supplement, 1893. References are to this edition.
- Reference hand-book of the Medical Sciences. 8 vols. 4°. New edition completely revised and rewritten. New York, 1901-1904. Appendix, 1908.
- Reinsch, R.—Petrographisches Practicum. Pp. 180. Illust. Berlin, 1904.
- Renaut, J. et Regaud, C.—Revue générale d'histologie Comprenant l'exposé successif des principales questions d'anatomie générale, de structure, de cytologie, d'histogénie, d'histophysiologie et de technique histologique. Avec la collaboration de savants français et étrangers. Pp. 800. Illust. Paris, 1906.
- Richardson, J. G.—A hand-book of medical microscopy. Pp. 333. Illust. Philadelphia, 1871. Methods and descriptions.
- Robin, Ch.—Traité du microscope et des injections. 2d ed. Pp. 1101. Illust. Paris, 1877. Methods and structure.
- Röthig, P.—Handbuch der embryologischen Technik. Wiesbaden, 1904.
- Rohr, M. v.—Die Theorie der optischen Instrumente. Bd. I: Die Bilderzeugung in optischen Instrumenten vom Standpunkt der geometrischen Optik. Bearbeitet von den wissenschaftlichen Mitarbeitern an der optischen Werkstätte von Carl Zeiss: P. Culmann, S. Czapski, A. König, F. Löwe M. v. Rohr, H. Siedentopf, E. Wanderleb. Pp. 587. Illust. Berlin, 1904.
- Roscoe, Sir Henry.—Lectures on spectrum analysis. 4th ed. London, 1885.
- Rosenbusch, H. und Wülfing, E. A.—Mikroskopische Physiographie der petrographisch wichtigen Mineralien. 4th ed. Illust., cuts and photo-micrographs. 3 vols. Pp. 1585. Stuttgart, 1907.
- Rosenbusch, K. H. F. translated by Iddings, P.—Microscopical physiography of the rock-making minerals. Illust. 3d ed. New York, 1908.

- Ross, Andrew.—The microscope. Being the article contributed to the "Penny Cyclo-pædia." Republished in New York in 1877. Illust.
- Rubenthaler, G.—Technique histologique et cytologique. Pp. 306. Paris, 1908.
- Rusby, H. H., and Jelliffe, S. E.—Morphology and Histology of Plants designed especially as a guide to plant analysis and classification, and an introduction to pharmacognosy and vegetable physiol. Pp. 378. Illust. New York, 1899.
- Rutherford, W.—Outlines of practical histology. 2d ed. Pp. 194. Illust. London and Philadelphia, 1876. Methods and structure.
- Sayre, L. E., and Stevens, Wm. C.—Organic Materia Medica and Pharmacognosy. An introduction to the study of the vegetable kingdom and the vegetable and animal drugs; insects injurious to drugs, etc. Histology and Microtechnic by Stevens. 3d ed. Pp. 675. Illust. Philadelphia, 1905.
- Scales, F. S.—Elementary microscopy. Handbook for beginners. Pp. 192. Illust. London, 1905.
- Schaefer, E. A.—A course of practical histology, being an introduction to the use of the microscope. 2d ed. Pp. 304, 40 Figs. Philadelphia, 1897. Methods.
- Schaefer, E. A.—The essentials of Histology, descriptive and practical, for the use of students. 7th edition, revised and enlarged. Pp. 520. Illust. London, 1907.
- Schellen, H.—Spectrum analysis, translated by Jane and Caroline Lassell. Edited with notes by W. Huggins. 13 plates, including Angström's and Kirchhoff's maps. London, 1885.
- Schimper, A. F. W.—Anleitung zur mikroskopischen Untersuchungen der vegetabilischen Genussmittel. 2d ed. Pp. 158. Illust. Jena, 1900.
- Schmorl, G.—Die pathologisch-histologischen Untersuchungsmethoden. 4th ed. Leipzig, 1907.
- Schneider, A.—Microscopy and micro-technique. Pp. 189. Illust. Chicago, 1899.
- Schuster, A.—Introduction to the Theory of Optics. Pp. 356. London, 1904.
- Sedgwick and Wilson.—General biology. 2d ed. Illust. New York, 1895.
- Seiler, C.—Compendium of microscopical technology. A guide to physicians and students in the preparation of histological and pathological specimens. Pp. 130. Illust. New York, 1881.
- Senft, E.—Mikroskopische Untersuchung des Wassers mit bezug auf die in Abwässern und Schmutzwässern vorkommenden Mikroorganismen und Verunreinungen. Pp. 196. Illust. Wien, 1905.
- Silliman, Benj., Jr.—Principles of physics, or natural philosophy. 2d ed., rewritten. Pp. 710; 722 Illust. New York and Chicago, 1860.
- Spencer Lens Company.—How to use and care for the Microscope. A simple treatise on the use of the Microscope, especially adapted to laboratory work. Pp. 29. Buffalo, 1905. This booklet is sent with every microscope, and gives in the briefest and simplest manner the fundamental things to be observed in using a microscope.
- Spitta, E. J.—Photomicrography. 4°. Pp. 163. Illustrated by half-tone reproductions from original negatives. Text illustrations. London, 1899.
- Spitta, Edmund J.—Microscopy, the construction, theory and use of the Microscope. Pp. 468. Illust. London, 1907.
- Starr, Allen M., with the cooperation of Oliver S. Strong and Edward Leaming.—An atlas of nerve-cells. Columbia University Press, New York, 1896. The atlas consists of text, diagrams, and some of the best photo-micrographs that have ever been published.
- Sternberg, G. M.—Photo-micrographs and how to make them. Pp. 204, 20 Plates. Boston, 1853.
- Stevens, Wm. C.—Plant Anatomy from the standpoint of the development and functions of the tissues, and hand-book of micro-technic. Pp. 349. Illust. Philadelphia, 1907.
- Stöhr, Philipp, and Lewis, Frederic T.—Text-book of Histology arranged upon an Embryological Basis. 6th Amer. ed. Pp. 434. Illust. Philadelphia, 1906.
- Stokes, A.—Aquatic microscopy for beginners, or common objects from the ponds and ditches. Illust. Portland, Conn., 1896.
- Stokes, Alfred C.—Microscopical Praxis or simple methods of ascertaining the properties of various microscopical accessories. Pp. 244. Illust. Portland, 1894.

- Suffolk, W. T.—On microscopical manipulation. 2d ed. Pp. 227. Illust. London, 1870.
- Sutherland, W. D.—Blood-stains, Skin Detection and the determination of their source. Pp. 178. Illust. New York.
- Szymonowicz, L. translated by MacCallum, J. B.—A text-book of Histology and Microscopic Anatomy of the human body, including microscopic technique. Pp. 435. Illust. Philadelphia and New York, 1902.
- Thomas, Mason B., and Wm. R. Dudley—A laboratory manual of plant histology. 2d ed. Crawfordsville, Ind., 1894.
- Trelease, Wm.—Poulsen's botanical micro-chemistry; an introduction to the study of vegetable histology. Pp. 118. Boston, 1884. Methods.
- Trutat, M.—La photographie appliquée à l'histoire naturelle. Pp. 225. Illust. Paris, 1884.
- Valentin, G.—Die Untersuchung der Pflanzen und der Thiergewebe in polarisirtem Licht. Leipzig, 1861.
- Van Heurck, H.—The microscope. Illust. London and New York, 1893.
- Vierordt. Die quantitative Spectralanalyse in ihrer Anwendung auf Physiologie, 1876.
- Vignon, L.—La Soie. Paris, 1900.
- Villiers, A., et Collin, E.—Traité des alterations et falsifications des substances alimentaires. Paris, 1900.
- Vogl, A. E.—Die wichtigsten vegetabilischen Nahrungs und Genussmittel. Pp. 575. Illust. Wien und Leipzig, 1899.
- Vogel, Conrad.—Practical pocket-book of photography. Pp. 202. Figs. London, 1893.
- Vogel, H. W.—Practische Spectralanalyse irdischer Stoffe; Anleitung zur Benutzung der Spectralapparate in der qualitativen und quantitativen chemische Analyse organischer und anorganischer Körper. 2d ed. Figs. Berlin, 1889.
- Wall, O. A.—Notes on Pharmacognosy. 2d ed. Pp. 703. Illust. St. Louis, 1902.
- Walmisley, W. H.—The A, B, C of Photo-Micrography. A practical hand-book for beginners. Plates and text figures. New York, 1902.
- Weinschenk, E.—Anleitung zum Gebrauch des Polarisationsmikroskopes. Pp. 147. Illust. Freiburg, 1906.
- Wethered, M.—Medical microscopy. Pp. 406, Figs. London and Philadelphia, 1892.
- Whipple, G. C.—The Microscopy of Drinking Water. 2d ed. Pp. xii+303. Illust. New York, 1905.
- White, T. C.—The Microscope and how to use it. A hand-book for beginners, with chapters on marine aquaria and the staining of bacteria. Illust. London, 1907.
- Whitman, C. O.—Methods of research in microscopical anatomy and embryology. Pp. 55. Illust. Boston, 1885.
- Whittaker, E. T.—The theory of optical instruments. Pp. 72. Cambridge, 1907.
- Wilder and Gage—Anatomical technology as applied to the domestic cat. An introduction to human, veterinary and comparative anatomy. Pp. 575, 130 Figs. 2d ed. New York and Chicago, 1886.
- Wiley, Harvey W.—Foods and their Adulterations. The origin, manufacture and composition of food products. Description of common adulterations, food standards and national food laws and regulations. Pp. 625. Illust. Philadelphia, 1907.
- Wilkinson, F.—The study of the Cotton Plant. New York, 1899.
- Williams, H. U.—Bacteriology. 4th edition revised and enlarged by R. Meade Bolton. Pp. 357. Illust. Philadelphia, 1903.
- Wilson, C. E. A.—Elements of Applied Microscopy. Pp. 168. Illust. New York and London, 1905.
- Wilson, Edmund B., with the cooperation of Edward Leaming.—An atlas of fertilization and karyokinesis. Columbia University Press, New York, 1895. This atlas marks an era in embryological study. It has admirable text and diagrams, but the distinguishing feature is the large number of almost perfect photo-micrographs.
- Winkelmann, A.—Handbuch der Physik, 2 Aufl. Bd. vi, 1 Optik. Pp. 432. Illust. Leipzig, 1904.
- Winslow, Charles-Edward Amory.—Elements of applied Microscopy. A text-book for beginners. Pp. 183. Illust. New York, 1905.

Winton, Andrew L., in Collaboration with Dr. J. Moeller.—The Microscopy of Vegetable Foods. Pp. 701. Illust. New York, 1906.

Wood, J. G.—Common objects for the microscope. Pp. 132. London, no date. Upwards of 400 figures of pretty objects for the microscope, also brief descriptions and directions for preparation.

Wormly, T. G.—The micro-chemistry of poisons. 2d ed. Pp. 742. Illust. Phila., 1885.

Wright, Sir A. E.—Principles of Microscopy, being a hand-book to the Microscope. Pp. 250. Illust. New York, 1907.

Wright, Lewis.—A popular hand-book to the Microscope. Pp. 256. Illust. London, 1885.

Wright, Lewis.—Optical Projection, a treatise on the use of the lantern in exhibition and scientific demonstration. 4th ed. Pp. 450. Illust. London, 1906. (Beginners will find this book very helpful.)

Wythe, J. H.—The microscopist; a manual of microscopy and a compendium of microscopical science. 4th ed. Pp. 434, 252 Figs. Philadelphia, 1880.

Zimmermann, Dr. A.—Das Mikroskop. ein Leitfaden der wissenschaftlichen Mikroskopie. Illust. Leipzig und Weim, 1895.

See also Watt's chemical dictionary, and the various general and technical encyclopedias.

PERIODICALS*

The American Journal of Anatomy, Baltimore, 1901+. The American Journal of Anatomy including Histology, Embryology and Cytology was established by seven universities,—Harvard, Johns Hopkins, Columbia, Pennsylvania, Michigan, Cornell and Chicago.

It is now (1908), published under the auspices of the Wistar Institute of Anatomy and Biology, Philadelphia, and has an editorial board consisting of Charles R. Bardeen, University of Wisconsin; Henry H. Donaldson, the Wistar Institute; Thomas Dwight, Harvard University; Simon H. Gage, Cornell University; G. Carl Huber, Michigan University; George H. Huntington, Columbia University; Franklin P. Mall, Johns Hopkins University; J. Playfair McMurrich, University of Toronto; Charles S. Minot, Harvard University; George A. Piersol, University of Pennsylvania. Henry McE. Knower, Secretary, Johns Hopkins University. There are also over 80 collaborators connected with different institutions.

The American journal of medical research. Boston, 1901+.

The American journal of physiology. Boston, 1896+.

The American journal of microscopy and popular science. Illust. New York, 1876-1881.

The American journal of science. New Haven, 1818+.

The American monthly microscopical journal. Illust. Washington, D. C., 1880--.

American Naturalist. A popular illustrated magazine of natural history. Salem and Philadelphia, Boston and New York, 1867+.

American quarterly microscopical journal, containing the transactions of the New York microscopical society. Illust. New York, 1878+.

American microscopical society, Proceedings. 1878-1894; Transactions, 1895+.

The Anatomical Record. Baltimore, 1906+. The scope includes the results of original investigations, preliminary reports, reviews, critical notes, courses of study, laboratory plans and events, including appointments, technique. It will also contain the Proceedings of the Association of American Anatomists. The first volume of the Anatomical Record

*NOTE—When a periodical is no longer published, the dates of the first and last volumes are given; but if still being published, the date of the first volume is followed by a plus sign.

See Vol. XVI of the index Catalog of the Library of the Surgeon General's office for a full list of periodicals. See also the later volumes for additions.

Besides the above-named periodicals, articles on the microscope or the application of the microscope appear occasionally in nearly all of the scientific journals. One is likely to get references to these articles through the Jour. Roy. Micr. Soc. or the Zeit. wiss. Mikroskopie. Excellent articles on Photo-micrography occur in the special Journals and Annuals of Photography.

was published with the *American Journal of Anatomy* (Nov., 1906 to Feb., 1908) and under the supervision of the same editorial board. It is now independent, with the following editors: Irving Hardesty, University of California; G. Carl Huber, University of Michigan; Clarence M. Jackson, University of Missouri; Horace Jayne, the Wistar Institute; Thomas G. Lee, University of Minnesota; Frederick T. Lewis, Harvard University; Warren H. Lewis, Johns Hopkins University; Florence R. Sabin, Johns Hopkins University; George L. Streeter, University of Michigan. Published by the Wistar Institute of Anatomy and Biology. Philadelphia, 1908+.

Anatomischer Anzeiger. Centrablatt für die gesammte wissenschaftliche Anatomie. Amtliches Organ der anatomischen Gesellschaft. Herausgegeben von Dr. Karl Bardeleben. Jena, 1886+. Besides articles relating to the microscope or histology, a full record of current anatomical literature is given.

Annales de la société belge de microscopie. Bruxelles, 1874+.

Archives d'Anatomie microscopique. Illust. Paris, 1897. (Balbiani et Ranvier.)

Archiv für mikroskopische Anatomie. Illust. Bonn, 1865+.

Bibliographie Anatomique, Paris, 1893+

Centrblatt für Physiologie. Unter Mitwirkung der physiologischen Gesellschaft zu Berlin, Herausgegeben von S. Exner und J. Gad. Leipzig und Wien, 1887+. Brief extracts of papers having a physiological bearing. Full bibliography of current literature.

English mechanic. London, 1866+. Contains many of the papers of Mr. Nelson on lighting, photo-micrography, etc.

Index medicus. New York, 1879+. Bibliography, including histology and microscopy.

International journal of microscopy and popular science. London, 1890+.

Journal of anatomy and physiology. Illust. London and Cambridge, 1867+.

Journal of Applied Microscopy and Laboratory methods. Illust. Rochester, N. Y., 1898+.

Journal de micrographie. Illust. Paris, 1877-1892.

Journal of microscopy and natural science. London, 1885+.

Journal of the New York microscopical society. Illust. New York, 1885+.

Journal of physiology. Illust. London and Cambridge, 1878+.

Journal of the American chemical society. New York, 1879+.

Journal of the Royal Microscopical Society. Illust. London, 1879+. Bibliography of works and papers relating to the microscope, microscopical methods and histology. It also includes a summary of many of the papers.

Journal of the Quekett microscopical club. London, 1868+.

The Journal of Comparative Neurology and Psychology. This Journal was founded in 1891 by Clarence L. Herrick, and was then called the *Journal of Comparative Neurology*. Since 1900 it has had the present name. The editorial board consists of: Henry H. Donaldson, C. Judson Herrick, Herbert S. Jennings, J. B. Johnston, Adolph Meyer, Oliver S. Strong, John B. Watson, Robert M. Yerkes. It is now published by the Wistar Institute of Anatomy and Biology. Philadelphia, 1908.

The Journal of Experimental Zoology. 1904+. Editors: William K. Brooks, William E. Castle, Edwin G. Conklin, Charles B. Davenport, Herbert S. Jennings, Frank R. Lillie, Jacques Loeb, Thomas H. Morgan, George H. Parker, Charles O. Whitman, Edmund B. Wilson. It is published by the Wistar Institute of Anatomy and Biology, 1908.

Journal of Morphology, 1887-1901, 1903, 1908+. The present editors are Edward Phelps Allis, Jr., Edwin G. Conklin, Henry H. Donaldson, Milton J. Greenman, Ross G. Harrison, G. Carl Huber, Horace Jayne, Frank R. Lillie, Frankliu P. Mall, Charles S. Minot, Thomas H. Morgan, George H. Parker, Charles O. Whitman, Edmund B. Wilson. The *Journal of Morphology* is now published by the Wistar Institute of Anatomy and Biology. Philadelphia, 1908.

The Lens, a quarterly journal of microscopy, and the allied natural sciences, with the transactions of the state microscopical society of Illinois. Chicago, 1872-1873.

The Metallograpist, a quarterly publication devoted to the study of metals with special reference to their physics, microstructure, their industrial treatment and application. Illustrated especially by photo-micrographs of metals and alloys. Boston, 1898+.

The Microscope. Illust. Washington, D. C., 1881-1897.

- Microscopical bulletin and science news. Illust. Philadelphia, 1883+. The editor, Edward Pennock introduced the term "par-focal" for oculars (see vol. iii, p. 31).
- Monthly microscopical journal. Illust. London, 1869-1877.
- Nature. Illust. London, 1869+.
- The Observer. Portland, Conn., 1890-1897.
- Philosophical Transactions of the Royal Society of London. Illust. London, 1665-.
- Proceedings of the American microscopical society, 1878-.
- Proceedings of the Royal Society. London, 1854+.
- Quarterly journal of microscopical science. Illust. London, 1853+.
- Rev. de Métallurgie. Paris, 1904-.
- Science, a weekly journal devoted to the advancement of science. New York. N. S. 1895-.
- Science Record. Boston, 1883-4.
- The Scientific American. New York, 1845+.
- Zeitschrift f. Angewandte Mikroskopie. 1898+.
- Zeitschrift für Instrumentenkunde. Berlin, 1881+.
- Zeitschrift für physiologische Chemie. Strassburg, 1877+.
- Zeitschrift für wissenschaftliche Mikroskopie und für mikroskopische Technik. Illust. Braunschweig. 1884+. Methods, bibliography and original papers.

INDEX

A

Abbe apertometer	187
Abbe camera lucida	142-152, 329
Abbe condenser or illuminator	54-58
Abbe test-plate	185-187
Achromatic; chromatic	4, 5, 185
Cover-glass	64
Spherical	4, 5, 185
Absorption spectra	158-160, 167-172
Ethylene light	42, 60, 226
Chromatic, condenser	49, 50, 229
Objectives	12, 15, 75
Oculars	26
Achromatism	15
Aplanatic focus	223
Adjustable objectives	14, 16, 64-68
Experiments with	64
Micrometry	138
Photo-micrography	235
Adjusting collar	65
Adjustment, of analyzer	173
Coarse or rapid, and fine	74
Frontispiece; of objective	14, 16, 65
Objective for cover-glass	65
Aerial image	35, 37
Air bubbles	103-106
Amblyopium fixative, Mayer's	271
Amblyopia, absolute	271
Ethyl	271
Denatured	271
Methyl	271
Picric	281, 285
Amblyopia, dye	311
Amblyopia, prism	155
Amblyopia, amplifier	123
Amblyopia, of microscope	116
Amblyopia, analyzer	163, 173
Amblyopia, of aperture	19, 20
Critical	64
Amblyopia, of Strom and Stokes' law	160
Amblyopia, of regular aperture	19, 20
Amblyopia, isotropic	175
Amblyopia, of Abbe's	187
Amblyopia, of objective	19, 23, 187
Illuminating cone	52
Numerical of condenser	52
Amblyopia, of planatic cone	54
Objectives	15
Ocular	15
Amblyopia, of chromatic condenser	50
Objectives	15, 76, 221

Apparatus and material	-----
1, 39, 99, 116, 141, 155, 185, 203, 220	-----
Appearances, interpretation	99-115
Arrangement, minute objects	261
Serial sections	318
Tissue for sections	317
Artifacts	100
Artificial illumination	-----
-----	42, 56, 60, 223, 228, 233
Axial light	41
Experiments with	48
Abbe illuminator	56
Axial, point	19
Ray	41
Axis, optic	2, 3, 12
Crystals	175
Illuminator	57
Secondary	3, 6, 57

B

Back-ground for photographing	-----
-----	207, 213
Back combination or system of objective	12-14
Bacterial cultures, photographing	243
Balsam	272
Acid	272, 281, 315
Bottle	257
Mounting in	257, 311
Removal from lenses	71
Natural	272
Neutral	272
Removal from slides	246
Xylene	272
Bands, absorption	158
Base of microscope, Frontispiece,	-----
Bath, water	153,
Bibliography, 1, 38, 114, 139-140, 154,	-----
172, 184, 192, 202, 243, 261, 264,	-----
283, 323, 326, 332, 333-345.	-----
Binocular	112-114
Black, anilin for tables	282
Blocks, for shell vials	259
Blood, absorption spectrum of	168
Blotting paper for models	326
Board, reagent	259, 268
Body of microscope, Frontispiece.	-----
Borax, carmin	273
Bottle for balsam, glycerin or shellac	257
Reagent	271

- Box, glass 249
 Brownian movement 109, 115
 Bubble, air 103-106
 Bull's-eye 60, 224
 Engraving glass 225
 Burning point 7, 35
- C**
- Cabinet for microscopic preparations 264-265
 Calipers, micrometer or pocket 249
 Camera, bed 205
 Drawing 154
 Embryos 209
 Large, transparent sections 212
 Photo-micrographic 219, 222
 Testing 220
 Vertical 205, 208, 219, 222
 Camera lucida 141
 Abbe 142-152
 Wollaston's 121, 124, 143, 144
 Canada balsam 272
 Mounting in 257, 311
 Removal from lenses 71
 Removal from slides 246
 Carbol-turpentine 274
 Carbol-xylene 274
 Carbon-monoxide hemoglobin, spectrum of 169
 Card, catalog 264
 Centering 254
 Care of, eyes 72
 Microscope, mechanical parts 70
 Optical parts 69-72
 Negatives 207
 Water immersion objectives 68
 Carmin, borax 273
 Mucus 273
 To show currents and pedesis, 108, 109
 Spectrum 170
 Castor-xylene clarifier 273
 Cataloging, formula 262
 Preparations 261-264
 Cedar-wood oil, bottle for 257
 Clearing 273
 Oil immersion objectives 273
 Cells, deep, thin 253
 Isolated preparation 260
 Mounting 253
 Staining 260
 Cement, shellac 253, 281
 Cementing collodion 275, 302
 Center, optical 2, 3
 Centering, arrangement of illuminator 50, 54
 Card 254
 Image of source of illumination 51
- Centimeter rule 118
 Central light 41, 48, 104
 Chamber, moist 256
 Chemical focus 15
 Microscope 178
 Rays 15
 Scales 269
 Chemistry, Micro 176
 Chloral hematoxylin 278
 Chromatic, aberration 4-5
 Correction 15, 185
 Objective 14
 Circle, Ramsden 37
 Clarifier, castor-xylene 273-274
 Class demonstrations in histology and embryology 193-202
 Cleaning, back lens of objective, 72
 Homogeneous objectives 69
 Mixture for glass 250
 Optical parts 70-72
 Slides and cover-glasses 246-249
 Water immersion objectives 68
 Clearer 273, 274, 311
 Clearing, mixture 274
 Tissues 311, 313
 Cedar-wood oil 273
 Clinical microscope 193
 Cloudiness, of objective and ocular, how to determine 101
 Removal 71
 Coarse adjustment of microscope, Frontispiece; testing 74
 Cob-web micrometer 133
 Collective lens 28
 Collodion 274
 Coating glass rod 107
 Cementing 275, 303
 Clarifying 309
 Fastening sections to slide 275
 Hardening 305
 Method 304-310
 Collodionizing sections 302
 Color, correct photography 214
 Correction 15
 Images 64, 68
 Law of 160
 Production of 176
 Screens 214-217, 244
 Colored, minerals spectra of 171
 Comparison prism 163, 164
 Spectrum 164, 169
 Compensation ocular 28, 29
 Complementary spectra 160
 Compound microscope, see under microscope.
 Concave lenses 3
 Mirror, use of 42-43
 Condenser 48-58

- Abbe 54-58
 Achromatic 49, 50, 229
 Apochromatic 50
 Bull's eye 60, 224
 Centering 50, 54
 Illuminating cone 52
 Mirror with 55
 Non-achromatic 55
 Numerical aperture 52
 Optic axis 50, 54
 Photo-micrography 224, 229
 Standard size 30, 55
 Substage 49
 See also illuminator.
 Condensing lens 40
 Cone, aplanatic 54
 Illuminating 52
 Congo-glycerin 275
 Red 275
 Conjugate foci 4
 Construction of images, geometri-
 cal 5
 Continuous, spectrum 158
 Contoured, doubly 107
 Converging lens 3
 Lens system 11
 Convex lenses 3-6
 Correction, chromatic, or color
 4, 15, 185
 Cover-glass 65, 66
 Over and under correction 15
 Cotton, collodion, gun or soluble 274
 Counterstaining 310-317
 Cover-glass, or covering glass 248
 Aberration by 64
 Adjustment, specific directions 65
 Adjustment for, in photo-micro-
 graphy 235
 Adjustment and tube-length
 16, 17, 65
 Anchoring 255
 Cleaning 248-249
 Correction 64, 65
 Effect on rays from object 21, 65
 Gauges 249-250
 Measurer 249, 250
 Measuring thickness of 249
 Non-adjustable objectives, table
 of thickness 18
 No. 1, variation of thickness 250
 Putting on 103, 252
 Sealing 254
 Serial sections 322
 Thickness 17, 18, 249, 322
 Tube-length 174
 Wiping 248
 Critical angle 64
 Crystals from frog for pedesis 110
 Systems 180
 Crystallization under microscope
 58, 177-180
 Crystallography 176
 List of substances 179-180
 Currents, diffusion, avoidance 313
 Liquids 108
 Cutting sections 289
- D**
- Dark-ground illumination 42, 56-60,
 198
 Abbe illuminator 58
 Mirror 57
 Dark room for drawing 153
 Daylight, lighting 40
 Decalcifier 275
 Deck-plugs for collodion blocks 305
 Dehydration 258, 271, 311
 Demonstration, microscopes 192-194
 Micro-projection apparatus 200-201
 Denatured alcohol 271
 Deparaffining 302
 Designation of oculars 29
 Wave length 165
 Determination of field of micro-
 scope 33
 Equivalent focus 190-192
 Magnification 116, 191
 Working distance 47
 Diamond, writing 319
 Diaphragms and their employment
 42, 43, 50-58
 Diffusion currents, avoidance 313
 Direct, light 40
 Vision spectroscope 155
 Disc, Ramsden 37
 Dissecting microscope 10, 194
 Dissociating liquids 275
 Dissociator, formaldehyde 275
 Müller's fluid 275
 Nitric acid 261, 275, 280
 Distance, principal focal 4, 7, 35
 Standard at which the virtual
 image is measured 123
 Working d. of simple micro-
 scope or objective 47
 Working d. of compound micro-
 scope 13, 39, 47
 Distinctness of outline 105
 Distortion in drawing, avoidance 143
 Diverging lens 3
 Double spectrum 164
 Vision 116, 118
 Doubly contoured 107
 Refracting 175
 Draw-tube, Frontispiece.
 Pushing in 44

Drawing, with Abbe camera lucida	146-153
Board for Abbe camera lucida,	146-149, 329
Distortion, avoidance	143
Embryograph for	154
Microscope	140
Models	329
Photographic camera	154
Photo-engraving	324
Room for projection microscope	153, 154
Scale and enlargement	151
With simple microscope	153
Drugs, adulteration	182
Dry objectives	14, 20-23
Light utilized	21
Dry mounting	252
Numerical aperture	20
Dry plates, discovery by Maddox	218
Dust, of living rooms, examination	111
On objectives and oculars, how to determine	101
Removal	71
Dye, general staining with	310
Aqueous	311
Alcoholic	311
E	
Eccentric diaphragm	51, 57, 58
Egg pipette	319
Eikonometer	137, 138
Elastic stain	275, 315
Embryograph	154
Embryos, camera for	209
Photographing	209-212
Records	211
Serial Sections	320
Engraving glass for condenser	225
Enlargements	242
Eosin	276
Equivalent focal length or focus of objectives and oculars	13, 29, 33, 190-192
Erect image	1
Erecting, binocular microscope	112-113
Etching for metallography	241
Ether, alcohol	276
Sulfuric	276
Ethyl alcohol	271
Examination of dust of living rooms, bread crumbs, corn starch, fibres of cotton, linen, silk, human and animal hairs, potatoes, rice, scales	

of butterflies and moths, wheat	111
Experiments, Abbe condenser	56
Adjustable and immersion objectives	64
Compound microscope	30
Homogeneous immersion objective	68
Lighting and focusing	42, 43
Micro-chemistry	176, 181
Micro-spectroscope	167
Micro-polariscope	174
Mounting	251
Photo-micrography	226
Simple microscope	6
Exposure, of photographic plates	226, 233, 236, 242
Color-screen	214-217, 244
Extraordinary ray of polarized light	173
Eye and microscope	1, 7, 9, 11, 36
Eyes, care of	72
Emmetropic, hyperopic, myopic, normal	8, 9
Muscae volitantes	110
Eye-lens of the ocular	25
Eye-piece	25
Micrometer	129
Parfocal	45
Eye-point	7, 37, 130, 142
Ocular, demonstration	37
Eye-shade, adjusting	73

F

Farrants' solution	276
Fibers, examination	111
Textile	181
Field	32
Camera lucida	121
Illumination	52, 61
Orthoscopic ocular	27
Periscopic ocular	27
View with Microscope	32-34, 118, 142-145
Size of, with different objectives and oculars	33, 34
Field-lens, of ocular	25-27
Action	37
Dust on	101
Filar, micrometer ocular	26, 30
Ocular micrometer	133-135
Filtering balsam	272
Fine adjustment, Frontispiece; Testing	74
Fir, balsam of	272
Fixation	284
Fixative, albumen, Mayer's	271
Fixer	284

fluid, Müller's.....	275, 280, 283
fluid, Zenkers'.....	283
fluorite lens.....	15
focal distance, or point, principal.....	4, 7, 35
Length equivalent.....	13
foculus.....	6
Actinic.....	223
Chemical.....	15
Conjugate.....	4, 6
Equivalent, of objectives and oculars.....	13, 29, 190
Principal.....	4, 5, 7
Virtual.....	3
Visual.....	15, 223
focusing.....	7, 39
Adjustments, testing.....	74
Compound microscope.....	39
Experiments.....	43
Glass.....	207, 210
High objectives.....	45
Low objectives.....	43
Objective for micro-spectroscope.....	166
Photo-micrography.....	226
Screen for photo-micrography.....	210, 226
Simple microscope.....	7, 39
Slit of micro-spectroscope.....	167
flood, detection of adulteration.....	182
form of objects, determination.....	103
formal.....	260
formalin.....	276
formaldehyde.....	276
Dissociator.....	275
Isolation.....	260
Percentages.....	270
formula, for aperture.....	20
Cataloging.....	262
Desired percentages.....	270
Equivalent focus.....	191
Refraction.....	62
Fraunhofer lines.....	158-159
free, hand sections.....	289
Working distance.....	39
front combination or lens of objective.....	12-14
frontal sections.....	321
fuchsin, acid.....	281
Basic.....	275
Picro.....	281
function of objective.....	34-35
Ocular.....	36

G

gauge, cover-glass.....	250
gauge, absorbent.....	246
gelatin, liquid.....	279

Geometrical construction of images.....	5
Glass, cleaning mixture.....	251
Ground.....	34, 210, 225
Rod appearance under microscope.....	106, 107
Slides or slips.....	245
Glasses, graduate.....	269
Watch.....	260
Glue, liquid, preparation of.....	279
Glycerin.....	277
Congo.....	275
Mounting objects.....	255
Glycerin jelly for.....	277
Anatomic preparations.....	277
Microscopic preparations.....	277
Mounting objects.....	255
Glycogen, iodine stain.....	278
Graduates.....	269
Greenough's binocular microscope.....	112, 113
Ground glass, focusing screen.....	210, 226
Preparation.....	34
Gun cotton.....	274

H

Half-tones.....	324
Hardening collodion.....	305
Tissue.....	284
Hematein.....	278
Hematoxylin, chloral.....	278
Hemoglobin spectrum.....	159
High school microscope.....	75
Histology, physiologic.....	264
History of photo-micrography.....	217
Holder, lens.....	10, 124, 319
Slide.....	302, 312
Homogenous immersion, condenser.....	54
Objective.....	14, 19-23
Cleaning.....	69
Experiments.....	68
Numerical aperture.....	19-23
Homogenous liquid.....	14
Tester.....	68, 188
Hones and honing.....	288
Horizontal camera.....	233
Huygenian ocular.....	26, 27, 37, 130

I

Illuminating, cone, aperture.....	52
Objective.....	16, 184
Power.....	24
Illumination.....	48
Abbe camera lucida.....	150
Artificial.....	42, 56, 60
Air and oil.....	103-106
Centering image.....	51

- Dark ground 42, 56-60, 198
 Daylight 40
 Entire field 61
 Lamp 61
 Methods 39-64
 Micro-polariscope 174
 Micro-spectroscope 165
 Oblique with air and oil 104
 Opaque objects 166, 239
 Photography 226
 Photo-micrography 232
 Wallaston's camera lucida 144
 Illuminator 48-58
 Vertical 16, 184, 240
 See also condenser.
 Image, aerial 35, 37
 Color 64, 68
 Flame 52
 Geometrical construction 5
 Inverted, real of objective 35
 Object, size and position, 5, 9, 11, 122
 Real 5, 9, 11, 12, 35-37, 116
 Refraction 61, 68
 Retinal 7, 11, 36
 Swaying of 56
 Virtual 5, 7, 9, 11, 123
 Image-power of objectives 22
 Imbedding 293, 305
 Immersion, fluid or liquid, 14, 68, 273
 Illuminator 54
 Objective 14, 20, 68-69
 Incandescence or line spectra 158
 Incident light 40
 Index, medium in front of ob-
 jective 20-23
 Refraction 62
 Indicator ocular 197
 Infiltration, collodion 304
 Paraffin 291
 Paraffin dish 292
 Ink for labels, catalogs, drawing 324
 Interpolation 20
 Interpretation of appearances un-
 der the microscope 99-115
 Iodin stain for glycogen 278
 Iris diaphragm 181
 Irrigating with reagents 255
 Isochromatic plates 214
 Isolation 259
 Formaldehyde 260
 Nitric acid 261
 Isostigmatic objective 206
 Isotropic 174
- J—K**
- Japanese filter or tissue paper 70
 Jar for slides, etc. 246-249
 Jelly, glycerin 277
 Jena glass 12
 Jurisprudence, micrometry 140
 Knife, sharpening 286-289
 Support 299
- L**
- Labels and catalogs 262
 Labeling microscopical prepara-
 tions 262
 Photographic negative 207
 Serial sections 323
 Laboratory compound microscope 74
 Table 73
 Lamp, acetylene 42, 60, 226
 Alcohol or spirit 301
 Black 279
 Condenser 153, 330
 Electric 42, 226
 Petroleum 42, 60, 226, 233
 Lantern 200
 Slides 242
 Law of color 160
 Lens, concave 3
 Converging 3
 Convex 3-6
 Eye 25
 Field 25-27
 Fluorite 15
 Holder 10, 124, 319
 Paper 70
 System 11
 Thick 3
 Letters, in stairs 102
 Photo-engraving 324
 Lettering oculars 29
 Light, with Abbe illuminator 56
 Acetylene 42, 60, 226
 Artificial 42, 56, 60, 226
 Axial 41, 48, 56
 Direct 40
 Central 41, 48, 104
 Electric 42, 226
 Incident 40
 Mirror 42, 43
 Oblique 41, 48, 56
 Petroleum 42, 60, 226, 233
 Photo-micrography 226
 Polarized 173
 Reflected 40
 Sun 226
 Transmitted 41
 Utilized with different objec-
 tives 21
 Vertical illuminator 240
 Wave length of 164
 Welsbach 42, 226
 Lighting 39-80

- Abbe camera lucida.....150
 Artificial.....42, 56, 60, 232
 Experiments.....42
 Horizontal camera.....233
 Micro-polariscope.....174
 Micro-spectroscope.....165
 Mirror.....43, 48
 Daylight.....40, 226
 Photography.....210, 213
 Photo-micrography.....228
 Vertical illuminator.....240
 See illumination
- ne spectrum.....158-159
 quid, currents in.....108
 Homogeneous.....14, 68, 273
 cker, Laboratory or Student.....268
 ngisection.....317
- M**
- magnification, of compensation oc-
 ulars.....28
 Effect of adjusting objective.....138
 Determination.....16-140, 191
 Eikonometer.....137
 Expressed in diameters.....116
 Initial or independent.....191
 Microscope.....116
 Microscope with Abbe camera
 lucida.....151
 Microscope, compound.....119
 Microscope, simple.....117
 Photo-micrographs.....232
 Real images.....116
 Table.....126
 Projection microscope.....117, 330
 Varying with compound micro-
 scope.....123
 Velocity.....108
- agnifier, tripod.....9, 117, 207
 arker for preparations.....80
 arking objects.....80, 199
 Negatives.....213, 238
 Objectives.....32
 asks for preparations.....201
- asurement, metric. cover 2nd p.....
 118, 140
 Unit of, in Micrometry.....127
 Wave length.....165
- asurer, cover-glass.....250
 easuring thickness of cover-glass
249
- asurement with microscope and
 micrometer, Ch. IV.
- echanical parts of compound mi-
 croscope, Frontispiece II, 74-75
 Care.....70
 Testing.....73
 echanical stage.....Fig. 76-78
- Mercuric chlorid.....279
 Crystals.....279, 283, 315, 317, 320
 Metallic surfaces, photography.....239
 Preparation.....241
 Metallography, microscope.....183
 Metals, examination.....183, 239
 Met-hemaglobin, spectrum 157, 169, 244
 Method, collodion.....304-310
 Paraffin.....291-304
 Methyl alcohol.....271
 Methylated spirits.....271
 Methylene blue.....280
 Metric measures and equivalents,
 cover 2nd p.....118
- Micro-chemistry.....176-181
 Slides.....179
 Micro-metallography, objects.....183
 Micrometer.....116
 Calipers.....249
 Cob-web.....133
 Combined ocular.....135
 Filar m. ocular.....133, 134
 Filling lines.....119
 Net.....147
 Ocular and stage.....139
 Object or objective.....119
 Ocular or eye-piece.....129-138
 Ocular, micrometry.....131
 Ocular, ratio.....132
 Ocular, valuation.....130, 135, 136
 Ocular, varying valuation.....136
 Photo-micrography.....232
 Screw ocular.....133
 Stage.....119
 Table of magnification.....126
- Micrometry.....126-140
 Adjustable objectives.....138
 Comparison of methods.....139
 Compound microscope.....127
 Eikonometer.....137
 Jurisprudence.....140
 Limit of accuracy in.....139
 Ocular micrometer.....131
 Simple microscope.....126
 Remarks on.....138
 Unit of measure in.....127
- Micro-millimeter.....127
 Micron.....127
 Measuring wave length of light.....165
- Micro-photograph.....217
 Micro-polariscope.....163, 173-176
 Micro-polarizer.....173
 Micro-projection.....153, 200
 Drawing.....153, 330
 Magnification.....117
 Masks for specimens.....201
- Microscope, care.....70
 Amplification.....116

Binocular	112-114	Objects, drawing	141
Chemical	178	Ocular	25
Clinical	193	Slides or slips	245
Demonstration	192-193	Tube-length	17-19, 66
Dissecting	10, 194	Vision	25
Erecting	112-113	Microscopic preparations, cabinet	264-265
Field	32-34, 142-145	Cataloging	262-264
Focusing	39	Labeling	261-264
Illumination for, Ch. II.		Mounting	251-261
Magnification	116	Trays	266
Metallography	183	Micro-spectroscope	155-172
Micro-chemical analysis	176	Adjusting	160
Opaque objects	238	Direct vision	155
Photo-micrography	227	Experiments	167
Polarizing	173	Focusing the slit	161
Preparation, with erecting prism	113	Lighting	165
Projection	153, 154, 200-201	Objectives to use	166
Price	75	Reversal of colors	155
Putting an object under	31	Slit, mechanism	156, 160
Screen	69	Micro-Tessar objective	209
Stand for large, transparent objects	212	Microtomes	286
Stand, for embryos	209	Figures	290, 295, 296, 297, 306, 307
Solar	200	Micrum	127
Traveling	195, 196	Mikron	127
Traversing	182	Milk globules, to overcome pedesis	115
Microscope compound	11	Minerals, absorption spectra	171
Drawing	140	Minot's microtome	295
Figures, Frontispiece 12, 82-98, 113, 178, 182, 193, 195, 198, 202, 227, 230		Minute objects, arrangement	261
Focusing	39	Mirror	12-14
High schools	74	Abbe illuminator	55
Laboratory	74, 82-98	Arrangement for drawing	146
Lamp	60, 61	Concave, use of	43
Magnification	116-126	Dark ground illumination	56-60
Magnification of drawing with Abbe camera lucida	151	Light with, central and oblique	48
Mechanical parts	11, 74	Lighting	40
Micrometry	127	Plane, use of	43
Optic axis	12-14	Mixture, clearing	274
Optical parts	11, 74	Cleaning	250
Quality and cost	75	Models	324
Testing	73	Blotting paper	326
Varying magnification	123	Drawing	329
Working distance	13, 40, 47	Wax	325
Micro-summaries	210	Moist, chamber	256
Microscope, simple	1	Molecular movement	109
Drawing	153	Monazite sand, spectrum	171
Experiments	6	Mounting	251, 311
Figures	9, 10, 124, 192, 194, 207	Cells, preparation	253-258
Focusing	7, 39	Low powers	241
Images	7	Media and preparation	252
Magnification	137, 117, 124	Objects for polariscope	174-176
Micrometry	126	Permanent	252
Obtaining focus	7	Temporary	251
Working distance	39	Mounting objects	251
Microscopic, objective	11	Balsam	257, 272, 311
		Dry in air	252
		Glycerin	255
		Glycerin jelly	255, 257

Media miscible with water 254
 Minute objects 261
 Opaque objects 241
 Permanent 252
 Resinous media, by drying or desiccation 257-258, 311
 Resinous media, by successive displacements 258, 311
 Temporary 251
 Movement, Brownian, or molecular 109
 Mucicarmín or mucus stain 273, 315-317
 Müller's fluid 280, 283
 Dissociator 275
 Muscae volitantes 110
 Muscular fibers, isolation 261
 Polarizing object 175
 Museum jar 246-247

N

Natural balsam 272
 Negative, labeling 207, 238
 Oculars 25
 Record 238
 Storing 207
 Net micrometer 147
 Neutral balsam 272
 Red 280
 Nicol prism 173
 Nitric acid 280
 Dissociator 275
 Nomenclature of objectives 13
 Non-achromatic condenser 54
 Objectives 14
 Non-adjustable objectives 16, 18
 Normal liquid 280
 Salt or saline solution 275, 280
 Nose-piece 31+46
 Marking objectives 32
 Thread or screw-thread 77
 Numerical aperture, of condenser 52
 Objectives 19, 23, 187
 Table 23

O

Object, determination of form 103
 Image, size of 12, 122
 Marking parts 80+
 Marking position 197, 199
 Micrometer 119
 Mounting 251, 311
 Putting under microscope 31
 Shading 69
 Suitable for photo-micrography 225
 Transparent with curved outlines, relative position in microscopic preparations 103

Objective 11-25
 Achromatic 12, 15
 Adjustable 14, 16, 64-66
 Adjustable, micrometry 138
 Adjustable, photo-micr. 235
 Adjustment 64
 Aerial image 35
 Aperture 19, 20, 187
 Aplanatic 15
 Apochromatic 15, 221
 Back combination 13, 14
 Cleaning 70-72
 Collar, graduated for adjustment 65
 Cloudiness or dust, how to determine 101
 Designation 13
 Dry 14, 20-24
 Equivalent focus 13, 33, 190
 Field 33, 34
 Focusing for micro-spectroscopy 166
 Front combination 13, 14
 Function 34-35
 Glass for 12, 15
 High, focusing 45
 Homogeneous immersion 14, 19-23, 68
 Homogeneous immersion, cleaning 69
 Homogeneous immersion, experiments 68
 Illuminating 16, 184, 239
 Image, power 22
 Immersion 14, 20, 68
 Index of refraction of medium in front 21, 23
 Initial magnification 191
 Inverted, real image 35
 Isostigmat 206
 Laboratory microscope 75
 Lettering 13
 Light utilized 21
 Low, focusing 43
 Magnification 191
 Marking, by Krauss' method 32
 Micrometallography 16, 183
 Micro-polariscope 174
 Microscopic 11
 Microtessar 209
 Micro-spectroscope 166
 Nomenclature 13
 Non-achromatic 14
 Non-adjustable 16
 Non-adjustable, table 18
 Nose-piece 31, 32, 46, 83+
 Numbering 13
 Numerical aperture 19, 23, 187

Oil immersion	14
Pantachromatic	16
Para-chromatic	16
Par-focal	31, 46
Photography	206-210
Photo-micrography	221
Projection	16
Putting in position and removing	30
Screw-thread	77
Section	16
Semi-apochromatic	16
Table of field	33
Terminology	13
Unadjustable	16
Variable	16
Visual and actinic foci	223
Water immersion	19-23, 66
Working distance	13, 39, 40, 47
Oblique light, with Abbe illuminator	56
Mirror	48, 57
Ocular, various forms	25-28
Aplanatic	15
Cleaning	70-72
Cloudiness, how to determine and remove	71, 101
Compensation	28, 29
Equivalent focus	29, 33, 191
Eye-point	26, 37
Field-lens	37
Filar or screw micrometer	30, 133-136
Function	36
Huygenian	26, 27, 37, 130
Indicator	80, 197
Iris diaphragm	181
Lettering and numbering	29
Micrometer, micrometry	129-136
Negative	25
Parfocal	27, 43
Photo-micrography	221
Pointer	80, 197
Positive	26
Power	29
Projection	29, 223
Searching	28
Spectroscopic	155
Standard size	30
Table	26
Working	28
Oil, and air appearances and distinguishing optically	103-106
Cedar-wood	273
Oil-globules, with central and oblique illuminations	104
Oil immersion objectives	14
Opaque objects, lighting	183, 238

Photography	238
Optic axis	2, 3, 12
Condenser or illuminator	54
Crystals	175
Microscope	12-14
Optical	1
Center	2
Focus	15
Parts of compound microscope	
Frontispiece and	11, 74
Section	108
Order of procedure in mounting	
objects dry or in air	252
Glycerin and glycerin jelly	255
Resinous media by desiccation	257
Resinous media by successive displacement	258, 311
Ordinary ray, with polarizer	173
Orthochromatic plates	214
Orthoscopic ocular, field	32
Outline distinctness	105
Oven paraffin	293
Over-correction	5
Oxy-hemoglobin, spectrum	159, 169

P

Paper, bibulous, filter, lens, or Japanese for cleaning oculars and objectives	70
Blotting for models	326
Paraffin	280
Filtering	281
Infiltrating	292
Imbedding	293
Method	291-304
Oven	293
Removing from sections	302
Wax	280
Parfocal objectives	47
Oculars	43-45
Pedesis	109, 110
Overcoming	115
Polarizing microscope	110
Penetrating power	24
Penetration of objective	24
Percentages, of liquids	270
Permanent, mounting	252
Preparation of isolated cells	260
Permanganate of Potash, spectrum	157, 168
Petri dish	249
Photographing bacterial cultures	243
Petroleum light	42, 60, 226, 233
Pharmacological products, examination	182
Photo-engraving, drawing and lettering	324

- Photographic, camera 203-205
 Negatives 207-213, 238
 Objectives 206, 209, 210
 Prints 207
 Photography of bacterial cultures 243
 Color-correct 214
 Colored objects 214
 Compared with photo-micro-
 graphy 217-220
 Embryos 209
 Focusing and exposure
 204-206, 210
 Indebtedness to photo-micro-
 graphy 217
 Large transparent objects 212-214
 Lighting 206, 213, 239
 Metallic objects 239
 Objectives 206, 209, 210
 Objects in alcohol or water 204
 Opaque objects 238, 241
 Plates 214
 Stage 208
 Vertical camera 204-210
 Photo-micrograph 217
 Determination of magnification
 232
 5-20 diameters 209
 20-50 diameters 228
 100-2000 diameters 232-236
 Metallic surfaces 238-242
 Objects suitable 225
 Opaque objects 238-242
 Prints 207
 Plates 214
 Reproductions 234
 With and without an ocular
 229-237
 Photo-micrographic, camera
 219-222, 233
 Outfit 220
 Stand 227, 230
 Photo-micrography 203-244
 Apparatus 220, 233
 Compared with ordinary pho-
 tography 215, 220
 Condenser 49, 224, 229
 Distinguished from micro-pho-
 tography 217-220
 Cover-glass correction 235
 Experiments 226
 Exposure 211, 214, 217, 231, 236, 242
 Focusing 206, 210, 226
 Focusing screen 206
 Lighting
 210, 223-226, 229, 232, 239, 240, 243
 Micrometer for magnification 232
 Objectives and oculars
 16, 221, 237-240
 Staining preparations 215
 Vertical camera 208, 219, 222
 With and without ocular 229-237
 Record table 238
 Physiologic histology 264
 Picric-alcohol 281
 Picro-fuchsin 281, 314
 Pillar of microscope, Frontispiece.
 Pin-hole diaphragm 54
 Pipette 300, 311
 Egg 319
 Plane mirror, use 43
 Plates, color-correct 214
 Isochromatic or orthochro-
 matic 214
 Pleochroism 175
 Pleurosigma angulatum 48
 Point, axial 19
 Burning 7, 35
 Eye 37, 130, 142
 Pointer ocular 80, 197, 176
 Polarized light, extraordinary and
 ordinary ray 173
 Polarizer and analyzer 162, 173
 Polarizing microscope, pedesis
 110, 175
 Position of condenser 54
 Objects or parts of same object 102
 Positive oculars 12, 26
 Power, of microscope 116
 Illuminating, penetrating, re-
 solving, of objective 24-25
 Ocular 29
 Preparation of reagents 268-283
 Preparations, cataloging 261
 Cabinet 264
 Labeling 262
 Permanent 252
 Temporary 251
 Principal, focus 3, 4, 7
 Focal distances 4, 35
 Optic axis 2, 7, 12
 Prism of Abbe camera lucida 144-148
 Amici 155
 Comparison 164
 Dispersing 158
 Erecting 113
 Nicol 173
 Slit of micro-spectroscope, mut-
 ual arrangement 161
 Wollaston's camera lucida 143-144
 Prints, photographic 207
 Projection, microscope
 153, 154, 200-201, 330
 Objective 16
 Ocular 29, 223
 Pyroxylin 274

Q—R

Quadrant for camera lucida	146, 148
Ramsden circle or disc	37
Ratio, ocular micrometer	132
Razor and support	299
Reagent	268-283
Board	268
Bottle	271
Real image	6, 9, 11, 12, 35-37, 116
Record, of embryos	211
Negatives	213, 238
Record table, collodion method	310
Negatives	238
Paraffin method	303
Red, congo	275
Neutral	280
Reflected light	40
Reflection, total	64
Refraction, images	61, 68
Index	62
Medium in front of objective	20-23
Refractive, doubly	175
Highly	107
Singly	175
Relative position of microscopic objects	103
Resinous media, mounting objects	257
Resolution and numerical aperture	24
Resolving power	24
Retinal image	7, 9, 11, 12
Revolving nose-piece	31, 32
Ribbon sections	296
Deparaffining	302
Electrification	298
Spreading	298
Storing	298
Tray	266, 268

S

Sagittal sections	322
Salicylic acid, crystallization	58
Salt solution, normal	280
Scale, of drawing	151
Size of photographs	204
Wave lengths	164
Scales, chemical	269
Screen, color	215-217
Focusing for photography	206, 210
Ground glass	34
Microscope	69
Screw, society	76
Micrometer	30, 133-135
Sealing cover-glass	254, 256
Searching ocular	28
Secondary axis	367

Section knife and sharpening	287-289
Lifter	309
Optical	108
Sections, arrangement of tissue	294
Clearing	274, 311
Cutting	289-323
Dehydration	311
Deparaffining	302
Extending with water	298
Fastening to slide	298-303, 308
Free hand	289
Freezing	290
Frontal	321
Longi-	317
Mounting	311
Ribbon	295
Sagittal	322
Serial	317
Spreading or stretching by heat	298
Staining	310
Surface	318
Trans-	317, 321
Transferring	308
Vertical	318
Selenite plate for polariscope	176
Semi-apochromatic objective	16
Serial sections	317-323
Embryos	320-323
Sharpening section knives	288
Shell vials	259, 285
Shellac cement	253, 281
Significance of aperture	23
Silvering	281
Simple microscope, see under microscope.	
Sines, table of, 3d page of cover.	
Slides	245
Cleaning	245-247
Holder	302
Micro-chemistry	179, 245
Tray	266-268
Sliding microtome	306-307
Slips, glass	245
Slit mechanism of micro-spectroscope	156, 160
Society screw	76
Sodium, lines and spectrum	157, 158, 244
Solar microscope	200
Spectrum or s. of sunlight	157, 158, 244
Soluble cotton	274
Solution, Farrants'	276
Percentage	270
Saturated	269
Spectral, colors	158

- Ocular 155, 160
Spectroscope 155
 Direct vision 155, 167
Spectroscopic, examination of
 color-screens 216
 Ocular 155
Spectrum 157-172, 244
 Absorption 158, 159, 160, 167
 Analysis 172
 Angström and Stokes' law 160
 Banded 170
 Blood 168
 Carbon monoxide hemoglobin 169
 Carmin solution 170
 Colorless bodies 171
 Color screens 244
 Comparison 164
 Complementary 160
 Continuous 158
 Double 164
 Incandescence 158
 Line 158
 Met-hemoglobin 157, 244
 Minerals, monazite sand 171
 Oxy-hemoglobin 159, 169
 Permanganate of potash
 157, 168, 244
 Single-banded of hemoglobin
 159, 169
 Sodium 157, 158, 244
 Solar 157, 158, 244
 Two-banded of oxy-hemoglobin
 169
Spherical aberration 4, 5
 Test 185
Stage, Frontispiece, mechanical 82
Stain, alcoholic and aqueous 311
 Counter 310-317
 Elastic 315, 275
Staining 260, 310-317
Stand, microscope 75
 Photo-micrographic 98, 227
 Special for embryos 208
 Special for large transparent
 objects 212
Standard, distance (250 mm.) at
 which the virtual image is
 measured 123
 Screw 77-80
 Size for condenser 30, 55
 Size for oculars 30
Starch, determination by polari-
 scope 175
Stender dish 260, 305
Stokes and Angström's law of ab-
 sorption spectra 160
Strops and stropping 289
Storing negatives 207
 Preparations 264
 Ribbons of sections 298
Student locker 268
Substage, Frontispiece.
Substances for crystallography
 179-180
Sudan III 282
Sulphonal with polarizer 176
Sulphuric or sulfuric ether 276
Support for knife of microtome 299
Surface sections 318
Swaying of image 56
System, back, front, intermediate
 of lenses 12-14
 Crystal 180
 Metric, cover 2nd p. 140
- T**
- Table, black 282
Collodion method 310
Immersion fluid 189
Laboratory 73
Magnification and valuation of
 ocular micrometer 126
Oculars 26
Tube-length and thickness of
 cover-glasses 18
Natural sines, third page of
 cover.
Numerical aperture 23
Paraffin method 303
Record, photography 238
Size of fields 33
Testing homogeneous liquids 189
Valuations of ocular microme-
 ter 126
Weights and measures, 2d page
 of cover.
Temporary mounting 251
Terminology of objectives 13
Test of chromatic and spherical
 aberration 185-188
Tester, cover-glass 250
 Homogeneous liquids 68, 188
Testing a camera 220
 A microscope and its parts 73
Test-plate, Abbe's, method of
 using 185-187
Textile fibers, examination 111, 181
Thickness, of cover-glass for non-
 adjustable objectives 18
 Serial sections 321
Thread, standard for nose-piece
 and objective 77
Tissues, arranging for sections 294
 Fixing or hardening 284-286
 Washing apparatus 286
Transections 317, 321
Transferring sections 308

- Transmitted light 41
 Traversing microscope 182
 Tray for ribbons or slides 266-268
 Triplet, Hastings 10
 Tripod 9, 117
 Focusing glass 207
 Tube of microscope, Frontispiece.
 Tube-length 17-19
 Cover-glass adjustment 66-67
 Importance 66
 Various opticians, table 18
 Turn-table 253
- U**
- Utramicroscopy 59
 Unadjustable objectives 16
 Under-correction 5
 Unit of measures, in micrometry 127
 Wave length 165
- V**
- Valuation of ocular micrometer
 126, 130, 135, 136
 Variable objective 16
 Varying magnification of com-
 pound microscope 123
 Varying ocular micrometer valua-
 tion 136
 Velocity under microscope 108
 Vertical, camera 203, 222
 Illuminator 16, 184, 239
 Sections 318
 Vials, preparation and shell
 259, 284-285
 Blocks 259, 268
 Virtual image 7, 9, 11, 12, 36
 Standard distance at which
 measured 123
 Visibility with objectives 24
- Vision, double 116, 118
 Microscopic 25
- W**
- Washing apparatus for tissues 286
 Waste bowl 309
 Watch glass 260
 Water immersion objective 19-23, 66
 Light utilized 21
 Numerical aperture 22, 23
 Water, bath 153
 Wave length, designation 165
 Scale 164
 Wax, bees 325
 Models 325
 Paraffin 280
 Weigert's elastic stain 275, 315
 Weights and measures, see 2d page
 of cover.
 Welsbach light 226
 Wenham's binocular microscope
 112, 114
 Wollaston's camera lucida
 121, 124, 143, 144
 Work-room for photo-micrography 221
 Work-table, position, etc. 73
 Working, distance of microscope
 or objective 13, 39, 40, 47
 Ocular 28
 Writing diamond 319
- X**
- Xylene 273
 Balsam 272
 Xylol, German form of xylene 273
- Z**
- Zenker's fluid 283

TABLE OF NATURAL SINES

Compiled from Prof. G. W. Jones' Logarithmic Tables

MINUTES.	DEGREES AND QUARTER DEGREES UP TO 90°.											
1' 0.00029	1°	0.01745	16°	0.27564	31°	0.51504	46°	0.71934	61°	0.87462	76°	0.97030
2 0.00058	1°, 15'	0.02181	16°, 15'	0.27983	31°, 15'	0.51877	46°, 15'	0.72236	61°, 15'	0.87873	76°, 15'	0.97134
3 0.00087	1, 30	0.02618	16, 30	0.28402	31, 30	0.52250	46, 30	0.72537	61, 30	0.88282	76, 30	0.97237
4 0.00116	1, 45	0.03054	16, 45	0.28820	31, 45	0.52621	46, 45	0.72837	61, 45	0.88689	76, 45	0.97338
5 0.00145	2	0.03490	17	0.29237	32	0.52992	47	0.73135	62	0.88995	77	0.97437
6 0.00175	2, 15	0.03926	17, 15	0.29654	32, 15	0.53361	47, 15	0.73432	62, 15	0.88499	77, 15	0.97534
7 0.00204	2, 30	0.04362	17, 30	0.30071	32, 30	0.53730	47, 30	0.73728	62, 30	0.88701	77, 30	0.97630
8 0.00233	2, 45	0.04795	17, 45	0.30486	32, 45	0.54097	47, 45	0.74022	62, 45	0.88902	77, 45	0.97723
9 0.00262	3	0.05234	18	0.30902	33	0.54464	48	0.74314	63	0.89101	78	0.97815
10 0.00291	3, 15	0.05669	18, 15	0.31316	33, 15	0.54829	48, 15	0.74606	63, 15	0.89298	78, 15	0.97905
11 0.00320	3, 30	0.06105	18, 30	0.31730	33, 30	0.55194	48, 30	0.74896	63, 30	0.89493	78, 30	0.97992
12 0.00349	3, 45	0.06540	18, 45	0.32144	33, 45	0.55557	48, 45	0.75184	63, 45	0.89687	78, 45	0.98079
13 0.00378	4	0.06976	19	0.32557	34	0.55919	49	0.75471	64	0.89879	79	0.98163
14 0.00407	4, 15	0.07411	19, 15	0.32969	34, 15	0.56280	49, 15	0.75756	64, 15	0.90070	79, 15	0.98245
15 0.00436	4, 30	0.07846	19, 30	0.33381	34, 30	0.56641	49, 30	0.76041	64, 30	0.90259	79, 30	0.98325
16 0.00465	4, 45	0.08281	19, 45	0.33792	34, 45	0.57000	49, 45	0.76323	64, 45	0.90446	79, 45	0.98404
17 0.00495	5	0.08716	20	0.34202	35	0.57358	50	0.76604	65	0.90631	80	0.98481
18 0.00524	5, 15	0.09150	20, 15	0.34612	35, 15	0.57715	50, 15	0.76884	65, 15	0.90814	80, 15	0.98556
19 0.00553	5, 30	0.09585	20, 30	0.35021	35, 30	0.58070	50, 30	0.77162	65, 30	0.90996	80, 30	0.98629
20 0.00582	5, 45	0.10019	20, 45	0.35429	35, 45	0.58425	50, 45	0.77439	65, 45	0.91176	80, 45	0.98700
21 0.00611	6	0.10453	21	0.35837	36	0.58779	51	0.77715	66	0.91355	81	0.98769
22 0.00640	6, 15	0.10887	21, 15	0.36244	36, 15	0.59131	51, 15	0.77988	66, 15	0.91531	81, 15	0.98836
23 0.00669	6, 30	0.11320	21, 30	0.36650	36, 30	0.59482	51, 30	0.78261	66, 30	0.91706	81, 30	0.98902
24 0.00698	6, 45	0.11754	21, 45	0.37056	36, 45	0.59832	51, 45	0.78532	66, 45	0.91879	81, 45	0.98965
25 0.00727	7	0.12187	22	0.37461	37	0.60182	52	0.78801	67	0.92050	82	0.99027
26 0.00756	7, 15	0.12620	22, 15	0.37865	37, 15	0.60529	52, 15	0.79069	67, 15	0.92220	82, 15	0.99087
27 0.00785	7, 30	0.13053	22, 30	0.38268	37, 30	0.60876	52, 30	0.79335	67, 30	0.92388	82, 30	0.99144
28 0.00814	7, 45	0.13485	22, 45	0.38671	37, 45	0.61222	52, 45	0.79600	67, 45	0.92554	82, 45	0.99200
29 0.00844	8	0.13917	23	0.39073	38	0.61566	53	0.79864	68	0.92718	83	0.99255
30 0.00873	8, 15	0.14349	23, 15	0.39474	38, 15	0.61909	53, 15	0.80125	68, 15	0.92881	83, 15	0.99307
31 0.00902	8, 30	0.14781	23, 30	0.39875	38, 30	0.62251	53, 30	0.80386	68, 30	0.93042	83, 30	0.99357
32 0.00931	8, 45	0.15212	23, 45	0.40275	38, 45	0.62592	53, 45	0.80644	68, 45	0.93201	83, 45	0.99406
33 0.00960	9	0.15643	24	0.40674	39	0.62932	54	0.80902	69	0.93358	83	0.99452
34 0.00989	9, 15	0.16074	24, 15	0.41072	39, 15	0.63271	54, 15	0.81157	69, 15	0.93514	84, 15	0.99497
35 0.01018	9, 30	0.16505	24, 30	0.41469	39, 30	0.63608	54, 30	0.81412	69, 30	0.93667	84, 30	0.99540
36 0.01047	9, 45	0.16935	24, 45	0.41866	39, 45	0.63944	54, 45	0.81664	69, 45	0.93819	84, 45	0.99580
37 0.01076	10	0.17365	25	0.42262	40	0.64279	55	0.81915	70	0.93969	84	0.99619
38 0.01105	10, 15	0.17794	25, 15	0.42657	40, 15	0.64612	55, 15	0.82165	70, 15	0.94118	85, 15	0.99657
39 0.01134	10, 30	0.18224	25, 30	0.43051	40, 30	0.64945	55, 30	0.82413	70, 30	0.94264	85, 30	0.99692
40 0.01164	10, 45	0.18652	25, 45	0.43445	40, 45	0.65276	55, 45	0.82659	70, 45	0.94409	85, 45	0.99725
41 0.01193	11	0.19081	26	0.43837	41	0.65606	56	0.82904	71	0.94552	85	0.99756
42 0.01222	11, 15	0.19509	26, 15	0.44229	41, 15	0.65935	56, 15	0.83147	71, 15	0.94693	86, 15	0.99786
43 0.01251	11, 30	0.19937	26, 30	0.44620	41, 30	0.66262	56, 30	0.83389	71, 30	0.94832	86, 30	0.99813
44 0.01280	11, 45	0.20364	26, 45	0.45010	41, 45	0.66588	56, 45	0.83629	71, 45	0.94970	86, 45	0.99839
45 0.01309	12	0.20791	27	0.45399	42	0.66913	57	0.83867	72	0.95106	86	0.99863
46 0.01338	12, 15	0.21218	27, 15	0.45787	42, 15	0.67237	57, 15	0.84104	72, 15	0.95240	87, 15	0.99885
47 0.01367	12, 30	0.21644	27, 30	0.46175	42, 30	0.67559	57, 30	0.84339	72, 30	0.95372	87, 30	0.99905
48 0.01396	12, 45	0.22070	27, 45	0.46561	42, 45	0.67880	57, 45	0.84573	72, 45	0.95502	87, 45	0.99923
49 0.01425	13	0.22495	28	0.46947	43	0.68200	58	0.84805	73	0.95630	87	0.99939
50 0.01454	13, 15	0.22920	28, 15	0.47332	43, 15	0.68518	58, 15	0.85035	73, 15	0.95757	88, 15	0.99953
51 0.01483	13, 30	0.23345	28, 30	0.47716	43, 30	0.68835	58, 30	0.85264	73, 30	0.95882	88, 30	0.99963
52 0.01513	13, 45	0.23769	28, 45	0.48099	43, 45	0.69151	58, 45	0.85491	73, 45	0.96005	88, 45	0.99976
53 0.01542	14	0.24192	29	0.48481	44	0.69466	59	0.85717	74	0.96126	88	0.99985
54 0.01571	14, 15	0.24615	29, 15	0.48862	44, 15	0.69779	59, 15	0.85941	74, 15	0.96246	89, 15	0.99991
55 0.01600	14, 30	0.25038	29, 30	0.49242	44, 30	0.70091	59, 30	0.86163	74, 30	0.96363	89, 30	0.99996
56 0.01629	14, 45	0.25460	29, 45	0.49622	44, 45	0.70401	59, 45	0.86384	74, 45	0.96479	89, 45	0.99999
57 0.01658	15	0.25882	30	0.50000	45	0.70711	60	0.86603	75	0.96593	90	1.00000
58 0.01687	15, 15	0.26303	30, 15	0.50377	45, 15	0.71019	60, 15	0.86820	75, 15	0.96705		
59 0.01716	15, 30	0.26724	30, 30	0.50754	45, 30	0.71325	60, 30	0.87236	75, 30	0.96815		
60 0.01745	15, 45	0.27144	30, 45	0.51129	45, 45	0.71630	60, 45	0.87250	75, 45	0.96923		

