

GARDEN GUIDE

THE AMATEUR GARDENERS'
HANDBOOK



Cornell University

Library

OF THE

New York State College of Agriculture

Ag. 8687

24/10/17

3518

Cornell University Library
SB 453.D55 1917

Garden guide, the amateur gardeners' han



3 1924 002 848 608

mann

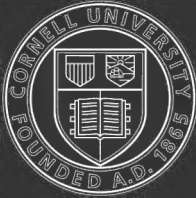

Cornell University Library

The original of this book is in
the Cornell University Library.

There are no known copyright restrictions in
the United States on the use of the text.

<http://www.archive.org/details/cu31924002848608>

GARDEN GUIDE

THE AMATEUR GARDENER'S HANDBOOK

How to Plan, Plant and Maintain the Home Grounds, the Suburban Garden, the City Lot. How to Grow Good Vegetables and Fruit. How to Care for Roses and Other Favorite Flowers, Hardy Plants, Trees, Shrubs, Lawns, Porch Plants and Window Boxes. Chapters on Garden Furniture and Accessories, with Useful Rules and Recipes, Selected Lists of Plants, etc.

Heavily illustrated with teaching plans and diagrams and reproduced photographs, all made expressly for this Great Little Text Book

Contributors

THE VEGETABLE GARDEN

F. F. Rockwell,
Putnam, Conn.

THE FRUIT GARDEN

A. J. Loveless,
Lenox, Mass.

BIRDS IN THE GARDEN

Chas. Livingston Bull



EDITED BY
J. HARRISON DICK

Contributors

THE FLOWER GARDEN LAWNS, TREES, SHRUBS GARDEN FURNITURE, & C.

Prof. A. C. Hottes,
University of Ohio

PUBLISHERS' FOREWORD

A. T. De La Mare

PRICE: Paper, 50 cts; Cloth, 75 cts.

NEW YORK

A. T. DE LA MARE COMPANY, INC., 438 TO 448 West 37th Street

©
S13453
D55
1917

ag. 8687

COPYRIGHT, 1917.
A. T. DE LA MARE COMPANY, INC.

All Rights Reserved

CONTENTS

(For Classified Index See Pages 251-254)

CHAPTER I—PLANNING THE HOME GROUNDS

First Considerations in the Composition of a Garden—Drives—Lawns—Location of Dwelling House—Treatment of the Shrubs, Belts, Borders, Beds—A Plea for Greater Seclusion.

CHAPTER II—LAWNS AND GRASS PLOTS

Establishing a New Lawn—Seed Mixtures—Care of the Lawn—Turfging.

CHAPTER III—HEDGES AND FENCES

The Homeliness of the Enclosed Garden—Best Plants for Hedges—Board Fences.

CHAPTER IV—TREES AND SHRUBS

Beauty, Shade and Shelter from Trees—Evergreen Trees and Shrubs—Street Trees—Selection of Flowering Trees and Shrubs—List of Blooming Dates.

CHAPTER V—THE ROSE GARDEN

Hardy Brier Roses. Climbing, Tea, Hybrid Tea, Hybrid Perpetual Roses—Preparation of Soil—General Treatment—Insects and Diseases.

CHAPTER VI—AMONG THE HARDY FLOWERS

Combinations of Perennials—Planning Hardy Borders—Spring and Autumn Planting—Cultivation—Staking—Watering—Lists of Alpines and Perennials.

CHAPTER VII—A FEW OF "EVERYBODY'S FAVORITES"

Gladiolus—Peony—Canna—Dahlia—Chrysanthemum—Iris—Sweet Pea.

CHAPTER VIII—ANNUALS AND BIENNIALS

Soils—Sowing—Combinations of Annuals—Everlasting Flowers—Annuals for Cut Flowers—Lesser-known Annuals—Germination Table.

CHAPTER IX—BULBS AND TUBEROUS-ROOTED PLANTS

Preparation of Beds—General Cultivation—List of Bulbous Plants.

CHAPTER X—HARDY GARDEN FERNS

Soil—Position—Selection of Kinds.

GARDEN GUIDE

CHAPTER XI—THE ROCK GARDEN

Construction—Materials—Suitable Plants.

CHAPTER XII—GARDEN FURNITURE

Arbors—Seats—Sundials—Birdbaths, etc.

CHAPTER XIII—FRUIT FOR THE SMALL GARDEN

Apples—Pears—Peaches—Gooseberries, etc.

CHAPTER XIV—VEGETABLE GARDEN

Digging and Preparing Soil—Planting and Transplanting—Principles of Cultivation—Harvesting and Storing—Sowing and Planting Table—Cultivation of the Chief Vegetables.

CHAPTER XV—HOME CANNING OF FRUITS AND VEGETABLES

CHAPTER XVI—PRUNING

Roses—Hedges—Ornamental Shrubs—Fruit Trees—Evergreens.

CHAPTER XVII—ENEMIES OF PLANTS

Insect Pests and Plant Diseases, with means of Combating Them.

CHAPTER XVIII—WINTER PROTECTION

Straw Mats—Protective Material for Outdoor Plants—Frames, etc.

CHAPTER XIX—PLANT PROPAGATION

Cuttings—Divisions—Seeds—Grafts—Layers.

CHAPTER XX—WINDOW BOXES AND PORCH PLANTS

CHAPTER XXI—GREENHOUSES, HOTBEDS AND FRAMES

Best Type of House for Small Place, also Notes on Heating—Hotbeds and Coldframes.

CHAPTER XXII—BIRDS IN THE GARDEN

Best Type of Bird Houses—Feeding of Birds—List of Berry-bearing Shrubs.

CHAPTER XXIII—GARDEN TOOLS

CHAPTER XXIV—CALENDAR OF GARDEN OPERATIONS FOR THE YEAR

ILLUSTRATIONS

Annual and Perennial Plants, Garden of.....	92
Apple Tree, Typical Half Stan- dard for Amateur's Garden..	133
Arch, a Rustic.....	129
Arches, Trellised Rose.....	127
Backyard Gardens, Plans of. 12- 13	13
Backyard Gardens to Street Houses.....	107-154
Bean, Improved Golden Wax- pod.....	167
Beans, Dwarf French.....	171
Bird Bath.....	90
Bird Houses (Wren and Blue- bird).....	230-232
Bog Garden and Semi-wild Gar- den.....	117
Borders of Hardy Flowers.59-60-	61
Box for Transplanting Seedlings.	148
Bridge, Rustic, Design for.....	125
Brussels Sprouts, Dish of.....	163
Bulbs, Diagram for Planting.....	111
Cabbages.....	167
Cannas, Bed of.....	77
Carrots, Early Stump-Rooted..	168
Celery Plants, Showing Thin- ning and Blanching of.....	164
Chair, Rustic, Making a.....	128
Crocuses Naturalized in the Grass.....	104
Cropping of a Half-acre Garden, Plan for.....	160
Cropping of a Town or City Garden, Plan for.....	159
Currant Shoots, Pruning.....	144
Cuttings, Hardwood and Soft- wood.....	200
Cuttings in Flower Pot.....	206
Daffodil Flower, Single.....	108
Dahlia Root.....	201
Dahlias, Hedge of.....	80
Delphiniums from Seed.....	96
Dove Cote.....	124
Flower, Section of a Typical....	206
Flowers, Old and New Way of Arranging.....	240
Foxgloves Colonized.....	95
Frame, A, 199; Cold, Well Shel- tered Line of, 225; Double Glazed, 224; Garden, the King Jr., 221; Small, for Forcing.....	223
Fruit—Collection of Grapes, Pears, Apples, 135; Collec- tion of Melons, Peaches, Apples, Grapes.....	138
Garden Composition, a Good..	36
Garden Plans. 12, 23, 25, 26, 29.	154
Garden Scene in Early Summer.	103
Grafting, Cleft, 207; Tongue...	208
Greenhouse, Small, Suitable for Moderate-sized - Suburban Place.....	218, 219
Home on Highway, With Hedges Around.....	17
Hotbed Frame, Section of.....	222
Hotbed, Planting a.....	161
House, Best Exposure in Rela- tion to Sun.....	14
Insects—Head of sucking, 194; Head of biting.....	194
Iris Border Backed with Shrubs in Semi-wild Garden.....	83
Iris Flower and Its Parts.....	87
Iris, Japanese, Colonized.....	85
Jerusalem Artichoke Tuber....	201
Lattice Screen.....	20- 21
Lattice Work Against a House, and Window Box.....	212
Lawn Plantings.....	33

- Lawn View..... 19
- Layering of Raspberry and Blackberry, 209; Gooseberries, 210; Rhododendrons..... 210
- Lily of the Valley Pip..... 109
- Mats, Straw or Reed..... 198
- Morning Glories, a Hedge of... 101
- Onion Sets..... 173
- Pavilion, a Rustic..... 127
- Peonies, a Border of, 71; Types of, 73; Rack for..... 73
- Peonies, Violas and Other Hardy Flowers..... 63
- Pergola of Classical Design, 130; a rustic..... 54
- Plans of Gardens..... 12, 13, 23, 25, 26, 29, 37, 38, 154
- Planting Plans for Shade and Shelter..... 15
- Planting, Right and Wrong Methods of..... 37- 38
- Pond With Water Lilies..... 113
- Potatoes, Basket of..... 175
- Pruning a Dwarf Rose..... 186
- Pruning: A limb, 188; Raspberries, 191; Shrubs, 187; Vines, 141; Young Tree..... 188
- Red Currant Tree, A..... 143
- Rock Garden, Diagram for Making a..... 121
- Rock Garden Scenes..... 118, 122
- Rose and Flower Gardens. 48-51- 56
- Roses on Arches..... 89
- Screen for the Side or Back of House..... 57
- Seat, Rustic..... 125, 129
- Sprayer, An Efficient Barrel... 145
- Spraying Engine, Hand Pump. 195
- Strawberry Runner..... 209
- Strawberry, The Marshall... 142
- Sub-tropical Plants in Summer. 41
- Sugar Corn, Well-grown Ears.. 180
- Summer House..... 124
- Sun Parlor and Window Boxes. 220
- Sweet Peas on Trellises..... 89
- Swiss Chard..... 177
- Terrace Garden Well Planted... 30
- Tools and Devices, 237; Barrel, Broad Wheeled, 239; Frame Barrow for Leaves and Grass, 239; Garden Hoes, 170; Garden Steps, 239; Garden Syringe and Vaporizing Sprayer, 194; Hoisting a Barrel, Device for, 239; Hand Cultivator, 239; Lawn Beater and Roller, 237; Light Ladder, 237; Markers, 165; Pea and Bean Supports, 237; Planet Jr. Hoe, 169; Roller, 236; Sawing Pieces off Level, Method of, 237; Secateurs, 192; Sickle, 239; Storage Box for Fruit, 239; Tree Guard, 236; Water Barrel on Wheels, 236; Watering Can, Long Stemmed..... 239
- Tomato Plants, Wire Netting Supports for..... 179
- Tomatoes Trained to Fence... 178
- Trellis, a Dainty..... 125
- Tulips, Narcissi and Other Bulbs in Backyard Garden..... 107
- Turnips, White Milan..... 176
- Vegetable Garden for Supplying a Large Household..... 155
- Vegetable Garden on Suburban Lot..... 149, 152
- Vegetables, Typical Collection of 150
- Vines, Grape, Kieffen System of Pruning..... 141
- Water Lilies in a Pond..... 113
- Water Loving Plants..... 116
- Window Boxes Filled with Petunias..... 211
- Workmen's Dwellings with no Garden..... 16, 31
- Workmen's Gardens Nicely Planted..... 32

PUBLISHERS' FOREWORD



BOOK must bear a title, a distinguishing name, and so here we have the AMATEUR GARDENER'S GUIDE. Its scope will be unfolded in the Preface of the editor and compiler. The Publishers, however, ask a first hearing. The conception of the book was not at all limited to the purposes set forth in the title. It had a higher aim. Through its medium we hope to win thousands from crowded city homes to the free air of the open country. We seek to preach freedom from the very housetops, to induce worthy citizens to cultivate their health as well as their gardens and, in so doing, add to their happiness and the years of their lives, to do their duty by their children through environing their young lives with the surroundings which will make them sturdy, self reliant and observant, and best fit them for their own battle of life. Among children there are few weaklings in the country.

The country (and in this term may be included practically all our suburban towns, boroughs and villages) is the children's paradise, with all Nature's world as their playground.

The hygienic value of fresh vegetables and fruits is beyond question; their value to the family cannot be estimated in terms of money. The writer knows this and thousands of fortunate suburbanites will testify to its truth. A good garden is Nature's antidote for all ills flesh is heir to; it certainly does not make for a source of revenue to the physician. Fresh fruits and vegetables, each in their season, taken from your garden, are something quite different from the much handled and frequently stale products we buy in the city. Nearly every vegetable is an annual and can be grown with the first year's occupancy, and the second Summer the taste for all the small fruits can be indulged in to the full.

The Cliff Apartment dweller, whose vision is bounded on all sides by straight lines of brick and mortar, cement and stone, whose life is harried by the janitor, whose quietude is disturbed by the noises overhead and below, who cannot enjoy a night's sleep in the open without fear of arrest, whose movements to and from business are made miserable in trolley, subway or "L," must surely envy the commuter, even though the latter be still made the butt of the irrepressible joker, whom we pardon because, poor man, *he* knows no better.

Advocacy of social advantages has no particular part in this presentation, yet these features have more play in country than in

towns, for the acquaintances made by your children in the former will, as a whole, be more permanent and have a larger bearing on their future because they are more intimately brought together in their school, their play and their daily association.

Suburban public schools are governed to a great extent by men who have come out from the cities. Their advantages here are equal to those of the city, perhaps superior, because the classes average smaller, high schools abound, and the education of the youth up to the age of seventeen or eighteen can thus be obtained at or very near home.

Life in the suburbs opens the way to a family home—one's very own, eliminating forever the yearly move. Don't pay rent—own your home so you can do with it as you please. Permanence of location is helpful to well-being, so then make a careful selection. Take time to make an intelligent choice and, where you settle, make the best of it; stick. If you have the funds to pay for the home outright, you are among the fortunate ones, otherwise the local building and loan association will take care of you at no greater outlay than rent if you own the ground and are considered a good moral risk. Inside of eleven years the home is yours and the money which would otherwise go to a generally indifferent landlord may be applied to betterments, to education or to the purchase of more land.

Whether it is better to buy than to build depends on circumstances. Painstaking investigation is always in order.

The family home, the home for your children and quite likely for some of your children's children, the home wherein the family traditions will linger, surely that is the home that's wanted—the home to which your children may come back and the recollection of which will brighten all the toilsome days of their lives. The family home is the wisest of all investments; it is the foundation which makes for family honor and stability. Pedigree adds to the stability of our country and its institutions, and the family home is the source and foundation of true patriotism.

There is no Springtime in the city, no Autumn. Among the bricks and stone the unfolding glories of Spring are unknown to the toiler and his family. The city is equally unresponsive to the awakening life of the one as it is to the passing glories of the other. A city has but two seasons, Summer and Winter, mostly the latter—the Winter of our discontent.

Do not let it be said of you: "The city was his country; he loved better to hear the trolley car rattle than the birds carol." The city may be a good place to work in; it undoubtedly is; but if all our homes could be in the freedom of the country we would be a superior race.

INTRODUCTION



WE all have our dream gardens in which stretches of smooth lawns appear, hedges of sweet smelling shrubs like Brier Roses, Lavender, Rosemary, or of neat leaved Box, such as one sees at the old home of George Washington at Mt. Vernon. We have our scenes of Rose beds encircled by grass or sand-covered paths, with a little fountain and bird bath nearby, a cozy arbor or rest-house off to one side, borders filled opulently with a variety of old-time hardy flowers, fragrant with memories of other days. Here and there a fruit tree stands laden with the promise of luscious fruits, and all around is the busy hum of insect life, with the flutter of birds and butterflies, and the throbbing of a hundred things of the great storehouse of Nature, that make a garden more than a dreamland, but certainly a place of great, refreshing rest, recuperation, peace, happy thoughts. It is the place to commune with friends, either in bodily presence or in books. It is a place in which to plan, to read, to rest, to work, to play. Back of all there is the utilitarian kitchen garden, the drying yard, the chicken run, the place for the household pets, the children's swing and sand heap, and the other happy features and adjuncts that make the house and garden our *home*.

We believe that one chief reason for the paucity of good and bright gardens is the lack of knowing how to set about making them. Gardening is a very large subject. It has formed the study and recreation of the leisure moments of many eminent men from the time of Solomon, Homer, Aristotle, Plato and others of the ancients, to Erasmus and Bacon of the Renaissance, Evelyn of the seventeenth century, to the more modern notabilities, as Pope, Walpole, Cowper, Goethe, Cobbett, our own Nathaniel Hawthorne and Thoreau, with many, many others. The amateur gardener is therefore in excellent company of the present, as well as of all past times. Gardening is pleasurable, healthful, intellectual.

We should not forget the purely economical side of the matter that has been dwelt upon in the publishers' foreword. But this GARDEN GUIDE is not intended exactly to be a mentor on making money or saving money. You are willing to pay for your household gods, embellishments, your automobile, your camera and sporting outfits, your concerts and theatres. Expect to pay, therefore, for your gardening; yet we can assure the amateur that well-considered expenditure on the garden more than pays for itself. You can have delicious edible Asparagus on your table day in, day out for weeks in the early

part of the year.* You can have salads and young vegetables from April until November. Then there are the flowers and fruits over and above, and other assets of and from the garden that are too apparent to need to be mentioned.

The plan of this book is sufficiently set forth in the table of contents, and we therefore offer this GUIDE confident in the belief that it will be found an excellent introduction to what is unequivocally one of the most delightful recreations that man can pursue.

In the preparation of this Guide acknowledgement must be given, in addition to those whose names appear on the title page, to John McArthur, Elizabeth, N. J., for suggestions on the heating of small greenhouses; to Samuel Redstone, formerly of Philadelphia, for hints on the kinds of greenhouses most suitable for amateurs; and to Prof. W. F. Massey, Salisbury, Md., for the calendar of garden operations for the South. For help in the preparation of the manuscript for the printer, and in the reading of the proofs, warmest thanks are tendered to A. G. Peterkin, Bloomfield, N. J.

CHAPTER I

Planning the Home Grounds

IF one's place is but a small area of so many dozen square yards, it is great fun to do one's own planning, and little can go wrong. Should the place be more pretentious, running to one or two acres, it might be money in one's pocket to consult a landscape gardener, or an experienced nurseryman or designer. There are several excellent books, too, that can be referred to, and from which valuable information can be got on the laying out of your home grounds. One of these is Cridland's "Landscape Gardening."

The first considerations in the composition of a garden or the grounds about one's place are Privacy, Variety, Shelter, Balance.

The planning and arrangement of the features of a garden or of the grounds about the house should be as carefully considered as the choice and placing of the furniture in one's home, or the choosing of a suit of clothes, or a dress to wear. The same idea holds, namely, the planning of a suitable, agreeable, comfortable composition. The garden has been called the outdoor drawing-room.

The arrangement of the drives and the grading of the lawns, the drainage when necessary, and the arrangement of the buildings and outhouses should all be preconceived and settled in an orderly, economical manner. As far as possible there should be no mistake about the main, permanent features. The minor features may be changed quite a great deal in the coming years and almost surely will, as new ideas and points of view assert themselves. This changing of the minor features is a part of the recreation of gardening. Thus one may considerably alter the contour of a shrubbery border, or may indeed eliminate it altogether. The same holds good of flower beds and borders, which are easily altered, removed or added to; but with large trees or the heavier groups of shrubs the expense of removal and shifting prohibits this being done except out of dire necessity.

Where one has the choice of building one's house or choosing its location, the best aspect for it is where the front porch faces southeast, as shown in accompanying drawing; another good position is facing due south. In any case, as everybody likes abundant sunshine or ought to, see to it that the windows and living rooms face in the direction of abundant light. Those places that are hidden beneath a dense canopy or half a forest of trees may suit, and do suit, some folks, but

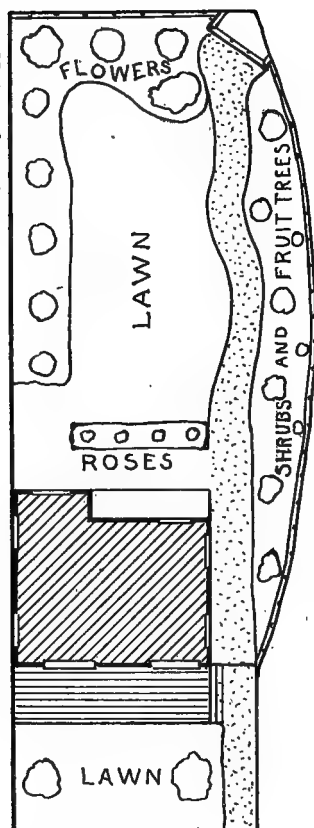

Actual layout of a backyard garden fenced, on lot 30x100 ft. Standard Apple, Plum and Pear trees were planted around the divisional fences. They did not unduly shade the hardy flowers. The smooth gravel path terminated in an arbor, over which Roses, Ivy and Clematis grew. Rhododendrons, evergreens, hardy Heaths, Viburnums, etc., with bulbs between, were used on the right hand border. There was a sun parlor at the back of the house. The garden lay due south

they are terribly depressing to the great majority of us, besides being, one should imagine, not conducive to health. Light, air, freedom, are good watchwords for the builder and planner.

Character can be given to an entrance by simply having two ornamental pillars built there, with possibly an iron arch over them. If this is planted with creeping vines and is supported at the sides with groups of evergreens, it adds wonderful dignity and seeming value to the property.

While winding paths or drives are graceful, they should not be made meaninglessly, but are in order where the ground slopes a little or dips, or where irregularity exists. Certainly these can always be added or made in order to get the curved line. Even in small places, as our plans show, the swinging line of beauty can be had. Straight paths may, however, be more convenient, and can still be tasteful and harmonious. They are undoubtedly neat.

No book can tell the reader exactly what may be the best arrangement for his garden or property. Every garden should have a character of its own, and generally does, unless in the case of the very smallest, where nearly all opportunity for variety is extinguished; yet it is remarkable what can be done on a quarter or an eighth of an acre. We have often seen plots of 30 ft. x 100 ft. laid out with much variety and taste, and which were full of interest. In those towns and cities of our own country, and in the old

countries where the inhabitants, almost to a man, appreciate the elegancies of gardening, the little places exhibit the utmost variety of character in their composition.

It is all too true that thousands of gardens and grounds all around our American homes are bare to desolation. The democratic idea and feeling against planting of hedges and the lining off of one's property makes for deadly uniformity. The arguments that unhedged or unfenced grounds would be contrary to the best artistic conception and treatment of a city or suburb as a whole, ought not to be allowed to sway the property owner from making the most and the best of his own place. There is a school of landscape gardeners and city planners who seem to set their face against this, encouraging the open community type of home grounds. The latter will never get us anywhere as a nation of garden lovers, and almost entirely precludes the practice of the finer gardening. We plead rather to see places nicely hedged or railed off, so that stray dogs and unceremonious persons may be kept, at a proper distance, but most of all for the sake of the enjoyment and encouragement of that quiet privacy without which the true pleasures of gardening cannot be attained.

Which is the best—to have a big, bare lawn and a few trees, or an odd group of shrubs here and there, or the trimly hedged and fenced grounds, with flower borders, specimen trees and shrubs, beds and belts of Roses, arches of Roses and

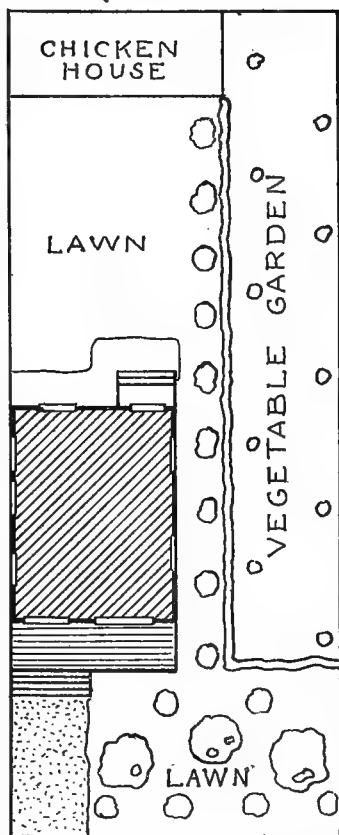

Suburban lot fenced, on 40x100 ft. A low hedge divided off the vegetable garden. Fruit trees and bushes were lined by the side of this, while pillar Roses, dwarf Roses, neat shrubs and beds of flowers were elsewhere well disposed. The vegetable plot was a model of good cropping, containing Tomatoes, Corn, Beans, Beets, Celery, Carrots, Spinach, herbs and salads. Raspberries lined the fences. This ran east and west

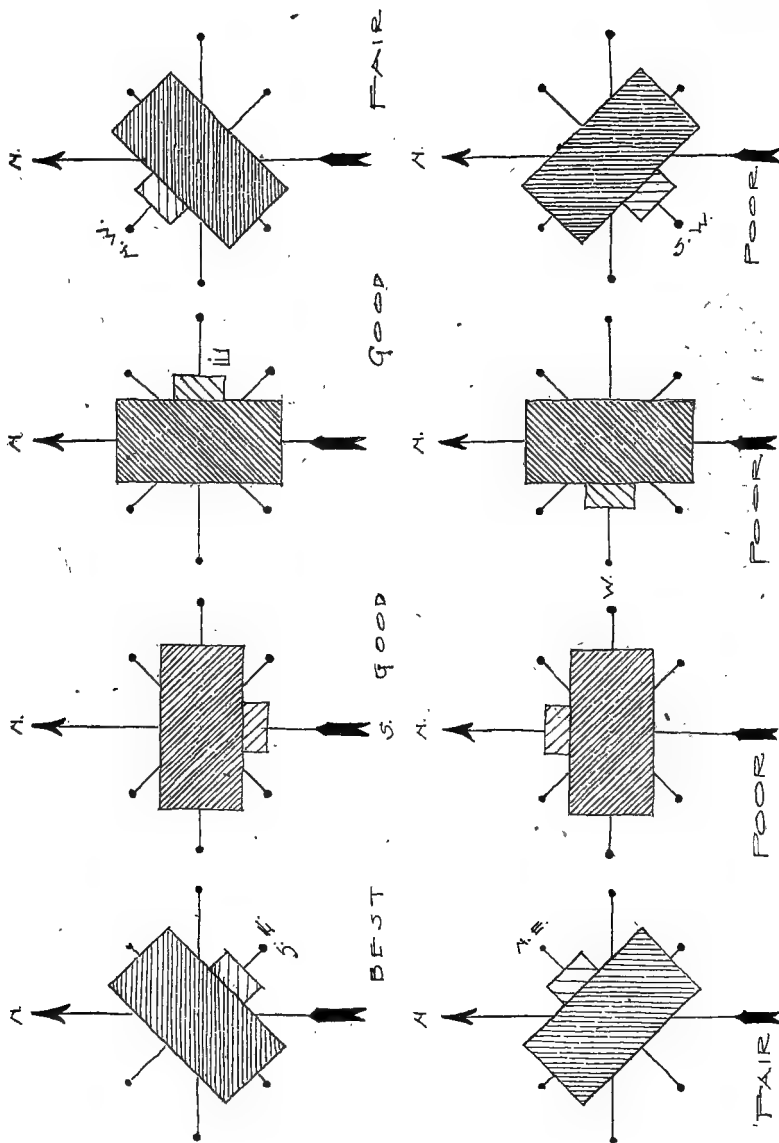

Facing South-east is the best exposure of the house in relation to the sun

other climbers, water basins, an arbor or Rose house where tea or ice-cream may be partaken in the sunny Summer days, or where in

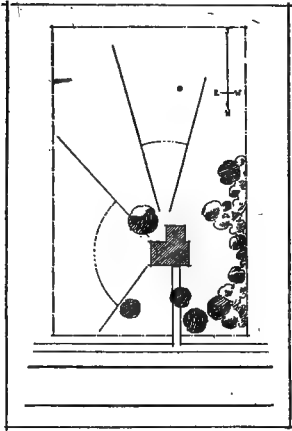

FIG. A — Planting plan to insure best effect of shade, outlook, protection, and privacy on a lot facing north

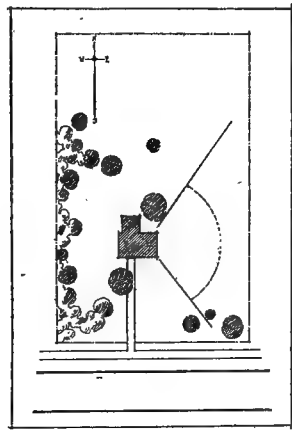

FIG. B — Planting plan to insure best effect of shade, outlook, protection, and privacy on a lot facing south

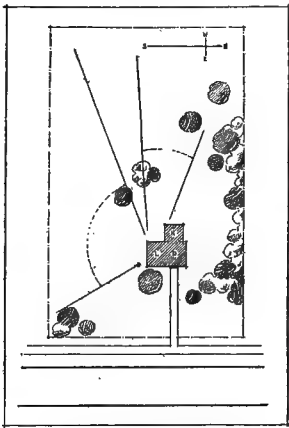

FIG. C — Planting plan to insure best effect of shade, outlook, protection and privacy on a lot facing east

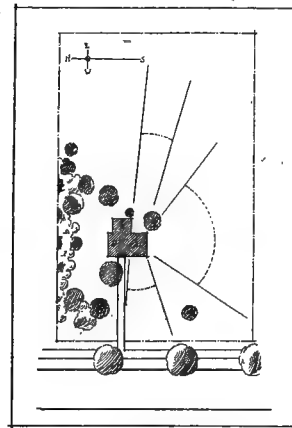

FIG. D — Planting plan to insure best effect of shade, outlook, protection and privacy on a lot facing west



Haven't you seen many working men's houses just like this—gaunt and bare, no neat hedges, no neat lawns, not even a Geranium or a Canna in sight?

some shady corner we can enjoy a siesta or a book in the open air?

The fact is we do not make half enough use of the grounds about our homes; they are left blank in most instances. We warmly urge the planting of light screen belts of trees and hedges around the property, which

need not be so dense as to prevent a neighbor or passer-by from enjoying glimpses of your garden. Regel's Privet, California broad-leaved Privet, Golden Privet, Hemlock, Arborvitæ, Austrian Pine, White Pine, Norway Spruce, Rambler Roses, Ivy, Ampelopsis, Plane trees, Berberis Thunbergii, are among the easily grown subjects that are useful in such screen belts, and most of which can be increased on one's own place at little expense if the suggestions given in another part of this book are carried out.

The initial expense of planting the outer parts and main features of the grounds or garden need not be large. By the exercise of a little patience one can grow on a good many things for future developments. Poplars should only be used sparingly. They grow fast, it is true, and for that reason are often employed, and in some places are elegant and pleasant enough, but generally they are "messy," losing their leaves early, and their roots often choke up drains. The almost constant rustling of their leaves and other aspects of the trees are disagreeable to many people.

Make provision for a good space of lawn, and treat the lawn well. Water in motion, as in fountains, is often desirable but is a secondary consideration, just as the number and amount of flower beds or borders is, as also the introduction of rock gardens, arbors and such like. The thing of prime importance is to have the main features properly planned at the outset—the garage, the barn, the poultry run, the kitchen or vegetable garden, and the other parts of the place such as have been already spoken of, also the grading and terracing (if any), are among the first matters that require attention. Minor undulations or changes of the surface can be left for a future day. It is not, we repeat, necessary to have a cut and dried plan from the beginning;

far better let it grow with your knowledge of the place. What may be called the adventitious, luxurious or additional features will, practically speaking, take care of themselves. You will gradually come to find out the most appropriate spot for this or that. Do not be in a hurry; allow the place to grow up. It will suit your pocket better and furnish endless recreation and pleasure. It will keep your mind happy and active. You will be interested and learning all the while. This is true gardening, and the meaning and the reward of gardening and garden making.

Some pains should be taken to have clean, well-made paths. Take out 6 in. or 8 in. of soil and fill with clinkers, rough ashes or stones, finishing off with smaller stones, bound or rolled in with a little soil. For a strong, permanent road, concrete may be employed. If a cement surface is objected to, gravel can be strewn over before the cement sets, and be rolled in. Grass paths are comfortable and beautiful. Brick is also good. It is well also to have a tile or slate or wooden edging to the paths, as this makes for neatness and easy up-keep.

You will find that by walking around your district or other districts, your walks are as a book; at every turn you will gain some experiences or suggestions that may be modified or adopted with profit on your own grounds.

Lastly, there is no place so unpromising that it cannot, by dint of knowledge, skill, effort and some small financial expenditure, be made a beautiful or trimly garden.



A comfortable home on a public highway in the country. Is the hedge any detraction? On the contrary, does it not bespeak repose and quietude within? It takes little imagination to conjure up a pleasant garden here—the fruit trees, the shrubs, the vegetables, the flowers, the children's swing, the rest house, the pretty lawn. These are solid comforts; let's have them

CHAPTER II

Lawns and Grass Plots

THE lawn furnishes the setting for a house, and if it is trim, smooth and of a healthy green, will add the finishing touch to an attractive home which no amount of planting can give. Wide spreading slopes or level terraces of turf are the delight of many of the simplest and stateliest residences. Neat lawns are ever the sign of thrifty people.

The main difficulty generally is that too frequently the surface is cut by meaningless and inappropriate beds. Such beds, in large lawns, sometimes detract from the feeling of repose, and in small lawns the beds may often be left out with advantage. Trees and shrubs which are arranged haphazard and thickly about a lawn are also objectionable. Many a home yard is utterly spoiled by this spotty appearance. The suggestion is to let the lawn stand for a feature by itself, and to arrange the trees, shrubs and flowers at the margins. In many cases no better effect can be gained than by allowing the cool green lawn to run directly up to the brick or brown stone houses.

In establishing a new lawn it should always be remembered that the first preparation is the important one; it should remain for years before being dug up again. If the soil is a heavy clay, it must be drained, for the grasses most used in lawns do not tolerate "wet feet." If grading has been done, soil which was at the surface must be provided for a surface layer, because subsoil does not contain the proper organisms for good growth. If top soil is not obtainable, it is better to seed for a year with Peas and Oats which should be spaded or plowed under when in juicy growth. Any soil will benefit by an application of well decayed manure. Fresh manure contains weed seeds and will always prove troublesome. Besides manure, there is nothing better than ground bonemeal. This will continue to supply the beneficial food substances for a great length of time. Before the seed is sown, the soil must be raked very smoothly and the stones removed. It should be firm and perfectly level, for every hollow will show later. A little rolling will compact the soil just enough for seeding.

SEED MIXTURES. No one variety of lawn grass is the best. In order to get results we must not depend on one grass alone, but must so mix our varieties that a thick turf is formed not only quickly, but permanently. Some grasses live but a year, and require an annual re-sowing. Cheap mixtures contain some of these. It is interesting to

know that the roots of some grasses go deeper than others; for this reason good mixtures utilize the whole top soil most advantageously. Reputable seedsmen can be depended upon to supply proper mixtures for various purposes. Go to them, tell them your soil conditions, and they will give you the proper mixture.

Kentucky Blue Grass is no doubt the most used. It does not make a good sod the first year, but improves in subsequent years. It succeeds admirably on the limestone soils. In Midsummer, it is apt to become somewhat brown. Canada Blue Grass is useful for dry and



A lawn, soft and smooth as velvet

clayey soils and seems able to resist drought. Many of the Fescues are extremely valuable. The fine-leaved Sheep's Fescue has the narrowest blades. The Hard Fescue is useful in forming a dense mat and stands drought. Besides these, the Creeping, the Sheep's and the Meadow Fescues all form sods, and are useful for mixtures.

For immediate results, but not lasting, a little Italian Rye Grass can be used. Red Top seems to succeed even on slightly acid soils, and forms a dense mat. The Sweet Vernal Grass is odorous and gives a softness to the lawn. Wood Meadow and Rough Stalked Meadow Grass both succeed well in the shade. White Clover is also useful in mixtures; it forms a dense ground cover and thrives in most soils and climates. A quart, which is a little over half a pound, should be used for every three hundred square feet of surface. The Clover is to be sown separately, as the seed is heavier.

SOWING. Grass may be sown as soon as the snow has gone and the



A lattice screen, supported at the base by a wall. Between the chinks of the stones and in a channel along the top, suitable plants are grown

ground warmed slightly. It is an advantage to get it well started before the trees begin to shade the soil, perhaps as early as April. If sown later, especially in Midsummer, the hot sun will make it difficult for the grass to start. The soil will need careful and thorough watering. Grass seed may also be sown in the Autumn from mid-August to October, with good results. If a day just before a rain can be chosen it will be found that the grass will be up in a few days. If no rain is in sight, give a thorough sprinkling of water, but not with force, else the seed will be washed out. If it is windy, however, the seed will scatter badly, and will not come up evenly.

When large areas are to be sown it is best to divide the lawn into approximately ten-foot squares and treat each separately, else it will be difficult to sow uniformly. To cover the seeds, the areas should then be raked in two directions, after which the lawn should be thoroughly rolled. This will compact the soil so that the seeds are in contact with the soil particles.

THE YEARLY CARE of the lawn consists first of a slight mulch of thoroughly rotted manure in the Winter. This not only protects the grass from the cold, but supplies plant food as well. In the Spring, when growth first starts, the coarser material should be removed and the lawn given a dressing of bonemeal. An application of nitrate of soda, which is best applied in solution (one oz. to two gallons of water), will give the lawn a good start. To renovate the lawn, seed can usually be sown about one-half as thickly as for new lawns.

Frequently bad spots are found. These are often due to the fact that in grading some large stone has been left in the soil which cuts off the supply of water from below. At other times the soil becomes a little sour. If the bad spot is dug up deeply and the stones removed, fresh soil, a little lime and decayed manure added, the fault is often remedied. It is advisable to give an extra heavy seeding also.

MOWING. When the young grass has been up for perhaps two weeks it is often good to roll it and defer the first cutting until the plants are about three inches tall. The new lawn should not be cropped too closely, but should be cut regularly. The grass will then be induced to spread out rather than grow tall. If cut weekly, the clippings should not be removed; they will be useful to protect the roots against the sun as well as to furnish an excellent mulch. If, however, the grass

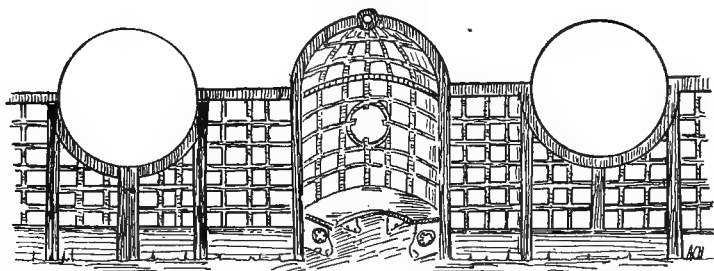

Some flower gardens are so situated that it becomes necessary to run a lattice-work fence around them. A dainty, ornamental fence like the above, if painted white, is very suitable

has grown long, the clippings should be raked and will be a good mulch for use about perennials in the borders.

ROLLING. Not only on the newly seeded areas is the roller useful, but all the lawns should be thoroughly rolled in the Spring. The Winter frosts cause more or less heaving of the soil, exposing the roots to drying as well as leaving an irregular surface. The best rollers for the purpose are the water ballast rollers; they are made of hollow iron and can be readily filled with water, thus increasing or diminishing the weight for the various soils and their changing conditions.

WEEDING. Many of the objectionable weeds on new lawns are annuals, and they may be entirely eradicated in one year if they are prevented from seeding. Many other weeds, such as Docks, Dandelions and Canadian Thistles, are perennials, and are provided with underground fleshy roots which must be dug deeply. Cutting them just below the surface aggravates the situation, for generally three or four shoots start in place of one.

TURFING. It often becomes necessary to establish a lawn under very adverse conditions, in which case it is best to use sod or turf which can be removed from a pasture or vacant lot. With a spade the turf can easily be cut into twelve-inch squares and moved. Especially is this advantageous for bordering newly established paths and roads, or where narrow strips are wanted between beds of flowers. The soil should be as carefully prepared and put in as good physical condition as for new lawns. In edging walks, the cut sod should be a little lower than the adjacent sown area, which in time will settle. The sod should be thoroughly firmed and watered so that the grass roots are encouraged to immediately start growth into the soil below.

GARDEN GUIDE

KEY TO PLAN OPPOSITE

Key No.	Quan.	Variety*	Common Name
1	1	<i>Populus fastigiata</i>	Lombardy Poplars
2	1	<i>Populus fastigata</i>	Lombardy Poplars
3	1	<i>Quercus palustris</i>	Pin Oak
4	1	<i>Fraxinus americana</i>	American Ash
5	1	<i>Acer saccharum</i>	Sugar Maple
6	3	<i>Salisburia adiantifolia</i>	Maidenhair Tree
7	2	<i>Acer polymorphum dissectum rubrum</i>	Cut-leaved Japanese Maple
8	3	<i>Thuja plicatum</i>	Fern-leaved Arborvitæ
8	2	<i>Juniperus elegantissima</i> Leei	Golden Juniper
9	1	<i>Liquidambar styraciflua</i>	Sweet Gum
10	5	<i>Viburnum tomentosum</i>	Single Japanese Snowball
11	6	<i>Lonicera fragrantissima</i>	Early Bush Honeysuckle
12	5	<i>Syringa</i> , named varieties	Lilacs
13	5	<i>Hydrangea paniculata</i>	Late Hydrangea
14	6	<i>Philadelphus coronarius</i>	Mock Orange
15	7	<i>Rosa rugosa</i>	Japanese Rose
16	6	<i>Buddleia Veitchiana</i>	Butterfly Plant
17	5	<i>Viburnum plicatum</i>	Japanese Snowball
18	6	<i>Lonicera Morrowi</i>	Bush Honeysuckle
19	7	<i>Abelia grandiflora</i>	Hybrid Abelia
20	9	<i>Rhododendron album elegans</i>	White Rhododendron
21	8	<i>Rhododendron roseum elegans</i>	Pink Rhododendron
22	7	<i>Lonicera Morrowi</i>	Bush Honeysuckle
23	6	<i>Rosa rugosa</i>	Japanese Rose
24	4	<i>Spiræa Van Houttei</i>	Drooping Spiræa
25	5	<i>Spiræa Thunbergii</i>	Snow Garland
26	3	<i>Weigela Eva Rathke</i>	Red Weigela
27	5	<i>Philadelphus Lemoinei</i>	Mock Orange
28	6	<i>Spiræa Van Houttei</i>	Drooping Spiræa
29	6	<i>Hydrangea paniculata grandiflora</i>	Large flowering Hydrangea
30	8	<i>Spiræa Thunbergii</i>	Snow Garland
31	9	<i>Abelia grandiflora</i>	Hybrid Abelia
32	7	<i>Azalea Hinodegiri</i>	Japanese Azalea
33	7	<i>Azalea Hinodegiri</i>	Japanese Azalea
34	5	<i>Spiræa arguta</i>	Hybrid Spiræa
35	6	<i>Kerria japonica</i> , single	Yellow Kerria
36	12	<i>Iris Silver King</i>	White Flag
37	7	<i>Hypericum Moserianum</i>	St. John's Wort
38	6	<i>Rosa multiflora</i>	Dwarf Japanese Rose
39	10	<i>Phlox divaricata</i>	Early Blue Phlox
40	10	<i>Aquilegia flabellata nana alba</i>	White Columbine
41	10	<i>Stokesia cyanea</i>	Stokes' Aster
42	8	<i>Iris pallida dalmatica</i>	Lavender Flag
43	3	<i>Pæony Festiva maxima</i>	White Peony
44	10	<i>Aster amellus Beauty of Ronsdorf</i>	Michaelmas Daisy
45	12	<i>Chrysanthemum Julia Lagravère</i>	Red Chrysanthemum
46	3	<i>Pæony Richardson's grandiflora</i>	Peony
47	16	<i>Delphinium formosum</i>	Indigo Larkspur
48	5	<i>Dicentra spectabilis</i>	Bleeding Heart
49	18	<i>Helenium Hoopesii</i>	Early Sneezewort
50	12	<i>Veronica longifolia subsessilis</i>	Speedwell
51	10	<i>Phlox Miss Lingard</i>	Early Phlox
52	6	<i>Kerria japonica</i> , single	Single Kerria
53	10	<i>Hesperis matronalis</i>	Sweet Rocket
54	12	<i>Chrysanthemum Golden Mme. Martha</i>	Yellow Chrysanthemum
55	6	<i>Weigela Eva Rathke</i>	Dark Red Weigela
56	12	<i>Aquilegia chrysantha</i>	Yellow Columbine
57	8	<i>Phlox Rheinstrom</i>	Pink Phlox
58	8	<i>Phlox Ardense Grete</i>	Early White Phlox
59	5	<i>Syringa</i> , named varieties	Lilac
60	2	<i>Juniperus virginiana</i>	Red Cedar
61	9	<i>Phlox Elizabeth Campbell</i>	Pink Phlox
62	8	<i>Lonicera Morrowi</i>	Bush Honeysuckle
63	5	<i>Hibiscus syriacus</i> , single	Pink Rose of Sharon
64	5	<i>Philadelphus Mont Blanc</i>	Mock Orange

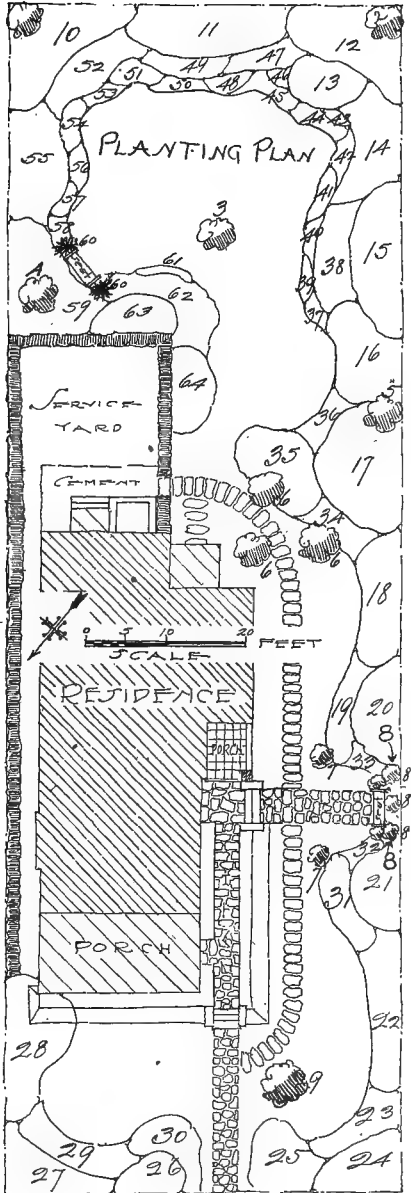

Planting Plan

Shows a good treatment of a property 50x150 ft., using broken flagstones with mortar joints for the main walk and stepping stone walk to the service quarters and the rear lawn. The service yard enclosed by hedge

(See Planting Key on page 22)

KEY TO PLAN OPPOSITE

Key No.	Quan.	Variety	Common Name
1	9	Juniperus virginiana	Red Cedar
2	16	Roses, Hybrid Tea (Standards)	
3	125	Hybrid Tea Roses	Everblooming Roses
4	350	Ligustrum ovalifolium	California Privet
5	3	Spiræa Van Houttei	Drooping Spiræa
		Lonicera Morrowi { Key Nos.—6 9 22 28 38 63 } No. Plants—5 6 5 5 3 3 }	Bush Honeysuckle
7	1	Magnolia acuminata	Cucumber Tree
8	5	Viburnum Opulus sterilis	Snowball
10	10	Buddleia Veitchiana	Butterfly Plant
11	3	Biota orientalis conspicua	Columnar Chinese Arborv
12	10	Desmodium japonicum	Purple Bush Clover
13	6	Hydrangea quercifolia	Oak-leaved Hydrangea
14	5	Forsythia suspensa	Drooping Golden Bell
15	1	Red Siberian Crab	Crab Apple
16	14	Dianthus barbatus	Sweet William
		Berberis Thunbergii { Key Nos.—17 18 31 64 } No. Plants—9 9 5 7 }	Japanese Barberry
19	6	Deutzia Lemoinei	Lemoine's Deutzia
20	8	Phlox W. C. Egan	Hardy Phlox
21	10	Iris Silver King	White Flag
23	8	Rose Pink Baby Rambler	Everblooming Rose
24	12	Rose White Baby Rambler	Everblooming Rose
25	6	Rose Hermosa	Everblooming Rose
26	8	Rose Pink Baby Rambler	Everblooming Rose
27	5	Rosa rugosa	Japanese Rose
29	3	Lonicera fragrantissima	Early Honeysuckle
30	8	Phlox Miss Lingard	Early Phlox
32	5	Juniperus Sabina	Savin Juniper
33	3	Taxus cuspidata	Japanese Yew
34	1	Larix europæa	European Larch
35	1	Cornus florida rubra	Pink Dogwood
36	2	Buxus arboreascens (Globe)	Globe-shaped Box
37	4	Taxus cuspidata	Japanese Yew
39	1	Magnolia conspicua	White Magnolia
40	15	Hypericum Moserianum	St. John's Wort
41	5	Forsythia suspensa	Drooping Golden Bell
42	9	Abelia grandiflora	Hybrid Abelia
42½	7	Hydrangea radiata	Silver-leaved Hydrangea
43	8	Xanthorrhiza apiifolia	Yellow Root
44	6	Spiræa Thunbergii	Snow Garland
44½	4	Syringa vulgaris	Lilac
45	1	Apple, Grimes' Golden	
46	5	Philadelphus coronarius	Mock Orange
47	9	Spiræa Margaritæ	Pink Spiræa
48	3	Juniperus virginiana glauca	Blue Cedar
49	1	Liquidambar styraciflua	Sweet Gum
50	5	Hydrangea paniculata	Late Hydrangea
51	9	Oenothera missouriensis	Evening Primrose
52	10	Iris Blue Boy	German Flag
53	9	Chrysanthemum St. Iloria	Pink Chrysanthemum
54	6	Pæonia Van Houttei	Crimson Peony
55	6	Funkia cærulea	Plantain Lily
56	6	Phlox Diadem	Hardy Phlox
57	3	Pæonia festiva maxima	White Peony
58	7	Delphinium chinense	Chinese Larkspur
59	10	Iris pumila aurea	Dwarf Flag
60	8	Spiræa Thunbergii	Show Garland
61	5	Pyrus Maulei	Pink Japanese Quince
62	1	Juniperus Cannarti	Pyramidal Cedar
65	9	Phlox Eugene Danzanvilliers	Lilac Phlox
66	12	Iris aurea	Yellow Flag
67	6	Pæonia grandiflora	Pink Peony
68	12	Iris pallida dalmatica	Lavender Flag
69	8	Chrysanthemum Julia Lagravère	Red Chrysanthemum
70		Annuals and Perennials	
71	1	Populus fastigiata	Lombardy Poplar

(See Planting Key on page 24)

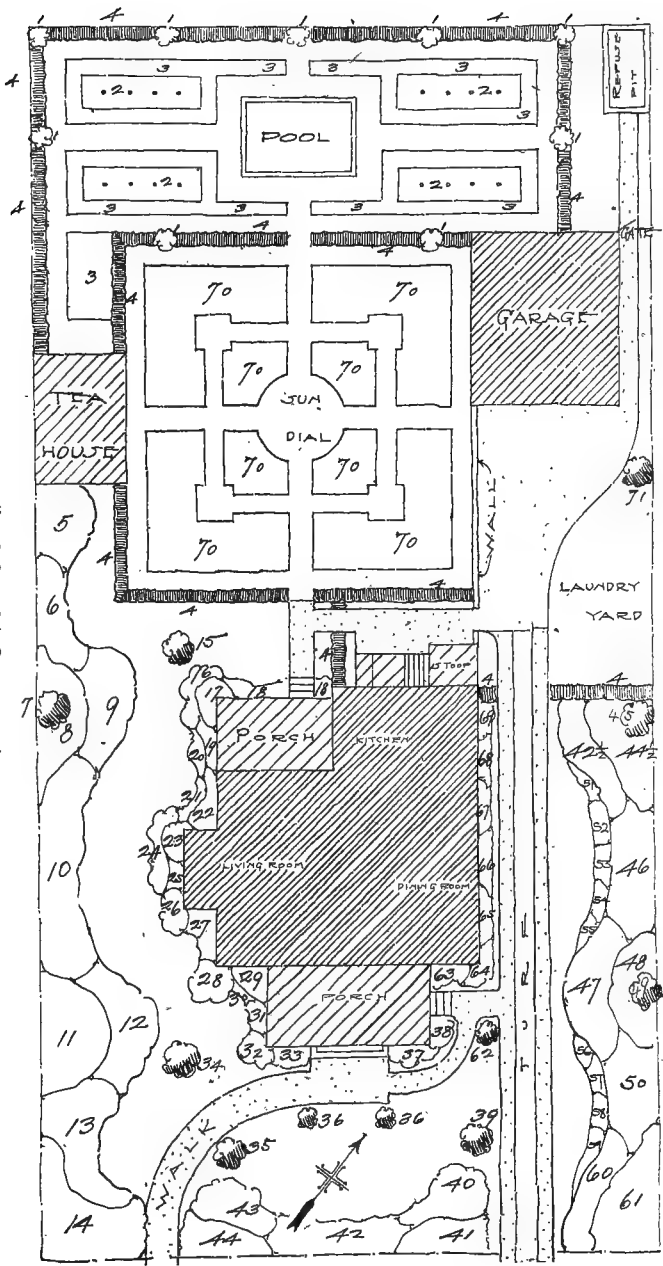

GARDEN GUIDE

KEY TO PLANTING PLAN OPPOSITE

Kr No.	Quantity	Variety	Common Name	Key No.	Quantity	Variety	Common Name
1	5	Makonia aquifolia	Holly-leaved Barberry	42	12	Abelia grandiflora	Hybrid Abelia
2	6	Bambusa Metake	Evergreen Bamboo	43	1	Apple Maiden's Blush	Apple
3	4	Funkia carulea	Plantain Lily	44	7	Calycauthus floridus	Sweet Shrub
4	15	Rhododendron roseum elegans	Pink Rhododendron	45	7	Spiraea Thunbergii	Yellow Garden
5	8	Buxus (Globe Shape)	Box Buxus	46	5	Abelia grandiflora	Hybrid Abelia
6	7	Rhododendron Sargentii	Rhododendron Sargentii	47	5	Abelia grandiflora	Hybrid Abelia
7	20	Rhododendron Mrs. Milner	Hybrid Rhododendron	48	5	Viburnum plicatum	Japanese Snowball
8	8	Funkia carulea	Plantain Lily	49	10	Jasminum nudiflorum	Yellow Jasmine
9	30	Ferns	Rhododendron atrosanguineum	50	12	Caryopteris mastacanthus	Blue Spiraea
10	50	Lily of the Valley	Crimson Rhododendron	51	15	Hydrangea paniculata	Late Hydrangea
11	30	Lily of the Valley	Ferns	52	1	Liquidambar styraciflua	Sweet Gum
12	30	Witch-hazel plants, collected	Lombardy Poplar	53	1	Abelia grandiflora	Bush Clover
13	17	Populus fastigiata	Rege's Privet	54	1	Apple Smoketree	Apple
14	2	Ligustrum Regelianum	Chinese Wistaria	55	1	Acer platanoides	Red-leaved Norway Maple
15	2	Clematis paniculata	Japanese Clematis	56	1	Quercus avilum fl. pl.	White-flowering Cherry
16	7	Spiraea japonica	Japanese Spiraea	57	7	Quercus palustris	Pin Oak
17	6	Spiraea pinnatifida fl. pl.	Bush Honey-suckle	58	6	Staphylea trifolia	Stephanandra
18	1	Cornus florida rubra	Bridal Wreath	59	6	Hibiscus syriacus, blue and white	Rose of Sharon
19	20	Spiraea A. Waterer	Hybrid Spiraea	60	8	Spiraea Billardi	Pink Spiraea
20	1	Fraxinus Ornus	Drooping Spiraea	61	8	Rhodotypos kerrioides	White Kerria
21	20	Spiraea Van Houttei	Japanese Barbery	62	6	Kerria japonica, single	Yellow Kerria
22	12	Hydrangea Thunbergii	Flowering Ash	63	5	Syringa, named kinds	Lilac
23	7	Spiraea pinnatifida	Flowering Spiraea	64	1	Picea pungens	Koster's Spruce
24	17	Deutzia gracilis	Chinese Lilac	65	4	Viburnum tomentosum	Sweet Shrub
25	12	Deutzia gracilis	Chinese Lilac	66	12	Spiraea A. Waterer	Dwarf Pink Spiraea
26	18	Weigela Eva Rathke	Dark Red Weigela	67	5	Abies balsamea	Balsam Fir
27	5	Cercis canadensis	Red Bud	68	5	Syringa, named varieties	Lilac
27a	1	Catalpa speciosa	Western Catalpa	70	10	Azalea mollis, yellow	Ghent Azalea
28	5	Viburnum Lantana	Wayfaring Tree	71	5	Philadelphus coronatus	Mock Orange
29	3	Viburnum coccineum	Chinese Opulbail	72	1	Sauk babytonica	Yellow Willow
30	1	Fraxinus Ornus	Scarlet Ash	73	6	Syringa vulgaris alba	White Lilac
31	1	Fraxinus Ornus	Flowering Ash	75	1	Acer polymorphum atrosan-guinum	Red Japanese Maple
32	1	Picea pungens	Koster's Spruce	76	1	Quercus rubra	Red Oak
33	10	Azalea mollis, red	Japanese Azalea	77	5	Deutzia gracilis	Slender Deutzia
34	3	Ligustrum Iboata	Iboata Privet	78	1	Acer poly. dissectum	Cut-leaved Japanese Maple
35	3	Proctia villosa	Proctia	80	1	Perennials	
36	3	Sophora japonica	Sophora	81	8	Aster lewis	Lavender Hardy Aster
37	8	Rege's Privet	Rege's Privet	82	10	Enothera missouriensis	Yellow Evening Primrose
38	2	Cercis japonica	Japanese Red Bud	83	10	Aquilegia chrysantha	Yellow Columbine
39	20	Berberis Thunbergii	Thunberg's Barbery	84	15	Phlox Eugene Dautanvillers	Lavender Phlox
40	3	Tsuga canadensis	Hemlock	85	10	Iris Blue Boy	German Flag
41	15	Betula nigra	Red Birch	86	10	Cornus	Common Dogwood
41	15	Symphoricarpos racemosa	Coral Berry and Snowberry	87	4	Crataegus Oxyacantha, standards	English Hawthorn
41	1	Vitex Agnus-Castus	Clasie Tree	88	2	Acer saccharum	Sugar Maple

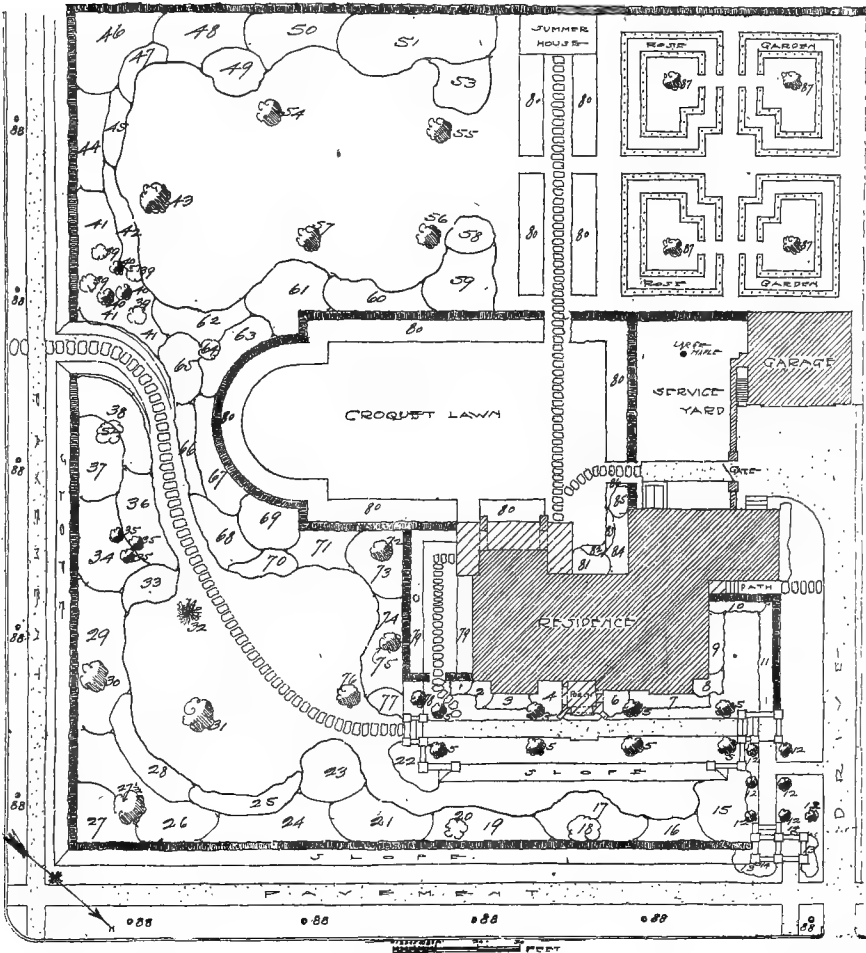

PLANTING PLAN

Lot 190x190 ft. Residence lot designed to provide a flower garden, garage, enclosed service yard and croquet lawn. The interesting features are a terrace walk, stepping stone walk in lawn, and unique entrance arrangement

¹ (See Planting Key on page 26)

Key		KEY TO PLAN OPPOSITE		Common Name
No.	Quan.	Variety		
1, 2	and 3	Syringas in variety		Lilac
4	6	Spiræa Van Houttei		Van Houttei Spiræa
5	5	Hydrangea arborescens grandiflora		Large Flower Hybrid
6	and 31	Kerria japonica, single		Corchorus
7	6	Forsythia viridissima		Golden Bell
8	7	Amygdalus nana		Flowering Almond
9	11	Exochorda grandiflora		Pearl Bush
10	15	Pyrus japonica		Japanese Quince
11	7	Lonicera grandiflora		Bush Honeysuckle
12	and 31	Spiræa Frøbelli		
13	12	Symphoricarpos racemosus		Snowberry
14	9	Berberis vulgaris		Barberry
15	6	Lonicera Marrowi		Bush Honeysuckle
16	14	Deutzia gracilis		Dwarf Deutzia
17	11	Viburnum Carlesii		
18	5	Retinispora plumosus		Japanese Cypress
19	7	Viburnum dentatum		Arrowwood
20, 33	and 34	Berberis Thunbergii		Japanese Barberry
21	11	Spiræa sorbifolia		Ash-leaved Spiræa
22	11	Weigela rosea		Pink Weigela
23	7	Deutzia Pride of Rochester		Pink Deutzia
24	5	Syringa Pekinensis		Chinese Lilac
25	5	Cercis japonica		Japanese Red Bud
26	5	Caragana arborescens		Siberian Pea
27	5	Juniperus virginiana		Red Cedar
28	9	Viburnum tomentosum		Single Japanese Snowball
28½	5	Rosa rubiginosa		Sweet Briar
29	20	Spiræa Thunbergii		Thunberg's Spiræa
30	7	Hypericum moserianum		St. John's Wort
32	and 35	Ligustrum Regelianum		Regel's Privet
37	and 54	Azalea Hino-de-giri		Evergreen Azalea
38	7	Berberis purpurea		Purple-leaved Barberry
39	3	Philadelphia Avalanche		Mock Orange
40	3	Viburnum Carlesii		
41	3	Syringa Mme. Casimir Perrier		White Lilac
42	6	Spiræa Anthony Waterer		Pink Spiræa
43	3	Syringa Pres. Grevy		Blue Lilac
44	5	Hydrangea paniculata grandiflora		Large Flowering Hybrid
45	5	Desmodium penduliflorum		Bush Clover
46	6	Weigela Eva Rathke		Red Weigela
47	6	Viburnum Opulus sterilis		Snowball
48	and 49, 11	Hibiscus		
51	8	Dwarf Fruit Trees (4 Apples and 4 Pears)		
50	3	Forsythia Fortunei		Golden Bell
52	1	Populus fastigiata		Lombardy Poplar
53	1	Pyrus Ivensis (Bechtel's)		Flowering Crab
55	5	Cotoneaster Simonsii		
56	and 57, 11	Ilex		Holly
58	3	Rhododendron roseum elegans		Rosy Bay
59	5	Mahonia japonica		Evergreen Barberry
60	and 62	Azalea amœna		Evergreen Azalea
61	5	Ilex crenata latifolia		Japanese Holly
63	5	Ilex crenata		Japanese Holly
64	5	Mahonia aquifolia		Evergreen Barberry
65	7	Rhododendron purpureum elegans		Rose Bay
66	5	Ilex glabra		Ink Berry
67	10	Rhododendron roseum elegans		Rose Bay
68	to 70	Juniperus virginiana and other Junipers		
71	to 72	Quercus, Red Oak, Pink Oak and Mossy Cup Oak		
74	and 75	Cerasus		Flowering Cherry
76	16	Juniperus Cannarti		Pyramidal Juniper
77	7	Lycium barbarum		Washington Bower
78	14	Berberis Thunbergii		Japanese Barberry
79	7	Symphoricarpos racemosus		Snowberry
80	5	Callicarpa purpurea		Beauty Shrub
81	6	Ligustrum Regelianum		Regel's Privet
82	14	Deutzia gracilis		Dwarf Deutzia
83	600	Assorted Hardy Perennials and Bulbs		

PLANTING PLAN

Key No.	Quan.	Variety	Common Name
84	4	Standard Crataegus roses fl. pl.	Hawthorn
85	200	Tea and Hybrid tea Rosea, 20 inches apart	
86	1	Picea Kosteriana	Colorado Blue Spruce
87 and 88	1	Retinispora filifera aurea	Japanese Golden Cypress
89	1	Juniperus Pfitzeriana	Spreading Juniper
90	1	Taxus cuspidata	Japanese Yew
91	2	Buxus pyramidalis	Pyramidal Box
92	7	Acer saccharum	Sugar Maple
93	1	Abies Veitchii	

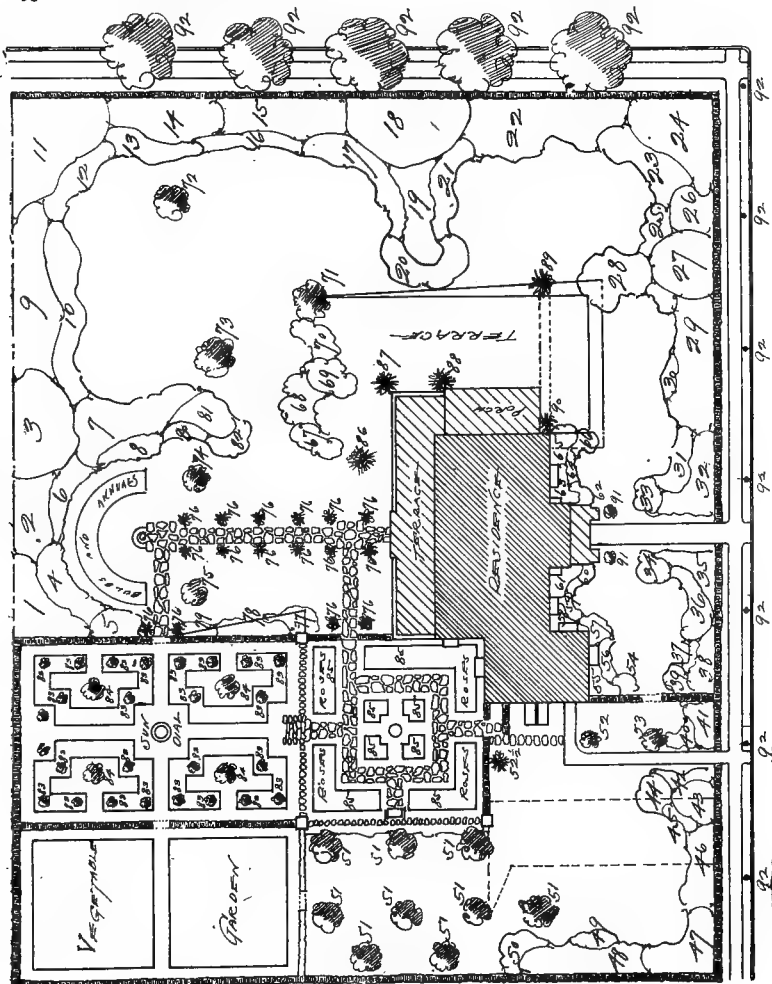

Plan for a property of two acres. (See Planting Key on page 28)

CHAPTER III

Hedges and Fences

MUCH has been said of late regarding the wholesale manner in which fashion has dictated that every sort of fence and boundary should be removed. The word "garden" carries with it the meaning of enclosure. We in America are getting more and more away from having even our own dooryards to



Moderate sized country house facing east. It is on a slope, which is terraced. Liberal use is made of evergreens, including Rhododendrons. A road which isn't seen in the picture, winds past the front to the north (or right hand) side of the house

ourselves. Often we cannot tell where our province leaves off and the next begins. Marauders have full sweep. There is something homely about an enclosure with some degree of privacy. Because the city is abolishing everything for such privacy we wish at times to be by ourselves, and the country is chosen. Hedges or boundaries need not be emphasized, but let us not fear to put up some little shrubbery to shield us from the public gaze, and let us enclose parts of our own domain by a low hedge. Formidable fences are not advocated, but private areas bounded by hedges are always interesting.

Low hedges of the graceful *Ligustrum Regelianum* (Regel's Privet) are very handsome; or *Berberis Thunbergii*, with its red berries and Fall coloring; or the Japanese Quince, which must not be trimmed too closely if it is to appear pretty, with its deep red or pink flowers; or the Siberian Dogwood (*Cornus alba sibirica*).



Ungainly and displeasing. The grass is unkempt; the shrubs in front are wild growths that have sprung up of their own accord, yet the situation is ideal for gardening

For an evergreen hedge, nothing has been used more than Box. This is not hardy in all parts of the North, and is a very slow grower. It is almost the only plant to use except the Dwarf Japanese Yew (*Taxus cuspidata* var. *brevifolia*). It is very hardy and has hardly become known as yet in American gardens. *Ilex crenata microphylla* and *Euonymus radicans* can also be used.

Taller hedges are best made of the Ibota (*Ligustrum Ibota*) and common Privet (*Ligustrum vulgare*). The California Privet (*Ligustrum ovalifolium*) should not be planted in the Northern States; it freezes down too frequently so that it never attains any character. The Golden Privet is very bright and cheery, but hard to buy. The Buckthorn (*Rhamnus cathartica*) is a useful and not easily penetrable hedge. Hedges of Hemlock, Arborvitæ and Norway Spruce are



Rough, neglected surroundings—no planting attempted, no lawn, no shrubs, no flowers. How much the dwellers miss!

substantial when the taller ones are wanted. The Hemlock is the finest, since each plant merges into the next admirably.

A common blunder with hedges is to locate them too near walks so that they are injured by the constant brushing against them by people as they pass.

The soil should be prepared as for ordinary shrub planting. At present, the practice is not advised of placing two rows of shrubs for a hedge. The hedge can be kept cleaner of weeds and its growth is more symmetrical by planting only one row. It is advisable in setting a hedge to set the plants so that they touch at planting time. This means that the smaller plants, as Barberry, will be planted six to eight inches, and Privets ten to twelve inches apart. The soil must be thoroughly firmed around the plants at setting.

For pruning hedges, see chapter on pruning.



Work-people's dwellings near a factory. Happily somebody had the sense and good taste to clothe them with *Ampelopsis* and *Clematis*. The hedges of *Rugosa* Roses and plantings of other shrubs help to make the row comfortable, agreeable and home-like. Neatness is exhibited also in the grass plots. A very fair example for similar little colonies

Wooden (board) fences are employed between the smaller suburban yards, or it may be spar fences. These can be covered with Rambler Roses and other climbers. By proper pruning and thinning these won't get too heavy or cumbersome, and can readily be held back if the fence requires to be painted. Iron fences and galvanized or alumina plated fences are also used, the latter being strong and durable. Or again, a soil bank can be thrown up and be planted with trees and shrubs. The consideration of brick and stone walls hardly comes within the scope of this book.

CHAPTER IV

Trees and Shrubs

TREES

TH**ERE** is nothing more exalting than a great tree, and as Prof. Bristow Adams suggests: "The wonderful thing about the tree is that it keeps growing year after year and thus takes its place as the oldest living thing." As such we should revere it as a choice heritage, or if we find no trees growing on our land we should plant them for our posterity. A story indelible in the mind of the writer is that of a man called "Johnny Applesseed," who was very fond of Apples, and eating them as he walked he sowed the seed by the wayside. Years later people gathered the fruit of his pleasant labor. His life stands a great lesson in this day of needed reforesting of our devastated and ill-cared-for woodlands. Some of us can never plant a forest, but we can start the growth of several trees that may become perfect.



Same place as the one shown below, but with the shrubs removed

Not only should we plant trees, but we should care for them properly, prune and spray them intelligently. Because we may be neglectful one year, an Elm which has grown for a hundred years may be destroyed by the Elm beetle. We owe it to the community to try to save it. Do not allow the removal of trees by telephone companies or when excavating, without careful thought.

TREES FOR SHADE AND SHELTER UPON THE LAWN. The trees each of us would choose for our lawn decoration would most probably be those for which we have a personal liking. From childhood, we reverence a certain type of tree either because of fruits it bears, or its shape or its Fall colors. Nothing compares with the American Elm for restful beauty; especially so are the forms which are vase shaped and with foliage to the soil. The Tulip tree holds a strong appeal; the foliage is glossy, and the tight bark of older trees is beautiful. What is more effective than a huge Red or Black Oak with its strong and often crooked branches? Such a tree is in mind which takes up as much room as the little



Shrubs dotted on a lawn, leaving no sweep of view

Dutch house beneath it. Specimen Beeches, which are branched to the soil, though usually very formal in shape, are yet graceful. All persons progressive enough to read garden books, of course, would never spoil the beauty of the lawn trees by removing the lower limbs. It is peculiar, but many persons have not realized that if they prune off the limbs of a young tree it is very difficult ever to get new branches to start out from below again. The white Birch is graceful and girlish, but it is being attacked by a borer to such an extent that it is best not to advise planting it.

Besides the large trees, there are a great number of very useful smaller growing trees. There are several Crab Apples which are most excellent; one of the prettiest with double pink flowers is Bechtel's Crab, and a very handsome variety of Japanese Crab has deep red buds which on opening become white or a blush pink. The beauty of this tree in bloom is overpowering. Many of the Thorn Apples are handsome. They require a great deal of water and should not be planted where they can rob the perennials. A tree known but little and valued because of its very superior Autumn tints, is the Sorrel tree (*Oxydendron*). For Autumn effect, some Japanese Maples are excellent, as also is the Sweet Gum. One must avoid great spots of color in trees, for too great an abundance of purple Plums and Beeches, Japanese Maples and variegated yellow forms are going to destroy the dignified beauty of your garden.

EVERGREENS. We have not spoken a word about the evergreens. They are ever beautiful and ever graceful as well as evergreen. To no other trees does the injunction to let the lower limbs grow apply so much as to the evergreens. How much different are our tastes! In the evergreens some of us enjoy the informal, look-as-though-they-were-weather-beaten sorts. We enjoy Pines which have had some accident when young and have four or five trunks instead of one. We admire the Austrian Pine at any stage of its growth; the Pitch Pine when it becomes old and picturesque, with its sturdy short branches, and persistent globular cones, and the long, heavy foliage of the Red Pine. Others will much prefer the conical Firs and Spruces. The greatest beauty is seen in a perfect specimen of Norway or Oriental Spruce, branching to the soil and hung with huge cones; or perhaps the blue-green or grayish-green foliage of the Silver Fir is a great attraction, for this is one of the best beautiful trees of this type which can be grown. The latter is prettier than the Colorado Blue Spruce, which is planted far too much; it is a trifle too bright and has such stiff foliage that, in the minds of many, it does not compare with the softer and more graceful foliage of the Silver Fir.

Among the smaller growing evergreens we have the Japanese

Cypresses or *Retinisporas*, the foliage of which is graceful and the habits charming. The *Arborvitæ*, especially the Chinese species, are very handsome. For mass planting, the Hemlock is admirable; the foliage is most dainty; the trees merge into one another very nicely. Because of the handsome cones and the soft foliage, the Douglas Fir is to be admired. The Rocky Mountain forms are hardy, but the Coastal Plain form is not in the East. The Irish Juniper is most slender and vertical. Winter snows often get into this tree, spreading the branches and often breaking them. It would seem well to tie the trees up a little before Winter.

STREET TREES. All trees are not adapted for street planting. Some of them are too rapid growing, so that the wood is soft and the trees short lived. The Poplars well illustrate this class. They are miserable trees, for they break easily in storms; their roots enter the sewer pipes and they heave up sidewalks. Cities which have good forestry control are making the planting of this tree a misdemeanor. The soft Maple, the Sycamore Maple, the European Ash, Birches, Willows, Tulip Tree and the Box Elder come in this class. Other trees are objectionable because their attractive fruits and flowers are apt to be picked. In this case, the form of the tree is usually spoiled. Examples of trees of this class are Chestnut, Hickory, Horse Chestnut, Catalpa, black or common Locust, Magnolia, Dogwood, Mountain Ash. The Catalpa and Horse Chestnut are really objectionable because of their mussy habit of dropping flowers, young fruits or bud scales.

Good street trees stand adverse conditions, are more or less free from insects and diseases and furnish shade, but not too dense; they are long lived, and those which are arching are preferred by many to the more formal globular forms. Prof. Curtis of Cornell University advises the following trees for various widths of street.

For narrow streets (less than sixty feet between buildings), the trees should be planted alternately and spaced forty feet apart and the following may be used :

PIN OAK. A tree of medium size, more slender than most Oaks; one of best trees for narrow streets. Especially likes moisture, but will adapt itself to other conditions.

GREEN ASH. A small but hardy tree. It is the species *Fraxinus pennsylvanica*, var. *lanceolata*.

HONEY LOCUST (*Gleditsia triacanthos*). A very hardy tree; grows well in a variety of soils. The foliage is light and does not cast a dense shade. It is the Locust with the huge thorns.

TREE OF HEAVEN (*Ailantus glandulosa*). This tree is excellent for dry paved tenement sections of cities, enduring smoke and dust. The wood is brittle and the trees are dangerous when they are old.

For medium width streets (from sixty feet to eighty feet between buildings), the trees should be spaced forty feet apart. The following may be used :

ORIENTAL PLANE. An excellent street tree. It is of rather rapid growth; stands smoke.

NORWAY MAPLE. A drought-resistant and smoke-enduring, symmetrical and tough tree. It is too low-headed for streets with wires.

MAIDENHAIR TREE, or GINKGO. When young, this tree is very erect, but when it becomes older, the head broadens out.

For wide streets (over ninety feet between buildings), the trees should be spaced fifty feet apart, and where possible they should be planted on the lawn six feet inside the sidewalk line. This should be agreed upon and carried out uniformly by all property owners on the street. The following may be used:



A good garden composition. A free use is made of Pine trees and conifers as well as deciduous subjects. The arch of Roses, the airy summerhouse, the flower-fringed water pool and other features here are well placed and excellent

AMERICAN ELM. The best of all street trees when given room, good air and water. The tree grows 80 to 100 feet tall.

RED OAK. It cannot grow in pavements, but is very well adapted to wide suburban streets, where it stands poor and dry soil, but does not thrive in wet situations.

SUGAR or HARD MAPLE. An excellent tree needing moisture and suffering from heat, smoke and dust. It should only be used on the wider streets.

PLANTING TREES. The best method of ascertaining how to plant a tree properly is to observe the carefully prepared sketches. More can be seen in these pictures than can be expressed in words. The main

object is to have a hole large enough for the roots, and to get the tree just a little deeper than they stood in the nursery. An important necessity for newly set trees is a support. The wind whips the tree about and the young roots are easily loosened. Stakes should be set deeply and be a real support; or the tree may be supported by wires, taking care that these wires are in contact with rubber packings on the branches so that they are not girdled. The proper staking of trees is a very important matter.

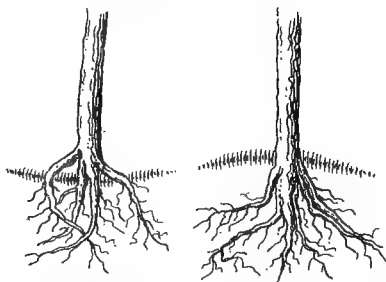

Wrong method of planting. In the left hand picture the tree is obviously placed too high, and its roots are also cramped. In the other case the soil is mounded up too much, thus shedding off the water

SHRUBS

For the garden, whether large or small, some shrubs are necessary. They not only furnish a good foliage background, but some are very beautiful for their flowers, which are not only decorative in a landscape way, but are highly useful for cutting. They are the proper sort of plants for hedges and for screening unsightly objects.

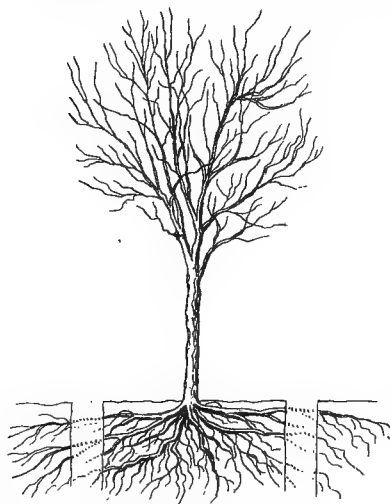

This tree is correctly planted, each root well spread, and neither too deep nor too high. The dotted lines show where to dig to lift it

In establishing a new planting of shrubs give the soil good, deep preparation and spade in a liberal supply of stable manure and bone-meal. Let the planting be done either in the Spring or Fall. The Fall is preferred because there is less work which is urgent at that time of the year. They should have an opportunity to get their roots established before permanent freezing. In the Spring they should be set out before

May. After the growing season begins they are somewhat weakened by not being in the soil; besides, they should be well established before the hot weather arrives. To make a good effect the shrubs should be planted almost twice as closely as they should stand permanently. It is, therefore, advised to plant only part of your place the first year and plant it thickly. By the time you are ready to plant the other part you can draw upon the first planted beds for your stock. Gardens, unlike houses, can be changed and rearranged easily. Shrubs rarely suffer from transplanting if done at the right time and watered thoroughly.

PRUNING. See chapter on Pruning. The proper time of pruning is very important

CERTAIN OF THE BEST SHRUBS. For general screen planting few shrubs compare with the Lilac. It is exceedingly hardy and the flower is always a favorite. If the good varieties of Lilacs are used, the individual blooms will be important. The only way to grow good, large blooms is to keep all the suckers from the base of the plant removed; plants so treated will resemble trees. Here is a selection of varieties of *Syringa vulgaris*, the common garden Lilac (late May), by Prof. Ralph Curtis:

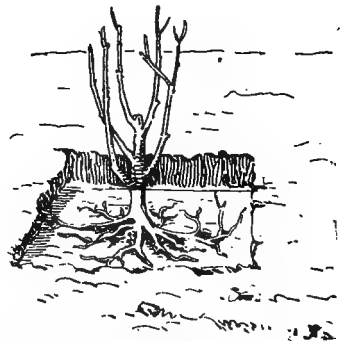
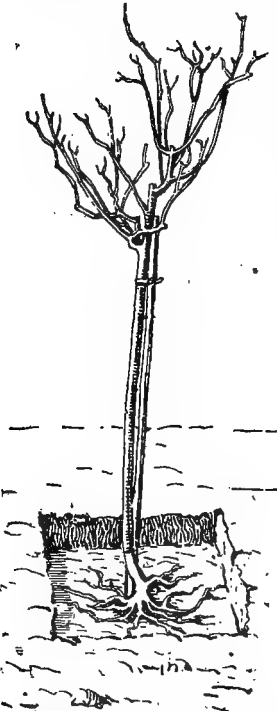

A planting diagram of the National Rose Society. The whitened parts of the stem indicate the depth to which a standard, and a dwarf Rose should be planted; that is, the same depth as they were when in the nursery

NOTE.—*Indicates a good selection; **Indicates first choice. Colored varieties should be separated by white varieties unless one is sure the colors will harmonize.

White

Early single. **Marie Le Graye, Vestale Bertha Alexander, Virginalis.
 Medium single. Alba grandiflora, **Frau Bertha Damman, Princess Alexander.
 Medium double. *Madame de Miller (dwarf).
 Late single. Alba pyramidalis.
 Late double. Madame Lemoine, **Miss Ellen Willmot.

Pink to rosy lilac

Medium single. **Charles X (rosy lilac), Dr. Regel, Gloire de Moulins, Lilarosa, **Machrostachia, Rubra insignis.
 Medium double. Antoine Buchner, Comte de Kerchove, *Emil Lemoine, Fuerst Lichenstein, Maxime Cornu.
 Late single. Othello.

Blue to bluish lavender

Early single. **Bleuâtre, Cœrulea superba.
 Medium single. Jacques Callot, *Justi, Madame Briot.
 Medium double. Doctor Masters, **President Grèvy (semi-double), Victor Lemoine.
 Late single. Gilbert.

Deep purple-red to reddish

Early single. **Philemon.
 Medium single. *Danton, Milton, Pasteur, Uncle Tom.
 Medium double. *Le Tour Auvergne, Marechal de Bousompierre, Souvenir de L. Thibaut.
 Late single. *Aline Mocquery, **Congo, Ludwig Spaeth, Toussaint l'Ouverture.
 Late double. *Charles Joly.

Van Houtte's *Spiræa* is unrivaled for prolificacy and grace of bloom. The white clusters of bloom, however, are soon shattered by the rains and at best it does not give a very permanent flower effect. For the early Spring display there is nothing so cheery as the yellow flowers of the Golden Bell (*Forsythia*), of which there are several forms; the one known as *suspensa* is most effective when planted at the top of a wall or rock ledge and allowed to grow down. There is a road in the city of Ithaca, New York, which is most attractive in the Spring owing to its wonderful golden display from this shrub; even after flowering the foliage retains a good color. The upright forms need to be massed, as individuals are not graceful.

Excellent beds or borders are arranged, using tall shrubs, such as Red Bud (*Cercis*) and Hawthorns, at the back, with Mock Orange and *Wiegela* at the midground and edged with *Deutzia gracilis* or *Spiræa Thunbergii*; or for lower beds, the use of *Berberis vulgaris* at back with *Berberis Thunbergii* and *Mahonia* in foreground.

For a bed remaining attractive during the Winter use a few *Kerria japonicas*, which have green twigs, or *Cornus alba sibirica*, with its red twigs, both of which retain their color all Winter.

There is a great group of shrubs with beautiful foliage. None equals the graceful horizontal branching of Regel's Privet. The flowers are not very conspicuous, being white, but they are followed by attractive black berries. The dainty narrow, minute foliage of the *Spiræa Thunbergii* is excellent; the tiny white flowers coming in early May add an extra charm. In the region of central New York the tips of branches Winter-kill, so that they need to be dressed a little in the Spring.

Certain shrubs are fascinating because of peculiar flowers, seeds and bark. The Sweet Shrub, *Calycanthus*, or, as it is also called, the Strawberry shrub, is very interesting; the twigs are aromatic all Winter and the leather-petaled, dull red flowers are very individual in fragrance. Picked today they have one fragrance, perhaps that of Strawberries; tomorrow, the fragrance is more like that of Apples. The Winged Spindle-Tree (*Euonymus alata*) bears peculiar corky angles on the twigs, and a funny little orange fruit inside of a hard red husk.

SHRUBS WITH EDIBLE BERRIES. Shrubs which, though ornamental, have berries which are good to eat, are interesting not only to you, but to the birds they attract. Many persons do not know that Barberries make very good jam. This is especially good served with the Thanksgiving turkey or wild game, being appropriate as well as tasty. Goumi or *Elæagnus longipes* produces an elongated red berry in June or July which is excellent picked from the plant and eaten. The Vacciniums, Blueberry or Huckleberry, besides being ornamental, are, as we all know, of an excellent flavor. Elderberries to some tastes make a pie superior even to Huckleberries. The red-fruited variety should not be eaten. The Nannyberry (*Viburnum Lentago*) bears a black fruit very freely. It has somewhat the flavor of Bananas. Besides, there are the Blackberries, the Raspberries and the Currants, species which are often ornamental. You may remark that you could hardly get a dish of some of these berries on the few shrubs you could plant, but nevertheless they taste good and it is very interesting to the gardener to know that some of the good-looking things may also be good to eat.

EVERGREEN SHRUBS. There are a number of interesting evergreen shrubs. None is so popular as the Rhododendrons. But these like a soil free from lime, and if you live in a limestone region, before you attempt to grow them dig out the beds to a depth of three feet, filling in with good wood-soil or leafmold. Give good drainage by putting a layer of ashes at bottom of the trench. The secret of success with Rhododendrons is to keep the roots cool and moist. In Winter they should be deeply mulched with leaves. In Summer they must have an abundance of water. In some Rhododendron plantations a "syringe" of water plays upon the beds continually. They like shade usually, but often by a proper choice of plants which have been growing in the sun, they succeed just as well in the sun. In Winter a framework of burlap gives the protection from the wind. They should always be massed, for Rhododendrons, unless in beds by themselves, are either apt to receive too much fussy care or none at all. The best early varieties are *R. roseum elegans*, an old rose colored variety, and *R. everestianum*, a lavender, both flowering in late May. Then in early

June we have *album elegans*, a large white; Mrs. C. S. Sargent, a pink; *caractacus*, a red; *purpureum*, a purple; and Lady Grey Egerton, a silvery gray lavender.

There are a number of Azaleas which are most brilliant, the best being *Azalea pontica* and *A. mollis*, in the various colors, and *Azalea amœna* which is a superb claret pink.

A shrub which has proven perfectly hardy is the Japanese Holly (*Ilex crenata*, var. *microphylla*); it grows about four feet tall and is



A garden scene in Summer. In this bosky dingle are shrubs of many kinds and tall umbrageous trees. The Yuccas are grouped for the season only, likewise the Bananas. *Filamentosa* is the hardiest of the Yuccas

excellent. The American Holly is hard to transplant, but seems hardy as far north as Cape Cod. The leaves should be removed and plants transplanted in the Spring. The Mountain Laurel (*Kalmia latifolia*), which has been proposed as the national flower of the United States, is, perhaps, the best evergreen shrub grown; it succeeds a little easier than Rhododendrons and without protection of the tops retains a good appearance all through the Winter. The Mahonia, or Oregon Grape (*Mahonia aquifolium*), is an excellent shrub; it succeeds perfectly if planted so that leaves are shaded from Winter sun. It surely looks fresh, green and glossy in Midwinter.

GROUND COVER AND LOW GROWING SHRUBS. Oftentimes one wishes a ground cover of very low shrubbery in the shade, and few plants are as valuable as *Pachysandra terminalis* for this purpose

Vinca minor is also useful; it is cheaper, but the leaves are not so large. The common Juniper (*Juniperus communis adpressa*) is also valuable; it requires sun. All of these three plants are evergreen. Several excellent low deciduous shrubs for ground cover in the sunshine are the aromatic dwarf Sumach (*Rhus aromatica*), Yellow Root (*Xanthorrhiza apiifolia*), which spreads rapidly by underground stems; it does not thrive in limestone soils. Sweet Fern (*Myrica asplenifolia*) will thrive on the driest, sunniest slopes; Memorial Rose (*Rosa Wichuriana*) is excellent, bearing numerous white flowers in late June or July; English Ivy and *Euonymus radicans* var. *vegeta* may also be used. The English Ivy, though very beautiful, is often rather tender; it enjoys a moist soil and shade in Winter.

LOW GROWING SHRUBS FOR VARIOUS PURPOSES*

Deciduous.

Cotoneaster horizontalis. For edging; semi-evergreen.

Daphne Mesereum. Flowers light purple, appearing in early April before the leaves.

There is a white variety. An erect shrub 3 feet high, with stout branches, which are flexible and leathery like those of Leatherwood (*Dicra palustris*).

Hypericum Buckleyi. Forms neat, compact mats. The earliest of the *Hypericum*s. Flowers yellow, early July.

Lonicera spinosa [—*L. Albertii*]. Has slender twigs and narrow linear leaves. Flowers pink, late May. Plant low, from 1 to 2 feet high.

Rhododendron canadense (*Rhodora*). A slender shrub, 2 feet high. Is good in a rock garden with a ground cover of the following species. Flowers rosy purple, appearing before the leaves in late April and early May.

Vaccinium pennsylvanicum (Early Low Blueberry). From 6 to 12 inches high. Should make good dwarf edging. Flowers white in early May.

Evergreen.

Arctostaphylos Uva-Ursi (Bearberry). A creeping, vine-like shrub with small leaves, abundant in Canada, forming broad mats over rocky ledges and slopes. Berries red.

Bryanthus (See *Phyllodoce*).

Calluna vulgaris (Scotch Heather). Flowers pink, July and August. There is a white variety.

Chimaphila umbellata (Prince's Pine, or Popsissewa). Somewhat resembles *Pachysandra*, *Cotoneaster adpressa* and *C. microphylla*. Resemble *C. horizontalis*, mentioned above, but are more dwarf and evergreen. Both have a neat habit and glossy foliage. May not be hardy everywhere, but should be tried for low, stiff edging.

Daphne Cneorum (Garland Flower). Dense and compact. Pink flowers in May. Excellent for edging. From 6 to 12 inches high. Twigs flexible and leathery, as those of *D. Mesereum*, described above.

Dendrium [—*Leiophyllum*] *bucifolium* (Sand Myrtle.) A dense shrub, to 3 feet high. There is a low, tufted form, var. *prostratum*. Flowers white or bluish in May.

Empetrum nigrum (Black Crowberry).

Erica carnea (Hardy Spring Heath.) Pink in April and May. From 6 to 12 inches high, *Gaultheria procumbens* (Wintergreen, or Checkerberry.) Red berries. Leaves have good flavor.

Gaylussacia brachycera (Box Huckleberry). Very dwarf and compact.

Juniperus chinensis var. *procumbens*. An excellent low Juniper.

Juniperus Sabina var. *tamariscifolia*. A very neat Juniper for edging.

Leiophyllum. (See *Dendrium*.)

Lycopodium obscurum (Ground Pine). A native Club Moss related to Trailing Christmas Green (*L. complanatum*), but with stems erect and treelike, to 12 inches high.

Mitchella repens (Partridge Berry). This and the preceding are two creeping, vine-like plants excellent for the rock garden. Moneywort has bright yellow flowers in June, and Partridge Berry has handsome red berries all Winter.

Pachysandra terminalis.

*List revised from Curtis, Cornell Bulletin 361.

Phyllodoce [—*Bryanthus*] *cærulea* (Mountain Heath). A low alpine shrub, from 3 to 6 inches high. Flowers pinkish purple, July.

Potentilla tridentata. Plant from 4 to 8 inches high, forming thick mats. Foliage bronzing in Winter. Flowers white, Strawberry-like.

Rhododendron [—*Azalea hinodegira*.] A low shrub, better than *R. amæna*, leaves large, and flowers a brilliant red. Late May and early June.

BUSHES FOR WET PLACES. When planting grounds it is often desired to obtain shrubs for planting in wet places, some that will attract either by their flowers, berries or other features.

There is a shrub which always comes to mind when this subject is thought of, the *Clethra alnifolia*, because of the profuseness of its flowering and the fragrance of its flowers. It blooms in Midsummer or later, the bush usually covered with panicles of white flowers of peculiar fragrance. In its wild state it is usually found on the banks of streams, or otherwise near water, so that it is well suited when planted in similar positions. There is another native *Clethra*, the *C. acuminata*, but the *alnifolia* is the best for the purpose.

The White Fringe, *Chionanthus virginica*, is at home in a wet place. It is wild in situations which are almost under water at times. This has white flowers, too, but they come early in Spring with the leaves, and because of the fringelike appearance of the flowers the shrubs are called Old Man's Beard in some portions of the South.

Another shrub of great merit is the *Magnolia glauca*, the one of our swamps and low grounds, which is almost evergreen, and famous everywhere for the fragrance of its flowers. It is often found side by side with the White Fringe. Both of these, though often listed as shrubs, grow to the size of a small tree in time, if kept to one shoot when young.

The Bayberry, *Myrica cerifera*, is a good wet position shrub, delighting in damp ground. When grown in groups where one shelters the other they are somewhat evergreen in character. The flowers are greenish white and small, making no display to attract, but the berries when ripe are covered with a white, waxy substance, making the clusters of them conspicuous and attractive.

Found in similar situations to the above mentioned shrubs is the *Azalea viscosa*, a species renowned for the fragrance of its blooms. The flowers are pure white, expanding in July and August. It is one of the most admired of Azaleas, yet not common in cultivation.

In *Vacciniums* there is a beautiful species for wet ground, the *V. corymbosum*. It delights in such situations. In Spring it presents to view beautiful clusters of white flowers. Edible, dark colored berries follow; later on, with the approach of Autumn, the foliage becomes of a lovely orange bronze color. It is then almost foremost of all the foliage trees and shrubs famous for their Autumnal display of color.

These six shrubs would give one a good start in planting a wet place, but they do not exhaust the list; many more could be added.

FLOWERING THE BRANCHES OF SHRUBS INDOORS. Many persons know that Pussy Willow when brought into the house opens very nicely, but few avail themselves of the pleasures in store for them by cutting the branches of a great many shrubs and trees early in the Spring or late Winter, and bringing them indoors. The nearer Spring the sooner will the buds pop into bloom. Shrubs should be chosen which bloom upon wood of previous season and almost all early Spring blooming trees and shrubs can be used. The shoots may simply be placed in water and allowed to start naturally, but if they are placed in a basement and sprayed several times a day with warm water they will open much more quickly. The forced branches lend themselves to "Japanesy" arrangements and have a light grace which is very charming.

The following shrubs and trees are useful for treatment this way:

Bladder Senna (<i>Coletea arborescens</i>). Light yellow.	<i>Kerria japonica</i> . Yellow.
Cornelian Cherry (<i>Cornus Mas</i>). Yellow.	Mock Orange (<i>Philadelphus</i>). White.
<i>Deutzia gracilis</i> . White.	Parkman's Crab (<i>Pyrus Halliana</i>). Deep pink.
Flowering Almond (<i>Prunus triloba</i>). Pink.	Pea Tree (<i>Caragana frutescens</i>). Yellow.
Flowering Currant (<i>Ribes aureum</i>). Yellow.	Pearl Bush (<i>Exochorda grandiflora</i>). White.
Fragrant Honeysuckle (<i>Lonicera fragrantissima</i>). White and pinkish.	Pussy Willow (<i>Salix discolor</i>). Gray.
Golden Bell (<i>Forsythia suspensa, viridissima, Fortunei</i>). Forces very quickly. Yellow.	Forces very quickly.
Hazle (<i>Corylus americana</i>). Brown.	Red Bud (<i>Cercis canadensis and japonica</i>). Pinkish lavender.
Japanese Cherry (<i>Cerasus rosea plena</i>). Pink.	Shad Bush (<i>Amelanchier canadensis and botryapium</i>). White and pink.
Japanese Quince (<i>Cydonia japonica</i>). Pink and red, very beautiful.	Thunberg's Spiræa (<i>Spiræa Thunbergii</i>) White, light and airy; very good.

LIST OF BLOOMING DATES OF TREES, SHRUBS AND CLIMBERS

T-TREE

S-SHRUB

C-CLIMBER

*Indicates that blooming period is likely to extend beyond the date under which it is classed.
(Revised from a list by Samuel N. Baxter)

April 1 to 15

Botanical Name	Common Name	Group	Height (ft.)	Color of Flowers
* <i>Daphne Mezereum album</i>	Mezereon Daphne	S	3	White
<i>Lonicera fragrantissima</i>	Bush Honeysuckle.....	S	6	White
<i>Cornus Mas</i>	Cornelian Cherry.....	S	15-20	Yellow
* <i>Magnolia stellata</i>	Dwarf Magnolia.....	S	5-8	White
* <i>Forsythia suspensa</i>	Weeping Golden Bell.....	S	8	Yellow
* <i>Acer rubrum</i>	Red Maple.....	T	15-100	Pink
* <i>Acer platanoides</i>	Norway Maple.....	T	100	Yellow
* <i>Benzoin æstivale</i>	Spice Bush.....	S	10-15	Yellow
<i>Spiræa Thunbergii</i>	Thunberg's Spiræa.....	S	5	White

April 16 to 30.

<i>Magnolia conspicua</i>	Yulan	T	50	White
<i>Magnolia Soulangeana</i>	Soulange's Magnolia.....	T	15	Pink
<i>Magnolia Kobus</i>	Japanese Magnolia.....	T	80	White
<i>Cerasus Avium alba, and rosea plena</i>	Double-flowering Cherry..	T	25	White, pink

<i>Cerasus Sieboldi rubra plena</i>	Double-flowering Cherry.....	T	15-25	Red
* <i>Cercis japonica</i>	Japanese Judas Tree.....	S	15-50	Pink
* <i>Cercis canadensis</i>	Red Bud.....	T	20	Pink
* <i>Andromeda japonica</i>	Japanese Fetter Bush.....	S	10-30	White
* <i>Leucothoe Catesbæi</i>	Leucothoe.....	S	6	White
* <i>Pyrus japonica</i>	Japanese Quince.....	S	3-4	White, red
* <i>Spiræa prunifolia</i>	Bridal Wreath.....	S	6	White
* <i>Citrus trifoliata</i>	Hardy Trifoliata Orange.....	S	15-20	White
* <i>Prunus (Amygdalus) Persica</i>	Flowering Peach.....	T	10-25	White, yell., pk
* <i>Prunus (Amygdalus) nana</i>	Flowering Almond.....	S	5	White, pink
* <i>Sassafras officinale</i>	Sassafras.....	T	30-60	Yellow
* <i>Amelanchier Botryapium</i>	Juneberry, or Shad Bush.....	S	25	White
* <i>Exochorda grandiflora</i>	Pearl Bush.....	S	6-8	White
<i>Ostrya virginiana</i>	Ironwood (catkins).....	T	30	
* <i>Syringa oblata</i>	Early Lilac.....	S	12	Blue
* <i>Ribes aureum and sanguineum</i>	Flowering Currant.....	S	4-5	Yellow, red
* <i>Prunus Pissardi</i>	Purple Plum.....	S	15-25	White
* <i>Corylopsis pauciflora</i>		S	2-3	Yellow
* <i>Rhus aromatica</i>	Aromatic Sumac.....	S	3-8	Yellow
May 1 to 15				
* <i>Staphylea colchica</i>	Bladder-nut.....	S	12	White
* <i>Rhodotypos kerrioides</i>	White Kerria.....	S	6	White
* <i>Kerria japonica</i>	Globe Flower.....	S	5-10	Yellow
* <i>Cornus florida and rubra</i>	Flowering Dogwood.....	T	20	White, pink
<i>Wistaria sinensis and alba</i>	Chinese Wistaria.....	C	20	White, blue
<i>Pyrus (Malus) Parkmanni (Halliana)</i>	Flowering Apple.....	T	20	Pink
<i>Pyrus coronaria, loensis</i>	Flowering Apple.....	T	20	Pink
<i>Pyrus floribunda atropurpurea and Schiedeckeri</i>	Flowering Apple.....	T	10-15	Red
<i>Magnolia Lennei and Meehanii</i>	Purple Magnolias.....	T	10-15	Purple
<i>Magnolia Fraseri</i>	Fraser's Magnolia.....	T	40	White
<i>Magnolia gracilis and purpurea</i>	Bush Magnolias.....	S	10	Purple
* <i>Æsculus Hippocastanum</i>	White Horse Chestnut.....	T	60-80	White
* <i>Æsculus rubicunda</i>	Red Horse Chestnut.....	T	20-40	Red
* <i>Xanthoceras sorbifolia</i>	Chinese Flowering Chestnut.....	S	15	White
<i>Azalea amœna</i>	Evergreen Azalea.....	S	1-8	Pink
<i>Azalea pontica and mollis</i>	Ghent and Chinese Azaleas.....	S	3-5	White, yellow
<i>Azalea nudiflora</i>	Wood Honeysuckle.....	S	5-8	Pink
<i>Azalea Vaseyi</i>	Carolina Azalea.....	S	5-8	Pink
<i>Rhodora canadensis</i>	Rhodora.....	S	2	Pink
* <i>Elæagnus longipes and umbellatus</i>	Silver Thorn.....	S	6-12	White
* <i>Cerasus Padus, pennsylvanica and pumila</i>	Bird and Dwarf Cherries.....	T	10-15	White
<i>Cratægus coccinea</i>	White Thorn.....	S	15	White
<i>Caragana arborescens and pendula</i>	Siberian Pea.....	S	6-8	Yellow
<i>Halesia tetraptera</i>	Silver Bell, or Snowdrop.....	S	20	White
* <i>Berberis vulgaris, purpurea and Thunbergii</i>	Common, Purple and Japanese Barberry.....	S	4-6	Yellow
<i>Asimina triloba</i>	Pawpaw.....	T	10-40	Brown
<i>Akebia quinata</i>	Akebia.....	C	12	Purple
* <i>Lonicera grandiflora rosea and Morrowii</i>	Bush Honeysuckle.....	S	6	White, pink
<i>Mahonia aquifolia</i>	Oregon Grapes.....	S	2-4	Pink
* <i>Paulownia imperialis</i>	Empress Tree.....	T	40	Purple
<i>Pavia rubra</i>	Dwarf Horse Chestnut.....	T	5-7	Red
* <i>Viburnum Opulus sterilis</i>	Common Snowball.....	S	8	White
* <i>Viburnum tomentosum</i>	Single Japan Snowball.....	S	6-8	White
* <i>Viburnum Sieboldi</i>	Siebold's Snowball.....	S	6	White
* <i>Viburnum Lantana</i>	Wayfaring Tree.....	S	10-15	White
* <i>Robinia hispida rosea</i>	Rose Acacia.....	S	4-5	Pink
* <i>Weigela rosea and candida</i>	Diervillas.....	S	4-5	White, pink
* <i>Deutzia Lemoinei and gracilis</i>	Dwarf Deutzia.....	S	3-5	White
<i>Daphne Genkwa and Cneorum</i>	Daphne.....	S	1	Pink

* <i>Calycanthus floridus</i>	Sweet Shrub	S	3-5	Reddish brown
* <i>Sorbus Aucuparia</i>	Mountain Ash.....	T	30-40	White
* <i>Fraxinus Ornus</i>	Flowering Ash.....	T	25	White
* <i>Genista scoparia</i>	Scotch Broom.....	S	3	Yellow
* <i>Syringa vulgaris</i> and <i>alba</i>	Common Lilac.....	S	12-15	White
* <i>Syringa rothomagensis</i> (<i>chinnensis</i>).....	Rouen Lilac.....	S	10-12	Blue
* <i>Syringa</i> , French named varieties.....	Improved Single and Double Lilac.....	S	10-12	White, pk., etc.
<i>Sambucus pubens</i>	Red-berried Elder.....	S	6-8	White
* <i>Tamarix africana</i>	Tamarisk.....	S	15	Pink
* <i>Spiraea Van Houttei</i>	Van Houtte's Spiræa.....	S	5-6	White
* <i>Xanthorrhiza apiifolia</i>	Yellow Root.....	S	10-20	Brown

May 16 to 30

<i>Azalea calendulacea</i>	Flame Azalea.....	S	4-10	Red
<i>Staphylea trifoliata</i> and <i>Bumalda</i>	American and Japanese Bladder-nut.....	S	6-8	White
* <i>Clematis</i> Named Hybrids.....	Large-flowering Clematis.....	C		White, pk., blue
* <i>Robinia pseudo-acacia</i>	Yellow or Black Locust.....	C	80	White
* <i>Cratægus Oxyacantha</i> and <i>Paul's Scarlet</i>	English Hawthorns.....	S	15-20	Red, white, pk.
* <i>Chionanthus virginica</i>	White Fringe.....	S	20-30	White
<i>Nevisia alabamensis</i>	Snow Wreath.....	S	3-6	White
* <i>Laburnum vulgare</i>	Golden Chain.....	T	20	Yellow
* <i>Rosa rugosa</i> and <i>alba</i>	Japanese Roses.....	S	3-5	White, pink
* <i>Rhododendron</i> hybrids.....	Named Hybrids.....	S	6-12	White, pk., red
* <i>Viburnum plicatum</i>	Japan Snowball.....	S	6-8	White
* <i>Syringa persica</i> and <i>alba</i>	Persian Lilacs.....	S	5-10	White, blue
<i>Syringa Emodi</i> (<i>villosa</i>).....	Lilac.....	S	8	Pink
<i>Syringa pubescens</i>	Lilac.....	S	6	White
<i>Cerasus serotina</i>	Wild Cherry.....	T	80	White
<i>Spiræa Reevesiana</i>	Reeves' Spiræa.....	S	4	White
<i>Cornus alba</i>	Red-stem Dogwood.....	S	8-10	White
* <i>Viburnum Opulus</i>	High Bush Cranberry.....	S	12	White
* <i>Viburnum prunifolium</i>	Sheepberry.....	S	15	White
<i>Photinia villosa</i>	Photinia.....	S	15	White
* <i>Liriodendron tulipifera</i>	Tulip Tree.....	T	150-190	Yellow
<i>Magnolia tripetala</i>	Umbrella Tree.....	T	40	White
* <i>Weigela Eva Rathke</i>	Crimson Diervilla.....	S	5-6	Blue
<i>Wistaria multijuga</i> and <i>alba</i>	Japan Wistarias.....	C		White, purple
* <i>Styrax obassia</i>	Storax.....	T	30	White
* <i>Stephanandra flexuosa</i>	Stephanandra.....	S	5	White
* <i>Philadelphua coronarius</i>	Mock Orange.....	S	8-10	White
* <i>Philadelphus Lemoinei</i>	Lemoine's Mock Orange.....	S	3-6	White

June 1 to 15.

* <i>Bignonia capreolata</i>	Trumpet Vine.....	C	50	Yellow
* <i>Hydrangea scandens</i>	Climbing Hydrangea.....	C	80	White
* <i>Lonicera Halleana</i>	Hal's Honeysuckle.....	C	15	White, yellow
* <i>Lonicera sempervirens</i>	Coral Honeysuckle.....	C	30	Red
<i>Robinia viscosa</i>	Clammy Locust.....	T	30-40	White
<i>Gleditschia triacanthos</i>	Honey Locust.....	T	70-140	White
<i>Andromeda</i> (<i>Pieris</i>) <i>Mariana</i>	Stagger-Bush.....	S		White
<i>Halesia diptera</i>	Silver Bell, or Snowdrop.....	S	30	White
<i>Cladrastis tinctoria</i>	Yellow Wood.....	T	30-40	White
<i>Cratægus crus-galli</i>	Cockspur Thorn.....	S	15-20	White
<i>Kalmia latifolia</i> and <i>angustifolia</i>	Mountain Laurel.....	S	5-8	Pink
<i>Syringa pekinensis</i>	Chinese Lilac.....	S	15	White
<i>Syringa Josikæa</i>	Lilac.....	S	12	Purple
<i>Magnolia acuminata</i>	Cucumber Tree.....	T	90	White
<i>Magnolia macrophylla</i>	Broad-leaf Magnolia.....	T	50	White
<i>Magnolia glauca</i>	Sweet Bay.....	T	10-12	White
* <i>Deutzia crenata</i> and <i>Pride of Rochester</i>	Tall Deutzia.....	S	6	White, pink

* <i>Ligustrum Regelianum</i> and <i>vulgare</i>	Regal and Common Privet.....	S	8-10	White
<i>Viburnum dentatum</i>	Arrow-wood.....	S	15	White
<i>Viburnum acerifolium</i>	Maple-leaved Viburnum.....	S	6	White
<i>Styrax japonica</i>	Japanese Storax.....	S	30	White
<i>Stuartia japonica</i>	Stuartia.....	S	50	White
<i>Pterostyrax hispida</i>	Wistaria Tree.....	T	25	White
* <i>Sambucus racemosa</i> and <i>laciniata</i>	Elderberry.....	S	10	White
<i>Rosa multiflora</i> and <i>rubiginosa</i>	Japanese and Sweet Brier Rose.....	S	10-12	Pink
<i>Colutea arborescens</i>	Bladder Senna.....	S	10-15	Pink
* <i>Cornus paniculata</i> and <i>sericea</i>	Cornel and Silky Dog- wood.....	S	5-8	White
<i>Wistaria frutescens</i>	Native Wistaria.....	C	30-40	Blue
<i>Wistaria magnifica</i>	Native Wistaria.....	C	30-40	Blue
<i>Physocarpus (Spiræa) opulifolia</i>	Nine Bark.....	S	9-10	White
* <i>Spiræa Billardi</i>	Billard's Spiræa.....	S	5-6	Pink
* <i>Amorpha fruticosa</i> and <i>canes-</i> <i>cens</i>	False Indigo and Lead Plant.....	S	10-15	Blue
* <i>Ceanothus americana</i>	Jersey Tea.....	S	2-3	White
<i>Gymnocladus canadensis</i>	Kentucky Coffee.....	T	100	White
June 16 to 30.				
* <i>Hydrangea quercifolia</i>	Oak-leaf Hydrangea.....	S	6	White
* <i>Hydrangea grandiflora alba</i>	Hydrangea.....	S	25	White
* <i>Spiræa sorbifolia</i>	Ash-leaf Spiræa.....	S	4	White
* <i>Rosa lucida</i> and <i>setigera</i>	Prairie Rose.....	S	4-6	Pink
* <i>Rhododendron maximum</i>	Rosebay or Great Laurel.....	S	10-35	Pink
* <i>Spiræa Bumalda</i> and <i>A.</i> <i>Waterer</i>	Spiræa.....	S	2	Pink
* <i>Tilia americana</i>	American Linden.....	T	80	White
<i>Catalpa speciosa</i>	Catalpa.....	T	100	White
<i>Catalpa bignonioides</i>	Catalpa.....	T	20-50	White
* <i>Rhus Cotinus</i>	Purple Fringe or Mist Bush.....	S	10-20	Purple
* <i>Rubus odoratus</i>	Flowering Raspberry.....	S	3-6	Pink
* <i>Hydrangea paniculata</i> (Early flowering).....	Single Hydrangea.....	S	20	White
* <i>Hydrangea radiata</i>	Wild Hydrangea.....	S	6	White
* <i>Hydrangea arborescens</i>	Wild Hydrangea.....	S	4-10	White
* <i>Hydrangea hortensis</i>	Japanese Hydrangea.....	S	8	Pink, blue
* <i>Hydrangea japonica cærulea</i>	Japanese Hydrangea.....	S	8	Pink, blue
* <i>Yucca filamentosa</i>	Adam's Needle.....	S	5	White
<i>Azalea arborescens</i>	Fragrant Azalea.....	S	8-20	White
<i>Azalea viscosa</i>	Small White Azalea.....	S	4-8	White

DIFFERENCE BETWEEN NURSERY STOCK AND MATERIAL GATHERED FROM THE WILD. Trees and shrubs in nurseries are so cultivated and transplanted that their roots make a symmetrical growth. The roots are thus short and branching because they search equally on both sides of the root for food. In the case of forest specimens they may have to go several feet for an opportunity to get food; furthermore, the only opportunity for food may be in one direction. The roots are often very long and unbalanced, and when the trees are dug the roots are seriously shortened. The precaution in using material from the woods should be to carefully prune the tops proportionately, supply water and give extra, painstaking treatment.

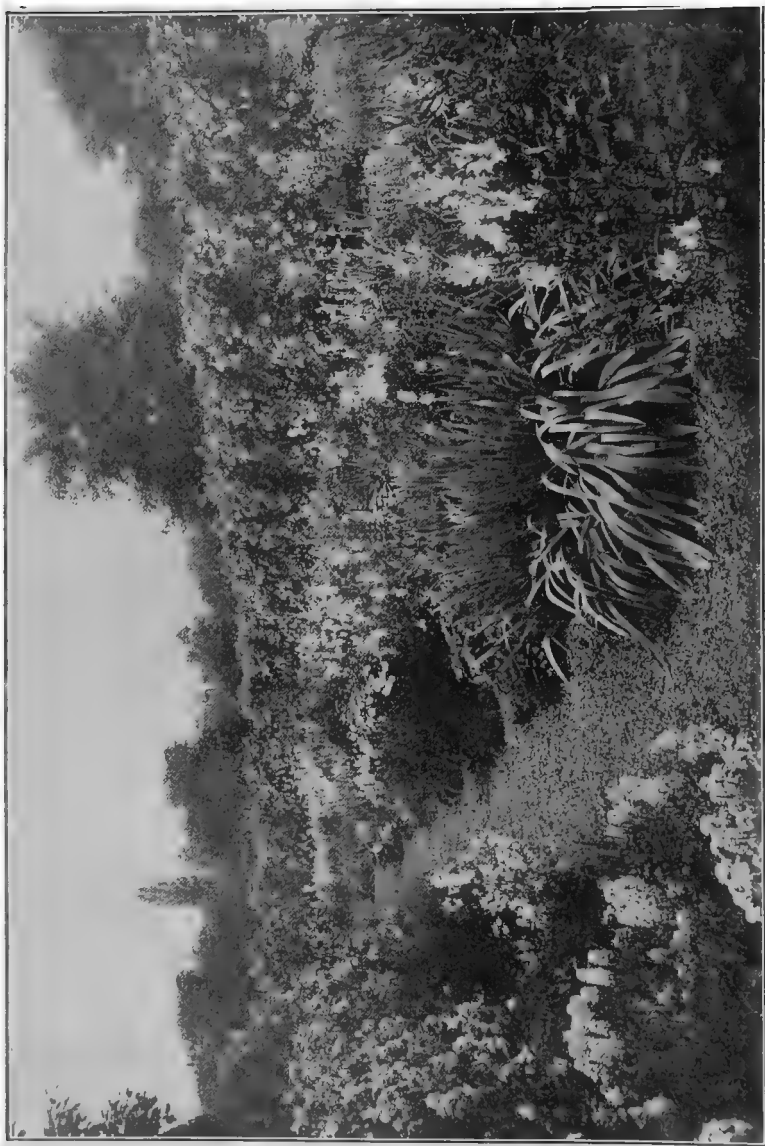

Small rectangular flower garden surrounded by arches of Roses

CHAPTER V

The Rose Garden

NO one really has a garden without some Roses. No one ever wrote about gardens without giving elaborate directions for the care of the Rose garden. All sorts of Roses are admirable—even, in a passing way, the freakish attempts at improvement such as the blue and the green Roses. Everyone has said the same thing about the location of the Rose garden, that it must be sheltered from the wind, but not surrounded, so that the air may have some circulation. It must not be in the proximity of large, water-robbing trees. It should have sun the greater part of the day. But everyone cannot locate his Rose garden in an ideal spot. A few hardy, robust kinds can be grown under rather adverse conditions. Those we mention are favorites in the North; many others can be tried in less severe climates.

BRIER ROSES. There is a huge group of shrubby or Brier Roses. On the whole, they are hardy and grow under adverse conditions. Some of them will be useful for making a hedge. If a Rose garden is to be made, plan it in the Winter and make preparations to surround it with a row of briers. No Rose is hardier, freer-blooming and more disease-resistant than the Japanese Rugged Rose, or *Rosa rugosa*. Bearing single and double, crimson, pink or white flowers, it is the first one to place in the hedge. Of charming fragrance and exquisite colors are the Penzance hybrids. Lord Penzance, an English lawyer, strove to be a success at the bar, but his name will live as a hybridizer of Roses long after people have forgotten him as a lawyer. He used the standard garden varieties of Roses and crossed them with the Sweet Brier. The result is a wonderful group of Roses with Apple-scented leaves and delicate pinkish orange, salmon and rose-pink single flowers. We must not pass over the early yellow Roses, two of which are of great importance. The earliest and lighter yellow Rose seen in every old-fashioned garden is the Persian yellow and a few days or weeks later the golden yellow variety, which is slightly tinged with red on some of the center petals, is Harrison's Yellow. The foliage of this Rose is charming; it is a pity that these two Roses bloom but once a year. One other Brier before we pass inside of the Rose plot which is to be. It is the Prairie Brier, *Rosa setigera*, and as it has a tendency to climb, should be given some sort of a trellis or fence. It blooms late and bears huge pink single flowers in large trusses.

CLIMBING ROSES. While we are speaking of a trellis for the Prairie Rose, let us also say a word for the climbing Roses. They can well be planted around our little garden or they can be trained on poles, or on the porches. The old Crimson Rambler is disliked by many people because it gets buggy and mildewed. Instead, plant Philadelphia, and surely try Excelsa. When the judges for the Hubbard Memorial Medal, given to the best Rose introduced during the last five years, decided upon Excelsa as the winner, it meant that this variety was in competition with hundreds of real, large garden Roses. Excelsa is the hardiest and most brilliant crimson climber we have. The finest light pink is without doubt the Dorothy Perkins; its clean foliage, dainty buds and abundance of bloom are highly admired. Tausendschön, or Thousand Beauties, is surely another peerless pink; the individual flowers are large and stand out prominently in the trusses; the color, which is deep pink upon opening, changing later to white, is exquisite.

Do you want a crimson single climbing Rose? This is Hiawatha. A large flowering variety, and one on which the flowers are produced very profusely, is the Christine Wright. The blooms are in small clusters and are of a clear wild-rose pink. The plants are sometimes not great climbers, but they are effective, at least at the base of the pillar. The yellows are rather too tender to be really climbers. Aglaia is beautiful, being deep golden yellow in bud. The pretty glossy foliage of many of these Roses has been derived from the Memorial Rose (R. Wichuraiana). It is very useful as a ground cover, being unexcelled for covering waste land, and trespassing upon steep banks can be successfully prevented by planting this Rose.

THE TEA ROSES. The teas really are perpetual blooming; they have exquisite colors and thick, leathery petals; besides this, their buds are pointed, but they are very tender. In other words, they are killed very easily by the frost. All of the readers who have grown Roses at all know this and remark: "Even so, we will continue to try and Winter them, for it is surely worth failing with some if only a few will grow." The snow-white Maman Cochet is large, fragrant and productive; the color becomes a trifle pink in the Fall. The buds of Lady Hillingdon, deep apricot-yellow in color, are certainly irresistible for cutting to bring indoors. Marie Van Houtte, whose color can be described either as a pink shaded cream white or vice versa, is also charming. Papa Gontier is an extra fine rich rosy red.

THE HYBRID PERPETUALS. The word "perpetual" in the title of this group is a misnomer; they are not perpetual. They have resulted from a cross between the tea, a perpetual Rose, and the various

groups of very hardy Roses, so that they are hardy, but only in rare cases do they bloom a second time. They are the vigorous varieties for general use. It is difficult to say of this class of Roses "Here is a list of the best twelve." Someone will surely remark: "Why, he does not even know the best variety of them all." Nevertheless, we all agree that

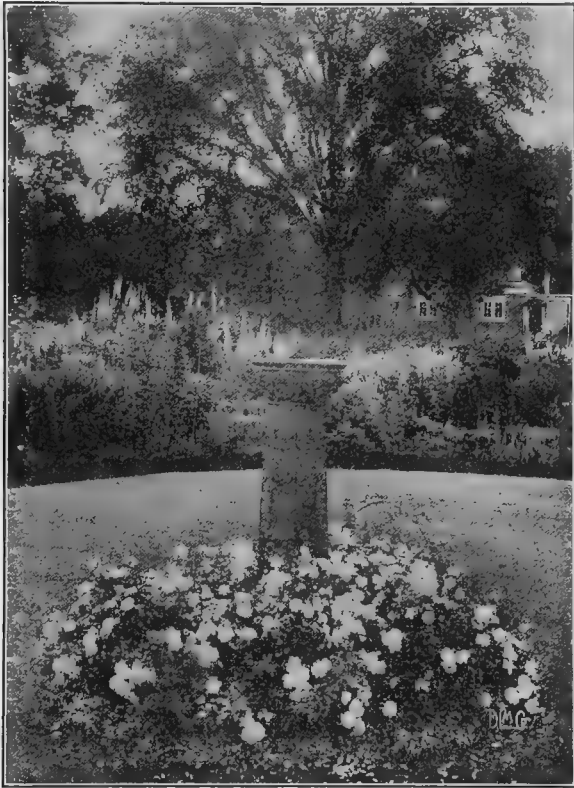

The sort of garden we all delight in. Baby Dorothy Rose and Baby Tausendschön Roses are massed around the sundial

Frau Karl Druschki is the finest white. The buds are handsome and it seems to bloom for a longer season than most. If you leave out Clio from your planting you would miss a very beautiful flesh pink. Another, and a free bloomer, is Mrs. R. G. Sharman-Crawford. A bright cherry red, a fine and rather new Rose, which is always

successful, is Gloire de Chedane Guinoisseau; perhaps an improvement upon Ulrich Brunner. Prince Camille de Rohan and Hugh Dickson are both deep velvety crimsons. Paul Neyron is the largest deep pink variety, frequently criticized for being too coarse and large. No, we have not forgotten the Jack Rose, or, as it is called in the catalogues, General Jacqueminot. You know how well it does everywhere and what a brilliant scarlet crimson it is. Another excellent strong grower and a deep scarlet is J. B. Clark. A very sweet and perfectly formed crimson carmine is the variety Captain Hayward. Mme. Masson is a hybrid perpetual which produces blooms at intervals during Summer and Fall. It is a sweet-scented crimson. Captain Christy bears a full flower which is tinted white and pale blush. Magna Charta is always admired for its vigor of growth and its bright, rosy pink flowers, which possess great substance.

THE HYBRID TEAS. In the hybrid teas are combined some of the hardiness of the hybrid perpetual as well as the more or less perpetual blooming quality, and the richness of coloring and beauty of form of the teas. The array of good varieties almost endless. Among the pinks the first that deserves to be recognized is Jonkheer J. L. Mock, that beautiful Rose, the outside of the petals of which are much lighter in color. The flowers are very fragrant and the stem erect and strong. The Killarney is rather more single than the other pink varieties, but although it opens quickly it remains for some time before shattering and is remarkable for its freedom of bloom. We cannot pass Lady Alice Stanley without recognition. The color is a lovely coral-rose, the inside a little lighter. The flowers are nearly perfect in form, color, fragrance and size. The popular Caroline Testout, which covers the streets of Portland, Oregon, is a superb bedding variety. Other fine pink varieties are Mrs. A. R. Waddell, Souvenir du President Carnot, Mrs. George Shawyer, Lady Ashtown, Dean Hole, La France. The most superb lemon white variety is, no doubt, Kaiserin Augusta Victoria.

In reds we have, first, Gruss an Teplitz, a velvety rich glowing crimson, a continuous bloomer and very sweet. A dazzling color is displayed by the variety Chateau de Clos Vougeot; it is not a strong grower but a continual bloomer. Second to none is a variety sent out as Lady Battersea. Certain rosarians have expressed a doubt as to its proper name. It is surely a superb deep, very double maroon-crimson. Laurent Carle is much lighter than the other red varieties mentioned; it is a carmine and intensely fragrant. Etoile de France bears a very double, cup-formed flower of deep crimson.

Among the salmony or coppery shades, Sunburst is one of the most successfully grown. It is superior to Mrs. Aaron Ward in color and

form. Another is Ophelia, a more decided pink salmon than Sunburst, and a variety which has been received throughout the Rose world with enthusiasm.

It is difficult to know where to place some Roses, such as the incomparable Mme. Edouard Herriot, the "Daily Mail" Rose, which is described by its introducer, Pernet-Ducher, as "coral red, shaded at the base with yellow." Another has described the color as appearing like "sunshine upon a copper-red metal." It is a splendid variety and worthy of acquaintance. One variety, a rich yellow, suffused carmine, commands the attention of all; it is Marquise de Sinety, a semi-double and very fragrant.

SOILS. The soil best suited for Roses is usually considered to be a medium heavy loam, especially for hybrid perpetuals, briars and climbers. The hybrid teas and teas prefer a lighter soil, a sandy loam. The hybrid perpetuals, hybrid tea sand teas require perfect drainage.

WIDTH OF BEDS. Roses are best planted in beds. If they are to be worked from both sides, five or six feet is wide enough and three feet is the proper width for beds against the walls. Beds that are too wide necessitate stepping in them when picking the blooms or when cultivating. Narrow beds are poor because of the intrusion of gross roots upon the nourishment which would otherwise go to the Roses. If possible it is best to reserve the Rose beds for Roses alone and not attempt growing many other things.

PREPARATION OF SOIL. Dr. Mills, the respected and efficient president of the Syracuse Rose Society, the largest amateur Rose society in the country, says that it is much better to put a fifteen-cent Rose bush in a fifty-cent hole than to put a fifty-cent Rose bush in a fifteen-cent hole. The preparation of the beds should take place in the Fall in order that the soil may have an opportunity to settle.

All Rose beds should be dug eighteen inches or two feet deep. The subsoil should be loosened and thoroughly manured, then fill in to over half the depth with manured top soil over which spread a good layer of compost. By compost we mean soil which has been thoroughly enriched by manure (one barrow of manure to three of soil) and bone-meal; this should be allowed to become thoroughly incorporated with the soil, piling alternate layers of soil and manure and allowing to remain for a few months or a year. Lastly, the top layer may be any unmanured soil. When the bed is finished it should be two or three inches above the normal level. The main secret of successful Rose growing lies in the proper preparation of the bed.

TIME TO PLANT. Spring is the best time to plant the hybrid teas and teas. If the beds have been carefully prepared the previous Fall, the soil will get into good condition quickly. The



A rustic pergola. Such pergolas can be made of peeled Oak or Pine, or of any durable branches one can get—but never Birch; that won't last beyond a season. A variety of vines can be trained here

nursery stored plants can be set out as soon as land can be worked. The pot-grown stock, if it is not crowded, can well be kept till May. These latter plants are growing and there is no necessity for giving a check by planting in open ground sooner. If the stock is frosted when received, cover the whole plant with soil until the frost is drawn out. The plants are often rather dry when received; the bark is shriveled or the roots brittle. If the whole plant is either buried in soil or placed in water before planting, it will be greatly benefited. In planting, remove all buds which may be present upon the stock and prune the broken roots. All tops should be severely cut back so that each bears three to six eyes; this is especially necessary and should not be neglected. The roots should be spread naturally and in the case of budded plants, so placed that the point budded is two or three inches below the surface of the soil. It is absolutely necessary to plant very firmly; the soil must be filled in about the roots most carefully and made solid. The hole should not be entirely filled, but the plant should be watered, after which dry soil is placed on top to prevent baking.

DISTANCE APART. Teas are best planted fifteen inches, hybrid teas eighteen inches, hybrid perpetuals three feet, and rugosas or Moss Roses four feet apart. Varieties will differ greatly as to the amount of space needed.

SUMMER TREATMENT. Keep the soil continually cultivated to retain as much moisture as possible; the stirring need not be deep, otherwise roots are injured. A mulch of lawn clippings is beneficial. Each time a new supply is ready the other will have been dried and worked into the soil. After every rain the soil should be loosened. A good syringing of water every day from the start of the season will go a long way toward keeping the insects off. The time for syringing is morning or evening. At midday it is rather injurious to the foliage. All through the Summer watch for suckers; they usually have more leaflets—five to seven, the garden varieties having but three to five. They should not be broken off but cut out down to the roots.

ROSE INSECTS. The Rose plant louse or aphid is one of the commonest pests; it appears on the young growths and reproduces with great rapidity, soon covering the plants. The tips of branches are stunted and the buds only produce deformed flowers. The daily syringe advocated elsewhere will do much to lessen the attacks, for the insects will be washed off the plants. Whale oil soap (one pound to ten gallons of water), or some nicotine preparation, will surely kill them if one keeps at them.

There are several Rose slugs. In each case they are worms which skeletonize the leaves and even attack the plant when the leaves first unfold. Arsenate of lead (one pound arsenate of lead to twenty-five gallons of water) is effective, but even water will check them if applied with force. Hellebore is good dusted on the leaves; it should first be diluted to half its weight with flour or plaster.

The leaf hoppers can be controlled by spraying with tobacco extract on under side of leaves. The Rose leaf roller can be controlled with arsenate of lead. There is also the Rose scale, which can easily be washed from the canes with corrosive sublimate or on a large scale sprayed with lime sulphur, or the canes burned.

The Rose beetle is especially prevalent on sandy soils. It is a slender beetle, thickly clothed with hairs, yellow; its legs are long, slender, and pale red in color. It appears in early Summer, feeding on leaves and flowers. A spray with a poison does little, but by some it is thought that they can be poisoned with arsenate of lead if it is mixed with molasses and sprayed on the foliage. Hand picking is really necessary. They should be dropped into oil. The white and light colored flowers are attacked more than dark reds. The larvæ feed on roots of Rose plants.



Bed of the pink tea Rose Lady Ashtown and other Rose beds on lawn with Yew hedge behind. The statuary adds finish, dignity and interest

The Rose curculio, a snout beetle, is found often on wild Roses, also on *Rosa rugosa*, on the unfolding bud. They should be hand picked. They drill into the bud and are found late in the day or early in the morning.

ROSE DISEASES. Mildew causes a powdery effect upon leaves. It is especially prevalent upon the Crimson Ramblers and Moss Roses. It appears when the nights are cool and days are hot and sultry, and disfigures the plant, but does not affect the next year's crop of flowers. Sulphur powdered upon the leaves is a suggested control.

Black Spot is the most serious disease, and is especially bad on the American Beauty and other hybrid perpetuals. It is confined to the foliage and appears in Midsummer. It looks like a black or purple spot one-quarter inch in diameter; the blotches more evident on the upper surface. When the patches are examined they will be found to have a fine mycelium growing on them which causes premature defoliation. The leaves should always be removed if possible. Spray with Bordeaux mixture (3-5-50), or other copper fungicides; potassium sulphide does not seem as good.

Leaf Scorch, when severe, causes the infected areas of the leaf to drop out. The canes are also attacked. The wild Roses, too, are infested. The best control is to use copper fungicides.

Rose Rust is especially prevalent on hardy varieties. It has Summer spores and Winter spores and attacks canes as well as leaves. The best preventive is the removal and burning of all rusted canes. A spray with some copper solution to protect and prevent is all that can be advised.

Rose Canker appears as a warty growth on the canes; excrescences on wood. It can only be cut out when found. It is caused by a fungus.

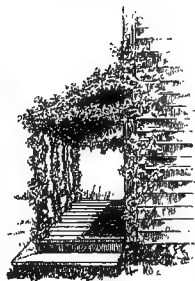

Screen for the side or back of a house. Grape vines may be used, but they must be kept free of insects and other "crawly things." Ampelopsis, Clematis or Wichuriana Roses also can be recommended

CHAPTER VI

Among the Hardy Flowers

BY hardy plants we mean those perennial herbaceous plants which will live a number of years without re-sowing seed.

We use the word "herbaceous" to contrast them with shrubs and trees, for it means that they die down to the soil each year. Their growth is soft, not woody.

It may be asked why we talk so much about the proper care of this or that perennial when on the whole the commonest ones merely need a medium good soil and their competitors, the weeds, removed. The reply is that we should not be content with Peonies, Phlox, or Iris unless they are grown to perfection, or unless we have the finest varieties.

We are interested in a particular flower often because it seems to possess a certain shape, color, or thrifty habit, which we admire. Our interest broadens when we prefer to get a great many varieties of the same flower. Finally, we are even interested in its botanical relatives. It is then that we become "cranks" and thoroughly know and truly enjoy a chosen favorite.

Perennials are adapted to such a range of soils and climates that we can surely find something beautiful to suit our situation exactly. If our land is very rocky and shallow we must govern our selection of perennials accordingly, and we can follow nature quite closely in choosing the sort of plants to use.

Each garden should be our own, and should express our likes in color and combination, but we must be governed by good taste, with the possession of which some are born, while by others it must be acquired. A lady told Ruskin that although she did not know good art she knew what she liked. Ruskin replied: "Even the beasts of the field know that." The observations of others often make us able to choose wisely for ourselves.

COMBINATIONS OF PERENNIALS

A planting of delicate pink Hollyhocks, in front of which we place a good clump of white Phlox, is to be much commended. Similarly, the Phlox will combine nicely with Delphinium.

A bed of Peonies, in which have been planted some *Lilium specio-*

sum rubrum and album, is good; the Peonies will have finished flowering before the Lilies begin.

Huge beds of German Iris of one variety are shown by themselves, but since they are out of bloom before July 1st it is well to have something to maintain the beauty. A few attractive shrubs are then useful. Especially decorative are Viburnum Opulus or some of the Honeysuckles with their berries.

Coreopsis lanceolata and a deep violet blue Delphinium make an excellent contrast.



Long borders of hardy flowers growing freely and in great luxuriance. The arch in the garden wall focuses the view. No straight trim edges, yet there is abundant room to walk. These borders run right up to the dwelling house

Another yellow and blue combination is Speedwell (*Veronica spicata*) with Evening Primrose (*Oenothera missouriensis*). The slender spikes of the Speedwell contrast nicely with the large, brilliant yellow flowers of the Evening Primrose.

Probably no flower of the Autumn is so graceful and welcome as the lovely Japanese Anemone. Excellent white and pink varieties are available. As they make no effect till near August they are best combined with a tall, ornamental grass which will give a good back-ground.

The large group of perennial Asters, or Michaelmas Daisies, should not be forgotten; they are the charm of the real late Fall garden. Planted at the rear of borders they make an excellent foliage back-

ground for the earlier flowering plants. Especially noteworthy is the Aster ptarmicoides, a very erect, strong-growing white species which blooms a trifle earlier than some of the others. A truly beautiful light blue is the Beauty of Colwall and a good pink is *A. novi-belgii* St. Egwin. A very late species, five to six feet tall, is *A. tataricus*; it possesses excellent clean foliage and bluish violet flowers. One of the largest flowering sorts is *A. grandiflorus*.

The Larkspurs and Monkshoods (*Aconitum*) are planted to

advantage in conjunction with Madonna Lilies (*Lilium candidum*). Spring bulbs are often combined with a few *Adonis amurensis*, a very pretty little yellow-flowering plant with finely cut leaves.

Under trees where grass will not grow, plant some *Ajuga reptans*, or even Ground Ivy (*Nepeta Glechoma*); the latter is often considered a weed, but very attractive results are often produced by its use. It bears pretty blue flowers.

In every home yard there is a certain small area, between perhaps the walk and the wall, which it would be advantageous to have nicely filled with plants; such an area is nicely planted to Bishop's Weed (*Ægepodium*). This plant has green and white variegated leaves and thrives in any soil. It is rapid growing, but only attains a height of twelve inches.

Excellent contrast combinations can be had by the intense blue *Anchusa italica* and the yellow Marguerite (*Anthemis tinctoria*), placing the *Anchusa* at the back.



Bringing the flower garden up to the house. Note also the brick path and other architectural features

Another good combination is that of German Iris, among which is planted the Summer Hyacinth (*Hyacinthus* or *Galtonia candicans*), with its long spikes of white bells and its broad leaves. The bulbs of the Summer Hyacinth are placed in the soil in the Spring; when they bloom the Iris will have finished its blooming but will furnish a foliage base.

An effective use of the blue *Aquilegia*, or *Columbine*, is to place a number of these plants at the base of a yellow Rose; for example, *Harrison's Yellow* or *Persian Yellow*.

CONSIDERATIONS FOR A PERENNIAL BORDER. We have a great many classes of perennials, some of which are so wild and aggressive that they should be planted among the shrubbery only. We have others which are very dainty and tender and whose growth must be carefully watched and their special needs for protection attended to.

We must scatter plants through the length of the border which will bloom throughout the season. We should, furthermore, attempt to get good color combinations. We should know the heights to which the plants grow, otherwise the taller ones may be in front and the more dwarf ones in the background. It is always well in an informal border to let the back line be somewhat broken; plants at some points are a little shorter.

SITUATION OF BORDER. Choose a southern exposure where it is not in too close proximity to large tree roots. It should be somewhat protected from the direct force of the wind, otherwise fragile flowers will not be very lasting. Most perennials enjoy a medium light loam.

PREPARATION OF SOIL. As with annuals, but perhaps more so with perennials, the soil for borders should be deeply and thoroughly prepared; two to three feet is none too deep, for plants must remain in one place for a long time. In the case of Peonies it is detrimental to move them often and it is frequently two years, and in some soils three years, after moving a Peony plant before it blooms normally.



Another garden where the flower borders are brought close to the house. Here, too, are ornamental architectural objects, and brick path in herring-bone pattern

Manure and a complete fertilizer should be well worked into a new border. All perennial borders profit by an application of bonemeal, hardwood ashes and sheep manure every year or two. Perennial borders which have been flowering year after year and to which much manure has continually been added, become somewhat sour and an application of slaked lime every two years is very beneficial. Many of the perennials do not attain their proper maturity before the Winter because they have been excessively fertilized and forced into continued sappy growth. They then suffer from cold. All soils for borders should be loose, so that they can be easily kept stirred. Soils are made light or loosened by manure, sand or coal ashes. Clay soils surely need some such treatment.

PLANTING. Now that the questions of fertilizers and soils are settled, let us consider the planting. A rule is given in setting perennials to put them a trifle closer than half their height. For example, Columbine grows two feet tall; for good clumps place young plants one foot apart. This rule will not apply in subsequent years, for as the plants grow they must be thinned out. A good, liberal planting is always the better plan. Plants should usually be set a little deeper than they were when growing in the nursery. Care must be exercised not to bury them too deeply, however, for some perennials, as Violets and German Iris, are almost surface creepers. In placing the perennials in the soil, spread the roots symmetrically; do not wad them and cram them into a little hole.

SPRING PLANTING. The planting of perennials is best done in Spring when the tops are just about to start into growth. There is danger in planting when the soil is too moist, especially clayey soils, which when they become caked are difficult to pulverize during the whole growing season.

AUTUMN PLANTING. In the Autumn most perennials can be transplanted successfully if their roots get established before cold weather. If perennials must be moved in full growth they should always be cut back; especially is this the case when much soil is removed from the roots. All newly set stock should be watered. There is usually less work in Autumn than in the Spring, hence this season is often preferred for planting.

CULTIVATION. Through the growing season the surface soil should be loosened so that air may enter in order to encourage root action, as well as to conserve the moisture, and keep the weeds in check. Under the heading of "Lawns" we have mentioned the value of lawn clippings as a Summer mulch to conserve moisture. We very strongly recommend nicely decayed stable manure and leafmold, where these are obtainable.



**Iri^{es}, Peonies, Violas and other hardy flowers and shrubs in a garden
in northern New York State**

WATERING, although beneficial, is less necessary if the soil is always kept loose. In dry seasons water may be applied, using plenty at one time. Little drippings of water are bad for all plants, for they only destroy the surface looseness. Syringing the foliage is beneficial; in many cases it serves to keep insects in check if done vigorously. Wherever possible, water should be laid on for use in the garden.

STAKING. Many of the perennials will become tall and some support will be necessary. Do not make it conspicuous. Paint the stake green and tie with green cord or raffia, but do not use an old mop handle nor tie with brilliant calico. A light, but long stake placed at the center of the plant is effective. Branchlets may also be used. In that case scarcely any tying is needed. Let the stakes be placed early; when the plants have made a great growth they cannot be effectively supported, so that a natural appearance is lost. The whole beauty of a garden is frequently marred by the absence of stakes or a poor method of staking.

REMOVAL OF OLD FLOWERS AND SEED PODS. All old flowers, seed pods and dead leaves should be removed from time to time. They should be burned. Old flowers harbor thrips, a very minute insect which is usually found in the heart of a Rose bloom; they cause a shabby appearance of the petalage. Seed production is a most debilitating process; the plant therefore should be prevented from doing this excessive labor. When the old flowers are picked the energies are often turned to a second crop of bloom. Many dead leaves are diseased and are a menace to the other plants. Besides this, old flowers, dead leaves and seed pods give an air of untidiness to the garden.

The propagation of perennials is discussed in a separate chapter, page 200.

NECESSITY FOR REPLANTING. Some of the later blooming perennials, especially Helianthus, Rudbeckia, Asters, Boltonia, Physostegia, Achillea, need to be replanted or parts of them removed each year. Five or eight shoots of these perennials can be chosen and the rest dug up and moved to another place. This is the only way to keep some of the weedier growers in subjection. Perennials which bloom from crowns in the early Spring are usually impatient of being moved often, examples being Bleeding Heart, Oriental Poppy, Dictamnus, Red Hot Poker and Peony. Iris reproduces rapidly and is best divided every two or three years; Phlox every three or four years and Peony only every five or six years. Many perennials, as Delphinium and Columbine, increase by a gradual enlargement of the crown.

LIST OF THIRTY INDISPENSABLE HARDY PERENNIALS

Judged from hardiness, color, profusion of bloom or particular seasonal value.

1. TEN TALL. (Above 3½ feet tall.)

- Althea rosea (Hollyhock). Great range of colors.
- Anchusa italica, Dropmore variety (Italian Borage). Deepest blue.
- Aster. Tall species (not China Aster), often called Michaelmas Daisies.
- Delphinium. Tall, deep blues.
- Digitalis purpurea, var. gloxiniaeflora. Excellent foliage.
- Echinops ruthenicus, or Ritro (Globe Thistle).
- Helianthus decapetalus, var. multiflorus. Forms huge clumps, excellent for screening.
- Rudbeckia laciniata, var. Golden Glow. Golden yellow.
- Thalictrum aquilegifolia. Feathery flowers, lilac in color.
- Yucca flaccida. Tall spikes of white, bell-shaped flowers.

2. TEN MEDIUM TALL. (Between 1½-3½ feet tall.)

- Anemone japonica. Chosen as best late white flower.
- Aquilegia chrysantha. Long-spurred, golden yellow Columbine.
- Campanula persicifolia. Blue or white, erect, clean growth, handsome spikes.
- Delphinium Belladonna. Indispensable, medium light blue.
- Dianthus barbatus (Sweet William). Various colors, fragrant.
- Gypsophila paniculata. Fine airy flower, white, graceful.
- Iris germanica pallida dalmatica. Excellent, light blue.
- Papaver orientale. Gorgeous scarlet and orange flowers.
- Peony, var. Festiva maxima. White, with dash of red at center.
- Phlox suffruticosa Miss Lingard. Pure taffy white flower.

3. TEN DWARF. (Below 1½ feet tall.)

- Arabis alpina. One of best early white perennials.
- Dianthus plumarius (Clove Pink). White to purple, very fragrant.
- Geum coccineum (Avens). A very clear scarlet; likes sun.
- Heuchera sanguinea (Coral Bells). Long, graceful spikes of white or scarlet bells.
- Iberis semperflorens. (Perennial Candytuft); excellent white.
- Iris pumila (Dwarf Iris). Good yellows, purples and whites.
- Phlox subulata (Moss Pink). Excellent Spring bloom, lavender pink.
- Primula polyantha and veris (Spring Cowslip). Excellent fresh colors.
- Sedum spectabile (Showy Sedum). Fleshy leaves, rose to crimson flowers.
- Chrysanthemum maximum (Shasta Daisy). Though it does not succeed well everywhere, it is an excellent improved white Daisy.

GENERAL SELECTION OF HARDY FLOWERS

† For cutting. * Shade enduring. ° For rock garden. ‡ For moist ground.

TALL PERENNIALS (Above 3½ feet)

- °† Achillea filipendula
- *°† Aconitum autumnale (Autumn Aconite).
- *°† Aconitum Fischeri (Monk's-hood).
- *°† Aconitum lycoctonum (Wolf's-bane).
- † Althea rosea (Hollyhock).
- *°† Anchusa italica Dropmore (Italian Borage Alkanet).
- *° Aruncus Sylvester (Goat's Beard).
- *° Asters, numerous species.
- *° Bocconia cordata (Plume Poppy).
- † Boltonia asteroides (False Chamomile)
- ° Boltonia latisquama.
- ° Campanula pyramidalis (Chimney Campanula).
- †*° Cimicifuga racemosa (Bugbane).
- °† Delphinium hybrids.
- *°† Digitalis purpurea, var. gloxiniaeflora (Foxglove).
- *°† Digitalis ambigua (Larger Yellow Foxglove).
- *°† Echinops ruthenicus (Globe Thistle).
- † Helianthus decapetalus (Perennial Sunflower).
- † Helianthus orgyalis (Narrow-leaved Sunflower).
- †† Helianthus tuberosa (Jerusalem Artichoke).
- *°† Lupinus polyphyllus (Lupin).
- †† Rudbeckia laciniata, var. Golden Glow.
- † Senecio clivorum.
- †*°† Thalictrum aquilegifolia (Meadow Rue).
- °† Tritoma Pfitzeri, properly called Kniphofia aloides (Red Hot Poker).
- † Valeriana officinalis (Valerian).
- °† Yucca flaccida (Bayonet Plant).

MEDIUM TALL PERENNIALS (1½-3½ feet)

- *†*Achillea Ptarmica* (Sneezewort).
 *†*Aconitum Napellus* (Monk's-hood).
 *†*Anthemis tinctoria* Kelwayi (Chamo-mille).
 **†*Anemone japonica* (Japanese Anemone).
 *†*Aquilegia* (Columbine).
 *†*Aquilegia* sp. *canadensis*.
 *†*Aquilegia chrysantha*.
 *†*Aquilegia cærulea*.
 *†*Aquilegia sibirica*.
 *†*Aquilegia vulgaris*.
 ††*Asclepias tuberosa* (Butterfly Weed).
 ††*Aster ptarmicoides* (Frost Weed).
 ††*Baptisia australis* (False Indigo).
 †*Campanula glomerata*.
 †*Campanula Medium* (Canterbury Bells).
 †*Campanula Medium*, var. *Calycanthema* (Cups and Saucers).
 ††*Campanula persicifolia* (Peach-leaved Campanula).
 ††*Campanula Trachelium* (Throatwort).
 ††*Callirhoe involucrata* (Poppy Mallow).
 ††*Centaurea dealbata* (Cornflower).
 ††*Centaurea dealbata macrocephala* (Knapweed).
 ††*Centaurea montana* (Mountain Bluet).
 ††*Centranthus ruber* (Red Valerian).
 ††*Chrysanthemum coccineum* (Pyrethrum).
 ††*Chrysanthemum Parthenium* (Feverfew).
 ††*Clematis Davidiana*.
 ††*Clematis recta*.
 ††*Coreopsis lanceolata grandiflora* (Tickseed).
 ††*Coreopsis verticillata* (Narrow-leaved Tickseed).
 *†*Corydalis nobilis*.
 ††*Delphinium Belladonna* (Larkspur).
 ††*Dianthus barbatus* (Sweet William).
 ††*Dicentra spectabilis* (Bleeding Heart).
 *†*Dictamnus Fraxinella albus* (Gas Plant).
 ††*Dimorphotheca aurantiaca* (Cape Marigold).
 *†*Dracocephalum moldavicum* (Moldavian Balm).
 ††*Doronicum excelsum* (Leopard's Bane).
 *††*Echinacea* (*Rudbeckia*) *purpurea* (Purple Coneflower).
 †††*Epilobium angustifolium* (Fire Weed).
 †††*Erigeron speciosus* (Fleabane).
 †††*Eryngium planum* (Sea Holly).
 †††*Eryngium amethystinum* (Sea Holly).
 †††*Eupatorium purpureum* (Joe Pye Weed).
 †††*Eupatorium perfoliatum* (Boneset).
 †††*Euphorbia corollata* (Flowering Spurge).
 †††*Filipendula hexapetala* (Meadow Sweet).
 †††*Gaillardia aristata* (Blanket Flower).
 †††*Galega officinalis* (Goat's Rue).
 *††*Galium boreale* (Northern Bedstraw).
 †††*Gypsophila acutifolia* (Baby's Breath).
 †††*Gypsophila paniculata* (Baby's Breath).
 †††*Helenium autumnale* (Sneezeweed).
 †††*Helenium* (*Dugaldia*) *Hoopesii* (Sneezeweed).
 †††*Helianthus Maximiliani* (Maximilian Sunflower).
 †††*Helianthus mollis* (Downy Sunflower).
 †††*Hemerocallis aurantiaca* (Orange Day Lily).
 †††*Hemerocallis flava* (Lemon Lily).
 †††*Hemerocallis fulva* (Day Lily).
 †††*Hemerocallis Thunbergii*.
 †††*Hesperis matronalis* (Sweet Rocket).
 †††*Iris germanica* (German Iris).
 †††*Iris Kämpferi* (Japanese Iris).
 †††*Iris sibirica* (Siberian Iris).
 †††*Liatrix pycnostachya* (Blazing Star).
 ††††*Lobelia cardinalis* (Cardinal Flower).
 ††††*Lobelia syphilitica* (Blue Lobelia).
 ††††*Lychnis chalcedonica* (Maltese Cross).
 ††††*Lysimachia clethroides* (Pepperbush Loosestrife).
 ††††*Lysimachia punctata* (Dotted Loosestrife).
 ††††*Lysimachia vulgaris* (Common Loosestrife).
 ††††*Lythrum Salicaria roseum superbum* (Purple Loosestrife).
 †††††*Metensia virginica* (Virginia Bluebells).
 †††††*Monarda didyma* (Beebalm).
 †††††*Oenothera missouriensis* (Missouri Evening Primrose).
 †††††*Oenothera speciosa* (Evening Primrose).
 †††††*Pæonia albiflora*.
 †††††*Pæonia officinalis*.
 †††††*Pæonia tenuifolia*.
 †††††*Papaver orientale* (Oriental Poppy).
 †††††*Pentstemon barbatus* Torreyi.
 †††††*Pentstemon gloxinoides*.
 *†††††*Phlox maculata*.
 †††††*Phlox paniculata* (Hardy Phlox).
 †††††*Phlox suffruticosa*.
 †††††*Physostegia virginiana* (Obedient Plant).
 †††††*Platycodon grandiflorum* (Chinese Balloon Flower).
 †††††*Rheum palmatum* var. *atro sanguineum* (Ornamental Rhubarb).
 †††††*Salvia azurea* (Blue Sage).
 †††††*Salvia pratensis* (Common Meadow Sage).
 †††††*Scabiosa caucasica* (Scabious).
 †††††*Sidalcea candida*.
 †††††*Smilacina racemosa* (Solomon Seal).
 †††††*Solidago* sp. (Golden Rod).
 †††††*Spiræa*.
 †††††*Thalictrum adiantifolium* (Meadow Rue).
 †††††*Thalictrum dipterocarpum*.
 †††††*Thermopsis caroliniana*.
 †††††*Tradescantia virginiana* (Spiderwort).
 †††††*Veronica longifolia* var. *subsessilis* (Speedwell).
 †††††*Veronica spicata* (Spiked Speedwell).

LIST OF DWARF PERENNIALS. (Less than 1½ feet.)

- *°Adonis æstivalis (Pheasant's Eye).
- *°Adonis vernalis (Spring Adonis).
- †*°Egopodium Podagraria (Gout Weed).
- *°Ajuga reptans (Bugle).
- *°Ajuga genevensis (Bugle).
- °Alyssum rostratum (Gold Dust).
- °Alyssum saxatile (Gold Dust).
- *°Arabis alba (Rock Cress).
- *°Arabis alpina (Rock Cress).
- *°Armeria maritima (Sea Thrift).
- *°Armeria formosa (Sea Thrift).
- *°Asperula odorata (Sweet Woodruff).
- *°Astrantia carniolica (Masterwort).
- °Aubrieta deltoidea (Purple Rock Cress).
- *°Campanula rotundifolia (Harebell).
- *°Campanula carpatica (Carpathian Harebell).
- °Centaurea nigra (Knap Weed or Hard-head).
- *°Cerastium tomentosum (Snow-in-Summer).
- °Chrysanthemum arcticum.
- °Chrysanthemum maximum (Shasta Daisy).
- *°Claytonia virginica (Spring Beauty).
- *°Coronilla varia (Crown Vetch).
- *°Dianthus deltoideus (Maiden Pink).
- *°Dianthus latifolius (Pink).
- *°Dianthus plumarius (Clove Pink).
- *°Dicentra eximia (Wild Bleeding Heart).
- *°Dicentra formosa (Chinese Bleeding Heart).
- *°Dicentra cucularia (Dutchman's Breeches).
- †*°Epimedium alpinum.
- *°Epimedium pinnatum.
- †*°Funkia.
- *°Gentiana Andrewsii (Closed Gentian).
- *°Geranium sanguineum (Crane's Bill).
- *°Geum coccineum (Avens).
- °Helenium autumnale pumilum (Sneeze-weed).
- *°Helleborus niger (Christmas Rose).
- *°Hepatica triloba (Mayflower).
- *°Hepatica acutiloba (Mayflower).
- *°Heuchera sanguinea (Coral Bells).
- °Iberis semperflorens (Perennial Candy-tuft).
- °Incarvillea Delavayi.
- °Iris cristata, pumila, and verna (Dwarf Iris).
- °Lychnis coronaria (Mullein Pink).
- °Opuntia vulgaris (Prickly Pear).
- °Papaver nudicaule (Iceland Poppy).
- °Phlox Arendsii.
- †*°Phlox divaricata (Wild Sweet William).
- †*°Phlox subulata (Moss Pink).
- °Plumbago Larpentæ (Lead Plant).
- †*°Podophyllum peltatum (May Apple).
- *°Polemonium cærulea (Jacob's Ladder).
- °Potentilla Miss Willmott.
- †*°Primula japonica.
- °Primula polyantha.
- °Primula vulgaris.
- *°Pulmonaria saccharata (Lungwort).
- *°Ranunculus acitonifolius fl. pl. (Double Buttercup).
- °Sagina glabra (Pearlwort).
- °Saxifraga pyramidalis (Saxifrage).
- †*°Sedum spectabile (Showy sedum).
- *°Sempervivum arachnoideum (Spider-web Houseleek).
- *°Sempervivum Brownii.
- *°Sempervivum pyrenaicum.
- *°Sempervivum tectorum (Old Man and Woman).
- *°Statice latifolia (Sea Lavender).
- °Stokesia cyanea (Stokes' Aster).
- †*°Trillium grandiflorum (Wake Robin).
- *°Trillium sessile.
- *°Trillium erectum (Red Trillium).
- †*°Trollius asiaticus (Globe Flower).
- †*°Trollius europæus.
- †*°Trollius excelsior.
- †*°Trollius giganteus.
- *°Tunica (Petrohagia) Saxifraga.
- °Veronica (Petrohagia) incana.

PLANS FOR BORDERS OF VARIOUS COLOR COMBINATIONS

LIGHT PINK BORDER

(Numbers 8-9, etc. refer to the months in which they are in flower.)

<p>1 Hollyhock. Pink double variety 7-8 Pink</p> <p>2 Chrysanthemum. Light pink variety. (For ex., Rhoda or Maid of Kent) 8-9 Light pink</p> <p>3 Anemone japonica, var. Queen Charlotte 9-10 Pink</p> <p>4 Pæonia Mme. Emile Galle 6 Pink</p> <p>5 Digitalis purpurea, var. rosea 6-7 Pink</p>	<p>6 Sedum spectabile 8-9 Light pink</p> <p>7 Dianthus plumarius 6-7 Light pink</p> <p>8 Campanula medium 6 Light pink</p> <p>9 Aster, novi-belgii, St. Egwin 9 Light pink</p> <p>10 Pyrethrum. Pink variety 6-7 Pink</p> <p>11 Phlox subulata, var. rose 4-5 Pink</p> <p>12 Bellis perennis 5-6 Light pink</p> <p>13 Coronilla varia 6-9 Light pink</p>
---	--

GARDEN GUIDE

LEMON YELLOW AND WHITE BORDER

1 Centaurea macrocephala	8-10	Lemon yellow	7 Achillea ptarmica, The Pearl	7	White
2 Spiraea aruncus	7-8	White	8 Aquilegia chrysantha	6	Lemon
3 Aconitum lycoctonum	7-9	Lemon	9 Asphodelus lutea	6-8	Lemon
4 Aster	9	White	10 Iris flavescens	6	Lemon
5 Cephalaria montana	6-8	Lemon	11 Sedum album	4-6	White
6 Anthemis tinctoria Kelwayi	6-7	Lemon	12 Enothera missouriensis	6-8	Lemon
			13 Iberis semperflorens	5	White

SCARLET AND WHITE BORDER

1 Aster, White Queen	8-9	White	8 Geum coccineum	6-7	Scarlet
2 Tritoma Pfitzeri	8	Scarlet	9 Papaver orientale	5-6	Scarlet
3 Hollyhock	7-8	White	10 Lychnis chaldonica	6-7	Scarlet
4 Monarda didyma	6-9	Scarlet	11 Gaillardia	6-7	Scarlet
5 Boltonia asteroides	7-8	White	12 Arabis alpina	5-6	White
6 Pentstemon barbatus Torreyi	6-7	Scarlet	13 Heuchera sanguinea	6	Scarlet
7 Cimicifuga racemosa	7-8	White			

BORDER WITH GRAY FOLIAGE

1 Buddleia Veitchiana			8 Lavandula vera		
2 Scotch Thistle			9 Santolina chamaecyparissus		
3 Rudbeckia grandis			10 Salvia argentea		
4 Bocconia cordata			11 Cerastium tomentosum		
5 Gynerium argenteum			12 Veronica incana		
6 Echinops ruthenicus			13 Leontopodium sibiricum (Edelweiss)		
7 Agrostemma coronaria					

ENTIRELY BLUE BORDER

1 Aconitum Napellus	7-8		8 Aquilegia cærulea	6	
2 Aster, Beauty of Colwall	9-10		9 Eryngium amethystinum	7-9	
3 Delphinium, Duke of Connaught	6-7		10 Aster amethystinus	8-10	
4 Iris sibirica orientalis	6		11 Ajuga genevensis	4	
5 Anchusa italica	6		12 Phlox divaricata Laphami	5-7	
6 Polemonium cæruleum	5-7		13 Iris cristata	5	
7 Veronica spicata	5-7				

BLUE AND WHITE BORDER

1 Lupinus polyphyllus	6	Blue	8 Campanula persicifolia	6-7	White
2 Iris sibirica White Queen	6	White	9 Centaurea montana	6-7	Blue
3 Delphinium	6-7	Blue	10 Aster ptarmicoides	8-9	White
4 Bocconia cordata	7-8	White	11 Iris pumila cyanea	5-6	Blue
5 Aster	9-10	Blue	12 Campanula carpatica	6-8	Blue
6 Gypsophila paniculata	7	White	13 Aubretia deltoides	2-6	White
7 Aquilegia cærulea	6	Blue			

BLUE AND YELLOW BORDER

1 Helenium autumnale superbum	8-10	Yellow	7 Anthemis tinctoria	6-7	Yellow
2 Delphinium	6-7	Blue	8 Lupinus polyphyllus	6	Blue
3 Solidago (Goldenrod)	9	Yellow	9 Coreopsis grandiflora	6-9	Yellow
4 Anchusa italica	6	Blue	10 Veronica longifolia subsessilis	8-9	Blue
5 Helianthus orgyalis	7-9	Yellow	11 Plumbago Larpentæ	6-9	Blue
6 Iris germanica var. asiatica	6	Blue	12 Alyssum saxatile compactum	5-6	Yellow
			13 Myosotis	3-8	Blue

CHAPTER VII

A Few of "Everybody's Favorites"

THE GLADIOLUS

HERE we have a regal flower stately enough for the finest mansion, as well as a democratic flower charming for the cottage window and home garden.

Each year finds new uses for the Gladiolus, which now holds first place among the Summer blooming bulbs. First, because of the great range of color; secondly, because of wonderful keeping qualities, each spike keeping over a week; thirdly, because of its easy cultivation, primarily the same as that for Potatoes; and, fourthly, by the proper choice of established varieties they can be commended because of their cheapness. This flower is extensively utilized for all kinds of decorative work. Large vases or baskets of the stately flower spikes fill a place quite distinct from any other flower. As a garden subject the Gladiolus is unexcelled for furnishing a long season of bloom, extending from mid-July until frost, either in a bed, in which case the plants should be very close, or in clumps in the herbaceous border.

The best soil for the Gladiolus is a medium loam. It appreciates good fertility, but seems sensitive to any manure in contact with the bulbs. Manure is good if applied in the Autumn previous to planting. The best fertilizer for general use is one that would be called a Potato fertilizer, rich in potash and phosphoric acid, both chemicals being useful in the proper formation of good bulbs. Bonemeal is also extensively used. Liquid manure, when the buds are forming, seems beneficial.

Gladioli are not hardy, except some varieties of Lemoinei, and even these require protection in New York State. Planting should be deferred until all danger of frost is past. A well-planned succession in planting is advisable. The depth to plant is determined by the character of the soil. In the lightest soil seven or eight inches is not too deep, but in a heavy clay four or five inches would be a sufficient depth. There are two reasons why the corms should be planted as deep as the character of the soil will permit: First, the Gladiolus is moisture-loving, and in deep planting its roots are in the cooler moist soil; secondly, the soil acts as a support, no other support for the stems being necessary ordinarily. Commercially, the corms, *i.e.*,

bulbs, are usually planted in rows, often two rows, about six inches apart, in the furrow. If the corms are over one inch in diameter they are scattered promiscuously.

Upon the approach of frost the corms are dug, and the tops left on the corms. They are then stored in an airy place to dry thoroughly. After several weeks the last year's exhausted corms and the old stems may be removed and the stock cleaned. The best storage temperature is from 40 to 45 deg., and in a rather dry atmosphere. If the corms become heated they dry, and this causes them to start prematurely. If too humid the corms rot or start growth. A shallow tray three or four inches deep insures the corms against heating.

PROPAGATION. (1) By seeds. By this method new varieties are obtained, but the standard varieties, being hybrids, do not come true when started from seed. (2) By cormels, or "spawn" (the small, hard-shelled little cormels borne upon the old ones). These, if planted during the Spring following the season in which they were produced, will bloom one or two years later, or usually one year sooner than from seed. (3) By the annual renewal of corms, of which there are from one to six, produced above the old corm each year.

THE PEONY

Like many other plants intensely interesting because of their charming blooms, the Peony first came to the attention of the world as a medicinal plant. It was named after Pæon, a mythological doctor, but the roots of the species *officinalis* have been used in the making of a broth.

Peonies are easy to grow; they are permanent and when once established are impatient of being moved. They are perfectly hardy wherever Apples can be grown and can easily be protected in the colder regions. They bear large and showy flowers, of a great range of colors; some are delicately scented. The plants are so free from insects that they prove themselves to be ideal for cut blooms or landscape flowers.

There are a number of interesting species of the Peony. The most seen is the Chinese Peony (*Pæonia albiflora*). This is the standard Peony of which we have so many matchless varieties. The plant of the narrow-leaved or Fennel-leaved Peony (*P. tenuifolia*) is very beautiful, but its value is fleeting. It blooms in May, the pretty scarlet flowers nestling among the dainty dissected foliage. Closely following in season are the European Peonies (*P. officinalis*). These are the old-fashioned crimson Pineys of the garden; they produce very satiny-petaled blooms, which possess a not unpleasant soapy odor.

At about the same season the shrubby or hardy tree Peonies (*P. Moutan*) open their enormous glossy single or double flowers. The shrubby Peony grows very slowly. It should be planted where it is sheltered from the wind.

The last groups to bloom are the albiflora varieties. These often begin to bloom in New York State for Memorial Day. For a succession of varieties to bloom, Rev. C. S. Harrison, who might be called the Chaplain of American Gardeners, recommends the varieties *umbellata rosea*, *L'Esperance*, *edulis superba*, *Monsieur Dupont*, *Richardson's rubra superba*, *Henry Woodward*, *Richardson's grandiflora*. Mr. Harrison, speaking further of prolonging the blooming of

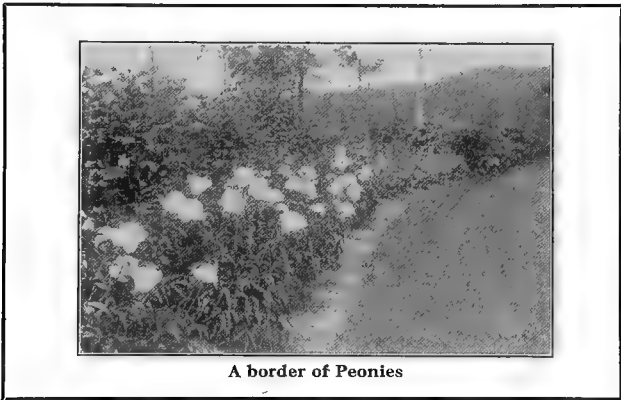

A border of Peonies

the Peony, says: "There is also a system by which the blooming of a single variety can be prolonged. Take a row, say of *Festiva maxima*; wait until the ground has frozen solid; leave the end of the row uncovered. Then, farther on, put on mulching and increase the depth until, at the farther end, it is a foot to eighteen inches deep; leave this on. The covering keeps the frost in; then the plant will take some time to push up through the mulching. You can apply this system to the later varieties and so lengthen the flowering season considerably."

A word may be necessary to explain the method of doubling in the Peony. The normal or single flower is composed of petals (we shall call all the petals guard petals in this case); stamens or the male part of the flower (these are yellow at the tip and bear pollen); the pistil, each section of which we call a carpel (this is often red and bears the seed). In doubling, the stamens become wider and wider until they

resemble the petals; then we call them petaloids. In the same way the seed-bearing power is lost by the female parts, changing to resemble petals at the center of the flower.

The following are the types recognized by the American Peony Society:

1. *Single*. (Have also been called Anemone-flowering type.) There are a few broad petals, the center being filled with stamens.

2. *Japanese*. In this type doubling has just begun; the filaments of the stamens have widened; the anthers are also much developed. The guard petals, the petals at the base of the flower, are the same as in the single varieties.

3. *Bomb*. The petaloides, or the transformed stamens, have become still wider and thickly set; the petals approach the guards in form, but are still distinguishable from each other.

4. *Semi-double*. Several rows of large petals and some with petaloides in all stages of transformation. A loose bloom.

5. *Crown*. When the carpels, the parts of the pistil, transform into petals they may form a different center from the guard petals and petaloides, giving the appearance of a small Rose in the center of the flower.

6. *Rose*. A fully double form. The stamens and carpels are both transformed. It is really a developed Bomb, for in this case the petaloids are merely wider and indistinguishable from the guard petals.

The following is a list of best varieties for home grounds:

FESTIVA MAXIMA. White, center carmine; medium early.	MARIE LEMOINE. A very late sulphur white.
COURONNE D'OR. A late-blooming, semi-double white.	MODESTE GUERIN. Bright rose pink; mid-season.
MONSIEUR JULES ELIE. An early silvery pink.	MME. DUCCEL. Silvery pink, flushed salmon; vigorous dwarf; midseason.
GRANDIFLORA. Late, bright flesh pink.	MME. VERNEVILLE. Rosy white, with sulphur white guard petals.
DUCHESSE DE NEMOURS. Deep pink, early; a fine double.	BARONÉSS SCHRÖDER. Flesh changing to white; vigorous; excellent.
EDULIS SUPERBA. An early dark pink.	LIVINGSTONE. Fine late flower of silvery pink.
FELIX CROUSSE. Midseason; a brilliant red.	MONSIEUR DUPONT. Ivory white with lively carmine border on central petals.
JEANNE D'ARC. Large, soft pink; mid-season.	LA TULIPE. Semi-double; almost white; mid-season.
AVALANCHE. Milk white, with creamy center.	DELACHIE. Dark red; semi-double; mid-season.
EUGENE VERDIER. Salmon pink, changing to clear pink.	

The soil should preferably be heavy rather than light; a clay loam is excellent if it can be worked deeply. The Peony is a gross feeder and enjoys a good mulch of well rotted manure in the Winter.

PLANTING AND CULTIVATION. The time for planting or transplanting is August, when the plant has completed its growth. When



Types of Peonies

S.—Single, showing (g), guard petals; (s), stamens; (c), carpels or lobes of pistil.

J.—Japanese type; stamens wider than in Single.

B.—Bomb type. The stamens become narrow petals, called petaloides.

SD.—Semi-double. Many petaloides are quite wide and are mixed among the stamens.

C.—Crown. The stamens are wider and petal-like. The carpels, which before have remained unchanged, are now petal-like.

R.—Rose. In this type there is an entire transformation of the bloom.

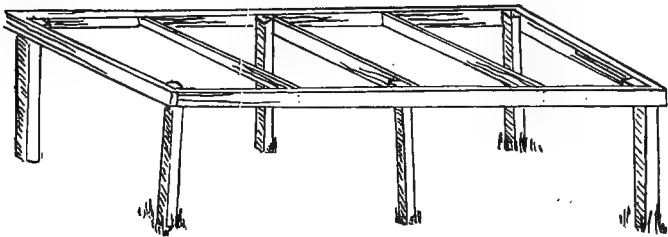

Rack for supporting Peonies

transferred in the Spring many of the feeding roots will be torn from the plants. The roots of the Peony are thick, almost no fibrous roots being formed; instead, very fine, delicate feeding roots start from the main roots.

The plants should be planted at least three feet apart and the crowns should be buried three inches below the surface. If they are planted too shallow the Winter frosts will heave them from the soil. A Winter mulch of from four to six inches of well decayed manure will also prevent this injury. When the plants have finished blooming, the cultivation must not be neglected since they must make a good growth and mature their foliage, else the crop of bloom for the next year will suffer. Every eight or ten years the Peony should be divided and replanted: It takes two or three years for a commercial three- to five-eyed root to throw characteristic blooms.

DISBUDDING. The albiflora varieties produce many buds in a cluster; if the best size blooms are preferred, all but the main or crown bud should be removed while they are yet small. Some weaker growing varieties are especially benefited by this practice. Single varieties are not disbudded.

STAKING. Certain very floriferous varieties will need some sort of support. One of the best and most permanent methods is to build a rack of wood over the Peony border and train the young shoots inside of this rack. For individual plants there is no better way than to use a barrel hoop supported on three uprights.

DISEASES. There are several diseases which attack the leaves, buds and stems. They are easily kept in check by spraying with Bordeaux mixture when the plants first start into growth in the Spring. Besides this, the diseased parts and all stems should be burned each Fall, for only by careful sanitation can the trouble be lessened.

THE CANNA

These handsome subjects mark a wonderful development by the plant breeder. At first the Cannas were only prized as a foliage plant; the petals were narrow and the flower was very unattractive. Now we have an excellent series of wonderful Cannas with superbly colored gigantic flowers, all of which are of easy culture and great value for the garden, where they are planted in formal beds or mixed in the perennial border.

STARTING CANNAS. Early in April the roots, which have been stored during the Winter, are best cut up so that there are one to three buds or eyes on each piece. They can then be planted in boxes of sand or sandy soil and placed in a light window. If the season is late and

the plants get rather large, they should be placed in pots; those four inches high are generally large enough.

Cannas are tender and should not be planted in the open ground before all danger of frost is past. There is no advantage in planting too early, for they do not make good growth till the ground becomes warm.

PREPARING CANNA BED. Spread a wheelbarrow load of manure over each square yard of soil and dig deeply; this means that the soil needs loosening to a depth of fifteen to eighteen inches. The deeper the digging the better will the bed absorb water. Large-leaved plants always require lots of water. Careful attention must be given to the question of the planting of varieties of harmonious colors as well as of the proper heights. The following table of varieties is supplied by the Conard & Jones Co.:

	Dwarf Up to 3 ft.	Medium 3 ft. to 4 ft.	Tall Over 4 ft.
White		Blanche Wintzer Mont. Blanc Impr.	Flag of Truce
Red	Express Philadelphia Pres., McKinley Triumph	Beacon Brandywine Chautauqua Cherokee Comte de Sachs Duke of Marlboro George Washington Italia King Humbert Patrie Wm. Saunders Dragon	Pocahontas Conowingo Giant Crimson Jupiter Louisiana Meteor Mrs. Geo. A. Strohlein Mrs. Kate Gray New York Olympic Pennsylvania Splendor Uncle Sam
Pink	Betsy Ross Hiawatha Loveliness Martha Washington Wawa	Eastern Beauty Luray Minnehaha Mrs. A. F. Conard Rosea Gigantea Venus Wabash	Lorraine Improved Louise West Grove
Yellow	Buttercup Director Holtze Dr. Nansen	Brilliant Kate F. Deemer	Austria
Yellow and Red		Elizabeth Hoss Florence Vaughan	Gladiator
Orange	Queen of Holland	California	Gaiety Indiana Wyoming
Variiegated	Halley's Comet Niagara Panama Souv. de A. Crozy Striped Beauty	Gladioflora Sam Trelease Impr.	Allemania Burbank Duke of York Jennie Walls Fahline Maid of Orleans Mrs. Carl Kelsey

Cannas usually spread a little and, as they are large growing, should be planted at least eighteen inches apart. The Orchid-flowering varieties require from twenty to twenty-two inches between the plants.

CANNAS FROM SEED. Canna seed is as hard as shot. It is difficult to get water through the seed coat so that the seed can start growth. Mr. F. P. Avery describes an experience with starting seed. He says: "March 22d I received some seed. I have access to an emery wheel, and I ground down to the white meat on every seed. That same evening I poured hot water on them, and kept them in hot water until the evening of March 27th, giving the seeds a five days' bath. I found four seeds showing a white germ the size of a pin-head. I put the lot in a big dish of sand, covering them about an inch. The dish stood in a hot place over a stove, where the seeds luxuriated in bottom heat and had hot sunshine. Fifteen days after I put the seeds to soak there were more than two hundred plants, averaging two inches in height. Some are three inches and some three and one-half inches tall. If these plants keep growing as they have begun they will match any plants started from roots by the time warm weather comes. Heat and moisture do the business, and March is a good month for starting the seeds, for fire heat is needed." Instead of using an emery wheel, the seeds are frequently nicked with a file.

DIGGING AND STORING. When the tops are killed by the frost the roots can be dug in the morning, and if the day is sunny they can be left to dry. They are easily stored in any place where Potatoes keep at all well. They must be kept warm, for if they are cold and damp they decay. They may either be buried in sand or soil, although sand is preferable. It is really unnecessary to wait till the tops die down, for the beds may be wanted to plant with bulbs, in which case let the Cannas grow as long as possible and then dig them.

THE DAHLIA

There is little question why the Dahlia has gained in popularity. The newer varieties win our admiration as soon as we see them. Should you insist that the Dahlia is very formal and stiff we should answer that the ones to which you refer are perhaps stiff because they were carefully bred for regularity and symmetry, and you would look upon them as triumphs of the breeder's art if you knew that the modern varieties have been evolved from several wild Mexican species. Near Mexico City, at an altitude of one thousand to two thousand feet above that of the city, we find the wild forms on sides of the deep ravines in partial shade. It is hot in the daytime, but really gets cold at night. How nicely this explains why our varieties bloom best nearer the cooler days of Autumn.

It was at the end of the eighteenth century before the Dahlia reached Europe and soon after three varieties were known. Soon

doubles were produced. The flat ones were first very popular; then the ball-shaped blossoms of the show type were greatly in evidence. Between 1830 and 1860 the interest in Dahlias became intense, and great premiums were paid for good varieties. Then in 1870 followed varieties which were flatter, less formal and delicately colored. In 1872 a new species, *Dahlia Jaurezii*, was introduced. This is the progenitor of the Cactus Dahlias, a type universally admired at



Even without any flowers the Canna is beautiful

present because of its graceful form and delicate coloring. The Cactus types are combined with the singles to produce the Peony-flowered forms from which have been eliminated the weak stems, resulting in an exalted form, and good-shaped blooms of matchless colors borne upon wonderfully strong plants. The large-flowered singles are having a great wave of popularity now, for they are often beautifully colored. In 1899 there was a pretty type produced in France in which there is a row of smaller and much more slender petals, of a different color, surrounding the central disk of an otherwise single flower. This type has been termed the Collarette Dahlia.

The American Dahlia Society's classification of Dahlias may be of interest for reference:

1. CACTUS DAHLIAS

A. TRUE, FLUTED TYPE: Flowers fully double; floral rays ("petals") long, narrow, incurved or twisted, with sharp, divided, or fluted points and

with revolute ("rolled back") margins, forming, in the outer florets, a more or less perfect tube for more than half the length of the ray.

Typical examples: Snowden, T. G. Baker, Mrs. Douglas Fleming, J. H. Jackson, H. H. Thomas and Rev. T. W. Jamieson.

B. HYBRID CACTUS OR SEMI-CACTUS TYPE: Flowers fully double; floral rays ("petals") short as compared with previous type, broad, flat, recurved or twisted, not sharply pointed except when tips are divided ("staghorn"), margins only slightly revolute ("rolled back"), and tubes of outer florets, if any, less than half the length of the ray.

Typical examples: Master Carl, Perle de Lyon, Flora, Mrs. J. T. Mace, Kalif and Rheinkoenig.

2. DECORATIVE DAHLIAS

Double flowers, full to center in early season, flat rather than ball-shaped, with broad, flat, somewhat loosely arranged floral rays ("petals") with broad points or rounded tips which are straight or decurved (turned down or back), not incurved, and with margins revolute (rolled back) if rolled at all.

Includes forms like those of *Souvenir de Gustave Douzon*, *Jeanne Charmet*, *Le Grand Manitou*, *Delice*, *Lyndhurst* and *Bertha Von Suttner*, but *does not* include *Le Colosse*, *Mrs. Roosevelt*, *Dreer's White*, *Grand Duke Alexis* or similar forms, which fall into section B. of the ball-shaped double Dahlias.

3. BALL-SHAPED DOUBLE DAHLIAS

A. SHOW TYPE: Double flowers, globular or ball-shaped rather than broad or flat, full to center, showing regular spiral arrangement of florets; floral rays more or less quilled or with markedly involute (rolled in) margins and rounded tips.

(The class called *Fancy Dahlias* is not recognized separately in this classification, but is included in this Sub-section A.)

Typical examples of Show Dahlias: *Arabella*, *Dorothy Peacock*, *Gold Medal*, *John Walker*, *Colonist* and *A. D. Livoni*.

B. HYBRID SHOW, GIANT SHOW OR COLOSSAL TYPE: Flowers fully double, broadly hemi-spherical to flatly globular in form, loosely built so spiral arrangement of florets is not immediately evident; floral rays ("petals") broad, heavy, cupped or quilled, with rounded tips and involute (rolled in or forward) margins.

Typical examples: *Grand Duke Alexis*, *Cuban Giant*, *Mrs. Roosevelt*, *Le Colosse*, *W. W. Rawson* and *Golden West*.

C. POMPON TYPE: Shape and color may be same as of A. or B.; but must be under two inches in diameter.

Typical examples: *Fairy Queen*, *Belle of Springfield*, *Darkest of All*, *Nerissa*, *Little Herman* and *Snowclad*.

4. PEONY-FLOWERED OR "ART" DAHLIAS

Semi-double flowers with open center, the inner floral rays ("petals") being usually curled or twisted, the other or outer petals being either flat or more or less irregular.

Typical examples: *Queen Wilhelmina*, *Geisha*, *Hampton Court*, *Mrs. W. Kerr*, *P. W. Janssen*, and *Glory of Baarn*.

5. DUPLEX DAHLIAS

Semi-double flowers, with center always exposed on opening of bud, with petals in more than one row, more than 12, long and flat, or broad

and rounded, not noticeably twisted or curled. (Many so-called Peony-flowered Dahlias belong here.)

Typical examples: Big Chief, Souv. de Franz Listz, Merry Widow, Sensation, Prairie Fire and Hortulanus Budde.

6. SINGLE DAHLIAS

Open centered flowers, small to very large, with eight to twelve floral rays ("petals") more or less in one circle, margins often decurved (turned down or back). There are no distinctions as to colors. The type embraces the large Twentieth Century as well as the smaller English varieties.

Typical examples: White Century, Golden Century, Scarlet Century, Newport Marvel (of the large flowered forms); with Polly Eccles, Leslie Seale, Danish Cross and Ami Barillet (of the lesser flowered forms).

The Star singles and Cactus singles are omitted from the present classification scheme as not being sufficiently numerous or well defined yet.

7. COLLARETTE DAHLIAS

Open centered blossoms with not more than nine floral rays ("petals"), with one or more smaller rays, usually of a different color, from heart of each ray floret, making a collar about the disk.

Typical examples: Maurice Rivoire, Souvenir de Chabanne, Diadem, Orphee, Madame Poirier and Albert Maumene.

8. ANEMONE-FLOWERED DAHLIAS

Flowers with one row of large floral rays ("petals") like single Dahlias, but with each disk flower producing small, tubular petals.

Includes such forms as those of Graziella, Mme. Chas. Molin, Claude Barnard and Mme. Pierre Dupont.

9. OTHER SECTIONS

MINIATURE OR POMPON CACTUS: Small flowered, stellate fine petaled cactus Dahlias represented by Tom-tit, Mary, Nora, Minima. **MIGNON OR TOM THUMB:** Dwarf, bushy, single flowered Dahlias for edging. *Typical example:* Jules Closson. **BEDDING DAHLIA:** A taller, more upright type than the Tom Thumb. *Typical examples:* Barlow's Bedder and Midget Improved. **COCKADE OF ZONAL DAHLIAS:** Single or collarette Dahlias, with three distinct bands of color about center. Type hardly known in America, but includes forms such as those of Cockade Espagnole

CULTIVATION. The Dahlia is typically Fall blooming and succeeds in any location where killing frosts do not come too early. If the plants are not seriously checked in their growth by frosts, they will usually bloom very nicely in most parts of New York State, New England and the Central West. The soils best adapted to Dahlias are those which are somewhat sandy, but they will grow on heavy clay. The regions which are influenced more or less by the ocean, that is, where cool nights are prevalent, are perhaps the most noted for Dahlia growing, especially Long Island, New Jersey, Rhode Island, Maryland and Massachusetts in the East, and without a

doubt the best Dahlias we have ever seen were in British Columbia, Northern California, Washington and Oregon. Heavy soils may be lightened by coal ashes. Sand and lighter soils will benefit by manure to make them more moisture-retaining. Nitrogenous fertilizers are rarely applied, because they cause too great vegetative growth and a retarding of the flowering period.

STARTING THE TUBERS. The tubers should be started about April 1st in a warm, light room, merely placing them in a shallow box of sand or light soil. When the young shoots begin to show, they should be so cut that one or two eyes are allowed to remain on each piece; the eyes start from the collar between the old stem and tuber.



Hedge of Dahlias and typical home in Victoria, B. C.

TIME AND DISTANCE OF PLANTING. They may be planted late in April or May, according to the season. It is better to set them out late than too early. As the Dahlia makes a large plant it should be given plenty of room; even four feet by four feet is not too much if the variety is a large one. Planted much closer the plants are difficult to tend.

SUPPORTING. Use some method of support immediately when the plants are set so that they may be "brought up in the way they should go" from the very start. The average root will make several shoots. Allow them to grow until they make the first set of leaves; by that time the strongest can be selected and the others cut away below the surface. Sometimes two shoots may be allowed to grow, but never more; as a rule one shoot is sufficient. Tie the shoot to the stake when about a foot high and do not neglect tying as the plant develops, for this is very important.

FOR ATTAINING LARGE FLOWERS. If the soil is carefully and diligently cultivated there will be little need for watering, which is detrimental unless consistently practised. Thorough watering should be given each time and at regular intervals; otherwise plants will be checked and flowers will suffer.

In order that each individual flower may be as large as possible, especially in the case of the show and fancy types, which produce a great many flowers of medium size, it is best to disbud the main branches leaving only the terminal bud. It is often best to allow only six or eight branches. The singles, collarettes and pompons are rarely pruned or disbudded, the idea being to get plants with as many flowers as possible. The cactus varieties are apt to have their weak neck habit intensified by excessive pruning and disbudding, so that they should be cautiously disbudded, removing only part of the buds.

Flowers are best cut in the morning or evening and any foliage not wanted should be removed. The stems should then be placed in water up to the base of the flowers and removed to a cool place. Hard-stemmed varieties are best placed in hot water and allowed to remain until the water cools, when they should be removed to fresh cold water. Under no circumstances attempt to ship for exhibition without the pre-cooling.

STORAGE. When the Autumn killing frosts arrive, perhaps in mid-October, and the foliage is killed, take up the plants and allow them to dry a little in the sun. Cut off the old stems so that a stub of three inches is left. Then place them in a cellar where temperature will surely remain above freezing, about forty to forty-five degrees F. They may best be placed with the stems down on shelves and covered with soil or sand. With large tubers it will be unnecessary to cover them; merely place them in a heap on shelf or floor, keeping the stems to outside. Do not let them get dried out; if they shrivel, sprinkle a little water over them. If kept too moist they soon mildew.

THE RAISING OF DAHLIAS FROM SEED. This is fascinating work, particularly the single forms. Of these, if the seed is sown in a frame or greenhouse in March, the plants will come into bloom in July; and they will flower finely if the seed is sown where it is to remain, the same as most of the annuals. The seed of the double Dahlias should be sown in February or March, and the plants grown on the same as if from cuttings. With good care they will come into flower early in September, when the pleasure commences. The certainty of getting something good, and the possibility of getting a flower worthy a name, possibly better than any of the existing forms or varieties, makes this branch of floriculture more interesting than any other.

The young seedlings should be set close together, not more than

two feet apart; when they come into flower weed out such as are not desirable to keep. Another reason for close planting is that the plants do not attain in their first season as large growth as if from tubers. This does not apply to the single forms, which reach their limit of size the first season.

CHRYSANTHEMUMS

The word *Chrysanthemum* has been derived from the Greek *chrysos*, gold, and *antheon*, flower.

It is very interesting to see just how many plants are really *Chrysanthemums*. The wild Ox-Eye Daisy, the Shasta Daisy, the *Pyrethrum* (from which insect powder is made), the Feverfew of our grandmother's garden, the Marguerite or Paris Daisy of the florist, as well as the monster decorative blooms of the expert culturist indoors, are all *Chrysanthemums*.

Some of the *Chrysanthemums*, or 'Mums, as the gardener affectionately calls them, are annuals. In each case the blooms resemble huge Daisies. They are white or some shade of yellow, and often, as in the case of *Chrysanthemum carinatum*, they have a maroon or red ring of color at the center. The annual types can all be sown in April, in the open ground, where they should be thinned to eight inches, or, if large plants are wanted, pinch them back when several leaves tall, and place twelve inches apart. A rich, sandy loam suits them best and they surely love the sun.

They bloom profusely throughout the Summer and early Fall. The species known as Golden Feather (*Chrysanthemum præaltum* var. *aureum*) should be sown indoors in March and though really a perennial, it is treated as an annual. It is used as a yellow border plant.

An excellent characteristic of some perennial *Chrysanthemums* is that they reproduce themselves so nicely by the production of suckers or underground stems. One of the species which multiplies itself in this manner is the Feverfew (*Chrysanthemum Parthenium*). It is a very old plant, but it certainly bears an interesting little tufted white and yellow flower in clusters which, coming in June, is well worthy of a place in the garden. It self-sows its seed, but rarely becomes a nuisance.

Two white, Daisy-like species are well worthy of a place in your garden. The first is the Shasta Daisy (*Chrysanthemum maximum*), a gigantic white field Daisy of very vigorous growth and producing flowers from June throughout the Summer. They have very good keeping qualities and are effective in the border or as a cut flower. Another species, a shrubby Daisy (*Chrysanthemum nipponicum*),

blooms in the Fall and produces its flowers on the stems from the old shoots of the previous year.

The class known as the hardy Chrysanthemums and which resemble the indoor varieties, are of two types, the button-like or pompons, and the Aster-like or large-flowering varieties. Most of the varieties are hardy if protected in the Winter by dry leaves. They enjoy constant cultivation and a rich soil which has been deeply pre-



Iris border backed with shrubs in a semi-wild garden

pared. They are best planted in the Spring and advice is frequently given that all old plants should be divided up and reset each year, for they exhaust the soil. Good seed is now available of this type and they may be grown successfully by this method.

As soon as the plants have grown four inches tall, especially if few plants are available, and a good display is wished, they should be pinched. This will cause them to branch nicely, each shoot bearing a number of buds. From the very start in growth the plants must be staked. The greatest fault with this group is that they all fall down near blooming time and the whole beauty of the plant is destroyed

by tying them up then in an unnatural way. The shoots can easily be tied to stakes if the stakes are once in place. If the very largest flowers rather than the greatest quantity of bloom are wanted, feed them liquid manure when buds begin to show, and remove many of the smaller buds on each stem. Chrysanthemum blooms will be much better if a covering is placed over them during the cold Fall rains or on nights of frosts.

PYRETHRUMS. A very charming group of perennial Chrysanthemums is the Pyrethrum (*Chrysanthemum coccineum*), Spring Chrysanthemum, or Pink Daisy, as it is variously called. The flowers are white, pink, rose, carmine, lilac, and yellow, and are borne upon long stems, lending themselves nicely to cutting. The plants bloom in June and if the flower stems are cut soon after flowering they often bloom a little in Fall. The foliage is finely cut and attractive.

The plants are not difficult to grow, but a well drained light loam is most favorable. They appreciate good tilth and plenty of well decayed manure in the soil. The seed, if sown one Spring, will bloom the next year. The plants are sometimes troubled with slugs, which are best controlled by covering the crown with coal ashes.

IRISES

Could the real beauty of the coloring of the Iris be expressed in words, such a description would be a masterpiece. The word "iris" has come from the Greek for rainbow. It is the colors of the rainbow we deal with in growing Iris. When the form of the Iris bloom is considered we realize that it is most dainty and elegant and surpassed by few other flowers. The fragrance of many varieties is so dainty that it vies with that of any Rose. The adaptability to varying conditions, such as excessive moisture, continued drought, extended freezing and almost perfect baking, is remarkable. The rapid reproduction of most varieties is an important point in its favor. Because of all of these favorable attributes we commend the various forms of this incomparable flower.

We shall mention only the forms of easiest growth. They will be sufficient until one realizes the true range of excellence which is found in the roll of its one hundred and forty species; then you will grow Californian Iris from seed, you will erect frames especially for the proper drying of your oncocyclus Iris and no amount of labor will be too much if the new variety can only be made to bloom for you. That is for the future.

■ To appreciate the Iris one should have a little idea of what its parts are. The flower consists normally of three petals which stand

upright, and three which droop more or less; these are well named, respectively, the standards and the falls. Inside of the standards are noticed three petal-like parts; these are actually lobes of the pistil, the female parts of the flower; it is a most peculiar formation, especially when we know that the little fringed pocket at the apex of each is really the stigma or part which receives the pollen. The two-forked tip of the pistil is called the crest. Just beneath the pistil is a stamen, the male part of the flower. If we look at a German Iris we will find



The wonderful Japanese Iris (*I. laevigata* or *I. Kämpferi*), colonized. While enjoying a moist, open situation this Iris does well in a variety of soils and positions

a very heavy beard on the base of the fall, while the Japanese and Siberian Irises do not have this tuft of hairs. In some Irises the standards are very small, often smaller than the crests of the pistil. Many times the standards, though large, do not stand upright at all.

There is a notion that Irises are all water loving; this is not true. Two Irises only can be planted in the water; these are the common Blue Flag (*Iris versicolor*), our little wild Iris, and the yellow European

Iris (*Iris pseudacorus*). These two Irises may well be used in water gardens, but they will succeed perfectly in ordinary garden soil. The wild Iris is hardly as beautiful as some of the others that might be grown, but the yellow European Iris has luxuriant foliage and large, clear yellow flowers, and deserves wider popularity.

The Japanese Iris (*I. Kämpferi*) and the Siberian Iris (*I. sibirica*) thrive very nicely at the edges of pools; they will not grow with their crowns submerged, however. The flower of the Japanese Iris differs from the others in being flat, the standards not being upright. There are several forms of the flower; some have six petals and others, because the standards are much abbreviated, are called three-petaled Iris. The flowers are very large. They enjoy good fertility and a constant stirring of the soil, which should never bake over the roots. The Japanese Iris likes to be flooded when in bloom, but at no other time. They bloom later than the other sorts and varieties can be selected which bloom from mid-June till nearly the end of July.

The Siberian Iris, with its blue or white flowers and grass-like foliage, is surely a beautiful garden subject. It lends itself to being cut also. The white variety, Snow Queen, with its golden blotch on the falls, is excellent, as are also the intense blue orientalis varieties. Neither the Japanese nor the Siberian Iris is insistent upon being planted in moist soil.

Under "Bulbs" we have given a discussion of the Spanish and English Irises. Perhaps no group is so universally successful to grow, requiring so little care as does the German Iris group. They are very hardy and stand all sorts of adverse conditions, growing in the parched soil under the eaves of houses, thriving where children tramp the soil to the hardness of a cement pavement, blooming under trees choked by grass, and still giving flowers as pretty as an orchid. They should always be planted quite on the surface of the soil, and are best placed in bold groups. So rapid is the multiplication that if a fine variety costs a dollar it usually produces so rapidly that the same plant will give five or ten dollars worth of stock for another year. The dwarf varieties of German Iris are known as pumila hybrids. When the tall varieties were crossed with the dwarf varieties an intermediate group resulted, known as intermediate or interregna varieties. The blooms are large and most exquisite in color. The range of colors in German Iris is extraordinary, varying from pure white to deepest yellow, purple and violet and including delicate lavender, blue and even approaching to pink. The pumila varieties are the earliest to bloom in this group, usually early May. They are followed by intermediate, then last the tall, a few of which open in late May or early June.

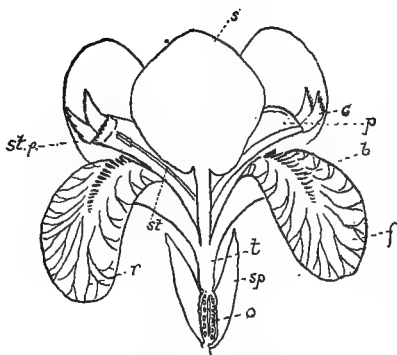

Typical German Iris Bloom

s, standard, p, pistil; c, crest of pistil; st. p, stigmatic pocket; st, stamen; f, fall; t, tube; sp, spathe valve; o, ovary; r, reticulation; b, beard.

flavescens, a very good light yellow. Various combinations of these species have given the following eight groups of German Iris: *I. variegata*, *pallida*, *florentina*, *sambucina*, *neglecta*, *squalens*, *amoena*, *plicata*. There are other bearded species of Iris worthy of culture, such as *I. mesopotamica*, *benacensis*, *cypriana*, *Kochii* and *Caterina*.

It is interesting to know that *Iris florentina*, the old-fashioned sweet, early-blooming, pale lavender-white species, is the orris-root of commerce and believed to be the original of the *Fleur-de-lis*, or French national floral emblem. The belles of ancient Greece grew it both for flowers and root, and the growing of this root is a leading industry of northern Italy. The rhizomes are dug in the Summer and peeled to remove the outer bark. The separate joints are laid aside to dry until the end of two years, when they will have acquired a delicate fragrance of Violets. The root pieces, which have a white appearance, are brought to the market of perfumers who powder them for dentifrices or sachet powders, or when distilled with water form the oil of orris, the basis of many perfumes.

Almost all Irises like sun. The best fertilizers for them are wood-ashes and bonemeal. The German Iris likes lime; the Japanese Iris is thought to not like a calcium soil. Most Irises are sensitive to active manure. After the first year there will be little need for protecting any but the weakest plants.

They are best transplanted after blooming, when the leaves have matured; this will be in August or September, not much later, for roots should become established before freezing. The Spring is

A discussion of *Iris* is not complete without a short consideration of the way the German *Iris* came about. The dwarf German *Iris* is derived from *I. pumila* and a number of other dwarf species. The tall varieties are the result of *I. variegata*, a species with yellow standards and mahogany marked falls; *I. pallida*, a very pale blue species with the two spathe valves (shown in sketch) always very papery and dry; *I. germanica*, a deep violet species, earlier than the others; *I. florentina*, a pale lavender white; *I.*

considered a poor time to move them. When Iris clumps begin to choke themselves out by covering the ground so that young shoots have difficulty in establishing roots, they should be broken up and set in another place. Due to the prolificacy of German Iris this will be necessary every third year.

SWEET PEAS

The poet has a jingle upon Peas. He says:

"Peas along the border, Peas upon the lawn,
Peas against an eastern wall to welcome in the dawn.
Peas among the Roses, Peas behind the Pinks;
Peas to catch the western glow when evening sunlight sinks.
Peas upheld with Chestnut, Peas held up with Ash;
Peas asprawl on Hazel spray, Peas on Larchen brash.
Peas on stiff, unyielding wire, Peas tied up with string;
Peas upon the trellis work where Rambler Roses swing.
Oh! merry, merry, merry, are the gay Sweet Peas;
Plant them when and how you will, it's certain they will please."

It would appear that the answer to the question of where to plant Sweet Peas is, "Everywhere." But Sweet Peas should be planted on a well drained soil only, or one in which the excessive rains of Spring will not cause water to stand around the roots and start mildew. They do not like excessive shade, for the plants should make a sturdy growth. In the shade the growth is weak and spindly and but few flowers are produced.

Place Peas, then, in the open, giving them all available light and air, although a little shade from midday suns of June and July is, of course, beneficial. Hot weather causes short stems on Peas and the best hay and grain weather makes an end of them.

THE PREPARATION OF THE SOIL is one of the most important points in the success of Sweet Peas. They like the cool soil and attempt to strike down deeply. Dig a trench two or three feet deep, break up and turn over the subsoil. Do not use it for top soil if it is poor. Put in a liberal amount of stable manure and work in a heavy dressing of bonemeal. This preparation should be made in the Fall and the bed left all Winter. When working over in the Spring give a good, liberal coating of well decayed manure or some fertilizer. If the soil is deficient in lime, dust the surface with fresh lime in Fall or Winter, using it as soon as slaked.

SOWING SEEDS IN POTS. In order to gain a month in season Sweet Peas may be sown in three-inch pots in February and placed in a coldframe. But they are generally sown a month before wanted for outdoor planting and a smaller pot is used. Four seeds are sown in each pot. The frame used should be thoroughly cleaned and dusted



Roses on arches and Sweet Peas on trellises between. On either side are Rose beds in the lawn. Iris beds in the foreground

with soot or lime. They can stand quite a lot of cold, but do not have them wet at the same time. Transplant outdoors when possible; this is usually about mid-April. Normally, the seed should be sown in open ground as early as March. As soon as the soil is warm enough the seeds will germinate.

FALL SOWING. For the Autumn sowing of Sweet Peas a piece of soil should be selected which will warm quickly in the Spring. Spade it up to good depth, two to three feet, but use no manure. Make a trench two inches deep and sow the seed thickly and cover with loose soil. When the seedlings have germinated and freezing weather has begun, cover with four inches of coarse litter or straw, which must be removed in the early Spring after heavy frosts are past. The seed should be sown so that the shoots are just at surface of the soil when Winter freezes set in, say, late in October or early in November, according to latitude.

SUMMER TREATMENT. Give frequent cultivation and when the plants are nicely budded work bonemeal into the soil along the rows. If conditions are very hot and dry give the plants frequent syringings, which will keep down the red spider, and never allow aphids half a chance. Keep the plants free from green fly.

STAKING. Many different methods are advised for training the vines. Perhaps no method is so successful as using brush or branchlets. Stretching string from pole to pole is an easy way. Such cord can be easily removed when the Peas are through blooming. Chicken wire is rather useful, but has two objections: it must be cleaned each year, and it is thought to become heated a little too much, causing the Pea vines to dry prematurely.



A BIRD BATH

in the garden in the form of a basin set upon a stone pedestal or column. Some dwarf, neat growing water plants may be kept in the basin, such as Umbrella Plant and Parrot's Feather. A stone in the bowl affords a place for the birds to stand

CHAPTER VIII

Annuals and Biennials

ANNUALS are plants the seed of which must be sown each year. Some plants, although they live more than one year, are not at their best after the first year and should be considered as annuals. The Pansy is such a plant; it is perennial, but is best when sown each year. Annuals are not permanent, it is true, but they fill a great need for profusion of bloom for garden effect. In few ways can a few cents be spent so profitably as in the purchase of a package of annual seed. They bloom so quickly and make such excellent fillers for the bare spots between our shrubs and other perennial plants that they are truly indispensable. For cut flowers they are unexcelled. Sorts may be easily chosen with long, strong stems and excellent keeping qualities, together with the daintiest or gayest colors. They commend themselves to planting near rented houses where investments for plants would otherwise be somewhat wasted.

For pot culture upon porches and areas where little space is available the annual fits in nicely. In window boxes the dwarf, compact plants are just as useful as the tall climbers. The annual vines are unrivaled in their ability to quickly cover unsightly buildings or rough ground, as well as serving for shade upon rustic arbors and porches.

In making few purchases does one need to be as careful as in the buying of seeds. They should only be bought from reliable dealers. These men aim to procure the seeds from the best plants, and those bearing the finest flowers. The matter of getting good seed must depend entirely upon our confidence in the dealer. The wise gardener avoids wasting his ground space by sowing seeds which have lain about grocery stores for any length of time. Many places are ill fitted for seed storage; seeds are resting, living plants, not pebbles.

SOWING. Many annuals, such as Petunia, Phlox, Verbena, ornamental Tobacco, China Asters, Snapdragon, Cosmos, Sweet Alyssum, Pansy, annual Larkspur, Salpiglossis, Scarlet Sage, Swan River Daisy and Torenia, benefit by being sown indoors in order to give them a growing start before placing in open soil.

March is the best time to sow. This necessitates procuring a good loam in the Autumn and storing it in the basement. The soil need not be rich, but it should be loose, which can be accomplished by the addition of well-rotted manure, or if this is not available, sifted coal

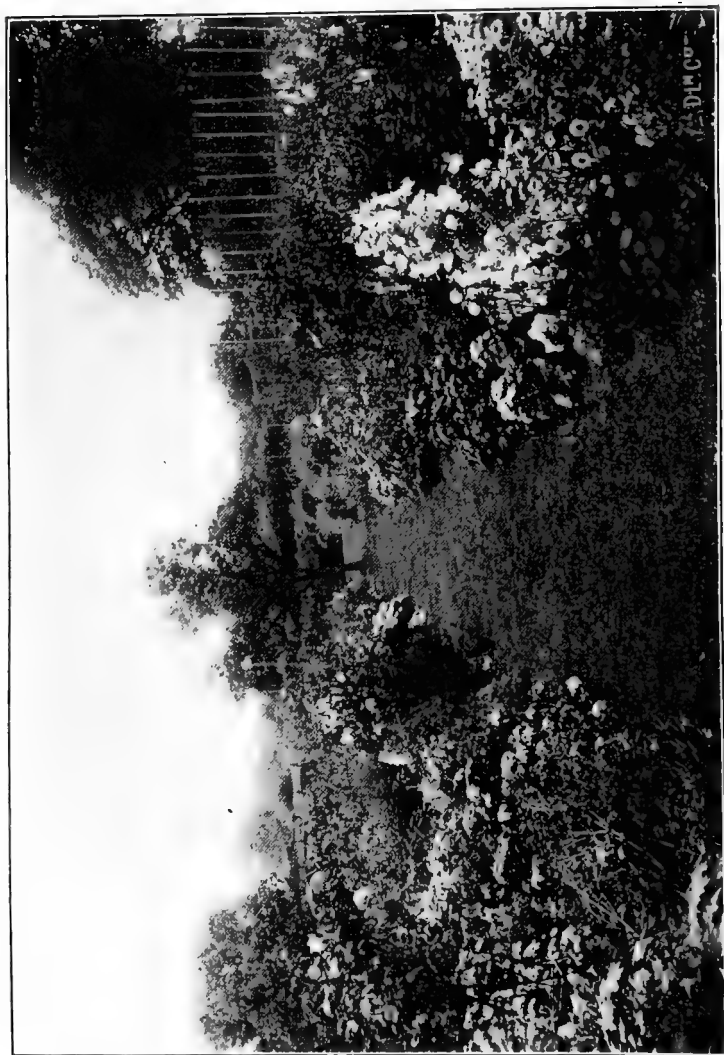

A garden of annual and perennial flowers

ashes or sand will be useful. Soil should not become dry in the basement, but should be moistened every month or oftener, according to its condition. It must not be kept too wet, otherwise it will sour badly.

Seed must always be sown thinly; thick sowing is a general cause of failure with annuals. Some seeds, as *Petunia*, *Verbena*, ornamental Tobacco, *Salpiglossis* and *Portulaca*, are very minute, and should not be covered with soil. A newspaper and a pane of glass placed over the pot or box will retain the moisture and keep the sunlight from the seed. When the seed is not covered, the soil should be thoroughly watered before sowing. Larger seeds are best sown in rows, and should be covered with soil about three times their diameter. To keep out the light and prevent the pots from drying, the use of newspaper over the pots is excellent. As soon as the seedlings get above the soil, they should be given the best light conditions, otherwise they will become very spindly and weak. Good light and rather cool conditions indoors, together with thorough but not too frequent watering, should produce stocky plants.

Excepting such as *Mignonette*, *Sweet Sultan*, *Love-in-a-Mist*, *Heliotrope*, and the Poppy-like plants, as *Eschscholtzia*, *Argemone* and *Papaver*, most annuals can be successfully transplanted. When seeds of these latter are sown they are best placed in very small pots, using only two or three seeds in a pot.

TRANSPLANTING. Seedlings may be transplanted when very small; in fact, after the appearance of several leaves, if the plants are becoming crowded, they should be transplanted into boxes about three inches deep, setting them several inches apart each way. The earliness of sowing the seed will govern the amount and need for transplanting. Transplanting is beneficial to many seedlings because it causes the root tips to branch, making a well balanced root system.

TIME TO SOW OUT-OF-DOORS. When the soil is warmed a little in the Spring most annuals can be sown directly in the open soil; but a few are tender, that is, they will stand very little cold and should never be planted till all danger of frost is past. Among these are: *Amaranth*, *Browallia*, *Celosia*, *Torenia*, *California Poppy*, *Gourds*, *Butterfly Flower*. These are all tender.

PREPARATION OF SOIL. The soil should not merely be loosened by a rake, but if good flowers are wanted, thorough preparation should be given and decayed manure added. After many of the annuals have grown two or three leaves tall, they will benefit by being pinched back; in other words, the main shoot should be cut out. This will cause the plants to become branchy and bear three times as many flowers. Especially successful is pinching such plants as *Stock*, *Nemophila*, *Butter-*

fly Flower, Petunia, Baby's Breath, annual Chrysanthemums, Clarkia, Cosmos, Godetia, Salpiglossis, Swan River Daisy and Calliopsis.

KEEPING SEED PODS REMOVED. Annuals soon accomplish their growth and hastily decline if their seed pods are not carefully removed. Many of them may continue to bloom throughout the Summer if careful attention is given this detail.

VINES. The annual vines form an important garden adjunct. The most important plant in this class is the Sweet Pea, and, perhaps, the next in value is the Nasturtium, which not only has excellent foliage, but at the same time is without a competitor for profusion and elegance of bloom. The Morning Glory (see p. 101) would be more valued but for the fact that inferior varieties are too often grown. Excellent giant forms, clear blue in color, are on the markets, which for a morning effect upon the garden fence are very attractive. The Cobæa is really a tender perennial, but does best sown in pots and started indoors each year. The seeds are flat and should be placed edgewise. The flowers are greenish purple and followed by attractive pods. The plants make a phenomenal growth. Another vine with inflated pods is the Balloon Vine. Although the flowers are inconspicuous, the balloons are borne very freely. The Cypress Vine and the Cardinal Climber both possess deep red flowers and fine foliage. The seeds of both are rather difficult to start, but if those of the Cypress Vine are scalded there should be little difficulty. The familiar Hop, Scarlet Bean and Gourds should not be forgotten. If one prefers something rather extraordinary and unique, the Canary Bird Vine (*Tropæolum peregrinum*) with its peculiar yellow fringed flowers and delicate foliage, should be grown.

COMBINATIONS OF ANNUALS. It is hardly ever advisable to buy mixed colors of flowers; it is much better to buy packages of good separate colors and mix them. Nothing is prettier than huge masses of one color. Bicolor or variegated flowers are to be avoided, because they often give a dull appearance as seen in beds.

Let us make a few recommendations for combinations of annuals or ways in which they give the best effects:

In making beds for annuals they should not be too wide; if against a fence, four or five feet, and if in the open, six or seven feet, is sufficient; otherwise, they cannot be handled easily either for picking the flowers or for cultivating and weeding. Few annuals can be sown so that they are exactly the proper distance apart when they bloom. They must, therefore, be thinned. According to the variety they all need from six to eighteen inches between plants. Poppy beds are always too thickly planted, for Poppy seed is very fine and difficult to sow properly. They must be thinned if the Poppies are to attain their proper development.

A bed of blue Bachelor's Buttons can be nicely edged with Sweet Alyssum or Candytuft, both of the latter being white. The Bachelor's Buttons will furnish a constant supply of cut flowers.

Snapdragon, of which a delicate pink variety, perhaps, is chosen, will be excellent combined with Dusty Miller.

Another bed will be showy, composed of California Poppies planted in front of the taller pot Marigolds. This will be in tones of orange-yellow.

Entire beds, perhaps five by ten feet, of Verbenas, planted 12 inches apart each way, will prove very effective.



Foxgloves are hardy biennials; they seed and reproduce themselves freely

Grow a fine lot of young Drummond's Phlox plants, a white variety, and after filling a bed with them placed eight inches apart, plant bulbs of the pink variety America Gladiolus between the plants.

Into your bed of Pansies transplant a few of the dainty blue *Browallia demissa*; this will cast a very light and airy effect over the whole bed.

On some narrow strip, where there is little room, try *Godetia Rosamond* with its satiny pink flowers by itself. You will be rewarded by a very pretty display.

A huge bed of *Nicotiana glauca*, the ornamental Tobacco, near a porch where you can get the great fragrance in the evening, is very satisfactory. The *Nicotiana* self sows and it will be necessary to keep these in check.

In a hot, sunbeaten, dry place, sow the *Portulaca* or Sunplant. The metallic seeds self sow and the plant will come up year after year. This is the old-fashioned "Seven Sisters" plant which some persons fancy bears seven colored blooms on one plant.

In some pots, to be placed on posts or on a wall, plant a few of the trailing *Lobelias* (*Lobelia erinus*) or a few *Nasturtiums*.

In some corner where you want something out of the ordinary, plant a few seeds of the Giant Spider plant (*Cleome*). The flowers are rosy crimson, and possess long filaments and pistils followed by long, slender seed pods. They are strong, attractive, but a trifle weedy.

Edge a bed of *Cannas* or other tall plants with Fountain Grass (*Pennisetum*).

To combine with bouquets, grow a little clump of Cloud Grass (*Agrostis nebulosa*).

For the Sweet Pea bouquets do not neglect planting some Baby's Breath (*Gypsophila elegans*). This will look well grown in a bed with annual Larkspurs or with Stocks. Baby's Breath must be planted several times during the season if a continuous supply is needed.

Some persons admire small hedges of Summer Cypress, or *Kochia*, but this plant turns a very bad bluish-crimson color in Autumn—a color which harmonizes with nothing.

When the season does not prove too moist, or when planted upon sandy soils, the dwarf or cupid Sweet Peas are excellent. They bear rather long stems and very good flowers.

No annual flower blooms for so long a time as the *Petunia*. If the colors can be selected before setting the plants into the bed, the results will be better. It will be unnecessary to combine them with anything else, as they are all-sufficient, and are as useful for beds two feet square as for huge borders a hundred feet long and four wide.

Where a dainty blue edging plant is wanted, use Swan River Daisy, (*Brachycome*), placing the plants about six inches apart.

If you must neglect your garden, but want a good show of color, try huge beds of *Zinnias* or *Marigolds*.

If you wonder what to use for edging any bed, decide to use Sweet Alyssum; it is a most adaptable border plant. When it appears to be nearly through blooming, cut it back and it will start up again.

It is only proper to take away a little of the enthusiasm for annuals by reading from the delightful book by Geo. W. Cable, known as "The Amateur's Garden." He quotes a man as saying: "I have seen a house, whose mistress was too exclusively fond of annuals, stand waiting for its shoes and stockings from October clear round to August, and then barefooted again in October. In such gardening there is too much love's labor lost. If one's grounds are so small that there is no better place for the annuals they can be planted against the shrubs, as the shrubs are planted against the building or fence. At any rate, they should never be bedded in the midst of a lawn."

EVERLASTING FLOWERS

It is always interesting to grow a few everlasting or "straw" flowers. If they are picked in their proper stages, the leaves removed and the

blooms hung upside down to dry, they will present a pretty appearance all Winter. The principal annual specimens are:

HELICHRYSUM BRACTEATUM (Straw Flower). One of the largest everlasting flowers. There are many shades of yellow and red. They grow two to three feet tall and need to be planted one foot apart if they are to develop properly. They should be picked before they are fully open.

HELIPETERUM ROSEUM. Bears dainty white and rosy pink flowers. They should be cut when quite in bud; they open a little after being picked, otherwise the centers are visible and being brown gives a shabby appearance to the otherwise attractive flower. It is pretty for the border, aside from its being good for the Winter bouquet.

HELIPETERUM MANGLESII (Rhodanthe) (Swan River Everlasting). The flowers are pink and white; the stems are very graceful.

HELIPETERUM HUMBOLDTIANUM. Bears a yellow flower, smaller than others but numerous.

GOMPHRENA GLOBOSA (Globe Amaranth). The straw-like heads resemble Clover. The two colors are a crimson and a rather muddy white.

XERANTHEMUM ANNUM (Everlasting or Immortelle). Bears rose, purple, and white flowers. As a garden subject they retain their bloom from early Summer till frost.

CATANANCHE CÆRULEA. Blue and yellow varieties are available. Somewhat resembles Bachelor's Buttons.

USEFUL FOR CUT FLOWERS

The flowering annuals are useful for cutting because they have long stems, good keeping qualities or excellent colors. They commend themselves admirably for arrangements in the low bowls which are beginning to be used and are of such great value for a proper loose display of flowers.

ACROCLINIUM (See *Helipeterum roseum*).

AFRICAN DAISY (See *Arctotis*).

ANTIRRHINUM (Snapdragon). This is gaining greatly in its deserved popularity. Almost all the colors are good.

ARCTOTIS GRANDIS (African Daisy). This is a very handsome Daisy-like annual, the flowers of which are a bluish white, the under surface being rather bluish gray. The buds open nicely after the flowers are cut.

AMETHYST (See *Browallia*).

ANNUAL LARKSPUR appears in superb pinks, blues, lavenders and has dainty foliage and good keeping qualities.

BABY'S BREATH (See *Gypsophila*).

BACHELOR'S BUTTON (See *Centaurea*).

BLANKET FLOWER (See *Gaillardia*).

BROWALLIA DEMISSA (Amethyst). A very graceful little blue or white annual which is prettily used in bouquets.

BUTTERFLY FLOWER (See *Schizanthus*).

CALENDULA OFFICINALIS (Pot Marigold). Bear strong, golden orange and lemon colored flowers. They will bloom for a long season if the seed pods are kept off.

CANDYTUFT. The varieties are pure taffy white as well as lavender and crimson. They are very useful for all sorts of cut flower purposes.

CASTOR OIL BEAN (See Ricinus).

CENTAUREA (See Senecio).

CENTAUREA CYANEA (Bachelor's Button). Furnishes some of finest blues. Is an excellent keeper when cut.

CENTAUREA IMPERIALIS and **AMERICANA** (Sweet Sultan). Dainty rose, light lavender and white thistle-like flowers; long stems; excellent for vases and baskets.

CHINA ASTER. This is perhaps the very best annual for cutting.

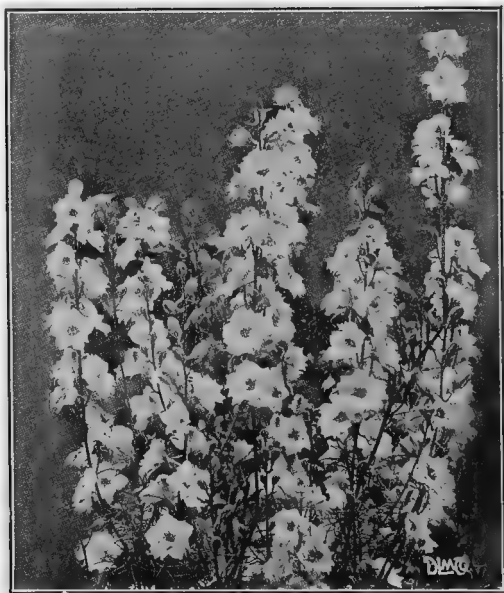

Delphiniums from seed

COREOPSIS TINCTORIA, DRUMMONDI (Coreopsis, or Calliopsis). Appears in excellent golden and maroon color combinations. The stems are long and wiry.

CORN, VARIEGATED (See Zea).

COSMOS. One of best tall annuals, and one of the latest to bloom, is Cosmos. Procure the earliest varieties for Northern planting.

DUSTY MILLER (See Senecio and Centaurea).

EVERLASTING (Applied to Helichrysum, Helipterum, Xeranthemum and some others).

FORGETMENOT. This dainty blue flower has a greater hold upon our sentimental admiration than almost any flower except the Rose.

FOUNTAIN GRASS (See Pennisetum).

- GAILLARDIA** (Blanket Flower). Resplendent in shades of orange and scarlet.
- GLOBE AMARANTH** (See *Gomphrena*).
- GODETIA**. Excellent satiny petals and some very good colors appear.
- GYPSOPHILA** (Baby's Breath). Unexcelled for bouquets. The fine, misty, white flowers lend to any decoration a grace which cannot be duplicated by any other annual.
- IMMORTELLE** (See *Xeranthemum*).
- LOVE-IN-A-MIST** (See *Nigella*).
- LOVE-LIES-BLEEDING** (See *Amaranthus*).
- LUPINES**. Free flowering. There are excellent pink, blue and light yellow varieties.
- MARIGOLD, African**. This flower is rather coarse, but always thrifty.
- MARIGOLD, Pot.** (See *Calendula*).
- MIGNONETTE** is indispensable because of its supreme fragrance. The less beautiful kinds are apt to be the most fragrant.
- NASTURTIUM**. For brilliancy of color, prolificacy of bloom and novelty of form, few flowers can rival the *Nasturtium*.
- NIGELLA DAMASCENA** (Love-in-a-Mist). Excellent fine foliage and pretty blue flowers.
- PANSY**. It must be borne in mind that Pansy seed only grows during the cool, early days of Spring or Fall. It must be planted accordingly.
- PAPAVER RHÆAS** (Shirley Poppies). With their silky petalage and good colors, these make good cut flowers if picked when in bud.
- PHLOX DRUMMONDI** (Phlox, Drummond's). The real, brilliant, clear colors of this annual Phlox are admirable for small vases.
- POINSETTIA HETEROPHYLLA** (See *Euphorbia*).
- POPPIES, SHIRLEY** (See *Papaver Rhæas*).
- RHODANTHE** (See *Helipterum Manglesii*).
- RIBBON GRASS** (See *Phalaris*).
- SCABIOSA** (Scabious). Excellent long stems—good colors lend themselves to pretty vase decorations.
- SCABIOUS** (See *Scabiosa*).
- SCHIZANTHUS** (Butterfly Flower). One of the fairy-looking flowers. Give a little shade in the garden.
- SNAPDRAGON** (See *Antirrhinum*).
- SQUIRREL'S TAIL GRASS** (See *Hordeum*).
- SUMMER CYPRESS** (See *Kochia*).
- STRAW FLOWER** (See *Helichrysum*).
- SWEET PEAS**. An ideal annual; see special article.
- SWEET SULTAN** (See *Centaurea imperialis*).
- TAGETES** (See *Gamolepis*).
- TARWEED** (See *Madia elegans*).
- WISHBONE FLOWER** (See *Torenia*).
- YOUTH AND OLD AGE** (See *Zinnia*).
- ZINNIA** (Youth and Old Age). A universally admired flower because of its rich appearance and ease of culture.

LESSER KNOWN ANNUALS

For those who have tried the commonest annuals, a few others of interest should be mentioned. Each year the catalogues list a new

introduction from other countries or a unique series of hybrids. These novelties are sometimes excellent, but being expensive and of doubtful value for the changed climates and soils, they should be bought only as experiments and not planted directly into beds in which a good show must be depended upon.

The plants in the following list are not especially new, but are rarely seen in our gardens, although they have a value:

ALONSOA ACUTIFOLIA. Attractive coral colored flower; compact plants.

ANCHUSA CAPENSIS (Cape Alkanet). Very pretty, minute blue flowers, but tend to go to seed rapidly.

ARGEMONE GRANDIFLORA (Mexican Prickly Poppy). Foliage spiny; flowers yellow.

CACALIA COCCINEA (See Emilia).

CERINTHE RETORTA. A unique annual bearing spotted leaves and yellow tubular inverted flowers, tipped with purple.

DIASCIA BARBERÆ. Bears a rose or orange colored spurred flower.

EMILIA FLAMMEA (*Cacalia coccinea*) (Tassel Flower). An intense scarlet. Should be planted at least four inches apart. Self sows.

ERYSIMUM PEROWSKIANUM. One of deepest orange colored annuals. Earliest culture.

GILIA CAPITATA. The light drab flowers are borne in miniature heads.

LAYIA ELEGANS. Pretty dwarf yellow annuals, with flowers about an inch in diameter.

MADIA ELEGANS (Tarweed). Very distinct yellow flowers and glandular heavily scented foliage.

MENTZELIA LINDLEYI (*Bartonia aurea*). Yellow flowers. Plant where they are to grow. Fragrant in evening.

NEMOPHILA INSIGNIS. Excellent pure deep blue.

PHACELIA CAMPANULARIA. Bears blue flowers resembling the Canterbury Bells.

POINSETTIA HETEROPHYLLA or PAINTED LEAF. Leaves are dark green, except the upper, which are bright red at the base.

SALVIA FARINACEA. Very pretty foliage and almost white flowers.

SANVITALIA PROCUMBENS. A dwarf, compact annual, useful for edging; very prolific of blooms.

TORENIA FOURNIERI (Wishbone Flower). A very pretty blue or white, yellow spotted flower.

ANNUALS FOR EDGING BEDS OF OTHER PLANTS

AGERATUM	DWARF SNAPDRAGON	PETUNIA
ANNUAL PHLOX	FRENCH MARIGOLD	PORTULACA
CALIFORNIA POPPY	LOBELIA (<i>Lobelia eri-</i>	SANVITALIA
BABY'S BREATH	<i>nus</i>)	SCARLET PHLOX
CALLIOPSIS (Dwarf)	MADAGASCAR PERI-	SWAN RIVER DAISY
CANDYTUFT	WINKLE (<i>Vinca ro-</i>	SWEET ALYSSUM
DWARF MARIGOLD	<i>sea</i>)	VERBENA
(<i>Tagetes signata</i>	NASTURTIUM TOM	
<i>primula</i>)	THUMB	

FOLIAGE ANNUALS

RICINUS COMMUNIS (Castor Oil Bean). One of the tallest, most rampant growing annuals.

SENECIO CINERARIOIDES and **CENTAUREA GYMNOCARPA** (Dusty Miller).
Unexcelled for gray effects.

PENNISETUM (Fountain Grass). Dainty and graceful hairy spikes.

AMARANTHUS CAUDATUS (Love-Lies-Bleeding). Foliage deep maroon often.

MEXICAN HORNED POPPY. The deep green leaves are veined with white.

PHALARIS ARUNDINACEA, VAR. **PICTA** (Ribbon Grass). A very useful grass for bouquets as well as landscape effect.

HORDEUM JUBATUM (Squirrel's Tail Grass). Spike resembles a squirrel's tail. Adds a very graceful touch to the border or bouquet.

KOCHIA TRICHOPHYLLA (Summer Cypress). Makes a formal cypress-like plant. In Autumn turns a bluish crimson, at which time it seems a poor color.

ZEA MAYS JAPONICA (Variegated Corn).

BIENNIALS. There is a class of plants which lives but two years. The seed can be sown the Summer or early Autumn one year; the



Hedge of Morning Glories

young plants form a rosette of leaves but do not bloom until the following year, after which they usually die. Such plants are called biennials.

- One of our commonest garden plants is a biennial, namely, Foxglove. Many other plants are best treated as biennials, as, for

example, some Campanulas, Hollyhocks, Anchusa and Sweet William, all of which decline at two years. There are few plants to rival the Foxglove; it possesses such excellent foliage that nothing need ever be planted at its base; besides, the stately spires of inverted glove fingers are most attractive.

Biennials are best protected by pulling the leaves together and packing straw between them, in which case they seem to Winter nicely. If poorly protected the center of the plant decays, leaving it hollow; the stems then do not become strong enough to bear the truss of bloom; at the same time the excellent foliage is entirely gone. This is too often the case with the beautiful Canterbury Bells (*Campanula Medium*), which should not be too thickly covered but properly handled.

GERMINATION TABLE†

5 days	8 days	10 days	15 days	20 days	25 days	30 days	50 days	Indefinite
a	b	c	d	e	f	g	z	*
Days			Days			Days		
Abutilon.....	e	Cockscomb.....	e	Ivies.....	*	Jack-and-the-Beanstalk.....	d	
Acroclinium.....	d	Coix lachryma.....	*	Japanese Bean.....	d	Japanese Hop.....	d	
African Golden Daisy.....	d	Coleus.....	e	Japan Iris.....	*z	Jerusalem Cherry.....	*e	
Agapanthus.....	e	Columbine.....	d	Job's Tears.....	*	Kenilworth Ivy.....	a	
Agathæa cælestis.....	e	Commelina.....	c	Kochia scoparia.....	d	Kudzu Vine.....	d	
Ageratum.....	a	Coreopsis.....	e	Lantana.....	d	Larkspur.....	d	
Alyssum.....	a	Cornflower Aster.....	*	Lathyrus.....	f	Lavender.....	e	
Ampelopsis.....	d	Cosmos.....	a	Lemon Verbena.....	b	Linaria.....	a	
Anchusa.....	e	Crimson Flax.....	b	Linum.....	b	Lobelias.....	b	
Anemone, St. Brigid.....	d	Cuphea.....	*b	Love-in-a-Mist.....	b	Lychnis.....	e	
Antirrhinum.....	e	Cyclamen.....	f	Mallow Marvels.....	*d	Marigold.....	a	
Aquilegia.....	d	Cyperus alternifolius.....	f	Marvel of Peru.....	a	Maurandya.....	*f	
Arctotis grandis.....	e	Cypress Vine.....	a	Mexican Fire Plant.....	e	Mesembryanthemum.....	*a	
Asparagus.....	g	Dahlias.....	a	Mignonette.....	a	Mimosa.....	b	
Asters.....	b	Daisies.....	e	Mimulus.....	b	Mina lobata.....	a	
Asters, Perennial.....	d	Daturas.....	d	Mirabilis.....	a	Monkey Flower.....	e	
Baby's Breath.....	e	Delphinium.....	d	Monardella.....	e	Moonvines.....	a	
Ball of Fire.....	d	Dianthus.....	a	Morning Glory.....	a	Mountain Honey-suckle.....	e	
Bachelor's Button.....	*a	Digitalis.....	e	Mourning Bride.....	e	Musk Plant.....	e	
Balloon Vine.....	f	Dimorphotheca.....	d	Nasturtium, Dwarf Tall.....	b	Nicotiana.....	b	
Balsams.....	c	Dolichos.....	d	Nigella.....	b	Oenothera.....	a	
Begonias.....	d	Dusty Miller.....	*a	Ornamental Grasses.....	*	Ostrich-Plume.....	e	
Bellis perennis.....	a	Echinocystis.....	*g	Oxalis.....	e	Palm.....	d	
Boston Ivy.....	d	English Double Daisy.....	a	Painted Tongue.....	a	Pansies.....	b	
Blanket Flower.....	e	Eschscholtzia.....	a	Passion Flower.....	z	Peas, Sweet.....	d	
Blue-eyed Daisy.....	e	Euphorbia.....	e	Pelargoniums.....	e	Pentstemon.....	e	
Blue Day Flower.....	e	Evening Primrose.....	a	Perennial Peas.....	f	Petunias.....	e	
Blue Salvia.....	*d	Everlasting Flowers.....	*	Pheasant-Eye Pink.....	a			
Brachycome.....	b	Feverfew.....	a					
Brazilian Morning Glory.....	*b	Fire-Cracker Plant.....	*b					
Browallia.....	e	Fire-on-the-Mountain.....	e					
Brugmansia arborea.....	d	Forget-Me-Not.....	d					
Bush Eschscholtzia.....	b	Four O'Clock.....	a					
Butterfly Pea.....	d	Foxglove.....	e					
Cactus.....	g	Fuchsia.....	*g					
Calendula.....	c	Gaillardia.....	e					
California Poppy.....	b	Geraniums.....	e					
Campanula.....	b	Gloxinia.....	d					
Canary-bird Flower.....	*	Godetia.....	d					
Candytuft.....	a	Gourds.....	d					
Cannas.....	*d	Grass Seed.....	*					
Canterbury Bells.....	*d	Gypsophila.....	e					
Cardinal Climber.....	a	Helianthus.....	e					
Carnations.....	b	Helichrysum.....	a					
Carnations, Perennial.....	b	Heliotrope.....	d					
Castor Beans.....	d	Heuchera sanguinea.....	e					
Celosia.....	e	Hibiscus.....	*d					
Centaurea.....	*a	Hollyhocks.....	a					
Centrosema.....	d	Hop, Japanese.....	d					
Chinese Bellflower.....	e	Horn of Plenty.....	d					
Christmas Orchid Flower.....	e	Humble Plant.....	b					
Chrysanthemums.....	a	Hunnemannia.....	b					
Cigar Plant.....	*b	Hyacinth Bean, Japanese.....	d					
Cineraria.....	a	Ice Plant.....	*a					
Clematis, Tuberosus.....	*g	Impatiens Sultani.....	d					
Cleome pungens.....	e	Ipomœas.....	a					
Cobæa scandens.....	d	Iris.....	*z					

(†From the Catalogue of Conard & Jones)

GERMINATION TABLE

103

	Days		Days		Days
Phlox.....	e	Scarlet Sage.....	*d	Sweet Peas.....	d
Pinks.....	a	Schizanthus.....	e	Sweet Sultan.....	*a
Platycodon.....	*g	Seeds for Vases and		Sweet William.....	c
Poppies.....	e	Baskets.....	*	Ten-Weeks Stocks....	
Portulaca.....	e	Sensitive Plant.....	e	Umbrella Plant.....	
Primroses.....	*d	Shasta Daisy.....	e	Verbena.....	b
Primulas.....	*d	Smilax.....	d	Vinca.....	*
Pueraria Thun-		Snapdragon.....	e	Violas.....	*
bergiana.....	d	Solanum.....	*e	Violets.....	*
Ragged Robin.....	e	Spider Plant.....	e	Wallflower.....	a
Illeceus.....	d	Stocks.....	a	Water-Lilies.....	*
Rose.....	*	Stokesia.....	*	Wedding Bells.....	d
Rose, Moss.....	e	Straw Flower.....	a	Wild Cucumber Vine..	*g
Salpiglossis.....	a	Summer Bush Cypress	d	Youth and Old Age...	a
Salvia.....	*d	Sunflower.....	d	Yucca.....	*
Scabiosa.....	e	Sun Plant.....	e	Zinnias.....	m
Scarlet Runner.....	b	Swan River Daisy....	b		



An early Summer scene

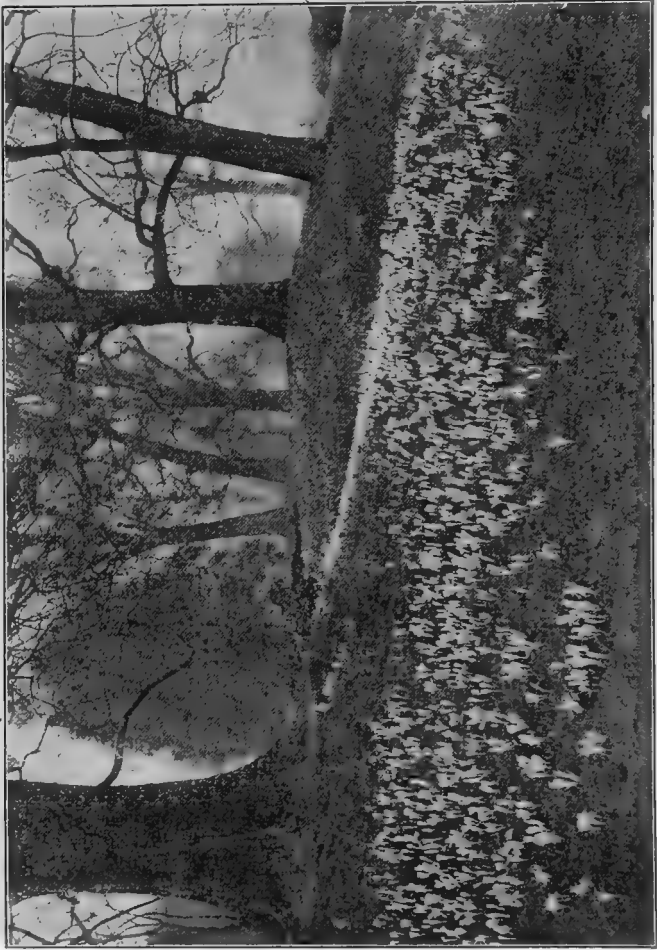

Although it is not often that we see Crocuses naturalized in the grass in such abundance as shown in this photograph, yet they, with Tulips and Daffodils, can be successfully grown in this way

CHAPTER IX

Bulbs and Tuberos-Rooted Plants

THE growing of bulbs is real fun. They are nearly mature plants all grown when we buy them; many of them even have stored in them the food for the leaves, flowers and roots. All we need to do is to place them under some favorable conditions for growth; then they send out their roots and by merely absorbing water produce their blooms. They are useful for the woods, the lawn, the border, the water garden, the rockery and the window in Winter; in fact, they have a most unusual adaptability.

Many readers will never try a single new bulb nor even read about any plant which is strange to them. They will never try an attractive clump of *Eranthis hyemalis*, the Winter Aconite, that very bright, cheery yellow flower of February or March; nor would they know of the striped *Scilla*, the *Puschkinia libanotica*, a dainty blue and white flower, which is of value but little known. Our suggestion is to try a few of the bulbs in the list which follows. They have been chosen because they are really good.

PREPARATION OF BEDS FOR BULBS. Bulbs may be grown on a great range of soils. They succeed especially well on the sandier loams, but will even grow on nearly pure sand or heavy clay. The heavy clay soils are easily loosened by the addition of sand or coal ashes. Manure if used at all must be so thoroughly incorporated with the soil that it is impossible for any of it to be in contact with the roots, or bulbs, both of which appear to be very sensitive to manure. Bonemeal, spread over the soil at planting, is excellent. Leafmold is ideal for mixing with the soil if it is obtainable.

TIME OF PLANTING. Some bulbs do not stand the cold; they are planted in Spring and must be dug before Winter each year. Examples of such bulbs are: *Gladiolus*, Summer Hyacinth (*Galtonia candicans*), *Montbretia*, *Tigridia*, *Tuberose*, *Zephyranthes*, tuberous *Begonia*, *Canna*, *Dahlia*. Most other bulbs should be planted in the Autumn. It is best to plant them as soon as they can be obtained from the dealer. If they remain out of the soil too long much of the nourishment is evaporated. Especially susceptible to deferred planting are *Crocus*, *Lilies*, *Snowdrops* and *Fritillaria*. This will bring the greater share of bulb planting in October.

PLANTING BULBS. The rule for depth of planting is that they

should be planted twice their diameter deep in the soil. This does not always apply, for it is usually better to get them a little deeper. The useful chart or diagram on page 111 shows the depth to plant. It is advisable in planting choice sorts to set them on a layer of one or two inches of sand. This will insure good drainage and keep bulbs from decaying.

NATURALIZING BULBS. For parks, groves, meadows and wild outlying grounds beyond the closely clipped lawn, a very pleasing style of naturalizing bulbous plants is coming much in vogue. Such bulbs should be used as can be planted in quantity, twenty-five to a hundred or more of a kind in a patch, and only sorts should be used as are hardy and will flower and thrive and increase with neglect; fortunately, in bulbous plants there are many that succeed even better in such rough places than in the prim garden; among them we will mention hardy Anemones, Crocus, Chionodoxas, Camassias, Convallarias, Daffodils, Dicentras, Erythroniums, Funkias, Liliums, Narcissi, Scillas, Snowdrops, Trilliums, and some of the late-flowering Tulips. The bulbs may be dibbled in when the ground is moist and soft during the Fall rains, but it is better to cut and turn back the sod here and there, place the bulbs under and press the sod back again.

CULTURE DURING THE SEASON. When the bulbs are in bud a little liquid manure is very beneficial, resulting in a larger sized bloom. After blooming, the leaves must mature if the bulbs are to be depended upon for bloom another year. If it is absolutely necessary to remove the tops before they are brown the bulbs should be dug and heeled in or replanted in an out-of-the-way spot. They can remain here till the Fall planting time.

MULCHING AFTER PLANTING. When cold weather has set in and there is a crust frozen over the bed, a mulch of leaves, straw or like material should be used to the depth of three or four inches. It serves to protect from the destructive alternate freezing and thawing. (See discussion of Winter Protection on pages 197 to 199.)

CAMASSIA ESCULENTA (Indian Quamash). This is a very dainty blue-flowering bulb, perfectly hardy. It blooms in the latter part of Spring and makes a good border subject. Plant the bulbs about three inches deep where they may have abundant moisture.

CHIONODOXA (Glory of the Snow). Species: *Luciliae*, light blue, white center; *sardensis*, dark blue. The Chionodoxas are very closely allied to the Scillas and might easily be confused with them. They are early flowering, March or April, and are very effective when planted in huge clumps in the border. For a small bulb they may be planted quite deeply—perhaps four to five inches is not too deep. They should be replanted every third year, else they run out.

CROCUS. Species: *vernus* and *Susianus*. The Crocus is as universally admired as any bulbous plant because it can be planted in great pro-

fusion without much expense. The varieties are so bright and cheerful that they are excellent planted either in lawns, in the herbaceous border or under trees. Especially attractive are bold clumps of one variety near evergreens when they are branched to the soil. Crocuses must be planted in an open place in order to have them flower. New bulbs are produced above the old ones each year and the plant becomes higher and higher in the soil; they should thus be transplanted every third year. Good varieties are: King of Whites, white; Sir Walter Scott, white, reticulated lavender; Albion, purple; Cloth of Gold, yellow.

CROWN IMPERIAL. (See *Fritillaria imperialis*.)

ERANTHIS HYEMALIS (Winter Aconite). This yields very cheerful yellow,



Even the small backyard gardens can have a delightful display of choice Tulips, Narcissi and other bulbs. You have only to buy them and plant them

star-shaped flowers and is very hardy, liking best to be planted in partial shade. It blooms as soon as the frost is out of the ground, whether it is February or April. Plant the small bulbs in clumps, otherwise they do not make a proper showing.

EREMURUS (The King's Spear). Species: *robustus* and *himalaicus*. This is a very stately subject for the garden. The spikes are frequently six to eight feet tall and are covered with white, pink or yellowish flowers, which continue to open for nearly a month. For some reason they are difficult to grow. Certain of the plants rapidly multiply and bloom, while others die out entirely. The bulbs should be planted rather shallow, in a fairly rich but very well drained soil. These plants are native to desert spots of Western and Central Asia. The matter of Winter protection is important, for the plants should be



This represents a typical flower of a single Daffodil often, but wrongly, called Jonquil. The Jonquil much more resembles the Paperwhite, except that it is yellow. Daffodils are a large study in themselves

They should be planted about four or five inches deep and on their sides, because they often decay easily. The bulbs should be set on several inches of sand. They enjoy a rather rich soil and when once established grow very easily. If the flower stem is a trifle weak give a little staking of some sort. Single and double, orange, scarlet and yellow varieties can be had.

One fact, before leaving the Crown Imperials: They are often called Skunk Lilies. The reason is easily guessed if one inhales the odor of the flowers or bulbs. This is hardly objectionable, however, if one does not get too close to the plants.

GALANTHUS (Snowdrop). Species: *nivalis* and *Elwesii*. Not that the Snow drop is really pretty, but because it is the first flower of Spring to bloom, we admire the little white inverted bells as they peep through the snow. We plant it usually in huge clumps, for the individual flowers or plants are too tiny for a show. These clumps increase very rapidly. If planted in different exposures an excellent succession of bloom is afforded.

GALTONIA CANDICANS (Summer Hyacinth). Here is a bold, stately, bulbous plant which is very admirably used in the back line of a border. The tall spikes of inverted white bells give a very pleasing effect, and seem to contrast most exquisitely with many of the medium tall growing perennials, such as *Monarda* and *Coreopsis*, or with annuals such as *Bachelor's Buttons* and *Snapdragons*. The bulbs are not strictly hardy and must be dug each Autumn and planted the following Spring. Placing the bulbs about five inches deep serves to give the tall stems the proper support. It is frequently noted that the bulbs are not sure blooming, year after year. After blooming one year they frequently rest a year before blooming again. It is perhaps advisable to buy a new stock each year.

GLORY OF THE SNOW. (See *Chionodoxa*.)

HYACINTHUS ORIENTALIS (Hyacinth). For garden culture many persons feel that the Hyacinth is a trifle stiff and formal, but there is a group known as miniatures, which are useful. They are cheaper and graded

covered with leaves during the Winter and left till quite late, otherwise the young shoots will often be injured. The roots are quite fleshy and spread out in several directions; they should be planted as soon as received in November.

FRITILLARIA IMPERIALIS (Crown Imperial). The Crown Imperial, which was such a familiar feature of the gardens of our grandfathers' time, has been very much neglected of late. It is so stately that this is extremely strange. In the Spring, when the bulbs start into growth, the stem elongates very rapidly until finally it is surmounted by a crown of flowing bells and a tuft of leaves. They are very interesting as seen in the distance, but even more so when examined carefully close at hand. The bulb seems very susceptible to any sort of injury and should not be kept out of the soil for any length of time.

from the larger size bulbs. The spikes of the miniatures are graceful and produce a very pretty, loosely arranged spike of bloom. They are adapted to informal planting in the border and are useful for cutting. The larger varieties are known as Dutch Hyacinths and are adapted for more regular and formal planting. The Hyacinth appreciates a lighter soil than most bulbs, and it is advised to set the bulbs on a thin layer of sand. They, of all the bulbs, need protection in Winter.

HYACINTH. (See *Hyacinthus orientalis*.)

INDIAN QUAMASH. (See *Camassia esculenta*.)

IRIS XIPHIODES and **XIPHUM** (English and Spanish Iris). Unlike the German and Siberian, this class of Iris is bulbous. The bulbs are cheap, and yet so few of this class of Iris are planted that we wish to commend this excellent group. Plant them in good, friable, well drained soil the latter part of September. They will bloom the next Spring in May. The Spanish Iris will start into growth immediately upon being planted. The English will wait till Spring before sprouting. The two sorts are easily distinguished. The English have wider petals and are found in shades of blue and white only; the Spanish are often yellow as well as blue, white, and other shades, and have comparatively narrow petals; they also bloom two weeks earlier. They are quite susceptible to a certain disease and to lessen its damage it is advised to take up the bulbs soon after their leaves have died down to the ground; they could then be planted again in September.

KING'S SPEAR. (See *Eremurus*.)

GRAPE HYACINTH. (See *Muscari*.)

LILIES. Everyone who has a pretty garden, some time, sooner or later, takes up the growing of Lilies. They are the charm of the border wherever they are planted. Success with Lilies is not difficult if one confines himself to a few sorts which he can grow. Lilies are of such diverse requirements that it is only by careful preparation of soils and individual study of their needs that all kinds can be grown successfully in any one location. The Tiger Lily seems to grow as easily as most weeds and is not even choked by them. Other Lilies prefer good soil, usually light and enriched heavily with peat and leafmold. Manure should not be used except as a mulch. In planting Lilies, then, it seems best to either add the needed sand, peat and leafmold or to actually remove the native soil to a depth of two and a half feet. A good thick layer of leaves or leafmold is always beneficial as a Winter mulch unless there is a growing ground cover. In Spring the young shoots are frequently injured by late frosts and it is well to use a few evergreen boughs. For the landscape they are easily combined with shrubbery or the herbaceous border, where they are perfectly at home. The wild yellow or Canada, the Turk's Cap and the yellow speciosum or Henry's succeed admirably in

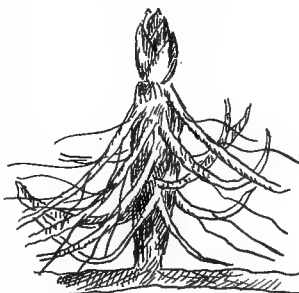

Lily of the Valley pip (reduced). This fragrant flower likes a sandy, moist loam in a semi-shady position. The pips should not be quite buried, but be level with the surface. Give an annual top-dressing of decayed leaves.

beds of Rhododendrons; especially when the Rhododendrons do not crowd them too much. The Gold-banded Lily should be planted among shrubs so that the roots are continually shaded, and where a fair degree of moisture is maintained. The Coral and the Thunbergian Lily are excellent planted among ferns, which furnish an excellent landscape effect besides. The Madonna grows nicely by itself and is most useful for clumps under pergolas or as an edging for walks.

The following are species which should succeed with a little care in many gardens:

CANADA LILY. (See *Lilium canadense*.)

GOLD-BANDED LILY. (See *Lilium auratum*.)

HANDSOME LILY. (See *Lilium speciosum*.)

LILIAM AURATUM (Gold-banded Lily). White, spotted brownish red and with a yellow band on each petal; three to twenty-five flowers on each stalk; flowers often a foot across; July to August; four to eight feet. One of the largest, but it is very capricious and may last only a year or two. Does well in Rhododendron beds, but it must not be crowded. Plant six to ten inches deep. Mulch with very well decayed manure. Likes the sandier or the more peaty soils.

LILIAM CANADENSE (Canada Lily, or Wild Yellow). Light orange, spotted brown; flowers drooping; July; three feet; very hardy. Prefers moist soil. Will thrive under garden conditions. Plant three inches deep.

LILIAM CANDIDUM (Madonna Lily). White, yellow anthers; June-July; four feet; hardy. Thrives well in ordinary gardens. Dislikes being moved. Transplant in August. Leaf growth takes place in September. Excellent garden subject. Superb combined with Delphinium or Aconitum. Plant four inches deep.

LILIAM CHALCEDONICUM (Scarlet Martagon Lily). Bright red; small; July; three feet. One of the best small-flowered Lilies. Does not flower well first season after being transplanted. Do not transplant later than October. Ordinary garden loam, good drainage. Plant four inches deep.

LILIAM ELEGANS (Thunbergian Lily). Red and orange; erect; May to July; only a foot or two tall. Likes full sunshine, and plant as deep as six to eight inches. Thrives in garden soil but prefers peat, light loam and leaf mold. Resembles *L. croceum*, which is taller, and more closely *L. davuricum*.

LILIAM HENRYI (Yellow Speciosum, or Henry's Lily). Deep salmon orange; August to September; six to twelve feet; very vigorous; excellent for border; very hardy. Give lots of water at blooming time. Any good soil. Plant six to eight inches deep.

LILIAM PHILADELPHICUM (Wood Lily, or Wild Red Lily). Scarlet, yellow center, dotted maroon; erect flowers; July to August; eighteen inches; very hardy; sun or shade; good loam. Best specimens found in wild; often hard to cultivate. Plant three inches deep.

LILIAM REGALE (**MYRIOPHYLLUM**) (Regal Lily). White, slightly suffused pink, and canary yellow at center; fragrant; hardy and vigorous. Thrives in any peaty soil when it becomes acclimatized.

LILIAM SPECIOSUM (Handsome Lily). Pink, white, red varieties, spotted crimson; petals very reflexed; *rubrum* is most common variety; August; two to three feet. Does well in either sun or shade. Likes a sandy loam best, deep and rich. Succeeds admirably when planted among other perennials which shade the soil.

LILIAM SUPERBUM (Turk's Cap). Orange, flushed scarlet, spotted brown; ten to thirty flowers on a stem; July to August; six to eight feet; hardy. Good for border if soil is rather rich and moist. Excellent among low, shrubby growth. Plant four inches deep.

LILIAM TENUIFOLIUM (Coral Lily). Deep scarlet; strong, recurved; six to ten flowers on stem; leaves fine; June to July; one and one-half feet. Treat as a garden subject. Give partial shade. It is short-lived and soon declines after its best production of bloom. Grows readily from seed. Plant three inches deep.

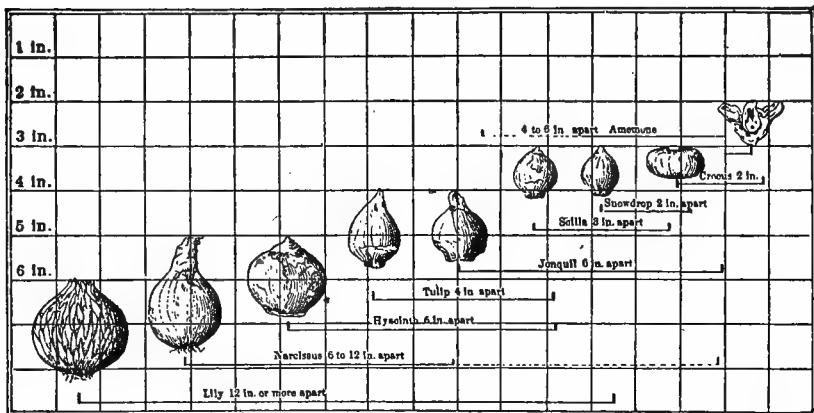

This diagram shows approximately how deep and how far apart to plant the different kinds of hardy bulbs in light soil. In heavy soil plant an inch to an inch and a half nearer the surface

LILIAM TIGRINUM (Tiger Lily). Orange red, spotted purple; large; petals reflexed; July to August; six feet; very hardy. Thrives in any soil; prefers sandy or peaty loam. Plant five to six inches deep. Stake or plant against wall to protect against winds.

MADONNA LILY. (See *Lilium candidum*.)

REGAL LILY. (See *Lilium regale*.)

SCARLET MARTAGON LILY. (See *Lilium chalcedonicum*.)

THUNBERGIAN LILY. (See *Lilium elegans*.)

TIGER LILY. (See *Lilium tigrinum*.)

TURK'S CAP. (See *Lilium superbum*.)

WOOD LILY. (See *Lilium philadelphicum*.)

YELLOW SPECIOSUM. (See *Lilium Henryi*.)

MUSCARI (Grape Hyacinth). Species: *botryoides* and *plumosus* var. *monstrosum*. Here is a little gem for the garden. The blue and white miniature bells, when seen in mass, are most attractive either in the border or when naturalized in grass or woodland. There are several other forms which are intensely interesting, especially the plumed or feathery Grape Hyacinth (*Muscari plumosum* var. *monstrosum*). In this the floral parts are much elongated and appear very feathery. It

grows only six or eight inches tall and needs to be planted in very front of border or in rockery.

NARCISSUS. There are a great many types and species of *Narcissus*. So great is the difference of opinion concerning them, even by botanists, that we will not try to present any complete outline of them, except to say that the following may help to classify the various types:

Doubles—Von Sion; properly called *Telamonius plenus*; very showy; an old variety; the flower usually referred to when the Daffodil is mentioned.

Pure White—*Albicans odorata*; perhaps the commonest white; the flowers are nodding. *Madame de Graaff*; largest; late.

Pure Yellow—*Ard Righ*; early. *Golden Spur*; also early and is a sure bloomer. *Emperor*; excellent flower; good keeping qualities. *Glory of Leiden*; late; very fine; large.

Bicolors—*Empress*; large, fine, rich yellow trumpet; companion in season to *Emperor*. *Victoria*; the earliest good, lasting one. *Horsfieldi*; good appearance in garden.

LONG TRUMPET. To this class belong all varieties with distinct tubular centers which are as long as the outer parts of the flower. There are two groups of the long trumpet *Narcissus*; the self colors and the bicolors; besides these there are singles and doubles. The doubles are termed Daffodils.

MEDIUM TRUMPET. To this class belong all varieties with distinct tubular centers, which are about half as long as the outer parts of the flower. When the flower doubles the tubular centers are really present but are much divided. Some of the principal of the *incomparabilis* and *Leedsii* varieties are: *Barri conspicuus*, light yellow bloom, the crown being edged orange red; *Sir Watkin*, large, bold, free flowering, most effective for garden; *Autocrat*, very prettily shaped canary yellow bloom which succeeds nicely. *Mrs. Langtry*, pale creamy yellow, good for cutting. *Duchess of Westminster*, a yellow and white flower, large and beautiful.

SHORT TRUMPET. To this class belong all varieties in which the tubular center is a mere cup or even a ruffle. The flowers of some of the varieties belonging to this group are borne in bunches of from three to ten blooms. They are called *Tazetta* or *Polyanthus* varieties. They are not hardy and should not be planted out of doors. Varieties representative of this group are: the *Chinese Sacred Lily*, the *Paperwhite Narcissus* (which is so easily grown in pots), and the yellow *Soleil d'Or*. Varieties which merely have a frill at the center are *Poet's Narcissus*. They are very adaptable to garden culture and often spread very rapidly. The catalogues term them *poeticus* varieties. They should not be confused with the *Poetaz* varieties, which are hybrids between *poeticus* and *Tazetta*; these are not very hardy. A third class are the *Jonquils*. Many persons call any single *Narcissus* a *Jonquil*; this is a mistake. *Jonquils* have very slender leaves; the flowers are either single or double, yellow and very fragrant; two to six flowers are borne on each stem; the trumpet is a little longer than the *Tazetta* varieties. The chief variety of *Jonquilla* is *rugulosus*. *Jonquils* are small and not hardy but are worthy of pot culture.

Cultivation.—The *Narcissus* is one of the most persistent bulbous plants when once established. It, therefore, lends itself admirably to be planted by the thousands in grass for a naturalistic effect. Its

natural method of rapidly dividing year after year insures its spreading widely. They also do well in beds and borders.

SCILLAS, or SQUILLS. Species: *sibirica* (Siberian Squill), *complanata* (Wood Hyacinth), and *bifolia*. The Siberian Squill bears an intensely blue flower which is unexcelled for the planting of entire beds. The bulbs are extremely hardy, the beds needing almost no care. The Wood Hyacinths are white, light pink or blue, and are very showy used as clumps in borders or woodland. They much resemble the Hyacinth, except that the blooms are much more sparsely arranged.



POND WITH WATER LILIES

There are many places that could be converted into pools for Water Lilies, even in small gardens. The pools or ponds should be 2 ft. to 2½ ft. deep. The plants can be placed in boxes or hampers of a size 2x2x1 ft., or a system of half barrels or hogsheads can be arranged in a chain, with water running between each. Sometimes a number of barrels are arranged together, either sunk in the soil or grass, or arranged a little above, sufficiently close to have soil filled between them, and Papyrus, Reeds, and other plants planted therein

SNOWDROP. (See *Galanthus*.)

SQUILLS. (See *Scillas*.)

SUMMER HYACINTH. (See *Galtonia candicans*.)

TULIPS. The finest garden subject among the Dutch bulbs is, in the opinion of many, the Tulip. It is so hardy, the colors are both dainty and vivid, the form is exquisite, and the ease of success commends it to every garden. It is hardly a wonder that in 1634 there was a Tulipomania, a time when bulbs were placed in balances with gold, when a single bulb of *Semper Augustus* sold for thirteen thousand florins and it was necessary for the Government to interfere in this wild speculation. The name has been derived from the Persian *toliban*, or

turban, which the flower resembles. There are a number of forms of Tulips, all of which are interesting. The earliest Tulips are of the Duc Van Thol group (*Tulipa suaveolens*). The stems are rather short and they would not be commended for garden culture except for the fact that they are very early. They are usually characterized by rather pointed or laterally rolled petals. The midseason Tulips occupy most of the garden interest. Hundreds of varieties are pictured and described in the catalogues. This main group is often termed the Gesneriana Tulips. It includes the peculiar fringed petaled group, known as the Parrot or Dragon, together with the Darwins with their subtle colors and long stems, as well as the May-flowering or Cottage varieties, which possess the long stems of the Darwins, but the blooms, instead of being globular, are more or less bell-shaped, the tips of the petals being reflexed. With excellent effect we have seen the exquisite scarlet Pride of Haarlem, a Darwin variety, growing in a bed of blue German Iris (*pallida dalmatica*). When the Tulips have finished flowering the Iris begins and the color scheme is entirely changed in a few week's time.

WINTER ACONITE. (See *Eranthis hyemalis*.)



CHAPTER X

Hardy Garden Ferns

NORTHERN exposures and moist places always suggest ferns. They are usually somewhat fragile and must be protected from high winds. They usually need an abundance of water, but prefer good drainage. Furthermore, they should be planted where water will not continually drip upon them. They are especially successful under trees where they take care of themselves nicely. They should be transplanted in early Spring or Fall—those in exposed places better in Spring. They may be planted in clumps of all of one species or they may be mixed. Among rocks, on a slope, is a very good place for them. They vary in height from four inches to four feet. Ferns possess creeping underground stems; some are deep, others are merely surface creeping; a few have thick, upright stems, which are hard to pull up.

The soil that ferns will like varies greatly. The best method of knowing what soil they need is to note where they grow naturally. In general, most ferns like a deep, rich, not too heavy soil—better with little peat in it. In their native habitat they have few or no enemies, but in the garden they are attacked often by wood lice, slugs, snails, caterpillars and the grub of the daddy longlegs.

The fern spores are very peculiar for they are produced in little sling shots which are so small as to appear like brown spots on the lower sides of the leaves. Some persons have thought their ferns unhealthy when they have seen these brown areas, but this is not the case, for it is the normal procedure to produce spores. When these sling shots ripen they burst open and scatter their contents. The spores, instead of growing into a fern that we would recognize, produce funny little green plants like a heart-shaped leaf, usually the diameter of a lead pencil. These green plants produce spores and it is from them that the characteristic fern grows. There are many kinds. We name the following:

ADIANTUM PEDATUM (Maidenhair). Prefers a well-drained, light soil.

It is of a poor color when grown in the sun.

ASPIDIUM. (See *Dryopteris*).

ASPLENIUM ACROSTICHOIDES. Moisture; some shade. Endures sunlight if cool.

ANGUSTIFOLIUM. Avoid the removal of old fronds. New crop springs up and weakens the plant.

- FILIX FOEMINA** (Lady Fern). Good, rich loam, moist. Excellent, well formed fronds, which are very variable.
- PINNATIFIDUM**. A small evergreen fern found in depth of glens. Useful for planting between stones.
- TRICHOMANES**. A rock garden plant.
- PLATYNEURON** (Ebony Spleenwort).
- CAMPTOSORUS RHIZOPHYLLUS** (Walking Fern). Prefers dry ledges.
- CHEILANTHES LANOSA**. Prefers deep shade.
- TOMETOSA**. Prefers less shade; more moisture.
- FENDLERI**.
- CYSTOPTERIS BULBIFERA**. Plant in shade upon a moist bank.
- FRAGILIS**. Fronds die early in August.
- DENNSTOEDIA** (Dicksonia) **PUNCTULOBULA** (Hay-scented Fern). Heavy growth. Grow for cutting for Summer.
- DRYOPTERIS** (Aspidium) **BOOTTII**. Does not need Winter shade.
- CRISTATA**, var. **CLINTONIANUM**. - Swampy ground.
- FILIX-MAS** (Male Fern). Rich soil; deep shade.
- GOLDIEANA**. Cool, rich soil. * Good in acid soil or leaf mold. Large, heavy growth.



Moisture loving plants by the edge of the water

MARGINALE. When transplanted in full leaf the plants rarely survive. Like a rich, moist soil and deep shade.

NOVEBORACENSIS. Not good for cutting. Easily transplanted.

SPINULOSA, var. **INTERMEDIA** (Spinulose Shield Fern). Good in wet, and under trees as well.

THELYPTERIS. Partial shade in marshes.

LYGODIUM PALMATUM (The Climbing Fern; Hartford Fern). This fern is difficult to establish. It is moisture loving.

ONOCLEA SENSIBILIS (Sensitive Fern). Wet ditches and rich, moist soil; partial shade.

STRUTHIOPTERIS (Os-



Flagstone path through bog-garden and semi-wild garden. Good use can be made of Gunneras, Spiræas, Japanese Irises, Knot-grass, Giant Reed and similar plants

- trich Fern). Burns in full sunshine.
- OSMUNDA CINNAMOMEA (Cinnamon Fern). Moist, rich.
- CLAYTONIANA (Interrupted Fern). Move while dormant.
- REGALIS. Peaty; branching; edges of brooks.
- POLYPODIUM VULGARE (Common polypody.) Can be planted up the ledges of gorges.

WATER SIDE PLANTS

The selection of plants suitable for the water and water side is a large one, chief among the first named being, of course, the true Water Lilies or Nymphæas, while the Rice Plant, or Zizania, the Flowering

Rush or Butomus, also various of the Reed Maces or Typhas can be used with success.

Among the water side plants (frequently spoken of as bog plants) are the Globe flowers, (Trollius), the stately scarlet Lobelia in several varieties, a selection of Loosestrifes, particularly the one called *Lysimachia clethroides*, and the gay Monkey-flowers (*Mimulus*), including *cardinalis* and *Lewisi*. The beautiful Moccasin Flower, called *Cypripedium spectabile*, must not be forgotten, the latter, together with other hardy orchids, being suitable for the drier parts of the ground. The list, however, could be very greatly enlarged.



Who would not wish to have a rock garden like this? A placid stream runs through it

CHAPTER XI

The Rock Garden

THOSE persons who like imported products of every kind will prefer to call these Alpine Gardens. There are so many parts of the United States where rocks abound that it is very peculiar that more really good rock gardens are not to be seen.

We do not wish to advocate the establishment of a garden of this sort where the rocks must be moved a great distance. We feel that such a feature as this in the prairie region is rather incongruous; besides, the cost is prohibitive. There are, however, certain regions which are well adapted for informal rockeries. Central Park at the center of New York City has wonderful outcrops of granite, in which are all sorts of crevices and holes for plants. Rochester, N. Y., has an abundance of peculiarly weathered limestone formations which are very useful. Each vicinity has a different sort of native rock formation, so that the type of planting will greatly differ. Rocks should hardly be placed for a definite display of themselves, for they should be the background.

We have only to visit Japan or read of her gardens; they are rock gardens; they are really rock landscapes. In them we find that rocks are as important as plants. We discover their arrangement studied. We hear that imperial edicts have been sent out from time to time prohibiting the price which may be paid for rock. It seems that during one of the dynasties the interest in foreign rocks was so great that such an edict was necessary. If we should remark to the Japanese gardener that a collection of rocks such as he has in his landscape is mere geology, he would ask us what difference it made so long as the whole was beautiful and meant something. He would continue to say that our own American gardens do not have any real significance. Few of the Japanese gardens in America have the real essential features. The American wants to use the Japanese material, but not understanding the Oriental arrangement he prefers an arrangement which he has imagined is the real way the Japanese gardens look. For one who cannot read Japanese, two pages of a Japanese book look enough alike to be equally well covered with interesting characters. So with a garden; one which is American using Japanese plants and receptacles looks superficially like the real Japanese arrangement.

We have digressed, but we must return to our own country where the conditions are really quite beneficial for rock features. An ideal situation is one where the plants are protected with snow during the Winter and not subjected to extremely hot conditions in Summer. The moist, cool rock crevices lend themselves most admirably to this treatment.

CONSTRUCTION. The amount of construction necessary will vary according to what is at hand to begin with. Let us suppose that we have a rocky bank which may even be a sort of supporting wall; perhaps we have a small brook whose sides we would like to plant, or we may have to construct the garden from the start.

The first case, that of a rocky bank or wall, is the simplest to manage. It may be necessary to use a wedge to open up some of the cracks so that they become larger; these should be filled with a rather rich, not too light, soil consisting of good loam and one-fourth manure. It is advisable to have all the crevices open into areas of soil. This we cannot do upon natural rock banks. With these natural rock gardens we must take a chance as to the depth of the crack and soil.

In planting a brookside, boulders and rocks will be available usually. The problem here is to build up the rocks informally and with soil between them. Many an innocent Summer brook is a bad marauder in the Spring. Confine your efforts to the areas above the flood and perhaps sow a few annuals near the water. Do not spend too much energy arranging the rocks nicely in the basin of the brook. The water will no doubt destroy all your efforts.

When we must construct an entirely new rockery the problem is greater. It should run nearly north and south; this will provide various exposures for different plants. Above all things, avoid any cut stone, brick or anything artificial. Statuary is never at home in a rock garden. If the garden must be made from flat land the best thing to do is to dig out a little valley, running it very irregularly. The soil removed can be used to build up on the sides, so that the little vale appears deeper than it is. It must be added that there is danger in having a wet hole instead of a beautiful rock garden if the created valley has poor drainage. Shrubs can be planted about the mound on the outside. This building up of the soil must be done in a very irregular way and care should be taken that the top soil is saved from the land which will be covered, for it will again be needed to cover the subsoil laid bare.

When the soil has been removed the rocks can be placed. They should never be arranged in correct tiers, nor should the direction of the strata in the rock be seriously changed. The sketch shows the strata of the rocks naturally arranged and provided with a dip which

will catch the moisture. Leave plenty of soil space between the rocks and plan little pockets to catch the water. Provide drainage by the use of a quantity of ashes or fine gravel in the center of the mound. The rocks get very hot and some plants may dry readily. If a little water can be provided it should be conducted to the top and allowed to seep down through the crevices. In Winter a protection of straw and decayed manure over the plants will be beneficial. It is best not to remove this protection too early. Neglect it a bit. Evergreen branches are excellent for those plants which do not die down each year.

MATERIAL FOR ROCK GARDEN. The rock garden is essentially a wild feature and a great deal of native material should be used. No variegated freak horticultural varieties should be introduced. Even fancy and well bred varieties are better when absent. We refer to the Mme. Chereau German Iris or, in fact, anything dressy. It is well to grow in the rockery the interesting little plants which need special attention to be seen properly.

Bulbs are excellent. Snowdrops, Narcissus, Scillas, Fritillarias, and Crocuses are all quite necessary.

Large trees should be avoided and some trees especially; for example, Hawthorns and Elms require much water and should never be planted. The smaller evergreens, Junipers, Arborvitæ, broad-leaved evergreens, Yucca and Cacti are excellent.

If the rock area is extensive and a very quick result is wished, the use of annuals is excellent. Dr. Southwick has used annuals most effectively in his "Garden of the Heart" in Central Park, N. Y. The otherwise objectionable colors of Petunia are there very cheery. Lobelia erinus is indispensable. California Poppies, either the golden, the crimson or the white ones, are very pretty. Baby's Breath (*Gypsophila muralis*, the pink, or *elegans*, the white) adds a graceful touch.

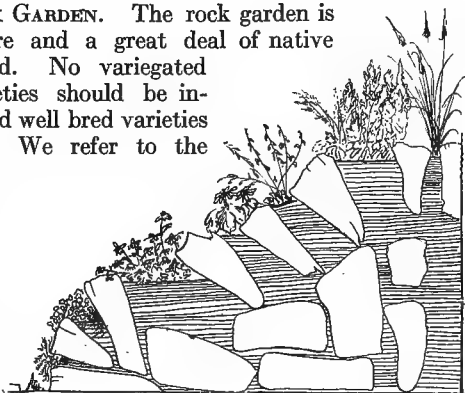

Diagram to show, in a general way, the placing of the boulders or large stones in the making of rock garden. A shelving arrangement is adopted, leaving spaces, called pockets, between the stones. These should be arranged so as to catch the rain. At the same time the water must pass readily away through drainage channels

The ornamental grasses look well combined in various places with the various blooming perennials. The annual Larkspurs and Lupines are both good blue subjects. Portulacas, Sanvitalias, Bouncing Bet



This picture shows a closer, more intimate view of a rock garden. In this instance it is employed most fittingly as an ornamental feature between the inner flower garden and the outer semi-wild parts

(*Saponaria ocymoides*) and *Nemophila* are of just the proper habit for the rockery. Speaking of rock gardens in California, even as far south as Los Angeles, a writer in a paper there says: "These rock gardens are positively alluring, for if one but follows a bank having a turn in direction of but a quarter circle he may find at one end the Edelweiss of the European Alps, and at the other, through gradual transitional plant zones, cacti from the desert sands. Next to the alpine is often brought in fern dells with trickling streams and waterfalls."

(For perennials useful for rockery, see page 65.)

CHAPTER XII

Garden Furniture

A GARDEN of any size should not be without a garden seat, a bird bath and similar adjuncts. Convenient seats and appropriate garden accessories should be a great joy. Inappropriate and mean-nothing garden features should always be avoided. Pergolas which lead nowhere nor hold up any vine are out of place. Garden fences which are too fantastic are like the too frequent highly ornate vases used in our homes for the simplest flowers. Furthermore, the style of the house and the manner of planting will largely determine the propriety of every garden seat, bird house or fence.

GARDEN BENCHES. An excellent, substantial garden bench may be constructed quite cheaply. A working drawing for such a bench is shown. It is made entirely of three-inch stuff, and can be either longer or shorter than six feet. It has been thought best to place the legs one foot from each end of the bench, unless the bench is shorter, when it will be better to have them six inches from the end. Four designs are here found for the ends. They are merely suggestive; others may be used just as well, but they should be simple and in every case should be wide at top and bottom. Small brackets are placed under the top on each side of the legs. They are made of two- or three-inch material, the legs of the right angle being three inches. If one prefers, three long screws may be placed through the top of the bench into the standards. In order to give the legs a good standard, they are faced on all sides at the base with a strip of two by two and one-half stuff. The bench may be painted white, light gray or green.

RUSTIC WOODWORK. For this work there are a number of good sorts of wood. Some are used with the bark and other wood is peeled before using. Hickory, red Cedar, Cherry, Blackthorn, Birch, Larch and Fir are used with the bark. Such wood should be used only when dry and is best cut in the Winter, when little sap is flowing. It is stored to dry and season.

To make the chair, select two back poles which have nearly the same curve, then the front posts which are nearly straight. There are two ways the parts may be joined, the first way being to bore holes in both the uprights and crosspieces and fit pegs or dowels of ash or elm into them. The other method is to make a tenon at the

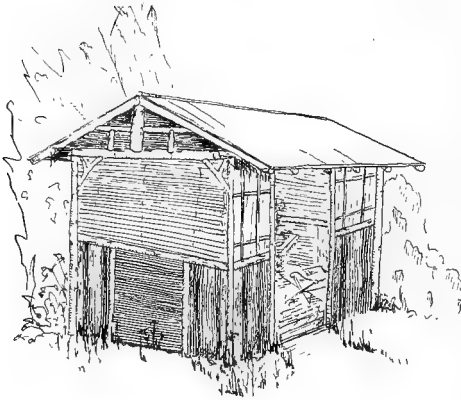

A simple garden house

end of the one piece and a hole to receive it in the other. This latter method is not as strong and is usually harder to make. In both cases the parts should fit very tightly. When putting together finally, coat all joints with white lead thinned with boiled linseed oil. It is best to put a nail or screw in all important joints and wipe off the surface white lead which may remain. The seat is made of split wood beveled at ends to fit on the main stays. If the seat does not seem perfectly solid, a brace or two can be fitted in from below and the seat nailed to it. Many ingenious garden benches, screens, trellises and pergolas may be made in this way. Care must be taken that all such furniture or bridges are perfectly strong. Our recollection of rustic things is that they are frequently out of repair. All sharp twig stubs must be removed and care should be exercised to keep all nails from sight or from doing injury.

THE GARDEN HOUSE offers possibilities for the enjoyment of the mistress of the house as well as furnishing an ideal playhouse for the children. Every child likes a playhouse. He thinks it is his own house. It is well to place the garden house in the shade of a large tree where it will be cool afternoons. It should be built so that it can be opened on all sides. The sketch on this page shows such a garden house of simple construction. The posts are of white Pine and the wainscoting on sides is made of slender twigs tacked upon the rough board sides.

(Text continued on page 127)

end of the one piece and a hole to receive it in the other. This latter method is not as strong and is usually harder to make. In both cases the parts should fit very tightly. When putting together finally, coat all joints with white lead thinned with boiled linseed oil. It is best to put a nail or screw in all important joints and wipe off the surface white lead which may remain. The seat is made of split wood beveled at ends to fit on the main stays. If the seat does not seem perfectly solid, a brace or two can be fitted in from below and the seat nailed to it. Many ingenious garden benches, screens, trellises and pergolas may be made in this way. Care must be taken that all such furniture or bridges are perfectly strong. Our recollection of rustic things is that they are frequently out of repair. All sharp twig stubs must be removed and care should be exercised to keep all nails from sight or from doing injury.

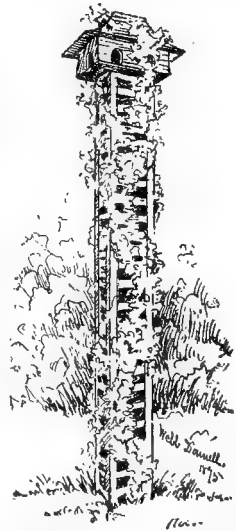

A "step-ladder" column supporting a dove cote and bearing a climbing plant

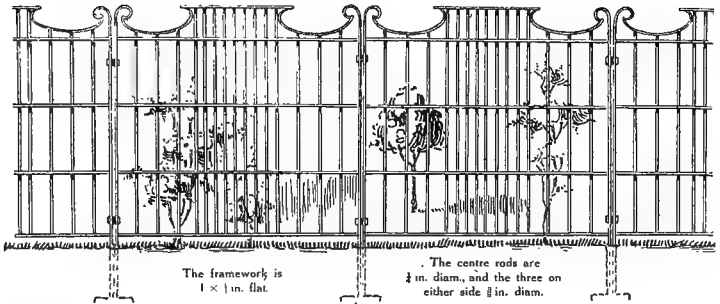

A DAINY TRELLIS, WHICH CAN BE MADE IN WROUGHT IRON OR WOOD

This design we reproduce from the country estate catalogue of the London firm of Wood & Son. The hurdles are 6 ft. long, with a stay to each, bolted with nuts, and are painted any color. The height is 5 ft. from the ground.

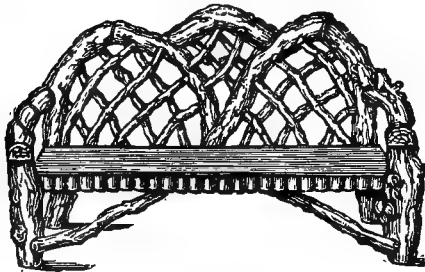

A RUSTIC GARDEN SEAT

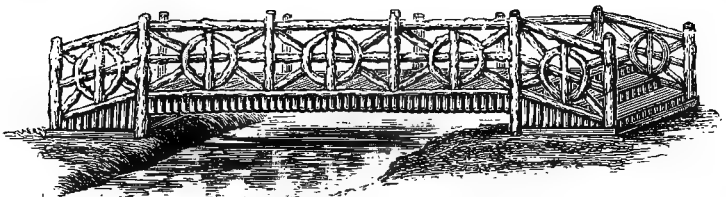

DESIGN FOR A RUSTIC BRIDGE

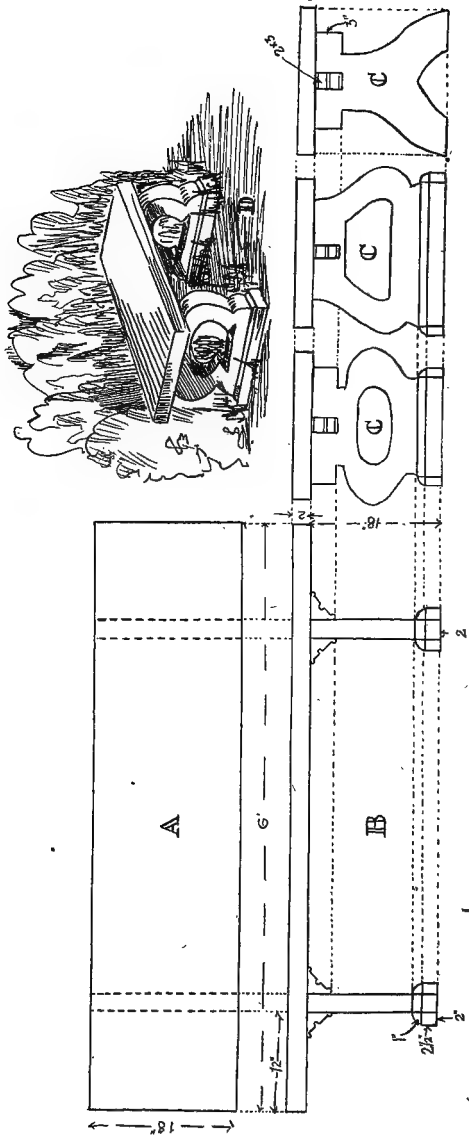

GARDEN BENCH

A, top. B, side. C, ends—a choice of patterns. D, completed bench

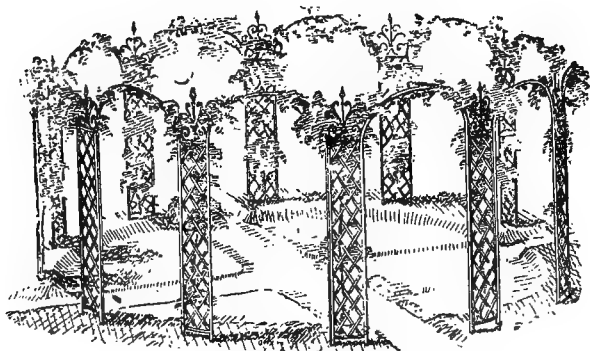

TRELLISED ARCHES

Another of Wood & Son's designs. These can be made in wood or wrought iron. The arches are 9 ft. high, composed of ornamental standards, the width of the arches being 6 ft.

(Continued from page 124)

FOUNTAINS. The fountain need not be the possession of the large estate owner alone, for it may merely be an inch pipe conducted underground to a convenient spot where a pool can easily be constructed of concrete. In

many places the pool should not be the conventional circular pool, but the border should be irregular and covered with a naturalistic planting. Fountains may be of the gurgly, squirty or spray sort; all are pretty. To some the squirty sort have an air of impatience or nervousness which makes them only useful at some distance from the garden seat. On the other hand, certain fountains give a restful, cool aspect to the garden, which is greatly

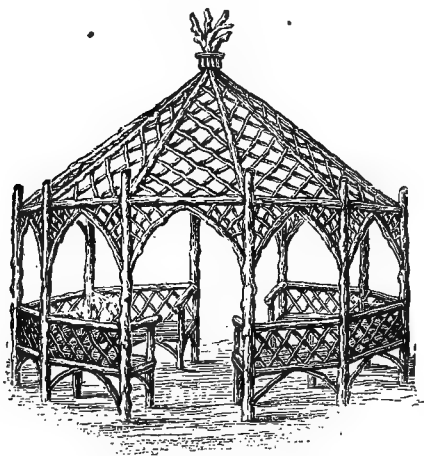

An airy, rustic pavilion

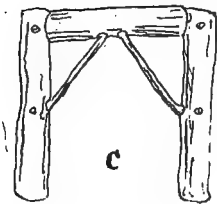
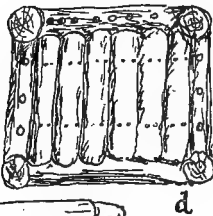
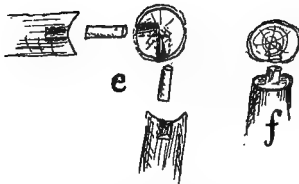
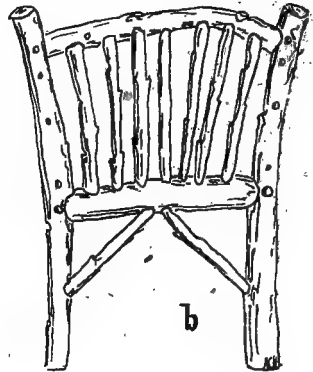
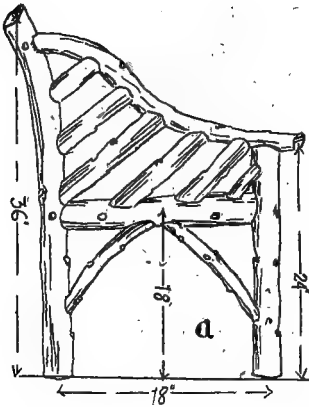

MAKING A RUSTIC CHAIR

A, side; b, back; c, front; d, seat; e, method of holding chair together by use of pegs, filled into holes bored into corresponding parts; f, method of making tenons without boring holes for insertion of pegs

enjoyed. There seems a universal enjoyment of water. Here the birds come, here plants may be grown, and here goldfish may be kept, and being fed at a certain time each day will become tame enough to take the food from the hand.

By one or all of these various adjuncts, appurtenances, garden ornaments, garden furniture, the beauty and comfort of the place can be considerably enhanced. The making of many of these things will, like the garden work itself, furnish agreeable recreation for many a holiday, Saturday afternoon or other period of one's leisure.

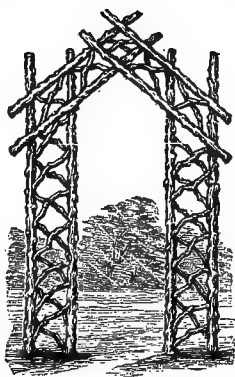

A rustic arch

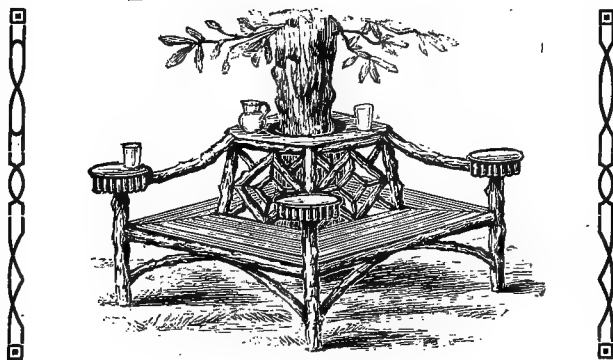

Rustic seat



Pergola of classical design covered with grape-vines. Square sided, paneled columns on the right; round columns on the left. Such a pergola is, of course, beyond the means of all but the very well-to-do. An easily made rustic pergola is shown on page 54

CHAPTER XIII

Fruit for the Small Garden

IN considering a collection of fruit trees for a suburban garden, particular attention will be given those varieties which produce a maximum amount of fruit in a minimum of space and which are designed to supply the family with fruit for the table and culinary purposes the greater part of the year. Available space must, of course, be considered in planting a fruit garden, and location must determine to a large degree the manner of planting and arrangement of the different fruits so as to allow each kind the greatest amount of light and air possible. Apples and Pears, Peaches, Plums and Cherries, therefore, should be planted to avoid casting too great a shade on the smaller fruits such as Strawberries and Currants. Raspberries, Blackberries and Grapes should be confined to trellises and not allowed to extend beyond certain limits, but to accomplish this, regular attention to pruning and thinning is absolutely necessary. A small fruit garden judiciously planned and planted will be a source of pleasure and profit, and well repay all the attention that can be bestowed.

Having chosen a location, proceed at once thoroughly to cultivate the ground, using a subsoil plough, or digging as deeply as possible; then cover the whole with a liberal dressing of well rotted farmyard manure, and a liberal sprinkling of bonemeal, and dig over again. In this plant your fruit trees. Should your soil be a rich loam it will be well adapted for the small fruits as well as Cherries and Apples, but heavy or clayey soils will produce fine Pears, while sandy soil will grow luscious Peaches. A careful study of conditions previous to planting will save a large amount of inconvenience, labor, expense and regret later on. Apple and Pear trees take about six years to come into bearing, but after that the crop increases annually. Pruning will accelerate fruit production to a large extent, and providing a good selection of varieties has been made, it is possible to have Apples nearly every month in the year, the proper facilities being available for Winter storage. Good cultivation is beneficial to the growth of fruit in general and liberal treatment will increase results.

It has been thought unnecessary to include, in a book of this nature, a large number of varieties, but rather to give the names of kinds that have been proved of real merit, and while those men-

tioned are not all of the good ones, they have been selected for their superiority in vigor and production.

These do best in a rich, loamy, well drained soil, in a position preferably facing the east or southeast. This situation protects the trees from north and west winds and retards blooming in Spring, thereby often preventing the destruction of the blossom by late Spring

frosts and the consequent failure of the crop. In **APPLES** planting, select a three-year-old tree, which can be procured at any reliable nursery, and insist on this being true to name, because a mistake at this point means years of disappointment. Nothing is more annoying than to find, after a period of six years, that the Red Astrachan you planted turns out to be some other variety, which upsets your plan of succession of fruiting. Do not make the usual mistake of planting your tree in a small hole, or planting too deeply, but be liberal in all your treatment and your tree will respond accordingly. Prune all broken and damaged roots, and after spreading the remaining roots evenly in the hole, cover with fine earth and give the tree a slight shake. Allow the earth to sift down among the fine roots, then put on more soil and tread in firmly, finish filling the hole, and put on a generous mulching to keep the soil about the tree moist, for upon this mulching often depends the life of the tree. After the tree is firmly planted, prune in the head to five or six branches and reduce these to half their original length. Attach a label to the tree and it is ready to take a permanent place in the garden.

During its first season of growth all superfluous shoots should be cut out, keeping in mind the future form of the mature tree. The second season the previous year's growth should be cut back about half, and after this the tree will usually need only thinning out the centre and such shoots as cross each other, to secure abundance of light and sunshine. The shoots which come out of the stem should be rubbed off as they appear. This treatment applies to standards, which should be planted at least twenty-five feet apart, but in a small garden trees known as pyramids, cordons, and espaliers may be grown with success. These can be purchased in that form, and are used for covering arches or for growing against buildings, walls or fences. They have the advantage of producing fruit quicker than standards, and in taking less space in which to grow, a consideration where room is limited. Pyramids could be planted in a row ten feet apart, cordons three feet apart against a wall or to form an arch over a walk, and espaliers along each side of a walk or against a wall or building, thus making the most of restricted space. Their pruning is more

severe and may be done in July and in Spring, the production of fruit bearing spurs being the end in view.

The prevention of San José scale is necessary to success, and a spraying with any good insecticide sold for that purpose must be given while the trees are dormant in Spring; lime and sulphur mix-



Typical half standard Apple tree suitable for the amateur's Garden

ture treatment is very good. Then the familiar codlin moth has to be dealt with. Arsenate of lead, three pounds to fifty gallons of water, sprayed through a fine nozzle, has proved the very best treatment for this pest, but many egg clusters can be gathered from the trees if carefully scrutinized while pruning. The trees should be sprayed as soon as possible after the blossoms fall, the object being to

get some of the insecticide into the calyx before it closes up tight, or the fruit turns downward.

Another spraying is necessary for fungous growth on the fruit. This should be done with arsenate of lead as soon as possible after the woolly down begins to come off the young fruit. No particular time can be stated, as in different localities the season varies, but by taking notice of the condition of the fruit, no mistake can be made. If green or black aphid appear on the growth of the young trees, spraying with what is known as "Black Leaf 40" is the best remedy. It is a preparation of nicotine in a concentrated form, and should be used according to directions supplied with each can.

Apples are seldom propagated except in nurseries, where large quantities are raised from seed and the many varieties in demand are then grafted on these seedlings while they are quite small. Grafting is sometimes practised in gardens for introducing a new variety on an old or objectionable kind.

In giving a list of varieties, due attention has been paid to sorts designed to keep the family supplied for a greater part of the year:

EARLY HARVEST. Fruit pale yellow, tender and good. Bears early.

Late July and August.

RED ASTRACHAN. Fruit largely covered with light and dark red. A good early, and bears young. August and September.

SWEET BOUGH. Fruit greenish yellow. The best early culinary variety. August and September.

YELLOW TRANSPARENT. Fruit clear yellow; tender, juicy, with a pleasant flavor. July and August.

DUCHESS OF OLDENBURGH. Fruit red striped, crisp, tender, juicy, aromatic. A good culinary variety. Late August and September.

GRAVENSTEIN. Fruit yellow striped, good size, attractive appearance, excellent quality. September to November.

TOLMAN'S SWEETING. Fruit pale yellow, decidedly sweet. A good dessert Apple. November to January.

MAIDEN'S BLUSH. Fruit lemon yellow with crimson cheek; very attractive. September to November.

SUTTON BEAUTY. Fruit attractive, red, fine grained, crisp. A good dessert Apple. November to March.

RHODE ISLAND GREENING. Fruit green. The very best culinary Apple. October to March.

BALDWIN. Fruit red. The well-known Winter Apple. October to May.

NORTHERN SPY. Fruit splashed with red; very crisp; of fine flavor. December to June.

WAGENER. Fruit red, large, subacid. An Apple of superior excellence. October to March.



No need to improve on such fruits as these—Cluster Grapes, choice Pears and Apples

Successful Pear culture is only practicable where the condition of the soil permits a free growth of wood. The trees may be planted closer together than in the case of Apples, because the tendency of the Pear tree is to grow tall rather than to spread out. Where an

PEARS Apple orchard is planted, Pear trees may be planted between the rows until the Apple trees require the room, when they should be cut out rather than encroach upon the room allowed for the Apple trees. Pears come into bearing much quicker than Apples, and the trees never assume large proportions. It is well to bear this in mind when planting, but a small Pear tree will produce liberally, and a careful selection of varieties will give a long season of fruit. Pears delight in a heavy soil, and as they bloom early in the season a sheltered position should be selected where some protection may be had from a windbreak of tall evergreens or group of buildings, or from the natural formation of the place chosen, such as the shelter afforded by a hill. The trees should be planted on the eastern slope when many are to be grown, but in the small garden pyramids or espaliers should be used. These give the best results, yielding a large amount of fruit in a restricted space. Pears respond to good cultivation and will stand closer pruning than Apples. The tall growing varieties should have the heads cut hard to prevent the trees reaching too great a height, which makes the gathering of the fruit difficult. It is good policy, therefore, to keep the trees low and bushy. Pears make spurs freely, and in pruning, this fact should be held in mind. Encourage a free, open, branching habit, and prune to clothe the branches with fruit bearing spurs, cutting out all superfluous growth at the Spring pruning.

Probably the worst enemy of the Pear is rust and fungus, an attack of which causes the fruit to grow deformed and unsightly. A frequent spraying with arsenate of lead, three pounds to fifty gallons of water, will keep the foliage and fruit in good condition. This should be applied immediately after the blossoms fall, and again about three weeks later, and should any sign of fungous growth appear later, another spraying should be given to insure good looking fruit and a clean, healthy growth to the trees.

Pears are usually grafted, and trees can be purchased much more cheaply than they can be grown to a fruiting age.

The following tried and popular varieties will prove a valuable addition to the garden:

CLAPP'S FAVORITE. Large, pale yellow; flesh fine, juicy and buttery. August.

BARTLETT. A very popular variety; large, shapely, melting; luscious flavor. September.

SECKEL. Fruit small but very sweet and melting. One of the best.

KIEFFER. Large; golden yellow when ripe; juicy, with Quince flavor. October and November.

SHELDON. Large, russet and red; aromatic flavor; rich and delicious. October and November.

BEURRE d'ANJOU. Large and handsome; flesh melting, extra fine. November.

Pears should be gathered as soon as the seeds are black, and stored in a dry, airy room until fit for use.

No garden is complete without a few Plums, so useful for table and culinary uses. The Japanese Plums are wonderful bearers, and produce annually large quantities of fruit. Their abundance makes it necessary to thin out the fruit to prevent rotting in clusters on the branches. Plums are not particular as to soil, as

PLUMS their roots spread so much nearer the surface than Apples or Pears, and any fairly good loamy soil that is well drained will produce fine fruit, but cultivating around the trees is very beneficial. Plant early in the Fall; be liberal with the spade, make large holes, spread the roots out evenly, and plant firmly.

Plums should not be pruned except for conserving the shape of the trees, particularly the Japanese varieties, which usually grow very strong the first season, and pruning back is a temptation, but if pruned they only produce another strong growth. If left alone they will form fruit buds all along these strong growths and so check excessive vigor. Plums are the earliest fruit to flower, and a sheltered position should be given them, or plant them on a northern exposure where the buds will be retarded until danger of freezing is past. To be effective, Plums should be sprayed very early, and again as soon as the blossoms fall, because the fruit is eaten without removing the skin. Plums intended for the table should be allowed to ripen fully on the tree, but for preserving and culinary purposes they may be gathered earlier. Should Plums insist on making a strong, rank growth, the best remedy is root pruning. Lift the trees in the Fall and shorten back all strong roots, keeping the roots exposed as short a time as is possible to complete the work.

Some Plums can be raised successfully from seed, the Greengage being one of these; but they are usually budded or grafted on the wild Plum stock.

The curculio is the worst pest we have to deal with, and the only way to fight this insect is to gather up all the fruit which falls prematurely and burn it, as in these fallen fruit the larvæ remain until full grown, when they eat their way out and enter the ground,



Something more than an artistic study: they are good to eat. Musk Melons, Peaches, Apples and hardy Grapes

where they change into the pupa state. The full grown beetle emerges in about four weeks and hides under the bark of the tree or some other protection until Spring business opens up.

Another insect which sometimes causes trouble is aphid. Spraying with a nicotine solution will destroy this pest, or the tops of the young infested growths can be cut off.

Some of the very choicest Plums for eating are:

OULLIN'S GOLDEN GAGE. Large, delicious flavor. August.

TRANSPARENT GAGE. Very large, round, juicy and rich. July.

GREENGAGE. Medium size, round, green, rich. August.

COE'S GOLDEN DROP. Very large, golden yellow, rich flavor. September.

VICTORIA. Large, oval, red. Useful for every purpose. August.

MAGNUM BONUM. Large, red. Good culinary variety. September.

For culinary purposes: **ABUNDANCE, BURBANK, RED JUNE, SATSUMA and WICKSON.**

To those in the warmer parts of the country where the Winters are not too severe, a few Peach trees will add much to the revenue of the garden, and who does not like Peaches? They can be served in so many appetizing ways. The Peach is not a long-lived tree, and will not produce profitably for more than five or six years. After the fruit begins to get small, new trees had much better be planted.

PEACHES

Peaches thrive in a light, well drained soil, and preference should be given to a northern aspect, as this tends to retard the date of flowering and prevent a total loss of the crop which would result if subjected to a freezing temperature while the trees are in bloom. At best Peaches are a precarious crop unless well protected from cutting winds. During Winter, if the temperature falls to ten degrees below zero, the blossom buds will generally be killed although in a dormant state, and no fruit can be expected under such conditions. Peach trees come into bearing early, and for this reason young plants should be selected for planting, and careful attention given to pruning to get the tree into shape.

Early Fall is the best time to plant, as the trees have a chance to get rooted a little before the ground becomes severely frozen. The roots being very fine, the trees should be planted as near the surface as consistent with firm and secure planting, and a stake put at each tree, if necessary, to prevent its moving. Peaches like the ground around them cultivated, and much better fruit will result.

They require little pruning except to cut back strong growths, and to thin out if the branches become too crowded. Dwarf standards

are preferable, but in small gardens trees can be trained against a building or on a fence. Under this method of culture they produce fine fruit, and ripening is assured in unfavorable seasons.

A spraying with arsenate of lead will check any tendency of fungous growth if done while the leaves are quite small; if done after the fruit gains size the woolly down which covers it holds the spraying solution and may cause some disfigurement. Aphids usually attack the young leaves and if planted against a wall frequent severe syringing with force enough to dislodge the insects will keep them in check. A solution of nicotine may be used effectively against this black aphid, but is almost sure to leave a stain on the fruit and should not be applied in any case after the fruit is half grown.

Early varieties are the best to plant as the season is none too long for the maturing of the fruit.

New varieties are raised from seed and their perpetuation is secured by budding. This is done when the stock is quite small and usually close down to the ground.

The best kinds are those which are known to do well in particular localities, but those named are known to be generally good, and can be safely recommended, and are all freestone varieties:

ALEXANDER. Medium size, white flesh, rich flavor. July.

BELLE OF GEORGIA. Large, showy, red cheek; flesh white, firm and sweet. August.

EARLY CRAWFORD. Large, yellow, of good quality. Early Sept.

HALE'S EARLY. Melting and rich flavor. August.

ELBERTA. Large, yellow with red cheek; of fine quality. September.

CHAMPION. Very large, white flesh; very productive. August.

Nearly everybody likes Grapes, particularly the children, and a garden is incomplete without them. Grape vines can be used to cover unsightly objects in the garden, or about the grounds, as well as on arbors, well shelters, pergolas, fences, or along walks, or to cover walks through the garden, and still be made

GRAPES productive. The quality of Grapes depends largely upon the attention they receive. Grapes delight in a rich soil, and should be planted about six feet apart and ten feet between the rows. They are best planted early in the Fall, and in Spring should be securely tied up, and as soon as growth commences each shoot should be carefully tied on a separate wire and allowed to run as far as it will, and removing such as are not wanted. Pinch off all secondary growths or off-shoots as they appear. The next season fruit growth will come from every joint of these old growths, and these should be pinched at the second leaf beyond the cluster of

fruit. Continue this practice through the growing season. Each bunch can be tied to the main shoot and the fruit will hang between the wires.

In December or January the vines should be pruned back to one good eye next to the main shoot, and from this eye comes your next growth which will produce fruit. After pruning, the canes should be securely tied in place for the next season. Vines are not very frequently attacked by insects or fungous diseases, mildew being the principal offender. This can be checked by an application of sulphuric acid as recommended for Gooseberries (which see).

Grapes are propagated by cuttings taken from the ripened growths, cut into pieces and inserted in sand or soil, where they soon root.

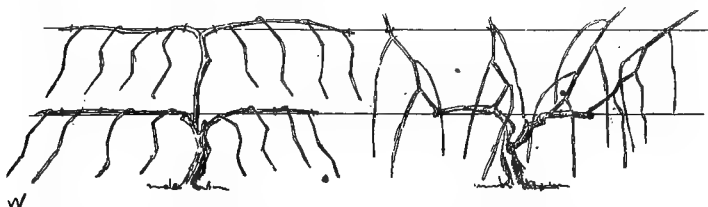

The Keffen system of pruning Grape vines, which is fully explained in the chapter on Pruning. See page 190

The following varieties are all good, but each locality has its favorite sorts:

Black.—CONCORD, MOORE'S EARLY, CAMPBELL'S EARLY

Red.—CATAWBA, DELAWARE, LUCILE.

White.—GREEN MOUNTAIN, NIAGARA, MOORE'S DIAMOND.

No garden is complete without Strawberries, and as they are so easily grown, no garden should be without them. What is nicer than a dish of Strawberries picked fresh from your own garden? Strawberries like a rich soil, and well repay a very liberal application of fertilizer. The best time to plant a bed

STRAWBERRIES is in September, when the young plants are just ready. Select an open piece of ground away from tall trees or shrubs; dig in a liberal dressing of well rotted farmyard manure, with a sprinkling of bonemeal, and in this plant your Strawberries one foot apart in the rows and two feet between the rows.

After the first hard frost throw over them some light protection—straw, old hay or anything that will not be liable to pack down on the

plants too tightly. The object of this covering is not to keep the plants from the cold, but to protect them from the sun, which causes more failures than the cold. This covering should be removed after Spring opens up, but not too early, as a little growth may have already started, and if exposed to a late frost may cause much injury. The plants, which will have become loose by the action of the frost, should be gone over and firmly pressed into place, the beds lightly forked to prevent the growth of weeds, and when they are in bloom, some straw or salt hay should be placed around and between the plants to prevent the soil from splashing on the ripe fruit.



The Marshall Strawberry

To lengthen the season of fruiting, the first blossoms may be picked from some of the plants, and these will fruit about three weeks later. Strawberries are sexual and bisexual, that is to say, in some the flowers have pollen

and seed organs, in others only one set of these. To insure fruiting it is necessary to plant some of each kind, unless the bi-sexual varieties alone are selected. A bed once planted is good for at least three years, when it should be renewed.

All runners should be cut away annually as soon as the fruiting season is past, unless some are wanted to make a new bed, in which case the strongest plants should be left until wanted and the runner should be stopped at the first strong plant to accelerate rooting.

Strawberries, fortunately, are not troubled with many insect pests or fungus diseases, and their propagation by runners is very simple, as they root freely of their own accord and can be cut off and planted where they are to remain.

There are many fine varieties and their selection is largely a matter of preference. The following are bi-sexual and are all good, tested sorts:

Early.—CLYDE, MARSHALL, BEDERWOOD.

Midseason.—ABINGTON, MCKINLEY, SHARPLESS, NICK OHMER.

Late.—COMMONWEALTH, GANDY, BRANDYWINE.

Autumn or Perpetual.—AMERICUS, PROGRESSIVE. These have small fruit.

Currants are used principally for culinary purposes, and unless wanted for preserving, a few plants will generally be sufficient for ordinary use. The red and white varieties are the ones usually grown, but some like the black, and a few plants could be included if room can be spared. The reds are the most popular.



Standard (or tree) Red Currant. This form of bush has special merits, being ornamental as well as utilitarian

CURRANTS

Any soil of a medium rich nature will grow good Currants and they are not particular as to situation. They prefer a light, open space preferably to one that is shaded by trees. They may be planted in Spring or Fall, and must be attended to in the matter of pruning to insure a good crop of fruit annually. All young shoots should be pruned back about half, and only a few left to form the bush, care being taken annually to remove all young growth which springs from the base of the bushes, otherwise they will get too thick and small fruit will result.



Pruning Currant shoots
1. Twig should be cut
back to bud as shown in
Fig. 3. No. 2 shows torn
snag

If planted four feet apart they will soon grow up and fill the space between each plant.

The Currant worm is one of the worst pests we have to deal with. Powdered hellebore dusted on the plants is a good remedy, but they should be watched for carefully as soon as the foliage appears, and kept destroyed until the foliage becomes hard. There is some danger in using a liquid insecticide because the fruit is small and it is almost impossible to wash off all traces of poison.

Currants are usually propagated from cuttings made of the ripened shoots, and root quite freely if put in during the Fall. The best varieties are:

Red.—FAY'S PROLIFIC, sweet, large and very productive. CHERRY, large and very prolific. POMONA, a new variety; keeps long after getting ripe.

Black.—CHAMPION. Berries large and of good quality.

White.—BAR-LE-DUC, WHITE GRAPE.

This luscious fruit is not much grown, but serves a purpose as a culinary fruit. It makes a good subject for planting between plots, as a fence, or along walks, as it can be pruned hard and kept within limits, trained on a wire fence for support. Planting may be

GOOSEBERRIES

done in the Fall and a crop of fruit can be had the first year. Very little pruning is required, as the plants usually grow short jointed wood, and keeping the plants thinned out so that the fruit may have exposure to the sun and air is all the pruning necessary. Like Currants, the Gooseberry is subject to the attack of worms (caterpillars), which soon denude the plants of foliage and make them unsightly, as well as preventing the proper maturity of the fruit. Dusting with powdered hellebore is one of the best remedies and should be applied as a preventive as soon as the foliage expands. Mildew often attacks the Gooseberry and causes trouble, but spraying with a solution of sulphuric acid, one part to one thousand parts of water, will control this disease. It may be borne in mind that eight teaspoonfuls make one fluid ounce, 16 ozs. make a pint, and there are eight pints in a gallon. A teaspoonful of sulphuric acid to a gallon of water is therefore a safe amount.

Propagation of the Gooseberry is done by cuttings of the ripened shoots. The following varieties are each good:

DOWNING. Large, pale green, soft and juicy; quite prolific.

INDUSTRY. Large, dark red; good cropper.

RED JACKET. Large, red, good flavor.

WHITE LION. One of the finest.

The popular Raspberry is always welcome in the home, and it is only when freshly gathered that it has that lovely flavor peculiar to this fruit and which makes it so desirable in the home garden.

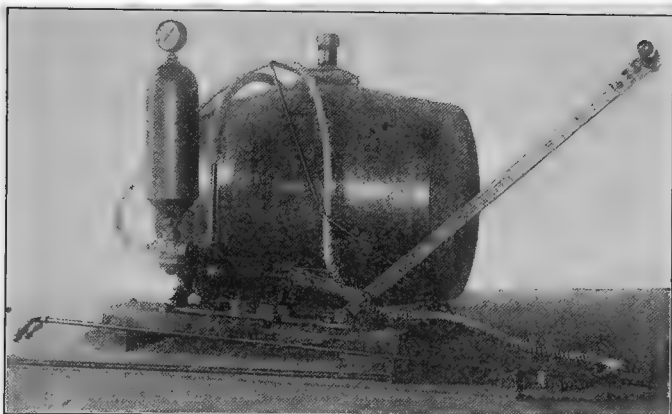

Experiment Station

University Tennessee

A simple, durable and efficient barrel sprayer

Raspberries must be handled with the greatest care or the fruit will become bruised and soon ferment. Small baskets should be used when picking, to prevent excessive weight, which invariably crushes the tender berries, and they soon become unfit for use.

RASPBERRIES The plants are not particular about the kind of soil they grow in, nor the location. They grow best in a good, rich, well drained, loamy, cultivated garden soil, and should be planted in rows two feet apart and four feet between the rows. They are best tied to a wire trellis for support and to facilitate ease in gathering the fruit.

The young growths which spring from the base of the plants, should be thinned out to four or five, and after the season's fruit is over, the old fruited wood should be cut out close to the ground, and

the young shoots given every chance to ripen before Winter sets in, when they may be tied together in bunches of five or six canes and left in this way until Spring, when they must be tied to the wires and trimmed evenly along the top to make them look neat.

Raspberries are not subject to much trouble from insects or diseases.

They are propagated by division of the roots or from cuttings, which should be taken from the ripened shoots and inserted in the ground in September, and will commence to grow the following Spring.

There are red, yellow and black Raspberries, but the red varieties are the most popular. A few well tried varieties follow:

CUTHBERT. Red, large and sweet; the most popular of all Raspberries

BRANDYWINE. A large, bright red berry; a good cropper.

GOLDEN QUEEN. Large, amber color; fine quality.

CUMBERLAND. Very large, black, glossy berries, juicy and sweet.

The culture of Blackberries is similar to the directions given for Raspberries. They grow stronger, however, and require more room, and owing to their sharp thorns they are not so desirable in the small garden. Some object to the many seeds they contain, particularly if grown on poor soil, but a few varieties are almost seedless:

TAYLOR. Without core and one of the best.

ERIE. Of very good quality.

ICEBERG. Produces white berries of a good flavor.

A few plants of the Loganberry may be grown as a useful novelty. The fruit has a very flat taste, but looks very pretty as a dessert, on the table.

LOGANBERRY There should be no reason why this easily cultivated fruit, which was raised by a Judge Logan in California, should not be tried in many gardens. In England it has become a general favorite. Its treatment in all respects is similar to that of the Raspberry.

CHAPTER XIV

The Vegetable Garden

NO matter how small the place, none is complete without its own vegetable garden to furnish the home table. In some instances, a vegetable garden is objected to on the ground that it interferes with the beauty of the surrounding effects. But the latter can be made to fit in with the general scheme. A well-planned and neatly-kept vegetable garden need never detract from the general appearance of the place; usually it is a decidedly attractive feature; it lends an air of simplicity and "hominess" which flowers alone cannot furnish. On a "dollars and cents" basis alone, in these days of high prices, the vegetable garden is, or can almost always be made, a paying factor. Even where that side of the matter is to be disputed there is no question that to get the very best quality of vegetables you must grow your own.

The commercial grower must be guided in his choice of varieties by the market demands, and by the factor of big yields, even though the varieties which meet these requirements may not be those of the best table quality. The home gardener, on the other hand, may select varieties which satisfy his own personal taste. Furthermore, there are many vegetables which, to be had at their very best, must be gathered only a few hours before they are used. As an old saying has it: "The pot should be boiling before you pick your Corn."

As a healthful recreation, nothing surpasses the cultivation of culinary vegetables. It never gets monotonous, for the work changes from day to day, and every day brings its own problems. The work involved may be made as mild or as strenuous as is desired. If one fears that not enough exercise is to be had with a hoe, a few hours' "trenching" with a spade will give him as big an appetite for his dinner as anything he can find to do.

It is not necessary to hesitate about having a vegetable garden because such a location as you may have available is not naturally the most ideal for the purpose. The plot of ground which cannot, with intelligent preparation, be made to grow successfully practically every one of the garden vegetables, is by all means the exception and not the general rule. At the same time it pays well to take advantage of any favorable natural conditions that may be at hand. The best soil is what is termed a "sandy loam," that is, a good clay soil in which there is enough material of a sand-like character to keep it friable and work-

able at all times of the year, while moisture is retained by it for a long time. If you have only a heavy clay soil, it can be improved by adding sand, wood ashes, sifted coal ashes, lime and humus. If the soil is light and sandy, heavy loam or muck added to it will improve it, and humus will also be very beneficial.

Drainage is one of the most important factors. If your garden spot is low and wet, by all means put in a drain tile at the first opportunity. Deep spading, and in extreme cases, loosening up the subsoil with agricultural blasting powder, will tend to overcome this difficulty.

If the garden can be located in a spot where it is protected from prevailing Winter and Spring winds the earliness of the crops will be advanced very noticeably. A good, thick hedge of Hemlock, Spruce, or Privet to the north and west of the garden, if it is not naturally sheltered, may be made to serve the double purpose of providing a wind shield, and of screening it from other parts of the place.

GROWING PLANTS FOR SETTING OUT. If you utilize your frames to advantage, your first plantings of Cabbage, Cauliflower, Lettuce, Beets, Onions, Tomatoes, Peppers, Egg-plants, Lima Beans, Corn, Cucumbers, Melons and Squash will be well started by the time it is warm enough to plant them out of doors.

If you have only coldframes, a few plants may be started in the house in a warm, sunny window to be put into the frames when they are large enough to transplant.

In making a hotbed begin a week or ten days before you expect to make your first sowing of seed. Procure horse manure that has not yet fermented, allowing one-sixth of a cord to each sash to be heated. Unless the manure has some considerable straw or bedding mixed in with it, it will be better to add one-fourth of leaves to the manure when it is piled up. Build it up in a square heap, tramping it down solidly as it is built. After three or four days, fork it over and restack, putting what was the outside of the heap in the center. Sprinkle with water any parts of it that may seem dry. Fork the heap over again within three or four days. In this way the whole mass may be made to ferment evenly, and will be in just the right shape to put into the frames

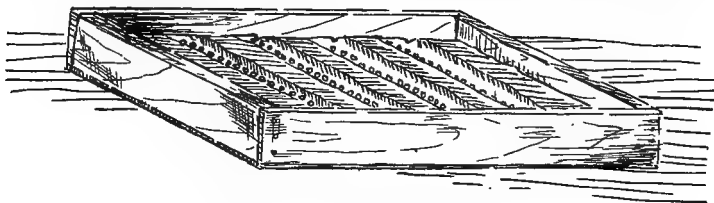

Box for the transplanting of seedlings

for your hotbeds. Fork out the old soil to a depth of from four to six inches; put in the manure, tramping it down firmly to a depth of eighteen inches or so. The amount of manure required will depend upon the climate and upon how early in the Spring the bed is made.

If soil that is not frozen is available, it will be well to put an inch or so of fresh soil on top of the old in which to sow the seeds. Any soil which has been removed should be put back on top of the manure and thoroughly fined and raked level. Then put on the sashes and



Small vegetable garden on suburban lot, with neat wire fence on left and wooden pathway

let the frames stand until a thermometer hung inside recedes to a temperature of 70 deg. to 80 deg., when it will be ready for the first sowing of seed.

DIGGING AND PREPARING THE SOIL. With the soil adequately enriched and thoroughly prepared, success is half won before you begin. Insufficient preparation, no matter how good your seeds may be, will remain a drag and a handicap throughout the entire season. The soil is the sole source of nourishment for the tremendous development plants will have to make through the comparatively few weeks of the growing season. All their food is absorbed in the form of a weak solution. We have already spoken of the necessity for thorough drainage.

The soil must also be well pulverized. It pays, therefore, to take time to prepare, just as thoroughly as you possibly can, your garden soil, no matter how impatient you may be to get at the more interesting tasks of seed sowing and planting.

If your garden plot is sufficiently large for a horse or team to turn in plowing will be much cheaper and on the whole much more satisfactory. Unless your soil is very light and sandy, it will pay to plow as deeply as possible without digging up the subsoil. Get all your plowing done as early in the Spring as possible. If the garden has to be dug by spade, you will have to watch carefully to see that the job is done thoroughly. It is hard, slow work and nothing is to be gained by trying to skim it. The garden that is dug shallow, left lumpy or merely fine on the surface, cannot give good results. Dig at least ten to twelve inches deep. Manure should be spread evenly over the ground before spading. It is usually best to throw the first row or furrow of soil out entirely, and then put the manure from the next strip on the bottom of the furrow dug out, proceeding in this manner across the piece.

When planting or sowing is to be done the whole plot should be raked over. It may be that only a small part of it will be wanted for immediate use for the hardiest seeds or plants, but if it is all given the same treatment the moisture will be conserved. It pays to take a good deal of care and time to get all trash and stones raked up and removed before you think of getting the surface ready for planting.

For practical results the enriching of your garden can be accomplished in no better way than by the application of all the manure you can conveniently get. It should be well rotted and not green and lumpy. Horse and cattle manure mixed that has been kept under cover and has thoroughly fermented but not "fire-fanged" or burned out, is the best. If you can get enough of this to spread it three or four inches deep all over your garden, you will have the foundation for big crops.

Chicken manure is particularly powerful, but should have been kept so that it is fine and dry, and not stuck together in a pasty mass. If you have only a small quantity, it is wise to keep it just for use in hills and for transplanting rather than to spread it over the whole garden. Sheep manure, like chicken manure, is very high in nitrogen, and should be used in the same way. Within recent years it has been possible to purchase cattle, horse and sheep manure in standardized, prepared forms which are dry and convenient to handle. Where yard manure cannot be conveniently obtained, these can be used.

Because it has been increasingly difficult to get manures in sufficient quantities, commercial fertilizers have come more into use. As

it is more convenient, the small gardener usually buys his fertilizer in the form of a completely mixed preparation.

It will be well to have on hand, however, a small quantity each of fine ground bone, guano or dried blood. These are all quick acting fertilizers which can be used in hills or drills. You can also use all the wood ashes you can get. Dustings of lime are also helpful. Commercial "humus" or prepared decayed vegetable matter is inexpensive and will prove very beneficial. It is often advertised.

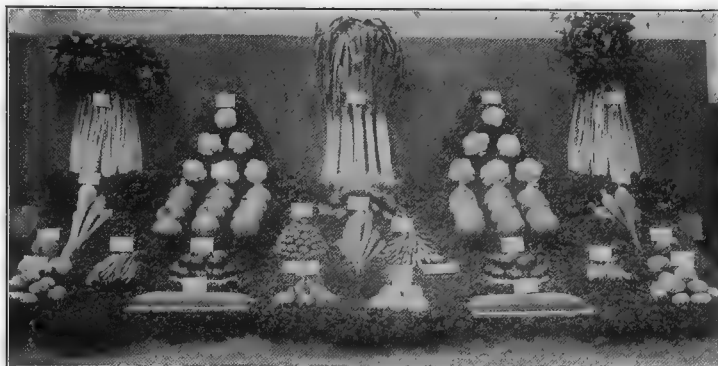

A table of choice, well-grown vegetables, properly staged

PLANTING AND TRANSPLANTING. The operations of planting and transplanting are two at which the gardener must become expert as soon as possible. The first step is to have a thoroughly prepared seed bed or planting surface. Have the soil thoroughly pulverized. It may then be left until ready for use. Just before you sow or plant, the surface should again be gone over with an iron rake. Make it as smooth and fine as you possibly can.

It is best to buy seed from a good, reliable seed house rather than to depend upon what you may find at the local hardware or grocery store. Small seeds such as Lettuce, Radish and Onions may be merely raked into the surface; medium size seeds, such as Beets, Spinach and Parsnips, from one-quarter to one-half inch and the comparatively large seeds, such as Cabbage, Carrots and Pumpkins, about one inch deep. In showery weather the seeds should be covered more lightly than in normal conditions, in a very light soil, or in hot, dry weather, cover more deeply. In extra early sowings of Peas, put the seeds in a little deeper, but not much.

As a general guide, sow Onions, (also plant Onion sets) smooth Peas, early Beets, Radishes, Spinach, Turnips and Cabbage just as

soon as the ground can be worked in the Spring. When Peach and Pear trees are in bloom, the medium hardy things, including Beets, Carrots, Kohl Rabi, Lettuce, wrinkled Peas, Parsnips, Salsify, Tomatoes, Swiss Chard may be sown and also Lettuce, Cauliflowers, Beets and Onion plants from the cold frames may be set out.

When the Apple trees are in blossom, sow the seeds of the tenderest things—Beans, Sweet Corn, Cucumbers, Okra, Melons, Pumpkins and Squash.



Lettuce, Beets, Onions, Carrots, Peas and wire netting support for Peas This garden is a model of good keeping

After all danger from late frost is past, set out growing plants of Tomatoes, Peppers, Egg-plants, Pole Beans, Melons, Cucumbers, Sweet Corn and Okra.

Poor germination results are often due to the fact that seeds are loosely covered in the soil. They should be well firmed and covered. Firming can generally be done well enough with the back of the hoe or rake.

For neatness make every row straight, using your garden line and reel frequently. Tag every row as soon as it is sown or planted, marking on the date as well as the name of the variety. You will thus be able to keep track of the time required for the different varieties to

mature, which will be of greater value to you in succeeding years.

Transplanting should be done preferably during showery weather, or in the late afternoon, and the plants will take hold more quickly. If they are shaded in some way for a few days, especially if the weather is windy and sunny, all the better. An irrigation system is of the greatest benefit, in transplanting or planting, as the work can be done at any time with an almost positive certainty of success. In all transplanting the soil ought to be pressed firmly.

Seeds may be sown directly in the soil, but usually it is better to sow in "flats" or seed pans, which can be moved about from one sash to another and handled more conveniently in transplanting. Small seeds should be barely covered from sight, while larger ones should be covered to the depth mentioned on page 151. It is important to press the seed firmly into the soil when sowing. Tag each variety carefully and water with a fine spray so as not to wash out any of the seeds.

As soon as the little seedlings are up it will be necessary to give some fresh air every day or two to keep them healthy and vigorous, the temperature being kept at from 60 to 75 deg. according to the things being grown. As soon as the first two or three true leaves appear, the seedlings should be transplanted, either into other "flats" or into the frames, setting them from two to three inches apart each way so they will have plenty of room.

During this season watering should be done only on bright mornings so that the soil will have a chance to dry off before night, as this will lessen the danger of "damping off." Avoid over-watering, as the soil dries out very slowly when the sashes have to be kept on most of the time.

Tomatoes, Peppers and Egg-plants should be transplanted a second time, preferably to pots, before being set out of doors. If they have been given plenty of room at the first shift in the frames or flats, they can be put into three and a half or four-inch pots, and be in bud and blossom when set into the garden.

It is very important that all plants, whether hardy or tender, should be "hardened off" carefully before being moved from the frames to the open garden. To do this, leave them uncovered all the time for several days and nights before you set them out, putting on the sashes only if frost threatens. Should plants inadvertently get touched by frost, watering them with ice-cold water in the morning and keeping them shaded from the sun will often enable them to recover when they might otherwise be lost.

WATERING. Within the last few years there have been developed several systems for applying water artificially. Any gardener who has a water supply with thirty pounds pressure available, can get his

own rain whenever he wants it by installing an irrigation system at a very slight cost.

The type that has been most widely used consists of horizontal piping supported a few feet above the surface of the garden and perforated at regular intervals. These pipes can be turned by a handle and a valve turns the water on or off as needed. A single line of pipe

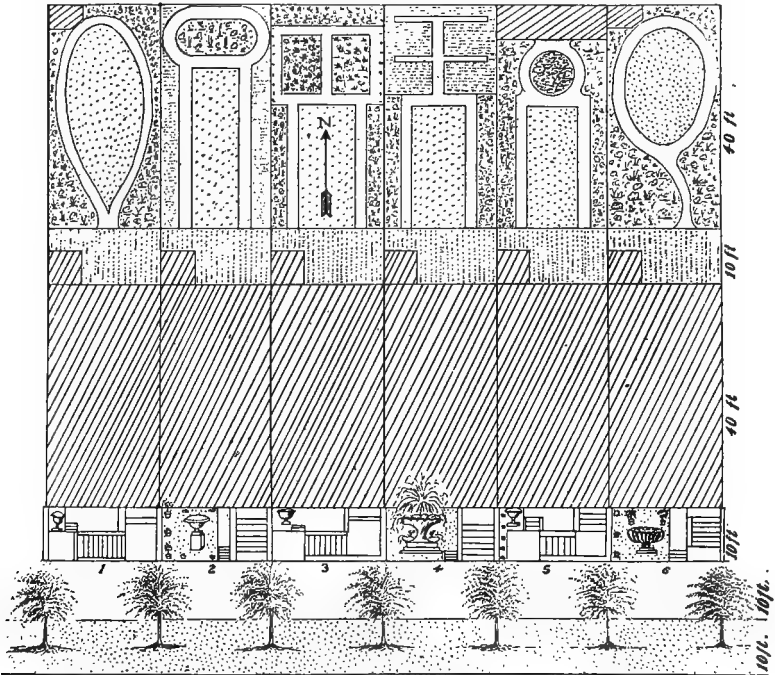

Street houses with their backyards. Some of these are purely ornamental; others, notably the two in the middle, have vegetable spaces. The dotted parts represent grass, the shaded parts arbors and rest house, the remainder being beds and borders

will water a strip of ground twenty-five feet wide on both sides or a total of fifty feet. A hundred feet of three-quarter inch galvanized pipe, even at present high prices, costs but a few dollars.

Another system which is slightly more expensive and applies the water more rapidly, has adjustable circular sprays placed every twenty-five or thirty feet along the line of pipe. It also does excellent work,

Watering with a hose by hand is not to be compared with water applied by a modern irrigating system. The soil can be soaked evenly and to as great a depth as desired, the water being put on whenever and wherever wanted by simply turning a valve and occasionally turning the pipe. For very small gardens a portable system of both types can be had.

GENERAL PRINCIPLES OF CULTIVATION. What is "cultivation?" Why do we do it and what does it accomplish? We cultivate to keep



A vegetable garden for supplying a large household. Here, as in the smaller gardens depicted on other pages, cleanliness and careful cultivation are pre-eminent. Observe the handsome pergola around the exterior

down weeds that might rob the growing crop of sunlight, air and nourishment; to conserve the moisture in the soil; to keep the soil open and aerated, and to pulverize the soil or break up its particles and thus assist the chemical and bacteriological changes in the soil. Cultivation brings these results. It also creates what is called "a soil mulch," i. e., a layer of dry soil on the surface which checks the loss of moisture from the lower layers to the surface where it evaporates rapidly.

The cultivation work required on any crop will depend largely on whether or not you get the first hoeing and weeding done just as soon as it is possible to do it, or let it go for a few days or a week later. Within a week or ten days the soil between the rows will have begun to form a crust again, and new crop of weed seedlings may have sprouted. This means another hoeing promptly. We do not think that it is any exaggeration to say that eighty per cent of the work in taking care of gardens is due to the fact that these hoeings and hand weedings are allowed to go for several days after they should have been attended to. The tedious task of hand weeding may be lessened considerably by using one of the small hand weeders.

Cultivation should be kept up frequently enough to maintain a dust mulch at all times. Cultivation with a wheel hoe should be kept up as long as it is possible to get between the rows. Then you should substitute for it a double or slide hoe. The types with runners or wheel to guide the blade and hold it even do much better and easier work. By all means, provide yourself with one.

INSECTS AND DISEASES. There are a number of insects which are almost certain to put in appearance every season. One important thing in combating insects and diseases is to be prepared to ward off attack. In cases where preventive measures are not possible, be prepared to act immediately if trouble appears. Owing to the large number of remedies, cures and poisons which the gardener sees advertised or hears about, he is likely to get the idea that the question of plant pests is such a complicated one that no simple and systematic measures are possible. As a matter of fact, warfare with plant troubles, while it is always serious enough, is by no means as complicated as at first appears. The first step to take and the most important thing to know is what kind of enemy you are fighting in any particular case. While their number is legion, they can be classified into three or four groups as spoken of in Chapter XVII, against each of which the same weapons are effective.

HARVESTING AND STORING. There are thousands of amateur gardeners who leave enough fruit and vegetables on or in the ground at the end of the season, to make all the difference between profit and loss on their season's operations. Learn to utilize everything you grow. Every head of Cabbage that splits, every ear of Corn, or handful of Beans that gets too old to use, every root that is left to freeze in the ground, is just so much waste. While many things can be successfully stored through the Winter, or a large part of it, others must be canned. The usual mistake is to try to do all the canning in a rush at the end of the season. The prejudice against canned things is largely due to the fact that they are not canned until they are already old and tough.

In storing vegetables, a few things need an exceptionally dry and warm place, such as a corner of the attic near the chimney. The storage room must be perfectly clean. Get it ready early. Some folks like to provide containers to hold the different fruits or vegetables and so make them easy to handle. Some vegetables demand a free circulation of air about them, while others must be kept barely moist by some packing material. Ordinary cracker boxes and slatted vegetable or "Onion" crates, each of which holds about a bushel, level full, are cheap, clean and convenient, and can be obtained at any grocery store. The boxes are also excellent for keeping Apples and other fruit, and for packing root crops such as Parsnips, Salsify, Turnips, Beets, Carrots and Winter Radishes in sand or sphagnum moss, and also for packing Celery for Winter. Slatted crates are good for Onions, Squash, Cabbage, and for handling Tomatoes, Melons, Egg-plant and so forth, which can be kept for some weeks in a cool place. Directions for storing and harvesting the individual crops are given in paragraphs that follow, but the fuller general information is given in this paragraph on storage.

SOWING AND PLANTING TABLE

Vegetables	Apart in Rows	Rows Apart	Seeds or Plants 50-ft. Row	Depth (in.)	No. of Days to Mature
Asparagus.....	1 ft.	3 ft.	50	4	1 yr.
Beans (early).....	3-4 in.	18 in.	1 pt.	1-2	45-75
Beans (wax).....	3-4 in.	15-24	1 pt.	1-2	55-80
Beans (lima).....	4-6 in.	18-24	1 pt.	1-2	60-90
Beans (pole).....	4 ft.	4 ft.	$\frac{1}{4}$ pt.	1-2	65-100
Beans (pole lima)...	4 ft.	4-5 ft.	$\frac{1}{4}$ pt.	1-2	70-90
Beets (early).....	4-6 in.	12-15	100-150	1	40-60
Beets (late).....	4-6 in.	12-15	1 oz.	2	75-90
Brussels Sprouts....	18 in.	2 ft.	35	$\frac{1}{2}$	100-140
Cabbage (early).....	18 in.	2 ft.	35	$\frac{1}{2}$	70-100
Cabbage (late).....	18 in.	2-3 ft.	25-35	$\frac{1}{2}$	120-180
Carrots (early).....	3-4 in.	12 in.	$\frac{1}{2}$ oz.	$\frac{1}{2}$	60-80
Carrots (late).....	2-4 in.	12-15 in.	$\frac{1}{2}$ oz.	$\frac{1}{2}$	60-90
Cauliflower (early)..	18 in.	2 ft.	35	$\frac{1}{2}$	50-80
Cauliflower (late)...	2 ft.	2-3 ft.	25	$\frac{1}{2}$	100-140
Celery.....	2-3 in.	12 in.	$\frac{1}{2}$ oz.	$\frac{1}{4}$ - $\frac{1}{2}$	125-150
Corn (early).....	3 ft.	3-4 ft.	$\frac{1}{2}$ pt.	2	60-80
Corn (main crop)...	4 ft.	4 ft.	$\frac{1}{2}$ pt.	3-4	80-100
Cucumbers.....	4 ft.	4 ft.	$\frac{1}{4}$ oz.	1	60-75
Egg plant.....	2 ft.	30 in.	25 plants		40-60
Endive.....	12 in.	12 in.	$\frac{1}{2}$ oz.	$\frac{1}{2}$	75-100
Lettuce.....	12 in.	12-15 in.	$\frac{1}{4}$ oz.	$\frac{1}{8}$	60-100
Leek.....	3-4 in.	15 in.	$\frac{1}{2}$ oz.	$\frac{1}{2}$	120-150
Melons, Musk.....	4-6 ft.	4-6 ft.	$\frac{1}{4}$ oz.	$\frac{1}{2}$ -1	90-120
Melons, Water.....	6-8 ft.	6-8 ft.	$\frac{1}{4}$ oz.	$\frac{1}{2}$ -1	100-125
Onion.....	2-3 in.	12-15 in.	$\frac{1}{2}$ oz.	$\frac{1}{2}$	120-175
Parsley.....	4-6 in.	1 ft.	$\frac{1}{2}$ oz.	$\frac{1}{8}$	90-110

SOWING AND PLANTING TABLE—Continued

Vegetables	Apart in Rows	Rows Apart	Seeds or Plants 50-ft. Row	Depth (in.)	No. of Days to Mature
Parsnips.....	3-5 in.	15-18 in.	$\frac{1}{4}$ oz.	$\frac{1}{2}$ -1	100-150
Peas (smooth).....	$\frac{1}{2}$ -2 in.	3 ft.	1 pt.	1-2	50-65
Peas (wrinkled).....	$\frac{1}{2}$ -2 in.	3-4 ft.	1 pt.	3-4	60-75
Peas (late).....	2-3 in.	3-4 ft.	1 pt.	3-4	70-80
Peppers.....	2 ft.	30 in.	25 plants		40-60
Potatoes.....	13 in.	28 in.	$\frac{1}{2}$ pk.	3-4	60-90
Pumpkin.....	6-8 ft.	6-8 ft.	$\frac{1}{4}$ oz.	1	100-130
Radish (early).....	2-3 in.	1 ft.	$\frac{1}{2}$ oz.	$\frac{1}{8}$	25-50
Radish (late).....	2-3 in.	1 ft.	$\frac{1}{2}$ oz.	$\frac{1}{8}$	25-50
Salsify.....	2-4 in.	15-18 in.	$\frac{3}{4}$ oz.	1	125-150
Squash (Summer)...	3-6 ft.	4-6 ft.	$\frac{1}{4}$ oz.	$\frac{1}{2}$ -1	60-75
Squash (Winter)...	6-8 ft.	6-8 ft.	$\frac{1}{4}$ oz.	1	
Swiss Chard.....	8-12 in.	15-18 in.	$\frac{3}{4}$ oz.	1-2	50-60
Tomato.....	3-4 ft.	4-5 ft.	15-20 plants		40-60
Turnips (early).....	4-6 in.	15 in.	$\frac{1}{2}$ oz.	$\frac{1}{2}$	60-75
Turnips (late).....	4-6 in.	15 in.	$\frac{1}{2}$ oz.	$\frac{1}{2}$	60-75

CULTIVATION OF THE CHIEF VEGETABLES

The principles of fertility and culture, which have been covered in the previous chapters, apply alike to all vegetables.

ASPARAGUS.—A hundred or two Asparagus plants, well cared for, will supply the home table. Select well drained soil in which to plant this crop, preferably one a little sandy. Dig out trenches about eighteen inches deep and three feet apart. Tread into these six inches or so of manure, and cover this with good soil to within six inches of the surface. On this prepared bed, set the roots a foot apart, spreading them out evenly. Fill the trench only two-thirds or so at first, and work the rest of the soil in until it is level as the plants develop. Beans, Beets, Carrots, Lettuce, can be grown between the rows of Asparagus during the first part of the season. In the Fall, clear off and burn all the dead material and weeds, and apply a coating of manure. As the shoots or growths develop in the Spring, a few of the largest may be cut, but only for a few weeks the first year. Cultivate thoroughly, however, to get as vigorous a growth of plants as possible. Manure or fertilize in August. This is to throw strength into the crown for the early Spring growth, as the succulent roots act as storehouses of plant food.

BEANS—Always select a warm and fertile soil if available. Avoid nitrogenous manures or fertilizers near the seeds. Thin out to several inches apart as soon as the plants are well started. As the plants develop, hill them slightly. Avoid working or picking while the foliage is wet. The Dwarf Limas are only partly dwarf, and

should be given more space than the Wax Beans. Put the seed in edgeways with the eye down, and if possible, avoid planting within two or three days of rain.

Pole Beans are usually planted in specially prepared hills, 3 to 4 ft.

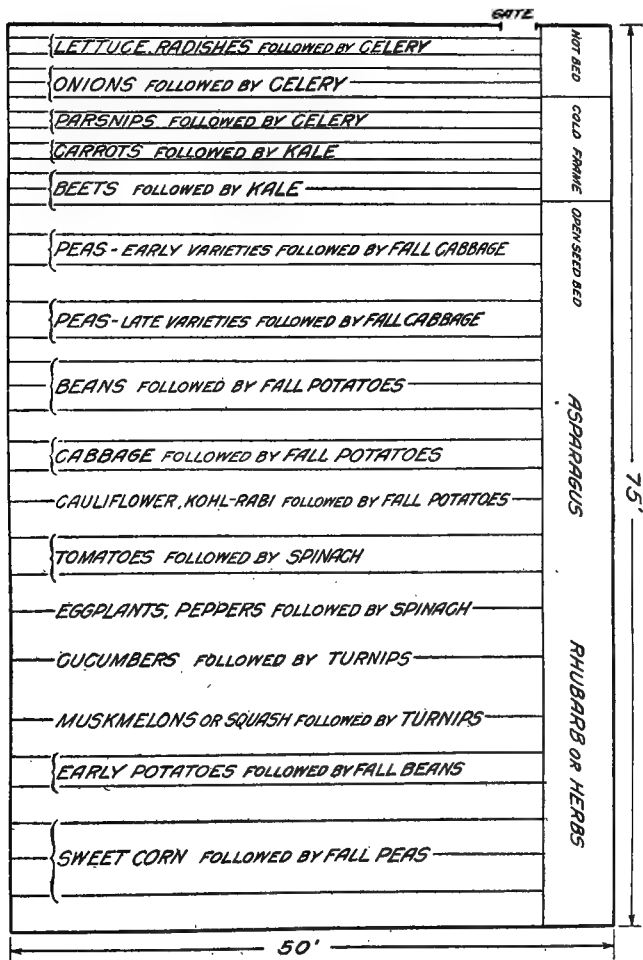

Plan for the cropping of a town or city garden 50ft. by 75ft. From U. S. Farmers' Bulletin 647

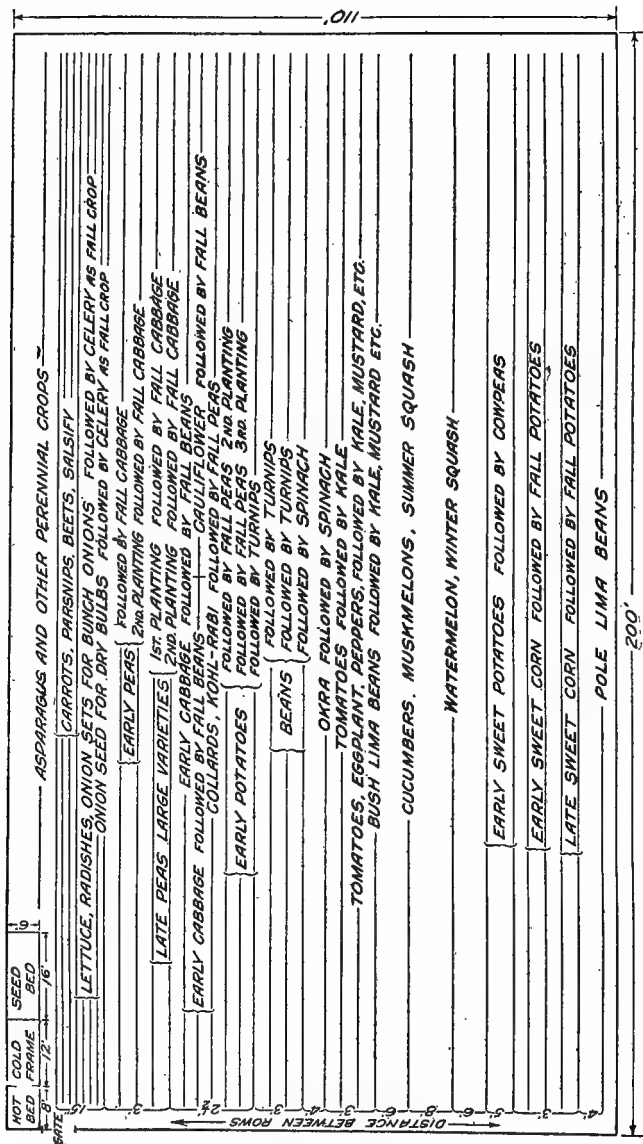

Plan for the cropping of a half acre garden. From U. S. bulletin 647

apart, and supported on rough poles or stakes with cross pieces. A better way is to grow them in rows, and support them on a continuous trellis. For a long bearing season keep all pods picked off as fast as they are large enough. Many varieties, however, are good as shell Beans after they mature.

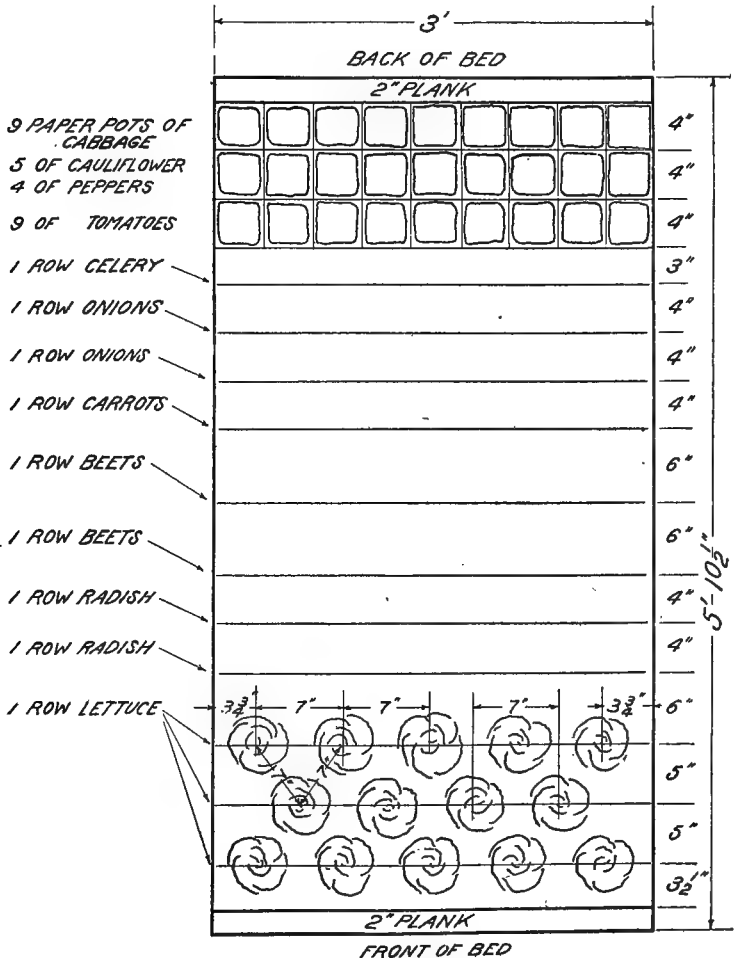

Plan for the planting of a hotbed. The frame is 3ft. wide by 5ft. 10½in. long
See also page 226, Chapter XXI

BEETS.—Plant in well enriched, moist soil and thin early. In setting out plants started in frames or started under glass, put them about 3 in. apart. The thinnings from the crop make excellent greens. As with all the root crops, especially when planted early in the season, growth will be greatly stimulated by a slight application of nitrate of soda. Make two or three sowings between April and the latter part of June when the crop for Fall use and Winter storage is put in.

BRUSSELS SPROUTS.—This extremely delicious vegetable is grown in much the same way as Cauliflower or Cabbage. The “buttons” or small heads which form along the stalk may be grown to a larger size by pinching out the crown of the plant after the “buttons” have formed. These plants are extremely hardy and the “buttons,” which are improved by frost, may be left on the stalk and gathered when wanted until Midwinter.

CABBAGE.—Use deep and very rich soil which is not lacking in lime, and in addition to this, put manure or fertilizer in the hills or rows. The early varieties may be set as close as 16 in. or 18 in. Plants started under glass are set out early in April, and seeds planted at the same time will give plants for a succession crop. Plants for the late crop are started in the latter part of May or early during the first half of July. As a rule, the earlier the better. One of the most important points in growing strong plants for transplanting is to thin them out to several inches apart as soon as they are well started; also keep them thoroughly cultivated at all stages of growth. A slight hilling up as they develop is desirable. Two or three light applications of nitrate of soda given a week or so after transplanting, and again in from ten to fourteen days, will help wonderfully in giving the crop a strong start.

CARROTS.—The general cultural requirements are similar to those recommended for Beets, with the exception that the ground can hardly be made too rich for the latter, while Carrots will often do excellently on ground which is not of so good tilth. For instance, if part of your garden is new ground, Carrots will be all right there, while Beets would do better on the old soil in the highest state of cultivation. For the earliest crop sow a variety recommended for forcing in the hot-bed or cold frame in rows 12 in. apart, setting Radishes between. The Radishes will be out of the way in time for the Carrots to develop. Where space is limited, a late planting of Onions for Winter use may be put in between the rows in late June, omitting every second or third row, giving room to dry and harvest the Onions. It will prove successful only if the ground is free from weeds, and soil moisture from irrigation or otherwise is to be relied upon.

CAULIFLOWER.—This crop is handled in much the same way as Cabbage, with the following additional cultural requirements. The plants are more tender and should not be set out until a week or so after the first planting of Cabbage. Cauliflower is a very gross feeder and even larger quantities of manure and fertilizer can be applied with advantage. An abundance of water is also of the greatest importance. To be kept white and tender the “heads” or curds must be protected from the sun soon after they begin to form by tying the leaves together over them. The “heads” remain in the best of condition for only a few days and should be examined frequently when about ready to prevent “going by.”



Do you grow Brussels Sprouts? They are the most tasty of the Cabbage tribe

CELERY.—The first requirement in growing good Celery is a good supply of water. The soil can hardly be made too rich. Early Cabbage and early Beets, Peas, Lettuce, etc., are usually out of the way in time to put in the Celery, so that the same ground can be used, but an additional dressing of fertilizer should be given. For early use set out strong plants in April or May, putting the rows 3 to 4 ft. apart, and the plants 6 in. in the row. Where irrigation is available the plants are sometimes grown in beds; being placed 8 to 10 in. apart each way; many more sorts may be grown in the same area but they never are as heavy as those grown in rows. The early crop is blanched where it grows, either by backing up with soil which is drawn in carefully about the stalks to hold them in an upright position as they develop, or through a more convenient means; that is, Celery blanchers of various types which are now obtainable. For late Fall and Winter use the seed is sown in April and the plants set out in June or July. Stronger plants can be ob-

tained by transplanting from the seed-bed to give the plants several inches apart each way. This makes them stocky and develops a fibrous root system which will give quicker and better results than if they are set out in the garden. In transplanting water thoroughly and shade from the midday sun for a few days. Be careful not to get any soil over the hearts of the plants. Give clean culture and one or two top dressings of nitrate of soda as the plants develop, and



Young Celery plants. The one on the left has been properly thinned when a seedling; the other has been crowded and is weak



Celery plant when large, blanched by means of a brown paper "collar"

throw enough soil up to them to hold the stalks upright. Blanching is accomplished by taking up the plants with such soil as adheres to the roots, and packing them close together and upright in a trench 12 to 15 in. wide, and deep enough so that the tops of the leaves come about on the level of the soil. As cold, freezing weather approaches, the trench is covered with a mulch or with boards; a portion of the crop left for Winter use is transferred to boxes and stored in the cellar as described in the section on Harvesting. Celery crop should never be worked or handled while the foliage is wet as this will tend to augment any disease there may be.

SWISS CHARD.—Swiss Chard, or Spinach Beet, is now used by many gardeners in preference to Spinach. One great advantage is that from a single planting in the Spring greens are available in abundance until hard freezing weather. If the outside leaves only are taken in gathering a picking may be made every few days, or the large, mid-

ribs may be stewed or creamed like Celery. Give the same culture as you give Beets, and thin the plants out to 6 or 8 in. in the row.

CORN.—To get an extra early crop, a hundred or so plants may readily be started in small paper pots in a cold frame, not to be planted until a week or two before it would be safe to plant outdoors. For this purpose, Golden Bantam, which is extra hardy and also dwarf in growth, is particularly good. As Corn remains at its best but a few days, succession should be provided for, either by making a small planting every week or ten days, or planting an early, a

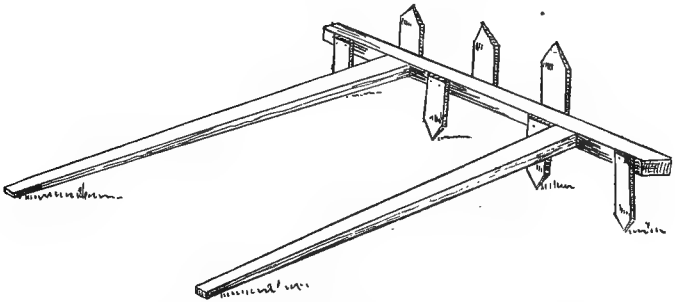

Handy device for marking off rows in the vegetable garden

medium and a late variety at the same time, early in May, early in June, and early in July. Give good clean culture with a slight hilling up when the plants are about half grown; this is about all the plants require. A mistake that is sometimes made is to leave too many stalks in a hill. Thin out to three or four for best results. It is often more convenient to plant and cultivate, and just as good results can be obtained by sowing in continuous rows or drills instead of in hills, the plants being left to stand about a foot apart.

CORN SALAD.—Corn Salad, or Feticus, is grown as a substitute for Lettuce during the late Fall months as it does not thrive during warm weather. Sow thinly in late August or early September. It is very hardy, and with a light mulching of hay, may be had after other salad plants are gone.

CRESS.—This refreshing, pungent little salad or garnishing plant, sometimes called Pepper Grass, may be easily grown throughout the season. Successive sowings should be made, as it quickly runs to seed. For a continuous supply, make small plantings every two weeks in rows 12 in. apart.

CUCUMBERS.—For Cucumbers a light, warm soil is preferable, but

they will succeed in almost any garden soil, provided there is good drainage.

The greatest difficulty in succeeding with Cucumbers and other cucurbits or vine crops, is to protect them from the striped yellow beetle, the Melon louse and the black wilt. To make sure of a crop give a general purpose spraying every ten days or two weeks, using a soapy-nicotine spray. As it is essential to cover the underside of the leaves as well as the surface, an angle nozzle should be used and a sprayer sufficiently strong to produce a good mist spray. Where such a sprayer is not available, dry spraying or dusting may be substituted, keeping the plants well covered from early growth. Much earlier crops and better results may be had, by starting the plants in paper pots in cold frames as recommended for sweet corn. It is well, however, to use larger pots—say, 4 in. square. Fill each about half full with a compost of light soil and old, thoroughly rotted manure. Thin out to three or four plants, and after they have been set out long enough to become established, thin to two plants to a hill. Keep the soil between the plants well cultivated until the vines cover it. In setting out started plants the hills or rows should be enriched with well rotted manure or guano or blood and bone, the same as when planting seeds. A method of insuring a good stand from seed is to soak half of the seed you have to plant over night in warm water, dry it off in fine dust or land plaster, and mix with the rest planting two together, covering some preferably a little deeper than others. The advantage of this is that whatever the conditions that follow planting may be, enough of the seeds to make a good stand are pretty certain to come through. If the vines are wanted to continue bearing for a long time, pick off fruits as they mature, whether they are needed or not. For late use and for pickling, a second planting may be made the latter part of June.

EGG-PLANT.—The Egg-plant is another vegetable which revels in the richest soil and an abundance of moisture. General culture is the same as that recommended for Tomatoes, except that the plants do not have to be staked up or pruned. The plants should be grown in pots and for best results repotted once or twice so that they are in three and a half or fours when set outdoors, which should not be until after Tomatoes are planted. The most dangerous enemy to be encountered in growing Egg-plants is the striped Potato bug. Arsenate of lead paste may be used, but if a few plants are grown, hand picking (knocking the beetles off with a small stick or paddle into a pan half full of kerosene and water) will prove effective and will give little trouble as the beetles are killed *before* they eat.

ENDIVE.—This is another salad grown mostly for Fall use. Sow the same as Lettuce in June or July, and thin to about 12 in. It requires blanching to be ready for use. The individual heads may be tied up loosely with raffia, or two 6- or 8-in. boards temporarily nailed together in an inverted V shape may be placed over the row, blanching a section at a time. Do not work crop when the leaves are wet.

HERBS.—A few of the common or culinary herbs should be grown in even the small vegetable garden. They are useful for flavoring during the Summer, and it is an easy matter to get a Winter supply by gathering and drying sprigs or foliage in Summer or Fall. They

will keep in any dry place for Winter use. Hang them up in bunches. The garden herbs contain both annuals and biennials. Among the most popular of the former are Anise, used for flavoring and garnishing; Sweet Basil, used in stews and for seasoning various dishes; Dill, of which the seeds are used largely in making Cucumber



Improved Golden Wax pod Bean



Cabbages—fresh and tempting

pickles; Summer Savory, another popular soup herb, and *Tagetes lucida*, which has much the same flavor as Tarragon, and is used as a substitute for it. Of the perennials, which after once being established will supply the garden without replanting each season, there are Caraway, widely used in cookies, etc.; Catnip and Sweet Fennel, used for flavoring sauces; Rosemary and Sage, which is very easily grown, and used perhaps more than any other herb for seasoning; Winter Savory which, like the Summer variety, is used for flavoring, and Thyme, another favorite seasoning herb. Most of these herbs can be grown without difficulty. Sow them in drills,



Early, Stump-rooted Carrots

as you would vegetable seeds of similar size. Thin them out to a few inches, if they come up too thickly, and give clean culture. Those of which the seeds are used should be cut and dried, when the seeds can be rubbed or pounded out and freed from the chaff by winnowing or sifting.

HORSE RADISH.—While only a small quantity of these may be needed for home use, a few plants may be grown as easily as not. Instead of seeds, sets or small pieces of roots are planted. They are perfectly hardy, and can be taken up in Fall or early Spring, just as wanted. Two dozen roots will give an ample supply for a small family. Its chief cultural requirements are plenty of moisture and a deep rich soil.

KALE or BORECOLE.—This vegetable may be described as a loose leaf Cabbage. It is cooked as greens. It is improved by frost and it is so hardy it may be had from outdoors in the garden when all other greens have long since perished. It is given about the same treatment as late Cabbage. Only extra hardy varieties may be sown in September and wintered over, like Winter Spinach.

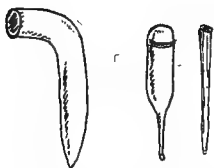

Types of dibbers for making holes for planting

KOHL-RABI.—This comparatively little used vegetable is very easily grown, and if cooked before the roots or bulbs get too large, is very good. For an extra early crop it may easily be started under glass and transplanted. To have it for use throughout the season, sow succession crops, as for Turnips.

LEEKS.—The Leek to obtain full development requires a long season of growth. It transplants readily, and seedlings started in April or early May may be transplanted in June, preferably to drills which have been enriched with old manure or the starting mixture. The lower portion of the stem should be blanched for use like Celery. This may be done by keeping the earth drawn up to it, or the plants may be taken up and stored in a trench like late Celery. They are very hardy and the flavor is greatly improved by freezing.

LETTUCE.—While Lettuce can be grown from early Spring until late in the season (and with the use of frames the year around) success with it will depend very largely upon using the right type for the particular season or conditions under which each successive crop is to be grown. The number of varieties in general culture is so great that it is rather confusing, but if the gardener gets the several distinct types fixed in his mind, he can make his selection intelligently. All varieties can be classed in general in two groups: the loose leaf and the headed. The former are the easier to grow, but as a general rule, the latter are considered of better quality, although that is mostly a matter of taste. The loose-leaf type is suitable for growing under glass, being for this purpose much less subject to the dreaded rot which quickly destroys head lettuce under glass, and also for growing outdoors in Spring, early Summer and Fall. With irrigation it can be grown easily throughout the Summer months, but in dry weather runs quickly to seed. The head types of Lettuce may be considered in three sections: the butter head, the Cabbage head and the tub. Of these, the loose leaf is suitable for Spring and Fall use. The hard or crisp heading sorts take longer to mature but form heads which resist the heat and are slower to run to seed, and are good for Midsummer growth; they

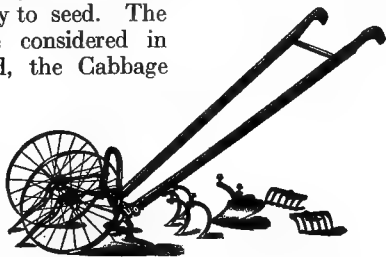

Planet Jr. hoe, very useful for medium-sized and large gardens

are not suitable for forcing. The Cos type, most varieties of which have to be tied up to blanch thoroughly, is quite distinct in appearance and flavor from the other types, but is easily grown and should be given a place in most gardens, even in small gardens, for variety. It is suitable for use during Midsummer and early Fall. To be of the best quality, Lettuce must be quickly grown. It requires an abundance of moisture and a high percentage of available nitrogen in the fertilizer or manure. Well-rotted horse manure is particularly adapted to the growing of this crop. A mistake often made in sowing the seed in drills in the open is to let the plants stand too thickly. Thin them out as soon as they are well started to 6 or 8 in. in the row, or even more in rich soil under irrigation. To have a succession of crops around the year start plants in January or February for setting out into the frames, and make a small sowing every two weeks or so thereafter, changing the type you use according to the changing seasons.

MELONS.—Muskmelons are similar in their cultural requirements to Cucumbers. In northern locations where the seasons are short, it is always a good plan to start at least part of the crop early in paper pots in frames. As some gardeners also advocate the pinching off of the ends of the runners after they have attained 4 or 5 ft. in length, to hasten the development of the laterals on which the fruits set, it may be well to do this. For very small gardens the bush type of Melon, recently developed, offers distinct advantages. The hills may be planted as close as 4 ft. apart. Heavy soil should be avoided, if possible. If it must be used, add plenty of sand, and leaf mold to the soil in the hill when preparing it, and raise the hill slightly; keep it flat but bring it a couple of inches above the ground level.

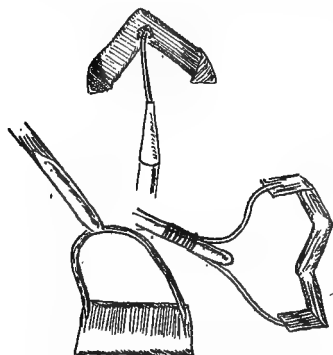

Garden hoes of different patterns

WATERMELONS.—The requirements of Watermelons are in general the same as those of the other cucurbits already mentioned, except that much more space is demanded by them. The hills are put 6 to 8 ft. apart each way. In a small garden space can sometimes be saved by putting Watermelons (and Winter Squash and Sugar Pumpkins) near the edge of the garden where the vines can be allowed to run out over the grass, or supported on old Pea Brush or

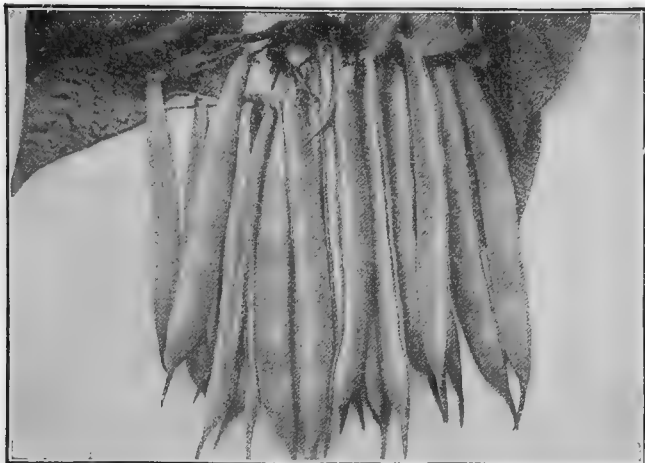

Dwarf French Beans

something similar along a fence, thus saving space. Plant only a variety adapted to your locality. In the Northern States the season is not long enough for any but the early varieties to mature, while this advantage can be overcome to a great extent by starting the plants in paper pots in frames two weeks or so earlier than the seeds could be planted outside.

MUSTARD.—The leaves of the newer, larger growing varieties can be used either as a salad or as greens, some of which attain a foot or more in height. Three or four crops may be sown during the season to supply a succession. Those planted in Summer or early Fall will usually give the best results. Sow thinly in drills 15 or 18 in. apart, and thin out and cultivate as you would Lettuce.

OKRA may be grown easily if a rich soil and a sunny position are provided. It is very tender and should not be planted until the ground is thoroughly warm. The rows should be from 2 to 3 ft. apart and the plants thinned to 18 in. or more to give room for ample development. The pods should be used while they are still young and tender.

ONIONS are used in all stages of development, from seedlings as big as a pencil, eaten raw, to the mature dried bulb. They may be grown from seed, from prickers (seedlings started under glass and set out later in the garden), sets (which are very small bulbs of standard varieties, grown small especially for this purpose), or from the

perennial multiplier, the Potato or Egyptian Onion. The last three propagate themselves by multiplying, either at the roots or at the top of the seed stalks, the cluster of bulblets being divided up and set out for the following crop. They may be planted either in early Spring or in late Fall.

Onions from seed yield very heavily in rich soil, but the preparation of the seed-bed must be of the best as the seed is fine; it must be lightly and firmly covered, eight to twelve seeds being drilled in to the inch of row. In addition to rich and very thoroughly prepared soil, the most important thing in growing Onion seed is to keep ahead of the weeds. The plants when they first come up are very small, not much bigger than blades of grass, and the whole crop may very easily be lost through neglect in this regard. Go through it with the wheel hoe and also by hand within a week or ten days after they break ground. Continued clean culture and occasional light applications of nitrate of soda will keep the crop developing vigorously till Midsummer. Lime in the soil and soot sprinkled along the rows will tend to mitigate the damage done by the Onion maggot. The most certain remedy for the maggot, however, is a poison spray or bait for the flies, which can be applied only with a strong pressure sprayer. When the plants get too large to go through them with the wheel hoe, the slide or scuffle hoe should be used, the kind with guides or runners in front of the blades, which hold it at an even depth, making the work easier and lessening the danger of injury to the bulbs. As soon as the tops die down the bulbs should be pulled and laid in windrows, and raked over every day or two until thoroughly dried; then they may be taken and the tops cut off, and spread out on a floor, or in an open shed, or packed in slatted Onion crates, which hold about a bushel apiece, to dry off thoroughly before being packed away for the Winter.

For transplanting, to get large bulbs, the seeds should be started under glass in February or early March, and transplanted in April or Early May, setting the plants about 3 in. apart. Seed should be sown very thinly in flats, with rows 3 or 4 in. apart. Keep them as near the glass as possible, and transfer them to the cold frames as soon as it is safe, so as to get hardy, stocky plants. In transplanting the roots are trimmed back to within three quarters of an inch or so, and half of the tops removed, when they can be handled readily, and practically none will drop out if the work is properly done. Sets planted early in the Spring by pushing the bulbs down into ground until they are slightly covered will make a quick growth and give Onions ready for use before those from "prickers" or

seed sown in the open. Rich soil and two or three hoeings is all that will be required.

PARSLEY.—For Summer use sow the seed early in Spring, soaking it thoroughly a day or two, for it is very slow to germinate, and thin the plants to 6 in. or so apart when they are well started. Give plenty of water to keep the growth succulent and tender. For Winter use sow a packet of seed in late July or August, and when the little plants have become well established, transplant to pots or a small box, or to a cold frame. A flat of Parsley in a sunny kitchen window will furnish garnishing throughout the Winter.

PARSNIPS are easily grown, but to produce long, smooth roots requires deep, rich soil. Another essential is to get them sown very



Onion sets

early in the Spring, as the longer the season the better the crop resulting, as a rule. Thin them out *early* as the long roots and side branches get tangled together, and those that are left are apt to be seriously injured by the process of thinning if it is not promptly attended to. They will be ready for use in the Fall and can be used from the ground until freezing weather, when enough to last through the Winter should be stored, the remainder being left in the ground for Spring.

PEAS from any one planting will remain in the best of condition for use only for a comparatively short time. To have a constant supply throughout the season, a succession of plantings should be made. Under irrigation they can be had from early June until frost, other-

wise dry weather is pretty sure to cause a failure of the crop during late July and August, so that it does not pay to plant after late May until the latter part of July.

The dwarf varieties do not bear as heavily nor for as long a period as the climbing sorts, but for small gardens they have the advantage that they are economical in space and do not require support. One or two good dwarf sorts sown every ten days or two weeks will maintain a supply. If the tall varieties are used, each planting will bear for two to three weeks, so that fewer plantings are required to maintain the succession. If an early medium or late variety is planted at the same time, the plantings may be a month or so apart.

The smooth, extra hardy varieties may be planted as early in the Spring as the ground may be worked. The others, however, should not be put in until a week or two later. If the soil is wet and kind of heavy, make early plantings near the surface. If well dried out, they may be planted at the bottom of a trench 4 or 5 in. deep, and covered only 1 to 2 in. deep at first, being filled in as the plants grow. Get the roots well below the surface so that they do not feel so quickly the effects of dry weather. A good, clean culture and protection with kerosene emulsion or nicotine spray (if the Pea louse puts in an appearance) and getting the brush or trellis in as soon as the plants break ground (in the case of the tall or climbing varieties) are the main points in achieving success with this crop.

PEPPERS.—The instructions given for Egg-plants apply also to Peppers. Be sure, however, to choose a variety or type suitable and adapted to your conditions and purposes. In the Northern States, it is well to stick to the earlier sorts, unless you grow your own plants and can have extra large ones ready for setting out. The small, pungent varieties are grown for pickling and flavoring, and the large, mild ones for stuffed Peppers and other table dishes.

POTATOES.—While Potatoes usually take up so much room, and again can be bought so readily that they do not find a place in the *small* home garden, a row or two of extra early ones, as a special treat for the table in July, should be made room for. To get the earliest results, select good, clean, medium sized potatoes of an early variety, and cut in quarters or halves, pushing the pieces down into a flat of sand till they are nearly covered and as close together as they will go. If these are kept in a sunny place, protected from frost and watered, the roots will make a vigorous growth, while the tops will remain very short and stocky, so they will be only 2 to 4 in. in length when they are ready to set out.

Prepare the rows with manure or fertilizer; throw in a little soil, and on top of this plant the Potatoes; then cover them over entirely, sprouts and all, to about 3 in. deep. An astonishing growth will result during the next two or three weeks. Potatoes, while vigorous, will not take care of themselves. The ground should be worked about them frequently, maintaining a soil mulch, the soil thrown up to them a little each time it is worked. When they are ready to



“The noble tuber”: what good Potatoes should look like

blossom they may be hilled up, if the season is wet, or the soil is moist. Under some conditions however, they should be given practically level culture as more moisture is maintained to develop the growing tubers. To make sure of success, it will be necessary to protect the crop from both the striped Potato beetle and early and late blight. This is done by spraying, every ten days or so, from the time the plants are about 6 in. high, with Bordeaux mixture and arsenate of lead paste, or a similar double purpose spray.

PUMPKINS.—A few hills of sugar Pumpkins, planted in the Sweet Corn, among pole Beans or along the edge of the garden, where they can run over the grass or trained over brush, etc., will give plenty of material for a number of pies. The culture is the same as that

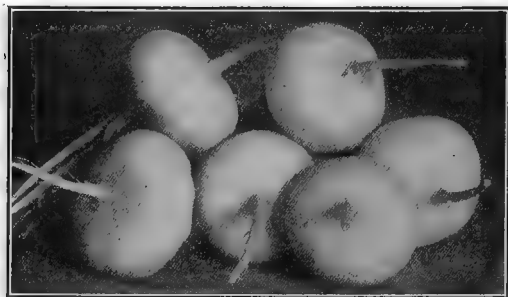

White Milan Turnips

recommended for Winter Squashes, except that they mature more quickly, and can, therefore, be planted later.

RADISHES.—These are easily grown in almost any soil, but for the best quality the soil should be rather sandy, and

a good coating of land plaster or gypsum incorporated with it before seed is sown. Avoid manures and fertilizers rich in nitrogen, as these are apt to cause misshapen roots and too great leaf growth in proportion. Two mistakes most often made in growing Radishes are to sow too many at a time and not to thin them enough or early enough to have them sufficiently far apart in the row. Give each plant room to develop. Radishes are easily raised under glass, requiring only 40 to 45 degrees temperature. The quick maturing kinds may be sown between rows of Carrots, Lettuce or Beets and gathered before the latter need all the room. A succession of roots in the best of condition, either under glass or outside, may be had by sowing every ten days or two weeks.

RHUBARB—Six to a dozen plants will supply a medium sized family. The soil should be made very rich and dug as deep as possible. Crowns taken from old established clumps are usually used for planting. Put them 3 to 4 ft. apart each way. The crowns themselves should be planted quite shallow, being covered with about 4 in. of soil. Plants set out in the Spring will bear quite abundantly the following season; or young plants sown from seed in the Spring, and transplanted in June to temporary rows in the garden, may be set out the following Spring in their permanent place, which should be, if possible, a sheltered spot, where they will not interfere with the cultivation of other things. Rhubarb, like Asparagus, stores much of its early Spring plant food in the thick root stalks over Winter. Therefore, manuring or fertilizing in the Fall will help the following crop. Dressings of nitrate of soda in Spring also produce splendid results, but be careful to keep it off the leaves.

RUTABAGA.—The Swedish or Russian Turnips differ from the or-

dinary kind in that they grow much larger and have a longer season in which to mature properly. They should be sown early in July. As the ground is frequently dry at this time, firm the seed well in, pressing the soil over the row with the back of a hoe or with the sole of the foot. Thin out to 6 in. or more apart, according to size of the variety grown and the richness of the soil.

SALSIFY.—Salsify, or Vegetable Oyster, has a very decided flavor from which it gets its common name. Unless you have used it and know you like it, plant only a small quantity. Its culture is easy as it is free from injury by either insects or disease. The only trouble in growing it is that it tends to become forked or sprangled. If possible, plant only on soil manured the previous season, and avoid fertilizers that are rich in nitrogen. It requires about the same season of growth and about the same general culture as Parsnips, but the rows may be put nearer together as the foliage is not so large.

SEA-KALE, which shares with Rhubarb and Asparagus the great advantage of being a perennial plant, yielding year after year, may be grown easily from seed or from sets—pieces of the roots such as are used in planting Horse Radish. To grow from seed sow in April in drills about 15 in. apart, thinning out to 6 in. Plant early the following season

as you would Rhubarb, except that 3 ft will be far enough apart between the plants. The Spring growth must be blanched for use. This is accomplished by shoveling around the crown of each plant in the Fall a peck or so of clean sand, and then throwing up over this, soil from between the rows. This banking up is left in place un-



Very profitable for the small garden—Swiss Chard

til after the Spring growth has started; then the soil is hoed or shoveled away, the ground enriched with bone and manure, and cultivated occasionally during the rest of the season, or the plants when grown may be taken up and forced in frames, hotbeds, or the greenhouse. In this case they are handled in much the same way as Witloof Chicory.



Tomatoes trained to a fence

SPINACH.—As with Lettuce and some other crops, success with Spinach depends largely on choosing a variety suitable for the season for which it is wanted. For Spring use Winter Spinach is sown the previous Fall and carried over with a mulching of hay, straw or dried litter. In Spring two or three succession plantings can be made to maintain the supply until Summer. For Summer use sow, during late May, New Zealand Spinach. This is not cut like other varieties, but the leaves are gathered from the stem while the plant continues to grow, until hard frost. The Spring varieties can be sown again for use in the Fall, or under irrigation they grow readily during Midsummer.

SQUASH.—These should be planted or started in frames, as recommended for the Cucumbers and Melons already discussed. For earliest use, plant a few hills of scalloped or crook-neck type of Summer variety. These may be had in the bush form, thus taking

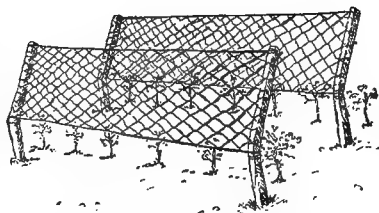

Wire-netting supports for Tomato plants

up very little space. There are a few varieties, such as Fordhook and Delicata, which will serve for both Summer and Winter use. If the plants are kept well dusted with tobacco or wood ashes during the early stages of growth, it will help to discourage the appearance of the insect likely to attack them. Success of the late or Winter varieties may be made much more certain by starting them in paper pots in frames and setting out. The first sign of the deadly Squash borer is likely to be a slight wilting of the leaves on a hot, bright day. Make a thorough examination at once at the base of the stem, and if you find a small hole from which a gummy, yellowish matter has exuded, slit the thin cavity lengthwise until you find the intruder.

TOMATOES.—Set out the strongest, stockiest plants you can find, even if you have to pay several cents more apiece for them, as soon as danger of late frost is over. A half handful or so of bone or guano in each hill will produce a strong start. However, a little chicken manure, or a well rotted compost may be used for this purpose. Set the plants deep, even if you cover several inches of stem, as new roots will be formed all the way up, and you will be better prepared, therefore, for dry weather. For garden culture the plants should be supported by stakes, a trellis, or the specially prepared circular Tomato supports now available. Set them from 18 in to 2 ft. apart, according to method of training to be pursued. Two dozen plants or so, if they are well cared for, will provide an abundance of fruit for the average family. To get the earliest and the smoothest fruits, keep the vines tied up with raffia, strips of cloth, or soft twine, as they grow. The side shoots or suckers should be rubbed off as soon as they appear, the plant being trained to three or four branches. By this method the fruits which do set will have more nourishment and more sunshine than if the vines are allowed to grow bushy. The newly set plants must be protected from cut-worms with paper collars or poison baits, but strong, pot-grown plants are likely to defy them, as they are too large and tough to be eaten through readily. Just before danger of frost pick all the

mature fruits and pack them in straw in a cold frame to ripen up. In this way they may be had for several weeks after frost.

TURNIPS.—Seed for the first crop may be put in as soon as the ground can be gotten ready in the Spring. As they are at their best for table use only for a short time, it is a good plan to plant an early and a medium or late variety about the first of each month through the season; in July a larger planting can be made for Winter use. While the tender seedlings are very small when they first come up, they grow very rapidly, and unless thinning out is done at once, it is likely to give the crop a severe set-back when it is attended to. Freshly manured soil should be avoided, and if there is a spot in the garden which is light and sandy, it is apt to produce roots of a milder flavor than heavy soil.

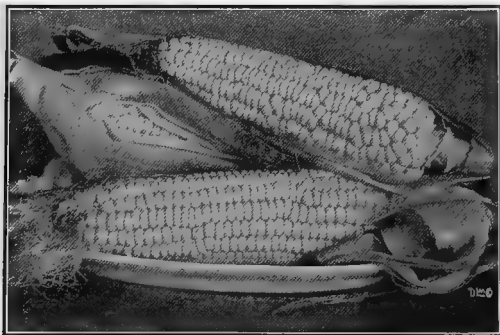

Mammoth Sugar Corn—well-developed ears

VEGETABLE MARROW.—This is another member of the curcubit family, very similar in habit of growth to the Summer Squashes, there being also bush, dwarf and running varieties. It is planted and grown in the same way. The fruits should be used while comparatively young.

WATERCRESS.—There may be opportunities for the cultivation of fresh young plants of this delightful, pungent, and health giving salad. It delights in a slow running brook, but may be also cultivated in beds where there is a very slight flow of water. It is easily raised from seeds, but more generally perhaps from cuttings. A bunch of the stems one buys from a green-grocer, stuck in the wet soil, will root readily, and the young tender sprouts from these will furnish the supply throughout the Summer.

CHAPTER XV

Home Canning of Fruits and Vegetables

THE products of our own garden always taste better than fruit which has been canned in the commercial establishments. We have grown the fruit; it is ours and we like it.

Science always tells us why we do a thing, and it is only by a knowledge of why we do things that we get so that we can apply the art of doing one thing to the art of doing another. As early as the seventeenth century, persons began to know that it was very minute plants and animals which caused the spoiling of fruits. These organisms induce fermentation and putrefaction, and are of immense importance. They are of three groups: First, molds, which appear as a white, green or black furry growth; they are often present on the vegetables at the time we can them. Secondly, we have the yeasts, which are familiar to every housewife who makes bread. These little "plants" are invisible to the naked eye and seem to like to get into all substances which contain sugar. They are not usually there very long before they cause the substances to become sour, the next stage being the production of alcohol. The air is full of yeast, and it is almost always found on ripe fruit. The third class consists of bacteria. When we realize that sometimes fifteen thousand of these pesky little things can be placed end to end in an inch, we wonder how they can do so much damage, but they are the hardest foes of canning we have to fight. These very minute organisms have a power of producing very resistant shelled spores, and they are sometimes not even injured by cooking. If, however, after the first boiling, they remain for a short time, they should soon start into growth; it is then that we kill them.

PREPARATION FOR CANNING. Every utensil which the housekeeper uses, and every vegetable and all the sugar and the water, contain some form of mold, yeast or bacteria. Our problem then is to take all possible care that each of our three enemies is conquered.

For absolute cleanliness the soil must be carefully washed from the fruit; over-ripe fruit should never be used; bruised and cracked fruit should be avoided, for it is in the bruises and cracks that the yeast and molds are very prevalent. All jars and containers must be thoroughly scalded with boiling water.

In canning, we use two terms: scalding and blanching. Scalding means merely dipping fruit into boiling water, while blanching carries with it the meaning of allowing the fruit to remain for some time in this hot water. We find scalding and blanching very beneficial because it removes the dirt and organisms from our fruit, and it serves to take off certain slimy or sticky substances which are found on some vegetables and when canned mars their beauty. In Peaches and Tomatoes it is a method of removing the skins; with some other fruits it reduces their bulk somewhat, and avoids too great shrinkage in the jars.

STERILIZATION means the eliminating of all the live molds, yeasts and bacteria. With some fruits and vegetables it is merely a short boiling. In canning such tender fruits as Raspberries, which should have a minimum amount of handling, and some of the vegetables, such as Peas, Beans, Corn and Tomatoes, which are only canned with difficulty, the fruits should be placed in the can and so arranged that they can be brought to a boiling point on from one to three successive days. This practice is based on the fact that, as previously mentioned, many of the bacteria produce hard shell spores which are not killed during the first boiling.

From the Ontario Department of Agriculture Bulletin No. 236, we derive a very useful time table for the canning of fruits and vegetables:

TIME TABLE FOR FRUITS

Product	Treatment	Scald or Blanch	Syrup		Sterilization
			Sugar	Water	
Apples.	Peel, core, halve or quarter.		1 part	1 part	Bring water to boil $\frac{1}{2}$ minute. Allow jars to stand in boiler 20 min. Seal tightly.
Apricots.	Halve, pit or pack whole.	1 to 2 mins.	1 part	1 part	Water boiling 5 to 10 mins. according to ripeness of fruit.
Blackberries.	Wash and pick over.		1 part	$\frac{1}{2}$ part	As apples.
Blueberries.	As blackberries.				
Cherries (Sour).	Wash, stem and pit.		1 part	$\frac{1}{2}$ part	As apples.
Cherries (Sweet).	Wash, stem and pit.		1 part	1 part	As apples.
Peaches.	Skin, halve or quarter, pit or pack whole.	1 to 2 mins.	1 part	1 part	As apricots.
Pears.	Peel, halve or quarter, core.		1 part	1 part	As apples.
Plums.	Pack whole or pit.		1 part	1 part	As apples.
Raspberries.	Hull.		1 part	$\frac{1}{2}$ part	As apples.
Strawberries.	Hull.		1 part	$\frac{1}{2}$ part	As apples.

By this method of intermittent boiling the fruit is kept in good texture and shape, and the natural beauty is not lost. An ordinary wash boiler can be converted into the ideal home canning outfit by fixing a false bottom of some sort in it upon which the cans can be placed;

TIME TABLE FOR VEGETABLES

Product	*Treatment	Blanch	Sterilization
Asparagus.	Wash, cut to jar length.	5 to 7 min.	30 min. on 3 successive days.
Beans (String).	String, cut up or pack whole.	5 to 10 min.	As asparagus.
Corn (Off cob).	Cut from cob after blanching.	10 to 15 min.	As asparagus.
Peas.	Hull.	5 to 10 min.	As asparagus.
Tomatoes.	Skin, core, halve or quarter.	1 to 2 min.	15 min. on 3 days†

*Salting to taste.

†20 minutes on 2 days has been successful, but cannot be recommended without reserve.

enough water is used in the boiler to come within an inch or two above the false bottom; the steam will do the heating as well as would filling the boilers full of water. The tops of the jars of fruit are slightly loosened before placing in the boiler in order to allow for expansion, but the boiler should have a very close fitting cover which will prevent unnecessary loss of steam.

Many of the larger fruits are canned by merely cooking in a syrup. For Peaches and Pears, a pound of sugar and a quart of water should be used for every four pounds of fruit. For smaller fruits, use one-half pound sugar for every pound of fruit, and let stand two hours before cooking. Bring the small fruits to a boiling point only. The large fruits, as soon as pared, should be thrown in cold water to prevent discoloration. When a sufficient quantity is prepared they can be placed in the boiling syrup and allowed to cook until they are easily pierced with a straw.

Large-mouthed jars should be used for canning. They should be placed in a pan of cold water and brought to the boiling point while the fruit is being prepared. When the fruit has been sufficiently cooked, take the jars out of the boiling water, stand on a folded towel, put the fruit in the jars through a wide-mouthed funnel, filling jars until they overflow. In order to get all of the air bubbles out of the cans an excellent method is to run a spoon handle inside of the jar until they are all gone, then the can must be filled until it overflows again and sealed very quickly.

All of the canning utensils should be kept in a pan of boiling water and never allowed to get cold. After sealing tightly, the cans should be placed upside down and allowed to cool slowly. All cans which begin to ferment and bubble should be boiled again. When you are sure that the fruit is properly sealed and that none of the cans are going to work, the jars should be wiped a little and placed in a cool, dry place. All canned products which contain sugar are decomposed by sunlight, so that it is best to keep canned fruit in a place which is dark.

In the making of jams, jellies and preserves, fruit and sugar should be used pound for pound. Always heat the sugar before adding to the

strained juice, which should have boiled for forty minutes; stir only long enough to dissolve the sugar and test for jelly.

We would advise that the so-called preservative powder should not be used. Small doses are not immediately harmful to the healthy adult, but for children and invalids, or in larger doses, the effects are dangerous, and for these reasons, although these powders prevent spoiling, they should not be employed.

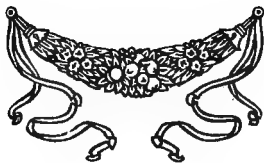

CHAPTER XVI

Pruning

PRUNING, when practised properly, is an aid to trees and shrubs. It not only stimulates growth, but increases fruitfulness at certain seasons; it keeps the plant full of healthy, disease-resistant growth, and gives us the privilege of changing the habit. We do admire symmetrical, dense trees, graceful shrubs or stocky hedges, all of which are maintained by pruning. Many times we even admire the picturesque results that can be obtained by making a tree grow out of its natural development. Pruning does stimulate growth because it tends to send the energy to the part of the plant in which it is most wanted. It is well known that a pruned plant inclines to resume its natural habit and that there is always a tendency to grow from upper buds. Checking growth usually causes an increase in flower production.

Besides the general removal of large branches, pruning includes the process of pinching, or removing undeveloped eyes to check growth in a certain direction; trimming, shortening top and roots at transplanting; topping, removing the leader or a flower stalk to retain the energy in the plant rather than in making a strong leader or seeds; suckering, the removing of shoots at base of plant to throw the strength into the plant itself. This would include the cutting of shoots from the stock in grafted plants; disbudding, removing of small buds at sides of main ones to throw the food into the perfect production of the larger flower; ringing, the cutting out of a narrow ring of bark from a branch of a tree (in the case of fruit the result is the production of a large specimen due to the fact that the food is all kept at the place beyond the ring); root-pruning, the cutting of roots at planting time so that they may be symmetrical and have clean, undecayed surfaces, but the top must always be shortened proportionately when this is done; sprouting, the cutting out of all sterile, unfruitful branches, which are usually called water sprouts.

ROSES. If we observe Rose bushes we will be able to see that they bloom from what were the strong shoots the previous season, and that these shoots become weaker when another shoot begins to grow lower down. There is an annual renewal of wood, therefore, and this is why pruning is necessary. Most Roses must be pruned severely at planting. Some climbers are ruined from the start by too

little pruning. In order to keep the bushes open nicely, the cut must always be made to an outside bud. Take care not to leave stubs above a bud either; the tips always die back and may die back farther than preferred.

BRIERS AND ROSES FOR LANDSCAPE EFFECT. Those Roses which are to be seen in mass and with which a profusion of bloom is to be preferred to a few slightly larger blooms should be pruned but little. The main work is to improve the shape of the bush and cut out the very oldest wood. Wood which has flowered year after year should be cut out from the base of the plant so that the younger shoots may be given a chance. Prune in March.

CLIMBING AND POLYANTHA ROSES. When the new season's wood is completed cut out the old stems which have flowered. Little pruning is necessary in Spring except to cut out any branches which have been killed. The old wood can usually be gradually removed year after year. All new canes should be carefully tied up. Prune in March.

HYBRID PERPETUALS. Various soils and climates cause the hybrid perpetuals to be either very tall bushes or, in other localities, only to attain a height of three feet. The varieties differ greatly in

height and amount of pruning needed. The weakest shoots should be pruned the most severely; in the same way the strongest varieties need the least pruning. Never leave a weak shoot. Care must be exercised that all shoots are not pruned to the same height. Prune early in Spring for main pruning, because the shoots are apt to freeze back if done in Fall or Winter. The canes of the strongest varieties, which may be eight or nine feet long, should be shortened a third in Autumn to prevent the injurious whipping by the Autumn winds.

HYBRID TEAS. The hybrid teas should hardly be pruned as severely as the hybrid perpetuals, otherwise the treatment is the same.

THE TEAS often freeze back to the soil; if so, remove all wood which is the least bit browned. Take care to

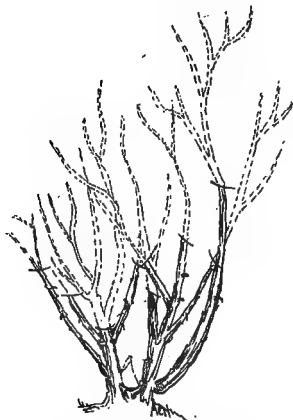

PRUNING A DWARF ROSE

The dotted lines show the growth or stems that are to be cut away. As a rule amateur gardeners are too much afraid to prune hard. "The weaker the growth the harder the pruning," is a fairly safe rule to follow

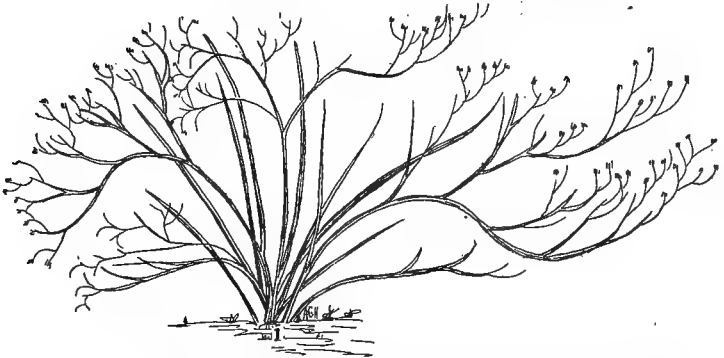
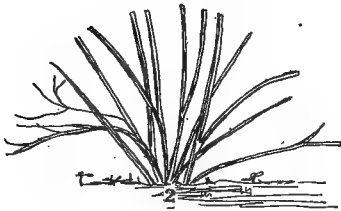
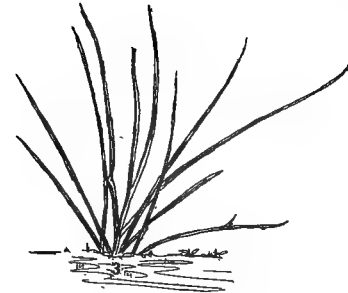

PRUNING SHRUBS

1, An unpruned example. 2, Pruned so that all the branches are of equal length. This is improper but all too commonly practiced. 3, Growths thinned out and shortened. This is the correct method. It is the same shrub in each case

SHRUBS. There are essentially two classes of shrubs—the Spring and the Summer blooming ones. Those which bloom in the Spring have their flower buds all formed on the bushes by the previous Autumn; they are usually near the top of the plant. Any pruning in late Winter or early Spring causes a removal of these flowers.

prune very severely; the plants will appreciate it and reciprocate by producing good blooms. All shoots which live through the Winter should be shortened one-third. Never make the mistake of thinking that there is so little bush left that it will be best not to prune at all. Nothing could be more faulty. Teas must be carefully watched for suckers from the stock, which should be removed from their point of origin. The leaflets of the stock are often paler green and not so glossy, and have five to seven leaflets instead of three to five as with many varieties. Never prune before eyes start and some may be frozen back if done too early.

The most pernicious habit is the one which so many enthusiastic gardeners have of pruning everything in the Spring, and not only that, but making the graceful Barberries, Spiræas, and Mock Oranges into formal, stiff shapes, due entirely to cutting their bushes with shoots all the same length.

Many Spiræas and Golden Bells never bloom well, while the Hydrangea blooms perfectly, merely because everyone prunes in the early Spring, not at all the proper time for Golden Bells or Spiræas but exactly proper for Hydrangeas. Spring blooming shrubs must

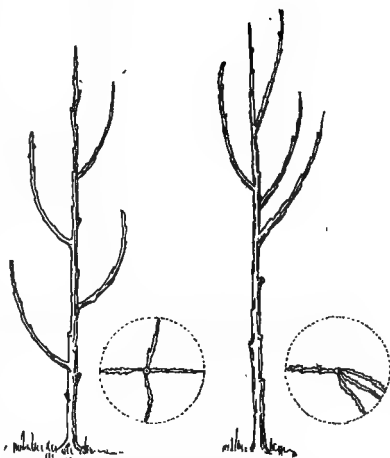

YOUNG TREES PRUNED

One at the left pruned properly, the head started low and branches well distributed. One at right—head too high, branches form a crotch and tree is not balanced

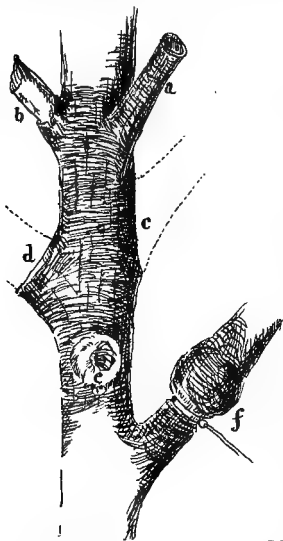

PRUNING A LIMB

a, Branch cut off too long. b, The branch (a) after several years, has died back but cannot heal. c, A branch cut properly. d, A branch which is cut so that a little pocket is left in which water can settle and cause decay. e, A wound healing properly. f, A branch being strangled by a wire-tie

be headed in a trifle after flowering, which will cause the production of flowering wood for another year.

HEDGES. A hedge, in order to give the best light conditions to the lower branches, should be broad at the bottom and narrower at the top. It is best not to be flat on top for snow quickly lodges in this sort of hedge and spreads it so that the true beauty is spoiled. Hedges should be trimmed before growth starts in the Spring and again lightly in late Summer or Fall. The young growth is best kept its proper length before it grows very long, otherwise the cut ends of the branches are large and over conspicuous.

FRUIT TREES. In pruning fruit trees for home grounds there should be an effort to keep them always low headed and open. This means that from the start the branches should be encouraged to grow out from the main trunk. Avoid allowing the branches to start so that a crotch is formed and have them distributed around the tree so that when they bear fruit there will be a natural balance. As the years pass, less pruning is necessary on fruit trees, except to keep the center open so that some light can get in to color the fruit. Dead or crowded branches must be removed. Any appearance of disease is better cut out than any treatment that can be given it. A tree once in good bearing condition seldom needs much pruning.

EVERGREENS need little pruning except to correct any lack of uniformity of growth. Many times in Pines, among the young growths some appear to be away ahead of others; if care is exercised they may be slightly pinched to check growth in that direction. Even if the leader of Spruces or Firs is lost, they seem capable of making a new one. Much can be done by staking and training of evergreens, assisted by pruning. The latter operation may lead to gumming if done carelessly or at an improper time.

<i>Name</i>	<i>How to Prune</i>	<i>When</i>
AKEBIA AMORPHA FRUTESCENS APPLE	Give only a little pruning. Requires pruning each year. For home garden Apple tree heads should be low so that the fruit may be readily picked. Keep the tree open in center by removing all branches which interfere, those which cross or shade each other.	July Jan.-Mar. Feb.-Mar.
AZALEA GHENT and MOLLIS BERBERIS THUNBERGII VULGARIS	Remove old wood. Remove only strongest shoots to retain form.	July July
BLACKBERRIES (See RASPBERRIES)		
CELASTRUS		July
CERASUS, Ornamental		July
CERCIS CANADENSIS		July
JAPONICA, CHERRY, Sour	Need little pruning except to remove branches which are crossed or broken.	Feb.-Mar.
CHERRY, Sweet	Keep head low because they have tendency to grow tall, and also to prevent the damage often caused by sun and wind.	Feb.-Mar.
CHIONANTHUS VIRGINICA	Requires very little pruning.	July
CLEMATIS	Rather vigorous pruning.	Jan.-Mar.
COLUTEA ARBORESCENS		Jan.-Mar.
CRATÆGUS, OXYACANTHA		July
CURRANTS	Canes bear two or three times, cut out few oldest canes each year, otherwise fruit becomes small.	Feb.-Mar. Late Summer
DEUTZIAS	Unless over long do not cut back shoots.	July
DOGWOOD		July
DWARF HORSE CHESTNUT		Jan.-Mar.
ELÆAGNUS LONGIPES	Needs to be looked over each year for removal of old wood and straggling branches.	July

Name	How to Prune	When
EXOCHORDA GRANDIFLORA (See Pearl Bush)	Cut back just after flowering.	
FLOWERING CURRANT (Ribes aureum)	Encourage vigorous young growth. Trim out older wood.	July
FLOWERING PLUM FORSYTHIAS FRINGE TREE (See Chionanthus)	Thin out branches and trim back others immediately after flowering.	July
GOLDEN BELL (See Forsythia)		—
GOLDEN CHAIN (See Laburnum)		
GOOSEBERRIES	Remove oldest shoots annually. In July or Aug. cut back each a bit; it causes more fruit buds to form.	Late Summer
GRAPES	Persons who have inherited tangles of Grape vines should exercise care in pruning the first year. Do not remove too much at the start, otherwise no Grapes will be produced. When possible, all untrained vines should be pruned back to a single eye if the vines are very large, but two eyes may be left if the vines are quite small. When the Grapes have nicely set we seem to think that they are benefited by cutting off the tips of each bearing cane two leaves away from each bunch. The canes usually branch in this case, and they may be cut back a little even then. Should one acquire or have to buy new vines, it is well to have a definite simple system of training. Grapes at planting and the year after should have the vines cut back two to three eyes. Then head back to 20 to 24 in. long. Several systems of training are good. <i>Kieffen System.</i> Good if wind is not too strong; simple. Single trunk is carried to the upper of two wires and two canes are taken out at an eye for each wire. Each year all the canes are removed except a shoot from each; spurs are chosen from the trunk. A vine may carry 40 buds usually. The fruit canes are produced on shoots of previous year's growth. <i>Charlottaqua System.</i> Two short, permanent branches are established at the lower wire; two or three canes are left on each arm and tied up to upper wire; these canes are renewed each year from buds at their base. When arms get too old, new ones are easily established.	Jan.-Mar.
HIBISCUS SYRIACUS (See Rose of Sharon)		
HONEYSUCKLES	The climbers and the bush Honeysuckles, except Spring flowering Standishii and fragrantissima.	Jan.-Mar.
HONEYSUCKLE LONICERA FRAGRANTISSIMA LONICERA STANDISHII		July
HYDRANGEA	Hydrangeas bloom upon wood produced the current season from older wood. They must, therefore, not be cut down wholly to the ground, otherwise they bloom poorly.	Jan.-Mar.
HYDRANGEA PANICULATA	These shrubs should be large because they are old; they should not be allowed to get into a monstrous size when young; their beauty is entirely spoiled by such treatment. If one does not admire the flower stalks, they are best pruned in Nov.	Jan.-Mar.

Name	How to Prune	When
INDIAN CURRANT JAPANESE QUINCES KERRIA JAPONICA KOELREUTERIA PANICULATA LABURNUM VULGARE	Require only that old wood shall be removed. Shorten any straggling shoots after flowering.	Jan.-Mar. July Jan.-Mar. July July
LIGUSTRUMS LILAC	Prune out old wood if specimen flowers are preferred, also prune out all the sprouts from the base.	Jan.-Mar. July.
MAGNOLIAS	Require only that old wood shall be removed. Tar over all scars.	July.
MAHONIA AQUIFOLIA MATRIMONY VINE MOUNTAIN LAUREL	Require only that old wood shall be removed.	July. Jan.-Mar.
NEVIUSA ALABAMENSIS PÆONIA MOUTAN PAVIA (See Dwarf Chestnut)	Requires only that old wood should be removed.	July July



Pruning Raspberry canes

PEACH	The Peach bears on shoots of previous year. The tree must, therefore, never be headed back; whole branches should be removed when pruning. Heading in does cause production of new wood but method advised is better.	Feb.-Mar.
PEAR	Low heads, keeping them open if possible. Keep all branches free from water sprouts.	Feb.-Mar.
PEARL BUSH PHILADELPHUS PLUM	Moderate pruning to remove old branches and new ones if tree becomes overloaded.	July Jan.-Mar. Feb.-Mar.
PRIVET (See Hedges)		July.
PRUNUS Double flowering Almond Dwf. dbl. flowering Almond P. tomentosa P. triloba		Feb.-Mar.
QUINCES	Head very low. Cut back ends of branches. Fruit borne on wood of current season.	Feb.-Mar.
RASPBERRIES, Black	Bear on wood which grew previous year. Remove all shoots except 6-8 in Spring. Head back all long shoots in Summer; this causes them to branch thus bearing more fruit. Cut out all canes which have borne in late Summer.	Spring or late Summer

<i>Name</i>	<i>How to Prune</i>	<i>When</i>
RASPBERRIES, Red	Remove old canes after fruiting. Leave young canes till Spring. Do not head back as with Blackberries, or black Raspberries, suckers start too freely. Early Spring clip back ends of shoots so that canes are 30-36 in. long or do not prune if trained on trellis.	July-Mar.
RED BUD		July
RHODODENDRONS		July.
RHODOTYPOS KERRIOIDES		July
RIBES (See Blackberries and Raspberries)	Remove oldest wood; remove seed pods.	
ROSE OF SHARON		Jan.-Mar.
SNOWBALL (Viburnum Opulus sterilis)	This is naturally a badly shaped shrub; prune to improve form.	July
SNOWBERRY		Jan.-Mar.
SPIRÆA VAN HOUTTEI	Remove old wood; shear off old seed capsules. Cut away half the branches that have bloomed.	July
SPIRÆA THUNBERGII	In north the tips freeze; they need a little Spring pruning. Main pruning after flowering.	July
SPIRÆAS (Summer-blooming)	Thin them out in winter. Cut back shoots that have flowered.	Jan.-Mar.
STAPHYLEA TRIFOLIATA	Require only that old wood shall be removed.	July
TAMARIX	Prune hard back.	Jan.-Mar.
VARNISH TREE (See Koelreuteria)		
VIBURNUM		
WEIGELA (DIERVILLA)	Includes Hoble Bush, Arrowwood, Snowball.	July
WISTARIA	Cut out old wood. Remove seed vessels.	July
WITCH HAZEL		July

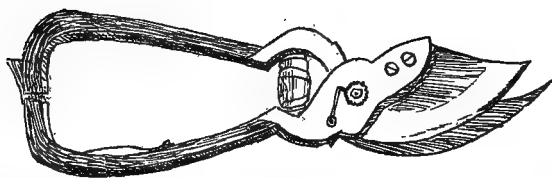

No gardener should be without secateurs, as shown in this drawing. Some professional gardeners prefer a pruning knife as it makes a cleaner cut, especially if the wood or twig is soft and pithy. The secateurs, however, are handy, strong, quick and easy to use.

CHAPTER XVII

Enemies of Plants

WE wish to say just a few words in regard to the enemy. There is such a diversity of little complaints of plants that we prefer not to present elaborate discussions of the way insects and diseases ravage the garden. The main method for controlling these pests is to prevent them by the strictest sanitation. All diseased or insect-infested parts must be burned; such stock must never be planted in your clean garden or allowed to remain there if it has already started. Land which is known to be infested with various pests must be avoided. Standard remedies should be at hand, and sprays applied upon the first signal of trouble. By the way, a method for spraying the plants is essential. Get a good knapsack sprayer if you have a large garden, and if a smaller garden buy one of the sprayers which resemble a squirt gun. Good force is half the battle. Loaded with water alone it will do much to keep the plant lice from getting a first hold. The best sprayer is the one that throws a fine spray the longest distance.

Keep down weeds which harbor diseases and insects. A method which must not be scorned is hand picking when possible. Anything which contributes toward the best culture of the plant will be found a control for the enemies as well. If you have questions as to just how to control any of the various maladies, consult your seedsman, florist, nurseryman or the editor of your favorite garden paper.

INSECTS

Most of the miserable "bugs," so-called, are of two sorts—those which eat the leaves and those which merely puncture the leaf to suck out the juice. The gardener should become more familiar with the ways of the insects, for some are valuable and should be admired. Those who have read Sir John Lubbock, Faber or Maeterlinck realize that the insect world is quite as romantic as our own.

Some of these insects are found on the roots, in which case the plants affected are thought to be diseased. Some of these insects actually chew the roots, while others suck out the sap. The root lice may be controlled by watering the plants with tobacco water. The Cabbage maggot can be prevented by placing a collar of tarred paper about the young plants.

Another lot of insects are borers. They burrow into the stalks, the bark and solid wood of branches, and even the trunks of trees. The fruit trees are especially attacked by these borers. Peaches, Apples, Currants, Gooseberries, Raspberries, Blackberries, Roses, China Asters, Squashes and many other plants are so affected. They must be dug out. Insecticides are hard to apply for any good effect.

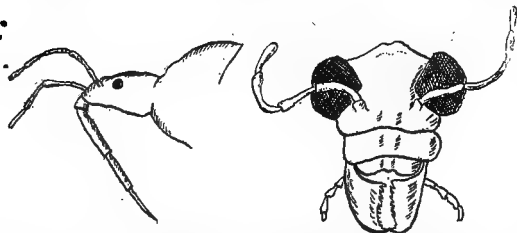

A sucking insect—note the formidable beak, used to pierce plants and extract juices

Head of biting insect—note jaws, large compound eyes, and the feelers near jaws and eyes

Other insects prefer the leaves and buds of plants. This class are the easiest to control. Do not be over worried by insects—merely take the time required for any worry and use it to apply effective insecticides.

As in medical work,

there is no panacea for all ills, but it is not dangerous to make one general sweeping statement about their control. It is this: Sucking insects are seldom poisoned by insecticides; their breathing pores along the sides of their bodies must be touched and filled with the fluid; they are controlled by contact insecticides. Chewing insects greedily eat the leaves which, if covered with a poison, will kill them.

INSECTICIDES. The following are good contact insecticides and are effective against sucking insects such as the various scales, plant lice, blister mite, thrips.

Soap Solutions. A fish oil soap is best, but white soap can be used to make a good spray. Useful for plant lice. Dish water will often keep them nicely in control.

Lime Sulphur. Useful for blister mite, San José and other scales applied when trees are resting.

Emulsions are near solutions of some oil and a soap solution. Good for plant lice and scale insects. Kerosene emulsion consists of: Hard, soft, or whale-oil soap, quarter pound; water, two quarts; kero-

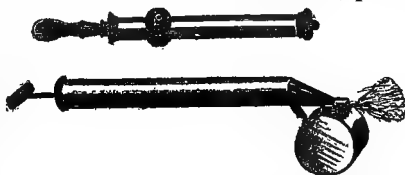

The upper figure shows an ordinary brass garden syringe. Be sure to buy a good article to begin with; it pays. The lower figure shows a brass vaporizing sprayer. This is just what is needed for applying liquid insecticides and fungicides

sene, one gallon. Dissolve soap in hot water while still hot but removed from fire; add kerosene and pump back and forth till it becomes a creamy mass. If made properly the solution will not separate upon cooling. When using, dilute with ten to fifteen parts water.

Tobacco. The various forms of tobacco extracts as a spray or powder, are the most useful against plant lice.

Pyrethrum is the dried and powdered flowers of a certain *Chrysanthemum*, and is useful against thrips and plant lice. As a dust it is applied while foliage is moist.

POISONOUS INSECTICIDES.

Use for chewing insects, slugs, cut-worms, maggots, caterpillars, and most insects called worms. The most used substance for this type of control is arsenic.

Arsenate of Lead. This substance is used at various strengths, depending on the plant affected and the insect working. It is now the most used remedy for caterpillars, slugs, maggots and worms feeding upon the foliage of plants.

Paris Green. Has same use as arsenate of lead, but is not quite so effective.

Hellebore. This is procured as a powder. It is much less poisonous than arsenical insecticides and is very useful upon ripening fruits, especially for the Currant worm. It is applied when dew is on the plants. For worms on Currant and Gooseberry bushes sprinkle slaked lime very lightly.

Slugs and cutworms are easily controlled by distributing a poison bait over the garden or in little piles under the plants. Use wheat bran mixed with a little Paris green or arsenic and some syrup. Mix thoroughly and scatter about just after dark.

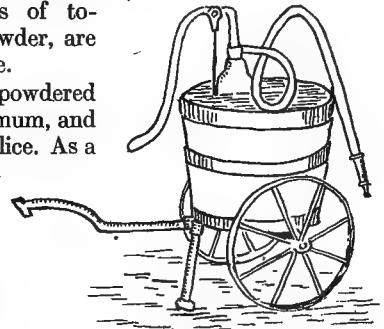

A useful hand-pump spray engine suitable for larger spraying operations

DISEASES

"Whenever the normal functions of plants are interfered with, the plant is diseased," says Dr. Freeman of the University of Minnesota. But many of the garden troubles are not true diseases. Plants become yellow because they are getting too much water or too little or, perhaps, their roots are affected by some insect, or perhaps the soil is too poor or too rich. Real diseases are caused by certain fungi and germs. They affect parts of plants and may be prevented from spreading, but the affected parts cannot be cured.

Most of the substances used against diseases contain sulphur or copper. For diseases on surface, appearing like very fine dust, the best substance to apply is flowers of sulphur. For other sorts of troubles sprays seem better, since they can be distributed more evenly. Bordeaux mixture is the standard substance to use upon perennials just as they come up in the Spring, but as it discolors the foliage, ammoniacal copper carbonate and other substances are used when the plants are in more advanced growth.

Most diseases must be sprayed several times, otherwise the treatment will be ineffective.

The matter of strict sanitation cannot be too often emphasized. To be specific, be sure that mummy fruits do not hang on the trees or lie on the ground; gather all such disease breeding nuisances and put them far away from the fruit trees. Certain of the weeds harbor diseases which are common upon the cultivated plants; such weeds as Mallow should be destroyed, because they harbor Hollyhock rust.

CHAPTER XVIII

Winter Protection

THAT plants or shrubs may withstand the cold, we protect them; but it is mainly to shield them from the Winter sun. Or some plants may be heaved from the soil by frosts; when thoroughly protected such heaving does not take place.

Many of the perennials are benefited by a protection in Winter. The sort of protection perennials need is one which will shield them from Winter and earliest Spring suns, which start the plants into growth only to be frozen again when the sun has set. This alternate freezing and thawing is the main cause of Winter injury to shrubs as well as perennials. The proper protection, then, is a light layer of straw or manure or leaves applied after the tops have been killed by frost.

It is usually better to wait until the ground is a little frozen before applying the Winter mulch. It prevents a premature start in Spring, due to a slight heating caused by fermentation. Perennials which retain their leaves through the Winter, as well as biennials and Sweet William, Heuchera and many others, are best covered with straw or leaves, but not manure, which often disfigures the foliage due to the decay. An excellent method, however, is to cover the beds with evergreen boughs and then place leaves upon these, in which case the leaves are prevented from matting. Leaves which mat together badly, as Elm, Maple, and other trees which crop their foliage early, are not as valuable as Oak. Coverings which are too thick cause a premature start in Spring, resulting in crippled growth because of the late frosts.

Unless the perennials are diseased the tops may remain during the Winter; breaking or cutting them off often exposes the growing points.

For protecting Lilies a mound of ashes, placed over the crown, is frequently advised. The Tiger, the Canada, the Coral, the Handsome, the Thunbergian, and the Turk's Cap can be successfully protected in this manner. We have had occasion before to mention the protection of Eremurus, which consists of using a deep box filled with leaves and left over the plants till rather late in the season, otherwise the young shoots will be injured in the Spring.

Then there are the Roses. When rosarians get together they

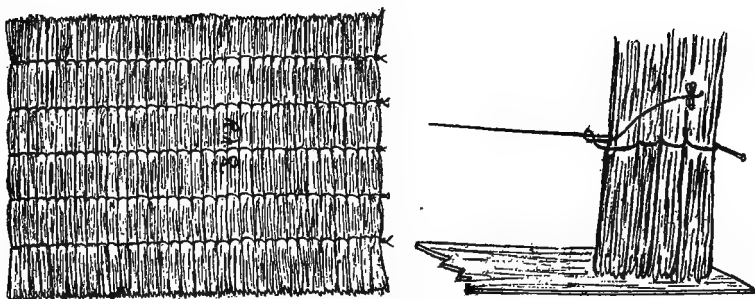

STRAW OR REED MATS

It is a fairly easy matter to manufacture a good, stout reed mat or straw mat for protective purposes. A ball of stout cord and the necessary material for the mat; a little dexterity in binding these into bundles, and in twisting the cord, as shown in the drawing, is all that are necessary. These mats can be put to a dozen good uses

discuss varieties for a time; then the question usually arises: "What do you use for protecting your Roses?" "Well," says one, "I believe that a protection for Roses should be merely a sunshade, not an overcoat, so I just turn a box over the tops of the plants. They always Winter as well that way as any other." "They really need some protection from the cold," says another, "and I think the only way to protect Roses is to mound up all the teas and hybrid teas so that the soil is almost a foot deep all around them." The third gentleman says that the protection afforded by something placed on their stems, such as rye straw, is best, although paper is an excellent insulator against the cold. Climbers are well protected by laying them down and covering them with evergreens or wrapped in burlap. Any sort of frame packed with leaves is a trifle dangerous, for the leaves are apt to ferment and cause the young shoots to start prematurely. Many persons dig their teas each Fall and store in coldframes, which usually keeps them perfectly but is rather troublesome.

For many trees and shrubs a windbreak will be the proper sort of shelter from the drying winds of Winter. Trees are apt to be injured in Winter by the loss of water by evaporation from the twigs; this cannot be supplied by the frozen roots, and the plant dies. Temporary fences may be erected of boards or Corn stalks which will give the required break to the full sweep of the wind. Such protection is placed on the south side of broad-leaved evergreens to shield them from the Winter sun. The branches of either deciduous or evergreen trees should be tied up when the trees are somewhat columnar and are susceptible to breaking by wind or snow. This is especially necessary with Irish Juniper.

Tender plants and newly set trees, evergreens and others, are successfully protected by tying them together and covering with Hemlock boughs. Other trees and shrubs are covered deeply so that the roots do not freeze, in which case many are encouraged to grow under adverse conditions.

It is the alternate freezing and thawing of the trunk and branches of fruit trees that causes them to crack open on the south side. Low heading is the only precaution.

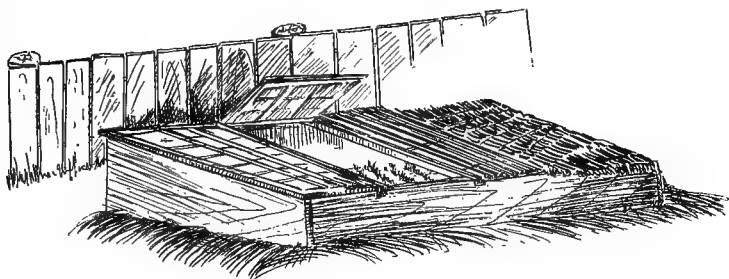

ANOTHER FORM OF WINTER PROTECTION

The ordinary coldframe, especially if covered with mats in hard weather, is sufficient shelter for all that class of plants which are spoken of as "doubtfully hardy." Parsley can be wintered here; Violets can be grown and flowered in deep frames; tender Roses and shrubs for placing out of doors in Summer can find a place.

CHAPTER XIX

Plant Propagation

WHY don't you propagate more of your plants and share your good ones with your neighbor? Nothing is more interesting than to get a slip from a neighbor. Plants of this sort carry with them memories of your friend which add to the charm of the plant itself. By doing so you will add to the number of garden lovers.

HARDWOOD CUTTINGS. People are afraid to cut up plants. They wish they had a whole hedge of a certain shrub instead of one plant. If that is true in your case, do this: In the Fall, cut up in six-inch lengths the good, strong, whip-like branches of such plants as Privet and Hydrangeas; tie them in bundles and either bury them in a sandy knoll, or place them in a box of sandy soil in the basement. Absolutely cover them. Water them occasionally. By Springtime the wood will have healed over a bit at the base and the cuttings should then

be placed in a well prepared soil so that only two buds are above ground. Climbing Roses, Grapes, Currants, Golden Bell, Spiræas, Lilacs, Willows, Mock Orange, Dogwoods and Deutzias are quite easily propagated in this manner. Note the illustration; it shows how wood should not be left above the top bud, and how the base of cuttings should be cut clean just below a bud or buds. If the leaves are on the plant, cut them all off.

SOFT-WOODED CUTTINGS. You can easily multiply your shrubs and even Roses during the Summer if you will make slips, and be sure to get them short.

Three inches is long enough. The slip should have a few leaves at top; the others should be removed. This type of cutting is called a soft-wooded cutting. Cuttings have no roots, no method of taking up food from the soil so that food stored in the stem and leaves which should produce roots is lost by evaporation if too much foliage remains on the cutting; if the leaves are



A hardwood
(Currant) cutting



A soft wood (Chrysanthemum) cutting. Such cutting may be 3 in. long —the best size

large they are often trimmed smaller. The cuttings, when made, should be placed in a box of sand or directly in the soil if it is sandy. Put the cuttings in rather deeply and firm them in very solidly. If there is a large glass jar or bell-glass handy, use it to cover those plants which you usually think are a little more difficult to root, such as Roses. But all cuttings, whether covered with glass or not, should have a shading. A good place for the cuttings is under the Grape vines where it is shady. Water them thoroughly. Don't leave too many leaves on a cutting; firm them in

sand solidly, surely shade, and carefully water. Cuttings of any sort should not be placed right where they are to grow.

MAKING CUTTINGS OF PERENNIALS. This sort of cutting can be made of hundreds of perennials. If you wish to increase your stock, merely take little slips in the Spring when the plants are six or seven inches tall. Be



Dahlia root, showing young shoots starting and where to cut apart (c)

sure to leave a few buds below where the cutting is taken; it will not injure the plants in the least, but will cause them to become branchy. Choose wood that is a little ripened.

Perennials which are readily propagated by cuttings:

Arabis
Asclepias
Cerastium
Chrysanthemum
Clematis

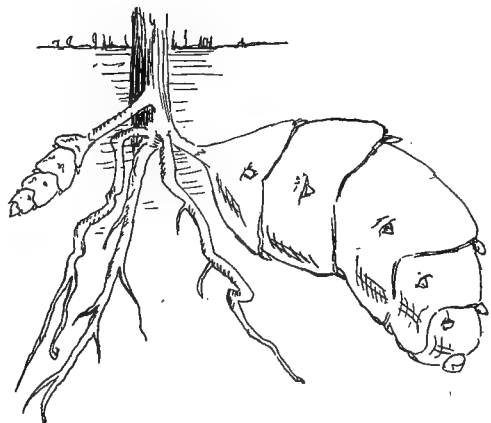

Jerusalem Artichoke tuber. Note the eyes; unlike those of the Dahlia they are on the tuber itself

Dahlia	Hollyhock	Lotus
Eupatorium	Iberis	Perennial Sun- flower
Helenium	Larkspur	Phlox
Hesperis	Lobelia	Pink
Heuchera	Loosestrife	Potentilla

LEAF CUTTINGS. There are yet two more sorts of cuttings—leaf cuttings and root cuttings. Leaf cuttings are rarely made in the garden, but perhaps a friend has given the reader a slip of a Rex Begonia. Remember to remove all but one leaf and oftentimes that leaf needs shortening. The leaves removed can be cut up in small pieces so that each piece has a portion of the heavy midrib at the base. When inserted in sand several inches deep in a warm greenhouse, the base will root and a young plant starts.

ROOT CUTTINGS are interesting to make. Plants with rather thick roots can usually be propagated by this method. A box will be necessary for such propagation; it should be about three inches deep and nearly filled with a light loam. The roots are cut into pieces an inch and a half long, and are scattered over the surface of the soil and covered about one-half inch deep with light soil. The box should then be placed in shade, watered and covered with a paper. In a short time shoots will start and the young plant can be transplanted to another location. The following plants can be propagated by this method: Polygonum, Euphorbia, Plumbago Larpentæ, Saponaria, Coronilla varia, Achillea, Japanese Anemone.

There are a number of perennials propagated by this method which succeed better when the roots are planted perpendicularly with a little piece of the end protruding. They are usually fleshy rooted sorts. Among the plants are: Italian Borage (*Anchusa*), Plume Poppy (*Bocconia cordata*), Dodecatheon, Stokes' Aster (*Stokesia cyanea*), Bee Balm (*Monarda*), perennial Phlox, Gaillardia, Gypsophila, *Helianthus rigidus*, Thermopsis, Papaver, Statice, Bleeding Heart, Peony. Lily of the Valley is increased by separating the pips or individual crowns. Among the vegetables, Horseradish is so propagated. Scotch and Moss Roses, Calycanthus, Lilacs and Blackberries may all be propagated in this way.

DIVISION OF PERENNIALS. Perhaps the commonest method of propagation of perennials and the one which is easiest, is the division of the clumps, the main crowns being cut into a number of pieces. The plants should be divided very early in Spring before growth starts, or late in the Fall. This is the most used method of propagating Iris, Peonies and Phlox. German Iris should be so divided every three, Phlox every four, and Peonies every six or seven years, while Michaelmas Daisy, Achillea Ptarmica and millefolium roseum,

Helianthus, Sedum, some Veronicas, Chrysanthemums, Enothera, and all perennials which sucker badly should be moved and divided every year. Artemisia, Boltonia, Campanula, Geum, Funkia, Doronicum, Armeria, Thalictrum are all propagated by division.

SOWING PERENNIAL-AND ANNUAL SEEDS. If we possess coldframes and hotbeds we can sow many of the perennials in March and get them to bloom the same year. We can sow annuals also and have them of excellent size for setting in open ground. We may also sow perennials and annuals out of doors, in which case some will bloom the first year, but with others a longer time will be required.

The following are a few of the perennials which will bloom the first year from seed: Gaillardia, Iceland Poppy, Chinese Larkspur (*Delphinium chinense*), Lychnis, Shasta Daisy, Platycodon.

On the other hand, there are many perennials which wait a year before flowering, namely: Cardinal Flower, Golden Alyssum, Campanula, Aquilegia (Columbine), Foxglove, Loosestrife, Physostegia, Hollyhock, Sweet Rocket.

The main advantage of growing perennials and annuals from seed is that it saves the great cost of buying plants, which runs up pretty high when quantities of plants must be bought from nurseries. Many of the best varieties do not come true to seed, however, for seedlings often vary in color and habit. This is true especially of highly bred plants, hybrids which have resulted from the incorporation of several species.

SEED SOWING: VEGETABLES. The hotbed or coldframe is more essential for the vegetable garden than it is for the flower, since we can get the crops so much earlier. Everything is tender and as it seems out of season tastes so good that all the pains of regulating the hotbed are worth while. Lettuce can be matured in such structures, and Tomatoes, Egg-plants, Beets, Onions, Muskmelons, and even Corn can be started. The space is valuable, so that careful planning is necessary to utilize every bit in the hotbed. (Hotbeds are discussed on page 222). Many persons will not have hotbeds, but will need to depend upon the windows for their early start.

SEEDS OF FLOWERS SOWN INDOORS. There is always a danger in advising a very early start for sowing seeds indoors for the reason that the plants are apt to become very spindly owing to the diminished light most of us can supply plants in our houses. For the early Spring sowing we shall need to save the soil in the cellar. It should not be too rich but should be loose, made so by the addition of sand, coal ashes, or leafmold. It should be in a fine condition. Small, shallow boxes, three inches deep, are best for seed sowing. The bottom should have a number of cracks and should be covered with some coarse

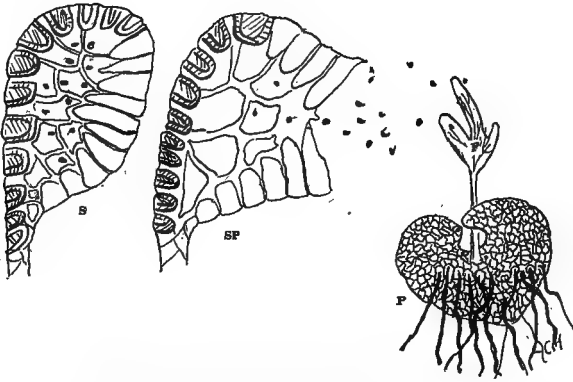

S.—Unripe spore case of a fern (greatly magnified)
 Sp.—The spore case burst and throwing its spores
 P.—The green growth that comes from a spore and which give rise to the little fern plant (f)



1.—Fern plant bearing a frond. Each division of the frond is called a pinnule (plural, pinnæ) (P). This frond is covered with dot-like masses which are the spore cases (Sp). At the base of the plant is a young frond (c) growing from the root stock (r)
 2.—Pinnule of *Dryopteris*. 3.—Pinnæ of *Adiantum*
 4.—In certain ferns the leaflets or pinnæ that bear spore cases are much changed, as for example in *Osmunda regalis*, the Royal Fern

drainage material, as broken crockery, sod or stones. The flats should be filled even full, then trenches should be made, the depth varying according to the sort of seeds that are to be sown. A depth equal to twice the diameter of the seed is all that is necessary indoors. The reader is referred to the Garden Calendar (page 241) for the proper time to sow each vegetable or flower. The seed may be sown thinly, so that each seedling will have plenty of air and space. When sown the seed should be covered and the soil firmed by the use of a board. After watering carefully with a fine spray, the box should be covered with glass and a newspaper, and put in a suitable place for growth. Just as soon as the seeds have germinated the shading of paper should be removed so that the plantlets may get the full light.

SOWING SHRUB AND TREE SEEDS. When the fruits of many of the trees and shrubs, as Regel's Privet, Hawthorns, Rhodotypos, Roses, Barberries, Boston Ivy, Euonymus, Viburnums, are thoroughly ripe they should be gathered and so placed that the mass of berries will ferment a little. The pulp of the fruit can then be washed from the seeds. Boxes should then be procured in which a layer of sand is placed; the seeds are sown broadcast and covered by at least an inch of sand. The flats are watered thoroughly and placed in the basement until February, when they are taken out of doors and allowed to freeze. This is necessary to break their heavy coverings. The following shrubs should be so treated: Barberry, Sweet Shrub, New Jersey Tea, Snowdrop Tree, Shadbush, Privet, Honeysuckle, Styrax, Snowberry, Indian Currant, Hawthorn and the Viburnums. When the ground is in condition for planting, sift the seeds from the sand and sow in rows. They should then start rather readily.

Tree seeds are treated the same as those of shrubs. Seeds which, though hard, will not stand freezing are often filed or nicked with a knife. The following tree seeds need to be placed in sand and frozen: Maples, Ailantus, Birch, Catalpa, Chestnut, Beech, Ash, Hickory, Butternut, Black Walnut, Locust, Basswood. A number of tree and shrub seeds should be sown immediately after ripening. The principal ones are: **TREES**—Birch, Chestnut, Elm, Hackberry, Horse Chestnut, Magnolia, Maple, Oak, Poplar, Ptelia, Sweet Gum. **SHRUBS**—Bayberry, Honeysuckle, Nemopantes, Rose, Spiræa.

Seeds differ greatly in their germinating power. The White Oak germinates quickly, the Black Oak slowly. The Ash seed is rather oily and benefits by being treated to a weak acid bath.

There are a number of reasons why seeds fail to germinate. They may have been immature when gathered. Pansy seed matures so that some of the seeds are ripe while others are not. Some seeds,

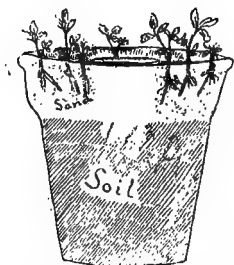

Flower pot filled with soil and sand, the sand at the top. Soft wooded cuttings root most readily if placed around the edges of the pot. Seedlings transplanted may be placed similarly

upon becoming too dry, are killed. Seeds have often been stored while moist and heating has resulted which killed the vital germ of growth; while still others have been injured by insects and fungi before or after maturing.

GRAFTING. Trees which belong to the same variety or species may be grafted. In other words, a Baldwin Apple may be grafted upon a Baldwin or any other Apple. Sometimes plants of different species but of the same genus may be grafted; other times this is not true. Apples may not usually be grafted upon Pears; yet Quinces (of the genus *Cydonia*) have Pears (*Pyrus*) grafted upon them to impart the dwarf habit. We

could never expect Cherries on Pear trees, or red Raspberries on Grape vines, for it is only those plants which are very closely related that will allow grafting.

We have seen, as in the above case, that Pears may be kept dwarf

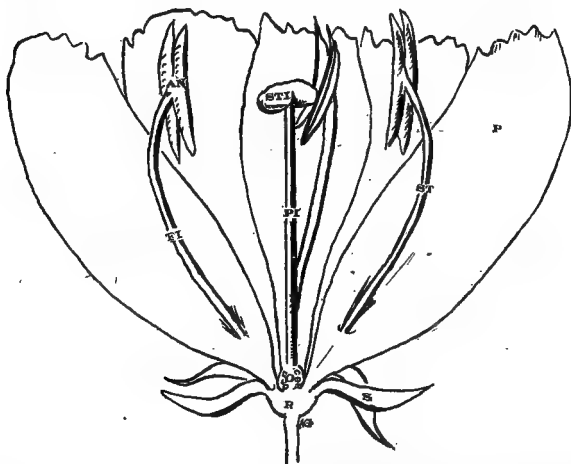

Section of a typical Flower: p—Petal: The petals taken together are called the corolla. s—Sepal: Sepals taken together are called the calyx. st—Stamen: The male part of plant. fi—The filament or thread-like part of stamen. an—The filament or pollen producing part of stamen. pi—Pistil or female part of flower. sti—the stigma or part receiving the pollen. o—the ovary which bears the seeds. r—Receptacle, often helps to make up the fruit

by working them upon the Quince stock. We may, likewise, increase the vigor of a variety by grafting it upon a stronger growing species. A familiar example of this is the grafting of certain Roses upon the Manetti Rose. Many times plants are grafted in order to render them more adaptable to adverse soils and climates. An example here is found in the case of Apples which are often grafted upon the Siberian Crab in order to render them better able to withstand intense-

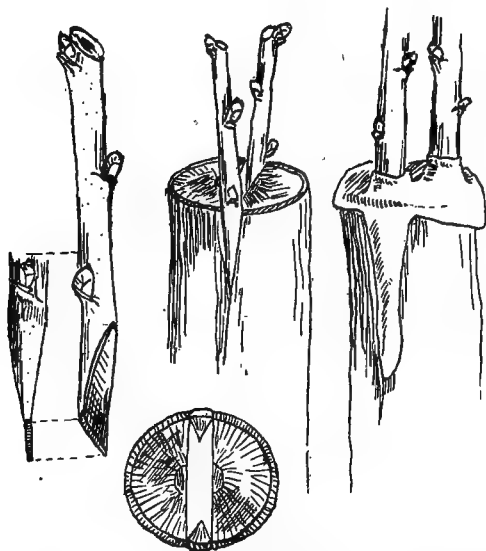

CLEFT GRAFTING

The methods of grafting are explained in the text on the next page. The above illustration shows in detail how cleft grafting is performed—usually on large Apple and Pear trees. On the left are the clons with tapering cut; on the right, the branches cleft or opened, also showing the waxing over. Below is a section through the top of the stock

ly cold climates. Sometimes double grafting has to be practised, especially with fine Pears, but that is a part of the subject we need not enter upon here.

Girdled trees may be grafted with a bridge graft. In most cases, however, the process of grafting is used to simply multiply the variety. Baldwin Apples are wanted; they do not come true to seed; cuttings are slower; so that some form of grafting is used.

When only a bud, instead of part of a shoot, is transferred, the process is called "budding." (See below.)

There is a fundamental necessity in all grafting work: The layer just between the wood and bark, the line where the bark peels, of both stock and cion, must be in contact. The *stock* is the plant grafted upon; the *cion* (also spelled scion) is the shoot or graft that is inserted.

BUDDING. The simplest method of budding is known as shield budding. It consists of placing a shield-shaped piece of bark bearing a bud, beneath the bark of the stock. A good, healthy, well budded branch is chosen; the buds are cut from it, holding the branch upside down. A T-shaped cut is made in the stock near the base of the plant; the free edges are carefully peeled back and the bud inserted as shown in the cut. The budded stock is then tied with yarn or raffia so that the bud is held firmly; all should be covered except the bud. Budding may be employed whenever the bark peels nicely.

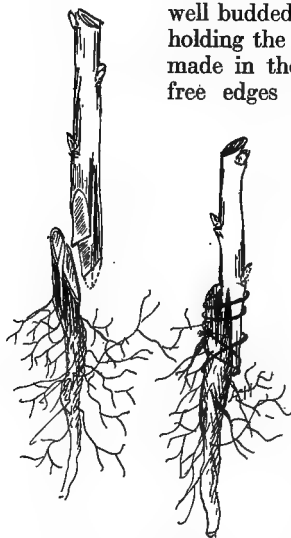

Tongue-grafting

In grafting the stock and cion must be firmly bound around with broad raffia or other ligature. The above drawing is intended to show how to fix the graft, but the binding must cover the union thoroughly to exclude the air

Prof. U. P. Hedrick, the expert horticulturist of the Geneva Experiment Station, gives the following dates for budding: Rose, July 1 to 10; Pear, July 10 to 15; Apple, July 15 to Aug. 1; Plum (St. Julian stock), July 15 to Aug. 1; Plum (Myrobalan stock), Aug. 15 to Sept. 1; Cherry (Mazzard), July 20 to Aug. 1; Cherry (Mahaleb), Aug. 20 to Sept. 1; Quince, July 25 to Aug. 15; Peach, Aug. 20 to Sept. 10.

CION GRAFTING. There are a number of very simple sorts of cion grafting. The method most used upon trees in which the stock is over one inch in diameter is called cleft grafting. The branch of the stock which is to be grafted is cut off short. It is split through

the center and the crack opened to receive a short cion. The cions are best cut during the Fall and stored through the Winter in moist sand, but they may be taken directly from the trees very early when the sap starts in the Spring but before the buds have burst. The best length is three buds long, the top bud being the top of the cion; the lower end is beveled at each side to form a perfect wedge as shown

in the cut. This wedge must have the cut surfaces perfectly straight, not hollowed out, if the union is to be a good one. In inserting the cion two cambium rings must be together; this is the part between the bark and the wood. To be sure of this, slant the cion just a trifle.

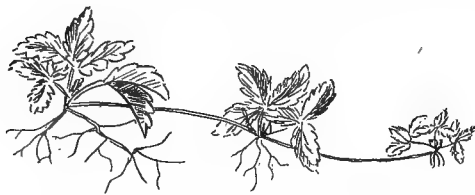

Strawberry runner, showing young plants rooted

Then cover over the whole cut area with grafting wax.

The next most common method of grafting is known as whip-grafting. It is especially used upon small branches or for grafting seedlings.

Apple seedlings may be nicely grafted by this method. Branches to be grafted must be nearly the same size. The stock should be beveled off with a long plane surface; the cion should be beveled the same way. Then each should be split so that the two tongues fit together nicely. Practise a bit upon some other wood and you will learn more by the experience than words can tell in description. As in all grafting, the layer between the bark and wood of each must be in contact on one side at least. This sort of grafting, like the former, should be done in Spring before growth starts. This graft may not be covered with wax, but merely tied firmly. A cord used for this purpose is usually No. 18 knitting cotton soaked in grafting wax. This is just strong enough to break when it should, before the branch is strangled.

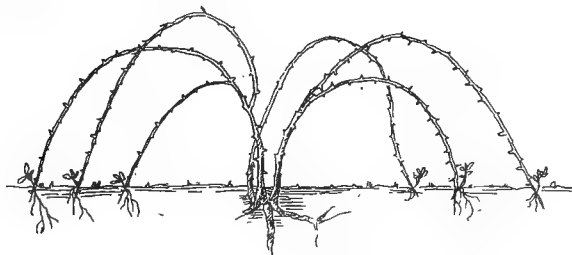

Method of tip-layering of Raspberry and Blackberry

LAYERS. By layers we mean that some portion of a branch has been placed in contact with the soil so that it may root. Many plants root very readily by this method, and as it is very convenient, perfectly simple and certain, it can be used in every garden for some

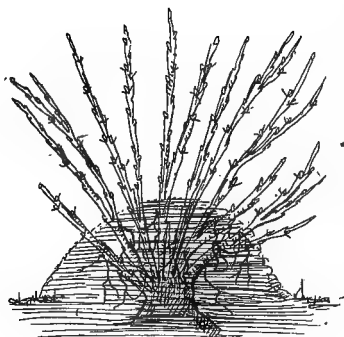

Mound layering of Gooseberries. Observe the roots forming

purpose. Grapes can easily be propagated by this method. A cane is merely bent down and a node or two covered with soil. They root readily and the new plant can soon be separated from the old one.

Another type of layering is that by which a bush is mounded so that each shoot roots, making from five to twenty-five young plants instead of one. After they are well rooted the plant can be divided and each part will be a separate plant. Gooseberries and many ornamental shrubs can be mound-layered. Strawberries are propagated by runners; each little runner makes roots and forms a new plant. If one continues to keep the rows between the Strawberries clear except for the plants wanted another year, the crop can be nicely renewed. The old plants are pulled and the new ones transplanted into place in a new row. Raspberries are propagated by bending down their tips and covering with soil. The tips root and the little new plants resulting may be transplanted. A sort of layering goes on naturally with many plants. Tomato stems root nicely when they touch the soil. Squash may be encouraged to root at several places by covering the eyes or where the leaf arises from the stem

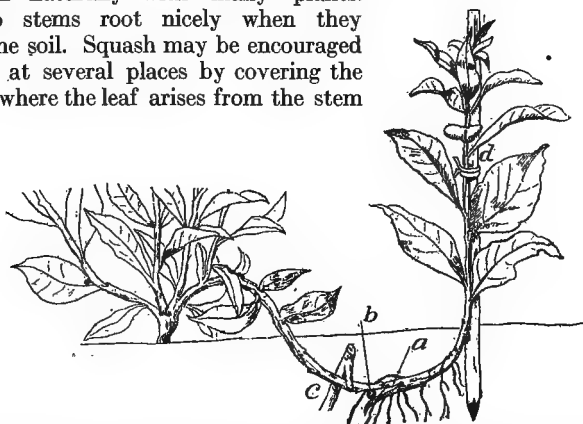

Method of layering a woody or half-woody plant, as for instance, a Rhododendron or a Carnation. a, Slit or tongue cut half way through the stem; b, pebble to keep slit open; c, peg for holding down the layer; d, a stake to keep the shoot firm

CHAPTER XX

Window Boxes and Porch Plants

THERE are many enthusiastic gardeners for whom the force of circumstances rules that the window or porch garden is their only form of flower growing possibility. To others the porch decoration has much to do with the whole appearance of the house. One word before we mention kinds of plants and boxes to use.

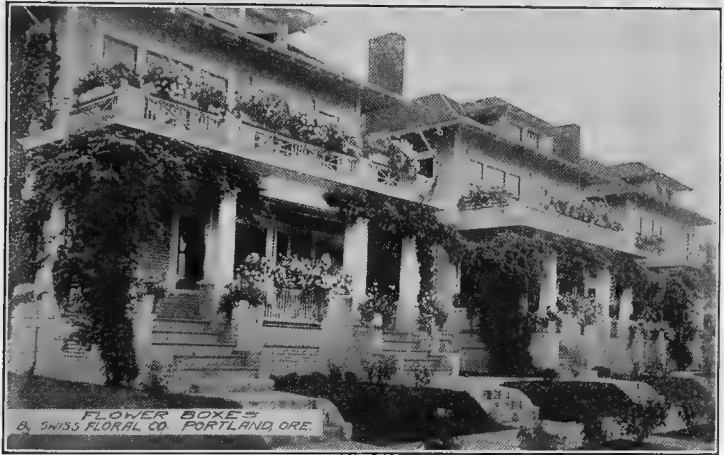

A gay scene at Portland, Oregon. The boxes are filled chiefly with Petunias

Many persons of exceptionally good taste in their home and garden seem to think that a discarded water tank for a receptacle, and a straggly display of hideous colors are the requirements for a porch garden such as we are to consider. This is not true. The container for the flowers should be of the same color as the house, or else of a harmonious shade. The plants should be thickly set in the box and, contrary to most common usage, the colors should be an excellent contrast or a perfect harmony.

The porch box should rarely be deeper than nine inches, from nine to twelve inches wide, and of any length. It will be much easier to handle a box not longer than three feet. It is suggested,

therefore, that a number of boxes be used if the area to be decorated is longer. The boxes should always be made rather solidly. Often they can be bracketed to the porch; when this is not possible some simple standard can be devised. If legs are placed on the box they should be a trifle wider apart at the floor. Round urns or hanging baskets are preferable to most boxes which must stand on the porch.

Self-watering boxes made of iron are on the market. There is a small reservoir for water at the base; sponges communicate the water to the soil. The boxes need watering only every week or ten days. They cost from \$1.50 to \$4, according to their size and amount of ornament. Care must be taken that drainage is good and the reservoirs are not filled too full of water.

Porch boxes or hanging baskets are easily made. White Pine, red cedar or cypress are the best woods. They are less injured by the continual moisture required in a box of this sort. When finished

they may simply be painted to match the house or they may be covered with cedar or other bark. They may be slightly decorated by using crosspieces of fine twigs.

Excellent hanging baskets are made from the heavy ox-muzzles. Bend the muzzle so that it is flatter and more basket shaped, attach three wires or chains, and the hanging basket is ready for use after lining with pieces of moss so that soil may be retained. The same type of wire basket may also be purchased. Special hangers may be bought which can be attached



Green lattice-work against a white house, with the Geraniums and Scarlet Sage. This makes all the difference between elegance and bareness

to the ordinary flower pot, converting it into a hanging basket. They are useful for specimen ferns or trailing plants.

Concrete boxes or urns are very heavy but are good, the main difficulty being that very simple designs are essential, otherwise the boxes appear very clumsy. If very fine sand is used, or when given a fine finish, they are very attractive.

For either indoors or outside, the wicker window boxes present a good appearance. They are excellent filled with Boston ferns and cost from \$3 to \$13, according to height and length. Excellent

long plant baskets are now offered for sale by all florists which are very handy to place upon the window sill. For the indoor window garden receptacles made of plaster of Paris are rather pretty, but are very easily chipped and broken and are not to be advised.



Concrete window box as an integral part of the building; in this case a garage

Plants for Window Boxes

For Shady Situations

Tuberous Begonias
 Begonia semperflorens
 Fuchsias
 Cobæa scandens
 Vinca
 Foliage Geraniums
 Crotons
 Funkia variegata
 Ferns
 Palms
 English Ivy
 Trailing Euonymus
 Wandering Jew

For Winter Effect

Box (Buxus)
 Dwarf Thuya
 Dwarf Retinispora
 Irish Juniper
 Hemlock, Small plants
 White Pine, Small plants
 English Ivy
 Trailing Euonymus

For Sunny Situations

Geraniums, tall
 Ivy Geranium
 Petunia
 Ageratum Houstonianum

For Sunny Situations

Cobæa scandens
 Phlox Drummondii
 Nasturtiums
 Verbena
 Lobelia erinus
 Coleus
 Lantana
 Cigar Plants (Cuphea)
 German Ivy or Wandering
 Jew
 Portulaca
 Mesembryanthemum
 Sweet Alyssum

Excellent boxes are made up entirely of Geraniums, the tall varieties for the background and a row of the Ivy Geraniums for the front. Nothing is more effective than a box composed of two pinks nearly the same in color. Fuchsias can be used likewise in combinations of several varieties.

Dracæna indivisa is always useful in the porch box. When its usefulness in the box is over it may be potted and kept all Winter.



Entrance porch and window box. *Ampelopsis Veitchii* is well and freely used

The excellent clear colors of Verbenas are always admirable when used alone or in combination. They flower profusely and continue fresh in appearance.

The *Nasturtium* is incomparable for filling urns or for porch decoration. For a northern exposure the tuberous *Begonia* is excellent. The colors of the single as well as the double varieties are very effective. They should always have the best soil available.

The best Ivy for trailing over the edge and extending downward for five or six feet is the German. If this has grown into quite a jungle when procured from the florist, cut it back and let it start out gracefully. *Vinca* or Periwinkle, a variegated green and white vine of exceeding long growth, is everybody's favorite. It stands adverse

conditions. *Cobæa scandens* will trail down or climb up. Creeping Jennie (*Lysimachia nummularia*) succeeds admirably in shade and, furthermore, in some sections of the country it can be gathered from the wild. Kenilworth Ivy (*Linaria cymbalaria*), a neat, nearly hardy, lavender-flowered trailer, can be tried, also *Asparagus Sprengeri*, a plant so popular with the florist and very useful in the window box.

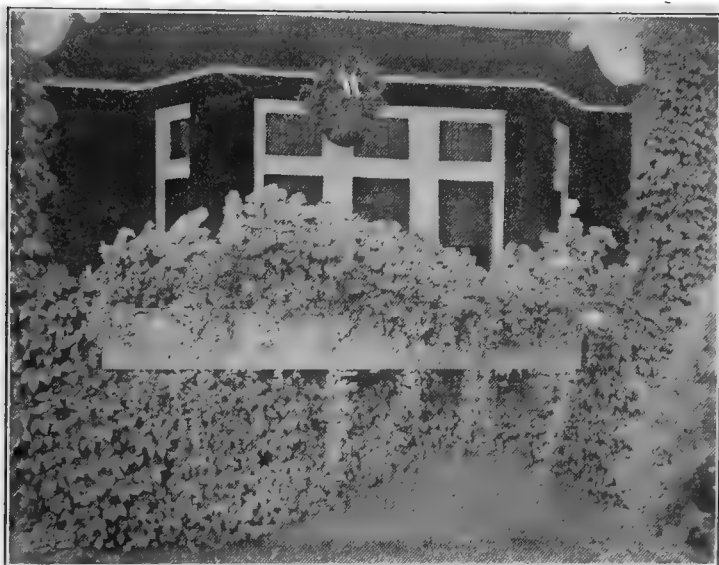

Nothing better bespeaks home joys, grace and comforts than a well-filled window box

Trailing plants of less rampant growth are: *Lobelia erinus* (not the compacta variety); the flowering habit is unexcelled. Another blue is the *Ageratum*, which, like *Lobelia*, is always in bloom, and it is fragrant. The trailing varieties of *Coleus* have a good habit, but the colors are much mixed. *Verbenas* and *Petunias*, are useful by themselves as well as the front margin of the box.

A little plant useful for the more personal porch boxes is the *Forgetmenot*. It is not very permanent but will bloom when many of the other plants have only started growth. When it finishes it may be dug up. The remaining plants will, no doubt, keep up the foliage and flower effect.

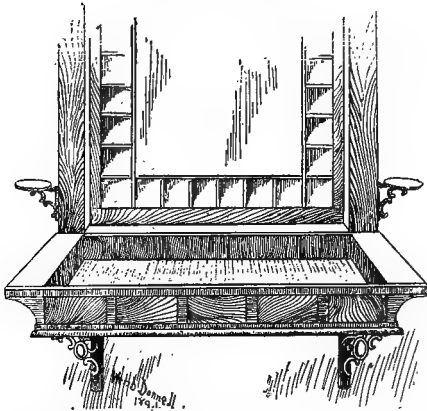

Paneled and benched window box showing bracket supports, also side brackets above, for plants

For the green and more formal window box, plants of Aucubas can be procured from the florist. In Winter the plants are useful on enclosed porches.



SELF-WATERING WINDOW BOX

This shows body of box, false bottom. (B) Above water chamber or reservoir. (W) and two sponges (S) by which the water passes up to the soil. The water supply is replenished through a tube in the right-hand back corner (T).

All boxes should be raised a little above the base or sill on which they rest, otherwise both box and sill quickly rot. The self-watering type prevents dripping, but even they require looking after on hot days, especially when in sunny positions.

CHAPTER XXI

Greenhouses, Hotbeds and Frames

IF we but appreciated a greenhouse at its true value, and knew the pleasure as well as the profit that can be derived from the possession of even a small one, there would be many more erected. It is a standing wonder that in a country so wealthy as ours there should be so few greenhouses attached to the residences of suburban and rural homes. Nor can we help noticing that hundreds of dollars will be spent readily on automobiles by even the moderately well-to-do, while the quieter joys of the garden and greenhouse are overlooked. Yet a greenhouse of moderate dimensions, 12ft. long by 8ft. wide, can be had for \$250, and its upkeep will be nothing like so much as for an automobile.

So confident are we as to the pleasure derivable from the greenhouse, especially in the cold Winter months and in the Spring time before the ground is warm and dry out of doors, that we most heartily urge its consideration on the readers of *THE GARDEN GUIDE*.

We merely wish to call attention in this place to the advantages of such a house. A succession of flowers can be had during the Winter at small cost, either by lifting the Geraniums from out-of-doors in the Autumn and potting them up, as well as Salvias and some other Summer flowering plants, or by sowing little batches of seeds, or planting bulbs and bringing these on gradually. We all know how difficult it is to make a success of Dutch bulbs in the ordinary dwelling house, owing to the dryness of the atmosphere and the fluctuation of temperatures. In a greenhouse these conditions can be regulated to suit the plants.

Among other subjects that can be grown are Chrysanthemums, Ferns, Azaleas, Forgetmenots, Palms, Primroses, Cyclamen, Schizanthus (sometimes called Poor Man's Orchid), Pansies, Sweet Alyssum, and a great variety of other stock. One can frequently obtain a slip or a seedling from a friend, and in this way enrich one's little collection. There are many plants also that can be raised from seed.

Little cultural reminders are published in the seed catalogs, or as a cultural guide Oliver's "Plant Culture" is recommended.

There are many hardy plants that are usually grown in the rock garden that can be placed in what are called flower pans, that is, receptacles as wide as a 5-in., 6-in., or 7-in. pot, but only 3-in. or 4-in.

deep—and which can be brought into flower in February, March, and April in a greenhouse that has no higher temperature than 50 degrees.

Hitchings, the well-known greenhouse builders, make a house of the size mentioned, ready to be screwed together for the sum already stated, namely, \$250. This is made of the best air-dried Cypress, with iron fixtures, bracers, ventilating push rods, galvanized hinges and everything complete, including six heavy iron posts for the support of the house. The glass is of the best double thick A quality, 10-in. wide. The sides are made in two panel sections, each 6ft. long and 4ft. 8½-in. high. There are two benches 11ft. 8-in. long, by 2ft. 7-in. wide, allowing for a walk of 2ft. 4-in. between. Altogether one has an indoor garden of nearly 65 sq. ft., and this includes also the little heating boiler, or in Southern parts of the country where a very little frost is experienced, no heating apparatus may be necessary, and the cost would be reduced by \$75.

Of course, more elaborate greenhouses with cement or brick foundation, and of iron framework with curved eaved glass or in other shapes to suit the architecture of the residence, can be erected, but would run to considerably more money.



A curvilinear roofed, lean-to conservatory by Hitchings & Co., with substantial brick foundation

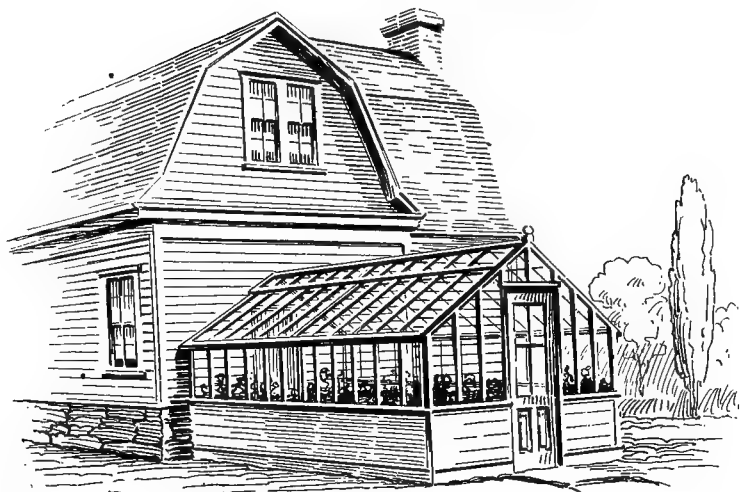

One of Hitchings' small greenhouses, 10ft. by 17ft., suitable for so many moderate-sized suburban places

The greenhouse builders are always willing to give advice, or to estimate for the erection of a greenhouse, and it would be well to consult them whenever a building is contemplated.

The best results are usually obtained from span-roofed houses running east and west, although any light position is satisfactory. The site should not be on wet or low ground, nor any very greatly exposed place, and the span-roofed type is generally preferred, although lean-tos or three-quarter span houses with the long slope to the south, are also excellent.

Some of the most beautiful, and we would say comfortable, conservatories we have seen were attached to the drawing room, or led into from the drawing room, thus making a light, beautiful lounge or extra drawing room. A billiard room can be built also in contiguity, and if the conservatory is large enough, aviaries, and aquaria for fancy fish, may be provided.

In other instances we have seen the conservatory set a little way out from the house, and connected with the latter by means of a glass corridor. Very beautiful results can be attained by planting vines and training them under the roof glass.

It should be mentioned that many of these greenhouses can be used for the growing of Tomato or Melon crops, or for the raising of early vegetables in the Spring if that is thought desirable.

HEATING.—Amateurs' small greenhouses, such as the portable houses, 8 ft. 3 in. wide and 12 ft. to 20 ft. long, are invariably heated by hot water. The boiler is what is known as a Junior, and is usually placed in a cellar or put at one end of the house. Coils of 2-in pipe are placed under each of the side benches, and these coils are connected to the boiler. There is a small open expansion tank at the end of the coils to fill the apparatus with water and take care of the expansion of the water in the system. The amount of radiation in the coils is generally proportioned for a temperature of 60 deg. at night when the mercury



This exemplifies the beauty and value of a few choice, neat growing evergreens close to the house. Dwarf evergreens are also used for filling the window boxes. The sun parlor might well have been converted into a conservatory, or one could have been attached

outside is at zero. The boiler is a very compact and efficient heater and requires no more attention than an ordinary kitchen stove.

A greenhouse 18ft. x 25ft. has usually three benches, (two side benches and one center bench) and is heated by coils of pipes placed under the side benches only, leaving the space under centre bench free so that bulbs or roots of various kind can be stored there. Hot water is invariably used for heating, as the boiler requires a great deal less attention and a more even temperature can be maintained than if steam is used. The usual temperature is 55 to 60 deg. but the coils are arranged and valved so that the temperature can be controlled.

A small, round, hot-water boiler is used for heating the coils. The boiler is arranged with a shaking and dumping grate. When the heating apparatus is filled with water and the fire started, the water circulates through the pipes and maintains the required temperature. The entire heating apparatus is simplicity itself; a child could take care of it.

When the greenhouse is 18 ft. wide and 50 ft. long, a partition can be placed in the center, making two compartments, and different



The "King Junior" garden frame made by the King Construction Co., a sort of miniature greenhouse, the top being on hinges. Being glazed on the sides as well as top the plants are afforded every possible bit of sunlight

temperatures can be maintained in each if desired. The compartment nearest to the boiler is usually heated to a higher temperature. If Roses are to be grown in the warmest compartment, it is customary to place heating pipes under both side and center benches for bottom heat, and to dry out the benches. The heating pipes are so arranged and valved in both compartments that the temperature can be controlled as desired. For heating a greenhouse 18 ft. x 50 ft., a small square sectional water boiler is used. There are no steam gauges or complicated fixtures required on a hot water heating apparatus.

FRAMES AND THEIR USES

The garden without its quota of frames is like an automobile without tires; you may run it, but it is hard and slow work to get anywhere with it. Frames, properly managed, will accelerate and supplement the garden throughout the year. The frames (which you can build yourself with little trouble if you do not care to buy them) and the sash are not expensive. They cost from one and a half to five dollars, according to quality and whether they are double or single

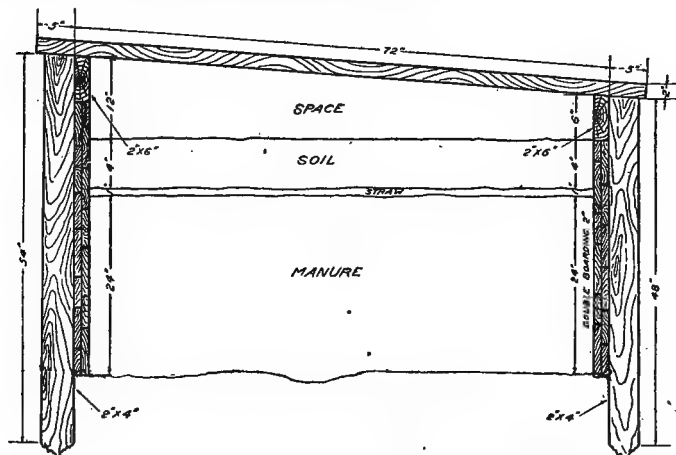

Section of a hotbed frame with details of measurements. Reproduced from a Cornell bulletin

glazed. With reasonable care they will last indefinitely. I have a sash in use today that has been used continuously for over twenty years. Concrete frames are growing in popularity, as they can be built at little additional expense and will last practically forever. They are tighter and warmer than wooden frames, and they do not warp or settle, so that the sash always fits them tightly, a very important point.

Standard size sash covers a space 3 by 6 ft., and the frames to support it are made to correspond. In building of wood it is better to use 2 in. planks, although inch boards are often employed. In building a wood frame, after ascertaining the correct size to fit the particular sash you are buying, put in posts of 3 by 4 in. stuff with the inside corner planed down for an inch or so, to avoid a sharp edge. There should be a drop of about from 3 to 4 in. from the back to the front. If you can get boards or planks 6 and 9 in. wide, and 6 or 12 ft. in length,

practically no cutting will have to be done in building the frame. Let the sides come down well below the ground as the soil inside should be a few inches below the general ground level. After it is finished, a layer of gravel or roofing slate on the outside, or banking up with soil, nearly to the top, will greatly increase its efficiency in keeping out cold. Concrete frames should be made 4 to 6 in. thick and sunk well below the ground level so that the frost cannot get under the mason work.

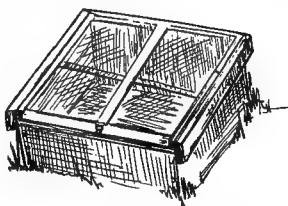

Small forcing frame

At least part of your sash should be of the double glazed type. Two layers of glass instead of one are used, with the result that the thin air space left between them forms a cushion of dead air which is as effective as a blanket of wool or canvas in keeping out the cold, while it admits the light and sunshine as readily as a single layer of glass. With a good tight frame and double glass sash, crops may be grown well into the Winter, and started very early in the Spring, without any other protection.

With single glass sash, wooden shutters or burlap mats are used as an extra covering in cold weather. If these are employed in addition to double glass sash, half hardy crops, such as Lettuce, can be carried through very severe weather without any artificial heat at all, and the frames will be ready for use in the Spring as early as they may be wanted, without having to wait for them to thaw out.

Hot beds are made one to two feet deeper than for cold frames to allow for the layer of manure put in to furnish the heat.

LOCATION. Generally it is best to locate with southern exposure and with a protection of trees or fence at north. Three feet should be allowed back of frame to the fence to allow for working facilities. Do not put the frame where the Spring rains may drain into it; good drainage is especially important in Winter as well as in Spring.

PREPARATION OF BED. During Winter keep the snow out by a covering of boards. In the middle of March, or six or eight weeks before plants can be safely put out of doors, if the bed has been constructed as directed, two feet of fresh manure is placed in the frames. Nothing but fresh manure will suffice, horse manure being best, which has been piled and turned several times to bring to a uniform temperature. As placed in frames, the manure should gradually be stamped rather firmly. To insure more uniform heating a layer of straw is used to cover the manure. Soil which has been stored in

basement is then spread over to a depth of four inches. The soil should be rather sandy and should consist of good loam, leaf mold, sand and some well decayed manure. Put on the sashes and, as Mrs. Rion, in "Let's Make a Flower Garden" says: "Let her bile." It will steam tremendously for four or five days, then it gets down to regular business of more or less even heat. There are nice thermometers to be had to take the bed's temperature; find out when its fever has dropped below ninety degrees; then you know it is time to go ahead and plant.

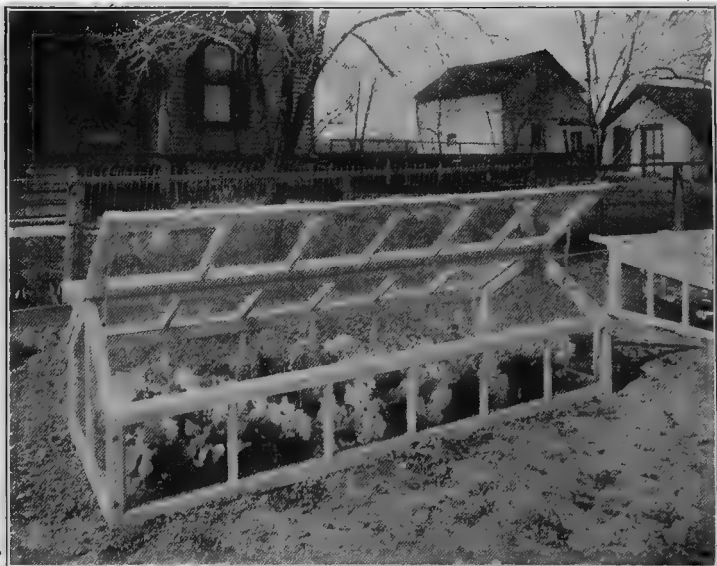

One of the King Construction Co.'s double-glazed frames; a very valuable type

Another sort of hotbed may be constructed by placing a coldframe upon a heap of manure which in the colder regions should be a foot and a half thick when packed rather firmly. Hotbeds can be easily heated by running a pipe from the heating plant of the house into the frame which can be located near the house.

MANAGEMENT OF HOTBEDS AND COLDFRAMES. Radish, Lettuce, Cabbage, Tomato, Cauliflower, Aster, Pansy, Scarlet Sage, Verbena, and such seeds, are planted in rows, several inches apart. The ventilation of the frame must be carefully attended to and if moisture

condenses on the glass the sash should be lifted a trifle on the side away from the prevailing wind. Sashes should be capable of being raised at any angle. Much damage can be done by leaving the frame closed tightly on sunny days, for the crops are easily burned.

The watering should be done on sunny mornings. When the plants have produced their third leaf they should be transplanted according to their various needs. Lettuce will, perhaps, be matured in the frames and will need to stand eight inches apart, while Tomatoes



A well-sheltered line of cold frames facing due south. How invaluable they are

may be set out three inches apart and transplanted again. On real cold nights the hotbeds should be covered with some sort of mat, either of straw or padded cloth.

Prof. Wilkinson of Cornell University gives the following discussion of vegetable combinations that can be grown in a hotbed:

“Radishes, Lettuce, Beets and Carrots seem well adapted for growing together, while Tomatoes, Egg-plants and Peppers, although they can be raised with the others, will grow better if given a higher temperature than, and conditions slightly different from, those required by the first four plants named. Through experience the various requirements of different plants will become known to the grower.

- "A good plan for planting a hotbed for the home garden is shown on page 161. The Cabbage, Cauliflower, Tomatoes and Lettuce that are transplanted to this bed can be first raised in a small flat, which is a wooden box twelve inches wide, eighteen inches long outside and two and one-half inches deep, filled with dirt, either earlier in this bed, in another bed, or in the house at a sunny window or behind the stove. Other plants, such as Radishes, Beets and Carrots are sown for maturing in this bed. For the best results they will require thinning, the Beet thinnings being used as greens. The seed of Celery and of Onions is sown and the seedlings are transplanted later.

"After the Lettuce plants have been disposed of, one row of Cucumber seeds may be planted, the plants being thinned later to six inches apart. Cucumbers may be planted also after the pots at the back of the bed are removed. The Cucumber plants are then allowed to spread at will and to mature a crop of Cucumbers for slicing or for other uses as required.

"After one crop is taken out another can follow, the soil in the bed being forked over and raked level between crops, and after the manure is spent the bed can be used for the development of vegetables throughout the Summer. In the Fall the soil and the spent manure is taken out of the hotbed pits, the sash is stored away, and the board covering is replaced for Winter protection. Fresh manure is used every Spring, also fresh soil, the process of making and managing the hotbed changing only as the operator becomes more experienced in successful hotbed work."

The same treatment should be given coldframes, except that they cannot be started so early.

USEFUL LITTLE FORCING STRUCTURES. The gardener's inventive genius will devise a hundred ways of growing the earliest possible plants out of doors. He will use boxes with glass lids and butter bell jars. Finally, he will see the advantage of a small individual cold-frame and will have small coldframes one or two feet square constructed, in which he can cultivate Cantaloupes, Cucumbers, early Peppers, Squash, Lima Beans

The Cloche Co. has devised a very ingenious plant forcer made of glass held together by wires. They are sun catchers and should be a great factor for early results. It is a handy and useful method of growing vegetables under what it calls "cloches."

There is a system of forcing in hotbeds called "French gardening." It takes a great deal of labor and a very perfect condition of soil, but enormous crops are grown on small areas. Those who are interested in vegetable growing should read about this French system of gardening.

A new type of frame, which is practically a miniature greenhouse, can now be bought. (See illustration page 221.) Double glazed sash are also used, and a miniature heating plant can be operated in cold weather in a little enclosure at one end of the frame. This does away with the inconvenience and the trouble of procuring and handling manure to furnish artificial heat

The satisfaction that you will get from your frames will depend upon your carefulness in planning their use. Look ahead and have one crop growing and ready to occupy frame space as fast as another is removed. Thus, in the Fall, you should start Lettuce in August or early September to be large enough to set in the frames as soon as frosty weather arrives. Radishes can be planted and half-grown before it is necessary to put on the glass. Lettuce started in January or February in the hot bed or in the house will be ready to set out in the frames in February or March. Cucumbers or Melons started in paper pots can be set into frames after the Spring grown plants are removed, weeks earlier than they can be put out of doors. Plan always for a succession of crops in your frames, just as you do in your garden.

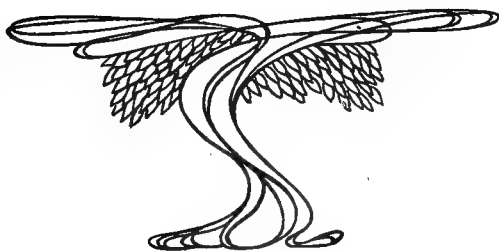

CHAPTER XXII

Birds in the Garden

Mr. Chas. Livingston Bull, than whom no one is better acquainted with the birds and their habits, furnishes us excellent directions for making them tenatable homes, as follows:

The bluebird and wren are the easiest to satisfy as to the outward appearance of the house; probably nine out of ten native birds living in artificial nesting sites are bluebirds. Almost any box, if only it has a space at least four and one-half inches high by the same width, and a length of seven inches or more, with a hole about one and one-half inches in diameter, preferably round, at the end and not too low down in that end, with some sort of perch just below it, will please the bluebird. As to outside finish, the more it looks like some natural object the more sure it will be to attract the lovely little bluecoats.

The most successful bluebird box of which I have knowledge was a section of a hollow limb, in which a woodpecker had cut a little round hole into the cavity. This limb, about seven inches in diameter, had been sawed from the tree and a section about two feet long containing the cavity, had been cut out and wired to the branch of an old Pear tree. This was used every year by a pair of bluebirds, and most years two broods were raised. Think of the thousands of fruit worms and curculios and other insects that went to feed the broods in that nest year after year!

I have duplicated that nest a number of times simply by cutting a section of a branch or small trunk, seven or eight inches thick and a foot long, boring a hole with an inch and a half bit half-way through, near one end, then hollowing out a chamber, either by sawing a slab off one side, which is tacked or wired on again after the chamber (about 5x5x8) is hollowed out, or by sawing a section for a cap two inches thick from the end farthest from the entrance hole and then drilling or turning out the hollow and closing the end with the cap, carefully tacked on. This house should be hung horizontally.

If a box is to be used as the foundation of a bluebird house, cover it with bark or make it of slabs with the bark on, or at the very least, stain it a dark grayish brown, and if the proportions are right, the birds will do their part.

Bluebirds like to nest rather low. The house should be placed either on a pole in the garden, about seven or eight feet above the

ground, or on a tree branch, perhaps a little higher. The pole or branch should be so slender that a cat would not venture to climb it, that is, not more than one and one-half inches thick; and if a pole, preferably some smooth, hard wood like a rake handle or the thick end of a bamboo fish pole.

The wren, whose bubbling song is such a joy all through the Spring and Summer, does not get here so early as the bluebird and might easily find all the nesting sites occupied, were it not for one thing. His tiny body will squeeze in where no sparrow or starling or bluebird could obtrude, and while he might try the bluebird box, the first pair of bluebirds or sparrows to come along would surely oust him.

An entrance hole one inch in diameter is the solution, and if the interior is no more than three and one-half or four inches square by six inches long, the larger bird will not even look in more than once.

Wrens have been known to nest in many curious places, such as the sleeve of an old coat, an old boot, a bomb shell, a pump, an empty Tomato can, and perhaps the most curious of all, a human skull.

The great majority of wrens, however, nest in a hollow limb or tree trunk, and naturally the bird house which most resembles such a location will be the most likely to attract these tireless little bug hunters. The ideal box would be the one which most nearly resembles a big knot on the side of the tree trunk.

A bluebird does not seem to care how exposed the house may be to the sun, in fact, he rather likes an open situation, but I have yet to see a wren's nest where the entrance was not well shaded, so, to guard against the gardener, who might not know this peculiarity of the cunning little brown fellow, the bird house man should provide a good overhang to the roof of the wren house, also a little perch just below that entrance hole and be sure once more that same entrance hole is round and no more than an inch in diameter. A couple of designs which have been successful are shown on pages 230 and 232.

Writing of the robin, Mr. Bull continues:

How cheery is his morning song just at the first peep of day. And how sweet his long evening song which he keeps up till long after sunset. And how weatherwise he is.

When he flies up to the topmost branch of his pet tree and calls his "twill-rain!" "twill-rain!" you may be very sure the garden will be sprinkled without overworking the water meter. How fat and cheerful he looks as he hops over the lawn; stopping now and again to yank out a great fat worm, possibly as long as himself. He will be glad to nest in your garden and if you have a large tree he will usually nest in that, but so many trees have no suitable forks. He would be most pleased to nest on a shelf under the eaves of your house, but so many

houses have no shelf there. Or under the porch roof, if he could find a good place. But most houses are so built that there is no suitable location for him, and so there have been many attempts to construct locations which might attract him.

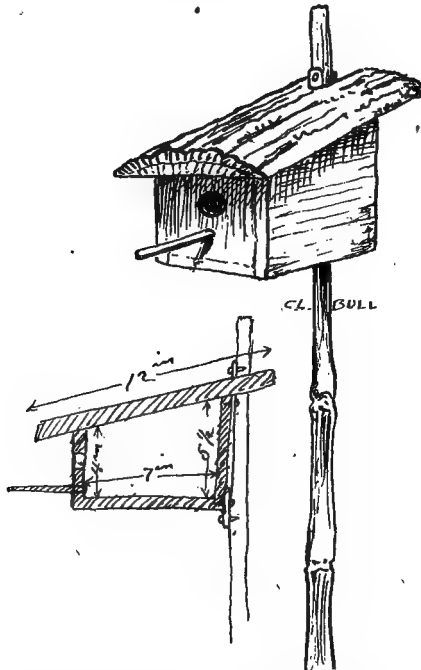

A serviceable bluebird house. Make box as shown in sketch, preferably of slab wood, especially top. If impossible to secure wood with bark attached, stain dark grayish brown. Box is fastened to pole by strip of sheet iron screwed on back of box and screwed to pole

He will not enter a hole. No box or house for him! It must be in the form of a shelf, preferably with a cover. It must be open on at least two sides and should have a low raised rim around the edge to keep the nest from being blown or washed off. It should have a roof, too, for while the great majority of robin nests are in trees, and in rather open situations at that, when they can find a good situation on a house it will nearly always be under some sort of overhang.

The shelf might be hung right on the side of the house, preferably on the east or west side, not on the south unless the location is partially shaded. It should hang so rigidly that no severe wind will swing it too hard, preferably by two screw eyes. The roof should have enough pitch and overhang so as to shed most of the rain and yet not too much. I have never seen a robin's nest less than 8 ft. above the ground and usually they are much higher; so hang it fairly high, beside or under a second-story window would be a good place; and, if there are vines, so much the better. If it must be in the garden, then put it on a tree 10 ft. from the ground or on a pole among the twigs and leaves of some shrub or bush 10 ft. high. The most successful robin shelves are those 7 in. square with a rim 1 in. high and half an inch wide around the open sides, making an inside measurement of 6 in. square. The back and one side closed; the whole stained brownish gray or to match the side of the house where it is to hang. The roof is preferably a piece of wood with the bark on and should be 4 in. above the platform at the lowest point and should have an overhang of about 2 in.

The same thing is right for the cat-bird, but the location should be entirely different. Cat-birds always nest close to the ground (from 2 ft. to 6 ft.) and in the heart of the densest brush they can find. The center of your biggest Rambler Rose is your best location, or deep in a close growing evergreen: Cedar, Retinispora, clipped Spruce or Hemlock or some similar growth. I found a big thorny Barberry bush in a clump of other shrubs a good place, when I tied five or six branches together above the little platform to hide it thoroughly.

One of the most valuable birds we can have about our homes is the phoebe. He belongs to the family of flycatchers, and well justifies the name for he spends the entire day watching from a twig and flying out and snapping up every fly, mosquito or moth that passes, and will pick off every little leaf or fruit worm that his keen eyes may note.

His note "phoebe, phoebe," is not as musical as the elaborate and varied assortment the cat-bird will regale one with; but it is cheery and alert, and, when one thinks of the vast number of insect pest she is destroying hourly, it is a most welcome note indeed.

The phoebe is not as common as we might wish, but if your garden is fairly large and the houses are not too close together, a pair will doubtless look you over this Spring, and if you have the right sort of place ready, may stay with you.

The favorite location for the phoebe is under a bridge or on a shelf of rock under a ledge, or a beam under an open shed, or similar location; preferably near water, though not necessarily so. They like plenty of room, and a good cover. The shelf should be 6 in. wide and at least 12 in. long, open at ends and with roof 5 in. above at the front

and 6 in. or 7 in. at the back and an overhang of at least 3 in. A perch is not necessary.

They are rather particular little fellows; for example, it is of little use to hang such a shelf on a house painted a light or bright color for

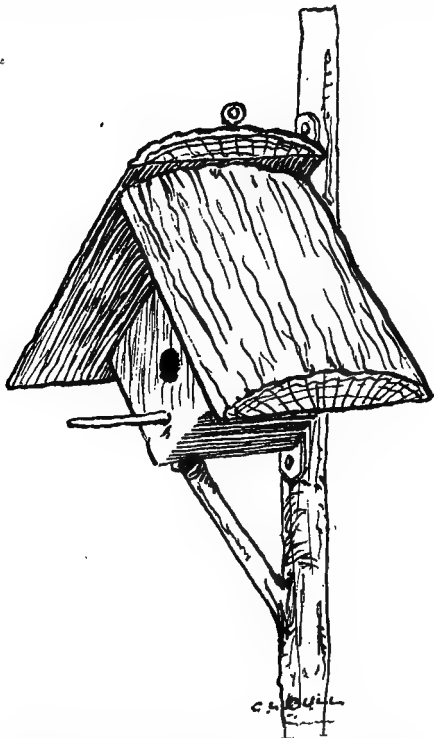

Wren House—Simply a square box (5in.), all dimensions inside measurement, with slab covering, flat on back, but 3 in. overhang in front and 1 in. at sides. One inch hole at center of front; 3 in. perch. We have shown this box on pole but it could be hung from screw eye.

they will not be interested. They will have nothing to do with anything on a pole. There must be the suggestion of the big wall of rock and the protected ledge, so if you can, hang the shelf under the eaves or under an open porch, not more than one story from the ground. No high places for them, but it should be 7 ft. or 8 ft. from the porch floor

or ground, at least. If you are so fortunate as to have a pair of phoebes nest on your house, you will be well repaid for the trouble of putting up the little shelf and be sure that it is some dark color, brownish or grayish, or you will have your trouble for nothing. To make the birds perfectly at home we must provide a bird bath or drinking basin. For this purpose any low bowl can be used in which the water is not too deep, for it would appear that some birds fear too deep water. If the bowl is deep, fill in with clean pebbles or cement, or very attractive baths may be procured from some of the seed and florist firms. These pedestals and bowls furnish an excellent ornament to the garden as well.

A suggestion for making the bath more attractive is to plant an umbrella-plant in a small pot and place it at the side. A small quantity of Colomba and Parrot's Feather (*Myriophyllum*) might also be included and so placed that the pot will be entirely hidden.

I have divided the birds into four distinctive groups, as follows:

No.1.—SUET GROUP:

- Chickadee
- Tufted titmouse
- White-breasted nuthatch
- Red-breasted nuthatch
- Downy woodpecker
- Hairy woodpecker
- Red-bellied woodpecker
- Flicker
- Blue jay
- Oregon jay
- Whisky jack
- Crow
- Clarks crow
- Brown creeper
- Myrtle warbler
- Rose-breasted grosbeak
- Hermit thrush
- Winter wren
- House wren
- Starling
- Screech owl

- These birds also eat
- Sunflower seed
- Squash seed
- Meat
- Fat pork
- Crumbs
- Dog biscuit
- Walnuts
- Butternuts
- Unroasted peanuts
- Other oily nuts

A few of these birds will also eat cracked corn and oats.

No.2.—SEED GROUP:

- Junco
- Tree sparrow
- Song sparrow
- White-throated sparrow
- White crowned sparrow
- Foxsparrow.
- Cardinal goldfinch
- Redpoll.
- Snow bunting
- Evening grosbeak
- Pine-grosbeak
- Purple finch
- Gray-crowned rosy finch
- Other finches and sparrows

These birds also eat almost any kind of small seeds or cracked grains such as bird seed, millet, etc., crumbs, bread, crackers, dog biscuit, etc.

A few of this group will also eat a little suet, or will pick at a bone with a little meat or fat adhering, but their normal food is vegetable.

No. 3.—GRAIN GROUP:

Ruffed grouse
Quail
Partridge
Pheasant
Lapland longspur
Shore lark

Any kind of grain as:

Oats
Wheat
Rye
Barley
Buckwheat
Cracked corn

No. 4.—FRUIT:

Robin
Mocking bird
Catbird and most other thrushes

This is a Southern group. Will eat oranges, figs, grapes and almost any other fresh fruit, also, sometimes, bread and milk.

BERRY-BEARING SHRUBS, VINES AND TREES FOR THE BIRDS

Another way, and a very effective one of attracting birds, is to plant berry-bearing shrubs, trees and vines. The robins, starlings, thrushes, cedar birds, mocking birds, in fact most so-called soft billed birds, will eat berries, and some of the finches and sparrows will pick them open to get at the seeds.

Many of the migrating birds will stay about a place, where there is an abundance of berry-bearers and an allowance of suet and seeds, much later than they ordinarily would stay.

For example here in Northern Jersey as I write this in the last of October, there are great flocks of robins and thrushes hurrying to cull the very last of my Mountain Ash and Dogwood berries, before they go away South.

Last year one robin stayed with us all Winter eating the Japanese Barberries. There is also a pair of chewinks still here, while back in the woods they have been gone for at least three weeks. I should head the list of berry-bearers with such trees as the Mountain Ash, Dogwood, various wild Cherries and Cedars, Junipers, and other berry-bearing evergreens. These are especially beloved by the birds. A list of shrubs should include the shrubby Dogwoods, such as the Cornelian Cherry, Red Osier, etc.; many of the Viburnums, and Ilexes, all the Vacciniums (that is, Blueberries, Cranberries and Deerberries) some of the Loniceras and Cratægus or Hawthorns, Aronias, Calli-carpa, Enkianthus, Ribes, Rubus, Sambucus, Phillyrea, Amelanchier and Symphoricarpos, and be sure and save a shady nook for a clump of Mahonia and Cotoneaster. Last but not least we put the Barberries, for the reason that the birds will eat everything else first. Then when all the rest of the berries are gone they will settle down to the sour, bitter berries of *Berberis Thunbergii*. *Berberis vulgaris* is also very good, but the birds will eat its fruit earlier for the clear, sour

.. flavor (which our grandmothers found so good in jam making) is pleasant to the robins' palate so, let me repeat, be sure to have a clump or hedge of *Thunbergii*, for the cold January and February days when all the other sweeter fruits are gone and the Cedar birds will stay with you till the hosts appear from the South in March, April and May.

There are also a few vines which will repay planting for the birds. Notably *Actinidias*, *Lyceum* and the berry-bearing *Loniceras*.

All these trees, shrubs and vines are not only useful as bird food but have decorative value as well. Not nearly enough people realize the great beauty of berry-bearers in Winter. The warm oranges, reds, bright blues and clear blacks of the different fruits are most attractive and especially if there are evergreens with which to contrast them, their decorative value has only to be seen to be appreciated.

The birds will find the evergreens, especially the dense, close growing Cedars, *Arborvitæ*s and *Retinisporas* extremely welcome as roosting places on long, cold Winter nights, as I have repeatedly observed, every one of my Cedars having its cozy feathered tenants.

I will never forget the night I saw, just at dusk, a Pine-grosbeak creep into one of my Junipers, the only one of that species I have ever seen. Or that other February afternoon when in a little flock of cedar birds eating Barberries, I suddenly realized that one was twice as large as any of the rest and had two white bars on each wing and I knew I was watching a Bohemian waxwing, that rare wanderer over the face of the world. I am sure he found a sufficient supper, rather bitter to be sure but warming, and a dense *Arborvitæ* hedge kept him warm and safe for one night at least.



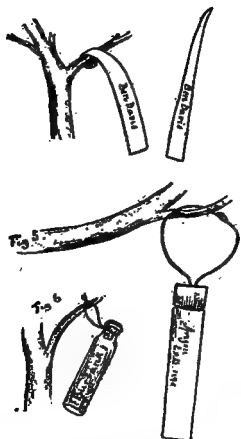

LABELS FOR FRUIT TREES

The top two are of thin strips of copper or tin; the largest one is of wood, while a third is shown in a sealed bottle

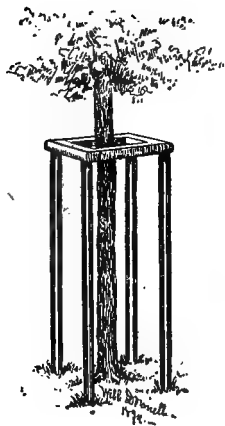

A tree guard

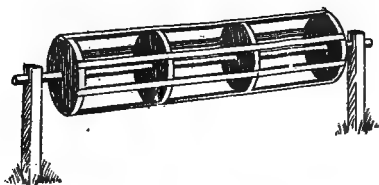

Roller for cloth or paper shade

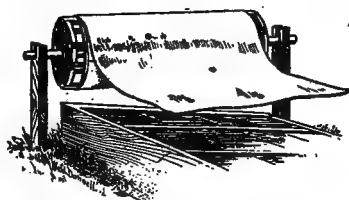

Showing how simply a shade or protecting cover can be unrolled

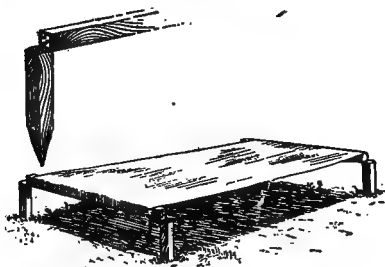

Shade for young plants and seedlings

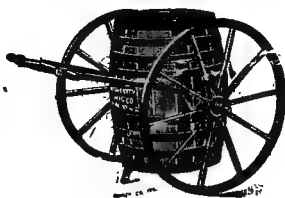

Water barrel on wheels

CHAPTER XXIII

Garden Tools

THE presence of a garden always carries with it the need for some tools. The first tools needed, perhaps, are a spade, a rake, a hoe and a trowel. In all of these tools nothing is more important than their strength. Strong unions of the steel to the wood are important, for it is here that the tool breaks most quickly. All the tools that are meant to be sharp should be kept so, or else their work cannot be done

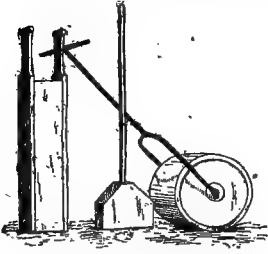

Two lawn beaters or levelers and a garden roller



Light ladder used for gathering fruit

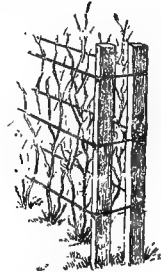

End posts and wires or strings used for Pea or Bean supports

efficiently. The spading fork is especially useful in digging up borders and about trees, as it may not cut off roots. The spade is indispensable for edging beds. Large and small hoes are both found useful, the large one for general use, and the small one for working about in small places. The Dutch or English scuffle hoe is found most useful for loosening the surface of the soil and cutting off weeds. A small hand

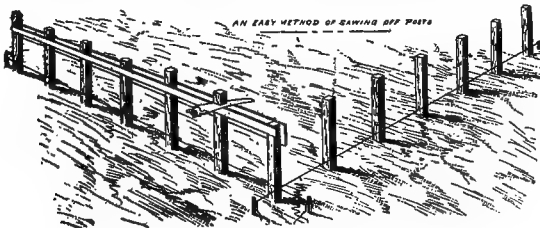

An easy method of sawing posts off level

cultivator is now on the market having prongs which are easily removed or their angle of cutting changed.

Many will feel that a wheel hoe is a very useful accessory tool; it will certainly come in handy, and can be used for hoeing, cultivating, furrowing, hilling up or raking. Combination seed drills and wheel hoes are also very serviceable. For the larger vegetable garden the seed drill will be very useful. With a seed drill the furrow can be opened, the seed sown, covered, the soil compacted over the row and the next row marked.

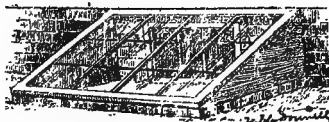

A little frame against a basement window

A wheelbarrow will surely be wanted; a good type is seen in the sketch. Some wheelbarrows are poorly balanced and are difficult to handle in the garden.

Small dibbers, or instruments for making holes, should always be at hand. Several sizes are useful. One may be the size of a broom stick with a curved handle, another should be small and is useful for transplanting young plants.

Pruning shears which are procured at ridiculously low prices are never worth anything. They are not sharp and injure the plants because in attempting to cut a branch, it is pinched and crushed. Good steel shears should be chosen fitted with strong springs which will cause them to open after cutting. The larger hedge and grass shears should also have these springs, otherwise they are a nuisance.

For the lawn we need as well as the standard ball-bearing lawn mower, a narrower one for trimming the edges; if you have much lawn you will appreciate the value of this machine for trimming to the very edge.

To keep the rows straight in the vegetable garden, a good stout garden line is necessary.

For cutting glass to be used in the hotbeds a glass cutter should be at

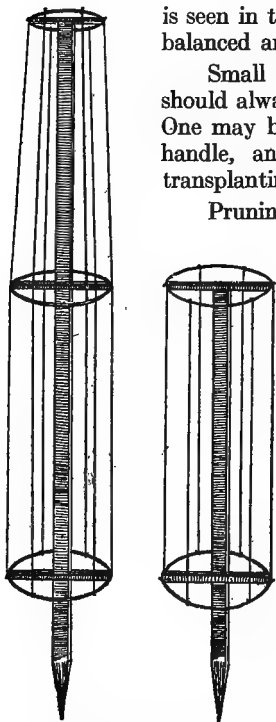

Tall and short supports for Beans or other climbing plants

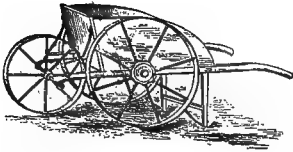

A broad-wheeled barrow



A sickle, sometimes used instead of shears



Garden steps

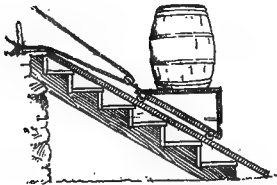

Shows a device for hoisting a barrel up steps or incline

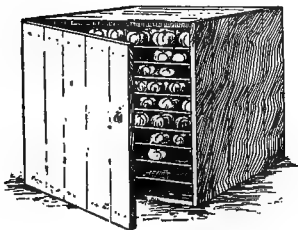

Shelves and temporary storage box for fruit

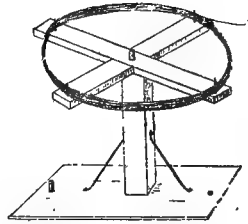

Device for winding cord or wire. A modification of this can be used for winding hose-pipe

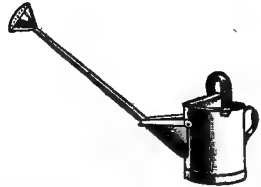

Long-stemmed watering can

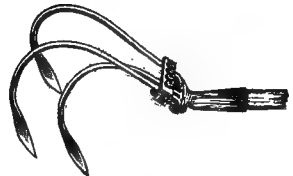

Three-pronged hand cultivator



A frame barrow for leaves, grass or similar material

hand. Very cheap steel ones can be bought, as well as better ones with diamond points. It is a rather simple matter to cut glass if a flat surface is available. The main object is to get a deep, even cut entirely across the glass.

Gloves are needed when pruning Roses and other thorny plants. Perhaps old discarded ones are as good as anything bought for the purpose.

Here is about what tools will cost on the average:

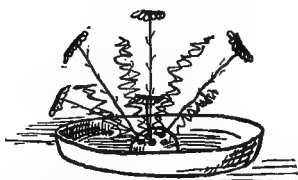

The old and the new way of arranging flowers. Top: bunched vase, too close. Bottom: glass holder in dish, allowing ample freedom of arrangement

Dibber.....	\$0.35
Hand Weeding Fork.....	.25
Spading Fork.....	1.00
Garden Line.....	20c. to 1.00
Glass Cutter.....	15c. to 3.00
Glazing Points, per lb.....	.75
Gloves.....	1.25
Grass Edging Knife.....	.75c. to 1.50
Sickle.....	.50c. to .60
Grafting Tool.....	.50c. to .75
Hoe, Ordinary.....	.50c. to .60
Hoe, Dutch or Scuffle.....	.50c. to 1.00
Lawn Roller, Water Ballast	
	\$11.00 to \$20.00
Rake, Steel, Bow, or Garden	
	45c. to .70
Saw, Pruning.....	.60c. to 1.25
Shears, Pruning.....	\$1.00 to 1.50
Shovel, Square Pointed,	
	\$1.00 to 1.40
Spade.....	1.00 to 2.00
Trowel.....	10c. to .50
Watering Can.....	.40c. to 2.50
Wheelbarrow.....	\$2.50 to 3.00
Wheel Hoe, Seed Drill, etc.	
	\$4.25 to \$10.00

CHAPTER XXIV

Calendar of Operations

THE suggestions for the work for the various months must always of course be merely approximate. Seasons govern land operations; latitude and altitude have also a wonderful influence on the climatology of a given place. We furnish two calendars, one as a guide to work to be done in the Northern and Middle States, and the other in the South, or say south of a line drawn through Richmond, Virginia; Nashville, Tennessee; and the Southern Mississippi.

Prof. J. W. Lloyd, of the University of Illinois, in his book on Vegetable Growing, makes three sections, the Central, Northern and Southern, and says that while no absolute boundaries can be ascribed, still one merges into another in a general way. For example, the territory lying between 37 and 42 deg. parallels of latitude may be considered as essentially Central, while the area north of the 42 deg. may be considered Northern, and that South of the 37 parallel Southern. These boundaries refer only to relatively low elevations, and do not apply in the high altitudes of mountainous regions.

In regard to the Calendar for the South, it is a pretty safe rule to do land operations one week later for ever 100 miles north. In this case the writer has made Southern Maryland his base.

Calendar for Middle and Northern States

JANUARY

This is the month for planning ahead. Look over the alterations to the garden, the purchase of new plants and stock. It is also the month for the ordering of early seeds, and for looking over catalogs. Pruning of some outdoor shrubs may be done (see Pruning chapter) as well as of fruit trees, if the weather allows. Keep snow from specimen evergreens.

Give air to cold frames wherever the temperature is well above the freezing point. Take Asparagus and Rhubarb to greenhouse for forcing, and place them under the stages. Sow Lettuce, Catflower, Cabbage, Onion and Leek under glass.

FEBRUARY

Sweet Peas may be sown in pots in the greenhouse or in frames

if they are intended for exhibition. Keep Violet plants clean, and begin taking runners for the supply of new plants for next year. Stakes and labels may be got ready for Spring and Summer. Collect hotbed material. Spray fruit trees against San José scale.

MARCH

Pruning may be done on Catalpas, Hibiscus, Vines. By the end of the month protective material may be taken away from most of the shrubs. Lawns should be swept, rolled, re-seeded and top dressed. Pansies, Daisies, dwarf Phlox may be planted at the end of the month: About the 17th make a hotbed. Sow seeds of annuals and perennials, especially Asters, Begonias, *Cobæa scandens*, Coleus, Gypsophila, Nicotiana, Petunia, Phlox, Ricinus, Salvia, Verbena, Zinnia, in the greenhouse or in frames. Sow in the greenhouse or hotbed, Peppers, Egg-plant, Tomato, Cucumber and Melon.

APRIL

Set out plants of Cabbage, Cauliflower, Celery, Kohl-Rabi, Leek, Lettuce from frames.

Set out plants of Alyssum, English Daisy, Dianthus, Myosotis, Pansy. Also sow in frames seeds of above and Asters, Candytuft, Celosia, Centaurea, Dianthus, *Dimorphotheca*, *Eschscholtzia*, Hollyhocks, Marigold, Morning Glory, Nasturtium, Poppies, Pyrethrum, Sweet Peas, Sweet William. Seedlings sown in March need transplanting. Make cuttings of all house plants that will stand it, such as Geraniums, Coleus, Begonias. Give them an indoor start. Sow outside Beets, Carrots, Corn (extra early), Kohl-Rabi, Leek, Lettuce, Onions, Parsley, Parsnips, Peas, Potatoes, Radish, Salsify, Spinach, Swiss Chard, Turnips.

Divide perennials and plant others received from nurseryman. Plant shrubs and evergreens. Plant Apples, Pears, Peaches, Plum trees, Currants, Gooseberries, Strawberries. Plant Beans, Corn and Cucumbers, Melons, Pumpkins, when Apples bloom. Give the Rhubarb some manure and nitrate and cover with box to keep it tender.

Asparagus.—Dig in the mulch and give nitrate and other fertilizer. Leave a few stalks for beetle traps. Prune hedges.

MAY

Frames need attention to watering and ventilation. Sow seeds for late crops of Cabbage and Cauliflower. Nothing is gained by setting out Egg-plants and Peppers too soon. Wait until it is really warm before removing from coldframes. You can keep the Onion and Carrot row stirred if you have planted Radishes and can see where the row is.

Spray fruit. Plant *Gladiolus* till late in June. Plant about four inches deep. Dahlias may be planted for later blooming.

When planting be sure to divide Cannas.

In the region of Central New York it is hardly safe to set out any bedding stock before May 30. A frost usually comes quite near this date. Roses bought from nurserymen can be set out.

Spray Currants with arsenate of lead wash, against caterpillars.

Plant *Gladiolus*, tuberous-rooted *Begonias*, *Caladiums*, Cannas, Tuberose, Madeira vine. Start *Asparagus* seed to keep up your stock. Put up window boxes, porch boxes, hanging baskets.

Make another sowing of all crops already sown. Sow early Corn, Cucumber, Melon and Squash. Thin crops to prevent overcrowding. Examine Peach trees for borers. Spray for Codlin moth as soon as Apple blossoms have fallen. Dust with hellebore powder for caterpillars on Gooseberries.

JUNE

Dahlias may be planted up to the middle of the month. Tender or half hardy annuals can be sown out-of-doors. Plant out tender Water Lilies. Spray against Rose bugs and aphids. Tie climbing Roses and vines. Keep all land well cultivated. See that recently planted trees are kept watered. Evergreens may require to be sprayed with clear water to prevent wilting. Lawns also may require watering. German Iris can be divided and replanted at the end of the month. Make successional sowings of desired vegetables. Sow Sweet Corn for September; also start Cabbage and Brussels Sprouts for Autumn use. Store away temporary frames and sashes.

JULY

Some pruning can be done to certain shrubs (see Pruning chapter) that have flowered, but this should mostly be done merely to thin the growths and allow room for the development of new ones, as in the case of the Flowering Currant, climbing Roses, *Spiræa Thunbergii* and *Van Houttei*, *Calycanthus florida*. Give herbaceous borders and flower beds constant cultivation. Staking must be done wherever plants require it. Trim lawns and hedges. Divide Japanese Iris. Remove seed pods from *Rhododendrons*. Keep everything well-watered. Cultivate thoroughly. Plant Sweet Corn and Beans for use in late September. Plant out late Tomatoes, Celery, Cabbage and Brussels Sprouts. Sow Endive for use in Fall.

AUGUST

Evergreens may be moved now. Transplant Iris, Peonies, Oriental Poppies and Madonna Lilies. Spray Box plants for red spider. Dust

the lawn with bonemeal after rain, or water thoroughly. Final Beans can be sown, Carrots and Beets also. Sow late varieties of Peas. Sow Spinach. Look over the Cabbage before it heads, for Cabbage worm and hand pick. Onions are gathered near the last of the month. Order bulbs. (Read chapter on Bulbs). Keep runners of Strawberries cut. Early in month sow perennials in some sort of frame. Cut flowers to prolong the season of blooming.

SEPTEMBER

New lawns may be made. Shrubs or trees may be transplanted at the end of the month. Cuttings can be taken of Geraniums, and some other bedding plants, and seeds of perennials and biennials sown. Plant early Dutch bulbs. Begin to blanch late Celery with soil or brown paper. Dig late Potatoes and harvest the Onions that were from seed.

OCTOBER

Dutch bulbs can be planted this month; the sooner they are planted the longer period they have for rooting before Winter starts and the better the results. Seedlings of hardy plants may be transplanted, and hardy borders can be re-made. This is also a good month for the thinning out of the branches of fruit trees before the leaves fall. Collect leaves for the making of leaf mold, or for protection purposes. Collect Corn stalks. Roses can be planted. Prepare compost pile for hotbed or greenhouse for Winter and Spring and take under cover. Place Parsley plants in frames for Winter use. Blanch Endive.

NOVEMBER

Leaves can still be collected. Plant bulbs, trees and shrubs, as well as hardy plants. By the end of the month protective material should be placed around the Rhododendrons, Hydrangeas and other shrubs. Dig up Cannas and Dahlias and store them. Take in Bay trees and Cacti to shelter. Digging should be done. Store Potatoes and all root crops. Clean up generally. Dig some Rhubarb before ground freezes hard.

DECEMBER

Tie up evergreens. Knock snow off branches of large trees. Protection may be given to shrubs or plants that are reputedly not altogether hardy. Ventilate frames on every good day. Protect Celery or such other crops as may be in the open ground. Look over and clean and oil all tools. Roots, fruits and stock in storage may be looked over occasionally during winter. This is the period when we look back; next month we look forward!

Garden Calendar for the South

JANUARY

Plant the extra early Peas of the Alaska type. Plant Broad Windsor Beans to come in green along with the early Peas. In Florida and the Gulf Coast plant early Irish Potatoes. If the Sweet Peas were not sown in the Fall they should be put in the ground as soon as possible to get them to bloom before the weather gets too hot. Lettuce in frames should be fully exposed to the air in all warm and sunny spells. Where grown under cloth it will get drawn up weak if the cloth is kept on too close. Sow Early Turnip Radish.

FEBRUARY

- In all the central and upper South prepare and fertilize the soil ready for planting Early Irish Potatoes from middle to last of the month. Sow seeds of Lettuce in a well prepared bed for transplanting in March for the early Spring crop in the open ground. Sow seed of the Copenhagen Market Cabbage and the Succession to follow the Fall-set plants of the Wakefield. In the latter part of the month sow the wrinkled Peas. Sow early Milan Turnips. Level the early Cabbage ridges after the middle of the month and cultivate clean and use side dressings of Nitrate of soda 150 lbs. an acre to push the early growth. Sow Leeks in seed bed. Sow seed of the Prizetaker Onion in frames early in the month for transplanting later. Sow in the open ground the latter part of the month seed of the New England Globe varieties of Onions in heavily fertilized soil. These will make full sized Onions the same season. The Bermuda Onions can also be grown by the transplanting method, or will make good crop sown in the open ground. The first week in the month sow seed of Earliana and Bonny Best Tomatoes and Sweet Peppers in a well made hotbed under glass. Give them plenty of air in sunny weather or you may cook them. Plant Asparagus seed and set roots. Sow early Beets and Spinach and Early Horn Carrots.

MARCH

In the upper South the Early Irish Potatoes can still be planted, and the latest Peas like the Champion of England. Later than this they will be caught by the hot weather. Transplant the Onion plants as soon as they are the size of a lead pencil, nipping roots and tops slightly and setting in rows shallowly 15 in. apart and 3 or 4 in. in the rows. Transplant the early Tomato plants into cold frames for hardening them off for setting in the open ground in April. Set the

plants 4 in. apart each way, and slip the sashes down in all sunny weather to get them inured to the air, and finally get them so hardened that the stems will have a purplish hue instead of a delicate green. The latter part of the month make the first sowing of Snap or String Beans. The Black Valentine is the most hardy for this early crop. Slight ridges running east and west should be made and the seed planted on the South side to shelter them from cold winds. If frost threatens take the hand garden plow and throw a furrow over the plants till the cold passes. Early Beets can be sown early in the month. Prepare beds, preferably under glass sashes, for bedding the Sweet Potatoes for the production of plants. A very light hotbed will answer or they can be bedded under the sashes and the sashes kept closed till sprouting shows and then give plenty of air in sunny weather. The sashes can be removed from the January-sown Beets and used for the Tomatoes and Sweet Potatoes. The Beets are then thinned and the thinnings transplanted. Sow early Turnip Radishes early in the month or late February. Sow Egg Plant seed in hotbed. Make first planting of garden Corn. The Norfolk Market Corn is better than sugar Corn for the early planting. Plant Sugar Corn last of the month. Sow Red Valentine Beans. Sow Early Horn Carrots. Plant Horseradish root.

APRIL

Sweet Potatoes should be bedded in the upper South. Plant succession crops of garden Corn, such as Kendel's Giant, Country Gentleman and Stowell's Evergreen. Sow Onion seed very thickly in rows to make sets for Fall planting. The white Pearl is good. Sow in fairly fertile soil without fertilization as the sets should not grow larger than a marble. Take the Tomato plants from the frames with a trowel and a mass of earth and transplant into holes filled with water and pull the dry soil over. If frost threatens after they are out turn the plants over and cover with soil till the cold passes. In the garden, set them in rows three feet apart and two feet in the rows and train the single stems tied to stakes. They will be earlier and better in this way. Sow Okra seed in rows three feet apart and thin the plants to 20 in. in the rows. Sow more String Beans for succession crop as soon as the ones sown last are well up. Plant Muskmelons in well-manured hills 6 ft. apart, and Watermelons in hills 8x10 ft. apart. Sow Parsley early in the month. Peppers sown with the Tomatoes in February and transplanted can be set out this month. For late Pickles sow seed in a border of the Sweet Peppers and transplant later. Sow seed in open ground for late crop of Tomatoes. Sow succession crops of Beans of Bush or Snap varieties and plant Bush and Pole Lima Beans. Sow Endive and Kohl-Rabi. Set succession of Summer Cabbages. Sow

Radishes of long sorts like Chartier. Plant Squashes, Canteloupes and Melons.

MAY

Continue succession crops of String Beans and Sweet Corn. Sow Tomato seed in the open ground for late crop plants. Sow Celery seed on border on north side of building or fence. Prepare the bed smoothly and sow the seed in lines 6 in. apart and pat them down with back of spade. Then cover bed with gunny sacks and water on these. As the seed germinates lift and gradually remove the sacks, and when the plants are large enough to handle transplant to another bed in rows a foot apart and 2 in. in the rows to make strong plants for setting in August.

Make third planting of Gladiolus corms. Lift Dahlia roots that have started and divide to single shoots and replant. If Canna beds are too thick lift them and divide the roots and replant. Plant Caladium esculentum. Any of these that have been left in the ground with a mulch should have the mulch removed. Sow more Tomato seed for late Fall crop. Transplant Egg-plants. Set succession Cabbages.

JUNE

Sow seed of Parsnips and Salsify about the middle of the month. These are among the earliest things sown in the North, but in the South they are apt to get overgrown and run to seed if sown early. In fact, we have sown them with success in July in North Carolina. They make their best growth in the Fall and grow more or less all Winter. Keep up succession plantings of String Beans and Sweet Corn. Plant more Gladiolus corms for succession. Tomatoes trained to stakes should have the side shoots regularly pinched out. Gather Tomatoes as soon as they begin to show color and put in shady place to fully color. This will prevent sun-scalding. Watch for the Southern bacterial blight on Tomatoes and Egg-plants, and if any escape where others perish, save seed from them to breed resistant strains. Sow Collard seed. Transplant Endive and late Tomato plants. Plant Cucumbers for pickles. Half long Carrots and Blood Beets last of month. In upper South plant late Irish Potatoes middle of the month.

JULY

Set Late Tomato plants for the Fall crop. Plant Carrots and late Beets. Fight the Crabgrass or it will soon get the better of you. Sow seed of late Cabbages after the middle of the month, and see that the seed bed never suffers from lack of moisture to get strong plants for setting in late August. Sow Rutabaga seed middle of month. Plant late

Irish Potatoes up to middle of the month; cover lightly at first and gradually work the earth to them as they grow till level, and cultivate shallow and level to conserve moisture. Cold storage seed best. Continue succession crops of String Beans and Sweet Corn, late Beets and Carrots, Salsify in lower South, Cucumbers for pickles. Tie up Curled Endive when leaves are dry. Sow green Curled Scotch Kale for transplanting to make large heads. Spray late Irish Potatoes regularly with Bordeaux mixture to prevent late blight. Spray late Cabbages with lead arsenate for the green caterpillars. They can also be kept down by dousing the plants weekly with the soapsuds from the family wash. Transplant Leeks from seed bed into open furrows and then gradually earth up till level to get good long shanks for Winter use.

AUGUST

Sow seed of Big Boston Lettuce for the outdoor Fall crop early in the month. After middle of the month sow English Peas for the Fall crop in deep open furrows and draw the earth to them as they grow till level so as to have the roots deep in moist soil. The dwarf early varieties like Sutton's Excelsior and Thomas Laxton are best for this sowing. Sow seed of Brussels Sprouts early in the month to make plants for setting in September as for Cabbages. After the middle of the month sow Savoy Leaf Spinach in rows 15 in. apart for the Fall crop. Sow early Milan Turnips for Fall use. After the middle of the month sow seed of the Prizetaker and Giant Gibraltar Onions for transplanting in October. Bermuda Onions can be grown in same way in the lower South. Set Celery plants in upper South. Make last planting of Sweet Corn. Sow succession crops of String Beans. Set late Cabbage plants after middle of the month. Sow green Curled Kale and Norfolk Curled Kale in rows for cutting later, last of month. Sow Chinese Celestial and rose colored Chinese Radishes for Fall use.

SEPTEMBER

Lettuce can still be sown for transplanting and heading in the open ground south of North Carolina, and the latter half of the month sow seed for setting in frames for heading in December and January, either under cotton cloth or under glass. In the long run glass sashes are cheaper than cloth and will make better crops. After the middle of the month sow seed of the Early Jersey Wakefield Cabbage for transplanting later for the early crop in the Spring. Plant sets of the Yellow Potato Onion and the White Pearl in heavily fertilized rows 15 in. apart. The Pearl will make bunching green Onions in February and March, and later the offsets from the Potato Onion can be used for bunching, and the main bulbs left to ripen in early June. In the

lower South seed of The Prizetaker and Giant Gibraltar Onion can be sown for transplanting later, and the Bermuda Onions likewise.

Seed of the Hanson and New York Lettuce sown after the middle of the month can be later transplanted along with the early Cabbages for wintering over and heading in Spring. The Big Boston is best for the frames, but if wintered outside is apt to run to seed instead of heading in Spring. The Comparatively new Copenhagen Market Cabbage is a fine sort to sow in a cold frame in January to set as a succession to the Early Wakefield, but it will not do to sow early and Winter over outside, as it will invariably run to seed instead of heading.

Sow the main crop of Purple Top Globe Turnips and the Yellow Aberdeen. Make another sowing of Spinach the middle of the month and a sowing the last of the month to Winter over for Spring cutting or late Winter. Sow Parsley seed early in the month for Winter and Spring use. Sow more Norfolk Kale for Winter use. Sow Winter Radishes for the Winter.

OCTOBER

The Flat Strap-leaf Turnips may still be sown. Sow the Seven Top Turnips for wintering over for Spring greens. Transplant Lettuce in 6 ft. beds 10 in. apart each way early in the month, and later set plants in the frames, but use no protection till the nights grow frosty. If, by reason of favorable weather, the Early Cabbages sown in September tend to get overgrown, it is always best to sow more the first of October, as the overgrown plants will be more likely to run to seed in the Spring than plants of only good size. Early in the month make another sowing of Spinach as the last sowing in September may get overgrown in favorable weather and the later sowing will be best for late Winter and early Spring. Plant Onion sets if not done in September.

NOVEMBER

Prepare the land for setting Cabbage and Lettuce plants for Spring heading. Run out furrows east and west, and in these use high grade commercial fertilizer, or fill half full of well rotted stable manure with a good application of acid phosphate on it. Then bed on this by throwing a furrow from each side. Then, with a shovel, plow open a furrow down the crest of this ridge, and in this set the plants deep enough to cover the stems. Set the Cabbage plants 16 in. apart and set a Lettuce plant between each Cabbage plant. Setting in an open furrow is better than the old method of setting on the south side of the beds, where the plants are exposed to the morning sun when frozen, and are also apt to grow tender in the warm spells. November is the best time in the whole year for setting Strawberry plants. Plants set

now will make some Fall growth and will make a fair crop of fruit in the Spring. November is the only safe time to prune the Scuppernong Grape Vines and others of the rotundifolia class. Cut out dead and stunted wood and train out the long one year and two year canes, for this class of Grapes, fruits on two-year wood. On the other hand the bunch Grapes, such as are grown in the North, should not be pruned till just before the buds swell in the Spring. Spinach can be sown in lower South.

DECEMBER

In lower South plant early Irish Potatoes latter part of the month. Turn the late Cabbages over where they grew with heads to the North. Then bank the soil over the stem and lower part of the head leaving the top exposed but sheltered from the morning sun. Those not well headed will continue to head. Collards treated in this way will blanch nicely. Leave late Beets, Carrots, Parsnips, Salsify and Leeks in rows where they grew, and lift as needed.

INDEX TO CONTENTS

	Page		Page
Alpine Gardens	119	Naturalizing	106
Alpine Plants, List of Suitable	65- 67	Planting Diagram	111
Annuals and Biennials	91	Preparation of Beds	105
Annuals:		Time of Planting	105
Climbing	94	Cabbages	162
Combinations of	94	Canna, the	74- 77
Foliage	100	Canning of Fruits and Vegetables	181
For Edging	100	Carrots	162
For Keeping Seed Pods Removed	94	Cauliflowers	163
Lesser Known	97	Celery	163
Soil for	91- 93	Chrysanthemums, Hardy	82- 84
Sowing	91, 93, 203	City Gardens, Planting and Cropping of	154, 159, 161
Transplanting	93	Climbers, Trees and Shrubs	44- 47
Apples	132	Coldframes, Management of	224
Arches, Rose Trellised	127	Color Combinations of Hardy Plants	67- 68
Arsenate of Lead Paste	133-195	Corn	165
Asparagus, Cultivation of	158	Crocuses	104-106
Backyard Gardens, Types of	12, 13, 32, 107, 154	Cropping Tables	159-160
Beans, Cultivation of	158	Crown Imperials	108
Beds and Plans for Planting	67- 68	Cucumbers	165
Beetroot	162	Currants	143
Benches, Garden	123	Cut Flowers, Useful	97
Berried Shrubs	40	Cuttings from Leaves	201
Biennials and Annuals	91, 101	Cuttings:	
Birds:		Hardwood and Softwood	200
Berry Bearing Shrubs and Trees for	234	Of Perennials	201
Food for	233	Crocuses in the Grass	104
In the Garden	228	Cultivators, Palnet, Jr	170
Blackberries	146	hand	239
Bordeaux Mixture as a Fungicide	196	Cutworms	195
Borders:		Daffodil Flower, a	108
Hardy Perennial	61	Dahlia, Cultivation of the	76- 82
Of Various Colored Combinations	67- 68	Dahlia Root for Propagation	201
Borers	194	Delphiniums from Seed	96
Bridge, Rustic	125	Device for Hoisting a Barrel	239
Brussels Sprouts	162	Digging and Preparing Soil	149
Budding	208	Diseases and Insect Pests of Vegetables	156
Bulbs and Tuberous-Rooted Plants	105	Diseases of Plants	195
Bulbs:		Division of Herbaceous Perennials	202
Alphabetical List of	106	Dove Cote	124
General Culture	106	Drives	12
Mulching after Planting	107	Edging Plants	42, 100
		Egg-plant	166
		Emulsions as Sprays	194

	Page		Page
Endive.....	167	Laying Out the.....	11
Enemies of Plants.....	193	Tools.....	237
Eremurus.....	107	Germination Table.....	102
Evergreen Shrubs.....	40	Gladiolus, the.....	69
Evergreens.....	34	Glory of the Snow.....	106
Pruning.....	189	Gooseberries.....	144
Everlastings.....	97	Grafting.....	206
Exposure of the House in Rela- tion to the Sun.....	14	Grape Hyacinth.....	111
Fences and Hedges.....	13, 17, 30	Grapes.....	140
Ferns:		Grass Plots and Lawns.....	18
From Spores.....	204	Grass:	
Hardy Garden.....	115	Mowing.....	20
Fertilizers and Manure for the Garden.....	150	Rolling, Weeding, Turfing... ..	21
Flower Borders, Hardy.....	61	Sowing.....	19
Flower Seeds, Germination of.....	102	Grasses.....	97
Flower, Section of a Typical... ..	206	Greenhouses, Hotbeds and Frames.....	217
Flowers:		Grounds, Home, Planning.....	11
A Few of Everybody's Fa- vorites.....	69	Hand Cultivator, a.....	239
Annual, Combinations of....	94	Hardy Flowers:	
Everlasting.....	96	Among the.....	58
Hardy, List of Thirty Indis- pensable, General Selection of.....	65-68	Cultivation.....	62
Hardy, Autumn and Spring Planting.....	62	Lists of.....	65-68
Hardy, Various Color Com- binations.....	67	Necessity for Replanting....	64
Old and New Methods of Ar- ranging.....	240	Removing the Seed Pods of..	64
Useful for Cutting.....	97	Staking.....	64
Flowering the Branches of Shrubs Indoors.....	44	Watering.....	64
Foliage Annuals.....	100	Hardy Plant Borders.....	61
Fountains.....	127	Harvesting and Storing Vege- tables.....	156
Frame Barrow for Leaves and Grass.....	239	Heating a Small Greenhouse... ..	220
Frame for Winter Protection... ..	199	Hedges and Fences.....	13-17-30
Frames and Hotbeds.....	217-225	Hedges, Pruning.....	188
Fritillaria.....	108	Hellebore Powder.....	195
Fruit:		Herbs.....	167
Canning, Time Table for....	182	Hoe, Planet Jr.....	169
For the Garden.....	123, 131	Hoes, Different Types of.....	170
Storage Box for.....	239	Home Grounds, Planning.....	11
Trees, Pruning.....	189	Horse-Radish.....	168
Fungicides.....	133, 195	Hose Pipe, Device for Winding... ..	239
Galtonia candicans.....	108	Hotbed:	
Garden:		Planting a.....	161, 222
Birds in the.....	228	Management of.....	224
Furniture.....	123	Planting a.....	161
House.....	124	Preparation of.....	223
		Hotbeds and Frames.....	217
		House:	
		Methods of Planting Around the.....	15
		Best Position for with Refer- ence to the Sun.....	14
		Hyacinths.....	108
		Immortelles.....	97

	Page		Page
Insecticides	133, 134, 194	Division of	202
Insect Pests of Plants	193	List of Thirty Indispensable, General List of	65
Insects and Diseases of Vegetables	156	Necessity for Replanting	64
Introduction to Garden Guide	9	Sowing	203
Iris	84- 88	Pergola Covered with Vines	130
English and Spanish	109	Pergola, a Rustic	54
Irrigation	153	Pests:	
Jerusalem Artichoke	201	Insect	193
Kale, or Borecole	168	Means of Controlling	194
Kohl-Rabi	169	Planning the Home Grounds	11
Lattice Screens	20, 21, 123, 212	Plans of gardens:	12, 13, 23, 25-29, 107-154
Lawn:		Plant forcer	226
Beaters	237	Plant Propagation	200
Plantings	33	Plants:	
Seed Mixtures	18	Enemies of	193
View of a	19	For edging	100
Lawns and Grass Plots	18	Tuberous-Rooted	105
Layering	209-210	Planting:	
Leaf Cuttings	201	Hardy Flowers	62
Leeks	169	Plans	22- 29
Lettuces	169	Plans to Insure Best Effect of Shade, Outlook, Protection, Privacy	15
Lilies, Hardy	110	Schemes for Hardy Plants	67- 68
Lily of the Valley	109	Trees	36
Lime Sulphur Spray	194	Plums	137
Loganberry, the	146	Pond with Water Lilies	113
Manures and Fertilizers for the Garden	150	Porch Plants and Window Boxes	211
Mats, Straw or Reed	198	Potatoes	174
Melons	170	Privacy, Planting for	15
Mowing	20	Propagation of Plants	200
Mustard	171	Protection:	
Names of Flowers, Common and Botanical	102	In Winter	197
Narcissi	112	Planting for	15
Naturalizing Bulbs	106	Pruning	185-186
Nest Boxes	230, 232	Table for Shrubs and fruits	189-192
Nursery Stock, Difference Between This and Material from the Wilds	47	Publisher's Foreword	7
Okra	171	Pumpkins	175
Onions	171-173	Pyrethrum Powder	195
Parsley	173	Radishes	176
Parsnips	173	Raspberries	145
Paths	12- 17	Red Currants	143
Pavilion, a Rustic	127	Rhubarb	176
Peaches	139	Rock Garden, The, 118, 119, 121, 122	
Pears	136	Rock Garden:	
Peas, Culinary	173	Construction	120
Peony, the	63, 70, 71, 73	Material for	121
Perennials:		Plants for	121
Hardy, Combinations of	58	Roller, a Garden	236
Cuttings of	201	Rolling	21

	Page		Page
Root Cuttings.....	202	Spinach.....	179
Rose Garden, the.....	49	Sprayer:	
Roses.....	49	An Efficient Barrel.....	145
Roses:		A Vaporizer.....	194
Beds for.....	53	Spraying:	
Climbing.....	50	Gooseberries.....	144
Diseases Injurious to.....	57	Peaches.....	140
Hybrid Perpetual.....	50	Squash.....	179
Hybrid Tea.....	52	Sterilization in Fruit and Vege-	
Insects Injurious to.....	55	table Canning.....	182
Preparation of Soil for.....	53	Storage Box for Fruit.....	239
Pruning.....	185	Strawberries.....	141
Summer Treatment of.....	55	Street Trees.....	35
Tea.....	50	Sub-Tropical Plants.....	41
Time to Plant.....	53	Suburban Gardens.....	12, 23, 37
Rustic Arches, Bridges, Seats,		Sulphur as a Fungicide.....	196
etc.....	123-129	Sulphuric Acid and Water as a	
Rutabaga.....	176	Spray.....	144
Salads.....	165	Summer House, a.....	124, 127
Salsify.....	177	Sugar Corn.....	165, 180
Sawing off Level, Method of.....	237	Summer Hyacinth.....	108
Scillas.....	113	Sun in Relation to the House... 14	
Sea-Kale.....	177	Supports, Pea and Bean... 237-238	
Screen for Side of House.....	57	Sweet Peas.....	88- 90
Seeds:		Swiss Chard.....	164
Flower, Germination of.....	102	Syringing and Spraying.....	194
Of Flowers Sown Indoors.....	203	Terrace Garden, Well Planted.. 30	
Of Perennials and Annuals,		Tomatoes.....	179
Sowing.....	203	Tomatoes, Pepper, and Egg-	
Seats, Garden, Rustic.....	125, 129	plants.....	153
Shade, Planting for.....	15	Tools:	
Shading, Method of.....	236	Average cost of.....	240
Shrubs and Trees for Gardens... 22, 24, 26, 33		Dibbers, types of.....	169
Shrubs:		For the Garden.....	237
Evergreen.....	40	Hand-Cultivator.....	239
For Cover Planting.....	41	Hand Pump, Spray Engine.. 195	
For Forcing.....	44	Hoe, Planet Jr.....	169
For Wet Places.....	42	Hoes, types of.....	170
Low Growing.....	42	Garden Steps.....	239
Pruning.....	187	Labels.....	236
Some of the Best.....	38	Lawn Beater.....	237
Trees and Climbers.....	44- 47	Marker for vegetable gar-	
With Edible Berries.....	40	den.....	165
Slugs.....	195	Pea and Bean Supports.....	238
Snowdrops.....	108	Secateurs.....	192
Soil:		Syringes.....	194
Digging or Plowing.....	149	Vaporizing Sprayers.....	194
For Hardy Plants.....	61	Watering Can.....	239
Soap Solutions.....	194	Wheelbarrow.....	239
Sowing and Planting Table for		Tree and Shrub Seeds.....	205
Vegetables.....	157	Tree Guard.....	236
Sowing Annuals.....	91- 93	Trees and Shrubs for Gardens.. 22, 24, 26, 33	

	Page		Page
Trees:-		Vegetables and Fruits, Canning	
For Streets.....	35	of.....	181, 183
Planting.....	36	Vegetables, Sowing and Planting	
Shrubs and Climbers, List of		Table.....	157
Blooming Dates of.....	44	Vines, Grape, Pruning.....	141
Trellises and Screens. 20, 21, 125, 212		Water Cress.....	180
Tuberous-Rooted Plants.....	105	Watering and Irrigation.....	153
Tulips.....	113	Water Lilies.....	113
Turfing Lawns.....	21	Watermelons.....	170
Turnips.....	180	Water plants.....	116-117
Vegetable Garden.....		Weeding Lawns.....	21
147, 149, 150, 152, 155		Wet Places, Shrubs for.....	42
Vegetable Garden:		Window Boxes and Porch Plants.....	211
Cropping a City.....	159-161	Window Boxes:	
Digging and Preparing Soil in.....	149	Plants for.....	213-216
General Cultivation of.....	155	Self Watering.....	212
Growing Plants for Setting		Winter Aconite.....	107
Out in.....	148	Winter:	
Harvesting and Storing from.....	156	Protection.....	197
Insects and Diseases in.....	156	Protection, Frame for.....	199
Manure and Fertilizer for... ..	150	Workmen's Dwellings.....	16, 31
Planting and Transplanting in.....	151	Workmen's Dwellings and Small	
Watering in.....	153	Gardens.....	12, 13, 107, 154
Vegetable Marrows.....	180		

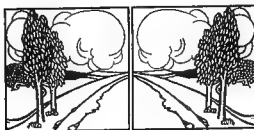

PRACTICAL LANDSCAPE GARDENING

By ROBT. B. CRIDLAND



JUST the book for those interested in beautiful home grounds, Owners of Suburban Homes, Flower and Garden Lovers, Florists and Nurserymen, Park Commissioners, Civic Officials, and Students of Landscape Architecture will find help and inspiration within its covers. The author is a practical landscape architect of more than twenty years' experience and of national reputation. He takes up in a simple, logical way all the elements that enter into the beautifying of properties, starting with the locating and placing of the house or building, and leading the reader up by easy stages through the subsequent steps necessary to create a pleasing whole.

The book should appeal particularly to the owner of the moderate sized suburban home. Its pages are a revelation as to the ease with which so much that is charming and durable can be acquired. Many plans and planting keys are given for laying out and

planting, along artistic lines, properties on lots of 50x100; 50x150; 75x200; 100x200, and on up to an acre or more.

Practical Landscape Gardening is an entirely different book from any landscape treatise previously written, because it fits into your wants, considers practicability equally with the laws of art and beauty, and covers every detail. It contains 91 photographic illustrations, 67 sketches and 29 plans, 19 of which are planting plans accompanied by planting keys.

The type is large and clear; the paper is enamel; the illustrations practical and a feast to the eye; the binding durable. The color plate on front cover is irresistibly attractive; it portrays a wonderful landscape scene. 276 pages. Size, 6x8 in. Prospectus on application. Price, delivery postpaid..... **\$1.65**

A. T. DE LA MARE COMPANY, Inc.

438 to 448 West 37th Street, NEW YORK, N. Y.

