

MARKET DAIRYING

AND MILK PRODUCTS

MICHELS

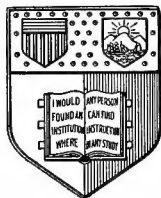

DEPT. OF DAIRY INDUSTRY
CORNELL UNIVERSITY
ITHACA, N. Y.

Library

rsity Library

ST 499.m33

Market dairying and milk products,



3 1924 003 022 716

mann

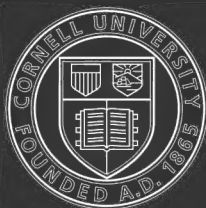

Cornell University
Library

The original of this book is in
the Cornell University Library.

There are no known copyright restrictions in
the United States on the use of the text.

<http://www.archive.org/details/cu31924003022716>

Market Dairying

and Milk Products

BY

JOHN MICHELS, B. S. A., M. S.

Professor of Dairying and Animal Husbandry in the Milwaukee
County (Wis.) School of Agriculture and
Domestic Economy

Author of "Creamery Butter-Making" and
"Dairy Farming"

SECOND EDITION, REVISED AND ENLARGED

ILLUSTRATED

WAUWATOSA, WISCONSIN
PUBLISHED BY THE AUTHOR
1912

All Rights Reserved

@ 720,194

COPYRIGHT, BY
JOHN MICHELS
1909 and 1912



PREFACE.

Dairy instruction has hitherto been confined chiefly to the economical production of milk and the manufacture of butter and cheese. Yet those who have thoroughly studied the subject must admit that market dairying deserves fully as much attention as either the economical production of milk or the manufacture of butter or cheese.

The subject of market dairying presents two very important aspects: One is to educate dairymen to produce better and more wholesome milk; the other is to instruct them in all the economies relating to their business so as to insure maximum financial returns.

For a number of years the author has been brought face to face with the problems relating to market dairying. He has been actively engaged in the production and marketing of sanitary milk and cream, and in the manufacture and marketing of ice cream, cottage cheese, and skimmilk-buttermilk. The markets and dairy conditions of the country have been thoroughly investigated and new methods and plans have been developed, some of which have already been published in bulletin form or otherwise.

The production of this volume is, therefore, largely the result of the knowledge and experience thus gained, and the realization of the urgent and increasing needs along this line of dairying. An attempt has been made to so arrange the material that it might answer the needs of both the classroom and the dairyman who cannot attend a dairy school.

JOHN MICHELS.

April 1, 1909.

PREFACE TO SECOND EDITION.

In preparing the second edition of *Market Dairying*, an attempt has been made to cover the entire subject of market milk as completely as possible, and to include instruction in the various side-lines which milk dealers may engage in at considerable profit. The subjects of butter and cheese making have also been accorded considerable space in order to satisfy the needs of those who are looking for information not only on the subject of milk but on the manufacture and handling of the common milk products as well.

Practically every chapter has been revised and amplified. This, together with the addition of fifteen new chapters, has nearly doubled the number of pages found in the first edition.

The constant aim in the present revision has been to adapt the book for class instruction, but it is believed that the scope and treatment will also justify its use as a reference book by all milk dealers as well as butter and cheese makers.

TABLE OF CONTENTS.

	Page.
Chapter	I. Chemical and Physical Properties of Milk 7
Chapter	II. Bacteria and Milk Fermentations..... 20
Chapter	III. Sanitary Milk Production..... 29
Chapter	IV. Cooling and Aeration of Milk..... 39
Chapter	V. The Babcock Test..... 48
Chapter	VI. Composite Sampling 59
Chapter	VII. Sampling and Testing Cream..... 65
Chapter	VIII. The Lactometer and Its Use..... 75
Chapter	IX. Acid Tests for Milk and Cream..... 83
Chapter	X. Creaming 90
Chapter	XI. Cold Storage 97
Chapter	XII. Pasteurization 104
Chapter	XIII. How to Secure a Good Market..... 117
Chapter	XIV. Marketing Milk and Cream..... 121
Chapter	XV. Profitable Side-Lines 132
Chapter	XVI. Starters or Lactic Acid Cultures..... 135
Chapter	XVII. Cultured Milk 147
Chapter	XVIII. Skimmilk-Buttermilk 154
Chapter	XIX. Ice Cream Making..... 157
Chapter	XX. Modified Milk 170
Chapter	XXI. Soft and Fancy Cheese Making..... 175
Chapter	XXII. Certified Milk 183
Chapter	XXIII. Relative Value of Milk and Its Products 186
Chapter	XXIV. Detection of Tainted Milk and Cream.. 190
Chapter	XXV. Detection of Preservatives and Dirt... 195
Chapter	XXVI. Judging Milk and Its Products..... 200
Chapter	XXVII. Buying and Selling on the Butterfat Basis 211
Chapter	XXVIII. The Care of Milk in the Home..... 216
Chapter	XXIX. Keeping Accounts 220
Chapter	XXX. Control of City Milk Supply..... 226
Chapter	XXXI. Buttermaking 239
Chapter	XXXII. Marketing Butter and Cheese..... 263

TABLE OF CONTENTS

	Page.
Chapter XXXIII. Butter Overrun	274
Chapter XXXIV. Cheddar Cheese Making	278
Chapter XXXV. Creamery and Factory Dividends.....	287
Chapter XXXVI. Mechanical Refrigeration	296
Chapter XXXVII. Washing and Sterilizing Milk Vessels..	306
Chapter XXXVIII. Dairy Houses	312
Chapter XXXIX. City Milk and Ice Cream Plants.....	320
Chapter XL. Boiler and Its Management.....	326
Chapter XLI. Water and Ice Supply.....	337
Chapter XLII. Sewage Disposal	343
Appendix	349
Index	369

MARKET DAIRYING.

CHAPTER I.

CHEMICAL AND PHYSICAL PROPERTIES OF MILK.

Milk, in a broad sense, may be defined as the normal secretion of the mammary glands of animals that suckle their young. It is the only food found in Nature containing all the elements necessary to sustain life. Moreover it contains these elements in the proper proportions and in easily digestible and assimilable form.

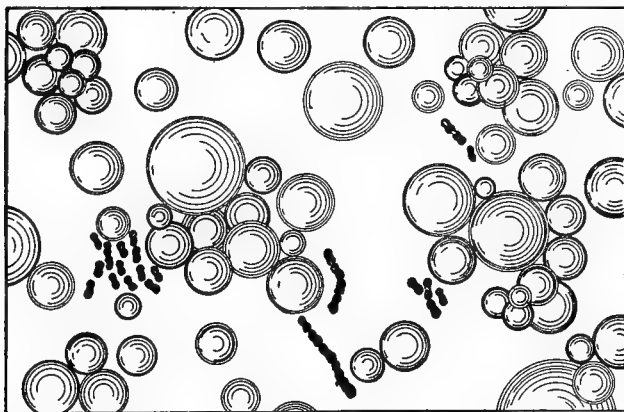

Microscopic appearance of milk showing relative size of fat globules and bacteria.—Russell's Dairy Bacteriology.

Physical Properties. Milk is a whitish opaque fluid possessing a sweetish taste and a faint odor suggestive of cows' breath. It has an amphioteric reaction, that is,

it is both acid and alkaline. This double reaction is due largely to acid and alkaline salts and possibly to small quantities of organic acids.

Milk has an average normal specific gravity of 1.032, with extremes rarely exceeding 1.029 and 1.033. After standing a few moments it loses its homogenous character. Evidence of this we have in the "rising of the cream." This is due to the fact that milk is not a perfect solution but an *emulsion*. All of the fat, the larger portion of the casein, and part of the ash are in suspension.

In consistency milk is slightly more viscous than water, the viscosity increasing with the decrease in temperature. It is also exceedingly sensitive to odors, possessing great absorption properties. This teaches the necessity of placing milk in clean pure surroundings.

Chemical Composition. The composition of milk is very complex and variable, as will be seen from the following figures:

Average Composition of Normal Milk. A compilation of figures from various American Experiment Stations.

Water	87.1%
Butter fat	3.9%
Casein	2.9%
Albumen5%
Sugar	4.9%
Ash7%
Fibrin	Trace.
Galactase	Trace.
	<hr/>
	100.0%

The great variations in the composition of milk are shown by the figures from Koenig, given below:

	<i>Maximum.</i>	<i>Minimum.</i>
Water	90.69	80.32
Fat	6.47	1.67
Casein	4.23	1.79
Albumen	1.44	.25
Sugar	6.03	2.11
Ash	1.21	.35

These figures represent quite accurately the maximum and minimum composition of milk except that the maximum for fat is too low. The author has known cows to yield milk testing 7.6% fat, and records show tests even higher than this.

BUTTER FAT.

This is the most valuable as well as the most variable constituent of milk. It constitutes about 83% of butter and is an indispensable constituent of the many kinds of whole milk cheese now found upon the market. It also measures the commercial value of milk and cream, and is used as an index of the value of milk for butter and cheese production.

Physical Properties. Butter fat is suspended in milk in the form of extremely small globules numbering about 100,000,000 per drop of milk. These globules vary considerably in size in any given sample, some being five times as large as others. The size of the globules is affected mostly by the period of lactation. As a rule the size decreases and the number increases with the advance of the period. In strippers' milk the globules are sometimes so small as to render an efficient separation of the cream and the churning of same impossible.

The size of the fat globules also varies with different breeds. In the Jersey breed the diameter of the globule

is one eight-thousandth of an inch, in the Holstein one twelve-thousandth, while the average for all breeds is about one ten-thousandth.

Night's milk usually has smaller globules than morning's. The size of the globules also decreases with the age of the cow.

The density or specific gravity of butter fat at 100° F. is .91 and is quite constant. Its melting point varies between wide limits, the average being 92° F.

Composition of Butter Fat. According to Richmond, butter fat has the following composition:

Butyric	3.85	} Soluble or volatile.
Caproic	3.60	
Caprylic55	
Capric	1.90	} Insoluble or non-volatile.
Lauric	7.40	
Myristic	20.20	
Palmitic	25.70	
Stearic	1.80	
Olein, etc.....	35.00	

This shows butter fat to be composed of no less than nine distinct fats, which are formed by the union of glycerine with the corresponding fatty acids. Thus, butyric is a compound of glycerine and butyric acid; palmitic, a compound of glycerine and palmitic acid, etc. The most important of these acids are palmitic, oleic, and butyric.

Palmitic acid is insoluble, melts at 144° F., and forms (with stearic acid) the basis of hard fats.

Oleic acid is insoluble, melts at 57° F., and forms the basis of soft fats.

Butyric acid is soluble and is a liquid which solidifies at -2° F. and melts again at 28° F.

Insoluble Fats. A study of these fats is essential in elucidating the variability of the churning temperature of cream. As a rule this is largely determined by the relative amounts of hard and soft fats present in butter fat. Other conditions the same, the harder the fat the higher the churning temperature. Scarcely any two milks contain exactly the same relative amounts of hard and soft fats, and it is for this reason that the churning temperature is such a variable one.

The relative amounts of hard and soft fats are influenced by:

1. Breeds.
2. Feeds.
3. Period of lactation.
4. Individuality of cows.

The butter fat of Jerseys is harder than that of Holsteins and, therefore, requires a relatively high churning temperature, the difference being about six degrees.

Feeds have an important influence upon the character of the butter fat. Cotton seed meal and bran, for example, materially increase the percentage of hard fats. Gluten feeds and linseed meal, on the other hand, produce a soft butter fat.

With the advance of the period of lactation the percentage of hard fat increases. This chemical change, together with the physical change which butter fat undergoes, makes churning difficult in the late period of lactation.

The individuality of the cow also to a great extent influences the character of the butter fat. It is inherent

in some cows to produce a soft butter fat, in others to produce a hard butter fat, even in cows of the same breed.

Soluble Fats. The soluble or volatile fats, of which butyric is the most important, give milk and sweet cream butter their characteristic flavors. Butyric is found only in butter fat and distinguishes this from all vegetable and other animal fats.

The percentage of soluble fats decreases with the period of lactation, also with the feeding of dry feeds and those rich in protein. Succulent feeds and those rich in carbohydrates, according to experiments made in Holland and elsewhere, increase the percentage of soluble fats. This may partly account for the superiority of the flavor of June butter.

It may be proper, also, to discuss under volatile or soluble fats those abnormal flavors that are imparted to milk, cream, and butter by weeds like garlic and wild onions, and by various feeds such as beet tops, rape, partially spoiled silage, etc. These flavors are undoubtedly due to abnormal volatile fats.

Cows should never be fed strong flavored feeds shortly before milking. When this is done the odors are sure to be transmitted to the milk and the products therefrom. When, however, feeds of this kind are fed shortly after milking no bad effects will be noticed at the next milking.

Albumenoids. These are nitrogenous compounds which give milk its high dietetic value. Casein, albumen, globulin and nuclein form the albumenoids of milk, the casein and albumen being by far the most important.

Casein. This is a white colloidal substance, possessing neither taste nor smell. It is the most important tissue-forming constituent of milk and forms the basis of an almost endless variety of cheese.

The larger portion of the casein is suspended in milk in an extremely finely divided amorphous condition. It is intimately associated with the insoluble calcium phosphate of milk and possibly held in chemical combination with this. Its study presents many difficulties, which leaves its exact composition still undetermined.

Casein is easily precipitated by means of rennet extract and dilute acids, but the resulting precipitates are not identically the same. It is not coagulated by heat.

Albumen. In composition albumen very closely resembles casein, differing from this only in not containing sulphur. It is soluble and unaffected by rennet, which causes most of it to pass into the whey in the manufacture of cheese. It is coagulated at a temperature of 170° F. It is in their behavior toward heat and rennet that casein and albumen radically differ.

Milk Sugar. This sugar, commonly called lactose, has the same chemical composition as cane sugar, differing from it chiefly in possessing only a faint sweetish taste. It readily changes into lactic acid when acted upon by the lactic acid bacteria. This causes the ordinary phenomenon of milk souring. The maximum amount of acid in milk rarely exceeds .9%, the germs usually being checked or killed before this amount is formed. There is therefore always a large portion of the sugar left in sour milk. All of the milk sugar is in solution.

Ash. Most of the ash of milk exists in solution. It is composed of lime, magnesia, potash, soda, phosphoric acid, chlorine, and iron, the soluble lime being the most important constituent. It is upon this that the action of rennet extract is dependent. For when milk is heated to high temperatures the soluble lime is rendered insoluble and rennet will no longer curdle milk. It seems also that

the viscosity of milk and cream is largely due to soluble lime salts. Cream heated to high temperatures loses its viscosity to such an extent that it can not be made to "whip." Treatment with soluble lime restores its original viscosity. The ash is the least variable constituent of milk.

Colostrum Milk. This is the first milk drawn after parturition. It is characterized by its peculiar odor, yellow color, broken down cells, and high content of albumen which gives it its viscous, slimy appearance and causes it to coagulate on application of heat.

According to Eugling the average composition of colostrum milk is as follows:

Water	71.69%
Fat	3.37
Casein	4.83
Albumen	15.85
Sugar	2.48
Ash	1.78

The secretion of colostrum milk is of very short duration. Usually within four or five days after calving it assumes all the properties of normal milk. In some cases, however, it does not become normal till the sixth or even the tenth day, depending largely upon the condition of the animal.

A good criterion in the detection of colostrum milk is its peculiar color, odor, and slimy appearance. The disappearance of these characteristics determines its fitness for butter production.

Milk Secretion. Just how all of the different constituents of milk are secreted is not yet definitely understood. But it is known that the secretion takes

place in the udder of the cow, and principally during the process of milking. Further, the entire process of milk elaboration seems to be under the control of the nervous system of the cow. This accounts for the changes in flow and richness of milk whenever cows are subjected to abnormal treatment. It is well known that a change of milkers, the use of rough language, or the abuse of cows with dogs and milk stools, seriously affects the production of milk and butter fat. It is therefore of the greatest practical importance to milk producers to treat cows as gently as possible, especially during the process of milking.

How Secreted. The source from which the milk constituents are elaborated is the blood. It must not be supposed, however, that all the different constituents already exist in the blood in the form in which we find them in milk, for the blood is practically free from fat, casein, and milk sugar. These substances must then be formed in the cells of the udder from material supplied them by the blood. Thus there are in the udder cells that have the power of secreting fat in a manner similar to that by which the gastric juice is secreted in the stomach. Similarly, the formation of lactose is the result of the action of another set of cells whose function is to produce lactose. It is believed that the casein is formed from the albumen through the activity of certain other cells. The water, albumen, and soluble ash probably pass directly from the blood into the milk ducts by the process known as osmosis.

Variations in the Quality of Milk. Milk from different sources may vary considerably in composition, particularly in the percentage of butter fat. Even the

milk from the same cow may vary a great deal in composition. The causes of these variations may be assigned to two sets of conditions: I.—Those natural to the cow. II.—Those of an artificial nature.

I. QUALITY OF MILK AS AFFECTED BY NATURAL CONDITIONS.

1. The composition of the milk of all cows undergoes a change with the advance of the period of lactation. During the first five months the composition remains practically the same. After this, however, the milk becomes gradually richer until the cow "dries up." The following figures from Van Slyke illustrate this change:

<i>Month of lactation.</i>	<i>Per cent of fat in milk.</i>
1.....	4.54
2.....	4.33
3.....	4.28
4.....	4.39
5.....	4.38
6.....	4.53
7.....	4.56
8.....	4.66
9.....	4.79
10.....	5.00

It will be noticed from these figures that the milk actually decreases somewhat in richness during the first three months of the period. But just before the cow dries up, it may test as high as 8%.

2. The quality of milk also differs with different breeds. Yet breed differences are less marked than those of the individual cows of any particular breed.

Some breeds produce rich milk, others relatively poor

milk. The following data obtained at the New Jersey Experiment Station illustrates these differences:

Breed.	Total Solids.	Fat.	Milk Sugar.	Proteids.	Ash.
	Per cent.	Per cent.	Per cent.	Per cent.	Per cent.
Ayshire.....	12.70	3.68	4.84	3.48	.69
Guernsey	14.48	5.02	4.80	3.92	.75
Holstein	12.12	3.51	4.69	3.28	.64
Jersey.....	14.34	4.78	4.85	3.96	.75

3. Extremes in the composition of milk are usually to be ascribed to the individuality or "make up" of the cow. It is inherent in some cows to produce rich milk, in others to produce poor milk. In other words, Nature has made every cow to produce milk of a given richness, which can not be perceptibly changed except by careful selection and breeding for a number of generations.

II. QUALITY OF MILK AS AFFECTED BY ARTIFICIAL CONDITIONS.

1. When cows are only partially milked they yield poorer milk than when milked clean. This is largely explained by the fact that the first drawn milk is always poorer in fat than that drawn last. Fore milk may test as low as .8%, while the strippings sometimes test as high as 14%.

2. Fast milking increases both the quality and the quantity of the milk. It is for this reason that fast milkers are so much preferred to slow ones.

3. The richness of milk is also influenced by the length of time that elapses between the milkings. In general, the shorter the time between the milkings the richer the milk. This, no doubt, in a large measure accounts for the differences we often find in the richness of morning's and night's milk. Sometimes the morning's milk is the richer, at other times the evening's; depending largely upon the time of day the cows are milked. Milk can not, however, be permanently enriched by milking three times instead of twice a day.

4. Unusual excitement of any kind reduces the quality of milk. The person who abuses cows by dogs, milk stools, or boisterousness, pays dearly for it in a reduction of both the quality and the quantity of milk produced.

5. Starvation also seriously affects both the quality and the quantity of milk. It has been repeatedly shown, in this country and in Europe, that under-feeding to any great extent results in the production of milk poor in fat.

6. Sudden changes of feed may slightly affect the richness of milk, but only temporarily.

So long as cows are fed a full ration, it is not possible to change the richness of milk permanently, no matter what the character of feed composing the ration.

7. Irregularities of feeding and milking, exposure to heat, cold, rain, and flies, tend to reduce both the quantity and the quality of milk produced.

a. Skim milk.

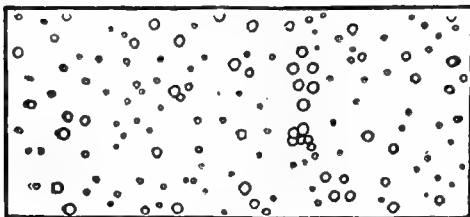

b. Milk.

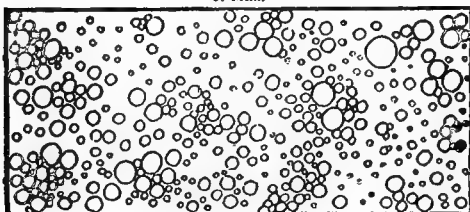

c. Cream.

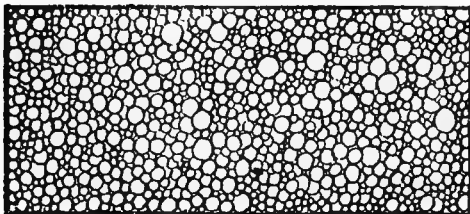

d. Colostrum.

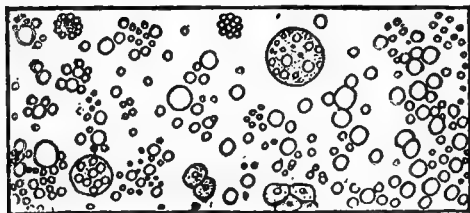

Fat globules magnified 300 times. (U. S. Farmers' Bulletin 42.)

CHAPTER II.

BACTERIA AND MILK FERMENTATIONS.

A thorough knowledge of bacteria and their relation to milk and milk products forms the basis of success in the handling of milk and cream as well as in butter and cheese making. Much attention will therefore be given to the study of these organisms in this work.

I. BACTERIA.

The term bacteria is applied to the smallest of living plants, which can be seen only under the highest powers of the microscope. Each bacterium is made up of a single cell. These plants are so small that it would require 30,000 of them laid side by side to measure an inch. Their presence is almost universal, being found in the air, water and soil; in cold, hot and temperate climates; and in living and dead as well as inorganic matter.

Bacteria grow with marvelous rapidity. A single bacterium is capable of reproducing itself a million times in twenty-four hours. They reproduce either by a simple division of the mother cell, thus producing two new cells, or by spore formation in which case the contents of the mother cell are formed into a round mass called a spore. These spores have the power of withstanding unfavorable conditions to a remarkable extent, some being able to endure a temperature of 212° F. for several hours.

Most bacteria require for best growth a moist, warm and nutritious medium such as is furnished by milk, in

which an exceedingly varied and active life is possible.

In nature and in many of the arts and industries, bacteria are of the greatest utility, if not indispensable. They play a most important part in the disintegration of vegetable and animal matter, resolving compounds into their elemental constituents in which form they can again be built up and used as plant food. In the art of butter and cheese making bacteria are indispensable. The tobacco, tanning, and a host of other industries cannot flourish without them.

II. MILK FERMENTATIONS.

Definition. In defining fermentation processes, Conn says that, "In general, they are progressive chemical changes taking place under the influence of certain organic substances which are present in very small quantity in the fermenting mass."

With few exceptions, milk fermentations are the result of the growth and multiplication of various classes of bacteria. The souring of milk illustrates a typical fermentation, which is caused by the action of lactic acid bacteria upon the milk sugar breaking it up into lactic acid. Here the chemical change is conversion of sugar into lactic acid.

The most common fermentations of milk are the following:

Milk Fermentations	{ Normal... { Abnormal... {	Lactic.
		Curdling and Digesting.
		Butyric.
		Bitter.
		Slimy or Ropy.
		Gassy.
		Toxic.
		Chromogenic.

NORMAL FERMENTATIONS.

We speak of normal fermentations because milk always contains certain classes of bacteria even when drawn and kept under cleanly conditions. These fermentations will be discussed in the following pages.

I. LACTIC FERMENTATION.

This is the most common and by far the most important fermentation of milk. Indeed it is indispensable in the manufacture of butter of the highest quality. The germ causing this fermentation is called *Lactici Acidi*. It is non-spore bearing and has its optimum growth temperature between 90° and 98° F. At 40° its growth ceases. Exposed to a temperature of 140° for fifteen minutes it is killed.

The souring of milk and cream, as already mentioned, is due to the action of the lactic acid bacteria upon the milk sugar changing it into lactic acid. Acid is therefore always produced at the expense of milk sugar. But the sugar is never all converted into acid because the production of acid is limited. When the acidity reaches about .9% the lactic acid bacteria are either checked or killed and the production of acid ceases. Owing to the universal presence of these bacteria it is almost impossible to secure milk free from them.

Under cleanly conditions the lactic acid type of bacteria always predominates in milk. When, however, milk is drawn under uncleanly conditions the lactic organisms may be outnumbered by other species of bacteria which give rise to the numerous taints often met with in milk.

Contradictory as it may seem, the lactic acid bacteria are alike friend and foe to the butter maker. Creamery

patrons are expected to have milk as free as possible from these germs so that it may arrive at the creamery in a sweet condition. They are therefore expected to thoroughly cool and care for it, not alone to suppress the action of the lactic acid bacteria but also that of the abnormal species that might have gained access to the milk.

While the acid bacteria are objectionable in milk, in cream made into butter they are indispensable. The highly desirable aroma in butter is the result of the growth of these organisms in the process of cream ripening. There are a number of different species of bacteria that have the power of producing lactic acid.

2. CURDLING AND DIGESTING FERMENTATION.

In point of numbers this class of bacteria ranks perhaps next to the lactic acid type. Indeed it is very difficult to obtain milk that does not contain them. It is not often, however, that their presence is noticeable owing to their inability to thrive in an acid medium.

According to bacteriologists most of these bacteria secrete two enzymes, one of which has the power of curdling milk, the other of digesting it. The former has the power of rennet, the latter of trypsin. "As a rule," says Russell, "any organism that possesses the digestive power, first causes a coagulation of the casein in a manner comparable to rennet."

It is only occasionally when the lactic acid organisms are in a great minority, or when for some reason their action has been suppressed, that this class of bacteria manifests itself by curdling milk while sweet. The curd thus formed differs from that produced by lactic acid in being soft and slimy.

Most of the curdling and digesting bacteria are spore bearing and can thus withstand unfavorable conditions better than the lactic acid bacteria. For this reason milk that has been heated sufficiently to kill the lactic acid bacteria, will often undergo the undesirable changes attributable to the digesting and curdling organisms.

3. BUTYRIC FERMENTATION.

It was mentioned that many bacteria have the power of producing lactic acid but that the true lactic acid fermentation is probably caused by a single species. So it is with the butyric acid bacteria. While a number of different organisms are known to produce this acid, Conn is of the opinion that the common butyric fermentation of milk and cream is due to a single species belonging to the anaerobic type.

The butyric acid produced by these organisms is the chief cause of rancid flavors in cream and butter. These bacteria are widely distributed in nature, being particularly abundant in filth. They are almost universally present in milk, from which they are hard to eradicate on account of their resistant spores. It is on account of these spores and their ability to grow in the absence of oxygen that the butyric fermentation is often found in ordinary heated milk from which the air has been excluded.

The influence of the butyric acid bacteria is felt mainly in butter and in overripened cream. The latter frequently possesses a rancid odor which must be charged to these bacteria, especially since it is known that overripened cream possesses conditions favorable for their development. Overripening should, therefore, be carefully guarded against.

The butyric fermentation is rarely noticeable during the early stage of cream ripening and its subsequent development in a highly acid cream is explained by Russell as being "probably due, not so much to the presence of lactic acid, as to the absence of dissolved oxygen, which at this stage has been used up by the lactic acid organisms."

Butter that is apparently good in quality when freshly made, will usually turn rancid when kept at ordinary temperatures a short time. The quickness with which this change comes is dependent largely upon the amount of acid present in cream at the time of churning. Butter made from cream in which the maximum amount of acid consistent with good flavor has been developed, usually possesses poor keeping quality. This seems to indicate that at least part of the rancidity that develops in butter after it is made is due to the butyric acid bacteria, while light and air, doubtless, also contribute much to this end.

ABNORMAL FERMENTATIONS.

No trouble needs to be anticipated from these fermentations so long as cleanliness prevails in the dairy. The bacteria that belong to this class are usually associated with filth, and dairies that become infested with them show a lack of cleanliness in the care and handling of the milk. Since milk is frequently infected with one or another of these abnormal fermentations a brief discussion will be given of the most important.

I. BITTER FERMENTATION.

Bitter milk and cream are quite common and there are several ways in which this bitterness is imparted: it may

be due to strippers' milk and to certain classes of feeds and weeds, but most frequently to bacteria. This class of bacteria has not yet been studied very thoroughly but we know a great deal about it in a practical way. In milk and cream in which the action of the lactic acid germs has been suppressed by low temperatures, bitterness due to the development of the bitter fermentation is almost certain to be noticeable. When the temperature is such as to cause a rapid development of the lactic fermentation, the bitter fermentation is rarely, if ever, present. It is quite evident from this that the bitter organisms are capable of growing at much lower temperatures than the lactic and that so long as the latter are rapidly growing the bitter fermentation is held in check.

This teaches us that it is not safe to ripen cream below 60° F. The author has found that cream quickly ripened and then held at a temperature of 45° for twenty-four hours would show no tendency toward bitterness, while the same cream held sweet at 45° for twenty-four hours and then ripened would develop a bitter flavor. This indicates that the lactic acid is unfavorable to the development of the bitter fermentation.

The bitter germs produce spores capable of resisting the boiling temperature. This accounts for the bitter taste that often develops in boiled milk.

2. SLIMY OR ROPY FERMENTATION.

This is not a common fermentation and rarely causes trouble where cleanliness is practiced in the dairy. The bacteria that produce it are usually found in impure water, dust and dung. These germs are antagonistic to

the lactic organisms and for this reason milk infected with them sours with great difficulty.

The action of this class of bacteria is to increase the viscosity of milk, which in mild cases simply assumes a slimy appearance. In extreme cases, however, the milk develops into a ropy consistency, permitting it to be strung out in threads several feet long.

Slimy or ropy milk cannot be creamed and is therefore worthless in the manufacture of butter. Such milk should not be confused with gargety milk which is stringy when drawn from the cow. The bacteria belonging to this class are easily destroyed as they do not form spores.

3. GASSY FERMENTATION.

This is an exceedingly troublesome fermentation in cheese making and is also the cause of much poor flavored butter. The gas germs are very abundant during the warm summer months but are scarcely noticeable in winter. Like the bitter germs, they are antagonistic to the lactic acid bacteria and do not grow during the rapid development of the latter. They are found most abundantly in the barn, particularly in dung.

4. TOXIC FERMENTATIONS.

Toxic or poisonous products are occasionally developed in milk as a result of bacterial activity. They are most commonly found in milk that has been kept for some time at low temperature.

5. CHROMOGENIC FERMENTATIONS.

Bacteria belonging to this class have the power of imparting to milk various colors. The most common of

these is blue. It is, however, not often met with in dairy practice since the color usually does not appear until the milk is several days old. The specific organism that causes blue milk has been known for more than half a century and is called cyanogenous. Another color that rarely turns up in dairy practice is produced by a germ known as prodigiosis, causing milk to turn red. Other colors are produced such as yellow, green and black, but these are of very rare occurrence.

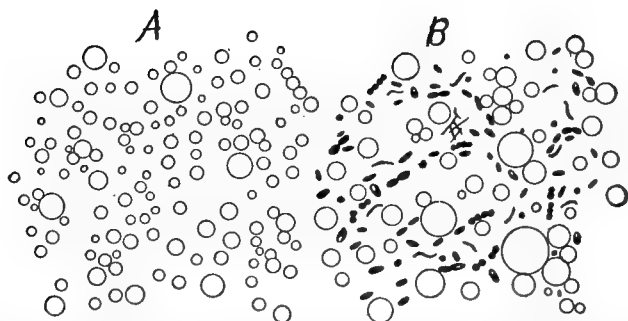

Microscopic appearance of pure and impure milk. A, Pure milk ; B, after standing in a wash room for a few hours in a dirty dish, showing, besides the fat globules, many forms of bacteria.—Moore.

CHAPTER III.

SANITARY MILK PRODUCTION.

Sanitary Milk Defined. Sanitary milk is milk from healthy cows, produced and handled under conditions in which contamination from filth, bad odors and bacteria, is reduced to a minimum.

Importance of Sanitary Milk. The production of clean milk is one of the most important subjects that confronts the American dairyman at the present time. Further improvement in the quality of butter and cheese must largely be sought in the use of cleaner milk. With the better appreciation by the public of the great nutritive value of milk, there opens an unlimited market for it for consumption in the raw form. Already we find that milk produced under the best sanitary conditions sells for practically double that obtained under ordinary, more or less, slipshod conditions. So great is the clamor for cleaner milk that any extra efforts expended in producing it are certain to be richly compensated.

The Necessary Conditions for the production of sanitary milk are as follows: (1) Healthy cows; (2) sanitary barn; (3) clean barn yard; (4) clean cows; (5) clean milkers; (6) clean milk vessels; (7) clean, wholesome feed; (8) pure water; (9) clean strainers; (10) dust-free stable air; (11) clean bedding; (12) milking with dry hands; (13) thorough cooling of milk after milking; (14) sanitary milk room.

Healthy Cows. The health of the cow is of prime importance in the production of sanitary milk. All milk

from cows affected with contagious diseases should be rigidly excluded from the dairy. Aside from the general unfitness of such milk there is danger of the disease producing organisms getting into the milk. It has been found, for example, that cows whose udders are affected with tuberculosis, yield milk containing these organisms. The prevalence of this disease among cows at present makes it imperative to determine definitely whether or not cows are affected with the disease, by the application of the tuberculin test.

Any feverish condition of the cow tends to impart a feverish odor to the milk, which should therefore not be used. Especially important is it that milk from diseased udders, no matter what the character of the disease, be discarded.

Sanitary Barn. Light, ventilation and ease of cleaning are essential to a sanitary dairy barn. The disinfectant action of an abundance of sunlight, secured by providing a large number of windows, is of the highest importance.

Of equal importance is a clean, pure atmosphere, secured by a continuous ventilating system. The fact that odors of any description are absorbed by milk with great avidity, sufficiently emphasises the great need of pure air.

To permit of easy cleaning, the barn floors and gutters should be built of concrete. They should be scrubbed daily, and care should be taken to keep the walls and ceiling free from dust and cobwebs. The feed boxes must also be cleaned after each feed.

The stalls should be of the simplest construction, to afford as little chance for lodgement of dust as possible. Furthermore, they should so fit the cows as to cause the latter to stand with their hind feet on the edge of the gut-

ter, a matter of the highest importance in keeping cows clean.

The walls and ceiling should be as smooth as possible. Moreover, they should be frequently disinfected by means of a coat of whitewash. The latter gives the barn a striking sanitary appearance.

Clean Barn Yard. A clean, well drained barn yard is an essential factor in the production of sanitary milk. Where cows are obliged to wade in mire and filth, it is easy to foretell what the quality of the milk will be. To secure a good barn yard it must be covered with gravel or cinders, and should slope away from the barn. If the manure is not taken directly from the stable to the fields, it should be placed where the cows cannot have access to it.

Clean Cows. Where the barn and barn-yard are sanitary, cows may be expected to be reasonably clean. Yet cows that are apparently clean, may still be the means of infecting milk to no small degree. When we consider that every dust particle and every hair that drops into the milk may add hundreds, thousands, or even millions of bacteria to it, we realize the importance of taking every precaution to guard against contamination from this source.

To keep cows as free as possible from loose hair and dust particles they should be carded and brushed regularly once a day. This should be done after milking to avoid dust. Five to ten minutes before the cow is milked her udder and flanks should be gently washed with clean, tepid water, by using a clean sponge or cloth. This will allow sufficient time for any adhering drops of water to drip off, at the same time it will keep the udder and flanks sufficiently moist to prevent dislodgment of dust particles

and hairs at milking time. This practically means that the milker must always have one or two cows washed ahead. He should be careful to wash his hands in clean water after each washing.

Under ordinary conditions the cow is the greatest source of milk contamination. The rubbing of the milker against her and the shaking of the udder will dislodge numerous dust particles and hairs unless the foregoing instructions are rigidly followed.

Attention should also be given to the cow's switch, which should be kept scrupulously clean. The usual switching during milking is no small matter in the contamination of milk when the switch is not clean.

Clean Milkers. Clothes which have been worn in the fields are not suitable for milking purposes. Every milker should be provided with a clean, white milking suit, consisting of cap, jacket and trousers. Such clothes can be bought ready made for one dollar; and, if frequently laundered, will materially aid in securing clean milk.

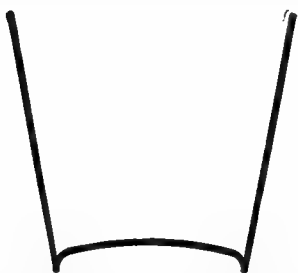

Fig. 1. Unflushed seam.

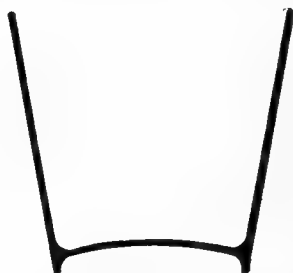

Fig. 2. Flushed seam.

Milkers should also wash and dry their hands before milking, and, above all, should keep them dry during milking.

Clean Vessels. All utensils used in the handling of

milk should be made of good tin, with as few seams as possible. Wherever seams occur, they should be flushed with solder. Unflushed seams are difficult to clean, and, as a rule, afford good breeding places for bacteria. Fig. 1 illustrates the character of the unflushed seam; Fig. 2 shows a flushed seam, which fully illustrates its value.

Fig. 3 illustrates a modern sanitary milk pail. The value of a partially closed pail is evident from the reduced opening, which serves to keep out many of the micro-organisms that otherwise drop into the pail during



Fig. 3. Sanitary Milk Pail.

milking. While such a pail is somewhat more difficult to clean than the ordinary open pail, it is believed that the reduced contamination during milking far outweighs this disadvantage.

All utensils used in the handling of milk should be as nearly sterile as possible. A very desirable method of cleaning them is as follows:

First, rinse with warm or cold water. Second, scrub

with moderately hot water containing some sal soda. The washing should be done with brushes rather than cloth because the bristles enter into any crevices present which the cloth cannot possibly reach. Furthermore, it is very difficult to keep the cloth clean. Third, scald thoroughly with steam or hot water, after rinsing out the water in which the sal soda was used. After scalding, the utensils should be inverted on the shelves without wiping and allowed to remain in this place until ready to use. This will leave the vessels in a practically sterile condition. Fourth, if it is possible to turn the inside of the vessels to the sun, in a place where there is no dust, then it is desirable to expose the utensils during the day to the strong germicidal action of the direct sun's rays.

Clean, Wholesome Feed. Highly fermented and aromated feeds, like sour brewers grains and leeks should be rigidly withheld from dairy cows when anything like good flavored milk is sought. So readily does milk absorb the odors of feeds through the system of the animal, that even good corn silage, when fed just previous to milking, will leave its odor in the milk. When fed after milking, however, no objection whatever can be raised against corn silage because not a trace of its odors is then found in the milk. Aromatic feeds of any kind should always be fed after milking.

Pure Water. Since feeds are known to transmit their odors to the milk through the cow, it is reasonable to expect water to do the same. Cows should, therefore, never be permitted to drink anything but pure, clean-flavored water. The need of pure water is further evident from the fact that it enters so largely into the composition of milk.

The water of ponds and stagnant streams is especially dangerous. Not only is such water injurious to the health of cows, but in wading into it, they become contaminated with numerous undesirable bacteria, some of which may later find their way into the milk.

Strainers and Straining. Milk should be drawn so clean as to make it almost unnecessary to strain it. This operation is frequently done under the delusion that so long as it removes all visible dirt the milk has been entirely purified. The real harm, however, that comes from hairs and dust particles dropping into the milk is not so much in the hairs and dust particles themselves as in the millions of bacteria which they carry with them. These bacteria are so small that no method of straining will remove them. Straining can not even remove all of the dirt, because some of it will go in solution.

A good strainer consists of two thicknesses of cheese cloth with a layer of absorbent cotton between. The strainer is to be placed on the can or vat into which the milk is to be strained and not on the milk pail. While a strainer like the above placed upon the milk pail, reduces the bacterial content slightly in the hands of careful milkers, it is believed that the slight advantage gained would be more than off-set by greater carelessness in milking; especially might this be true with ignorant milkers who are apt to think that the strainer will make up for any carelessness on their part. A cheese cloth strainer on the milk pail is worse than useless with any kind of milker.

New sterilized cotton must be used at each milking and the cloths must be thoroughly washed and sterilized. Like the cotton, it is best to use the cloth but once.

Dust-Free Air. Great precaution should be taken not

to create any dust in the stable about milking time, for this is certain to find its way into the milk. Cows should, therefore, never be bedded or receive any dusty feed just before or during milking.

Dry roughage, such as hay and corn fodder, always contains a considerable amount of dust, and when fed before or during milking may so charge the air with dust as to make clean milk an impossibility.

Moistening the floor and walls with clean water previous to milking materially minimizes the danger of getting dust into the milk. A mistake not infrequently made even in the better class of dairies is to card and brush the cows just before milking. While this results in cleaner cows, the advantage thus gained is far more than offset by the dirtier air, which, as will be shown later, materially increases the germ content of the milk. The carding and brushing should be done at least thirty minutes before the milking commences.

Clean Bedding. Clean shavings and clean cut straw should preferably be used for bedding. Cows stepping and lying on dirty bedding will soil themselves and create a dusty barn air.

Milking With Dry Hands. A prolific source of milk contamination is the milking with wet hands. Where the milker wets his hands with milk, some of it is bound to drip into the pail, carrying with it thousands or millions of bacteria, depending upon the degree of cleanliness of the milker's hands and the cow's udder. There is no excuse for the filthy practice of wet milking, since it is just as easy to milk with dry hands.

Fore-Milk. Where the purest milk is sought, it is desirable to reject the first stream or two from each teat, as this contains many thousands of bacteria. The reason

for this rich development of germs is found in the favorable conditions provided by the milk in the milk-ducts of the teats, to which the bacteria find ready access.

Flies. Flies not only constitute a prolific but also a dangerous source of milk contamination. These pests visit places of the worst description and their presence in a dairy suggests a disregard for cleanliness. Of 414 flies examined by the Bacteriologist of the Connecticut Station, the average number of bacteria carried per fly was *one and a quarter millions*. Flies should be rigidly excluded from all places where they are apt to come in contact with the milk.

Experimental Data. To show to what extent the bacterial content of milk may be reduced by adopting the precautions suggested in the foregoing pages, a few experimental data are herewith presented.

In Bulletin No. 42 of the Storrs (Conn.) Experiment Station, Stocking reports the following:

1. When the cows were milked before feeding the number of bacteria per c. c. was 1,233; when milked immediately after feeding, the number of bacteria was 3,656, or *three* times as many.

2. When the udder and flanks of the cows were wiped with a damp cloth, the number of bacteria per c. c. was 716; when not wiped the number was 7,058, or *ten* times as great.

3. When the cows were not brushed just before milking the number of bacteria per c. c. was 1,207; when brushed just before milking, the number was 2,286, or *nearly twice* as great.

4. When students who had studied the production of clean milk did the milking, the number of bacteria per c. c. was 914; when the milking was done by regular

unskilled milkers the number of bacteria was 2,846, or *three* times as great.

Wiping or washing udders before milking not only very materially reduces the bacterial content of the milk, but also lessens the amount of dirt to a very great extent. Frazer has shown that "the average weight of dirt which falls from muddy udders during milking is *ninety* times as great as that which falls from the same udder after washing, and when the udder is slightly soiled it is eighteen times as great."

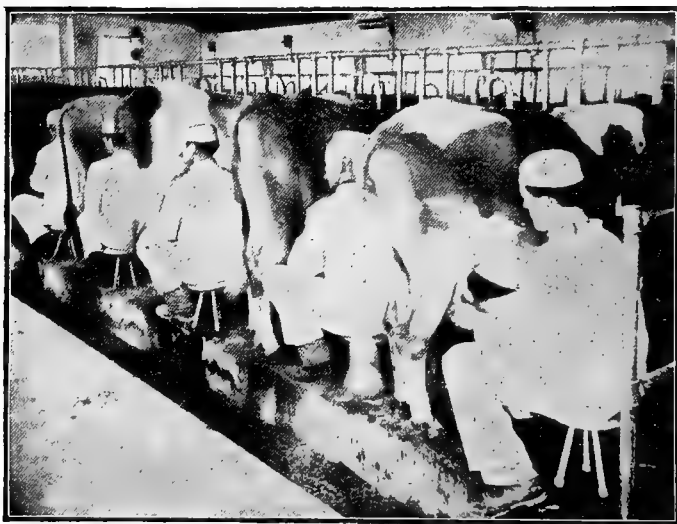

Clean Milking. (From Da. Div., U. S. Dept. of A.)

CHAPTER IV.

COOLING AND AERATION OF MILK AND CREAM.

Importance of Low Temperature. Milk always contains bacteria no matter how cleanly the conditions under which it is drawn. At ordinary temperatures these bacteria increase with marvelous rapidity; at low temperatures their growth practically ceases. The effect of temperature on bacterial development is graphically shown in Fig. 57.



Fig. 4.—Relation of temperature to bacterial growth.

a represents a single bacterium; *b*, its progeny in twenty-four hours in milk kept at 50° F.; *c*, its progeny in twenty-four hours in milk kept at 70° F. (Bul. 26, Storrs, Conn.)

At a temperature of 50° F. the bacteria multiplied five times; at 70° F. they multiplied seven hundred and fifty times.

Roughly speaking, at 98° F. bacteria multiply one hun-

dred times faster than at 70° F. At 32° F. bacterial development practically ceases.

Milk or cream may be kept sweet a long time at 40° to 45° F. because the lactic acid bacteria practically stop growing at these temperatures. But there are other classes of bacteria that can grow at these temperatures, as evidenced by the production of undesirable flavors. Such flavors usually become noticeable after thirty-six hours. Where milk and cream are to be kept in the best possible condition, it is necessary to reduce the temperature to within a few degrees of freezing.

Lack of thorough cooling necessitates two deliveries of milk per day, and, what is still worse, requires many dairymen to milk their cows shortly after midnight and shortly after midday, a drudgery which casts a damper upon the whole milk business. Lack of cooling also means financial loss through souring of milk and leads to many dissatisfied customers.

Prompt Cooling. Milk should be cooled as quickly as possible after it is drawn. Indeed, the milk should be taken directly from the cow to the cooling room and promptly cooled. To do this conveniently it is necessary to have the cooling room located as near the barn as is consistent with freedom from barn odors.

Too often the milk is allowed to remain in the barn until all the cows have been milked, and this may require from two to three hours, depending upon the number of cows milked by each milker. A few hours delay in cooling reduces the keeping quality of milk to a far greater extent than is commonly supposed.

Importance of Aeration. Milk not only contains bacteria immediately after it is drawn, but it also contains gases, chief among which, perhaps, is car-

bonic acid gas. These gases should be removed as quickly as possible after milking by exposing the milk in thin sheets to the atmosphere. Fortunately the construction of modern coolers is such as to make it possible to do the cooling and aerating in one operation.

Formerly it was customary for dairymen to aerate their milk before cooling. Such practice is known to give somewhat better aeration than is possible where the cooling and aerating are performed in the same operation; yet the difference is so slight that consumers cannot detect it. The practice of aerating first and cooling afterward is therefore being abandoned.

Coolers. All modern coolers permit cooling with ice water. Without this a sufficiently low temperature cannot be obtained to stop practically all bacterial growth. To meet the requirements of dairies of different sizes, several styles of coolers are herewith described and illustrated.

Corrugated Cooler. This style of cooler is shown in Fig. 5, which also shows a desirable method of fastening it. It is especially adapted to dairies having from fifteen to thirty cows. The cooler consists of two parts: An upper section which is used to cool milk and cream with uniced water, and a lower section through which ice water is circulated.

A storage tank for well water may be placed above the ceiling. From this the water is admitted to the upper section through the valve which is used to regulate the flow. As shown by the arrows the water enters the section at the bottom and discharges at the top. The waste water may be conducted to the feed water tank of the boiler, to a watering trough, or other places where it may be useful.

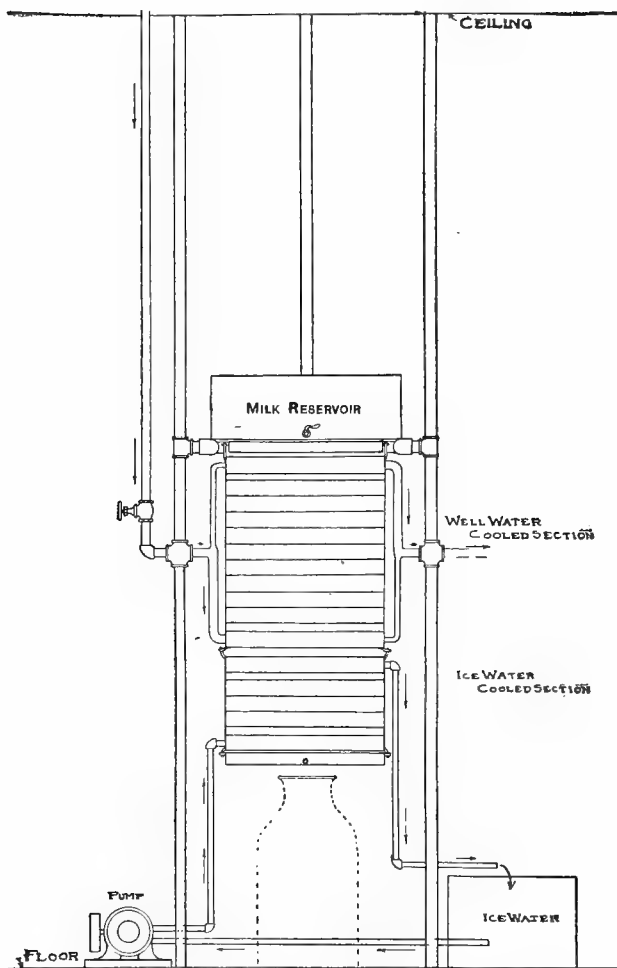

Fig. 6.—Showing Corrugated Cooler and Method of Support.

By means of the pump at the left, the ice water is forced back into the small tank at the right, which contains finely crushed ice.

As might be expected, by forcing the ice water from the cooler back into the ice water storage, a considerable saving is effected, not only of ice and water, but of time as well. Proof of these advantages is brought out by the results recorded in the following table, which shows the work of the cooler with and without the ice water pump. When no pump was used, ordinary well water was sprayed over finely crushed ice in the can shown at the right, and the discharge was allowed to run into the drain.

TABLE SHOWING WORK OF COOLER WITH AND WITHOUT THE PUMP.

Number of Experiment.	Amount Ice Used—Pounds.	Time in Cooling—Minutes.	Temperature of Milk Before Cooling—Degrees F.	Temperature of Well Water—Degrees F.	
No. 1	{ With pump.....	37	45	85	73
	{ Without pump.....	89	92	88	73
No. 2	{ With pump.....	35	40	85	66
	{ Without pump.....	94	82	84	66
No. 3	{ With pump.....	32	35	82	64
	{ Without pump.....	85	93	85	64
No. 4	{ With pump.....	38	45	88	72
	{ Without pump.....	95	85	85	72
No. 5	{ With pump.....	34	43	85	70
	{ Without pump.....	83	88	88	70
Average	{ With pump.....	35	41	85	69
	{ Without pump.....	89	88	86	69

All the milk was cooled to 45° F., and the amount of milk cooled in each experiment was forty-four gallons, one-half of which was cooled with a pump and the other half without.

The above figures show that less than half the amount of ice and less than half as much time were required in cooling with the pump than when no pump was used.

Where no ice is intended to be used, coolers may be purchased without the ice water section.

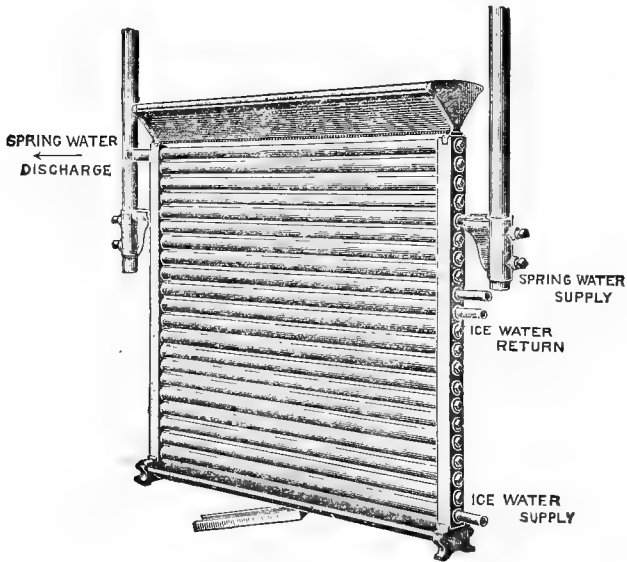

Fig. 6.—Tubular Cooler.

The cooler is fastened by means of two-inch galvanized iron gas pipes, the lower ends of which are embedded in the concrete floor while the upper ends are at-

tached to the ceiling (Fig. 5). The milk reservoir is also supported by galvanized iron gas pipes, in the manner shown in the illustration.

The water pump should be fastened to the concrete floor in a manner similar to that in which the cream separator is fastened (see page 95):

Tubular Cooler. Fig. 6 illustrates this type of cooler, which is recommended for large dairymen and milk dealers. This cooler is very substantial, and, as a rule, has greater width in proportion to length than the corrugated style, which leaves the top of the cooler a more convenient distance from the floor. It may be fastened and operated in the same manner as the corrugated cooler shown in Fig. 5.

Cone-Shaped Cooler.

For dairies having fewer than fifteen cows a cheap cooler like that shown in Fig. 7 may be used to advantage. The water enters the bottom of the cooler and discharges at the top, while the milk flows in a thin sheet over the outside. Ice may be placed inside the cooler, if desired. The can at the top is the milk receiver, which has small openings at the bottom near the outside, through which the milk discharges in fine streams, directly upon the cone below.



Fig. 7.—Cone Shaped Cooler.

Cooling With Brine. This is the cleanest, most con-

venient and efficient, and, in many cases, the cheapest method of cooling milk and cream. The brine may be reduced to any temperature desired with a mechanical refrigerating machine. It is forced through the cooler with a pump, in the same manner as ordinary ice water. With the latter it is difficult to cool milk and cream below 40° F., while with the brine the temperature is easily reduced to 34° F., at which milk and cream remain practically without change. Such a low temperature is especially desirable in shipping milk and cream. When cream leaves the dairy at a temperature near freezing, it may be shipped in an ordinary can wrapped with a felt jacket a distance of 500 miles or more in warm weather without undergoing a noticeable change in either flavor or acidity.

Precautions in Cooling. While cooling milk or cream, the room should be kept damp, especially the floor. This will keep down any dust that may be in the room and thus keep it from getting into the milk. Draughts should be avoided during cooling for the same reason. In this connection it is well to remember that the real harm is not so much in the dust particles themselves as in the many bacteria which usually adhere to them.

Where coolers are left exposed to the air of the room after they have been cleaned and sterilized, they should be rinsed off with boiling water just before using.

It is important also to use a reliable thermometer. Ordinary cheap thermometers often read two to six degrees too high or too low. A standard thermometer should be on hand by which the cheaper ones may be standardized.

Never Use Ice in Milk or Cream. Adding ice directly to milk and cream is a pernicious, though not un-

common, practice. The best of natural ice contains dirt and bacteria. Even ice made by mechanical means from distilled water often contains considerable quantities of impurities. Ice also is an adulterant just as much as water. In case of cream cooled with ice the body is unsatisfactory, even if the cream contains the required amount of fat.

Cooling Without Special Coolers. When no special coolers are at hand milk and cream should be cooled in small cans by placing them in a tank or an oil barrel cut in two. Cold water is pumped into the tank or barrel in such a way that the cold water enters near the bottom of the tank, thus forcing out the warm surface water.

Water should be pumped into the tank at frequent intervals until the milk or cream has nearly reached the temperature of the water. The time of cooling is materially shortened by frequent stirring, which is a very essential part in cooling milk and cream in cans.

Where milk is placed in large cans and stirred little, farmers lose in having the test lowered by hard particles of cream forming at the top. Where milk is properly cooled, hard flakes of cream or churned cream will not be found on top of the milk.

CHAPTER V.

THE BABCOCK TEST.

This is a cheap and simple device for determining the percentage of fat in milk, cream, skim-milk, buttermilk, whey and cheese. It was invented in 1890 by Dr. S. M. Babcock, of the Wisconsin Agricultural Experiment Station, and ranks among the leading agricultural inventions of modern times. The chief uses of the Babcock test may be mentioned as follows:

1. It has made possible the payment for milk according to its quality.

2. It has enabled butter and cheese makers to detect undue losses in the process of manufacture.

3. It has made possible the grading up of dairy herds by locating the poor cows.

4. It has, in a large measure, done away with the practice of watering and skimming milk.

Principle of the Babcock Test. The separation of the butter fat from milk with the Babcock test is made possible:

1. By the difference in the specific gravity of butter fat and milk serum.

2. By the centrifugal force generated in the tester.

3. By burning the solids not fat with a strong acid.

Sample for a Test. Whatever the sample to be tested, always eighteen grams are used for a test. In testing cream and cheese, the sample is weighed. For testing milk, skim-milk, buttermilk and whey, weighing requires

too much time. Indeed, with these substances weighing is not necessary as sufficiently accurate samples are ob-

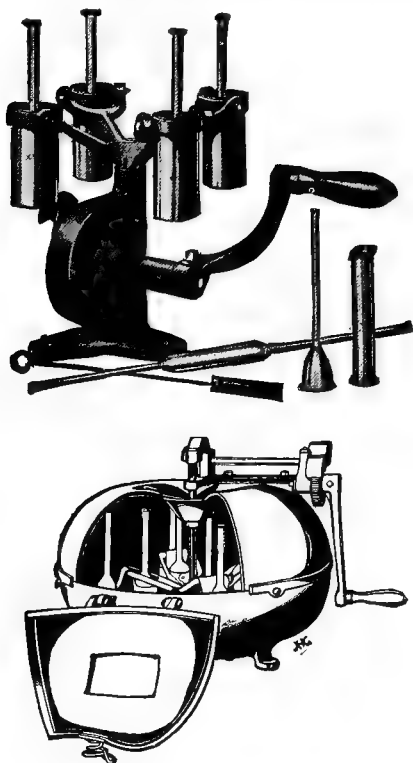

Fig. 8.—Two styles of Babcock testers.

tained by measuring which is the method universally employed. In making a Babcock test it is of the greatest importance to secure a uniform sample of the substance to be tested.

Apparatus. This consists essentially of the following parts: A, Babcock tester; B, milk bottle; C, cream bottle; D, skim-milk bottle; E, pipette or milk measure; F, acid measures; G, cream scales; H, mixing cans; I, dividers.

A. Babcock Tester. This machine, shown in Fig. 8, consists of a revolving wheel placed in a horizontal position and provided with swinging pockets for the bottles. This wheel is rotated by means of a worm wheel (lower machine) at the top of the tester. When the tester stops the pockets hang down allowing the bottles to stand up. As the wheel begins rotating the pockets move out causing the bottles to assume a horizontal position. The wheel is enclosed in a cast iron frame provided with a cover.

B. Milk Bottle. This has a neck graduated to ten large divisions, each of which reads one per cent. Each large division is subdivided into five smaller ones, making each subdivision read .2%. The contents of the neck from the zero mark to the 10% mark is equivalent to two cubic centimeters. Since the Babcock test does not give the percentage of fat by volume but by weight, the 10% scale on the neck of the bottle will, therefore, hold 1.8 grams of fat. In other words, if the scale were filled with water it would hold two grams; but fat being only .9 as heavy, 2 cubic centimeters of it would weigh nine-tenths of two grams or 1.8 grams. This is exactly 10% of 18 grams, the weight of the sample used for testing. A milk bottle is shown in Fig. 9.

C. Cream Bottles. These are graduated from 30% to 55%. A 30% bottle is shown in Fig. 10. Since cream usually tests more than 30%, the sample must be divided when the 30% bottles are used. See page 71.



Fig. 9.—Milk bottle.



Fig. 10.—Cream bottle.

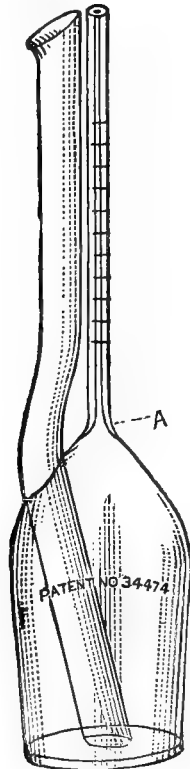

Fig. 11.—Skim-milk bottle.

D. Skim-milk Bottle. This bottle, shown in Fig. 11, is provided with a double neck, a large one to admit the milk, and a smaller graduated neck for fat reading. The entire scale reads one-half per cent. Being divided into ten subdivisions each subdivision reads .05%. The same bottle is also used for testing buttermilk.



Fig. 12.—Pipette.



Fig. 13.—Acid measure.



Fig. 14.—Acid measure.

E. Pipette. This holds 17.6 c.c., as shown in Fig. 12. Since about .1 c.c. of milk will adhere to the inside of the pipette it is expected to deliver only 17.5 c.c., which is equivalent to 18 grams of normal milk.

F. Acid Measures. In making a Babcock test equal quantities, by volume, of acid and milk are used. The acid measure, shown in Fig. 13, holds 17.5 c.c. of acid, the amount needed for one test. The one shown in Fig. 14 is divided into six divisions, each of which holds 17.5 c.c. or one charge of acid. Where

many tests are made a graduate of this kind saves time in filling, but should be made to hold twenty-five charges.

H. A cream scales is shown in Fig. 15. Also see Figs. 27 and 28, pages 71 and 72.

Acid. The acid used in the test is commercial sul-

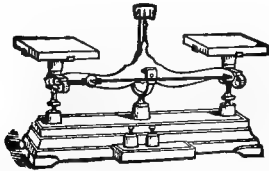

Fig. 15.—Cream scales.

phuric acid having a specific gravity of 1.82 to 1.83. When the specific gravity of the acid falls below 1.82 the milk solids are not properly burned and particles of curd may appear in the fat. On the other hand, an acid with a specific gravity above 1.83 has a tendency to blacken or char the fat.

The sulphuric acid, besides burning the solids not fat, facilitates the separation of the fat by raising the specific gravity of the medium in which it floats.

Sulphuric acid must be kept in glass bottles provided with glass stoppers. Exposure to the air materially weakens it.

Making a Babcock Test. The different steps are indicated as follows:

1. Thoroughly mix the sample.
2. Immediately after mixing insert the pipette into the milk and suck until the milk has gone above the mark on the pipette, then quickly place the fore finger over the



Fig. 16.—Showing manner of emptying pipette.

top and allow the milk to run down to the mark by slowly relieving the pressure of the finger.

3. Empty the milk into the bottle in the manner shown in Fig. 16.

4. Add the acid in the same manner in which the milk was emptied into the bottle.

5. Mix the acid with the milk by giving the bottle a slow rotary motion.

6. Allow mixture to stand a few minutes.

7. Shake or mix again and then place the bottle in the tester.

8. Run tester four minutes at the proper speed.

9. Add moderately hot water until contents come to the neck of the bottle.

10. Whirl one minute.

11. Add moderately hot water until contents of the bottle reach about the 8% mark.

12. Whirl one minute.

13. Read test.

How to Read Milk Test. At the top of the fat column is usually quite a pronounced meniscus as shown in Fig. 17. A less pronounced one is found at the bottom of the column. The fat should be read from the extremes of the fat column, 1 to 3, not from 2 to 4, when its temperature is about 140° F. Too high a temperature gives too high

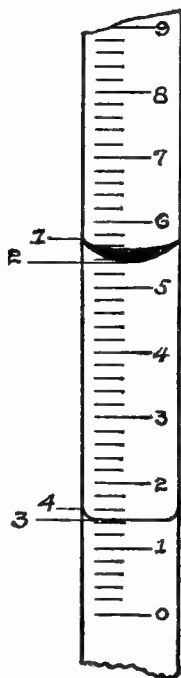

Fig. 17.—Fat column showing meniscuses.

a reading, because of the expanded condition of the fat, while too low a temperature gives an uncertain reading.

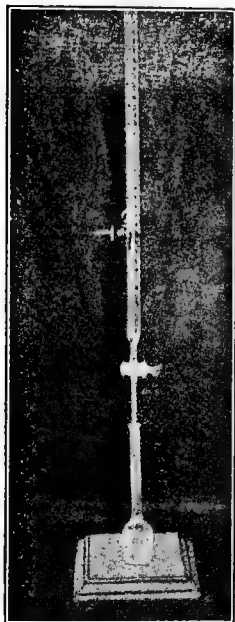

Fig. 18. Burette method.



Fig. 19.—Milk bottle tester.

Precautions in Making a Test. 1. Be sure you have a fair sample.

2. The temperature of the milk should be about 60 or 70 degrees.

3. Always mix twice after acid has been added.

4. Be sure your tester runs at the right speed.

5. Use nothing but clean, soft water in filling the bottles.

6. Be sure the tester does not jar.

7. Be sure the acid is of the right strength.

8. Mix as soon as acid is added to milk.

9. Do not allow the bottles to become cold before reading the test.

10. Read the test twice to insure a correct reading.

The water added to the test bottles after they have been whirled should be clean and pure. Water containing much lime seriously affects the test. Such water may be used, however, when first treated with a few drops of sulphuric acid.

As stated before skim-milk, buttermilk and cream are tested in the same way as milk, with the exception that the cream sample is weighed not measured.

Cleaning Test Bottles. As soon as the test is read, the bottles are emptied by shaking them up and down so as to remove the white sediment. Next wash them in hot water containing some alkali, and finally rinse them with hot water. Occasionally the bottles should be rinsed with a special cleaning solution, which is made by dissolving about one ounce of potassium bichromate in one pint of sulphuric acid. A small brush should also occasionally be run up and down the neck of the bottle.

Testing or Calibrating Milk Bottles. Fill the bottle to the zero mark with water, or preferably wood alcohol to which a little coloring matter has been added. Immerse the lower section of the tester, shown in Fig. 19, in the contents of the bottle. If the bottle is correct, the contents will rise to the 5% mark. Next immerse both sections of the tester which will bring the contents to the 10% mark if the bottle is correctly calibrated.

It has been learned that the volume of the graduated part of the neck is 2 c.c. Each section of the tester is made to displace 1 c.c. when immersed in the liquid, hence the two sections will just fill the scale if the latter is correct.

The method recommended below for calibrating cream bottles may also be used with milk bottles.

Calibrating Cream Bottles. According to Hunziker,* the most satisfactory method of calibrating cream test bottles is as follows (see Fig. 18): Fill the bottle to the zero mark with water. Remove any drops adhering to the inside of the neck with a coiled piece of filter or blotting paper. Now slowly add measured amounts of water from an accurate burette graduated to at least 0.1 c.c. Every 0.1 c.c. of water run into the neck is equivalent to 0.5% on the scale of an 18 gram cream bottle and 1.0% on a 9 gram cream bottle. That is, with an 18 gram 30% bottle, 6 c.c. of water would be required to exactly fill the scale on the neck.

In calibrating milk and cream bottles, different parts of the neck should be tested as well as the neck as a whole.

Calculating Speed of Tester. The speed at which a tester must be run is dependent upon the diameter of the wheel carrying the bottles. The larger this wheel the fewer the revolutions it must make per minute to effect a complete separation of the fat.

In the following table by Farrington and Woll the necessary speed per given diameter is calculated:

*Bulletin No. 145, Indiana Experiment Station.

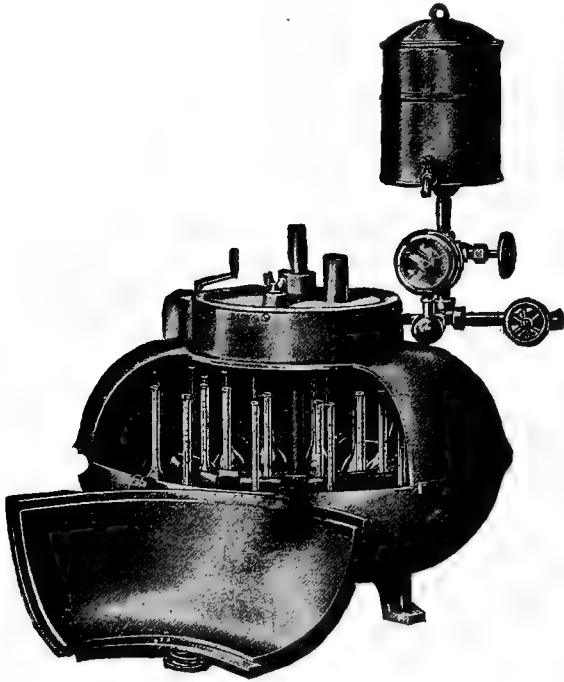

Fig. 20.—Steam Babcock Tester.

Testing Cream. The testing of cream is explained in detail in Chapter VII.

CHAPTER VI.

COMPOSITE SAMPLING.

Where milk is bought on the fat basis, it is essential that it be sampled daily as it arrives at the creamery. It is not practicable, however, to make daily tests of the samples because this would involve too much work. Each patron is therefore provided with a pint jar to which samples of his milk are added daily for one or two weeks, the sample thus secured being called a *composite* sample. A test of this composite sample represents the average percentage of butter fat in the milk for the period during which the sample was gathered.

Careful experiments have shown that quite as accurate results can be obtained with the composite method of testing as is possible by daily tests, besides saving a great deal of work. This has led to its universal adoption wherever milk is bought by the Babcock test.

All composite jars should be carefully labeled by placing numbers upon them. These numbers should be written in large indelible figures as exhibited by the composite jar shown in Fig. 24. Shelves are provided in the intake upon which the jars are arranged in regular consecutive order. Numbers corresponding to those on the jars are placed on the milk sheet opposite the names of the patrons which should be arranged alphabetically.

Taking the Samples. Whatever the method of sampling, all milk should be sampled immediately after it enters the weigh can, not, as is frequently the case, after it is weighed.

Most of the sampling is done by either of two methods: (1) by means of a half ounce dipper, shown in Fig. 21, or (2) by means of long narrow tubes, one of which is shown in Fig. 22.

The dipper furnishes a simple and easy means of sampling milk. Where the milk is thoroughly mixed, and the variations in quantity from day to day are slight, the dipper method of sampling is accurate.

The other method of sampling is illustrated by the Scovell sampler (Fig. 23). The main tube of the sampler is open at both ends, the lower of which closely fits into a cap provided with three elliptical openings. As the sampler is lowered into the milk the latter rushes through the openings filling the tube to the height of the milk in the can. When the cap strikes the bottom of the can the tube slides over the openings, thus permitting the sample to be withdrawn and emptied into the composite jar.

This sampler has the advantage of always taking an aliquot portion of the milk, and furnishing an accurate sample when the sampling is somewhat delayed, because it takes as much milk from the top as it does from the bottom of the can.

The McKay sampler (see page 66) works on the same principle as the Scovell and has proven very satisfactory.

Preservatives. Milk cannot be satisfactorily tested after it has loppered owing to the difficulty of securing an accurate sample. This makes it necessary to add some preservative to the composite samples to keep them sweet.

The best preservatives for this purpose are corrosive sublimate, formalin, and bichromate of potash. All of these are poisons and care must be taken to place them

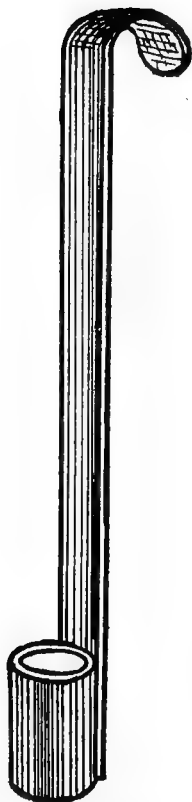

Fig. 21.—Milk sampler.



Fig. 22.—Milk thief.



Fig. 23.—Scovell sampling tube.

where children, and others unfamiliar with their poisonous properties, can not have access to them.

The bichromate of potash and corrosive sublimate can be purchased in tablet form, each tablet containing enough preservative to keep a pint of milk sweet for about two

weeks. The tablets color the milk so that there can be no mistake about its unfitness for consumption.

When colorless preservatives are used, like ordinary formalin and corrosive sublimate, a little analine dye should be added to prevent mistaking the identity of milk treated with these preservatives.

During the warm summer time the bichromate of potash is not as satisfactory as either of the other two preservatives mentioned, because of its comparative weakness and liability to interfere with the test when too much of it is used. When the bichromate is used in the ordinary solid form not more than a piece the size of a pea should be used, otherwise a good, clear test is not possible.

For spring, fall, and winter use, however, bichromate of potash is excelled by no other preservative, either in cheapness, or safety and convenience in handling.

Care of Composite Samples. It is a duty which the milk buyer owes his patrons to keep the sample jars carefully locked up in the refrigerator when not in use so as to prevent the possibility of anyone's tampering with them. This will serve the additional purpose of excluding the light and heat from the samples, for they will keep but a short time when exposed to light and heat.

When the sample jars are permitted to stand a few days without shaking, the cream which rises will dry and harden, especially that in contact with the sides of the jar, so that it becomes difficult to secure a fair sample on testing day without special treatment of the sample. This is prevented by giving the jar a rotary motion every time a sample of milk is added.

It is important, too, that the covers of the jars fit tight, otherwise evaporation takes place, resulting in an increased test. In several instances the author has ob-

served that the sampler did not cover the jars at all! Can we wonder why patrons complain so frequently about the testing? Where the jars are kept uncovered for several weeks the cream is in a condition in which it can not be reincorporated with the milk and the Babcock test in this case becomes truly a snare and delusion.

Should the samples show any dried or churned cream on testing day, the sample jars must be placed in water at a temperature of 110° F. for five or ten minutes to allow the cream or butter to melt. When this is done the sample for the test bottle must be taken instantly after mixing, as the melted fat separates very quickly.

Frequency of Testing. It must not be supposed that if enough preservative can be added to the sample jars to keep the milk sweet for a month or longer that it is just as well to make monthly tests as weekly. Far from it. Even if the milk does remain sweet, the tendency of the cream to churn and become dried and crusty is in itself sufficient protest against monthly testing. It is rare, indeed, that samples that have been kept for a month or longer can be sampled satisfactorily without warming them in a water bath, which means a great deal of extra work.

The best tests are secured when the samples are tested weekly or at most every two weeks. When the tests are made weekly it rarely becomes necessary to warm the samples if they have been properly cared for. Then, too, if an error is made anywhere in the testing, there are three other tests for the month that help to minimize it. It is not strange at all that a sample jar should break occasionally. If the jar should contain a whole month's milk the patron is deprived of his test for

that month. On the weekly basis of testing there would still be three tests to fall back on.

Composite Cream Samples. When cream is received in good condition, the method of composite sampling may be employed in the same manner as with milk. The best results are always obtained, however, by testing each delivery of cream, and this practice is strongly recommended. Only samplers which take samples proportional to the amount of cream, are permissible in making composite samples of cream.

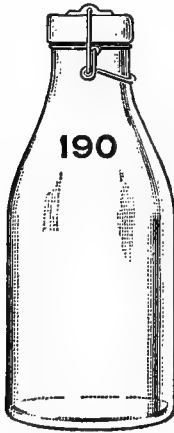

Fig. 24.—Composite test jar.



Glass top composite jar.

CHAPTER VII.

SAMPLING AND TESTING CREAM.

CREAM SAMPLING AND SAMPLERS.

Taking an Aliquot Sample. This means that the amount of cream taken for the composite test jar, must always be proportional to the amount of cream furnished. If cream always had the same richness, or if always the same amount were furnished, the dipper method of sampling would give satisfactory results, provided the cream was thoroughly mixed before sampling. But since we rarely find two batches of cream alike, either in quantity or quality, the necessity of taking an aliquot sample becomes apparent. This may be made perfectly plain by the following illustration :

Feb. 1 patron X furnishes 50 lbs. of 20% cream.

Feb. 2 patron X furnishes 30 lbs. of 30% cream.

Feb. 3 patron X furnishes 20 lbs. of 40% cream.

Dividing the total butterfat furnished during the three days by the total pounds of cream we get 27, which represents the correct average test. This test would be secured by taking aliquot samples. The test by the dipper method would equal the sum of the three tests divided by three. Thus $20+30+40 \div 3=30$, the average test by the dipper method, differing from the correct average test by 3%. By the dipper method the same amount of cream is taken for a sample, regardless of the amount of cream furnished.

Cream Samplers. While an aliquot sample is necessary only where composite samples are made, samplers taking an aliquot sample, like the Scovell, McKay and Michels, have the further advantage of securing a more accurate sample when the cream is not thoroughly mixed. These samplers take a uniform sample from the top to the bottom of the cream in the can. The "milk thief," which also takes an aliquot sample, does not take as satisfactory a sample when the cream is not thoroughly mixed.

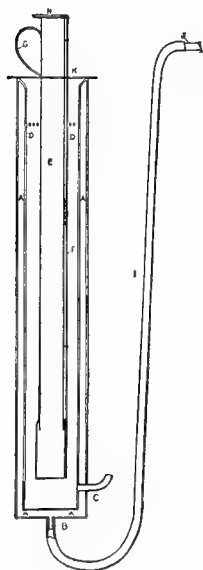

Fig. 25.—Michels sampler.

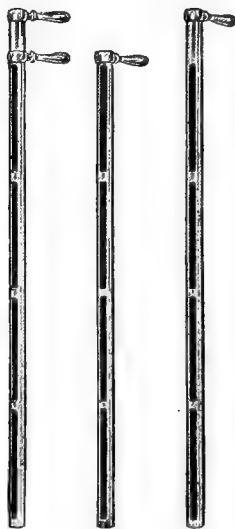

Fig. 26.—McKay sampler.

McKay Sampler. This consists of two tubes, one of which slides into the other. One side of each tube is open so that the cream enters along the entire side of the

sampler. When the sampler is filled the tubes are turned with the openings or slots at right angles to each other, thus closing the sampler and permitting the withdrawal of the sample of cream. See Fig. 26.

Michels Sampler. This consists of a modified Scovell sampler heated in a tin heater as shown in Fig. 25.

A is a steam and hot water reservoir with an inlet at *B*. The steam and hot water discharge through a circle of small openings at *D*. The condensed steam finds exit at *C*. *E* is a Scovell sampler provided with a handle, *G*, and a circular piece of heavy tin, *K*, which holds the sampler in position and prevents the escape of steam. *F* is a strong wire attached to the cap which opens and closes the sampler. The wire ends at the top in a right angle turn, *H*, which rests across the top of the sampler when the latter is open. The construction of the heater prevents the entrance of water into the sampler and necessitates the use of but a very small amount of steam, which is admitted through the steam hose, *I*. The latter connects with the pipe, *J*, leading to the boiler.

When ready to sample, remove the sampler from the heater, plunge at once to the bottom of the can of cream to be sampled, and remove quickly. While holding the composite sample jar in the left hand, discharge the contents of the sampler into it by pressing down on *H* with the thumb of the hand holding the sampler. Owing to the heated condition of the sampler, the cream discharges instantly and, what is equally important, all of it discharges.

The sampler is accurate, quick, convenient and simple, and makes the sampling of heavy, rich cream, or thick, sour cream, no more difficult than that of milk.

The McKay sampler can also be heated in the tin heater and is probably to be preferred to the modified Scovell sample for sampling extremely cold or extremely rich cream.

Scovell Sampler and Milk Thief. These samplers are illustrated and described on page 61.

SAMPLING AND WEIGHING AT THE FARM.

In addition to the regular supply of empty, sterile cream cans, the cream gatherer should be provided with a pair of scales, a cream pail, tubes or jars for carrying the cream samples, a cream stirrer and a sampling tube or a small sample dipper. The dipper may be used when the samples are tested after each delivery. Where composite samples are taken the sampling tube must be used owing to the daily variation in the quantity and quality of cream.

Thoroughly mix the cream before taking the sample. This is best accomplished by pouring it several times from one vessel to another. If the cream is lumpy, the lumps should be broken up with the stirrer. Immediately after mixing the cream, a sample is taken and placed in the patron's sample tube or jar. The receptacle should be plainly numbered and provided with a tight-fitting cover. The cream is then weighed and poured into the regular supply cans.

The samples should be carefully placed in a carrying case where they are protected from breakage and outside temperatures. Promptly on arrival at the creamery the samples are emptied into their respective composite sample jars, if the composite method of testing is followed.

Where the cream is too thick for satisfactory sampling

with the sampling tubes, a proportionate amount of cream may be measured by putting into a graduated tube, with a dipper, say one c.c. of cream for every pound of cream furnished.

SAMPLING AND WEIGHING AT THE CREAMERY.

There are several methods of weighing and sampling in vogue at the present time. One is to sample and weigh the cream in the cans in which it is delivered. In this case the sample is taken with a dipper or sampling tube after the cream has been thoroughly mixed with a stirrer. The cream is then weighed and emptied directly into the cream vat or into a receiving can. From the latter it may be conducted into the cream vat by gravity or by means of a pump. A better method of handling the cream is to pour it from one can to another several times before sampling. This insures better mixing than is possible with the stirrer alone. But even where the cream is poured, the stirrer may be of value in supplementing the mixing, especially in case the cream is lumpy. Weigh the cream in the delivery can or the receiving can and run it by gravity into the cream vat.

In case composite samples are made, an aliquot portion of cream must be taken by means of one of the sampling tubes. And where the cream is not thoroughly mixed before sampling, the Scovell, McKay, or Michels sampler is preferred.

All cream samplers except the Michels must be rinsed in hot water after each sampling. This is especially important when sampling heavy cream.

Where the cream is weighed in the cans, the weight of the empty can should be permanently marked upon it.

TESTING CREAM.

Frequency of Testing. Where the cream is delivered to the creamery in good condition, *composite* samples may be taken in the same manner as with milk. Usually, however, where a great deal of hand separator cream is handled, some of it is delivered in too bad condition for composite sampling. In this case it becomes necessary to test the cream as often as it is delivered.

At present in many of the larger and in some of the smaller creameries, a test is made of each delivery of cream. This practice insures the most satisfactory tests, but requires more work than where composite samples are taken. On this account a great deal of cream is still tested by the latter method.

Where composite samples are made, these are preferably tested once a week and should *never* be tested less than twice a month. See chapter on "Composite Sampling."

Necessity of Weighing Cream. Accurate tests of cream can not be secured by measuring the sample into the bottle as is done in the case of milk. The reason for this is that the weight of cream varies with its richness. The richer the cream the less it weighs per unit volume. This is illustrated in the following table by Farrington and Woll:

Weight of fresh separator cream delivered by a 17.6 c.c. pipette.

Per cent of fat in cream.	Specific gravity (weighed.)	Weight of cream in grams.
10	1.023	17.9
15	1.012	17.7
20	1.008	17.3
25	1.002	17.2
30	.996	17.0
35	.980	16.4
40	.966	16.3
45	.950	16.2
50	.947	15.8

These figures plainly show that justice can not be done to patrons where cream is sampled with a 17.6 c.c. pipette. Cream is therefore always weighed on a cream scales, the amount necessary for a full sample being eighteen grams.

Cream Bottles and Their Uses.

Numerous styles of cream bottles are now upon the market. They range in length from six to nine inches with necks graduated from 30 to 55%. The nine-inch bottles are graduated from 50 to 55% and require special testers on account of their unusual length. These long-necked bottles have the



Fig. 27.—Torsion cream scales.

advantage of permitting the use of a full sample of cream which insures a more accurate reading than is possible where only half a sample of cream is put in an

ordinary cream bottle, or where shorter wide-mouthed 50% bottles are used.

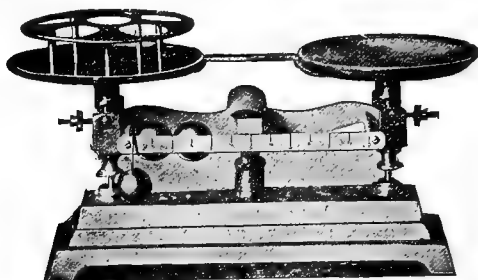

Fig. 28.—Cream scales.

A cream bottle commonly used is the Winton 30% bottle, shown in Fig. 10. With this bottle only half a sample (9 grams) of rich cream can be used. To the half sample of cream a scant half-measure of acid is added, and the testing finished in the usual way. What is better, however, is to add to the nine grams of cream approximately 9 c.c. of water and then use the full amount of acid. Obviously where only half a sample of cream is used in the ordinary bottle, the test must be multiplied by 2 to get the correct reading.



Fig. 29—Nine gram cream bottle.

Lately, a small bore cream bottle (Fig. 29) has been placed upon the market in which only half a sample of cream is used, but which gives a reading for a full sample. This does away with multiplying tests by 2 when only half a

sample is used, and reduces the error in reading by one-half. The small bore of the neck also lessens any error in reading the test.

In testing cream with this bottle, add 9 grams of cream, 9 c.c. of water, 17.6 c.c. of sulphuric acid and proceed with the test in the usual way, remembering that the fat column gives the reading for an 18 gram sample.

Preparing the Sample. Before weighing the cream on the balance, care should be taken to thoroughly mix the sample by pouring and repouring a few times. Should the samples show any dried or churned cream, the sample jars must be placed in water at a temperature of about 110° F. until the lumps of cream or butter have melted. When this is done the sample for the test bottle must be taken instantly after mixing, as the melted fat separates very quickly. In general, warming the sample jars somewhat before sampling by placing them in warm water will facilitate the mixing and sampling of the cream.

Making and Reading Cream Tests. The different steps in testing cream are essentially the same as in testing milk. However, as already stated, the cream must be weighed and tested in a special bottle. Furthermore, special precautions must be used in reading the test.

It is well known that reading the extremes of the fat column gives too high a reading. This error is due to the meniscus at the top of the fat column the size of which varies with the width of the neck. Farrington and Woll recommend reading from the lowest extremity of the fat column to the bottom of the upper meniscus. This is the method commonly employed in reading tests. Eckles and Wayman recommend removing the meniscus by adding a small quantity of amyl alcohol (colored red)

to the top of the fat column. Farrington suggests adding a few drops of fat-saturated alcohol to the top of the fat as a means of removing the meniscus. Ordinary alcohol has a solvent action on butter fat, hence the necessity of using fat-saturated alcohol.

Hunziker* after a thorough investigation of the subject, has found "glymol" best suited for the removal of the meniscus. Glymol is known commercially as white mineral oil and is used for typewriters, sewing machines, etc. It will give satisfactory results without the addition of coloring matter. It may be colored, however, by placing a small cheese cloth bag containing "alkanet root" in a bottle of glymol for a day or two. One ounce of alkanet root will color one quart of glymol.

A few drops of the glymol are sufficient, and should be carefully added to the top of the fat column before reading the test.

To get accurate readings the bottles should be read while the temperature of the fat is between 135° and 140° F. The bottles should be taken from the tester and placed in a water bath having a temperature of 140° F. and kept there several minutes, or long enough to cool the fat to 140° F. The water in the vessel should extend to the extreme top of the fat in the bottles, or preferably a little above. Accurate readings cannot be obtained by reading the bottles directly from the tester; the first bottles removed have too high a temperature while those removed last have too low a temperature.

*Bulletin 145, Indiana Experiment Station.

CHAPTER VIII.

I. THE LACTOMETER AND ITS USE.

This instrument, shown in Fig. 30, is used to determine the specific gravity of milk. The stem has two scales upon it, a thermometer scale at the upper end and a lactometer scale at the lower. The latter scale reads from fifteen to forty, being divided into twenty-five divisions, each of which reads one *lactometer degree*. The lower end of the instrument consists of two bulbs: an upper one containing the mercury for the thermometer scale, and a lower and larger one weighted with shot or mercury which serves to immerse and to keep in an upright position the large oblong bulb or float below the stem.

Making the Test. In making a lactometer test the sample of milk is carefully mixed and placed in the lactometer cylinder. (Fig. 31.) The lactometer is now carefully lowered into it and enough milk is added to the cylinder to fill it brim full. Now place your eye in a horizontal position with the surface of the liquid and read down as far as the liquid will permit. The reading thus obtained is the correct lactometer reading, provided the temperature as indicated by the thermometer scale is 60° .

Corrections for Temperature. Lactometers are standardized at a temperature of 60° F.; but, since it is difficult to have a sample always at this temperature, corrections may be made for temperatures ranging from 50° to 70° . As the temperature rises the liquid expands and the specific gravity decreases. This decrease amounts to

one-tenth of a lactometer degree for every degree of temperature above 60. A decrease in temperature would result in a corresponding increase in the specific gravity. For every degree below 60, therefore, we subtract one-tenth degree from, and for every degree above 60 we



Fig. 30.
Lactometer.

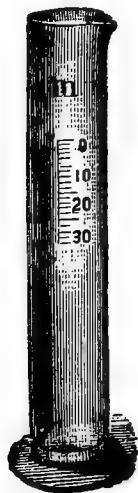

Fig. 31.—Lactometer cylinder.

add one-tenth degree to, the lactometer reading. Examples:

1. Lactometer reading is 32.5 at a temperature of 55. Corrected reading is 32.5 less .5, equals 32.
2. Lactometer reading is 31.7 at a temperature of 63. Corrected reading is 31.7 plus .3, equals 32.

Interpretation of Lactometer Reading. In the chapter on milk we learned that normal milk has an average

specific gravity of 1.032. This means that a tank that holds just 1,000 pounds of water would hold 1,032 pounds of milk. On the lactometer scale the 1.0 is omitted. A reading of 32, expressed in terms of specific gravity, would therefore read 1.032.

Precautions in Making a Lactometer Test. 1. A lactometer test should not be made until three or four hours after the milk leaves the udder of the cow. The reason for this is that milk, immediately after it is drawn, holds mechanically mixed with it air and probably other gases, which tends to give too low a reading.

2. The sample must be thoroughly mixed. If a layer of cream is allowed to form at the surface, the consequence is that the hollow oblong bulb will float in partially skimmed milk and give too high a reading.

3. A dirty lactometer is certain to give a false reading. A lactometer should be washed in luke warm (not hot) water to which a little soda or other alkali has been added, and then rinsed off with clean water and wiped.

II. MILK SOLIDS.

The solids of milk include everything but the water. If a sample of milk be kept at the boiling temperature until all the water is evaporated, the dry, solid residue that remains constitutes the solids of milk. It is convenient to divide the solids into two classes, one including all the fat, the other all the solids which are not fat. In referring, therefore, to the different solids of milk, we speak of the "fat" and the "solids not fat" which, together, constitute the "total solids." The amount of each of these different solids present in milk is easily seen from the composition of milk. Thus, besides water, milk contains:

3.9%	fat	}	= 9. % = solids not fat.
2.9%	casein		
0.5%	albumen		
4.9%	sugar		
0.7%	ash		

Total 12.9% = total solids.

Relationship of Fat and Solids not Fat. In normal milk a fairly definite relationship exists between the fat and the solids not fat. For example, milk rich in fat is likewise rich in solids not fat. On the other hand, milk poor in fat is also poor in solids not fat. As a general rule, an increase in the solids not fat always accompanies an increase in the percentage of fat. The increase is, however, not quite proportionate, the fat increasing the more rapidly.

Since the casein represents the most valuable constituent of the solids not fat, the following ratio between this substance and the fat very well illustrates the relationship that exists between the fat and solids not fat in milk:

According to Van Slyke.

<i>Per cent fat.</i>	<i>Per cent casein.</i>
3.00	2.10
3.25	2.20
3.50	2.30
3.75	2.40
4.00	2.50
4.25	2.60
4.50	2.70

Specific Gravity as Affected by Richness of Milk.

The richness of milk seems to have but a very slight effect on its specific gravity. Usually a four per cent milk shows a slightly higher reading than a three per

cent milk, but the specific gravity of a four per cent milk is practically the same as that of a four and one-half per cent milk. From what has been said about the relationship of the fat and solids not fat in milks of different richness, it is quite natural that the specific gravity of such milks should vary but little. If the fat alone were increased, the lactometer reading would naturally be depressed. But since the solids not fat increase in nearly the same proportion as the fat, the depression caused by the latter is compensated for by the former.

Calculation of Milk Solids. The milk solids are calculated from the fat and the lactometer reading of milk. This is done by means of the following formula worked out at the Wisconsin Agricultural Experiment Station:

Formula for solids not fat equals one-fourth L, R plus one-fifth F, in which L, R stands for lactometer, R for reading, and F for fat. Expressed in another way, *the solids not fat are obtained by adding one-fifth of the fat to one-fourth of the lactometer reading.* The total solids are obtained by adding the fat to the solids not fat. Examples:

1. To calculate solids not fat when the milk shows a lactometer reading of 31.6 and fat reading of 3.5. Substituting these figures for the letters in the formula, one-fourth L, R plus one-fifth F, we get:

$\left(\frac{31.6}{4} \text{ plus } \frac{3.5}{5}\right)$ equals (7.9 plus .7) equals 8.6 equals solids not fat.

2. The total solids in the above sample are obtained by adding the fat and solids not fat. Thus: 8.6 plus 3.5 equals 12.1 equals total solids.

III. DETECTION OF MILK ADULTERATION—WATERING AND SKIMMING.

A knowledge of the methods of detecting watering and skimming of milk is in many cases of considerable value to milk dealers, even when the milk is bought on the fat basis. Where the milk is bought irrespective of its fat content, such a knowledge is simply indispensable for the welfare of the business.

In normal milk ranging in fat from 3% to 5%, it is not difficult to detect a moderate amount of watering and skimming. We speak of *normal* milk because this means the milk from a full milking and excludes colostrum milk, milk from diseased cows and those far advanced in lactation. Normal milk cannot be expected when cows are either only partially milked, diseased, or very far advanced in lactation.

The accuracy of determining the amount of watering and skimming becomes greater in proportion as the sample represents more cows. For example, no sample of milk from a herd consisting of six or more cows has been known to average below 3% fat. For this reason any sample of milk testing below 3%, when taken from a herd, is to be looked upon with suspicion. On the other hand there are records of individual cows that show tests as low as 1.7% and as high as 8%. It is owing to these extreme variations in the composition of milk from individual cows, that small amounts of adulteration cannot be estimated with the same degree of accuracy in such milk as in herd milk.

Detection of Adulteration. The general procedure in determining whether milk has been watered or skimmed, or both, is as follows:

1. Determine the percentage of fat in the sample under consideration.
2. Determine its specific gravity.
3. From the fat and specific gravity calculate the solids not fat and total solids.
4. Compare the results obtained with the average specific gravity, per cent of fat, solids not fat and total solids given for normal cows' milk, or compare with the legal State Standard.
5. In drawing conclusions remember that
 - a. Fat is lighter than water.
 - b. Milk is heavier than water.
 - c. Skimming increases the lactometer reading.
 - d. Skimming slightly increases solids not fat.
 - e. Skimming decreases fat and total solids.
 - f. Watering decreases fat, solids not fat, lactometer reading and total solids.
 - g. Watering and skimming decrease fat (materially), solids not fat, and total solids.
 - h. The solids not fat are less variable than the fat.
 - i. Skimming and watering may give a normal lactometer reading.

From i it is seen that a normal lactometer reading is possible when milk is skimmed and watered in the right proportions. A lactometer reading without a Babcock test is therefore worthless.

For herd milk a lactometer reading above 33.5 is positive evidence of skimming when accompanied with a low percentage of fat. Herd milk showing a lactometer reading below 28 is considered watered.

Examples of milk adulteration in which only herd milk is considered are given as follows:

1. Suspected sample shows:		Normal milk shows:	
Lactometer reading.....	32	Lactometer reading.....	32
Fat	2.5	Fat	3.9
Solids not fat.....	8.5	Solids not fat.....	8.78
Total solids.....	11.0	Total solids.....	12.68

Conclusion: Sample is watered and skimmed because (a) lactometer reading is normal and fat low; (b) solids not fat are nearly normal and total solids low.

2. Suspected sample shows:	
Lactometer reading	33.2
Fat	3.1
Solids not fat.....	8.92
Total solids	12.02

Conclusion: Sample is skimmed because lactometer reading is high and fat low.

3. Suspected sample shows:	
Lactometer reading shows.....	29
Fat	3.4
Solids not fat.....	7.93
Total solids	11.33

Conclusion: Sample is watered because everything is much below normal, which is to be expected in the case of watered milk.

CHAPTER IX.

ACID TESTS FOR MILK AND CREAM.

Milk dealers and buttermakers who have had years of experience do not find it safe to rely upon their noses in determining the acidity of milk or the ripeness of cream for churning. They use in daily practice tests by which it is possible to determine the actual amount of acid present. The method of using these tests is based upon the simplest form of titration.

Titration. This consists in *neutralizing* an *acid* with an *alkali* in the presence of an *indicator* which determines when the point of neutrality has been reached.

Acids and alkalies are substances that have entirely opposite chemical properties. The acid in milk gives it its sour taste, and for our purpose, illustrates very well what we mean by an acid. Ordinary lime may be used to illustrate what we mean by an alkali.

When lime is added to sour milk the acid unites with the lime forming a neutral substance which is neither alkaline nor acid. If we keep on adding lime to the milk we reach a point at which all the acid has combined with the lime. This is called the point of *neutrality*. The moment this point is passed is made visible to the eye by means of the indicator, (phenolphthalein) which is colorless in the presence of an acid but pink in the presence of an alkali. One drop of alkali added to milk after the acid has been neutralized will turn it pink.

In the tests used for milk and cream the alkali used is sodium hydroxide. This is made up of a definite strength so that the amount of acid can be calculated from the amount of alkali used.

Kinds of Tests. There are two tests in general use at the present time: one devised by Prof. Manns and known as the Manns' Test; the other devised by Prof. Farrington and known as Farrington's Alkaline Tablet Test.

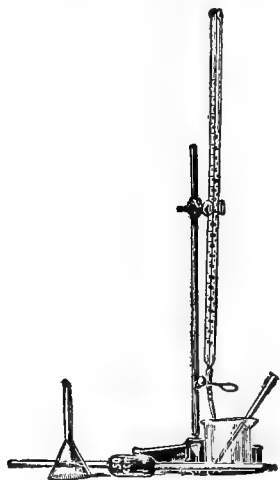

Fig. 32.—Manns' acid test apparatus.

MANN'S TEST.

The apparatus used in this test is illustrated in Fig. 32. It consists of a 50 c.c. burette, a 50 c.c. pipette, a small funnel, and a glass beaker with stirring rod. The alkali (not shown in the figure) can be bought ready made in gallon bottles and is labeled "neutralizer." This alkali or neutralizer is made by dissolving

four grams of sodium hydroxide in enough water to make one liter solution. The solution thus formed is called a one-tenth normal solution, each cubic centimeter of which contains .004 of a gram of sodium hydroxide which will neutralize .009 of a gram of lactic acid.

Making the Test. Measure 50 c.c. of cream with the pipette into the beaker, then with the same pipette add 50 c.c. of water. Now add five or six drops of indicator. Next fill the burette to the zero mark with the neutralizer

and slowly run this from the burette into the cream, shaking the beaker after each addition of alkali. With the first few additions of alkali the pinkish color produced quickly disappears. But when the point of neutrality approaches, the color disappears very slowly and the neutralizer must be added drop by drop only. The moment the cream remains pink indicates that the acid has all been neutralized. The number of cubic centimeters of alkali added to the cream is then noted, and from this the percentage of acid is calculated according to the following formula:

$$\text{Per cent acid} = \frac{\text{No. c.c. alkali} \times .009}{\text{No. c.c. cream}} \times 100.$$

Example: What is the percentage of acidity when 30 c.c. of alkali are required to neutralize 50 c.c. of cream?

$$\frac{30 \times .009}{50} \times 100 = .54\%.$$

From the formula it is evident that any amount of cream may be used for a test. But more accurate results are obtained by using 50 c.c. than less. Where this amount of cream is always used the formula may be considerably simplified.

Thus, by dividing the numerator and denominator by 50, the expression $\left(\frac{\text{No. c.c. alkali} \times .009}{50} \times 100 \right)$ becomes $(\text{No. c.c. alkali} \times .009 \times 2)$ or $(\text{No. c.c. alkali} \times .018)$. The acidity in the problem above would therefore equal $30 \times .018 = .54\%$.

FARRINGTON'S ALKALINE TABLET TEST.

In the Farrington test the same alkali is used as in Manns', but in a dry tablet form in which it is more

easily handled than in the liquid form. Each tablet contains enough alkali to neutralize .034 gram of lactic acid.

Apparatus Used for the Test. This is shown in Fig. 33 and consists of a porcelain cup, one 17.6 c.c. pipette, and a 100 c.c. rubber-stoppered graduated glass cylinder.

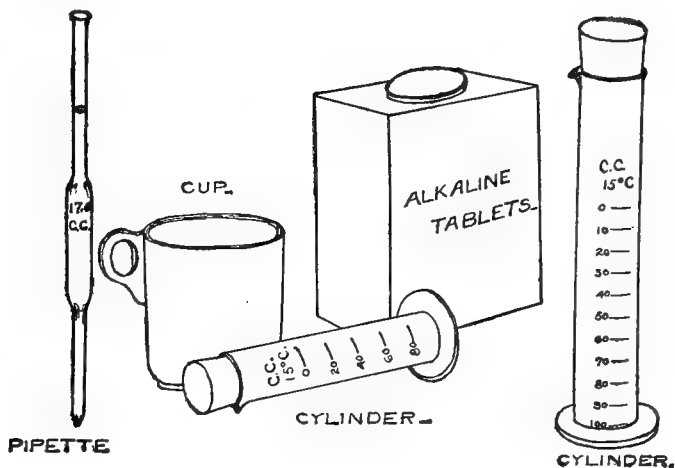

Fig. 33—Farrington acid test apparatus.

Making the Solution. The solution is made in the graduated cylinder by dissolving 5 tablets in enough water to make 97 c.c. solution. When the tablets are dissolved, which takes from six to twelve hours, the solution should be well shaken and is then ready for use. The solution of the tablets may be hastened by placing the graduate in a reclining position as shown in the cut.

Making the Test. With the pipette add 17.6 c.c. of cream to the cup, then with the same pipette add an equal amount of water. Now slowly add of the tablet solution,

rotating the cup after each addition. As soon as a permanent pink color appears, the graduate is read and the number of c.c. solution used will indicate the number of hundredths of one per cent of acid in the cream. Thus, if it required 50 c.c. of the tablet solution to neutralize the cream then the amount of acid would be .50%. From this it will be seen that with the Farrington test no calculation of any kind is necessary.

The acidity of milk may be determined in the same way as that of cream, except that the milk need not be diluted with water before adding the alkali.

A Rapid Acid Test for Milk. Where milk is pasteurized it is often desirable to determine approximately the acidity of each lot as it arrives at the creamery. It has been found that milk that contains more than .2% acid cannot be satisfactorily pasteurized. Farrington and Woll have devised the following rapid method for testing the acidity of milk that is to be pasteurized:

Prepare a tablet solution by adding two tablets for each ounce of water. When the tablets have dissolved, take the solution into the intake. Now, as each lot is dumped into the weigh can a sample of milk is taken with a No. 10 brass cartridge shell and emptied into a teacup. With another, or the same, No. 10 shell add a measure of tablet solution to the cup. Mix the alkali and milk by giving the contents of the cup a rotary motion. If the milk remains white it contains more than .2% acid; if it is colored, there is less than .2% acid present.

Where the tablet solution is prepared as above care must be taken to secure equal quantities of milk and solution for the test.

PRECAUTIONS IN MAKING ACID TESTS.

1. Always thoroughly mix the cream or milk before taking a sample for a test.
2. Prepare the tablet solution and dilute the cream with water as nearly neutral as possible. Soft water is better than hard.
3. Keep the tablets dry and well bottled.
4. Keep the Manns neutralizer and the Farrington tablet solution carefully stoppered with a rubber stopper, as exposure to the air will weaken the solutions by absorbing carbonic acid.
5. With the Farrington tablets it is best to prepare a new solution every day.
6. Make the tests where there is plenty of light so that the first appearance of a permanent pink color can readily be noticed.

RELATION OF RICHNESS AND ACIDITY IN CREAM.

In practice we find that the ripening is slower in rich than in poor cream. The reason for this is that the acid develops in the milk serum, which really should be used as the basis in measuring the degree of acidity, if this were possible.

In a cream testing 25% we find that more acid must be developed to get the desired effects in cream ripening than is necessary in a 35% cream. This is so because in the 25% cream we have the acid distributed through 75% milk serum, while in the 35% cream it is distributed through only 65% milk serum.

If both the above creams show an acidity of .5%, this means that in the poor cream the .5 pound of acid is distributed through 75 pounds of serum, while in the rich

cream it is distributed through only 65 pounds of serum, hence the latter must have the greater intensity of acidity. This may be graphically shown as follows:

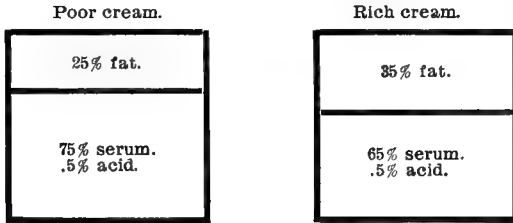

In the illustrations above it is seen that the acid in the rich cream is distributed through less space than in the poor, hence the degree of acidity must be higher in the rich cream.

We find in practice where the same results are to be expected from the ripening process, a 25% cream must show about .6% acidity, while a 35% cream, about .5%.

In bulletin No. 24 of the Washington Experiment Station, Prof. Spillman gives a table showing the required acidity for cream of different richness.

CHAPTER X.

CREAMING.

Cause. Creaming is due to the difference in the specific gravity of the fat and the milk serum. The fat being light and insoluble rises, carrying with it some of the other constituents of the milk. The result is a layer of cream at the surface.

Processes of Creaming. The processes by which milk is creamed may be divided into two general classes: (1) That in which milk is placed in shallow pans or long narrow cans and allowed to set for about twenty-four hours, a process known as natural or gravity creaming; (2) that in which gravity is aided by subjecting the milk to centrifugal force, a process known as centrifugal creaming. The centrifugal force has the effect of increasing the force of gravity many thousands of times, thus causing an almost instantaneous creaming. This force is generated in the cream separator.

Shallow-Pan Method. The best results with this method are secured by straining the milk directly after milking into tin pans about twelve inches in diameter and two to four inches deep. It is then allowed to remain undisturbed at room temperature (60° to 65° F.) for twenty-four to thirty-six hours, after which the cream is removed either with a nearly flat, perforated skimmer, or by allowing it to glide over the edge of the pan after it has been carefully loosened along the sides. The average loss of fat in the skim milk by this method is 0.7%.

Deep-Cold-Setting Method. The best results with this method are secured by using a can like the *Cooley* illustrated in Fig. 34. This can is provided with a cover which allows it to be submerged in water. It also has a spout at the bottom by which the skim milk is gently removed, thus preventing the partial mixing of cream and skim milk incident to skimming with a conical dipper.

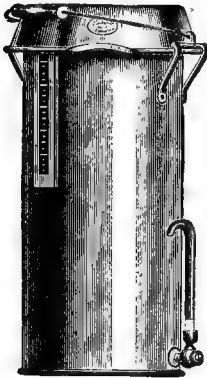

Fig. 34.—Cooley Can.

The milk is put into the cans directly after milking and cooled to as low a temperature as possible. To secure the best results with this method the water should be iced. Where this is done the skim milk will show only about 0.2% fat. It is desirable to allow the milk to set twenty-four hours before skimming, though usually the creaming is quite complete at the end of twelve or fifteen hours.

Dilution or Aquatic Separators. One of the most unsatisfactory methods of creaming is the addition of water to the milk. The creaming by this method is done in variously constructed tin cans, which the manufacturers usually sell under the name of dilution or aquatic separators. Those uninformed about the genuine centrifugal separators are often lead to believe that they are buying *real* separators at a low cost when they are investing five, ten or fifteen dollars in one of these tin cans, which are no more entitled to the term *separator* than are the common shallow pans. The average loss of fat with this system of creaming is about 1½%.

Centrifugal Method (Cream Separator). Dairies having four or more cows should cream their milk by the centrifugal method, the cream separator. The saving of butter fat with this method soon pays for the cost of a separator. Moreover it has the additional advantages over the gravity methods of creaming in providing fresh, sweet skim milk for feeding purposes, and yielding cream of any desired richness.

Efficiency of Creaming With a Separator. Under favorable conditions a separator should not leave more than .05% fat in the skim milk by the Babcock test. There are a number of conditions that affect the efficiency of skimming and these must be duly considered in making a separator test. The following are some of these conditions:

- A. Speed of bowl.
- B. Steadiness of motion.
- C. Temperature of milk.
- D. Manner of heating milk.
- E. Amount of milk skimmed per hour.
- F. Acidity of milk.
- G. Viscosity of milk.
- H. Richness of cream.
- I. Stage of lactation. (Stripper's milk.)

A. The greater the speed the more efficient the creaming, other conditions the same. It is important to see that the separator runs at full speed during the separating process.

B. A separator should run as smoothly as a top. The slightest trembling will increase the loss of fat in the skim milk. Trembling of bowl may be caused by any of the following conditions: (1) loose bearings, (2) sepa-

rator out of plumb, (3) dirty oil or dirty bearings, (4) unstable foundation, or (5) unbalanced bowl.

C. The best skimming is not possible with any separator when the temperature falls below 60° F. A temperature of 85° to 98° F. is the most satisfactory for ordinary skimming. Under some conditions the cleanest skimming is obtained at temperatures above 100° F. The reason milk separates better at the higher temperatures is that the viscosity is reduced.

D. Sudden heating tends to increase the loss of fat in skim-milk. The reason for this is that the fat heats more slowly than the milk serum, which diminishes the difference between their densities. When, for example, milk is suddenly heated from near the freezing temperature to 85° F. by applying live steam, the loss of fat in the skim-milk may be four times as great as it is under favorable conditions.

E. Unduly crowding a separator increases the loss of fat in the skim-milk. On the other hand, a marked underfeeding is apt to lead to the same result.

F. The higher the acidity of milk the poorer the creaming. With sour milk the loss of fat in the skim-milk becomes very great.

G. Sometimes large numbers of undesirable (slimy) bacteria find entrance into milk and materially increase its viscosity. This results in very unsatisfactory creaming. Low temperatures also increase the viscosity of milk which accounts for the poor skimming at these temperatures.

H. Most of the standard makes of separators will do satisfactory work when delivering cream of a richness of 50%. A richer cream is liable to result in a richer skim-

milk. The reason for this is that in rich cream the skim-milk is taken close to the cream line where the skim-milk is richest.

I. Owing to the very small size of the fat globules in stripper's milk, such milk is more difficult to cream than that produced in the early period of lactation.

Regulating Richness of Cream. The richness of cream is regulated by means of a cream screw in the separator bowl. When a rich cream is desired the screw is turned toward the center of the bowl, and for a thin cream it is turned away from the center.

Advantages of Rich Cream. To separate a rich cream at the farm results in mutual benefit to producer and manufacturer. The main advantages are as follows: (1) Less bulk to handle; (2) less cream to cool; (3) less transportation charges; (4) more skim-milk for the farmer; (5) better keeping quality; (6) allows more starter to be added; (7) gives better results in churning, and (8) makes pasteurization easier, especially with sour cream.

Best Time to Separate Milk. The best results with a separator are obtained by running the milk through the machine immediately after milking.

Saving of Butter Fat with a Separator. That the owner of four good cows can afford to invest \$50.00 in a small cream separator is shown by the following: Four good cows will yield not less than 24,000 pounds of milk a year. By the common shallow pan method of creaming, the loss of butter fat will average 0.7 pound for every 100 pounds of milk. With the centrifugal separator the loss of fat will not average over 0.05 pound, hence there will be effected a saving of 0.65 pound of

butter fat in each 100 pounds of milk by the use of the separator. At this rate, the total saving of butter fat annually on the 24,000 pounds of milk will be 156 pounds. Since each pound of butter fat will yield approximately 11-6 pounds of butter, 183 pounds of butter will be saved by the process, which, at 25 cents per pound, amounts to \$45.75. This saving in butter fat alone will almost pay for the separator in one year.

Fastening a Separator. To secure steady motion, the separator must be fastened to a solid foundation. There is nothing better in this respect than a concrete floor, with which every dairy should be provided.

One of the best methods of fastening separators to concrete floors is the use of expansion bolts.

These consist of lag screws with tapering points provided with malleable shields, having threads on their inner sides to fit the threads of the lag screws and projections on their outer sides to catch and hold in holes made in the concrete. The shields expand as the lag screw is screwed in.



Expansion Bolt.

Heating Milk Before Separating. Milk received in a cold condition should be heated to about 85° F. before separating. There are two classes of heaters on the market for this purpose: those which admit the steam directly to the milk, known as direct heaters, and those

which permit the steam to enter a jacket surrounding the milk, known as indirect heaters. Only *indirect* heaters should be used in heating milk to the separating temperature.

The two main objections to the direct heaters are: (1) the liability of contaminating the milk with impure steam, and (2) the effect of the sudden heating upon the loss of fat in the skim-milk which may be quite considerable when the milk is heated through a long range of temperature.

It is well known that the exhaustiveness of skimming with any separator is greatly influenced by the manner in which the milk is heated. In general very sudden heating has the effect of diminishing the difference in the specific gravity between the fat and milk serum, consequently rendering the separation of the fat from the milk more difficult.

In experiments conducted by the author it was found that in many instances where the milk was received in a partly frozen condition and suddenly heated to a separating temperature of 80° to 85° F., the loss of fat in the skim-milk was from .08% to .12%.

The addition of water to the milk through the condensation of the steam is also objectionable in heating milk with steam direct. The practice of turning steam into milk should therefore be abandoned.

CHAPTER XI.

COLD STORAGE.

An efficient cold storage is an indispensable asset in the manufacture of ice cream and in the proper handling of market milk and cream. Too many try to economize in first cost at the expense of insulation. This is false economy because money spent in securing thorough insulation will save enough in ice or refrigeration to pay for the extra cost in a short time.

The accompanying illustration (Fig. 35) shows a method of construction which has been found very satisfactory, especially in larger plants. It will be noted that the walls, floor and ceiling are insulated with cork, which is one of the best of insulating materials. It is necessary, however, to use every precaution to keep the cork free from moisture. Thorough treatment of the surface with asphalt will render it practically waterproof. Two thin layers of cork are preferred to one thick layer because the breaking of joints prevents leakage at the edges.

The inside walls and any partitions are constructed of four-inch hollow tile lined with two courses of $1\frac{1}{2}$ inches of sheet cork.

Anteroom. Cold air is relatively heavy and when the storage doors open directly into a large warm room the air rushes out as though it were water, causing a considerable loss of cold. Such loss can be prevented to a large extent by providing an anteroom, which is

simply a compartment about four feet wide and built along the front of the refrigerator. By having the anteroom doors closed when opening the refrigerator doors, little cold air will escape.

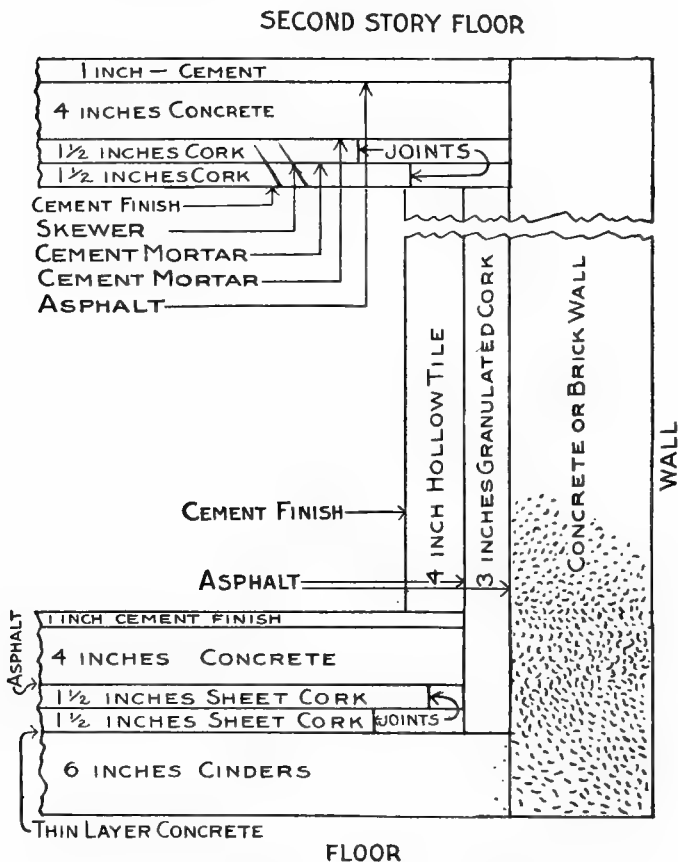

Fig. 3.—Showing Construction of Cold Storage.

Doors: Special care should be exercised in securing tight-fitting doors with heavy flanges; they should also have the same degree of insulation as the other parts of the refrigerator.

Forced Circulation of Air. To prevent dampness, mold and mustiness in cold storage rooms, circulation of air is absolutely essential. Usually a reasonable de-

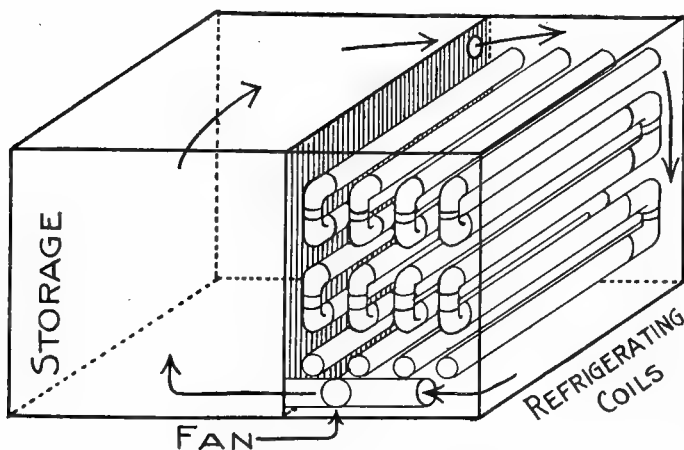

Fig. 36.—Showing Method of Forced Circulation.

gree of circulation is secured without resorting to mechanical methods of forcing, but forced circulation will produce the best results and is recommended for all large refrigerators. The refrigerating coils should be in a room separate from the cold storage as shown in the accompanying illustration (Fig. 36) which also shows the method of producing forced circulation. A fan located at the floor of the refrigerating room, forces the refrigerated air into the cold storage rooms, causing the warm air of the latter to escape through an

opening at ceiling, whence it passes over the refrigerating coils. Here it becomes cooled and freed from its moisture, to be again forced into the cold storage room by means of the fan.

Frequent removal of the ice accumulating on the refrigerating coils is necessary to maintain the best storage conditions.

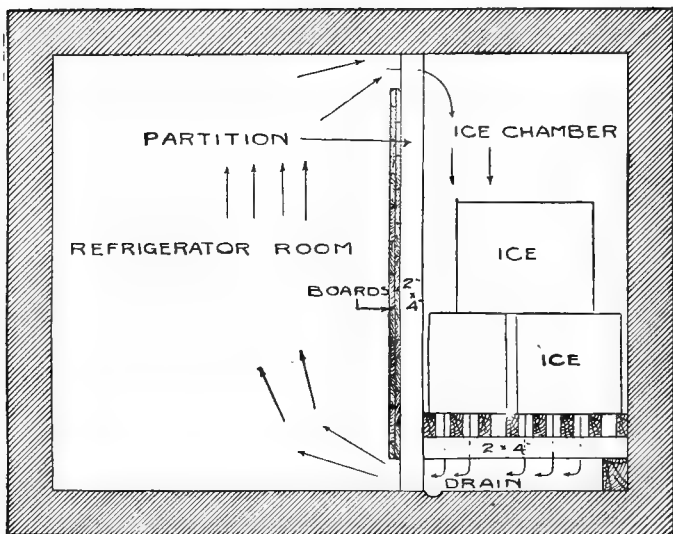

Fig. 37.—Section Through Refrigerator Having Ice Chamber at One End.

Natural Circulation. The best natural circulation is secured by having the refrigerating pipes in a room directly above the cold storage. Air shafts are provided which conduct the cold air from the floor of the refrigerating room to the floor of the cold storage room. Similar shafts extend from the ceiling of the storage room to the top of the refrigerating coils.

Refrigerating Coils in Storage Room. Where forced circulation is not available, the usual method of cooling rooms for storage purposes is to arrange a series of direct expansion pipes at the ceiling and along the walls near the ceiling. In case the refrigerating machinery is not operated during the night it will be necessary to use a brine tank in addition to the direct expansion coils. The purpose of the brine tank is to store

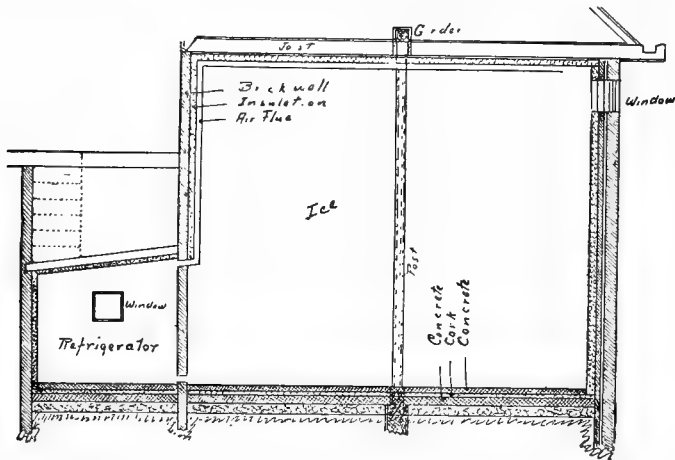

Fig. 37½—Insulated Ice House Joined to Refrigerator. From Bulletin 41, Minn. Dairy & Food Commission.

cold to be drawn upon when the machinery is not running. The tank should be located near the ceiling where it will serve practically the same purpose as an overhead ice box. See page 297.

Storage Rooms Cooled With Ice. In small dairy plants not provided with mechanical refrigerating machinery, a refrigerator or cold storage with an ice chamber at one end is commonly used. The construction of the ice chamber is shown in Fig. 37. The ice chamber

is filled periodically from an adjoining ice house.

A more satisfactory arrangement for refrigerating with ice is to have the ice house take the place of the ice chamber shown in Fig. 37½. This, of course, requires an ice house with the same degree of insulation as that of the refrigerator itself, because no saw dust is used in packing the ice.

Connecting the refrigerator directly with the ice

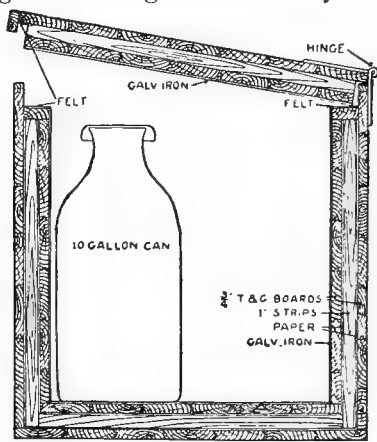

Fig. 38.—Ice Box for Small Dairymen.

house dispenses with the handling of ice, produces better circulation and therefor results in a drier and cooler refrigerator. The increased circulation is due not so much to the larger mass of ice with which the air comes in contact as to the greater height of the ice house. Circulation may be reduced, if desired, by regulating or closing the opening at the ceiling by means of a slide or register.

Cold Storage for Small Dairymen. A temperature of 40° F. may be maintained in a simple ice box, constructed as shown in Fig. 38.

The box consists essentially of two boxes separated by one-inch strips placed at intervals of about one foot. Double thickness of building paper is placed on both sides of the strips and tacked to the boxes. A one-inch strip, two inches wide, covers the upper space between the one-inch strips, thus making a dead-air space between the two boxes. The construction of the cover is the same as that of the bottom, with the exception that there is a flange at the front and sides of the cover. The sides, bottom and cover of the refrigerator are built of three-quarter-inch tongued and grooved lumber, five and a half inches wide. The ends are constructed of one and one-eighth-inch tongued and grooved flooring three and a half inches wide. The inside of the ice box is lined with galvanized iron. A rope provided with a heavy weight and running over an overhead pulley, makes it easy to raise and lower the cover. A drain is provided at the bottom. The cost of such an ice box, 7x2.5x2.5 feet, is approximately \$30, including both labor and material.

The efficiency of the ice box is materially increased by filling the one-inch space with granulated cork.

CHAPTER XII.

PASTEURIZATION OF MILK AND CREAM.

The term pasteurization is derived from the discoverer of the process, Pasteur, an eminent French scientist, who is justly called the Father of Bacteriology. Originally this process was applied to wines to rid them of undesirable fermentations. Pasteurization as applied to milk and cream consists in heating and cooling milk and cream in a manner which will destroy the bulk of bacteria in them, but which will leave their chemical and physical properties unchanged as far as possible.

Advantages of Pasteurization. The advantages to be derived from pasteurization vary with the conditions under which the milk is produced and the efficiency with which the work is conducted. If the milk comes from dairies where disease and uncleanness prevail, pasteurization will prolong the keeping quality of the milk and also materially lessen, or entirely eliminate, the danger from disease germs. If, on the other hand, healthfulness and cleanliness receive the exacting attention which prevails on certified dairy farms, comparatively little is gained by subjecting milk to the pasteurizing process.

Under existing conditions, thorough pasteurization of milk and cream is desirable, for several reasons: In the first place average unpasteurized market milk contains over 1,000,000 bacteria per c. c., and none of this can be guaranteed free from pathogenic organisms. Milk that comes nearest to being free from pathogenic and other classes of bacteria, is certified milk, but even

this class of milk, in exceptional cases, contains disease producing bacteria.

The large number of bacteria in average market milk is especially harmful to babies, because a large percentage of the bacteria belong to the putrefactive and closely allied kinds, which in a large measure are responsible for the prevalence of diarrhea and general gastro-intestinal troubles and, therefor, for the high mortality among infants and children. By properly pasteurizing milk, at least 95% of the general mass of bacteria may be destroyed, while all of the strictly pathogenic bacteria, like the typhoid and tubercle bacilli, may be entirely eliminated.

Pasteurization Growing in Popularity. Among large milk dealers, pasteurization has long been popular, partly because of the protection it has afforded them against spreading disease among their customers, but chiefly because of the material increase in the keeping quality of the milk resulting from this treatment.

Until recently, however, consumers and health authorities have been divided as to the advisability of pasteurizing milk for city trade. This attitude on the part of consumers and health authorities has largely been due to faulty methods and slipshod work which have been so characteristic of much of the pasteurizing work in the past.

At present there is unmistakable evidence that pasteurization of milk and cream for city trade is rapidly gaining favor, both among health authorities and the public in general. Two reasons may be given for the change in attitude toward pasteurization: First, the realization that no positive assurance can be given that raw milk is free from pathogenic bacteria; secondly, the

increased confidence of the public in the efficiency of the pasteurizing process, resulting from the gradual elimination of the continuous or flash process and the substitution therefor of what is known as the "holding" or "held" process, by which the milk is kept at a temperature of about 145° F. for 30 minutes or longer.

With the continued increase in the efficiency of pasteurizing methods, pasteurization of milk and cream for city trade is bound to increase in popularity.

Processes of Pasteurization: There are two processes of pasteurizing milk and cream: (1) the "continuous" or "flash" process by which the milk is permitted to pass in continuous stream through the pasteurizer and is subjected, on an average, less than one minute to the pasteurizing temperature; (2) the "held" or "holding" process by which every particle of milk is heated from ten to sixty minutes according to the degree of heat employed.

Obviously where milk is heated only a minute, a higher temperature must be employed than where the time of exposure is longer. With the "flash" method the temperature varies from 165° to 180° F. and the time of exposure averages less than one minute. In case of the "held" process, the temperature ranges from 140° to 150° F. and the time of exposure from ten to sixty minutes. Low temperatures must be maintained for a longer time than high temperatures to accomplish the same result. The temperature and time of exposure should always be such as to insure the destruction of the tubercle bacillus, which is one of the most resistant of the disease bacteria most commonly found in milk.

Objections to the Flash Process: With the flash process reasonably satisfactory results in destroying bac-

teria cannot be obtained unless the milk is heated to 176° F. But a stream of milk coming from a flash machine and showing a temperature of 176° F., does not necessarily mean that every particle of the milk is heated to this temperature; indeed, quite the contrary is to be expected. It is easily conceivable that where milk passes through a machine in a constant stream, some particles

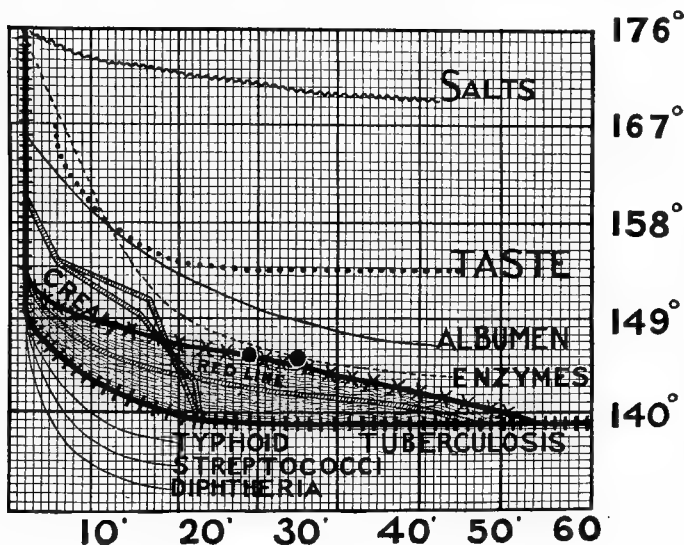

Fig. 39.—Chart by Dr. North.

will be heated higher than others, that is, some particles will exceed 176° while others will fall short of this temperature. It is generally conceded that perfectly uniform heating is practically impossible with the flash process, and for this reason it is perfectly possible for some bacteria with a thermal death point of 176° F., or even lower, to escape destruction by this process.

In addition to the lack of uniform heating, the flash or continuous process has several other drawbacks, due to the relatively high temperature necessary to destroy the bacteria: (1) it materially interferes with the rising of the cream and therefore tends to destroy what is known as the "cream line;" (2) it tends to give milk a cooked taste; and (3) it tends to impair the digestibility of milk.

In substantiation of the charges against the flash process, attention is called to the chart (Fig. 39) prepared by Dr. Chas. E. North of the New York City health department.

In this chart the figures at the bottom represent minutes, while those at the side represent degrees Fahrenheit. Starting at the top, there is a wavy line marked "salts" which shows that the salts of milk are not affected until exposed for one minute at 176°. At lower temperatures, a longer exposure is necessary to affect the salts.

The dotted line marked "taste" shows that the taste of milk is affected by keeping it at a temperature of 167° for several minutes. At 150° an exposure of 40 minutes does not affect the taste of milk.

The solid line marked "albumen" indicates that this constituent of milk is affected at an exposure of 165° for one minute. At an exposure of 40 minutes it does not become affected until a temperature of 147° is reached.

Looking next at the broken line marked "enzymes," it is seen that these digestive ferments of milk become affected at an exposure of 174° for one minute. At 145° they do not become affected until an exposure of 45 minutes is reached.

Next is the heavy line marked with crosses, which indicates the time and temperature at which the cream line becomes affected. Thus it will be seen that one minute's exposure at 155° affects the cream line. At 145° the cream line does not become affected until exposed for 35 minutes.

The balance of the chart indicates the time and temperature at which some of the common disease producing bacteria are destroyed. Most resistant of the disease bacteria is the tubercle bacillus whose thermal death point is shown by the heavy line marked like a railroad track. An exposure of one minute at 176° , or 20 minutes at 140° , will kill this bacillus. The typhoid bacillus is destroyed at an exposure of 150° for one minute, or 140° for ten minutes. Streptococci and the bacteria causing diphtheria are both destroyed by heating for one minute at 150° ; an exposure of 10 minutes will destroy both at less than 140° .

The two parallel light lines marked "red line" and running midway between the two heavy dark lines, indicate the line of safety in pasteurizing milk and cream. Going much below this line will not kill the tubercle bacillus and going much above it will affect the cream line.

Dr. North properly draws the conclusion from this table that a temperature of 145° maintained for 25 minutes is about the most ideal.

Other Considerations in Pasteurization. While the foregoing chart, together with what has been said in regard to the lack of uniformity of heating, clearly condemns the "flash" process as an unsafe and undesirable method of treating milk, there is another matter to consider which makes the "flash" process seem still more

undesirable as compared with the "held" process. Besides the disease bacteria mentioned on the chart, there are large numbers of other bacteria in milk some of which are even more difficult to destroy than the tubercule bacillus. These bacteria, while perhaps harmless to adults are known to have an irritating effect on the digestive system of babies and children. And because of these bacteria and as a matter of safety so far as bacteria in general are concerned, some of the leading city milk dealers have found it desirable to expose milk at 145° for an whole hour. These milk dealers have found it wise to pay less attention to the milk constituents and more to the bacteria.

In the destruction of bacteria by the pasteurizing process, it is never safe to employ temperatures which closely approximate the thermal death point of those particular bacteria which it is desired to destroy. The ups and downs in the pasteurizing temperature, the inaccuracies in thermometers, and the changing conditions in the milk itself from one day to another, make it advisable to employ temperatures appreciably in excess of those absolutely necessary to destroy the bacteria under normal conditions.

Milk that has been underheated is more dangerous than that which has not been heated at all. The reason for this is that inadequate heat in pasteurizing may destroy the lactic acid bacteria (which are easily killed) and by so doing actually better the conditions for the growth of the more resistant and obnoxious kinds. Lactic acid organisms are antagonistic to other classes of bacteria and are therefore a real safeguard to milk. This makes it plain that unless milk is pasteurized at a temperature which will destroy the pathogenic and non-acid bacteria

as well as the acid bacteria, it is far better not to heat it at all.

Pasteurization should be condemned where its only object is to keep milk sweet. Its real object should be to destroy all actively growing bacteria and especially all disease-producing organisms such as the tubercle bacillus which is among the most resistant.

The "Held" Process. In view of the large amount of data bearing upon the inefficiency of the "flash" process in pasteurizing milk, the wise milk dealer will equip himself with machinery by which milk can be held at a temperature of 145° F. for 30 minutes or longer. There is no longer any question that to render milk safe from pathogenic bacteria it is necessary to employ the held or "holding" process of pasteurization. By this process all milk can be uniformly heated and held at the proper temperature long enough to insure the destruction of all bacteria except those in a spore condition. Fortunately the common pathogenic bacteria are not spore-bearing and hence are easily destroyed by this method of pasteurization.

For general arrangement of machinery for pasteurizing milk by "held" process, see Fig. 69, page 322.

New York and Chicago Pasteurizing Regulations: In order to secure greater efficiency in pasteurizing milk, a number of cities have adopted ordinances making it necessary for milk dealers to heat milk to certain minimum temperatures. Thus New York City imposes the following restrictions with reference to temperature and time of exposure:

No less than 158 degrees F. for at least 3 minutes.

No less than 155 degrees F. for at least 5 minutes.

No less than 152 degrees F. for at least 10 minutes.

No less than 148 degrees F. for at least 15 minutes.

No less than 145 degrees F. for at least 18 minutes.

No less than 140 degrees F. for at least 20 minutes.

Chicago has the following regulations:

A uniform heating of 140 degrees F. maintained for 20 minutes.

A uniform heating of 150 degrees F. maintained for 15 minutes.

A uniform heating of 155 degrees F. maintained for 5 minutes.

A uniform heating of 160 degrees F. maintained for 1½ minutes.

A uniform heating of 165 degrees F. maintained for 1 minute.

Necessity of Clean Milk for Pasteurizing. Contrary to general public opinion, milk to be pasteurized must be especially clean to make it a safe food for babies. The reason for this is the fact that the pasteurizing process does not destroy the bacterial spores which are always associated with unclean milk, and a large percentage of these spores belong to the putrefactive kind. In ordinary unpasteurized milk, these spores are held in check by the rapid development of the lactic acid bacteria, which are first to succumb in the pasteurizing process.

The ordinary pathogenic bacteria are not spore-bearing but the putrefactive and many other obnoxious kinds of bacteria are spore-bearing. These putrefactive spores, which come from manure and other filth, develop rapidly in pasteurized milk kept at high temperatures.

Importance of Low Holding Temperature. While filthy milk, as pointed out above, is rich in bacterial spores, there is perhaps no milk entirely free from them.

On an average about 2 per cent of the total bacteria found in milk are present in the spore stage in which they cannot be destroyed by the pasteurizing process; hence the necessity of holding milk at such low temperature as will prevent the development of these spores into actively growing organisms. These spores, if enabled to develop sufficiently, will impart undesirable flavors to milk; and, furthermore, it is these putrefactive kinds which are responsible, too, for a great many diarrheal and gastro-intestinal troubles of children. Pasteurized milk may appear perfectly sweet to the consumer but may be actually dangerous to children if it is kept at temperatures which will permit a rapid development of putrefactive and other kinds of spores. To keep pasteurized milk in a good condition, its temperature should not be allowed to exceed 50° F., and much lower temperatures are desirable.

Viscogen. Thorough pasteurization reduces the viscosity or whipping property of cream. To assist in restoring the original viscosity, a solution of sucrate of lime is added which is known as viscogen. This solution is made by adding an excess of slaked lime to three parts of sugar dissolved in five parts of water. The mixture is allowed to stand twenty-four hours, after which the clear liquid at the top is poured from the sediment and preserved in a stoppered bottle at a low temperature.

Add one part viscogen to about 150 parts of cream. Never add so much as to render the cream alkaline.

While viscogen is entirely harmless, it is nevertheless an adulterant and cream treated with it must be labelled so as to indicate that it has been treated with viscogen.

By holding pasteurized cream at low temperatures a

sufficient length of time, its whipping property is sufficiently restored to make the use of viscogen unnecessary.

PASTEURIZING MILK IN BOTTLES.

While the "held" process of pasteurization has been a big step in advance of the "flash" process, it does not fulfill all that is desired in ideal pasteurization. With both processes there is too much opportunity for reinfection of the milk after it leaves the pasteurizer. The milk cooler, pipes, air, bottle caps, bottles and employes—all subject milk to possible contamination. To show the possible seriousness of such contamination, an instance is cited by Dr. C. E. North in which 85 cases of typhoid fever were traced to milk which had become infected through a "typhoid carrier" whose business it was to cap the bottles.

It is evident that the only way to avoid reinfection is to pasteurize the milk after it has been bottled and capped, and a fairly large number of milk dealers are already pasteurizing milk in this way with very satisfactory results.

Bottle Caps. To pasteurize milk in bottles, water-tight caps are necessary. Metallic caps lined with paraffined paper discs, are now used to a considerable extent, not only where milk is pasteurized in bottles but for ordinary handling of milk as well. These caps are similar to those used on beer bottles and are fastened in a similar manner, thus sealing the bottles against entrance of air and water as well as against possible tampering with the contents. Special bottles and machinery for applying the caps are now available everywhere.

Pasteurizing Apparatus. The practicability of pas-

teurizing bottled milk on a commercial scale is shown by Dr. C. E. North in Medical Record for July 15, 1911. Dr. North has found that the apparatus used by brewers in pasteurizing bottled beer, can be adapted to pasteurizing milk in bottles with satisfactory results. The results obtained by him in pasteurizing milk for thirty minutes at a temperature of 148° F. in a beer pasteurizer, are shown in the following paragraphs:

“Raw milk, bacteria per cubic centimeter in the several samples, 250,000; 450,000; 200,000; 900,000; 70,000.

Pasteurized top layer, bacteria per cubic centimeter, 500; 100; 300; 2,100; 500; 600; 100; 500; 200; 400; 200; 200.

Pasteurized second layer, bacteria per cubic centimeter, 1,000; 400; 200; 600; 1,000; 0; 100; 200; 100; 200; 0; 400.

Pasteurized third layer, bacteria per cubic centimeter, 800; 2,500; 400; 200; 300; 600; 300; 500; 300.

Pasteurized fourth layer, bacteria per cubic centimeter, 600; 400; 600; 300; 1,800; 400; 300; 600; 400; 300; 100.”

Commenting on the low bacterial counts obtained in these experiments, Dr. North says: “I have never before obtained from any pasteurizing apparatus of the commercial type results which nearly approached these in excellence.” He further adds: “In less than an hour after leaving the pasteurizer, the milk in all of the bottles had developed a distinct cream line, and the amount of cream appearing at the top of each bottle was sufficient to indicate that the rising of the cream had not been in any way impaired. The milk was pleasant to the taste and possessed no odor or taste which would suggest that it had been heated.”

The beer pasteurizing apparatus works automatically, the bottles passing successively from one compartment to another until the pasteurizing is completed. The water in the first compartment registers about 110° F. From this point on, the water grows gradually hotter until the proper pasteurizing temperature has been reached, and then gradually drops to 60° F. These machines have been adapted for milk by adding another compartment in which the milk can be cooled below 50° F. During the pasteurizing the bottles are completely immersed, and the results with beer as well as with milk have been found more satisfactory when the pasteurizing is done with water than when steam is used.

Undoubtedly apparatus will soon be found upon the market which will answer the purpose of small milk dealers. Many of the smaller milk dealers are now pasteurizing bottled milk in a simple water tank.

CHAPTER XIII.

HOW TO SECURE A GOOD MARKET.

Quality. As a rule it is easy enough to secure some kind of a market, but to secure the best frequently requires considerable effort. To get fancy prices requires first of all that the product be of superior quality. This is particularly true of milk. The extensive agitation in recent years for clean, pure milk has had the effect of putting a high premium upon such milk. The public is becoming aware of the dangers which lurk in dirty, unsanitary milk and is willing to pay a good price for milk whose wholesomeness is unquestioned.

Value of Advertising. To obtain big prices it is not enough to have products of superior quality, but whatever particular merits they have must be forcibly brought to the attention of consumers. In other words, a certain amount of advertising is necessary.

It is good policy to furnish prospective customers a few free samples and to distribute leaflets describing the conditions under which the products are produced and handled. If the milk is produced in clean, ventilated, whitewashed stables, and from cows which are regularly tested for tuberculosis; if the milk is handled by clean, healthy attendants and is thoroughly cooled and aerated immediately after milking; and if, in addition, all this is certified to by a competent inspector, an increase in prices and patronage is certain to follow when such facts are placed before the public.

The majority of city consumers have little conception of the conditions under which average milk is produced. For this reason the man who is producing clean milk will find it highly profitable to place in contrast vivid pictures of the conditions that yield *average* milk and those that yield *sanitary* milk.

Investigate Outside Markets. Often outside markets offer better prices for milk and cream than does the home market. This is especially true of cream. This product permits of long distance shipping and many outside markets may be glad to get it at fancy prices when the home market may be entirely overstocked.

Dairymen must not expect the market to come to them, however; they must seek the market. A visit or correspondence with managers of cafés, hotels, restaurants, drug stores and ice cream manufactories in different cities, is frequently the means of securing more business and better prices.

Where one is just starting in the dairy business or trying new markets, it is good policy, as a rule, not to ask very high prices at the start. First demonstrate the merits of your products. If these are of a high order consumers will gradually respond to demands for increased prices rather than lose the products. Too high prices at the start are likely to discourage prospective buyers, and thus deprive you of an opportunity to prove the value of your goods.

Uniformity. One of the essentials in building up a good market is uniformity of product. Where this is lacking, improvements in other directions will be of little avail. On the other hand, products which are uniformly the same, week after week, and month after month, are

likely to command good prices even when of only medium quality.

Punctuality. Another essential in building up a good market is punctuality. If your customer expects his milk at 7:30, do not deliver it at 7:40; deliver early rather than late. If you are shipping cream or milk you cannot afford to miss your train—even a single time. It generally means greater disappointment at the other end of the line than one would anticipate.

Try to Please. Always put yourself in an attitude to please. If criticisms come concerning your products, you cannot afford to resent them. Usually there is reason for the criticism. Try to discover the trouble and remedy it.

Delivery Outfit. Cleanliness and neatness must characterize the dairy business throughout. Milk wagons, cans, bottles, drivers, etc., must present a clean appearance. Where they do not, it is usually an easy matter to surmise the condition of milk.

Use a Trade Mark. The name or monogram of the dairy, placed upon the products and delivery wagons, guarantees genuineness and will materially assist in securing a better and more extended market. It is one of the best ways of advertising a superior product.

Secure Your Market Early. If it is intended to sell cream for manufacture into ice cream, it is important to get a market early in the spring. It is difficult to find one in the flush of the ice cream season, because ice cream dealers, as a rule, contract considerably in advance of the time they need the cream. If it is intended to supply winter resorts, apply for the market early in the fall. What has been said here with reference to cream applies also to milk.

Secure Reliable Customers. Where milk and cream are shipped some distance, it is important to determine beforehand the reliability of the buyer. As a rule it is good policy not to make more than three shipments before the first has been paid for. It is well, even where milk and cream are sold locally, to investigate the standings of customers before their accounts have run up very high.

Selling Direct to Consumers. No argument is needed to show the advantage of selling dairy products direct to consumers wherever this is possible. It means the elimination of the middleman whose profits are saved to the dairyman.

Letterhead Stationery. It is not only businesslike to use stationery with a suitable letterhead, but it also serves to advertise the business. The following is submitted as a suitable form of letterhead:

Springdale Sanitary Dairy.

J. C. Boone, Prop.

Dealer in

Pure, Bottled, Jersey Milk and Cream

from Tuberculin Tested Cows.

Reidsville, N. H. 190..

CHAPTER XIV.

MARKETING MILK AND CREAM

RETAILING.

Dip Method. The old method of hauling milk to the city in five, eight or ten gallon cans and removing each patron's allowance by means of a dipper or faucet, has been found so objectionable that the practice has been largely abandoned. The principal objections to this method are: (1) The admission of dust and bacteria to the milk while measuring it; (2) the use of unsterilized milk vessels by consumers; (3) exposure of the vessels to dust while on the steps of the consumer; (4) the use of unclean vessels by milkmen in measuring each customer's share; (5) lack of uniformity in the milk, especially if removed from the cans by means of a faucet, in which case the first drawn milk is likely to be lowest in fat content; and (6) the possibility of drivers tampering with the milk.



Milk Bottle.

The Use of Bottles. Milk and cream intended for retail trade should be put into pint or quart bottles, for reasons cited above. The advantages of this method are apparent from the fact that the milk is bottled immediately after cooling and that it may be

kept in the same bottle until it is to be consumed. Whenever milk is changed from one vessel to another there is always more or less contamination from dust and bacteria.

Bottling. For dairies having from ten to twenty cows, a can or vat provided with a sanitary faucet will do satisfactory work in filling bottles. A pouring can with a slightly curved spout may also be used for this purpose.

For large dairies special bottle fillers will be found advantageous. These machines fill from two to twelve bottles at a time. In selecting a bottle filler secure one of simplest construction. This is important for sanitary reasons.

Whatever method of filling is used, it is important to keep the milk well stirred while filling, so as to insure uniform quality in all the bottles.

Special machines are now on the market for capping bottles. With the larger machines it is possible to cap many thousands of bottles in a day. The machines not only have the advantage of rapid capping, but eliminate possible infection from the hands where the capping is done by hand.

The tendency at present is to seal the bottles with hermetic seals similar to those used on beer bottles. This insures against tampering, protects the lips of the bottles and makes possible pasteurization of the milk in bottles. A bottle so capped is shown in Fig. 40.

The bottles should be capped immediately after filling and only the best quality of caps should be used. Caps which lack stiffness or which have been poorly paraffined usually can be bought cheaply but they will prove expensive at any cost.

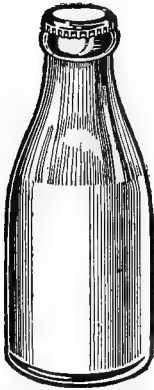

Fig. 40.—Bottle Capped with Hermetic Seal.

During bottling the room should be kept damp to keep the air free from dust and bacteria. No air currents should be allowed to sweep in from the outside. Only clean laundered white suits should be worn by those in charge of the cooling and bottling.

Milk Bottle Delivery Cases. On delivery wagons the bottles are carried in cases holding twelve or more bottles each. These cases are made of galvanized iron or wood, or of both, and have light removable partitions inside, separating the bottles to keep them from breaking. Galvanized iron cases, like that shown in

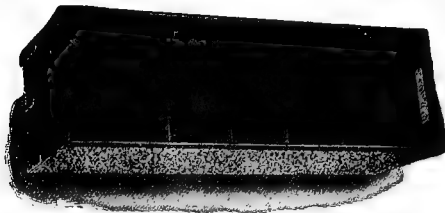

Fig. 41.—Galvanized Iron Milk Bottle Case.

Fig. 41, are the most sanitary and also permit putting crushed ice around the bottles.

Fig. 42 shows a galvanized iron milk bottle case, enclosed by a box made of one-inch boards and provided with a tight fitting cover. Cases of this kind should be used in warm weather to keep the milk cool during

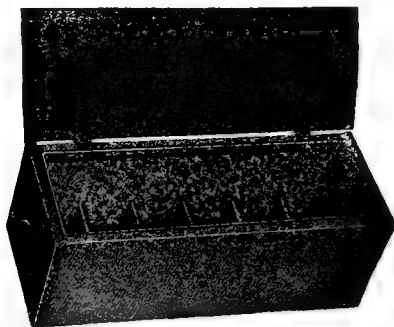

Fig. 42—Insulated Galvanized Iron Milk Bottle Case.

delivery. On especially warm days, crushed ice should be used around the bottles. This style of case is also recommended where bottles are shipped.

A great deal of milk is spoiled while in transit to the consumer. The last milk delivered on the route may be on the road five or six hours before it finally reaches its destination. If carried in open, uniced cases, on warm days, an exposure of such duration may easily shorten the keeping quality of the milk by eight or more hours.

A matter of prime importance in delivering milk in bottles is to have them thoroughly sterilized before using. Unless this is done milk will not keep long and, what is worse, is likely to disseminate disease along the route.

This danger is due to the bottles' passing from one home to another and eventually reaching a home in which there is some contagious disease. In such cases there is always a probability that the bottles may become infected with the disease germs.

Frequency of Delivering Milk. When milk is cooled to 45° F. or below immediately after milking and is held at this temperature until it reaches the consumer, one delivery a day is sufficient. If it is desirable, however, to make two deliveries a day, these should be made independent of the milking; that is, the night's milk should be delivered in the morning and the morning's milk in the afternoon.

In some sections, especially in the south, milk is sold with little or no cooling whatever. Hence, the practice of delivering the morning's milk before breakfast, and the night's milk before supper. This practice requires the first milking to be done shortly after midnight and the second milking shortly after midday, a drudgery wholly unnecessary and easily obviated by thoroughly cooling the milk.

Delivery Wagons. These should be clean, covered, well painted, and provided with good springs. The name of the dairy should be printed on each side. A neat and attractive delivery wagon is essential in building up a good trade.

STANDARDIZING MILK AND CREAM.

This is a process by which milk and cream are brought to a definite percentage of fat. Cream producers are called upon to furnish cream of a definite richness, and different grades may be demanded by different buyers. The simplest way to meet such demands is to have the separator deliver cream somewhat richer than the richest grade called for and to reduce this to the required richness by adding skim-milk.

Reducing Cream with Skim-milk. When a definite quantity of standardized cream is called for, determine first the amount of original cream (cream as it leaves the separator) required according to the following rule:

Rule: Multiply the number of pounds of standardized cream called for by its test and divide the product by the test of the original cream.

The difference between the amounts of original and standardized cream represents the amount of skim-milk required.

Problem: How many pounds each of 45% cream and skim-milk (zero test) are required to make 60 pounds of 18% cream?

Applying the above rule we get,

$$(60 \times 18) \div 45 = 24 = \text{No. lbs. of original cream.}$$

$$60 - 24 = 36 = \text{No. lbs. of skim-milk.}$$

Milk may be standardized in the same way.

Mixing Two Milks or Two Creams, or Milk and Cream, of Different Richness. In the preceding two formulas the test of the skim-milk was considered zero. When milks or creams of different tests are mixed the calculation becomes more difficult. Pearson, however, has devised a method by which calculations of this kind are very much simplified. This method is as follows:

Draw a rectangle with two diagonals, as shown below. At the left hand corners place the tests of the milks or creams to be mixed. In the center place the richness

desired. At the right hand corners place the differences between the two numbers in line with these corners. The number at the upper right hand corner represents the number of pounds of milk or cream to use with the richness indicated in the upper left hand corner. Likewise the number at the lower right hand corner represents the number of pounds of milk or cream to use, with the richness indicated in the lower left hand corner.

Example: How many pounds each of 30% cream and 3.5% milk required to make 25% cream?

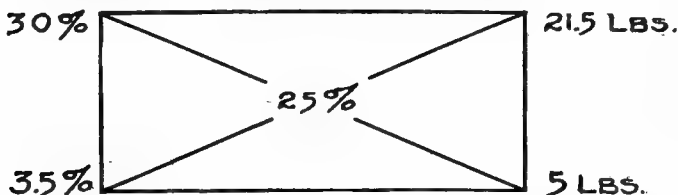

21.5, the difference between 3.5 and 25, is the number of pounds of 30% cream needed; and 5, the difference between 25 and 30, is the number of pounds of 3.5% milk needed.

From the ratio of milk and cream thus found, any definite quantity is easily made up. If, for example, 300 pounds of 25% cream is desired, the number of pounds each of 30% cream and 3.5% milk is determined as follows:

$$21.5 + 5 = 26.5$$

$$\frac{21.5}{26.5} \times 300 = 243.4, \text{ the number of pounds of 30\% cream.}$$

$$\frac{5}{26.5} \times 300 = 56.6, \text{ the number of pounds of 3.5\% milk.}$$

SHIPPING MILK AND CREAM.

The essential things in shipping milk and cream are cleanliness and low temperature. It is possible to keep milk and cream in good condition for two or three days, if produced and handled under cleanly conditions and

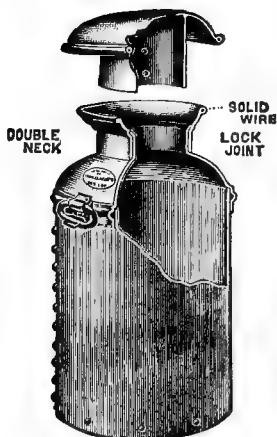

Fig. 44.—Milk Can.



Fig. 45.—Felt Jacket on Can.

cooled directly after milking to 40° F. or below. This low temperature must be maintained when long keeping quality is desired. Every dairy should be provided with a good ice box or refrigerator, into which milk and cream

may be placed immediately after cooling and in which they may be kept until ready for shipment.

Shipping in Cans. Various insulated cans are now upon the market and a number of these have been tested by the author. The tests showed that these cans possess about the same insulating effect as the felt jackets that are commonly wrapped around ordinary milk cans. Since the latter, as a rule, are more durable and more easily handled, they will be found more satisfactory when wrapped with a felt jacket than the so-called insulated shipping cans.

When milk and cream are cooled close to freezing and placed in ordinary milk cans wrapped in felt jackets, they may be safely shipped to any point that may be reached within 24 hours even in warm weather.



Fig. 46.—Screw Top Can.

If the temperature of the milk and cream at the time of shipment is 50° F. or higher, then long distance shipment is best accomplished by the use of an ordinary can placed inside of a covered ice cream shipping tub containing ice. Such a tub has practically the same in-

sulating effect as a felt jacket, but is rather heavy and cumbersome and should not be used except in cases where it is necessary to pack ice around the cream or milk. The best results from the ice are secured by packing it in large lumps around the neck of the can.

Shipping in Bottles. Where milk and cream are shipped in bottles, the latter should be placed in insulated delivery cases (Fig. 43) and surrounded with crushed ice. The cases should have the owner's address on them and must be kept locked while in transit.

Mode of Shipping. The usual way of shipping milk and cream is by express. In the main dairy sections baggage rates are available. These rates are lower than express rates and can be obtained nearly everywhere by special arrangement with the railroad companies.

Shipping rates should always be obtained in advance of shipment and the charges should be prepaid. A considerable saving is certain to be effected by rigidly adhering to this practice. Insist upon getting the lowest rates possible.

Pointers on Shipping. Have the name and address of your dairy permanently marked in brass upon every can and cover; also have it sewed or stitched on the felt jackets. This is necessary to insure the return of your own goods. The name and address will be put upon the cans and covers by the dealer from whom they are purchased, if so requested; or, in case unmarked cans are already on the premises, the brass plates with the name and address may be purchased from dairy supply firms and placed upon the cans and covers by a local tinner.

Even when labeled as indicated above, cans will occasionally get lost. Empty cans are usually returned free of charge and, for this reason, express receipts are com-

monly not taken for them. This is a mistake. If the purchaser of your products will take a receipt for the empty cans, the express company becomes responsible for them in the event they are lost. Without the receipt it is next to impossible to claim damages for lost goods.

The empty cans should be washed before they are returned. This should be done for sanitary reasons as well as for the protection of the cans, which are short-lived unless washed and dried immediately after use.

Another matter of importance in shipping is to have the cans full to prevent churning.

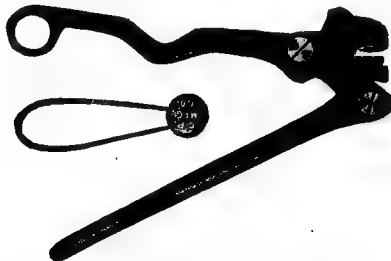

Fig. 47.—Lead Seal and Seal Press.

It is necessary also to have the cans sealed to prevent tampering with the contents. The sealing is easily accomplished by means of lead seals and a seal press (Fig. 47).

In delivering the cream or milk at the station the delivery man should see to it that the cans are put in as cool a place as possible.

CHAPTER XV.

PROFITABLE SIDE LINES.

Only a comparatively few of the thousands of milk dealers are as yet making use of the full possibilities of their business. It has always been taken for granted that milk and cream must be delivered daily to have them reach the consumer in a wholesome and palatable condition. Yet the same may be said about cottage cheese, buttermilk, cultured milk, club cheese, butter, eggs, ice cream, cream cheese and Neufchatel cheese, Pimento and other fancy cheeses.

The sale of some of these products could be infinitely increased by supplying them in as good a condition as milk and cream, but to do this requires that they be delivered in just as fresh and palatable a condition.

Fancy Cheese. The soft and fancy varieties of cheese are appreciated by all classes of people; their wholesomeness when fresh is superior to meat and their cost as a rule is considerably less. But what an insignificant amount of this class of cheese is consumed at the present time! If these perishable products would be manufactured by the milk dealers and delivered by them in a fresh condition, the consumption of soft and fancy cheese could undoubtedly be increased a hundredfold.

At present these cheeses are shipped at heavy cost from manufacturer to city wholesaler who, in turn, delivers them to the grocery stores—a roundabout way of handling that is both costly and unsatisfactory because

the cheese is too old when it reaches the consumer. Of course the average milk dealer may know nothing about fancy cheese making, but he can learn as easily as anyone. The man whose business is continually expanding is the one who is continually expanding in knowledge.

Eggs and Butter. Eggs and butter must be sold more direct in the future than they have been in the past, because their perishable nature does not permit of the roundabout method of marketing practiced at the present time. What an enormous saving there would be in middlemen charges and in reduced cost of delivering by having one wagon, the milkman's wagon, carry the various perishable dairy products on a single trip which now require half a dozen or more trips!

Ice Cream. Think of how much cheaper the milk dealer could furnish ice cream to his customers than the exclusive ice cream manufacturer who frequently must drive an extra two miles to make a single delivery. Of course, those city consumers who have no ice may not be in a position to handle the milk dealer's ice cream to best advantage, but most of the consumers of ice cream do have ice during the summer. Those customers who insist upon having their ice cream delivered, say, an hour before they expect to use it, let them patronize the city ice cream plant. It is quite certain, however, that the reduced cost at which milk dealers can deliver ice cream will secure for them the bulk of ice cream trade among those whom they are supplying with milk.

Cultured Milk. The possibilities for well made cultured milk are practically unlimited. Already many large milk dealers are catering to the demand for this

product and the sale has increased enormously during the past few years. It is a product that should be supplied by all milk dealers, large and small. There is no drink which, by reason of its food and tonic value, relative cheapness and general wholesomeness, is so much entitled to become the leading of all beverages. It is up to the milk dealers to make this *the* national drink for all classes, rich and poor.

Skimmilk-Buttermilk. Well made skimmilk-buttermilk is very palatable and quite as wholesome as cultured milk; indeed in a sense it is cultured milk, but this term should not be applied to fat-free milk. This product is especially commendable because of its cheapness. It answers all purposes of buttermilk and, when made right, is superior in quality.

Reduced Delivery Expenses. Most of the milk dealers are running one-horse delivery wagons, and the sooner the milk dealer can add enough to his wares to run a two-horse delivery, just so soon will he be able to reduce the cost of delivery. Labor is expensive these days, and the labor with a two-horse wagon is no greater than that with the one-horse wagon. The milk dealer ought to be able to carry enough load on his route to justify the use of two horses to each wagon. The additional side lines suggested would soon double the milk dealer's load and would enable him to use two horses instead of one. If these additional lines would do nothing more than enable every driver to drive two horses and a whole load instead of one horse and half a load, the undertaking would be justified.

CHAPTER XVI.

STARTERS, OR LACTIC ACID CULTURES.

The value of carefully selected cultures of lactic acid producing bacteria in cream ripening was first demonstrated by Dr. Storch, of Copenhagen, about twenty-five years ago. Since then the use of these cultures has spread so rapidly that few successful creameries can be found at the present time in which they are not used.

Definition. *Starter* is the general term applied to cultures of lactic acid organisms, whether they have been selected artificially in a laboratory, or at creameries by picking out lots of milk that seem to contain these organisms to the exclusion of others. A good starter may be defined as a clean flavored batch of sour milk or sour skim-milk.

The word starter derives its name from the fact that a starter is used to "start" or assist the development of the lactic fermentation in cream ripening.

Object of Starters. Cream ordinarily contains many kinds of bacteria—good, bad, and indifferent—and to insure the predominance of the lactic acid type in the ripening process it is necessary to reinforce the bacteria of this type already existing in the cream by adding large quantities of them in a pure form, that is, unmixed with undesirable species.

The bacterial or plant life of cream may be aptly compared with the plant life of a garden. In both we find plants of a desirable and undesirable character. The

weeds of the garden correspond to the bad fermentations of cream. If the weeds get the start of the cultivated vegetables, the growth of the latter will be checked or suppressed. So with the bacterial fermentations of cream. When the lactic acid bacteria predominate, other fermentations will be checked or crowded out. The use of a liberal amount of starter nearly always insures a majority of good bacteria and the larger this majority the better the product.

Classification of Starters. Starters are divided into two general classes, namely, natural starters and commercial starters. The former consist of naturally soured milk or skim-milk and are generally less satisfactory than starters prepared from commercial cultures. There are comparatively few natural starters used at the present time. Commercial starters are sent out in hermetically sealed bottles and, in the majority of cases, may be obtained in either liquid or powder form. The bacteria will keep longest in the powder preparation, but will be found most active in the liquid provided the same is used immediately.

NATURAL STARTERS.

Sour Milk and Skim-milk. Natural starters are those obtained by allowing milk, skim-milk, or possibly cream, to sour in the ordinary way.

The earlier methods of using natural starters consisted in selecting milk or skim-milk from the patrons who furnished the best milk at the creamery, and allowing this to sour by holding it over till the following day. While good milk could be selected in this way, the method of souring it was very unsatisfactory. On warm days the milk might oversour, while on cooler days it would be

found comparatively sweet unless a good deal of attention was given to keeping the temperature where it would sour in the proper length of time. This method of starter making is rapidly falling into disuse.

The most satisfactory natural starters are selected and prepared in the following manner: Secure, say, one quart of milk from each of half a dozen healthy cows not far advanced in lactation, and fed on good feed. Before drawing the milk, brush the flanks and udders of the cows and then moisten them with water or, preferably, coat thinly with vasaline to prevent dislodgement of dust. Then, after rejecting the first few streams, draw the milk into sterilized quart jars provided with narrow necks. Now allow the milk to sour, uncovered, in a clean, pure atmosphere at a temperature between 65° and 90° F. When loppered pour off the top and introduce the sample with the best flavor into fifty pounds of sterilized skim-milk and ripen at a temperature at which it will sour in twenty-four hours (about 65° F.).

A starter thus selected can be propagated for a month or more by daily inoculating newly sterilized or pasteurized milk with a small amount of the old or mother starter. Usually three or four pounds of the mother starter added to one hundred pounds of pasteurized skim-milk will sour it in twenty-four hours at a temperature of 65° F. Under certain conditions of weather this amount may possibly have to be modified a little, for it is well known that on hot sultry days milk will sour more quickly at a given temperature than on cooler days. The best rule to follow is to use enough of the mother starter to sour the milk in twenty-four hours at a temperature of 65° F.

Buttermilk and Sour Cream. If the cream has a good flavor, a portion of this, or the buttermilk from it,

may be used as a starter. But in the case of unpasteurized cream, even though the flavor is good, there are always present some undesirable germs which will multiply in each successive batch of cream or buttermilk used as a starter, so that after a week's use the flavor may actually be bad. Where cream is slightly off flavored and a portion of this, or the buttermilk from it, is used as a starter, it will readily be seen that the taint will not only be transmitted but will multiply in the cream from day to day. The use of either cream or buttermilk as a starter is therefore not to be recommended.

COMMERCIAL STARTERS.

Commercial starters may consist of a single species of lactic acid organisms, but usually they are made up of a mixture of several species. These starters are prepared in laboratories where the utmost precautions are taken to keep them free from undesirable germs.

Preparation. Most of the commercial cultures are sent out in one ounce bottles which are hermetically sealed. The method of making starters from them is the same for all whether they are obtained in the liquid or in the dry form.

In making the first batch of commercial starter, the entire contents of the bottle is put into a quart of skim-milk, sterilized by keeping it at a temperature of 200° F. for two hours, and then cooling to 80° which temperature should be maintained until the starter has thickened. A new starter is now prepared by introducing the quart of starter into fifty pounds of skim-milk, pasteurized by keeping it at a temperature of 170° to 185° for thirty minutes and then cooling to 65° F. All subsequent starters are prepared in the same way except that the amount of

mother starter for inoculation must be reduced a little for a few days because the germs become more vigorous after they have propagated several days.

In preparing the first starter from a bottle of culture it is necessary to have the skim-milk *sterile*. For if any spores should remain, the slow souring would give them a chance to develop which might spoil the starter. Moreover, the cooked flavor imparted by the prolonged heating at high temperatures does not matter in the first starter as this should never be used to ripen cream. The first and second starters prepared from a new culture seldom have the good flavor produced in subsequent starters. The cause of this in all probability is the inactive condition of the germs and the peculiar flavor of the medium in which they are sent out.

In the starters prepared later the destruction of the spores is not so essential as the lactic acid germs are then in a vigorously growing condition which renders the spores practically harmless. At any rate the harm done by them would be less than that caused by the sterilizing process. When milk is pasteurized at 170° to 185° F. for thirty minutes the vegetative germs are destroyed and but little cooked flavor is noticeable.

NATURAL VERSUS COMMERCIAL STARTERS.

Experimental tests have shown that equally good results can be secured with commercial and natural starters. It is believed, however, that the average butter maker can get the best results with commercial starters. Too few are good judges of milk and for this reason are not always capable of selecting the best for natural starters. Standard commercial cultures can be relied upon as giving uniformly good results.

From what has been said of the methods of preparing starters it must have been noticed that they are essentially the same for both the natural and the commercial, the chief difference being in the original ferment, which in the case of the natural starter consists of a quart of selected milk allowed to sour naturally, while in the commercial it consists of a bottle of culture prepared in a laboratory.

USING A STARTER EVERY OTHER DAY.

During the winter when milk is received every other day at creameries the ordinary method of preparing starters daily is, of course, out of question. There are two ways, however, in which starters may be carried along during this time. One way is to keep the starter an extra twenty-four hours by holding it at a temperature below 50° after it has soured. The other and more satisfactory way is to prepare a small starter on the day the milk is separated; and, in addition, to pasteurize, but not inoculate, the amount of skim-milk needed for the regular starter. This milk is repasteurized the following day and then inoculated from the small starter prepared the day previous.

The object in repasteurizing the milk is to destroy the spores that have developed into the vegetative state.

HOW TO SELECT MILK FOR STARTERS.

It is poor practice to select starter milk promiscuously. The sweetest and best flavored milk should be obtained for the preparation of starters. Where possible the best plan is to select the morning's milk of one of the earliest patrons at the creamery and separate this first. In case

the best milk is received toward the middle or close of the run, it should be carried into the creamery and separated by itself so as to secure the skim-milk without contamination from other milk of inferior flavor.

It must not be supposed that any milk may be made into a first-class starter by thorough pasteurization and inoculation with good cultures of bacteria. The best starters are possible only with the best milk.

WHOLE MILK STARTERS.

Where whole milk is used for making starters the cream should always be skimmed off before using the starter. Indeed it is good practice to skim off the top of any starter before using as the surface is liable to become contaminated from exposure to the air.

ACIDITY OF STARTERS.

It has already been stated that a starter is at its best immediately after it has thickened when it usually shows about .7% acid. It must not be supposed, however, that all starters are at their best when they show this amount of acid, because different starters thicken with different degrees of acidity. Nor must it be supposed that a starter that tends to sour very quickly is better than one that sours slowly. Marshall, of the Michigan Agricultural College, has recently found that when certain alkali producing bacteria are associated with the lactic acid organisms the milk sours more quickly than when the alkali bacteria are not present. These alkali producing bacteria, while they hasten the souring, produce an undesirable flavor. This probably explains why starters that have a tendency to sour very rapidly are often inferior to those

that sour less rapidly. Usually, too, starters after they have been propagated for some time, become intensely acid producing, which is probably due to contamination with the peculiar alkali producing bacteria.

RENEWAL OF STARTERS.

Under average creamery conditions it is policy to renew the starter at least once a month by purchasing a new bottle of culture. It will be found that after the starter has been propagated for two or three weeks bad germs will begin to manifest themselves as a result of imperfect pasteurization, contamination from the air, or from overripening, so that its original good flavor may be seriously impaired at the end of one month's use. It is only where the utmost precautions are taken in pasteurizing the milk and ripening the starter, that it is possible to propagate a starter for many weeks and still maintain a good flavor.

VALUE OF CARRYING SEVERAL STARTERS.

There is always some possibility of losing a starter by overripening or by accidental contamination which would deprive the butter maker of the use of a starter for several days. To insure against this, butter makers should practice carrying a few extra ones in quart cans. This has the additional advantage of offering some choice. The best is, of course, always selected for regular use. The milk for the small starters should be sterilized rather than pasteurized.

This practice of carrying several starters is strongly recommended.

STARTER CANS.

The most difficult thing in connection with starters is to get them just ripe when ready to use. A starter has its best flavor right after it has thickened. When it begins to show whey it indicates that the ripening has gone too far and should not then be used in the cream. The strong and curdy flavors found in butter are often directly attributable to overripened starters.

It is evident that to secure the proper acidity in the starter from day to day, cans or vats must be used in which it is possible to obtain perfect control of temperature. The improved modern starter cans answer the requirements. They are provided with a double jacket between which steam, hot water, cold water, or ice water may be circulated. They are also provided with power agitators.

MOTHER STARTERS.

About two per cent of the bacteria in milk are present in the form of spores in which condition they cannot be destroyed by the ordinary pasteurizing process. To destroy the spores, or to render milk sterile, requires pasteurization on three successive days. It is for this reason that mother starters should be carried independently of the regular starter, the milk for which it is impracticable to sterilize.

A good method of handling the mother starter is as follows:

Have a tinner make four narrow cylindrical tin cans, each large enough to hold the mother starter for one day. Number the cans 1, 2, 3, 4. The first day pasteurize can No. 1; the second day pasteurize cans Nos. 1 and 2; the

third day pasteurize cans Nos. 1, 2 and 3. Can No. 1 has now been pasteurized three times which makes it sterile. Inoculate this can with a bottle of pure culture of lactic acid bacteria. The next day pasteurize cans Nos. 2, 3 and 4 and inoculate can No. 2 from can No. 1, the former having now been pasteurized on three successive days. The next day pasteurize cans Nos. 1, 3 and 4 and inoculate can No. 3 from can No. 2. And so the process is continued day after day. The mother starters thus prepared are used to inoculate the regular starter milk for cream ripening.

The pasteurization of the small cans is easily accomplished in a whisky barrel sawed in two. The cans are put into the half barrel and the latter is then covered with a piece of oilcloth or other material and a small stream of steam turned into the barrel. The cans being narrow, only a small amount of steam is required to heat the milk close to 200° F. Half an hour of heating will usually be found sufficient. The milk should be kept at 170° F. or above for at least 15 minutes. The cans are cooled in the same barrel with cold water, the overflow of the barrel being placed at least two inches below the top of the cans.

POINTERS ON STARTERS.

1. Starters give best results when added to cream immediately after they have thickened.
2. An overripe starter produces somewhat the same effect in butter as overripened cream. Curdy flavors are usually the result of such starters.
3. To prevent overripening, starter cans or starter vats must be used in which the temperature can be kept under perfect control.

4. Skim-milk furnishes the best medium for starters, since this has undergone the cleansing action of the separator and is free from fat, which hampers the growth of lactic acid bacteria.

5. Agitate and uncover the milk while heating to insure a uniform temperature and to permit undesirable odors to escape.

6. Always dip the thermometer in hot water before inserting it in pasteurized milk. The pasteurizing process becomes a delusion when dirty thermometers are used for observing temperatures.

7. Always use a sterilized can for making a new starter.

8. Keep the starter can loosely covered after the milk has been heated to prevent germs from the air getting into it.

9. Stir the starter occasionally the first five hours after inoculation to insure uniform ripening.

10. Never disturb the starter after it has begun thickening until ready to use.

11. When a new bottle of commercial culture is used, the first two starters from it should not be used in cream as the flavor is usually inferior on account of the slow growth of the bacteria and the undesirable flavor imparted by the medium in which the cultures are sent out. A commercial starter is usually at its best after it has been propagated a week.

12. Always sterilize the neck of a new bottle of culture before emptying the contents into sterilized skim-milk.

Starter a Vast Army Fighting Against Evil Doers. The lactic acid germs are antagonistic to the other species of bacteria and the two classes may well be likened to two armies on the field of battle. In cream there are

frequently as many of the taint producing organisms present as of the lactic acid kind. But by adding a reasonable amount of starter to such cream, the lactic acid bacteria will so far outnumber the others that a good flavor may be expected.

In order to better understand how the addition of a good starter will increase the fighting force of lactic acid bacteria in cream, we have represented in the accompanying illustration the relative number of good and bad bacteria present in a given sample of cream just before and just after the addition of starter.

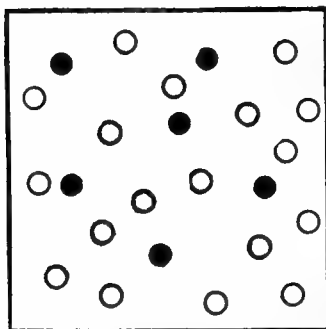

Fig. A. Cream just before adding starter.

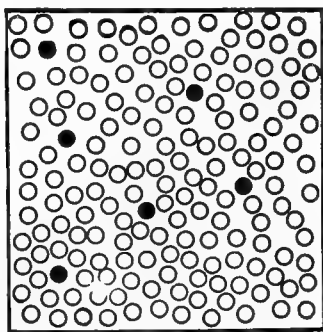

Fig. B. Same cream just after adding 10% of starter.

Fig. A represents a sample of cream rather below the average in quality, assumed to contain 6,000,000 bacteria per c.c. Two-thirds of these in this instance belong to the lactic acid group, which is represented by the circles. The other third of the bacteria belong to the taint producing group, which is represented by dots.

What an insignificant chance taint-producing bacteria have to taint cream that has been treated with a good starter compared with their opportunity for mischief in the same cream, untreated!

CHAPTER XVII.

CULTURED MILK.

Definition. The term cultured milk is applied to milk which has been soured by the use of special cultures of lactic acid bacteria among which, as a rule, is included the *Bacillus Bulgaricus*. Usually such milk is partially skimmed and then pasteurized before it is inoculated with the special cultures. When thoroughly coagulated, the milk is agitated in a churn or other apparatus specially designed for this purpose, until it assumes a smooth, homogeneous consistency.

Milk of this class is sold to the trade under various names, such as Bulgara, Pokoloc, Bacillac, Fermillac, Vitalac, Yoghurt, Zoulac, etc.

Therapeutic Value. It was Dr. Metchnikoff of the Pasteur Institute who first proclaimed the full virtues of this class of milk, especially that soured with the *Bacillus Bulgaricus*, which is the name applied to a species of lactic acid bacteria indigenous to Bulgaria, where Metchnikoff found people to live to an unusually old age. Investigation proved to him that the regular indulgence in a drink, Yogart, containing this bacillus, was largely responsible for the good health and longevity of Bulgarians. Metchnikoff demonstrated that the Bulgarian and other lactic acid bacteria are antagonistic to putrefactive and allied organisms and that, by virtue of this, when taken into the system, will check putrefaction in the intestines and thus prevent the formation

of toxic substances, which give rise to a retinue of intestinal and bodily disorders.

From what has been said it is evident that the therapeutic value of cultured milk rests upon a sound, scientific basis. Foods, after going through the usual course of digestion, are temporarily stored in the colon or large intestine where putrefaction and other undesirable forms of fermentation always take place before the undigested material is finally eliminated from the body. Such fermentations are always undesirable and, when carried to excess, cause auto-intoxication or ptomaine poisoning. In mild cases such poisoning may produce only headaches and general discomfort or indisposition, but in aggravated cases severe sickness, and even death, may be the consequence.

While all of the ordinary species of lactic acid bacteria are capable of counteracting undesirable fermentation processes in the intestines, the *Bacillus Bulgaricus* has special value in this connection because of its vigorous acid-producing qualities and great resistance to stomach and intestinal secretions which enable it to reach the colon or larger intestine in an active condition.

The antiseptic value of cultured milk is believed by Metchnikoff to be the means of prolonging life to a very appreciable extent. He claims that old age is hastened by the weakening and destruction of the brain, nerves, bone, muscle and other cells of the body, caused by the absorption of products formed by the undesirable ferments of the intestines. In checking or destroying these undesirable ferments by the antiseptic action of cultured milk, the weakening or destructive effects of their products on the body cells, is materially reduced or eliminated.

Value as a Drink and Food. Well made cultured milk is a palatable product highly relished by most people. It is superior to ordinary sour milk or buttermilk, both in palatability and wholesomeness as well as in food value. Its palatability and food value increase with the richness of the milk.

Cultured milk made from whole milk is fully as nutritious as ordinary milk and many food experts prefer it to whole milk as a food because of the presence of the acid, which aids in its digestion. But if we credit it only with the same food value as ordinary milk, it will still be found a cheap food as the following extract from Farmers' Bulletin 413, U. S. Department of Agriculture, will show:

"A quart of milk supplies practically as much of both protein and energy as three-quarters of a pound of beef of average composition or eight average eggs, and can generally be bought for less money. In case milk is 8c a quart, beef 20c a pound and eggs 24c a dozen, 10c spent for milk will buy a little more protein and much more energy than 10c spent for beef or 10c spent for eggs. Thus, while animal foods other than milk (meat, eggs and cheese) are desirable to give variety to the diet it may be assumed that milk may be used as an economical substitute for any of them."

From this it will be seen that cultured milk, which, as has been stated, is fully equal in food value to ordinary milk, will prove economical if used only as a food. Its medicinal value, therefore, instead of being obtained at some expense, as many believe, actually costs nothing when cultured milk can be obtained at, say, ten cents per quart.

Method of Manufacture. In making cultured milk

the idea is to get a drink which shall contain practically none other than the common lactic acid and the Bulgarian bacilli. This requires that the milk be thoroughly pasteurized and then inoculated with pure cultures of the common lactic acid and Bulgarian bacteria.

Bacillus Bulgaricus. So far as known, none of those who are making a specialty of supplying cultured milk have found the *Bacillus Bulgaricus* entirely satisfactory when used by itself. The high acid production and the comparatively high temperature at which it must be grown, combined with the tendency to produce a slimy curd, make milk fermented with this bacillus less palatable than that soured with ordinary lactic acid bacteria. The flavor produced by this bacillus is also less desirable than that produced by the ordinary lactic acid bacteria.

On the other hand, while there are objections to the exclusive use of the Bulgarian bacteria, they have a use in cultured milk aside from the medicinal value already discussed. The slimy curd produced by them gives smoothness to body when mixed with the common lactic acid cultures and checks or prevents the separation of the whey in the finished product.

Unlike the common lactic acid bacteria, the Bulgarian bacteria are extremely sensitive to temperature, developing best at about 100° F. At this temperature the amount of acid produced may reach three per cent. Below 90° F. there is little development and for this reason the culture soon deteriorates when attempts are made to propagate it at the same temperature at which the ordinary lactic acid cultures are prepared. This fact has caused many cultured milk manufacturers to propagate the Bulgarian and common lactic acid cul-

tures separately, holding the former close to 100° F. and the latter at about 70° F.

Preparation and Propagation. The *Bacillus Bulgaricus* culture is prepared and propagated in essentially the same manner as the common lactic acid cultures (starters) discussed in the preceding chapter, except that it must be given a higher temperature for development—95° to 100° F. Because of this difference in temperature requirement, the *mother* cultures of the Bulgarian and common lactic acid cultures should always be propagated separately. The high growing temperature also makes it necessary to pasteurize the milk more thoroughly. A pasteurizing temperature of about 190° F. should be maintained for at least thirty minutes.

Under ideal conditions, two batches of milk should be pasteurized, one to be inoculated with the Bulgarian mother culture and the other with the common lactic acid culture. When thoroughly curdled, the two batches are mixed and churned together. The customary practice is to pasteurize one batch of milk and to inoculate this with the desired amount of both cultures. Usually considerably more of the common lactic acid culture is used than of the Bulgarian. Where the same batch of pasteurized milk is inoculated with both cultures, the milk, as a rule, is inoculated at from 90° to 100° F. and the temperature gradually allowed to drop so that it will have reached about 70° F. at the time of coagulation. The high initial temperature gives the Bulgarian bacteria an opportunity for development.

As soon as the milk is thoroughly coagulated, the curd is broken up by churning or by other means of agitation. Special cans or vats are now obtainable which make it possible to pasteurize, sour, churn and cool the

milk in the same machine. The coagulated milk is churned until it has become perfectly smooth and uniform. Prolonged or too vigorous agitation will induce severe foaming, which is undesirable. Where much foam gathers, it must be allowed to settle and then skimmed off before bottling, otherwise a skin or crust will form on top of the bottle. The more the milk is churned or agitated the thinner it will become in consistency. Too heavy a consistency is undesirable.

After churning, the milk should be thoroughly cooled, strained and then bottled.

Marketing. Cultured milk is usually sold in half pint and pint bottles, at from five to ten cents per pint. One cent a pint above the market price for whole milk should give the producer a reasonable profit from cultured milk, even if made from whole milk. As a rule it is made from partially skimmed milk, containing as low as one per cent fat, in which case, of course, it can be produced for considerably less.

This class of milk should first of all be sold to consumers direct the same as ordinary milk, and large quantities can be disposed of in this way. Other outlets should be sought, however, such as drug stores, hotels and restaurants. Owing to the well advertised merits of cultured milk, there is call for it at practically all soda fountains; in fact some do an exceptionally large business in this class of milk, not only during the summer but throughout the year. Soda fountains retail cultured milk, as a rule, at five cents per half pint bottle.

While the wholesomeness of cultured milk is well recognized by physicians, dieticians and the better educated classes in general, the majority of milk con-

sumers do not know much of its value, and, therefore, a certain amount of advertising will be found profitable. This can be done through the press, through posters and by furnishing dealers with attractive display signs. Those who handle this product for the first time on their milk routes, should furnish their customers with printed leaflets discussing the merits of the product.

Necessary Precautions. To keep the cultured milk as free from foreign organisms as possible, thorough pasteurization of the milk is essential. It will also be necessary to buy new cultures about every two weeks. Indeed the same precautions should be taken here as in the case of starters discussed in the preceding chapter. Every bottle of the cultured milk must bear a label giving the trade name of the milk, such as "Cultured Milk," "Fermillac," etc. The milk must be constantly kept at low temperatures from the time it is made until it reaches the consumer; the nearer the freezing temperature the better, but it must never be frozen.

CHAPTER XVIII.

SKIMMILK-BUTTERMILK.

Souring the Skim-milk. As soon as the skim-milk leaves the separator, whole milk is added at the rate of one gallon to twenty gallons of skim-milk. This gives the mixture a fat content, which approximates that of ordinary buttermilk. A large quantity of pure culture of lactic acid bacteria (starter, see p. 135) is next added and the temperature brought to 70° F. Enough starter is added to curdle the skim-milk in about six hours at the temperature mentioned. This requires about one pound of culture for every three pounds of skim-milk. When a temperature above 70° F. is employed, there is a tendency for whey to separate after the skim-milk has curdled.

Churning. When thoroughly curdled, the skim-milk is placed in a churn and churned for about twenty minutes in the same way that cream is churned in making butter. The churning process thoroughly breaks up the curd clots, resulting in a smooth, thick liquid which cannot be distinguished from ordinary good buttermilk.

Cooling: Immediately after the buttermilk leaves the churn, the temperature should be reduced below 50° F. to prevent further development of acid and the separation of the whey. Ordinary milk and cream coolers with enlarged holes in the distributing receptacle will answer very satisfactorily.

Straining. As soon as cooled, the buttermilk should

be run through a strainer consisting of one thickness of cheese cloth to remove any unbroken curd clots.

Bottling. After it is strained the buttermilk is bottled or put in tin cans holding from one to five gallons, after which it is placed in the refrigerator where it is held until ready for delivery.

Marketing Skim-milk Buttermilk. In trying to sell skimmilk-buttermilk it is necessary in the first place, to explain that this product, when made as herein described, is almost identical with the highest grade of natural buttermilk, both in composition and physical properties, and, therefore, in palatability and wholesomeness. Indeed, it is not thought possible under average conditions to secure natural buttermilk of as uniform a quality or as fine a flavor as can be obtained from skim-milk. When these facts are explained to dealers and consumers, any prejudices which might exist against this so-called artificial product are certain to vanish.

The dealers in buttermilk should be furnished with attractive signs, calling attention to the fact that the product is for sale by them. Buttermilk is not found at all soda fountains, and unless conspicuous signs are posted at these places, the public may not call for it.

Buttermilk may readily be sold to drug stores, restaurants, hotels and boarding houses at from ten to thirty cents per gallon, averaging about twelve cents per gallon.

As with cottage cheese, the most satisfactory way of disposing of buttermilk is to sell it direct to the milk and cream customers along the dairy route.

Where buttermilk is intended to be used as a beverage, it is important to keep its temperature below 50° F. until it is consumed.

Food Value of Buttermilk. When used as a bever-

age, buttermilk is usually appreciated only for its palatability. Aside from this, however, it has a high dietetic, as well as high medicinal, value. In certain diseases, especially those affecting the alimentary tract, buttermilk is considered indispensable. Its nutritive value is high, two quarts being approximately equal to one pound of good beefsteak.

Buttermilk From Pasteurized Skim-milk. The best buttermilk is obtained by adding the starter to pasteurized skim-milk. Under such conditions the entire skim-milk becomes virtually a starter or pure culture of lactic acid bacteria. This not only means a better flavor but also insures freedom from pathogenic organisms. Pasteurization also lessens the tendency for the whey to separate.

CHAPTER XIX.

ICE CREAM MAKING.

Scores of creameries throughout the country are now making ice cream in connection with butter with very satisfactory results. At prevailing prices, cream converted into ice cream will yield approximately double the profit obtained by making it into butter.

Creameries have several important advantages in the manufacture of ice cream not possessed by exclusive ice cream manufacturers. In the first place the creamery can obtain its cream at a lower cost than the ice cream factory; and, secondly, most creameries are in a better position to meet the varying demands for ice cream because of the abundance of cream they always have on hand. This makes it possible for them to double their output on short notice, as well as enables them to pull through a sudden slump in the demand without loss because any surplus cream can be manufactured into butter.

Kind of Cream. Select the best flavored sweet cream containing about 20% butter fat. To secure the best bodied ice cream and the proper swell, cream should be kept as near the freezing point as possible for twenty-four hours previous to freezing.

Where sweet, clean flavored cream is not obtainable, pasteurization is very essential. Pasteurized cream has better keeping quality and will also produce a better bodied ice cream when properly handled.

Pasteurize the cream at a temperature of from 140°

to 150° F., and hold at this temperature for 15 minutes. Then quickly cool and keep the cream as near freezing temperature as possible for at least 24 hours before freezing. Holding the pasteurized cream cold this length of time restores to a great extent the viscosity which it has lost in the pasteurizing process.

Cream can also be satisfactorily pasteurized in continuous pasteurizers, but greater care is necessary because of the higher temperature that must be employed. But even with the higher temperature the pasteurizing is bound to be less thorough than where the cream is held some time at a lower temperature.

Freezing Process. With an initial temperature of about 35° F., the time required to freeze ice cream should average about twelve minutes, and to get the best consistency the temperature at the close of the freezing process should be approximately 28° F.

Too quick freezing causes the water to separate from the cream, which results in a granular ice cream. Freezing too slowly reduces the overrun and tends to make the ice cream smeary.

To reduce the temperature of a mass of cream below the freezing point, requires a freezing mixture of a low temperature. Such a mixture is secured by mixing salt and crushed ice in the proportion of one of salt to about twelve of ice. The purpose of the salt is to lower the freezing point of the melting ice and to hasten the melting.

To melt one pound of ice at 32° F. into water at the same temperature requires 142 heat units. Rapidly melting ice, therefore, absorbs a large quantity of heat which in the freezing of cream is largely extracted from the cream.

The temperature of the ice cream mixture when starting the freezer should be as near freezing as possible to prevent churning the cream. The tendency to churn is also lessened by revolving the freezer slowly the first few minutes in freezing.

In packing the freezing mixture around the cream container, fill the freezer about half full of finely crushed ice and finish the filling by using salt and ice in the proportion of about one to six. As the ice mixture works down during the freezing process, continue adding more salt and ice as needed.

If the freezer is started while the cream is still warm (about 60° F.), the speed of the freezer must be kept down to about fifty revolutions until a temperature of about 35° F. is reached. After this the speed is increased to 150 to 200 revolutions per minute until the cream is frozen. This speed insures the proper incorporation of air and the desirable smoothness of the finished product.

The freezer should be stopped before the cream becomes too thick, else it will lose some of the air that has been incorporated as well as show a tendency to coarseness in texture. Yield and quality therefore demand that the freezer be stopped while the cream is still a trifle soft.

Vanilla Flavor. Of all ice cream flavors vanilla is the most popular. The majority of ice cream manufacturers use vanilla extract, but great care should be used in its selection as there are many different grades upon the market.

The best flavors are obtained from the Mexican vanilla beans, which are dark in color, measure 9 to 9½ inches in length, weigh about 1-6 of an ounce, and are oily and

pliable, so that they can be wound around the fingers. They must be very fragrant and closed, leaving none of the seeds exposed, which are the seat of much of the vanilla flavor. The lower grades of Mexican and other varieties of vanilla beans can easily be recognized by their length, as shown in the accompanying illustration.

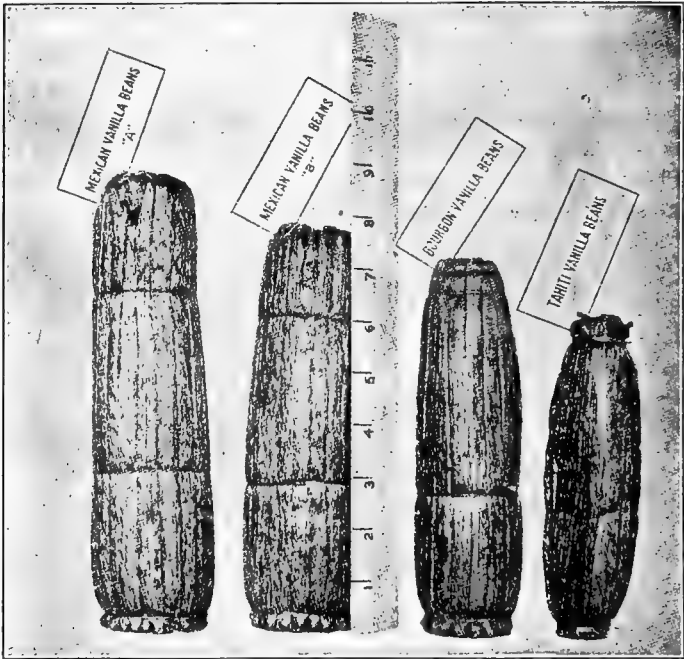

Mexican, Bourbon and Tahiti Vanilla Beans.

The finest vanilla flavor is secured by purchasing the best quality of Mexican vanilla beans and preparing them as follows:

Cut the beans in small pieces and grind them as fine

as possible with loaf sugar. Immediately after grinding, the vanilla sugar is bottled and corked and set aside until ready for use. On an average one bean is required per gallon of ice cream.

Add the vanilla sugar (sugar containing the ground beans) required for a given batch of ice cream to one or more gallons of the cream and keep the latter at a temperature of about 150° F. for five or ten minutes and then strain through three thicknesses of cheese cloth while still hot. While extracting the flavor with the hot cream the cream container should be kept covered as much as possible. The high temperature aids in extracting the flavor as well as aids in straining out the remnants of the beans. The seeds are very fine and require a very fine strainer to remove them.

Some grind up the beans and extract the flavor by means of alcohol, an ounce of the cut up beans being soaked in about ten ounces of a mixture consisting of equal parts of grain alcohol and water. The flavor of the alcohol and other spirituous substances used in the extraction of vanilla flavor, are objectionable and can be recognized in the ice cream.

The vanilla beans when prepared with sugar as suggested, not only produce a better flavor than is possible with extracts, but also cost less.

Vanilla Ice Cream. To make ten gallons of finished ice cream, requires about six gallons of cream to which should be added about nine pounds of sugar, or one and one-half pounds to the gallon. The sugar should be well mixed with the cream and allowed to dissolve before starting the freezer. Next add four ounces of vanilla ex-

tract or six best quality Mexican vanilla beans prepared as directed under "Vanilla Flavor," and freeze.

Chocolate Ice Cream. This can be made by adding chocolate flavor to finished vanilla ice cream. The chocolate flavor for ten gallons of finished ice cream is prepared as follows: Dissolve one and one-half pounds of bitter chocolate by placing it in a double boiler and adding a little water; then heat slowly working the chocolate to a smooth paste; add more water and work until the mass is smooth;* add one pound of sugar, heat and work smooth; add more water, heat the mixture nearly to the boiling point and add one pound of sugar; stir and bring to a boil, care being taken not to scorch it. Nearly three pints of water are required to dissolve the chocolate.

In making a regular batch of chocolate ice cream, the chocolate is added before starting to freeze.

Lemon Ice Cream. In making lemon flavored ice cream, use the best paper-wrapped lemons, free from any signs of decay. Wash the lemons lightly in cold water and grate off the outer, yellowish portion of the rind, being careful not to grate off any of the white portion which is very bitter. Mix the grated rind with sugar, using one ounce of sugar for each lemon rind. Next cut the lemons in two and squeeze out the juice, removing any seeds that may have dropped in from the squeezer. Mix the juice with the sugared rind and add orange juice to the mixture, using one orange to every three or four lemons. Allow the mixture to stand for about one hour, stirring it occasionally, and then strain. Use at the rate of one-half pint per gallon of cream.

*Bulletin No. 155, Vermont Experiment Station.

The flavor is added to the cream when nearly frozen to prevent curdling it. Use two pounds of sugar per gallon of cream.

Walnut Ice Cream. Use six gallons of cream, nine pounds of sugar, four ounces vanilla extract (or bean equivalent) and four pounds of ground walnut meats. Freeze the same as vanilla ice cream.

Other Nut Ice Creams. Chestnut, filbert, hazelnut, pecan, peanut and almond ice creams may be prepared essentially as walnut ice cream.

Strawberry Ice Cream. Use six gallons of cream, nine pounds of sugar and one-half gallon of crushed strawberries. The fruit should be added to the cream after it is partially frozen so as not to curdle the cream or to have the fruit settle to the bottom.

Other Fruit Ice Creams. Cherry, raspberry, pineapple, peach, apricot, currant, grape and cranberry ice creams are made the same as strawberry, except that the amount of sugar is varied according to the acidity of the fruit.

Packing Ice Cream. Remove the ice cream from the freezer while still in rather soft condition and put the same in packing cans which have been thoroughly chilled by having the ice and salt packed around them about ten minutes before receiving the ice cream. Most of the salt should be put near the top, the same as in freezing. The ice cream should be held in the packing cans at a temperature below 20° F.

Remove the brine and repack often enough to prevent melting. In the melting process the water separates and forms undesirable crystals when the cream is refrozen.

Always repack with a new freezing mixture just before the ice cream leaves the creamery.

The Use of Gelatin or Binders. Many look upon gelatin as an adulterant in ice cream and in some states its use is prohibited by law. It is true that the highest quality of ice cream is produced without the use of gelatin, still, under commercial conditions, the use of a limited amount of good gelatin has been commended for several reasons:

1. It prevents, to a great extent, the granulation or crystallization of the ice cream that usually occurs with advancement of age. Ice cream without any binder, such as gelatin, will become coarse and granular and the older the ice cream, the more aggravated this condition becomes. This, however, is the very reason why the use of gelatin has been condemned by many in the past. Where no gelatin is used the extent of crystallization is an indication of the age of the ice cream, thus affording protection to consumers against old ice cream.

2. Gelatin assists in maintaining the body of the ice cream under comparatively high temperature conditions. Ice cream without any binder will immediately become soft and mushy on exposure to a high temperature, a condition which materially lessens the palatability of the cream. The advantages thus afforded by the use of gelatin have some disadvantages, so far as the consumer is concerned, in that the ice cream can be held under temperature conditions which favor the development of the various kinds of organisms usually present in ice cream.

Where gelatin is used, place the gelatin in a double boiler, add two or three quarts of cream and heat, stirring until the gelatin is all dissolved. Next strain the

hot gelatin mixture into the regular batch of cream to be frozen and thoroughly mix. In melting the gelatin the heating should be stopped as soon as melted to prevent danger from curdling the gelatin.

The Overrun or Swell. This refers to the excess of ice cream over cream. Anything that tends to incorporate and hold air in cream conduces to a large overrun. Thus excessive beating of the cream during freezing mixes a great deal of air with it, and hence, increases the overrun. A high viscosity of the cream holds the air incorporated during freezing. Fresh separator cream has a low viscosity, that is, does not whip well, hence will not swell up so much in freezing as cream that has been kept cold for twenty-four hours. Pasteurized cream also has a low viscosity, but this will improve by keeping the cream at a low temperature a number of hours before freezing.

An overrun of from 60 to 70 per cent is large enough. Overruns approximating 80 to 90 per cent are obtained at the expense of quality.

Cost of Ice Cream. The cost of making ice cream will depend largely upon the richness and cost of the cream, the amount of overrun, and the kind and quantity of ice cream manufactured. An average ten-gallon batch of vanilla ice cream made in a creamery will cost approximately as follows:

6 gallons of 20 per cent cream.....	\$3.36
9 pounds sugar50
4 ounces vanilla30
3 ounces gelatin10
Ice and salt70
Labor and power	1.00

\$5.96

Total cost per gallon, 59.6 cents.

The six gallons of cream would weigh approximately forty-eight pounds and contain 9.6 pounds of butter fat. Valuing butter fat at 35 cents per pound, the cost of the cream used will be \$3.36, as stated above.

Where 100 or more gallons of ice cream are made daily, and cream containing, say, 15 per cent butter fat is used, the cost of a gallon of ice cream will be about 45 cents.

The gelatin may be omitted.

Marketing Ice Cream. The essential thing in building up a good ice cream trade is to make the best product possible. The market is glutted with cheap, inferior ice cream, and the call now is for a high grade product. Fortunately the public is beginning to realize that there is positive danger in eating ice cream made from old, stale milk or cream, and the public also seems to begin to understand that the bulk of ice cream is made with so-called thickeners, like gelatin, corn starch, tapioca, arrow root, and others. Many so-called ice creams contain no cream whatever. The highest quality of ice cream contains nothing but good, pure cream, sugar and flavoring.

Plants making ice cream are not limited to their own home town as a market for this product. With proper refrigeration, ice cream may easily be shipped several hundred miles. A great deal of the ice cream consumed in Charleston, S. C., is shipped from New York. New Orleans gets much of its ice cream from North Carolina, Virginia and Tennessee.

If you haven't sufficient market near home for your ice cream, don't hesitate to ship it several hundred miles. Study the available markets, small and large, and keep reaching out until you have market for all of your product.

Homogenizer. This machine is now used by most of the leading ice cream manufacturers. Its purpose is to break up the fat globules into smaller particles. This is accomplished by forcing the cream under high pressure through small openings. The effect of breaking up the fat globules in this way is to give cream more body, making it seem considerably richer than it actually is. Not only does the homogenizing process give cream more body but it also gives the ice cream a smoother texture and an apparently richer flavor. It also increases the yield of ice cream.

The cream is usually pumped directly from the pasteurizer into the homogenizer at a temperature of about 130° F. From the homogenizer the cream is sent directly onto the cooler, the pressure of the machine being such as to force the cream to any height desired.

Aging Cream. It is well known that pasteurization lowers the viscosity of cream; it is likewise well known that pasteurized cream will regain, to a large extent, its viscosity if held at low temperatures a sufficient length of time. Ice cream manufacturers whose ambition is to secure maximum yields, have gone to extremes in regard to aging cream after pasteurization. Some actually hold the pasteurized cream a week, or longer before freezing. There is no justification in holding cream this long. As a rule, cream will have gained a large percentage of its "recoverable" viscosity six hours after pasteurization if held close to the freezing temperature; and little, if anything, in the way of body can be obtained by holding pasteurized cream longer than 24 hours before freezing, provided of course, that the cream is kept near 32° F.

What is said here about pasteurized cream applies

also to fresh, unpasteurized cream, though to a less extent. Sweet, fresh cream after it leaves the separator has little body and such cream should be held at least four hours close to the freezing temperature before freezing. But here as in the case of pasteurized cream, the time of aging at low temperatures before freezing should be limited to twenty-four hours.

While *prolonged* aging may slightly increase the body of the cream and, therefore, make possible a larger yield than can be obtained by aging cream six to twenty-four hours, the advantage thus gained is more than offset by the extra cost and labor involved in the extra holding and by the depreciation in the flavor due to bacterial development. Cream always contains bacteria capable of developing at freezing temperatures and the longer the cream is kept the more the flavor will suffer. Indeed there is actual danger in prolonged holding of cream at low temperatures because of the possible development of toxic substances. Every year many persons are poisoned by eating ice cream and such poisoning is usually ascribed to prolonged holding of insanitary cream at low temperatures.

What is said here about holding cream before freezing applies with equal force to cream after freezing. Hardening after freezing is essential, but there is no reason why this process should be extended beyond twenty-four hours. Ice cream will be better twenty-four hours after freezing than when kept longer.

The Use of Condensed Milk: A great many ice cream manufacturers use condensed milk in making ice cream. Some use as much as eight per cent. Condensed milk gives body to ice cream.

LACTO.

This is a frozen sour skim-milk product* which has proved very popular. The skim-milk for lacto is prepared in the same manner as for starter. Indeed a first class starter furnishes the best milk for this product. The following are a few of the formulas used for making lacto:

Cherry Lacto: 3 gallons lacto milk, 9 pounds sugar, 12 eggs, 1 quart of cherry juice or concentrated cherry syrup, 1½ pints lemon juice.

Orange Lacto: 3 gallons lacto milk, 11 pounds sugar, 12 eggs, 2½ quarts orange juice, 1½ pints lemon juice.

Grape Lacto: 3 gallons lacto milk, 9 pounds sugar, 12 eggs, 1 quart grape juice, 1½ pints lemon juice.

In making up the mixture for the different formulas the following procedure is recommended:

The sugar is first dissolved in the lacto milk. The eggs are then prepared. The whites and yolks are kept in separate containers and each lot is beaten with an egg beater. Both the yolks and whites are then added to the milk. The mixture is thoroughly stirred and strained through a fine wire gauze. The fruit juices are added last. If there is any indication of the juices precipitating the casein, they should be left out until the mixture has begun to freeze, when they may be added. The freezer is now run until it turns with difficulty, when the paddle is removed. The brine is removed and the freezer repacked with ice and salt and left for an hour before the contents are served.

Buttermilk has not proven very satisfactory for making a high quality lacto.

*Bulletin No. 118, Iowa Experiment Station.

CHAPTER XX.

MODIFIED MILK.

In the feeding of babies, the importance of changing the natural composition of cow's milk to approximate that of human milk is now so generally recognized by physicians, nurses and dieticians as to require no further comment. Milk so changed is known as modified or nursery milk, and what is needed now is to get milk dealers to recognize the importance of supplying this milk. All milk dealers have customers that are in need of modified milk and all should be in a position to provide it. While there are many who are supplying modified milk at the present time, it is safe to state that the great bulk of babies dependent upon cow's milk are fed this milk in an unmodified form.

Human and Cow's Milk Compared. In order that milk dealers may appreciate more fully this subject, we shall try to point out some of the main differences between human milk and cow's milk. According to Koenig, the composition of cow's milk and human milk is as follows:

	Water %	Fat %	Protein %	Sugar %	Ash %
Cow	88.17	3.69	3.55	4.88	0.71
Human	88.20	3.30	1.50	6.80	0.20

The chief difference between the two milks, it will

be noted, is in the protein content. Cow's milk contains more than twice the amount of protein found in human milk. But this is not all: the casein of cow's milk has an acid reaction while that of the human is alkaline. The acid condition of the milk casein causes it to clot when taken into the stomach which, in the case of the calf, does no harm because its stomach is adapted to handle such clots. With the baby the situation is different; with a small stomach and a small opening leading from it into the intestines, where the greater share of digestion takes place, a clot will cause the baby a great deal of discomfort. The alkalinity of human milk prevents to a great extent the formation of clots.

Method of Modifying Milk. As pointed out, cow's milk contains fully *twice* as much protein as human milk, and it is this excessive protein that must be gotten rid of in adapting cow's milk for infant feeding. To show how this may be done, we will suppose that approximately 225 pounds of modified milk is to be made. Take 150 pounds of whole milk and run it through a cream separator. Place the skim-milk in a vat, heat it to 100° F. and add rennet extract at the rate of 3 to 4 ounces per 1,000 pounds of milk. When curdled, cut the curd in cubes as in Cheddar cheese making and stir, gradually bringing the temperature up to 108° to 110° F. In the course of about 30 minutes the whey can be removed from the curd. The whey obtained in this way from the 150 of milk will amount to about 120 pounds. This whey will contain about 0.9 pound of protein consisting chiefly of albumen.

Next take 100 pounds of whole milk and add enough of the cream skimmed from the 150 pounds of milk to give it a fat content of 3.5% when mixed with the

they previously prepared. This will make the composition approximately correct so far as fat and protein are concerned. But the milk is deficient in sugar as human milk contains about 25% more sugar than cow's milk. The deficiency in milk sugar is made up by adding commercial milk sugar. Milk sugar is specified because it is more digestible than cane sugar.

It will be remembered that human milk has an alkaline reaction while cow's milk is decidedly acid. It is, therefore, advisable to add some lime water in modifying milk. Enough should be added to make the milk practically neutral.

The best lime preparation for reducing the acidity of milk is "viscogen," the preparation of which is discussed on page 113. Sugar has a great solvent action on lime and hence its use makes possible a very concentrated lime solution.

The milk to which the cream and sugar has been added, should not be mixed with the whey until the latter has been heated to 145° F. for ten minutes, or long enough to destroy the action of the rennet extract remaining in it. As soon as the rennet has been destroyed, the prepared milk is added to the whey and thoroughly mixed. Next the acidity is reduced by adding the viscogen prepared for this purpose. This done, the mixture is pasteurized at 145° F. for thirty minutes and then quickly cooled to a low temperature when it is ready for market.

The foregoing suggestions regarding the modifying of milk for infants can easily be followed by anyone and milk so modified can be sold at a profit by charging only slightly more for it than for ordinary market milk.

One of the things that has restricted the use of modified milk in the past is the high price at which it has been sold. There is no urgent need of putting the milk in small bottles provided with cotton plugs as is practiced in some of the large modified milk laboratories. What is needed above all is to get good pure milk and to reduce the casein content to at least one-half. Next in importance is the reduction of the acidity. Reducing the amount of casein not only eliminates an unnecessary tax upon the digestive system in disposing of a surplus of a certain food element, but makes the casein more digestible in that it cannot clot so readily. If, in addition to eliminating half the casein, the milk is rendered alkaline or nearly so, the tendency of the milk to clot in the stomach is practically eliminated. The amount of colic and suffering due to milk clotting in the infant's stomach, is difficult to estimate, but it is undoubtedly considerable.

Rations. Infants and children like young animals, require slightly changed rations with advancing age. Thus in some of the laboratories where milk is modified on a large scale, the percentages vary as follows:

Age of Child	Fat, %	Sugar, %	Protein, %
One week.....	2.00	4.50	0.75
Four weeks.....	3.00	6.00	1.00
Seven weeks.....	3.50	6.50	1.25
Fourteen weeks.....	3.50	6.50	1.25
Twenty weeks.....	3.75	6.50	1.50
Thirty weeks.....	4.00	6.50	1.75

It is not practicable for the average milk dealer to furnish different grades of modified milk; what he must do is to strike an average composition.

Simple Modification. An easy method of modifying milk in the home is discussed in Chapter XXVIII. This method is recommended to those who are not able to procure modified market milk.

CHAPTER XXI.

SOFT AND FANCY CHEESE MAKING.

There is a rapidly growing demand everywhere for the soft varieties of cheese such as cottage, Neufchatel and cream, and the manufacture of this class of cheese is becoming a very remunerative branch of dairying. The soft varieties of cheese are deservedly becoming popular because of their wholesomeness and palatability.

COTTAGE CHEESE MAKING.

Cottage cheese, which is made from skim-milk, may be manufactured in either of two ways, namely, with or without rennet extract. The cheese resulting from the use of rennet extract is finer grained though somewhat more acid than that obtained without rennet.

Rennet Method. When rennet extract is used, the night's separator skim-milk is held at a temperature of about 65 degrees F. until the following morning when it should show about 0.2 per cent acid. The temperature is then raised to 75 degrees F., and rennet extract added to the skim-milk at the rate of one-twentieth of an ounce (about one-half teaspoonful) per hundred pounds of milk. To insure an even distribution of the rennet, it should be diluted with a cup of water before mixing it with the milk. As soon as the rennet has been thoroughly mixed with the milk, the latter should be allowed

to stand quietly at a temperature of about 70 to 75 degrees F. for 24 hours, when a firm curd will have formed. The curd is now carefully dumped into a cotton bag or strainer and allowed to drain until all free moisture has escaped. Salt is next added at the rate of one and one-half ounces per ten pounds of cheese. The palatability of the cheese is much improved by adding a small amount of rich cream to it.

Fairly good results may be obtained by omitting the rennet.

Starter Method. This method yields the highest quality of cheese when fine flavored starter is used. Put the skim-milk into a vat and sour it with a good starter at a temperature of between 90 and 95 degrees F. The more starter used, up to 25 per cent, the better the quality of the cheese. Thoroughly mix the starter with the skim-milk and allow to remain undisturbed until firmly curdled. When this stage is reached, cut the curd, the same as in cheddar cheese making, and at once begin stirring by hand. Raise the temperature to 104 degrees F., keeping the curd constantly stirred during the heating process. After this the curd should be stirred occasionally for about 40 minutes, when the whey may be drained off.

The draining is best accomplished in a tin strainer covered with a piece of cheesecloth. The curd must be hand-stirred as soon as it has been dumped into the strainer, but the stirring should be done very gently at the start to prevent loss by mashing the curd particles. Continue the stirring until the curd is firm enough to prevent the particles sticking together, which usually requires about five minutes. As soon as the curd has been

stirred dry enough it is wrapped in the cloth strainer and squeezed with the hands until most of the free whey has been removed, that is, until it is dry enough to permit granulating it to fine particles by rubbing with the hands.

When the curd has been squeezed dry enough and thoroughly granulated by rubbing and stirring with the hands, it should be salted at the rate of about one and one-half ounces of salt per ten pounds of curd. After salting the curd is soaked with skim-milk or milk; or where a high quality of cheese is desired a thin cream should be used.

Packing Cottage Cheese. The same packages will answer for cheese made by either of the two methods. For simplicity and cheapness there is no better method of packing than the following: With an ordinary butter printer, print the cheese in one-pound blocks and then cut the blocks in two. This will make packages weighing one-half pound each. The half-pound blocks are wrapped in thin parchment or oiled paper in a manner similar to wrapping one-pound butter prints. The sheets of parchment or oiled paper for this purpose should be six inches wide by ten and one-half inches long. Any dealer in dairy supplies can furnish this paper at a very small cost. If the cheese is to be sold in one pound packages the wrapping paper should be eight and one-half inches wide by ten and one-half inches long. Cottage cheese may also be packed in water-proof packages such as are used for carrying ice cream, oysters, etc. The fiber butter boxes, made of pasteboard and lined with parchment paper, will also be found satisfactory for this purpose. Both of the above styles of package should be lined with

parchment paper before putting the cheese into them.

Some use wide-mouthed, single service milk bottles for packing cottage cheese.

Marketing. When much cheese is made, it should be marketed at fancy grocery stores and meat markets. If made on farms that operate daily milk routes in the city, much cheese can be sold on these routes to consumers direct, thus saving the middleman's profits. The average retail price of the cheese is ten cents per pound.

The yield of cottage cheese, when made according to the methods herein described will approximate 15 pounds of cheese per 100 pounds of skim-milk.

MAKING NEUFCHATEL CHEESE.

There are two methods by which American Neufchatel cheese may be made, namely, with and without the use of starter. The method of making the cheese without starter is as follows: Place the night's milk preferably in shotgun cans and cool to a temperature as near 70 degrees F. as possible. Next add at the rate of about one teaspoonful of rennet extract for each hundred pounds of whole milk. The rennet should first be diluted in a cup of water and then thoroughly mixed with the milk. If the temperature of the milk is kept at 70 degrees F. it will be thoroughly curdled in from 15 to 20 hours, when it should be perceptibly sour to the taste. The actual amount of acidity at this stage should be about 0.3 per cent. The curd is now poured onto a strainer rack covered with a cotton strainer cloth, or it may be poured or dipped into cotton bags, to drain. After the curd has drained an hour, light pressure should be applied to it which may be gradually increased to hasten the draining.

As a rule, it is desirable to have the draining completed in about three hours, the temperature during this process being maintained at about 70 degrees F. Applying moderate pressure will hasten the draining and is recommended for best results. As soon as the curd has sufficiently drained, salt is added at the rate of one ounce to every five or six pounds of cheese. The cheese should be thoroughly kneaded with the hands to distribute the salt evenly and to give it a smooth consistency. It is now molded into cylindrical packages, $1\frac{3}{4} \times 2\frac{3}{4}$ inches, weighing one-fourth of a pound. These cylindrical masses of cheese are first wrapped in thin parchment or oiled paper and then wrapped in tin foil. These packages usually retail at five cents each.

Starter Method. When starter is used a better flavored and more uniform cheese is possible. The starter may consist of well thickened whole milk allowed to sour in a natural way, but whole milk soured with pure culture of lactic acid bacteria is preferable. Where pure cultures are used the whole milk intended for starter should be pasteurized before inoculating it with the culture.

When starter is used the cheese is made as follows: Add at the rate of one pound of starter to four pounds of fresh whole milk. The mixture should have a temperature of about 80 degrees F. Next add at the rate of one-half tablespoonful of rennet extract per hundred pounds of milk, mixing the rennet with the milk as previously explained. When thoroughly curdled, which usually requires about one hour, the curd is ready to drain. The rest of the process is carried out the same as when no starter is used.

Neufchatel cheese yields from 18 to 20 pounds per 100 pounds of milk.

CREAM CHEESE.

Cream cheese is made from milk containing about ten per cent butter fat; that is, milk reinforced with cream. Like Neufchatel cheese, this cheese may be made with and without starter, and the processes are the same as with Neufchatel cheese, except that it will be found advantageous to have the temperature from three to five degrees higher. Much butter fat is saved when making cream cheese by the starter method. Cream cheese is molded in rectangular forms, $1\frac{1}{4} \times 2\frac{1}{4} \times 2\frac{3}{4}$ inches, holding about one-quarter of a pound. These packages usually retail at ten cents each.

CLUB CHEESE.

Another kind of cheese that is very much relished and that can be made by anyone, is known as "club" or "potted" cheese. The method of making this cheese is as follows: Grind up with an ordinary meat grinder five pounds of old, well-ripened cheddar cheese of good flavor, and mix this with one pound of good butter. The mixing is easily accomplished with a bread mixer. The mixing should be continued until the cheese has a uniform consistency, free from lumps. Running the mixture through the grinder a second time and working it with the hands will assist in reducing the lumps. This cheese can be packed in small tin-top jelly tumblers, covering the top of the cheese with parchment paper. This makes an exceedingly palatable cheese which retails, as a rule, at forty cents a pound. The cheese may also be packed in the same manner as Neufchatel.

COTTAGE CHEESE FROM BUTTERMILK.

By mixing at the rate of one pound of skim-milk to about five pounds of buttermilk, cottage cheese can be made from buttermilk in essentially the same way as from skim-milk.

Cottage cheese can be made from buttermilk without the addition of skim-milk, by a special method which originated at the Wisconsin Dairy School. The method is briefly as follows:*

The buttermilk is curdled by heating it to 80° F. and then allowing it to stand undisturbed for one hour. It is then heated to 130° and after standing quiet for about an hour, the clear whey is drawn off the curd, and the latter is placed on a draining rack, which is covered with cheese-cloth. Here it remains half a day or over night, until as dry as desired, when it is salted at the rate of one and one-half pounds of salt per hundred pounds of curd. The curd is then ready for use.

Cream containing 50 per cent or more fat, as well as buttermilk from cream which has been pasteurized when very sour, is not suitable for making buttermilk cheese by the Wisconsin method. The curd from such buttermilk is always so fine grained that it runs through the draining cloth and is lost.

WHEY, OR RICOTTA CHEESE.

Ricotta cheese, which is popularly known as Ziger or Whey cheese, is made from the whey resulting from the manufacture of other varieties of cheese, such as

*Bulletin No. 211, Wisconsin Experiment Station.

cheddar, and consists principally of albumen. The whey is ripened to 0.3 per cent acidity, either naturally or by the addition of sour whey. It is then heated to 165° to 175° F., usually by turning live steam directly into it. It is now allowed to stand undisturbed a few minutes when the fat may be skimmed off. After the removal of the fat, enough sour whey is added to bring the acidity to 0.4 per cent. It is now further heated with live steam until the temperature has reached as near 212° F. as possible. The albumen now slowly rises to the surface in a flaky condition and is skimmed off. Salt is applied at the rate of about 1½ ounces per 10 pounds of curd.

This cheese has a tendency to dry out, which is prevented by keeping it packed in stone jars and covering it with whey. It is usually marketed in small quantities wrapped in parchment paper.

Some prefer this cheese treated with cream.

PIMENTO CHEESE.

Pimento cheese is American Neufchatel cheese treated with ground red peppers. Usually from one-fourth to one-half pound of the pepper is used per ten pounds of Neufchatel cheese. The peppers are ground up fine by running them through a meat mincing machine after which they are thoroughly mixed with the cheese. Pimento cheese is very popular with those who like spicy foods. It is packed in the same manner as Neufchatel cheese.

CHAPTER XXII.

CERTIFIED MILK.

Definition. Certified milk is milk produced under conditions imposed by medical milk commissions, which usually employ a veterinarian, a bacteriologist and a chemist to look after the production of the milk. It must

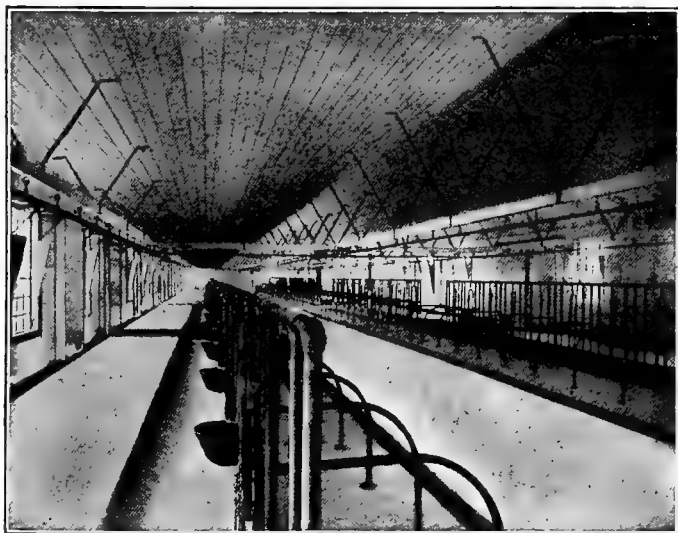

Fig. 48. —Sanitary Dairy Barn. (Da. Div., U. S. Dept. of A.)

be free from disease germs and preservatives, must have a known chemical composition, and must be so produced and handled as to insure a minimum number of bacteria.

If the producer has complied with all the requirements he is furnished a certificate by the commission, which permits him to use the "certified" label on his products.

The term "certified milk" is registered in the United States patent office and its use is legally permitted only on milk approved by medical milk commissions.

Uses. Certified milk is now largely used for infants and invalids. There is, however, also a rapidly increasing



Fig. 49. —Truman Sanitary Milk Pail. (Storrs, Conn. Station.)

use made of this milk by the better informed people who realize the unsanitary condition of average market milk. Certified milk is the means of saving the lives of thousands of infants and its increasing use offers splendid opportunities for dairymen who are in a position to meet the requirements laid down by medical commissions.

Production and Handling. The general conditions called for in the production of "certified" milk are essentially the same as those stated in the chapter on "sanitary milk production."

The cows, milkers and premises are regularly inspected, and the milk is regularly subjected to chemical and bacteriological tests. The number of bacteria permitted by different commissions varies from 10,000 to 30,000 per cubic centimeter of milk; and the fat content ranges from about 3.5 to 4.5 per cent.

The milk bottles are sealed preferably with metallic caps bearing the date of bottling and the name of the commission. Delivery should be made within twenty-four hours after the milk is drawn and its temperature during this time should not exceed 45° F.

In the dairy house arrangements must be such as to reduce contamination to a minimum. A receiving can placed in an ante-room is used by the milkers to empty their pails, and from this the milk is conducted into the milk room. A sterilizer with doors at both ends is preferably placed between the milk room and the wash room, so as to enable the milkers to get their pails without entering the milk room and, at the same time, to allow the sterilized bottles to be removed without entering the wash room. For details, see appendix.

Profits. Obviously it costs more to produce certified than average market milk, but the additional cost is less, as a rule, than the increased price realized. Certified dairies that have failed to make money have almost invariably invested more money in buildings and equipment than was actually necessary. It has been shown that this class of milk may be successfully produced in quite ordinary buildings and with moderately cheap equipment. What is of greatest importance is extreme cleanliness, which is achieved mainly through intelligent care and management of every detail of the work from start to finish.

CHAPTER XXIII.

RELATIVE MARKET VALUE OF MILK AND ITS PRODUCTS.

Many milk producers are so situated as to make it possible for them to sell either milk, cream, butter, cheese or ice cream. To those so situated the question naturally arises, what method of disposal will yield the largest returns? This, of course, will depend to a great extent upon the relative market prices of these products.

To show how dairymen may determine for themselves in what form they can realize most for their milk, a simple method of calculation is here presented, in which, for purposes of illustration, the following prices have been adopted: Milk, seven cents per quart; 30% cream, one dollar per gallon; butter, twenty-five cents per pound; cheese, thirteen cents per pound; and ice cream, made from 15% cream, one dollar per gallon. Using these as average prices for a given locality, determine the relative returns from one hundred pounds of milk containing 4% (4 lbs.) butterfat, (1) when retailed as milk, (2) when sold as cream, (3) when sold as butter, (4) when sold as cheese, and (5) when sold as ice cream.

1. Value of Milk. Since milk weighs 2.15 pounds per quart, 100 pounds of 4% milk are equal to 46.5 quarts, which, at 7 cents per quart, are worth \$3.25.

2. Value of Cream. One hundred pounds of 4% milk will make 13.33 pounds of 30% cream, as determined by the following rule:

Rule: To find the number of pounds of cream that can be obtained from a given amount of milk, multiply the milk by its test and divide the product by the test of the cream. Thus the amount of 30% cream from 100 pounds of milk testing 4% equals

$$\frac{100 \times 4}{30} = 13.33 \text{ pounds.}$$

Since a gallon of 30% cream weighs practically the same as a gallon of water (8.35 lbs.), the 13.33 pounds of cream are equal to 1.6 gallons which, at \$1.00 per gallon, are worth \$1.60. Allowing one-half cent per pound for skim-milk, we have 43 cents as the value of the 86 pounds of skim-milk, which gives a total value of \$2.03 for the 100 pounds of 4% milk.

2. Value of Butter. One hundred pounds of 4% milk will yield 4 2-3 pounds of butter, because where up-to-date methods of creaming and churning are followed every pound of butterfat will make 1 1-6 pounds of butter. Four and two-thirds pounds of butter at 25 cents per pound are worth \$1.17. Valuing buttermilk at the same price as skim-milk (one-half cent per pound) 48 cents should be added to the \$1.17 as the value of the skim-milk and buttermilk, making a total value of \$1.65 for the 100 pounds of 4% milk.

4. Value of Cheese. Since one pound of butterfat yields approximately 2.6 pounds of cured cheddar cheese, 100 pounds of 4% milk will make 4×2.6 , or 10.4 pounds of cheese, which, at 13 cents per pound, are worth \$1.35. Allowing 10 cents as the value of the whey from the 100 pounds of 4% milk, we get a total value of \$1.45.

5. Value of Ice Cream. Since a gallon of 15% cream weighs 8.45 pounds, 100 pounds of 4% milk will make 3.15 gallons of 15% cream (see formula for calculating cream, p. 240) or, allowing an overrun of 33 1-3%, 4.2 gallons of ice cream. At \$1.00 per gallon this is worth \$4.20. To this must be added the value of 73 pounds of skim-milk which, at one-half cent per pound, are worth 37 cents, making a total value of \$4.57 for the 100 pounds of milk made into ice cream.

Summary. The preceding calculations show that 100 pounds of 4% milk are worth

\$1.45	when sold as cheese,
1.65	when sold as butter,
2.03	when sold as cream,
3.25	when retailed as milk,
4.57	when sold as ice cream.

It is to be remembered that the above figures show the relative gross returns at the prices given. The net returns will vary greatly, depending largely upon the nearness to market and the quantity of milk handled; also to some extent upon the use to which the skim-milk is put. If fed to pigs and calves the value of skim-milk is less than one-half cent per pound; if made into buttermilk or cottage cheese its value may range from one to two cents per pound.

Table of Values. The following table of values has been prepared for handy reference. The price of milk is used as a basis, and the table shows at what prices cream and butter must be sold to give the same returns as milk:

Per Cent. of Fat in Milk	When Milk sells at	20% Cream must sell at	30% Cream must sell at	Butter must sell at
3.5	5c per quart	25c per quart	36c per quart	50c per pound
	6c " "	31c " "	43c " "	60c " "
	8c " "	42c " "	59c " "	84c " "
	10c " "	53c " "	75c " "	\$1.06 " "
4.0	5c per quart	22c per quart	31c per quart	44c per pound
	6c " "	27c " "	38c " "	54c " "
	8c " "	37c " "	50c " "	73c " "
	10c " "	46c " "	66c " "	93c " "
4.5	5c per quart	20c per quart	28c per quart	39c per pound
	6c " "	24c " "	34c " "	47c " "
	8c " "	32c " "	46c " "	65c " "
	10c " "	41c " "	59c " "	82c " "
5.0	5c per quart	18c per quart	25c per quart	35c per pound
	6c " "	21c " "	30c " "	43c " "
	8c " "	29c " "	42c " "	59c " "
	10c " "	37c " "	53c " "	75c " "

In calculating the above values, skim-milk and butter-milk have been rated at 30 cents per 100 pounds. The weight allowed per quart is as follows: Milk, 2.15 pounds; 20% cream, 2.1 pounds; and 30% cream, 2.0 pounds. The cost of handling and retailing these products, as well as the cost of making the butter, has not been considered.

From the table it will be seen that when 3.5% milk sells at 5 cents per quart, 20% cream must sell at 25 cents per quart, 30% cream at 36 cents per quart, and butter at 50 cents per pound, to yield equivalent returns. Similarly, when 5% milk sells at 5 cents per quart, 20% cream must sell at 18 cents per quart, 30% cream at 25 cents per quart, and butter at 35 cents per pound.

The table emphasizes the importance of selling milk on the basis of its fat content.

CHAPTER XXIV.

DETECTION OF TAINTED MILK AND CREAM.

In well regulated dairies the head operator will usually be found at the intake every morning carefully examining the milk as it arrives at the factory. It requires skill and training to detect and properly locate the numerous taints to which milk is heir. It also requires considerable tact to reform patrons who have been careless in the handling of their milk. The best skill available in the dairy should therefore be placed in the intake.

In the daily examination of milk, defects can usually be detected by smelling of it as soon as the cover is removed from the cans. When, however, milk arrives at the creamery at a temperature of 50° F. or below, it becomes more difficult to detect taints; indeed during the winter when milk is often received in a partly frozen condition, experts may be unable to detect faults which become quite prominent when the milk is heated to a temperature of 100° F. or above.

Frequently milk is seeded with undesirable kinds of bacteria which have not had time to develop sufficiently to manifest themselves at the time the milk is delivered to the creamery, but which later in the course of cream ripening produce undesirable flavors. It is necessary, therefore, in making a thorough examination of milk to heat it to a temperature of from 95° to 100° F. and to keep it there for some time to permit a vigorous bacterial development. Such bacterial development can be carried on in what is known as the Wisconsin Curd Test and the Gerber fermentation test.

WISCONSIN CURD TEST.

This test originated at the Wisconsin Dairy School. The name of the test implies that the samples of milk to be tested are curded, which is accomplished in a manner similar to that in which milk is curded for cheese making.

The Wisconsin Curd Test is frequently spoken of as "fermentation test," since the process involved consists in fermenting the milk by holding it at a temperature at which the bacterial fermentations go on most rapidly.

Apparatus. This consists of one pint cylindrical tin cans placed in a tin frame, and of a well insulated box made so that the tin frame will nicely slide into it. Added to this is a case knife, and a small pipette used to measure rennet extract.

The construction of the box and the position of the cans inside is illustrated in Fig. 49. This box consists of three-eighths inch lumber, the inside of which is lined with a quarter inch thickness of felt. Narrow strips are tacked on the felt and tin upon these, the object of the strips being to prevent conduction of heat by contact of the tin with the felt. The cover of the box is constructed in the same way and made to fit tight. This construction makes it possible to maintain a nearly constant temperature of the samples which are surrounded by water as shown in the illustration.

Making the Test. A curd or fermentation test is made at the creamery by selecting from each patron about two-thirds of a pint of milk and placing this in the tin pint cans after they have been thoroughly sterilized. Each pint can should be provided with a sterilized cover which is placed upon it as soon as the sample has been taken.

The sample cans are next placed in the insulated box provided for them. Here they are warmed by adding water at a temperature of 103° F. to the box, a temperature which should be maintained throughout the whole test.

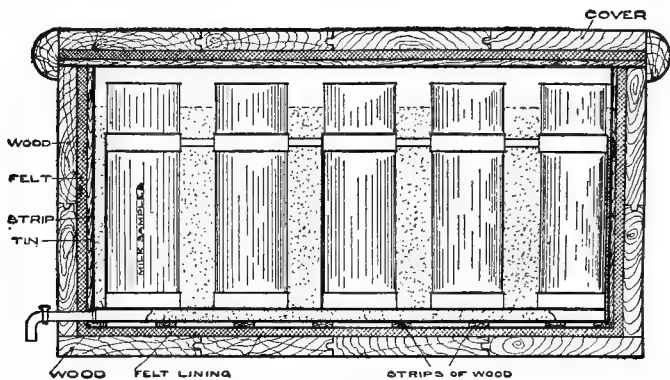

Fig. 49.—Section through curd test.

With a sterile thermometer watch the rise in temperature until it has reached 86° F. when 10 drops of rennet extract are added to each sample and mixed with it for a few moments with a sterile case knife. This knife must be sterilized for each sample to avoid transferring bacteria from one can to another.

As soon as the milk has curdled it is sliced with the case knife to permit the separation of the whey. After the whey has been separating for half an hour, the samples should be examined for flavor, which can be told far better at this stage than is possible by smelling of the milk as it arrives at the creamery.

After the samples have all been carefully examined, the whey is poured off at intervals of from twenty to forty minutes for not less than eight hours. At the end

of this time a mass of curd will be found at the bottom of the can in which there has been a vigorous development of bacteria throughout the test.

If the sample of milk is free from taint, this curd when cut with a knife will be perfectly smooth and close. If, on the other hand, the sample contains gas germs, these in course of eight hours' development will have produced enough gas to give the curd an open spongy appearance when cut. The openings are usually small and round, hence the name "pin holes" has been applied to them indicating holes the size of a pin's head.

Whenever, therefore, milk produces a curd that answers this description it may be taken for granted that it contains **undesirable bacteria**.

Sometimes the milk may be tainted and yet produce a close textured curd, but in such cases the taint can be detected by carefully smelling of the curd.

Precautions. In making a test as above outlined two things must constantly be kept in mind: first, that to secure the desired bacterial development, the temperature of the samples must be maintained as nearly as possible at 98° F., which is accomplished by surrounding them with water at a temperature of 103°; second, that to avoid contaminating one sample with another, the knife used for mixing the rennet with the milk and cutting the curd must be sterilized for each can. The thermometer used must also be sterile.

The temperature of the samples can easily be maintained by using a well insulated box like that shown in Fig. 51. When a common tin box is used it becomes necessary to change the water in it about once every half hour.

GERBER FERMENTATION TEST.

This test is simpler than the Wisconsin Curd Test and can be used for both milk and cream. Where milk need not be examined specially for gas-producing organisms, this test will give as satisfactory results as the curd test. The essential difference between the two tests is the elimination of rennet extract with the Gerber.

Making the Test. The samples of milk or cream are placed in glass tubes which are numbered to correspond with the names of the patrons. These tubes are warmed in a tin tank containing water whose temperature is maintained at 104° F. throughout the test by placing a lamp under the tank. At the end of about six hours the samples are examined for flavor, color, taste and consistency. After this examination, they are put back into the tank to be re-examined after another interval of about six hours. Any "off" condition of the milk or cream can usually be told at the end of six to twelve hours.

CHAPTER XXV.

DETECTION OF PRESERVATIVES AND DIRT.

PRESERVATIVES IN MILK.

Milk dealers sometimes add small quantities of preservatives or antiseptics to milk to prolong its keeping quality. These substances check bacterial development, and whatever stops the growth of bacteria also acts injuriously upon the human system. For this reason the use of preservatives in milk is strictly prohibited by law.

Among the preservatives most commonly found in milk are boric acid and its compounds, formaldehyde and salicylic acid and some of its compounds. Methods for detecting these substances are given in the following paragraphs:

Boric Acid. This acid, or its compounds, is often used as a preservative. While far less harmful than many other preservatives, it has been known to cause stomach and bowel disturbances, and its use in milk is universally condemned. There are a number of methods for detecting boric acid, two of which are here described:

1. Treat a small quantity of milk with a few drops of phenolphthalein; then add, by drops, sodium hydroxide till a faint pink color is noticeable. Now divide the milk between two test tubes, diluting one with an equal volume of water and the other with a neutral 50 per cent solution of glycerin. When no boric acid is present, the color of the two tubes will be practically

the same; if boric acid is present, the glycerin tube will be lighter, usually white.

2. Another method commonly used is to treat about 100 c.c. of milk with enough sodium or potassium hydroxide to render the same alkaline; then evaporate to dryness and incinerate; dissolve the ash in water slightly acidulated with hydrochloric acid, and filter; dip a piece of turmeric paper in the filtrate and dry at 212° F. If boric acid is present, the paper will assume a reddish brown color.

Formaldehyde. This is a violent poison which has strong antiseptic properties. A trace of it will preserve milk for a considerable time. As in the case of boric acid, a number of methods are available for detecting small quantities of this preservative in milk. The following method will reveal the preservative, even when only a trace of it is present.

Mix 5 c.c. each of milk and water in a porcelain dish. Add 10 c.c. of hydrochloric acid containing a trace of Fe_2Cl_6 , then heat the mixture very slowly. A violet color is formed in the presence of formaldehyde.

Another method of detecting formaldehyde is as follows: Mix equal quantities of milk and water in a test tube, then add a little of 90 per cent commercial sulphuric acid in such a way that the acid will run along the side of the tube and form a layer at the bottom. In the presence of formaldehyde, a bluish or violet zone develops at the junction of the acid and the milk; in its absence the zone develops a greenish color. This method will detect one part of formaldehyde in 200,000 parts of milk.

Salicylic Acid. This acid, while less poisonous than formaldehyde, seriously affects digestion and also exerts

an irritant effect upon the kidneys. Its presence in milk is easily detected by the following test:

Add 2 to 3 drops of sulphuric acid and about the same amount of ether to 20 c.c. of milk, then shake the mixture; evaporate the ether solution and treat the residue with 40 per cent solution of alcohol, and filter. The

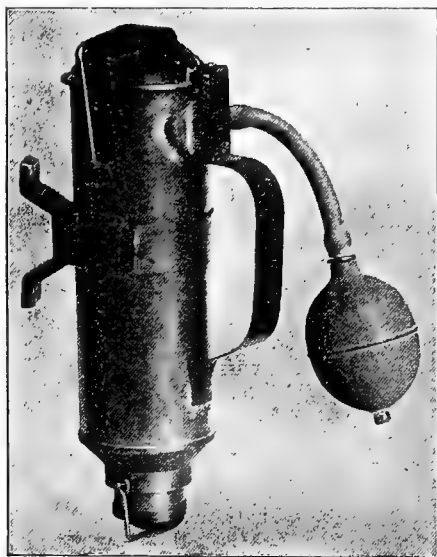

Fig 50.—Sediment Tester.

addition of a few drops of ferric chloride to the filtrate will produce a violet color in the presence of salicylic acid.

DIRT IN MILK.

There is undoubtedly more dirt consumed through milk than through all other food products combined.

With a reasonable amount of care in milking, the amount of dirt now carried in market milk could easily be reduced 75 per cent.

Producers as a rule do not realize how much dirt actually gets into their milk because they are not able to see it in the cans except when the cans are carefully emptied, in which case dirt may be noticed in the bottom of the can. Sediment is also noticeable in dirty bottled milk.

The best way of demonstrating to producers the condition of their milk with respect to dirt, is to use sedi-

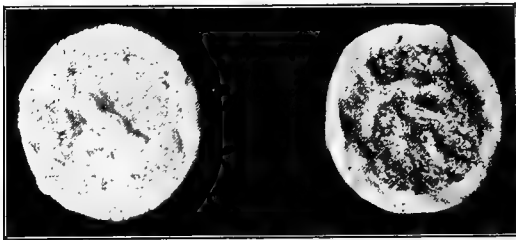

Fig. 51.—Cotton Filters.

ment testers like those shown in Figs. 50 and 52. These are simple devices for *filtering* the dirt out of milk. The tester shown in Fig. 50 is a small metal container into which the milk is poured, the cover clamped on and the milk forced through a cotton filter by squeezing the air bulb. The device shown in Fig. 52 does away with the metal container, the cover with attached air bulb being clamped on the milk bottle and the milk forced directly from the bottle through the cotton filter. Any dirt removed from milk with either of these testers is easily seen on the white cotton filters. (See Fig. 51.)

Testers of this kind are being used with much success by milk inspectors and milk dealers in getting producers to furnish cleaner milk.

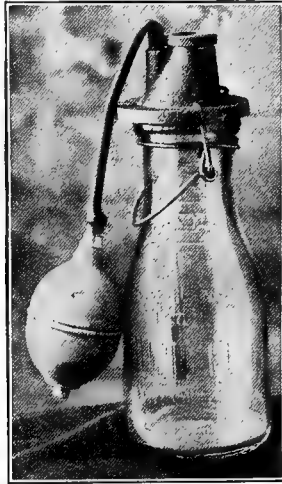

Fig. 52.—Sediment Tester.

CHAPTER XXVI.

JUDGING MILK AND ITS PRODUCTS.

JUDGING MILK AND CREAM.

Official judging of milk and cream is a comparatively new matter, and its adoption at dairy shows, state fairs and dairy conventions, has naturally followed the general interest manifested everywhere in a pure milk supply for towns and cities. The use of the score card has been found of especial value in bettering the conditions surrounding the production and handling of milk at the farm.

Score Card. The following is a good specimen of the score cards used at the present time:

Class..... Exhibit No.....

Item	Perfect Score	Score Allowed	Remarks
Bacteria.....	35	Bacteria found per } cubic centimeter }
Flavor and odor..	25	} Flavor..... { Odor.....
Visible dirt.....	10
Fat.....	10	Per cent found.....
Solids not fat....	10	Per cent found.....
Acidity.....	5	Per cent found.....
Bottle and cap...	5	} Cap..... { Bottle.....
Total.....	100	

Exhibitor

Address.....

(Signed)

Judge

EXPLANATION OF SCORE CARD.

Bacteria. The maximum number of bacteria permissible per cubic centimeter for a perfect score on bacteria as a rule is 400. Numbers beyond this point will detract from the score until 200,000 is reached when the score is zero. Deductions from the perfect score are made uniform, being proportional to the bacteria count between 400 and 200,000.

A bacteria count as low as 400 per c.c. is possible though difficult to attain. By exercising proper cleanliness and thoroughly cooling milk, the majority of dairymen can keep the bacteria count below 10,000 per c.c. A low bacteria count is largely a matter of cleanliness and low temperature.

Flavor and Odor. Flavor refers to taste and odor to the aroma detectable by the nose. It is impossible to describe a perfect flavor and odor. Anything in the least objectionable to the taste or smell will detract from the score. Under this head, weedy, stable, manure, bitter, rancid, and unclean flavors or odors are most common. To obtain a perfect score for flavor and odor, perfect cleanliness must prevail, the milk must be kept free from odoriferous surroundings and feeding must be done after milking, especially when silage, or other odoriferous feeds are fed.

Visible Dirt. Any sediment, however slight, in the bottom of the bottle will detract from the score. Most milk will show visible dirt unless it has passed through a clarifying process. Dust, particles of dirt, hairs or particles of litter, and sometimes all of these, are noticeable in the bottom of bottled milk.

The greatest factor in reducing dirt to a minimum is washing the cow's flanks and udder just previous to

milking. The moist condition prevents the dislodgement of dirt. Another great aid in obtaining clean milk is the covered milk pail.

Fat. To obtain a perfect score on fat, milk, as a rule, must contain not less than 4.0%. For each tenth below 4.0%, 0.2 point is deducted from the perfect score till 3.5% is reached. A whole point is deducted for every tenth below 3.5%. Milk with a fat content less than 2.7% or less than the legal local limit, is scored zero for fat.

Cream is usually scored perfect for fat when its fat content is 20% or above.

Solids Not Fat. Usually 8.7% or more is required for a perfect score on solids not fat. For each tenth per cent below 8.7% one point is deducted. Milk containing less than 7.8% or less than the legal limit, is scored zero for solids not fat.

Solids not fat are not considered in cream.

Acidity. The limit of acidity for a perfect score is 0.2%. When milk is thoroughly cooled there is little difficulty in keeping the acidity below this limit.

Bottle and Cap. The following defects detract from the perfect score for bottle and cap: Partially filled bottle, tinted glass, leaky caps, improperly paraffined caps, unprotected caps and anything that in any way detracts from the appearance of the package.

JUDGING BUTTER.

Butter is judged commercially on the basis of 45 points for flavor, 25 for texture, 15 for color, 10 for salt and 5 for package: total 100.

A score card showing the common defects of butter is presented on the following page.

BUTTER SCORE CARD

No. _____

	Perfect.	1st Scoring Date.....	2d Scoring. Date.....	
Flavor.....	45			{ Curdy. Light. Rancid. Fishy. Feverish Oily or greasy. Weedy. Stable. Unclean. High acid. Bitter.
Texture.....	25			
Color.....	15			{ Poor grain. Cloudy brine. Weak body. Too much brine. Greasy.
Salt.....	10			
Package.....	5			{ Mottles, White specks. Too high. Too light. Color specks.
Total.....	100			

Remarks :

Judges

Date.....

{ _____

Flavor: Immediately after the sample of butter is withdrawn from the package it should be held under the nose to ascertain the quality of the aroma (flavor). Strictly speaking, flavor refers to the taste. But the use of the term flavor in butter judging usually includes both taste and aroma, the emphasis resting upon the latter.

It is difficult to describe an ideal butter flavor. It may, perhaps, be likened to the flavor of clean, uncontaminated, well ripened cream, that is, it should be rich and creamy.

Curdy flavor is caused by overripened starters or adding starters to cream while the latter is at too high a temperature. Also by ripening very thin cream at high temperatures.

Light flavor is generally due to churning cream too sweet. It may be due also to too much washing and to the character of the feed. It is well known that good succulent June pasturage produces a higher flavored butter than average dry winter feed.

Rancid flavor is due chiefly to overripened cream. The age of the milk, cream and butter is also frequently the cause of rancidity. Good butter exposed to light and air at ordinary temperatures turns rancid in a very short time.

Feverish flavor is noticeable principally in the spring of the year when cows are turned out on pasture and is, no doubt, due in most cases to the sudden change from dry feed to luxuriant pasturage. It is possible that this feverish or grassy odor is due partly to the grass itself and partly to a feverish condition of the cow caused by the sudden change of feed. We find that any feverish

condition of the cow will manifest itself in the milk and the products therefrom.

Oily or *greasy* flavor may be caused by churning and working butter at too high a temperature, or by keeping the milk and cream at high temperatures. It may also be caused by using poor color or too much color. Bad smelling color that shows sediment at the bottom should not be used. Bacteriologists claim that certain species of bacteria have the power of imparting an oily flavor to butter.

Woody flavors are caused by cows feeding on weeds. Leeks or wild onions are frequently the cause of very serious trouble when cows have free access to them. The trouble may also be caused by exposing milk and cream to an atmosphere charged with objectionable odors.

Fishy flavor, according to L. A. Rogers, is due to oxidation which is favored by a high acid cream and overworking. The latter favors oxidation by increasing the amount of air in butter.

Stable flavor is caused by lack of cleanliness in milking, and by keeping milk too long in, or near, a dirty stable.

Unclean flavors are caused by dirty pails, strainers, and cans, filthy creamery conditions, and general uncleanliness in the care and handling of milk.

High acid flavor is due to oversoured cream or starter.

Bitter flavor is caused by keeping cream too long at low temperatures.

Texture. This includes three distinct things: (1) grain, (2) body, and (3) brine.

An ideal grain is indicated by a somewhat granular appearance when a piece of butter is broken, an appear-

ance quite similar to that of the broken ends of a steel rod.

Body refers to the consistency of butter. In other words, it refers to its degree of firmness or its ability to "set up" well at ordinary temperatures.

Brine refers to the amount and character of the water in butter. It should be as clear as water and not present in such quantities as to run off the trier.

Poor grain is caused by overworking and overchurning; also by too high temperatures in churning and working.

Weak body is usually caused by employing too high temperatures in the entire process of manufacture, including the ripening of the cream. These high temperatures usually result in overripened cream, overchurned butter and consequently butter with too high a water content. The character of the butter fat also influences the body of the butter.

Too much brine is caused chiefly by underworking and by churning to small granules.

Cloudy brine is caused by churning at too high a temperature and also by granulating too coarse. Insufficient washing has a tendency to produce a cloudy brine.

Greasy butter is caused by overworking or by handling at too high temperatures.

Color. The essential thing in color is to have it uniform. It should have a little deeper shade than that produced by June pasturage. Artificial coloring is therefore necessary.

Mottles are discolorations in butter caused by the uneven distribution of salt. Those portions of the butter that contain the most salt will have the deepest color because of the attraction of salt for color. Mottles

can always be removed from butter by working, but frequently the conditions are such as to require overworking to secure this end.

The following are conditions that favor mottles:

1. Coarse uneven grained salt.
2. Carelessly adding the salt to the churn.
3. Butter too cold for working.
4. Using too cold or too warm wash water.
5. Too much buttermilk in the butter.
6. Not enough moisture in butter when worked.

White specks are due either to curd particles in cream caused by overripening and lack of stirring during ripening, or to dried and hardened cream.

Color specks are tiny specks of color caused by using a poor grade of color, old color, or color that has been kept at too high a temperature.

Salt. As with color, the essential thing with salt is to have it evenly worked through the butter and none of it should remain undissolved.

Undissolved salt may be due to four things:

1. Poor salt.
2. Too much draining before salting.
3. Salting the butter at too low a temperature.
4. Too much salt.

JUDGING CHEDDAR CHEESE.

Cheese is commonly judged on the basis of 45 points for flavor, 30 points for texture, 10 points for color and 15 points for finish and appearance. Some judges prefer to divide the 30 points allowed for texture, giving 15 points for texture and 15 points for body. This division is not essential, however, and the judging of cheese will be discussed upon the basis of the following score card which gives the common defects found in Cheddar cheese;

CHEESE SCORE CARD

No. _____

	Perfect Score	Actual Score	
Flavor.....	45		{ Strong Rancid Acidy Sour High, Quick Low, Flat Stable Bitter Weedy Fruity
Texture.....	30		{ Curdy Pin hole Swiss hole Pasty Mealy Corky
Color.....	10		{ Mottled, wavy Pale Too high
Finish or appearance...	15		{ Dirty Moldy Uneven Cracked Wrinkled
Total.....	100		

Remarks:

..... Judge

Date.

Flavor. The plug of cheese for examination should be drawn from the top of the cheese and not from the side as is sometimes done. As soon as removed from the cheese, the plug is held close to the nose to get the flavor. The flavor is further tested at the final examination for texture when the cheese is kneaded and molded in the hands. This process warms the cheese to near the temperature of the hands thus enabling it to give off more of its odor or aroma.

It is difficult to describe an ideal cheese flavor; perhaps the best that may be said is that it should be clean and nutty. Some of the defects in flavor given on the score card have already been described under butter judging, and the balance of the defects are sufficiently suggestive to require no further explanation. It may be stated that a sour cheese is one containing an excess of acidy whey and is usually soft. An acidy cheese is more or less brittle and smells acidy.

Texture. An ideal textured cheese is solid, waxy and meaty. When the plug of cheese is broken the ends should not be smooth but have a flinty appearance. *Pinholes* indicate that the cheese was made from gassy milk. *Swiss* holes or openings about the size of buck-shot indicate an insufficient development of acid in the curd. Curdy cheese is tough and rubbery, indicating insufficient ripening. *Corky* cheese lacks moisture and resembles cork. A *mealy* or crumbly texture is the result of too much acid while a *pasty* texture is the result of too much moisture.

Color: A plug of cheese when held to the light should be translucent. A white, pale color indicates too much acid. Too much moisture also produces a dead color. Mottled cheese may be the result of uneven coloring,

uneven cooking, uneven temperatures or not straining the starter. The degree of color does not affect the score, as different markets demand different degrees of color. Cheese to which no color has been added should have an amber color.

Finish. The surface of the cheese must be entirely free from checks or cracks to prevent danger from skippers. The bandage must be free from wrinkles and the edges should be square. Mold is objectionable and can be prevented by paraffining, by rubbing the cheese daily, or by avoiding a stagnant atmosphere in the curing room. Cheese presenting a dirty appearance should be severely scored.

CHAPTER XXVII.

BUYING AND SELLING ON THE BUTTER FAT BASIS.

Milk and cream should be bought and sold on the basis of the amount of butter fat contained in them, whether made into butter and cheese, or sold as milk, cream and ice cream. In butter making it would be considered absurd now-a-days to pay for milk and cream on any basis other than the fat basis, because the yield of butter is proportional to the amount of butter fat used.

In the case of market milk and cream, the same number of quarts are obtained per hundred pounds regardless of the quality of the milk and cream; consequently milk dealers have found the quality basis of less importance in their business than butter makers have found it in theirs. So far as consumers are concerned, however, the quality basis counts the same in market milk as in butter making, because the food value of milk is approximately proportional to the per cent of fat contained in it.

Quality and the Producer. Paying for milk by the can or hundred, irrespective of its fat content except that it must not fall below a certain minimum, has a demoralizing effect on producers. Under such conditions the moment a farmer changes from the creamery or cheese factory where he has been paid on the quality basis, he begins to look for cows which produce large yields but a relatively poor quality of milk. A change of individual cows, and, as often happens, a complete

change from one breed to another, is attended with considerable expense as well as with a certain amount of danger. There is always the risk of introducing disease into the herd where changes of this kind are made.

One of the great drawbacks to the gallon or hundred-weight basis, therefore, is the handicap which it places upon herd improvement. It is now almost universally conceded that weighing and testing the milk from each cow individually is one of the greatest aids in building up a dairy herd. Where milk is sold by weight alone, half the benefits of this system are lost to the producer. It is possible, for instance, that the most valuable cow in the herd, so far as total butter fat production is concerned, will be found unprofitable to keep if her milk yield is low and the quality very rich. There can be no satisfactory herd improvement unless the *total* butter fat can be taken into account, and this is impracticable when the milk is sold on the *quantity* basis alone.

Quality and the Consumer. Wide variations exist at present in the quality of market milks. Analyses of normal market milks show a variation in fat content of from 3% to 5.5%. And there is a great deal of milk sold illegally containing only 2.5% butter fat.

From a nutritive standpoint butter fat is the most valuable constituent of milk, but this is not the only constituent that varies in market milks. Milk which is rich in butter fat is likewise rich in other milk solids, such as casein, sugar and albumen; so that the richer the milk is in butter fat the richer it is in solids other than fat. For this reason it would not be fair to say that 100 pounds of 4.5% milk contains only one pound more food material than 100 pounds of 3.5% milk.

The casein, next to the butter fat, is the most valu-

able food constituent of milk, and the quantity of this in any sample of milk bears a rather definite relation to the butter fat in the same milk, as the following figures of Dr. Van Slyke, of the Geneva (N. Y.) Experiment Station, show:

Per cent of fat in milk.	Per cent of casein in milk.
3.0	2.1
3.5	2.3
4.0	2.5
4.5	2.7
5.0	2.9

The other constituents of milk, while they vary according to the butter fat content, do not vary as much as the casein.

It is fair to say that in point of food value, a quart of 5.5% milk is worth at least 50% more than a quart of 3.0%. In other words, when a consumer pays 9 cents a quart for 5.5% milk he is paying no more for the actual amount of food he gets than when he pays 6 cents a quart for 3% milk.

It is as much a business proposition for consumers to consider the food value of milk as it is to consider the quality of cloth they buy. Milk should be bought under a guarantee as to its quality, which guarantee the consumer can enforce by having his milk tested occasionally for butter fat. The cream line on the bottle, upon which consumers rely more or less, is not a sure indication of the quality of the milk.

A definite percentage of butter fat should also be guaranteed in cream. This is especially important since the homogenizing of cream and the frequent use of viscogen by milk dealers makes it impossible to place

any reliance upon consistency as an index to quality. Both the homogenizing process and the use of viscogen materially increase the body or consistency, thus making cream look much richer than it actually is.

Ice cream, too, should be paid for on the basis of the amount of fat it contains. While generally used as a delicacy or dessert, its high food value when made from good cream justifies a far larger consumption of this product.

Quality and the Milk Dealer. Because the bulk of consumers have hitherto been so indifferent regarding the amount of butter fat in the milk they buy, milk dealers have made few efforts to volunteer supplying milk of special quality and for the same reason they have not been obliged to pay much attention to the quality of the milk they buy, except that it comes within the limits prescribed by law.

As already pointed out, the system of handling milk regardless of its quality is wrong and has a demoralizing influence on the milk trade, and because of this, a change to the quality basis must come sooner or later. Indeed in some sections, notably in the east, milk dealers are beginning to guarantee the quality of the milk they sell and with very satisfactory results. The minimum per cent of butter fat guaranteed is usually stamped on the bottle cap. This is in line with progress in the milk business, and it is hoped that the system of guaranteeing the quality of milk will become general.

In buying cream, many milk dealers and ice cream manufacturers pay a certain price per gallon guaranteed to contain a certain per cent of fat. Others buy cream by the gallon, paying a certain price based upon a

certain test and paying a unit price for each per cent of fat above the actual test required. The proper method of buying cream is to pay a definite price for each pound of butter fat contained in it.

CHAPTER XXVIII.

THE CARE OF MILK IN THE HOME.

No matter how good the condition of the milk when delivered, if carelessly handled in the home it will keep sweet but a very short time and the dairyman will get the blame. It is of vital interest to dairymen, therefore, to instruct their customers in the proper care of the milk in the home.

There is no doubt that a great deal of good milk is spoiled in the home of the consumer. This, as a rule, is the result of ignorance. Few consumers have a good knowledge of milk and, therefore, do not know how to care for it. If milk producers will bring the following suggestions to the attention of their customers, it may relieve them of much of the complaint they have hitherto been obliged to suffer :

Instructions to Consumers. To keep milk and cream sweet and pure, they must be kept cold and clean. As soon as the milk is delivered, it should be put in a cool place—a clean refrigerator if possible. The vessels in which the milk and cream are kept must be sterile and covered. Vessels are not sterile unless they have been kept in boiling water for five minutes and then inverted upon a clean shelf without wiping.

On account of their great absorption properties milk and cream must be kept in covered vessels, especially when placed in the kitchen or cellar or possibly in the refrigerator with fruits and vegetables. Aside from absorbing odors when exposed in these places, they will also take up bacteria which will shorten their keeping quality.

At 45° F. milk may be kept perfectly sweet for twenty-four hours, while at a temperature of 70° it may sour in less than six hours. This emphasizes the importance of cold in preserving milk and cream.

Pour milk from one vessel to another as little as possible to avoid contamination. The best plan is to keep it in the original bottles.

Do not add new milk to old milk; neither add warm milk to cold.

The tops of the bottles should always be washed before removing any milk. They are more or less contaminated with dust during transportation and also become soiled from the hands.

Always clean the bottles before returning them.

Finally it is well to remember that the lowest-priced milk is usually also the poorest and dirtiest. Such milk in the end will prove the most expensive.

HOME PASTEURIZATION.

Milk used for baby feeding should be pasteurized in the home regardless of whether it has been previously pasteurized or not. The best of pasteurized milk needs re-pasteurizing to destroy the bacteria that have developed in the interim between pasteurization and delivery.

A simple method of pasteurizing in the home is as

follows: Place the milk in a sterile double boiler and heat for thirty minutes at a temperature of 140° to 145° F. Then quickly cool and keep at a temperature of 50° F. or below until all has been consumed. The lower the temperature at which the milk is kept the less chance for bacterial development. The milk should be frequently stirred during the heating process. A reliable thermometer is indispensable.

MODIFYING MILK IN THE HOME.

Where market modified milk is not available, the following simple method of modifying cow's milk for baby feeding may be used with good success in all homes: Take a quart of rich milk and pour out two-thirds of the contents, which will contain most of the cream; add water to the enriched milk, using one part water to two parts milk; next add a little more than two level tablespoonfuls of milk sugar, and neutralize the mixture by adding two to three tablespoonfuls of viscogen (see page 113). Now pasteurize the mixture as directed under "home pasteurization."

The amount of viscogen required to neutralize the milk will depend upon the acidity of the milk and the strength of the viscogen solution. The amount required can easily be determined by adding a few drops of phenolphthalein, dissolved in alcohol, to a small measured amount of milk. In the presence of acid the color of the milk remains unchanged, but as soon as the milk becomes alkaline it changes to a pink color. Standard lime water kept at drug stores is far weaker than viscogen, requiring about one part of lime water to neutralize two parts of milk

If there is any tendency to constipation in feeding

milk prepared according to the above directions, the milk should be diluted with oat meal water instead of plain water. The oat meal water is prepared by adding a tablespoonful of rolled oats to a pint of water and boiling the mixture for at least thirty minutes. Strain through several thicknesses of cheese cloth and use the filtrate. The use of oat meal water in place of plain water in diluting milk is especially recommended for babies over three months of age when a more concentrated ration should be fed. The addition of cream is also desirable with advancing age.

One important precaution in successful baby feeding is to wash the nipples and bottles in hot water to which some alkali has been added, and to keep them well sterilized by boiling them in water. Frequent boiling in lime water is desirable.

CHAPTER XXIX.

KEEPING MILK AND CREAM ACCOUNTS.

Various methods are followed in keeping accounts with patrons, but nearly all of them involve the use of tickets, route book, and some form of ledger. The method here described is recommended because of its simplicity.

Tickets. Most customers prefer to settle their milk and cream accounts daily. This they do by purchasing a quantity of tickets from the milkman and handing them out every time milk or cream is purchased.

The tickets should be used but once. Where they are repeatedly used they become dirty and a real source of danger. Passing from one household to another they are likely to become contaminated with disease germs and thus become the means of disseminating disease.

The coupon ticket presented on the next page is one of the most satisfactory in use at the present time. The portion of the ticket above the perforations is retained by the milkman. If the ticket is paid for at the time of purchase, this must be indicated on the stub retained by the dairyman as well as on the customer's ticket.

Coupon tickets are also used for cream and buttermilk. Tickets for different products should have different colors.

Tickets are not absolutely necessary; indeed, many customers prefer to do without them. Where no tickets are

No. 45 Date Dec. 2 1908

Mr. C. Eaton
102 Elm St.

To TICKETS \$1.00. MILK. Cr. 1.00

MILK.
No. 45 Date Dec. 2 1908

Mr. C. Eaton

To SPRING VALLEY DAIRY, Dr.

J. L. JONES, Prop., Middletown, N. Y.

To TICKETS \$1.00.

Received Payment J. L. Jones

Date Dec. 2 1908

ONE PINT.	SPRING VALLEY DAIRY. ONE QT. MILK MIDDLETON, N. Y.	ONE PINT.	SPRING VALLEY DAIRY. ONE QT. MILK MIDDLETON, N. Y.	ONE PINT.
ONE PINT.	SPRING VALLEY DAIRY. ONE QT. MILK MIDDLETON, N. Y.	ONE PINT.	SPRING VALLEY DAIRY. ONE QT. MILK MIDDLETON, N. Y.	ONE PINT.
ONE PINT.	SPRING VALLEY DAIRY. ONE QT. MILK MIDDLETON, N. Y.	ONE PINT.	SPRING VALLEY DAIRY. ONE QT. MILK MIDDLETON, N. Y.	ONE PINT.
ONE PINT.	SPRING VALLEY DAIRY. ONE QT. MILK MIDDLETON, N. Y.	ONE PINT.	SPRING VALLEY DAIRY. ONE QT. MILK MIDDLETON, N. Y.	ONE PINT.
ONE PINT.	SPRING VALLEY DAIRY. ONE QT. MILK MIDDLETON, N. Y.	ONE PINT.	SPRING VALLEY DAIRY. ONE QT. MILK MIDDLETON, N. Y.	ONE PINT.

Coupon Ticket.

used, an account is rendered at the end of the month similar to that rendered by the grocer.

Route Book. It is evident that if customers were always supplied with tickets and regularly paid for each delivery of milk or cream, no further record would be necessary. But customers will run out of tickets occasionally as well as forget to regularly hand them out, hence it is necessary for drivers to carry with them a record or route book in which each transaction is recorded at the time it is made. A form suitable for this purpose is shown below.

JANUARY, 1906.	<i>Adamson, C. F.</i>								<i>Anson, C. R.</i>									
	CASE PAID.	MILK		CREAM		B. M.		BOTTLES.		CASE PAID.	MILK		CREAM		B. M.		BOTTLES.	
		QUARTS	TICKETS	PINTS	TICKETS	QUARTS	TICKETS	DELIVERED	RETURNED		QUARTS	TICKETS	PINTS	TICKETS	QUARTS	TICKETS	DELIVERED	RETURNED
1																		
2																		
3																		

Form of Route Book.

The route book consists of loose leaves, upon which the names of customers are arranged alphabetically. The leaves are renewed each month, the old one being placed on file for future reference. The letters B. M. stand for buttermilk.

Ledger. As a rule all accounts are settled monthly. The ledger form shown below serves satisfactorily as a permanent monthly record.

On the debit side are recorded the sales and the total value of the tickets purchased. On the credit side are

recorded all the receipts for the same period. The *balance* represents the difference between the debits and credits.

Dr.					<i>John Smith</i>					Cr.				
DATE 1908.	CASH.	TICKETS.			BOTTLES.	DATE 1908	CASH.	TICKETS.			BOTTLES.			
		MILK.	CREAM.	BUTTER- MILK.				MILK.	CREAM.	BUTTER- MILK.				
JAN 1-31	8.00	30	10	10	50	JAN 1-31	6.00	25	10	8	46			
						BAL. JAN 31	2.00	5	0	2	4			
BAL. FEB. 1	2.00	5	0	2	4									
FEB. 1-29														

Form of Ledger.

Monthly Statement. At the end of each month a statement should be rendered to customers showing their indebtedness. A form like that herewith shown answers the purpose satisfactorily.

SPRINGDALE SANITARY DAIRY,

J. C. BOONE, Proprietor

REIDSVILLE, N. H. *Feb 1* 1908*Mr. John Smith*

TO SPRINGDALE SANITARY DAIRY, DR.

J. C. BOONE, Proprietor

	<i>Balance Feb. 1</i>	<i>2</i>	<i>50</i>		
<i>Feb. 1-28</i>	<i>40 quarts milk @ 8</i>	<i>3</i>	<i>90</i>		
"	<i>11 pints Cream @ 20</i>	<i>2</i>	<i>20</i>		
"	<i>5 quarts Buttermilk @ 5</i>	<i>25</i>		<i>8</i>	<i>15</i>
"	<i>By cash</i>			<i>6</i>	<i>00</i>
	<i>no. of unreturned bottles 8</i>			<i>2</i>	<i>15</i>

Monthly Statement.

THE WAUCOSTA DAIRY CO.

174 PINE STREET.

Pasteurized milk and cream, buttermilk, cottage cheese, cultured milk and butter.

Account for JUNE 1912.

Name

Address

Date	Milk		Cream		B. M.	Cheese	C. Milk		Butter	Cash Paid
	Qts.	Pts.	$\frac{1}{2}$ Pt.	Pt.	Qts.	Lbs.	Qts.	Pts.	Lbs.	
1
2
3
4
5
6
7
8
9
10
11
12
13
14
15
16
17
18
19
20
21
22
23
24
25
26
27
28
29
30
31
Ttl

NOTE: This card is your property and all orders must be placed thereon and card put where driver can see it. Do not pay driver unless he signs this card.

CHAPTER XXX.

CONTROL OF CITY MILK SUPPLY.

The need of safe-guarding the milk supply of towns and cities becomes evident when we consider the extent to which milk acts as a carrier of infectious diseases. During the past twenty years, more than one hundred and fifty epidemics of typhoid fever have been traced to milk infected with the typhoid bacillus. There are records of twenty-eight epidemics of diphtheria and eighty or more of scarlet fever.

Besides these epidemics, it is difficult to estimate how many thousands of isolated cases of these and various other diseases have been caused by infected market milk. The prevalence of tuberculosis among dairy cattle, alone, calls for a rigid control of city milk supplies. As stated elsewhere in this chapter, a large percentage of market milk contains the tubercule organism, and that the bovine tubercle bacillus can and does produce tuberculosis in man has been established beyond a doubt by the Royal Commission on Human and Animal Tuberculosis and by other notable scientific bodies and individuals.

In addition to the danger of infection with strictly pathogenic bacteria, milk produced and handled under uncleanly conditions contains organisms which, while not classed with the pathogenic kinds, are nevertheless the cause of a high mortality among children under two years of age. These organisms come from manure

and filth and are largely responsible for the diarrhœa, summer complaint or general gastro-intestinal diseases so common among infants and young children subsisting on cow's milk.

Importance of Cleanliness. Milk furnishes an ideal medium for the development of a large variety of bacteria and for this reason, when improperly handled, it is possible for many of the organisms which gain entrance into it, to multiply thousands and even millions of times before the milk finally reaches the consumer's table.

Another reason why extreme cleanliness should be practiced with milk is the fact that possibly no other food is naturally exposed to so many contaminating influences as is milk in its production. If water should be squeezed by unclean hands from unclean cows confined in unclean stables, with particles of dirt and manure dropping into it in the process, it is certain that even the least fastidious persons would refuse to drink it. Yet thousands are daily consuming milk produced under such conditions, apparently oblivious of the filth and bacteria contained in it. Two reasons may be given for this apparent indifference towards milk on the part of a large percentage of consumers: (1) the general ignorance regarding bacteria and the part they play in milk; (2) the opaque color of milk which obscures the bulk of the dirt contained in it.

To improve the quality of milk supplied to towns and cities, it is necessary to exercise a reasonable control over it, both at the farms as well as in the city where it is consumed. Most cities now have a well organized system of milk inspection and great improvement in the composition and in the sanitary conditions surrounding

the production and handling of milk may be looked for in the near future.

Inspection at the Farm. The past few years has witnessed a remarkable progress in general dairy inspection which has largely come about through the employment of better qualified inspectors and the realization by the inspectors that their work must be largely of an educational character.

Real effective milk inspection must begin at the farm. The cows must be examined to see that none are diseased; attention must be given to the stables to see that they are kept clean and that they admit sufficient sunlight and air to make them sanitary; the purity of the well water must be ascertained; outhouses must be of sanitary construction and removed a reasonable distance; suitable cleaning and sterilizing facilities should be available; the health of those entrusted with the milking and handling of the milk should be above suspicion; and in this way a hundred different matters need to be looked after. It is to be hoped, therefore, that cities will not only provide inspection within the city limits, but will have the greatest force of inspectors in the country where the milk is produced.

In this connection it is suggested that an important qualification of the "country" inspector should be a good practical knowledge of herd management and barn construction. Expensive equipment is not necessary to produce pure milk and inspectors that lack the practical knowledge to suggest changes within the limits of the farmer's pocketbook, are sure to fail in their mission of inspection. Stress is laid upon this point because there are hosts of inspectors who have good chemical and bacteriological training along milk lines, but who lack

a working knowledge along the lines suggested.

Another matter for milk inspectors to remember is the fact that all unsanitary conditions are not necessarily the result of willful neglect or transgression. They may be the result of ignorance. In this connection it should be remembered that dairy inspection is a comparatively new matter and the ideals of many of the inspectors and framers of health regulations can be attained only after months of patient education. Bacteriology itself is a comparatively new science and it is, therefore, not so remarkable that there should be so much ignorance regarding bacteria and sanitation in general.

A score card for judging dairy farms will be found in the appendix.

Tuberculosis and Tuberculin Testing. Undoubtedly one of the most pressing problems confronting the city milk trade is the matter of obtaining milk from tuberculin tested cows. Numerous cities throughout the country have endeavored in the past, or are endeavoring at the present time, to pass and enforce ordinances requiring all milk to come from herds which the tuberculin test has shown to be free from tuberculosis. The opposition to such ordinances by milk producers is sometimes extremely fierce, as recently experienced by the city of Milwaukee. The producers objected to the ordinance requiring cows to be tested for tuberculosis, maintaining that the tuberculin test was not reliable. The matter was finally carried to the supreme court, but the courts affirmed the reliability of the tuberculin test in every case.

The Tuberculin Test. The usefulness of this test as a diagnostic agent rests upon the fact that when a substance called "tuberculin" is injected under the skin of an animal, the injection is followed by a rise of tempera-

ture in infected animals, while in those unaffected the temperature remains the same. It must be added, however, that in the last stages of the disease, tuberculin fails as a diagnostic agent, but this is of little consequence since the disease is readily recognized in these stages by a physical examination.

The tuberculin test should not be applied to cows in heat or shortly before and after calving; neither may reliable results be expected with cows suffering from garget or other diseases. A period of at least 60 days should elapse before a retest is made for tuberculosis.

In regard to the reliability of the test, there is plenty of evidence to show that when the testing is done by competent persons the test is almost infallible. In California, for instance, 817 out of 9,618 head tested reacted and 817 upon post-mortem examination showed tuberculosis. The accuracy of the test in this case was 100%. In Massachusetts 86,223 were tested, and of the 10,760 that reacted, 99.34% showed tuberculosis. In Wisconsin, out of 408,000 tested, 24,784 were killed and 98.39% of these showed tuberculosis. We might go on this way indefinitely showing figures bearing upon the accuracy of the tuberculin test, and it is such figures that milk producers should be thoroughly acquainted with before being asked to submit their cows to the test.

Regarding the efficiency with which the tuberculin testing is done, it cannot be denied that there is often occasion for criticism. The testing should be done by experienced men who have shown proficiency in this always prima facie evidence that the work is being con- line. The fact that the tester is a veterinarian is not ducted satisfactorily. We have many men that style themselves veterinarians who are nothing more nor less

than "quacks," and when the testing is done by such men there is bound to be trouble. Efforts should be made to secure well-known, competent men to do the testing and to lay the qualifications of such men before the herd owners.

Farmers Benefited by Tuberculin Test. There is one thing that should be strongly emphasized in the matter of getting milk producers to test their cows for tuberculosis, and that is the need of healthy cows in conducting a profitable dairy business. Entirely aside from the health consideration so far as they affect consumers of milk, it is an imperative matter for milk producers to eliminate tuberculosis from their herds to insure a profitable business. Tubercular cows are sick cows, and it is folly to expect the best results from sick cows. If milk producers would fully understand the detriment to their business from keeping tubercular cows, it would not be necessary for city ordinances to compel them to cull out their infected animals. There is not a first-class dairyman in the country today who is willing to conduct a dairy business without assuring himself that his herd is free from tuberculosis. This phase of tuberculin testing should be properly stressed when asking dairy-men to comply with city ordinances affecting the health of cows

Greater co-operation in tuberculin testing can undoubtedly be obtained by refraining from forcing this test upon the farmers until they have had a reasonable opportunity to become acquainted with the efficiency and value of tuberculin testing. Education is needed here just as along general sanitary lines, and this should precede the enactment of stringent city ordinances.

Presence of Tubercle Bacilli in Milk. That tuber-

cle bacilli are frequently found in milk is abundantly shown by actual statistics.

Some years ago an investigation was made of the milk supply of the city of Washington by the Hygienic Laboratory, Public Health and Marine Hospital Service, Washington, D. C. This investigation disclosed the fact that approximately 11% of the milk of 100 or more dairies investigated contained tubercle bacilli. Out of 1287 samples of milk collected in fourteen European cities, including London, Liverpool, Paris, St. Petersburg, Berlin and Copenhagen, 144, or 11.2%, contained tubercle bacilli.

Bacterial Counts. One of the common aids employed in determining the purity of milk is to count the number of bacteria contained in it. In general there is a fair relation between the number of bacteria and the purity of the milk, and when the bacteria count is supplemented with an inspection of the conditions under which the milk is produced and handled it has considerable value. On the other hand, we should not forget that a bacterial count alone is likely to lead to very erroneous conclusions regarding the wholesomeness of milk. To illustrate, let us compare two milks produced under identical conditions as to cleanliness. If one of the milks has been promptly cooled to 45° F. and kept at this temperature it may contain only 5000 bacteria per c. c. while the other sample, if poorly cooled, may contain 1,000,000 per c. c. The higher temperature has given the bacteria in the latter sample an opportunity for rapid development while the temperature (45° F.) of the former sample has checked the growth of the bacteria contained in it. If the milks were produced under cleanly conditions, the increase in the number of bacteria in

the sample kept at the higher temperature will be largely of the lactic kind and may be practically as wholesome as the sample containing only 5,000 bacteria per c. c.

From the standpoint of safety, it is of far greater consequence to know the *kind* of bacteria present in milk than to know the actual *numbers*. For example, a sample of milk may be produced under the strictest hygienic conditions, but if not properly cooled may show ten million bacteria per c. c. On the other hand, another sample of milk may be produced from diseased cows under filthy condition, if thoroughly cooled immediately after milking may contain less than ten million bacteria per c. c.

Where bacterial counts have their greatest value in determining the purity of the milk is when the number of bacteria does not exceed 20,000 per c. c. Only under clean conditions can milk be obtained containing less than 20,000 bacteria per c. c. when delivered to consumers.

Composition of Milk and Cream. Standards for milk, cream and ice cream are now found in most states and in the larger cities of the country. These standards, in the case of milk, call for a minimum per cent of fat, solids not fat and total solids; in cream and ice cream, as a rule, only a minimum per cent of fat is considered. The total solids are obtained by adding the fat and solids not fat, and where there are standards for the latter two, no standard for total solids is needed.

The minimum per cent of fat in milk called for by the standards varies from 2.5 to 3.7; for solids not fat the minimum varies from 8 to 9.5 per cent, while the minimum for total solids varies from 11 to 13 per cent. The minimum limit for fat in cream ranges from 15 to

20 per cent; for ice cream, from 8 to 16 per cent.

Consumers have hitherto been too indifferent regarding the composition of the milk they buy; they have failed properly to consider milk from the standpoint of a food. In most cities there is a wide variation in the composition of milk sold by different dealers, and often the highest priced milk will be found the cheapest when considered from a food standpoint. A quart of milk containing 5.5 per cent fat is worth fully 50 per cent more than one containing only three per cent.

When compared with other foods, such as meat and cheese, milk at prevailing prices is a cheap food. Milk dealers should impress this fact upon their patrons. Those who sell a good quality of milk will find it profitable to stamp the per cent of fat on the bottle cap.

City milk authorities should encourage the quality basis of handling milk as much as possible, because it will promote justice and honesty. The subject of buying and selling milk on the butter fat basis is discussed in chapter XXVII.

Sterile Milk Vessels. Much disease is disseminated through unsterile milk bottles. Every milk dealer's bottles at one time or another reach homes where there are persons affected with some contagious disease, and bottles will in many cases become infected with the disease producing organisms. A number of epidemics have been directly traced to unsterile milk bottles. In too many instances milk bottles are not sufficiently sterilized, and some milk dealers make no attempt whatever to have the bottles *sterile*; the main consideration with them is to have the bottles *clean*. The realization of the importance of having milk bottles sterile has started a movement to pasteurizing the milk in the bottles.

The matter of sterile milk bottles means a great deal to the health of milk consumers, and milk inspectors should see to it that this phase of inspection receives the necessary consideration. There is urgent need, too, of directing more attention to milk cans. A large percentage of milk shipping cans is entirely unfit for handling milk. Rusty and badly bruised cans should be condemned. Another matter that should be insisted upon is to have the cans washed and sterilized before returning them to the milk producers.

Pasteurization. A number of cities in the United States have deemed it wise to require the pasteurization of all milk coming from cows that are not known to be free from tuberculosis. If properly done, there is no question whatever that pasteurization of milk as it is now received in most cities, is a safe-guard to health. See chapter XII.

Temperature and Age Regulations. To hold milk in good condition until it reaches the consumer requires that it be kept at a low temperature. Many cities have passed regulations fixing a minimum temperature at which milk shall be transported and handled, and good results have followed such regulations.

Low temperatures, however, like many other good things, are often abused as in the case of ice cream manufacturers. Some hold ice cream weeks before it goes to the consumer, believing that no bacterial development takes place at storage temperatures. While cold materially retards the growth of all bacteria and completely stops that of many, there is probably no minimum temperature at which all bacterial development stops.

That there is abundant bacterial development in cream is conclusively shown in Bulletin 41, of the Hygienic

Laboratory, Public Health and Marine Hospital Service, Washington, D. C. In the investigations reported in this bulletin, samples of ice cream were purchased from ice cream dealers and stored at temperatures ranging from 0° to 10° above zero F. The initial bacterial count of the samples varied from 10,000,000 to 135,000,000 per c. c. As a rule, at the end of the third day of storage the bacteria had nearly doubled in number, but from that point on there was a gradual decrease so that on the 14th day the number was less than in the initial count. From the 14th day on the number increased again and so rapidly that on the 27th day of storage some of the samples showed eighteen times as many bacteria as were found in the initial count. In other experiments it was found that some samples showed marked bacterial growth at 5.8° below zero (F.).

It is usually the obnoxious kinds of bacteria that develop at low temperatures. The development of ptomaines is most frequently noticeable in milk or cream that have been kept at low temperatures a long time. The prolonged storage of milk, cream and ice cream at low temperatures should, therefore, be prohibited.

MILK ADULTERATIONS.

Watering and Skimming. Up to within recent years the chief duty of milk inspectors was to guard against watering and skimming of milk. Vigilance in this matter is still very necessary, though at present the efforts of inspectors is directed chiefly along sanitary lines.

In connection with the subject of watering and skimming, it should be remembered that most states require

that milk be sold as it comes from the cow; that is, it would be illegal to remove a part of the fat from milk, even if this would leave it above the minimum composition fixed by law.

The matter of detecting watering and skimming is discussed in chapter VIII.

Preservatives and Dirt. Preservatives are often found in market milk. Those most commonly used are, boracic acid, formalin, salicylic acid and carbonate of soda. The use of these preservatives materially prolongs the keeping quality of the milk owing to their antiseptic properties. Every effort should be made, however, to inflict maximum punishment upon users of preservatives because their poisonous nature makes them very detrimental to health.

So far as dirt is concerned, it cannot technically be classed as a milk adulterant, though in its effects it may be fully as detrimental to health as preservatives.

The presence of dirt in milk presupposes the presence of an undue number of dirt-loving bacteria which, at least so far as babies and young children are concerned, are perhaps just as detrimental to health as preservatives. Filthy milk has killed thousands of children under two years of age, and its use should be strictly prohibited.

The methods of determining preservatives and dirt in milk are discussed in Chapter XXV.

Bad Fermentations. It has already been stated that the *number* of bacteria in any given sample of milk is of less consequence than the *class* to which they belong. Filthy milk, if promptly and thoroughly cooled, may come within the numerical limit established for bacteria by any particular city, yet such milk may be extremely

unwholesome, because the preponderance of bacteria is of the undesirable kind. The character of such milk is easily detected by means of fermentation tests described in Chapter XXIV.

CHAPTER XXXI.

BUTTERMAKING.

This chapter will be discussed under three heads:

- Part I. Theory and Methods of Cream Ripening.
- Part II. The Control of the Ripening Process.
- Part III. Cream Acid Tests.

PART I.—THEORY AND METHODS OF CREAM RIPENING.

Cream ripening is a process of fermentation in which the lactic acid organisms play the chief role. In every-day language, cream ripening means the souring of the cream. So important is this process that the success or failure of the butter maker is largely determined by his ability to exercise the proper control over it. In common creamery practice the time consumed in the ripening of cream varies from six to twenty-four hours and includes all the changes which the cream undergoes from the time it leaves the separator to the time it enters the churn.

Object. The ripening of cream has for its prime object the development of flavor and aroma in butter, two qualities usually expressed by the word flavor. In addition to this, cream ripening has several minor purposes, namely: (1) renders cream more easily churnable; (2) obviates difficulties from frothing or foaming in churning; (3) permits a higher churning temperature; (4) increases the keeping quality of butter.

Flavor. This, so far as known at the present time,

is the result of the development of the lactic fermentation. If other fermentations aid in the production of this important quality of butter, they must be looked upon as secondary. In practice the degree or intensity of flavor is easily controlled by governing the formation of lactic acid. That is, the flavor develops gradually with the increase in the acidity of the cream. Sweet cream butter for example is almost entirely devoid of flavor, while cream with an average richness possesses the maximum amount of good flavor possible when the acidity has reached .6%.

Exhaustive experiments conducted by the author (See Rept. Wis. Exp. Sta., 1905) show that the desirable butter flavor develops in the milk serum (skimmilk) and is absorbed from this by the butterfat. Such absorption may take place either during the ordinary course of cream ripening, or during the process of churning as would be the case when well ripened skimmilk (starter) is added to sweet cream and the mixture churned immediately. This explains why in creamery practice such good results have been obtained by churning sweet cream immediately after the addition of a large amount of well ripened starter.

Churnability. Practical experience shows that sour cream is more easily churnable than sweet cream. This is explained by the fact that the development of acid in cream tends to diminish its viscosity. The concussion produced in churning causes the little microscopic fat globules to flow together and coalesce, ultimately forming the small granules of butter visible in the churn. A high viscosity impedes the movement of these globules. It is

evident, therefore, that anything that reduces the viscosity of cream, will facilitate the churning.

As a rule, too, the greater the churnability of cream the smaller the loss of fat in the buttermilk.

Frothing. Experience shows that ripened cream is less subject to frothing or foaming than unripened. This is probably due to the reduced viscosity of ripened cream and the consequent greater churnability of same.

Temperature. Sour cream can be churned at higher temperatures than sweet cream with less loss of fat in the buttermilk. This is of great practical importance since it would be difficult, if not impossible, for most creameries to get low enough temperatures for the successful churning of sweet cream. Indeed, many creameries fail to get a low enough churning temperature for ripened cream.

Keeping Quality. It has been found that butter with the best keeping quality is obtained from well ripened cream. It is true, however, that butter made from cream that has been ripened a little too far will possess very poor keeping quality. An acidity of .5% should be placed as the limit when good keeping quality is desired.

METHODS OF CREAM RIPENING.

There are three ways in which cream is ripened at the present time:

1. By the unaided development of the lactic fermentation called *natural ripening*.
2. By first destroying the bulk of the bacteria in cream by heat and then inoculating same with cultures of lactic acid bacteria. This method is known as *pasteurized cream ripening*.

3. By the aided development of the lactic fermentation called *starter ripening*.

I. NATURAL RIPENING.

By this is meant the natural souring of the cream. In this method no attempt is made to repress the abnormal fermentations or to assist in the development of the lactic. From the chapter on Milk Fermentations we have learned that milk normally contains a number of different kinds of germs, frequently as many as a dozen or more. Naturally, therefore, where this method of ripening is practiced, a number of fermentations must go on simultaneously and the flavor of the butter is impaired to the extent to which the abnormal fermentations have developed. If the cream is clean and uncontaminated the lactic fermentation greatly predominates and the resulting flavor is good. If, on the other hand, the cream happens to contain many bad germs the probability is that the abnormal ferments will predominate and the flavor of the butter will be badly "off."

Where cream is therefore allowed to take its own course in ripening the quality of the butter is a great uncertainty. This method, though still practiced by many butter makers, is to be condemned as obsolete and unsatisfactory.

2. PASTEURIZED CREAM RIPENING.

Theoretically and practically the ideal way of making butter is to pasteurize the cream, a process which consists in heating cream momentarily to a temperature of 160° to 185° F. and then quickly cooling to 60° F. In this manner most of the bacteria in the cream are destroyed. After this treatment the cream is heavily inoculated with the lactic acid bacteria, and the lactic fermentation is given

a favorable temperature for development. When cream is treated in this way the lactic fermentation is practically the only one present and a butter with the desirable flavor and aroma is the result. It is the only way in which a uniform quality of butter can be secured from day to day.

This system of cream ripening is almost universally followed in Denmark, whose butter is recognized in all the world's markets as possessing qualities of superior excellence. The method is also gradually gaining favor in America and its general adoption can only be a matter of time. In the chapter on Cream Pasteurization this method is discussed in detail.

3. STARTER RIPENING.

This method of ripening consists in adding "starters," or carefully selected sour milk, to the cream after it leaves the separator. A full discussion of starters will be found in the following chapter.

In America this is at present the most popular method of cream ripening. While it does not, and can not, give the uniformly good results obtained by pasteurizing the cream, it is far superior to natural or unaided ripening.

When we have a substance which contains many kinds of bacteria, there naturally follows a struggle for existence and the fittest of the species will predominate.

We always have a number of different types of bacteria in cream, both desirable and undesirable. The latter can be held in check by making the conditions as favorable as possible for the former. Fortunately, when milk is properly cared for the lactic acid germs always predominate. But where milk is received at the creamery from 30 to 200 patrons, undesirable germs are frequently present in such large numbers as to seriously endanger

the growth of the lactic acid bacteria. However, when a large amount of starter containing only lactic acid germs is added to the cream from such milk these organisms are certain to predominate.

The best results with the starter method are secured when the milk is received at the creamery in a sweet condition and when a large amount of starter is used. Generally when milk is received in a sweet condition, especially during the summer months, it indicates that it has been thoroughly cooled and that the germs are present only in small numbers. When the cream from such milk is heavily inoculated with lactic acid germs by adding a starter, the development of the lactic fermentation is so rapid as to either check or entirely suppress the action of undesirable bacteria that may be present in the cream.

PART II.—THE CONTROL OF THE RIPENING PROCESS.

In Part I an attempt was made to convey some idea as to our present theory and methods of cream ripening. We learned that the highly desirable flavor and aroma of butter are produced by the development of the lactic fermentation. In the following discussion we shall take up the means of controlling this fermentation and treat of the more mechanical side of cream ripening. This will include: 1. The time the starter should be added to the cream; 2. The amount of starter to be added; 3. The ripening temperature; 4. Time in ripening; 5. Agitation of cream during ripening; 6. Means of controlling temperature.

1. The value of a starter in cream ripening has already been made evident in the discussion of the theory of cream ripening. To secure the maximum effect of a starter it should be added to the cream vat soon after the separation

of the milk has begun but not until the cream has reached a temperature of 70° F. The cream thus coming in contact with the starter as it leaves the separator insures a vigorous development of the starter germs, so that by the time the separation is completed, the starter fermentation is almost certain to predominate, especially when a large amount of starter is used.

2. The maximum amount of starter that may be consistently used is one pound to two pounds of cream. A larger amount than this would be liable to result in too thin a cream. Experience teaches us that the maximum richness of cream permissible in clean skimming under average conditions is 50%. Adding one pound of starter to two pounds of such cream would give us a 33 1-3 % cream, the ideal richness for churning. But this amount of starter is rarely permissible on account of the poor facilities for controlling the temperature of the cream.

3. Since the lactic acid bacteria develop best at a temperature of 90° to 98° F. it would seem desirable to ripen cream at these temperatures. But this is not practicable because of the unfavorable effect of high temperatures on the body of the cream and the butter. Good butter can be produced, however, under a wide range of ripening temperatures. The limits may be placed at 60° and 80° . Temperatures below 60° are too unfavorable for the development of the lactic acid bacteria. Any check upon the growth of these germs increases the chances for the development of other kinds of bacteria. But it may be added that when cream has reached an acidity of .4% or more, the ripening may be finished at a temperature between 55° and 60° with good results. In general practice a temperature between 60° and 70° gives

the best results. This means that the main portion of the ripening is done at this temperature. The ripening is always finished at temperatures lower than this.

4. As a rule quick ripening gives better results than slow. The reason for this is evident. Quick ripening means a rapid development of the lactic fermentation and, therefore, a relatively slow development of other fermentations. Practical experience shows us that the growth of the undesirable germs is slow in proportion as that of the lactic is rapid. For instance, when we attempt to ripen cream at 55° F., a temperature unfavorable for the growth of the lactic acid bacteria, a more or less bitter flavor is always the result. This is so because the bitter germs develop better at low temperatures than the lactic acid bacteria.

The main portion of the ripening should be done in about six hours. After this the temperature should be gradually reduced to a point at which the cream will not overripen before churning.

5. It is very essential in cream ripening to agitate the cream frequently to insure uniform ripening. When cream remains undisturbed for some time the fat rises in the same way that it does in milk, though in a less marked degree. The result is that the upper layers are richer than the lower and will sour less rapidly, since the action of the lactic acid germs is greater in thin than in rich cream.

This uneven ripening leads to a poor bodied cream. Instead of being smooth and glossy, it will appear coarse and curdy when poured from a dipper. The importance of stirring frequently during ripening should therefore not be underestimated.

6. The subject of cream cooling is a very important

one and will be discussed under the head of cream ripeners.

CREAM RIPENERS.

During the summer months much butter of inferior quality is made by overripening the cream and churning at too high a temperature. This is due chiefly to a lack of proper cooling facilities. With the open cream vats the control of temperature is a difficult thing. Fortunately these vats have been largely replaced by the more modern cream ripeners. These ripeners possess two important advantages over the open vats, namely: first, they permit a more rapid cooling by agitating the cream while cooling; second, they maintain a more uniform temperature because of tight fitting covers and better all round construction.

There are a number of different makes of ripeners on the market that are giving good satisfaction.

Since some of these ripeners are so constructed as to render the addition of ice to the water in them impossible, they can not therefore be considered complete without an ice water attachment. In Fig. 53 an ice water tank may be seen attached to the ripener.

Tank A contains ice water which is kept circulating through the ripener by means of pump B. By using the water over and over again, only a very small quantity of ice is required in cooling cream to the desired temperature. When the great cooling power of ice is once fully understood it is easy to see what a great amount of cooling a small quantity of ice will do. One pound of ice in melting will give out 142 times as much cold as one pound of water raised from 32° to 33° F. In other

words, the cooling power of ice is 142 times as great as that of water.

With uniced water, a low temperature is not possible. On warm days the ripener may be run during the greater

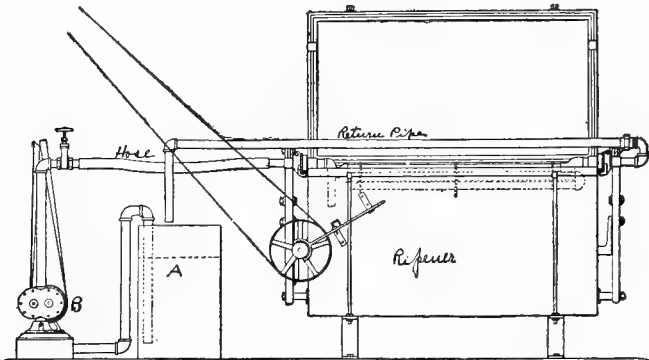

Fig. 53.—Showing method of circulating ice water through ripener.

part of the day without reducing the temperature below 56° F., and this too when the water is pumped directly from the well into the ripener. It is rarely possible to obtain a lower temperature than this with water that has a temperature of 51° to 52° F. as it enters the ripener.

When we compare the quick cooling with iced water and the slow and inadequate cooling with uniced water, it is easily seen that the saving in fuel and wear and tear of machinery will more than cover the cost of the ice. Moreover, quick cooling has a very important advantage in cream ripening. It permits the use of a large amount of starter which is not possible where good cooling facilities are not at hand. Using iced water makes it possible to have cream with the same degree of acidity 365 days in the year, and it is believed that the general

use of the improved cream ripeners and ice water attachments will result in a great improvement in both the quality and uniformity of butter and do away with the dangerous practice of adding ice directly to the cream.

CHURNING.

Under the physical properties of butter fat it was mentioned that this fat existed in milk in the form of extremely minute globules, numbering about 100,000,000 per drop of milk. In rich cream this number is increased at least a dozen times owing to the concentration of the fat globules during the separation of the milk.

So long as milk and cream remain undisturbed, the fat remains in this finely divided state without any tendency whatever to flow together. This tendency of the globules to remain separate was formerly ascribed to the supposed presence of a membrane around each globule. Later researches, however, have proven the falsity of this theory and we know now that this condition of the fat is due to the surface tension of the globules and to the dense layer of casein that surrounds them.

Any disturbance great enough to cause the globules to break through this caseous layer and overcome their surface tension will cause them to unite or coalesce, a process which we call *churning*. In the churning of cream this process of coalescing continues until the fat globules have united into masses visible in the churn as butter granules.

CONDITIONS THAT INFLUENCE CHURNING.

There are a number of conditions that have an important bearing upon the process of churning. These may be enumerated as follows:

1. Temperature.
2. Character of butter fat.
3. Acidity of cream.
4. Richness of cream.
5. Amount of cream in churn.
6. Speed of churn.
7. Abnormal fermentations.

1. Temperature. To have the microscopic globules unite in churning they must have a certain degree of softness or fluidity which is greater the higher the temperature. Hence the higher the temperature, within certain limits, the quicker the churning. To secure the best results the temperature must be such as to churn the cream in from thirty to forty-five minutes. This is brought about in different creams at quite different temperatures.

The temperature at which cream must be churned is determined primarily by the character of the butter fat and partly also by the acidity and richness of the cream.

Rule for Churning Temperature. A good rule to follow with regard to temperature is this: When the cream enters the churn with a richness of 30 to 35 per cent and an acidity of .5 to .6 per cent, the temperature should be such that the cream will churn in from thirty to forty-five minutes. This will insure an exhaustive churning and leave the butter in a condition in which it can be handled without injuring its texture. Moreover, the buttermilk can then be easily removed so that when a plug is taken with a trier the day after it is churned the brine on it will be perfectly clear.

2. Character of Butter Fat. The fat globules in cream from different sources and at different times have the proper fluidity to unite at quite different temperatures.

This is so because of the differences in the relative amount of "soft" and "hard" fats of which butter fat is composed. When the hard fats largely predominate the butter fat will of course have a high melting point. Such fat may be quite hard at a temperature of 60° while a butter fat of a low melting point would be comparatively soft at this temperature. For a study of the conditions that influence the hardness of butter fat the reader is referred to the discussion of the "insoluble fats" treated in the chapter on milk.

3. Acidity of Cream. This has a marked influence on the churning process. Sour or ripened cream churns with much greater ease than sweet cream because the acid renders it less viscous. The ease with which the fat globules travel in cream becomes greater the less the viscosity. Ripe cream will therefore always churn more quickly than sweet cream. Ripe cream also permits of a higher churning temperature than sweet which is of great practical importance where it is difficult to secure low churning temperatures.

4. Richness of Cream. It may naturally be inferred that the closer the fat globules are together the more quickly they will unite with the same amount of concussion. In rich cream the globules are very close together which renders it more easily churnable than thin cream. The former can therefore be churned in the same length of time at a lower temperature than the latter.

The ideal richness lies between 30% and 35%. A cream much richer than this will stick to the sides of the churn which reduces the amount of concussion. The addition of water to the churn will overcome this stickiness and cause the butter to come in a reasonable length of

time. It is better, however, to avoid an excessive richness when an exhaustive churning is to be expected.

5. Amount of Cream in Churn. The best and quickest churning is secured when the churn is one-third full. With more or less cream than this the amount of concussion is reduced and the length of time in churning correspondingly increased.

6. Speed of Churn. The speed of the churn should be such as to produce the greatest possible agitation or concussion of the cream. Too high or too low a speed reduces the amount of concussion. The proper speed for each particular churn must be determined by experiment.

7. Abnormal Fermentations. The slimy or ropy fermentation sometimes causes trouble in churning by rendering the cream excessively viscous. Cream from single herds may become so viscous as to render churning impossible. At creameries where milk is received from many herds very little trouble is experienced from these fermentations.

CHURNS.

A churn is a machine in which the cream is made to slide or drop, or is in some way agitated to bring about the union of the fat globules, which changes the liquid fat into a solid. For many years the factory churns had assumed the form of a box or barrel free from any inside fixtures. Such churns were revolved by power and did very satisfactory work. But it was necessary to transfer the butter, after it was churned, to a worker upon which it was worked.

This transfer from one piece of apparatus to another was obviated by the invention of "combined" churns and

workers placed upon the market about two decades ago. These are provided with rollers inside, which remain stationary during churning, but can be made to revolve when it is desired to work the butter.

The combined churns have to a great extent replaced the old box and barrel styles because of the many advantages they possess over the latter. The principal advantages may be stated as follows:

1. They occupy less space.
2. Require less belting and fewer pulleys.
3. The churn can be kept closed while working which keeps the warm air and flies out during the summer.
4. The butter can be made with considerably less labor.

A few disadvantages might be mentioned such as the greater original cost and the greater difficulty of cleaning and salting. But with proper care the butter may be evenly salted and the churns kept clean.

For small dairymen there are no better churns than the barrel churns. They are simple, cheap, and answer every requirement for a satisfactory churning of cream, but dairymen who have 50 or more cows will find the dairy size combined churn and worker an advantage. What dairymen should strictly avoid in the way of churns is the so-called one-minute churns and other rapid churning devices.

CHURNING OPERATIONS.

Preparing the Churn. Before adding the cream, the churn should be scalded with hot water and then thoroughly rinsed with cold water. This will "freshen"

the churn and fill the pores of the wood with water so that the cream and butter will not stick.

Straining Cream. All cream should be carefully strained into the churn. This removes the possibility of white specks in butter which usually consist of curd or dried particles of cream.

Adding the Color. The amount of color to be added depends upon the kind of cream, the season of the year, and the market demands.

Jersey or Guernsey cream requires much less color than Holstein because it contains more natural color.

During the summer when the cows are feeding on pastures the amount of color needed may be less than half that required in the winter when the cows are feeding on dry feed.

Different markets demand different shades of color. The butter must therefore be colored to suit the market to which it is shipped.

In the winter time about one ounce of color is required per one hundred pounds of butter. During the summer less than one-half ounce is usually sufficient.

In case the color is not added to the cream (through an oversight) it may be added to the butter at the time of working by thoroughly mixing it with the salt. When the colored salt has been evenly distributed through the butter the color will also be uniform throughout.

Kinds of Color. There are two classes of butter color found upon the market. One is a vegetable color having its origin in the annatta and other plants, the other is a mineral color, a product of coal tar. Both are entirely satisfactory so far as they impart to butter a desirable color. But from a sanitary standpoint the vegetable color

seems to be preferred and this is the color now used in creameries.

Gas in Churn. During the first five minutes of churning the vent of the churn should be opened occasionally to relieve the pressure developed inside. This pressure according to Babcock "is chiefly due to the air within becoming saturated with moisture and not to gas set free from the cream."

Size of Granules. Butter should be churned until the granules are about half the size of a pea. When larger than this it is more difficult to remove the buttermilk and distribute the salt. When smaller, some of the fine grains are liable to pass out with the buttermilk, and the percentage of water in the butter is reduced. When the granules have reached the right size, cold water should be added to the churn to cause the butter to float. Salt will answer the same purpose. The churn is now given two or three revolutions and the buttermilk drawn off.

Washing Butter. One washing in which as much water is used as there was cream is usually sufficient. When butter churns very soft two washings may be advantageous. Too much washing is dangerous, however, as it removes the delicate flavor of the butter.

Too much emphasis cannot be laid upon the importance of using clean, pure water for washing. Experiments conducted at various experiment stations have shown that impure water seriously affects the flavor of butter. When the water is not perfectly pure it should be filtered or pasteurized.

SALTING.

It is needless to say that nothing but the best grades of salt should be used in butter. This means salt readily

soluble in water and free from impurities. If there is much foreign matter in salt, it will leave a turbid appearance and a slight sediment when dissolved in a tumbler of clear water.

Rate of Salt. The rate at which butter should be salted, other conditions the same, is dependent upon market demands. Some markets like Boston require much salt in butter while some buyers in the New York market require scarcely any. The butter maker must cater to the markets with regard to the amount of salt to use as he does with regard to color.

The rate of salt used does not necessarily determine the amount contained in butter. For instance it is perfectly possible under certain conditions to get a higher percentage of salt in butter by salting at the rate of one ounce per pound than is possible under other conditions by salting at the rate of one and a half ounces. This means that under some conditions of salting more salt is lost than under others.

The amount of salt retained in butter is dependent upon:

1. Amount of drainage before salting.
2. Fineness of butter granules.
3. Amount of butter in churn.

1. When the butter is salted before the wash water has had time to drain away, any extra amount of water remaining will wash out an extra amount of salt. It is good practice, however, to use a little extra salt and drain less before adding it as the salt will dissolve better under these conditions.

2. Small butter granules require more salt than large ones. The reason for this may be stated as follows: The surface of every butter granule is covered with a thin

film of water, and since the total surface of a pound of small granules is greater than that of a pound of larger ones, the amount of water retained on them is greater. Small granules have therefore the same effect as insufficient drainage, namely, washing out more salt.

3. Relatively less salt will stick to the churn in large churnings than in small, consequently less will be lost.

Standard Rate. The average amount of salt used in butter made in the combined churns comes close to one and a half ounces per pound of butter. But the rate demanded by different commission men may vary from no salt to two and a half ounces per pound of butter.

With the combined churns great care must be exercised to get the salt evenly distributed from one end of the churn to the other as it can not redistribute itself in the working.

Brine Salting. This consists in dissolving the salt in water and adding it to the butter in the form of a brine. This will usually insure an even distribution with less working since the salt is already dissolved. Where butter containing a high percentage of salt is demanded the method of brine salting is not practical, because it limits the amount that can be incorporated in butter.

Where there is difficulty in securing an even distribution of the salt without excessive working, an oversaturated brine may be used to advantage. Salt added to butter in this form very quickly dissolves and a butter with any degree of salt is possible.

But it is believed that where butter is drained little and a somewhat higher rate of salt is used, dry salting will never require overworking and will insure greater uniformity than is possible with brine salting.

Object of Salting. Salt adds flavor to butter and

materially increases its keeping quality. Very high salting, however, has a tendency to detract from the fine delicate aroma of butter while at the same time it tends to cover up slight defects in the flavor. As a rule a butter maker will find it to his advantage to be able to salt his butter rather high.

Salt an Absorbent. Salt very readily absorbs odors and must therefore be kept in clean, dry places where the air is pure. Too frequently it is stored in musty, damp store rooms where it will not only lump, but become impregnated with bad odors which seriously impair the quality of the butter.

WORKING BUTTER.

The chief object in working butter is to evenly incorporate the salt. Working also assists in expelling moisture.

After the wash water has sufficiently drained away, the salt is carefully distributed over the butter and the churn revolved a few times with the rollers stationary. This will aid in mixing the salt and butter. The rollers are then set in gear and the butter worked until the salt has been evenly distributed. To work butter twice reduces the water content, but is a safeguard against mottles.

How Much to Work. Butter is worked enough when the salt has been evenly distributed. Just when this point has been reached can not always be told from the appearance of the butter immediately after working. But after four or six hours standing the appearance of white streaks or mottles indicates that the butter has not been sufficiently worked. The rule to follow is to work the butter just enough to prevent the appearance of mottles

after standing about six hours. Just how much working this requires every butter maker must determine for himself, by experiment, for the reason that there are a number of conditions that influence the length of time that butter needs to be worked in a combined churn. These conditions are:

1. Amount of butter in the churn.
2. Temperature of the butter.
3. Time between workings.
4. Size of granules.
5. Solubility of salt.

1. When there is a moderately large amount of butter in the churn the working can be accomplished with fewer revolutions than with a small amount. Satisfactory working can not be secured, however, when the capacity of the churn is overtaxed.

2. Hard, cold butter is difficult to work because the particles will not knead together properly.

3. A moderately long time between workings allows the salt to dissolve and diffuse through the butter and hence reduces the amount of working.

4. Coarse or overchurned butter needs a great deal of working because of the greater difficulty of distributing the salt.

5. A salt that does not readily dissolve requires excessive working and is therefore productive of overworked butter. With such salt the brine method of salting is undoubtedly preferable.

DIFFICULT CHURNING.

The causes of trouble in churning may be enumerated as follows: (1) thin cream, (2) low temperature, (3) sweet cream, (4) high viscosity of cream, (5) churn too full, (6) too high or too low speed of churn, (7) colostrum milk, (8) advanced period of lactation, and (9) abnormally rich cream.

Foaming. This is usually due to churning a thin cream at too low a temperature, or to a high viscosity of the cream. When caused by these conditions foaming can usually be overcome by adding warm water to the churn. Foaming may also be caused by having the churn too full, in which case the cream should be divided and two churnings made instead of one.

CLEANING CHURNS.

After the butter has been removed, the churn should be washed, first with moderately hot water, next with boiling hot water containing a little alkali, and finally with hot water. If the final rinsing is done with cold water the churn dries too slowly, which is apt to give it a musty smell.

This daily washing should be supplemented once a week with a washing with lime water, which is prepared as follows: Gradually slake half a bushel of freshly burned lime by adding water to it at short intervals until about 150 pounds of water has been added. Stir the mixture once every half hour for several hours, after which allow it to remain undisturbed for about ten hours. This permits the undissolved material to settle. The clear liquid is now poured off and added to the churn, which is

slowly revolved for at least half an hour so that the lime water may thoroughly penetrate the pores of the wood.

Nothing is equal to the cleansing action of well prepared lime water and its frequent use will prevent the peculiar churn odor that is bound to develop in churns not so treated.

The outside of the churn should be thoroughly cleaned with moderately hot water containing a small amount of alkali.

Churning Cream Immediately After Adding the Starter. Where much hand separator cream is handled, it is usually received with varying amounts of acid, ranging in some cases from 0.15% to 0.8%. When the average acidity of the cream is such that when treated with a large amount of starter the mixture will show 0.5% acid or more, the cream should be churned as soon as the proper churning temperature can be secured. If, for example, the vat of cream shows 0.4% acid and the starter 0.7%, then one part of starter to two parts of cream would give an average acidity of 0.5%, the right amount for churning cream of moderate richness.

Pumping Cream into the Churn. Cream may be forced into the churn either by means of air pumps, sanitary milk and cream pumps, or with pumps working on the principle of an ordinary well pump.

The air pumps require air-tight cream ripeners for their successful operation. The air is pumped into the ripener to create sufficient pressure to force the cream into the churn. Forcing air into the ripener has the advantage of permitting the cream to be conducted to the churn through an open spout.

Pumps worked with a handle have the advantage of

enabling the buttermaker to put his cream into the churn in the morning before there is sufficient steam pressure to work pumps with the engine.

Fig. 54 shows a very satisfactory cream pump which

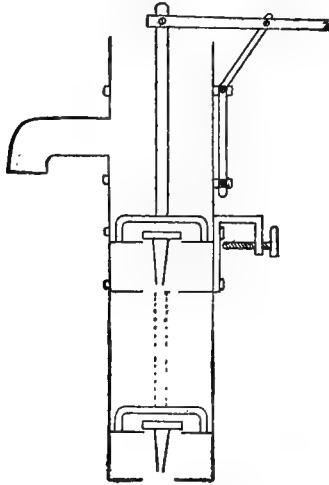

Fig. 54.—Cream pump.

can be made by any tinner. It simply consists of a heavy tin cylinder four inches in diameter which is provided with two brass valves having two inch openings. This pump is attached to the cream ripener and the cream pumped by hand into the churn through an open spout. Both valves can be removed so that there is not the slightest difficulty in cleaning the pump. Such a pump will readily pump 25 gallons of cream per minute.

CHAPTER XXXII.

MARKETING BUTTER AND CHEESE.

PACKING BUTTER.

Butter is usually in the best condition for packing immediately after it has been worked. It can then be packed solidly into the packages without the vigorous ramming necessary when the butter becomes too cold. When allowed to stand in the churn some time after working during the warm summer days, the butter will usually get too soft for satisfactory packing.

There is a great variety of packages in which butter may be packed for the markets. The bulk of the butter for home trade is packed in ash and spruce tubs, the former holding 20, 30, and 60 pounds, while the latter are made in 10, 20, 30, and 50 pound sizes.

Before adding the butter, the tubs must be thoroughly scrubbed inside and outside, the hoops carefully set, and then soaked in hot water for about half an hour. After this they are steamed for three minutes and then allowed to soak in cold water not less than four hours. The sides and bottom of the tubs are next lined with parchment paper which has been soaked in strong brine for twenty-four hours. See "paraffining tubs," page 265.

The wet liners are easily placed in the tubs by allowing them to project an inch and turning this over the edge.

The tubs are now weighed and the butter packed into

them directly from the churn, adding about five pounds at a time and firmly packing it with a wooden packer made for this purpose. The butter should be packed solid so that when stripped of its package on the retailer's counter no open spaces will appear in it.

When ash tubs are used they are packed brim full and trimmed off level with the tub by running a string across the top. The tubs are then weighed and the weights marked on the outside, allowing not less than half a pound for shrinkage for a sixty pound tub. A cheese cloth circle is next placed over the top and an oversaturated brine is pasted upon this. After careful cleaning place the covers on the tubs and fasten them with not less than three butter tub fasteners.

With spruce tubs the method of packing is the same with the exception that most markets require an even number of pounds in a tub, as 30 or 50 pounds. The tubs are, therefore, trimmed down till the required weight, plus half a pound for shrinkage, is reached. Some markets do not require the spruce tubs to be lined but it is always better to do so.

Prints. Considerable quantities of butter made in creameries are put up in one pound oblong blocks called *prints*. The prints are carefully wrapped in parchment paper which has been soaked in strong brine for twenty-four hours, and then packed in cheap wood boxes which usually hold about fifty of them. These boxes should be held not less than one day in a refrigerator before they are shipped. Print butter is growing in popularity.

Other packages. There are various other packages in which butter is packed, such as five pound crocks, gem

fibre paper boxes lined with parchment and holding 2, 3, 4, 5, and 10 pounds, and the wooden bail boxes holding from 5 to 10 pounds. Most of these packages are used for local trade.

Foreign Trade Packages. For export trade butter is preferably packed in cubical spruce boxes lined with paraffin and holding 56 pounds. These boxes are prepared by rinsing them with cold brine and then lining with parchment paper (double thickness at top and bottom) which has been soaked in brine. The boxes are now weighed and carefully packed, after which they are trimmed down to a weight of 57 pounds, which allows one pound for shrinkage. Finish the packing by placing a double thickness of parchment paper over the top and upon this oversaturated brine.

Butter shipped to tropical countries is packed in tin cans which are hermetically sealed.

Paraffining Butter Packages. During recent years buttermakers and butter dealers have suffered considerable losses from moldy butter caused by the growth of mold on the liners and on the inside of the tubs. These losses can easily be avoided by resorting to the proper methods of destroying the mold. Rogers of the United States Department of Agriculture has shown that this trouble can be prevented with certainty by coating the inside of the tub with a layer of paraffin. He says: "With paraffining not only are the molds and their spores already on the tub prevented from growing but the wood is covered with a surface from which molds

can not get nourishment. The wood is made impervious to water, and the space between the tub and the liner remains filled with water, so that the molds which may be on the liner can not get the supply of air necessary to their growth." He has also shown that loss from shrinkage is largely prevented in this way.

Testimonials from buttermakers indicate that the practice of paraffining tubs is giving good satisfaction and many have already adopted it as a permanent feature in creamery work.

To secure the best results from the paraffin, it should be applied at a temperature of about 240° F., immediately after steaming the tub. The steaming may or may not be preceded by soaking; under present conditions, however, soaking is recommended, if for no other reason than to give tubs their full weight. Butter dealers are accustomed to handle soaked tubs and where they are not soaked, the creamery is liable to lose an amount of butter equal to the difference between the weights of the soaked and unsoaked tubs.

Special machines are now upon the market for paraffining tubs. The paraffin may, however, be applied by pouring the same into the tub and rotating the latter until it is entirely coated. A brush may also be used for this purpose. Those who contemplate paraffining should investigate the merits of the machines now upon the market.

Printing Cold Butter. Until recently the common practice has been to print butter directly from the churn. With the advent of the "cold" butter printers or cutters, much butter is being printed outside the creameries, and the latter are also adopting the practice of cooling the butter before printing. Cold butter makes better looking prints,

injures the butter less, causes less water to be lost, facilitates the wrapping, and makes it easier to pack the butter.

The butter is preferably packed directly from the churn into square boxes of a size to fit the printer. Where butter is printed from tubs, there is too much butter left in irregular pieces, which are hard to repack and must be disposed of in bulk.

MARKETING CREAMERY BUTTER.

The producer of any commodity is always confronted with the problem of finding the best markets for his product. Indeed his success is measured more or less by his ability in handling this end of the business.

Buttermakers lose thousands and thousands of dollars every year because they do not fully understand how to manage the sale of their product. They fall into the clutches of men without credit or credentials who offer big prices but no returns. Swindlers are always on the lookout for victims and every year many buttermakers are entrapped by them. To the one who is just beginning to seek a market for his butter the following course of procedure is recommended.

1. Find the names of three or more leading reputable butter firms in the leading butter markets by inquiring of men from whom trustworthy information may be expected.

2. Divide a day's standard make among these butter firms and instruct each to send you statement as to the price they can give you net (f. o. b.) at your station for regular shipments, the price to be based on quotations of some leading market. Inform them further that you are ready and willing to comply with their demands as to color, package, and salt, in future shipments.

3. Ship your butter to the firm that offers you the best price, but do not deal with this firm exclusively. A tub should occasionally be sent to a new and reliable firm with a view to securing better prices.

4. Remember, however, that it requires time to establish a good trade for butter. Frequent changes from one firm to another are therefore undesirable.

5. Do not sell butter on commission, but ask for prices f. o. b. your station, based on some market quotation like New York, Chicago or Elgin.

6. Demand that payment shall be made for each shipment of butter within two weeks after it is sent out.

7. Never send a firm a third shipment until the first has been paid for.

8. Butter that is not up to the standard should be marked and the firm properly instructed regarding its disposition. An attempt to crowd in an inferior shipment may cost you your regular trade.

9. Do not feel hurt when criticisms come regarding defects in your butter but seek to overcome them.

10. Always allow one-half pound of butter for shrinkage on fifty and sixty pound tubs. If this allowance proves inadequate it indicates that the tubs have not been properly soaked or that the "house" is cutting you on weights.

11. Never contract butter for more than a year at a time.

How to Sell to Commission Houses. A common mistake in marketing butter is to sell it at prices based upon the score of the butter. This places the butter-maker at the mercy of the commission man who may, or may not, give an honest score. If he is not strictly honest he may easily place butter that would naturally grade as extras in the class of firsts, and butter

that would naturally grade as firsts in the class of seconds.

One of the best methods of selling butter to commission houses is as follows: Furnish the buyer enough samples of butter to give him a good idea as to the average quality of the butter produced by the creamery. An agreement can then be made as to the price the creamery shall receive for regular shipments, the price to be based upon some standard market quotation. If, for example, the buyer agrees that the quality of the butter merits one-half cent above Elgin, and the seller is satisfied with this price, future shipments shall be paid for at the rate of one-half cent above Elgin until such time as either party may become dissatisfied with the original agreement. If the butter maker feels that he is receiving a good price for his butter, he will do his best to maintain the standard of his product.

Selling to Retailers and Wholesalers. Wherever possible creameries should try to sell their butter direct to retailers and wholesale houses and in this way save the commission man's profits. This method of marketing, of course, necessitates visiting retailers and wholesalers in nearby cities, but this trouble will be more than compensated for by bringing the buttermaker in closer touch with the markets and with general market requirements.

Branding Butter. As with hundreds of other commodities, the branding of good butter is absolutely essential in creating a strong demand for it. A high quality butter without a distinguishing mark is bound to sell at a disadvantage because consumers are not willing to pay high prices for products about whose quality they have no positive assurance. The brand advertises the butter and increases the demand for it, and an increased demand is always followed by better prices.

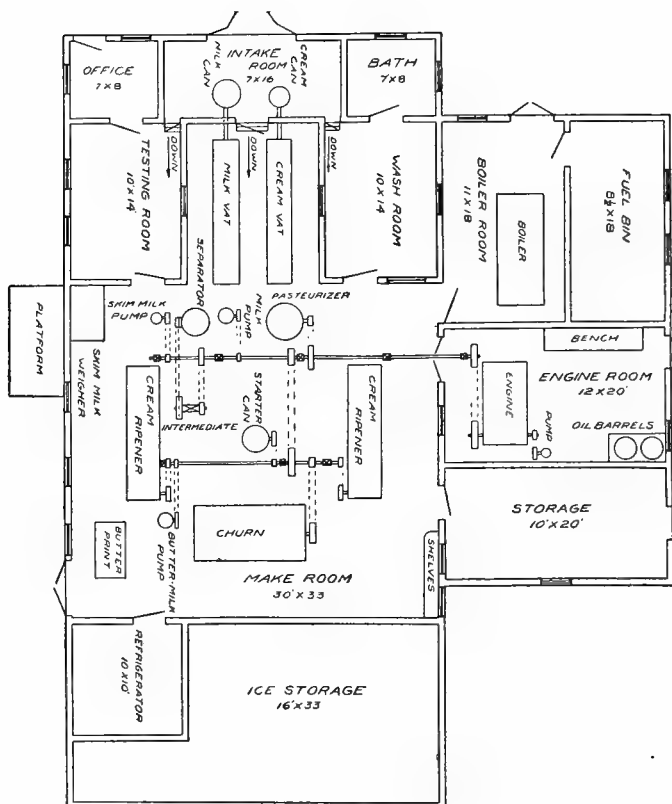

Floor plan of combined gathered cream and whole milk creamery.

MARKETING DAIRY BUTTER.

For fancy trade, one-pound prints wrapped in parchment paper are the most popular. These prints are made with a small hand printer which should have the dairyman's monogram cut into it. The imprint of the monogram in the butter will serve as a guarantee of its genuineness.

It is also desirable to have some neat lettering on the parchment wrapper, such, for example, as Fancy Dairy Butter, Cold Spring Dairy Butter, Golden Jersey Butter, etc. Prints must be kept cold to preserve their attractive rectangular appearance.

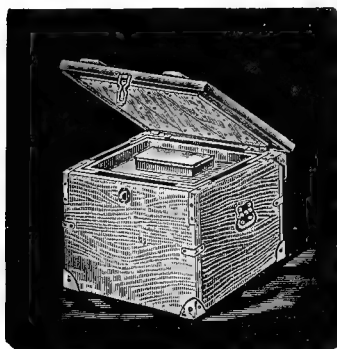

Fig. 55.—Print Butter Box.

The best prices for butter are realized by selling it direct to the

consumer. With milk dealers who retail milk and cream, this method of marketing not only yields the best prices, but is also the most convenient, because the butter can be disposed of at the same time as the milk and cream.

A covered box like that shown in Fig. 55 is best adapted for carrying print butter to market. Ice may be packed in the box with the butter during warm weather.

With the small butter producer the greatest trouble is finding a suitable market for his product. It is customary with most of these producers to sell their butter to the country grocer, who, as a rule, makes little discrimi-

nation in the quality of the butter, the good and the poor selling for practically the same price. No producer of good butter can afford to market his butter in the country stores. Those who have made farm butter making a success have invariably catered to private trade, or have sold their butter to well-known butter dealers. A great deal of butter could be sold in villages, towns, and cities at 25 and 30 cents a pound which would bring only 12 or 15 cents in the country stores. Seek, therefore, private customers who are willing to pay for a good product, and if these are not within easy reach by road, try to reach them by rail.

MARKETING CHEESE.

Cheddar Cheese. Most of the cheese is sold from the factory when from three to ten days old. Flats are shipped either single or two in a box; in the former case they are known as "singles," in the latter as "twins." Young Americas and long horns are usually shipped four in a box.

One or two scale boards should be placed in the bottom of the box and on top of the cheese to protect the surface of the cheese. In the case of "twins," two scale boards should also be placed between the two cheese. The cheese boxes are cut down to about one-eighth of an inch below the top of the cheese. This enables the cover to rest securely on the cheese. About one-half pound overweight should be allowed on each box, the same as on butter tubs. The weight of the cheese must be plainly marked on the side of the box with a blue pencil or stencil.

Cheese as a rule is sold on dairy boards of trade. In Wisconsin, most of the cheese is sold under the "call board" system, which is virtually equivalent to auctioning off the cheese to the highest bidder. All the cheese makers and cheese buyers belonging to a particular board meet as a rule once a week. At this time each cheese maker's offering of cheese is written on a black board, after which the buyers bid on the entries so made. The cheese maker usually sells to the highest bidder.

Soft and Fancy Cheese. Cheese of a perishable nature, such as cottage, cream, club, pimento and Neufchatel, should be sold to the consumer as direct as possible. Milk dealers are in the best position to supply this cheese. Many are already supplying cheese of this kind to their customers at considerable profit. See chapters XV and XXI.

CHAPTER XXXIII.

BUTTER OVERRUN.

In a well conducted creamery the total pounds of butter made is always greater than the total pounds of butter fat received; the difference is called the overrun. Thus, if during a certain time a creamery makes 2,400 pounds of butter from 2,000 pounds of butter fat, the overrun equals 2,400 less 2,000, or 400 pounds. The *per cent* of overrun is found by dividing the number of pounds of overrun by the total pounds of butter fat received and multiplying the quotient by 100. Putting this in the form of a formula, we have:

$$\left. \begin{array}{l} \text{Per cent} \\ \text{Overrun} \end{array} \right\} = \frac{\text{pounds of overrun}}{\text{total pounds of butter fat}} \times 100$$

Where 2,000 pounds of butter fat will make 2,400 pounds of butter, the overrun will therefore equal:

$$\frac{400}{2000} \times 100, \text{ or } 20\%.$$

A mistake not uncommonly made in calculating the per cent overrun is to divide the pounds of overrun by the total pounds of butter, instead of the total pounds of butter fat.

FACTORS THAT INFLUENCE THE OVERRUN.

It is well known that the overrun varies considerably at different creameries as well as at the same creamery.

The amount of overrun is directly dependent upon the following factors:

1. Efficiency of skimming and churning.
2. Composition of the butter.
3. Richness of milk and cream.
4. Mechanical losses.
5. Correct reading of tests.

Efficiency of Skimming and Churning. It is evident that the more fat there is lost in skimming and churning the lower will be the overrun. To obtain a maximum overrun, the loss of fat as shown by the Babcock test should not exceed 0.05 per cent for skim-milk and 0.15 per cent for buttermilk.

In this connection it should be stated that during the summer season it is not at all uncommon to find buttermilk testing from 0.3 to 0.5 per cent, largely a result of employing too high a churning temperature.

Composition of the Butter. Besides butter fat, butter contains water, curd and salt, and, other conditions the same, the greater the amount of non-fatty matter in butter the greater the overrun. Water, being present in large quantity and subject to considerable variation, very appreciably affects the percentage of overrun. There has been a tendency among creameries the past few years to manipulate butter so as to increase its normal water content and thereby increase the overrun.

The water in butter easily fluctuates between 10 and 15 per cent, and a good overrun can be obtained by keeping it within the limits of 13 and 14 per cent.

Salt as a rule has little influence on the per cent of overrun because under normal conditions an increase in

the amount of salt usually results in a decrease in the amount of water. Of course, where special methods of manipulating the water content are resorted to, it is possible to increase the overrun by increasing the amount of salt.

Curd is present in butter in very small quantities, and its influence on the overrun is very slight.

Richness of Milk and Cream. The test of skim-milk is practically independent of the richness of the milk—that is, other conditions the same, skim-milk from 2.5% milk will test the same as that from 5 per cent milk. But since it takes twice as much 2.5 per cent milk to obtain 100 pounds of butter fat as is required with 5 per cent milk, it follows that the loss of fat in the skim-milk will be twice as great with the poorer milk.

Assuming a loss of 0.05 per cent fat in the skim-milk, the loss of fat in the amount of milk needed to yield 100 pounds of butter fat is one pound greater for the poorer milk. The extra pound of fat thus lost would have made approximately 1.18 pounds of butter, so that the overrun from a 5 per cent milk may be expected to be approximately 1.18 per cent greater than that from milk testing 2.5 per cent.

Rich cream yields a higher overrun than poor cream because of the smaller loss of fat in the buttermilk. That is, there is less buttermilk from rich cream than poor cream, and, since the per cent of butter fat in the buttermilk will be about the same in both cases, it follows that the loss will be greater from the poor cream, which yields the greater amount of buttermilk.

Assuming a loss of 0.2 per cent of fat in the buttermilk, 100 pounds of butter fat in 35 per cent cream will

yield about one-half pound more of butter than the same amount of fat in a 20 per cent cream; in other words, the overrun from a 35 per cent cream will be one-half per cent greater than that from a 20 per cent cream.

Mechanical Losses. By mechanical losses is meant the small losses of cream remaining in cans, vats, strainers, etc., and the butter particles remaining in the churns and on the packers, butter spades, etc. Where care is exercised in properly rinsing the cans and ripeners and in the handling of the butter, losses from this source will be rather slight. On the other hand, carelessness in these matters may result in heavy losses and in a material lowering of the overrun.

Correct Reading of Tests. It is very evident that a little too high or a little too low a reading will materially affect the overrun. If a cream whose actual test is 30 per cent should be read only 29 per cent, the overrun will be abnormally increased by approximately 4.0 per cent. It is easy to make a mistake of one per cent in the reading of cream tests and, what is worse, many cream tests are purposely read too low so as to enable the creameryman to show a big overrun. It is to every creameryman's interest to read tests accurately, because inaccuracies are bound to be discovered sooner or later and may lead to the disruption of the creamery.

Average Overrun. The overrun from whole milk averages 18%, that from cream 20%.

CHAPTER XXXIV.

CHEDDAR CHEESE MAKING.

Ripening the Milk. As soon as the milk has been placed in the cheese vat, a test is made for acidity, preferably by means of acid tests such as are described in chapter IX. If less than 0.2% acid is present, starter should be added. Starter improves the flavor of cheese just as it improves the flavor of butter. One to one and one-half pounds of starter per 100 pounds milk is a fair allowance for average cheese factory milk. The starter should always be strained through cheese cloth before adding it to the milk.

After the starter has been added, the milk should be heated to a temperature of 86° F. and allowed to ripen until 0.2 per cent acid is present. While holding the milk for acid development, it should be frequently stirred to keep the cream mixed with the milk. A temperature of 86° F. must be maintained during the ripening process.

Adding Color and Rennet. When the milk shows 0.2 per cent acid, color is added at the rate of about one ounce per thousand pounds of milk. The amount of color to use, however, depends upon market demands, some markets preferring no color at all. The color should be diluted with about four times its volume of water to aid in mixing it with the milk. Imperfect mixing results in mottled cheese.

After the color is thoroughly incorporated, add rennet extract at the rate of about three and one-half ounces per 1,000 pounds of milk. The rennet extract should be diluted with water to the extent of at least five times its own volume before adding it to the milk. After the rennet extract has been thoroughly stirred in, the milk should be allowed to stand undisturbed until sufficiently curdled to cut. The temperature at the time of adding the rennet should be 86° F.

The amount of rennet extract to be used is determined by the quickness with which the cheese is to ripen. If a quick ripening cheese is wanted, add about 4 ounces per 1,000 pounds of milk. If a slow ripening cheese is desired, add 2½ to 3 ounces per 1,000 pounds.

While the milk is curdling it must be kept well covered to keep the surface layer warm.

Cutting the Curd. To determine when the curd is ready to cut insert the forefinger, slightly break the curd with the thumb, and move the finger in the direction of the break and parallel to, and half an inch below, the surface. If the whey in the break is clear, the curd is ready to cut; if milky, the curdling has not progressed far enough. The cutting is done as follows: First cut the curd in horizontal layers with the horizontal knife; next cut lengthwise and crosswise, alternately, with the perpendicular knife until the curd cubes are about three-eighths of an inch on a side.

Warming and Stirring the Curd. Immediately after cutting, stir the curd very gently, yet enough to prevent the particles from matting together. Run the palm of the hand along the sides and bottom of the vat to remove any adhering curd. After 10 minutes stirring, gradually apply heat and raise the temperature to between 98° and

100° F. in about 30 to 45 minutes. After this temperature has been reached, the curd may be stirred at intervals of 10 minutes until ready to remove the whey. It is important to keep the temperature close to 100° F.

Drawing Off the Whey: When a bunch of curd is pressed between the two hands and on relieving the pressure the particles fall apart readily, the curd is ready for the removal of the whey. When this firmness is reached, the whey should show 0.17 to 0.18 per cent acid. When the milk is set at the proper ripeness, the degree of firmness and amount of acid indicated above are reached in two and one-half to three hours after adding the rennet extract.

Remove the whey through a faucet or by means of a siphon. Place perforated wooden racks, about two inches high, at one end of the vat and cover them with a piece of muslin or French crash. Scoop the curd upon the racks, which have the advantage of draining the curd quickly and also permits the use of hot water under the curd to assist in keeping the temperature at 98° F., a temperature which should be maintained up to within a short time of salting.

Piling and Matting the Curd. As soon as removed from the whey, the curd is stirred a few minutes, spread about six inches deep upon the racks and then allowed to mat 15 minutes, after which it is cut into strips about 8 by 12 inches and then turned. After another 15 minutes, turn again and pile the strips two layers deep; 15 minutes later turn again and pile three layers deep. Usually after one and a half to two hours matting the curd tears like chicken breast, which indicates that it is ready to mill. During the entire matting process the curd should be kept at a temperature of 98° F.

Milling. When properly matted the curd is run through a curd mill, which will cut the curd into strips about the size of a finger. This treatment makes possible a ready absorption of the salt by the curd.

Salting. After milling the curd is stirred frequently until it becomes mellow and velvety to the touch, when it is ready to salt. At this time the whey exuding from the curd should show about one per cent acid. With normally working curds, salt can usually be added about one hour after milling. Tainted curds require more time.

If a fast-curing cheese is desired, salt at the rate of $2\frac{1}{4}$ pounds of salt per 100 pounds of curd. When a slow-ripening cheese is desired salt at the rate of $2\frac{3}{4}$ pounds. Use only the best grade of salt, and have the curd at a temperature of about 90° F. at the time of salting. The salt must be evenly mixed with the curd to ensure uniformity of color and quality in the cheese.

Molding and Pressing. When the curd has become soft and mellow, which usually requires from 20 to 30 minutes, the curd is ready for the hoops (molds) which are prepared as follows: Place a piece of muslin in the bottom of the hoop and on top of this a cheese cloth circle somewhat less in diameter than the hoop. Now place the bandage on the bandager so that when the latter is in position the bandage will lap slightly over the cheese cloth circle in the bottom of the hoop. Next put in the curd. This done, cover the curd with a piece of muslin and put on the cover (follower). Apply pressure very gradually at the start and do not apply full pressure (about 20 lbs. to the square inch) until after 20 to 30 minutes' pressing. Shortly after full pressure has been applied, remove the follower, the muslin cloth and bandager. Turn the projecting bandage over onto the

cheese. Next place a cloth circle over the top, replace the muslin and bandager, and then apply full pressure for about 12 hours. The cheese is now taken out of the hoop, any folds or irregularities in the bandage straightened out, and then washed off with hot water and put back into the hoop inverted. Press about ten hours longer and remove the cheese from the hoop and put it into a suitable place for curing. Remove the muslin cloths but leave the cheese cloth circles on the cheese.

Ripening or Curing. After leaving the press the cheese should be placed in a cool, damp room with ample ventilation. Keep the temperature of the curing room at 60° F. or below. The curing or ripening process, which consists of the transformation of insoluble into soluble casein, requires from two to eight months, according to the amount of rennet extract and salt used, amount of moisture in the cheese and the temperature at which it is ripened. The higher the temperature and moisture, the quicker the cheese will ripen. During the first two weeks the cheese should be turned and rubbed daily, and if any portion of it is not covered with cheese cloth, grease should be applied to prevent cracking.

The Value of Low Curing Temperatures. A subject which deserves more attention than has heretofore been given it is the value of cold storage in connection with cheese factories. Many factories are already thus equipped and the general opinion of the owners of these factories is that the advantages afforded return very good interest on the money invested. The chief advantages afforded by cold storage are less shrinkage and a better quality of cheese.

Experiments have shown that with cheese weighing about 65 pounds, the shrinkage during the first week,

when the cheese is kept at 55° F., is 1.6 pounds per hundred pounds of cheese. At 80° F. the shrinkage is 2.4 pounds per hundred, an increase of 50 per cent.

With small cheese weighing 9 pounds, the shrinkage is about 40 per cent greater than with cheese weighing 65 pounds. Since the temperature in the majority of curing rooms averages about 80° F. during July and August, a factory making cheese weighing 9 pounds and averaging 600 pounds per day will effect a saving of 6.72 pounds by curing the cheese the first week at 55° F. instead of 80° F. At 14 cents per pound the saving amounts to 94 cents a day.

What is of still greater significance than the saving in shrinkage, is the general improvement in the quality of cheese cured at low temperature. Temperatures between 50° and 60° F. will produce very satisfactory results.

Paraffining Cheese. To prevent molding and excessive loss of moisture in curing cheese in the average curing room, cheese should be paraffined about three days after it leaves the press or as soon as the rind has become thoroughly dry. The paraffining is done by immersing the cheese for about five seconds in paraffin having a temperature of at least 220° F., and 240° F. is better.

GASSY MILK.

Gassy milk causes cheesemakers a great deal of trouble, especially during the hot summer months. Gassy curds and floating curds have always been among the cheesemaker's greatest troubles. During hot weather the gas producing bacteria predominate over the other undesirable kinds and under certain conditions they predom-

inate over the lactic acid kind. It is under the latter condition that the gassy curds result.

Preventive Measures. The trouble from gas organisms can almost entirely be overcome by instructing the patrons to cool their milk thoroughly and by the use of a good lactic acid starter. The cooling of the milk holds the gas producing bacteria in check and will give the cheesemaker milk sweet enough to enable him to use a reasonable amount of starter.

In many cheese factories, during warm weather, the milk arrives at the factory too ripe to permit the use of starter. Where this is the case a high quality cheese is hardly possible. If there is no trouble from gas organisms there are usually other taints present.

The use of one pound of good starter to every 100 pounds of milk will almost entirely eliminate trouble from gas germs and will also eliminate taints that are likely to develop where no starter is added. Where the sweetness of the milk permits, it is desirable to use more starter but care must be taken not to overripen the milk with too much starter which might result in an acid or sour cheese; but at least one-half pound to the hundred pounds of milk should always be used.

Handling Gassy Curds. A good starter is the best means of combating gas-producing bacteria. The latter cannot survive in the presence of a large number of lactic acid organisms. Every cheesemaker knows that gassy milk ripens slowly and this is so because the gas organisms seriously hamper the development of the acid bacteria. It is for this reason that milk that is known to be gassy should be ripened further before adding the rennet than normal milk. Also more acid should be developed in the whey than with normal curds.

While the curd is matting on the racks, the temperature should be kept close to 98° F. and this temperature should be maintained close up to salting. The curd after cutting should be kept well stirred and the salting delayed until the gas holes have thoroughly flattened or practically disappeared. At this stage the curd will be very mellow and greasy, a condition favoring a close textured cheese from gassy milk. After salting the curd should also be kept well stirred and allowed to become mellow and velvety before going to press.

Where curds show gas day after day a curd test should be made of each patron's milk to locate the source of trouble. Directions for making a curd test are given on page 191.

HANDLING OVERRIPE MILK.

When milk is overripe, set at a little higher temperature, add a little more rennet, cut the curd a trifle softer than usual and cut finer. By cutting the curd twice as fine as usual it can be firmed up in practically one-half the usual time. Heat faster than usual. Curd that is cut fine cannot easily be injured by fast heating. In heating fast, however, greater care must be exercised in preventing the curd from getting lumpy.

Heat the curd to a higher temperature than usual—up to 106° F. in badly overripe milk. Remove a portion of the whey as soon as possible; this materially checks the development of acid. Stir the curd constantly. If rather soft at dipping time, stir upon racks until firm. Do not develop more than the usual amount of acid in the whey. It is better to dip the curd soft rather than to hold it till firm and develop too much acid.

If the curd is rather soft when placed on the racks

and the acid appears to develop fast, do not pack the curd deep but turn it frequently and keep the temperature close to 98° F. Pouring clean, warm water over the curd right after it is placed on the racks, will materially check the development of acid.

Mill rather early and when the proper amount of acid has been reached, salt. If the curd is rather soft and moist at this time use an extra amount of salt and hold the curd longer than usual after salting.

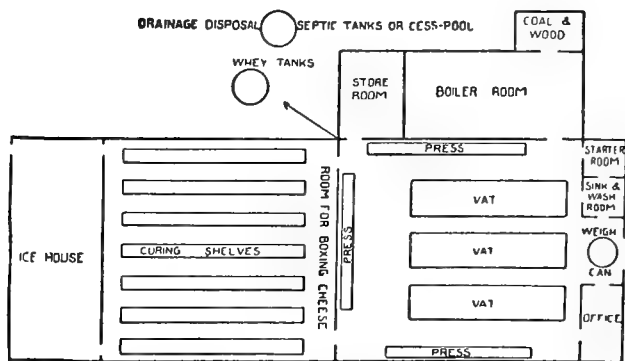

Floor Plan of Cheese Factory. (From "Science and Practice of Cheese Making.")

CHAPTER XXXV.

CREAMERY AND FACTORY DIVIDENDS.

CREAMERY DIVIDENDS.

Milk and cream yield butter in proportion to their butter fat content. That is the reason why practically all milk and cream made into butter are now bought by the "Babcock test," that is, on the "butter fat basis." In discussing the method of paying for milk and cream, therefore, only the "butter fat basis" will be considered.

The periodical payments made for milk and cream at creameries are known as creamery dividends. These payments or dividends are sometimes made daily, as in the case of some gathered cream plants; more often, however, they are made weekly, semi-monthly and even monthly.

The different steps in the calculation of dividends at creameries are as follows:

First, find the total pounds of butter fat received from all the patrons. This is done by finding the total amount of butter fat furnished by each patron separately and adding together the totals so found. In finding each patron's total butter fat, every delivery of cream is multiplied by its test and the results of the different deliveries added together.

Second, find the net money from the sale of butter by multiplying each sale of butter by its price and deducting from the amount thus found the cost of making the butter.

Third, find the price per pound of butter fat by divid-

ing the total net money by the total pounds of butter fat delivered by all the patrons.

Fourth, find each patron's share of the money by multiplying the total pounds of butter fat delivered by him by the price per pound of butter fat.

To make the above steps perfectly clear, let us calculate a weekly dividend at a creamery where only cream is received and where A, B and C are the patrons:

Illustrating the First Step. The total butter fat delivered by A, B and C is as follows:

	Pounds of cream.		Test.	=	Pounds of butter fat.
A.	May 2	42	×	35.4	= 14.87
	May 4	50	×	30.1	= 15.05
	May 6	48	×	30.5	= 14.64
	May 7	20	×	36.6	= 7.32
	Total				<u>51.88</u>
B.	May 2	23	×	40.5	= 9.32
	May 4	29	×	30.0	= 8.00
	May 6	25	×	36.4	= 9.10
	May 7	13	×	35.0	= 4.55
	Total				<u>30.97</u>
C.	May 2	64	×	33.0	= 21.12
	May 4	69	×	31.1	= 21.46
	May 6	58	×	37.5	= 21.75
	May 7	30	×	34.4	= 10.32
	Total				<u>74.65</u>

The total butter fat delivered by A, B and C equals 51.88 + 30.97 + 74.63 equals 157.48 pounds.

Illustrating the Second Step. The net money is found as follows:

	Pounds of butter sold.	Price per pound.	Amount.
May 3	86	× 26½c	= \$22.79
May 7	103	× 26c	= 26.78
	189		\$49.57
Total lbs. butter.....			Total money

At 3½ cents a pound for making, the cost of manufacture will be 3½ × 189, or \$6.62. Deducting this amount from the total money, there remains \$42.95, which is the total net money due the patrons.

Illustrating the Third Step. The price per pound of butter fat is obtained by dividing the total net money found in step two by the total pounds of butter fat found in step one. Thus: $\$42.95 \div 157.48 = 27.27$ cents = price per pound of butter fat.

Illustrating the Fourth Step. Find the money due each patron by multiplying the butter fat furnished by him as determined in step one by the price per pound of butter fat as determined in step three. Thus:

51.88	×	\$.2727	=	\$14.15	=	A's money.
30.97	×	.2727	=	8.44	=	B's money.
74.65	×	.2727	=	20.36	=	C's money.

WHERE WHOLE MILK IS RECEIVED.

The method of calculating dividends at whole milk creameries is the same as that at hand separator creameries except that a test is not made of each delivery of milk. Where whole milk is received a composite sample is made of each patron's milk; that is, each patron is provided with a pint jar to which samples of his milk are added daily for one or two weeks when the composite sample is tested. A test of the composite sample represents the

average per cent of butter fat in the milk for the period during which the sample was gathered.

The method of composite sampling employed by whole milk creameries is also used to some extent at hand separator creameries, but unless the cream is delivered in a fine, sweet condition, sufficiently accurate results cannot be obtained with this method. Usually hand separator cream is delivered in a more or less sour condition which does not permit of composite sampling. The fact that the deliveries of cream vary considerably in quantity and richness is a further reason why the composite method of testing cream is liable to lead to inaccurate results.

WHERE BOTH MILK AND CREAM ARE RECEIVED.

The calculation of dividends at creameries receiving both milk and cream differs from the method used where only milk or cream is received in that allowance must be made for the fat lost in the milk skimmed at the creamery. On an average 2 per cent of the total fat of milk is lost in the skimming process. Hence, if cream patrons are credited with all the fat they bring in the cream, it will be necessary to deduct 2 per cent of the fat brought in the milk by the whole milk patrons, which represents the amount carried home by them in the skimmed milk.

Heretofore most creameries have equalized the payment for milk and cream by increasing the butter fat from cream patrons by 2 per cent, which, so far as dollars and cents are concerned, will have the same effect as deducting 2 per cent from the fat delivered by whole milk patrons. The latter method, however, results in a greater overrun and therefore in a greater price per pound of butter fat. In order, therefore, to put cream-

eries receiving both whole milk and cream on a par with those receiving only cream, so far as overrun and price per pound of fat is concerned, it will be necessary to deduct 2 per cent from the fat delivered by whole milk patrons and not, as commonly done, add 2 per cent to the fat delivered by cream patrons.

The following example illustrates how milk and cream patrons are credited with butter fat in making dividends at creameries receiving both milk and cream:

Patron A delivers 6,500 pounds of milk testing 4.0 per cent.

Patron B delivers 600 pounds of cream testing 30 per cent.

A's total fat = $6,500 \times .04 = 260$ pounds. B's total fat = $600 \times .30 = 180$ pounds. To decrease A's fat by 2 per cent, multiply 260, the total pounds of fat furnished in his milk, by .98, which equals 254.8.

In making the dividend, therefore, A is paid for 254.8 pounds of fat and B for 180 pounds.

THE TWO PER CENT—HOW CALCULATED.

In a well conducted creamery the average loss of fat in the skim-milk should not be more than .078%. Dividing this figure by the average percentage of fat in milk, 3.9, we get .02. So that in the separating process, .02 pound of fat is lost in the skim-milk for every pound of fat present in the milk.

From the above calculation it will be seen that the cream factor (2%) would necessarily vary with the efficiency of skimming and the average test of the milk. To determine what this shall be for any particular creamery divide the average loss of fat in the skim-milk by the average test of the milk at the creamery.

METHODS OF PAYING FOR MILK AND CREAM.

While practically all creameries buy milk or cream according to the amount of fat contained in it, the method of paying for same varies with different creameries. With proprietary whole milk creameries, the usual custom has been to guarantee patrons a certain price for butter based upon some leading market quotation and charge a fixed price for making the butter, say $3\frac{1}{2}$ cents per pound. All of the butter made belongs to the patrons.

Cooperative creameries, as a rule, pay for butter fat according to the net returns from the creamery; that is, they deduct from the total gross returns the actual cost of making the butter, plus a small sinking fund, and divide the balance on the basis of the amount of butter fat furnished by each.

Many hand separator creameries, and most of the centralizers, pay for butter fat according to market quotations on butter. The price paid averages, as a rule, from one to three cents below the average market price for butter, transportation charges being paid by the creamery.

AVERAGING TESTS.

In whole milk creameries, where the amount of milk delivered from day to day and the tests of the same vary but slightly, reasonably accurate results may be obtained by averaging two composite tests, each representing, say, one week's milk. With cream the matter is different. Cream deliveries from the same patron vary considerably in quantity and quality and hence averaging cream tests is almost certain to lead to fallacious results, as may be seen from the following example:

The quantity and quality of cream delivered by a certain patron for three days is as follows:

Date.	Lbs. cream.	Per cent fat.
May 1	33	40.5
May 2	48	30.0
May 3	55	28.5
	136	3)99.0

Wrong average test = 33.0
 Wrong total fat = $136 \times 33 = 44.88$ lbs.

The correct average test is obtained by multiplying each delivery of cream by its test and dividing the total butter fat thus found by the total number of pounds of cream and multiplying the quotient by 100. Thus:

Lbs. cream.	Per cent fat.	Lbs. fat.
33	40.5	13.36
48	30.0	14.40
55	28.5	15.68
136		43.44

Correct average test = $(43.44 \div 136) \times 100 = 31.94\%$
 Correct total fat = 43.44

CREAMERY STATEMENT.

When the monthly or weekly payment is made, each patron is presented with an envelope upon which is printed his individual account with the creamery and also the entire transactions of the creamery. A check on the nearest bank, or the money, is placed in the envelope and handed to the patron on "pay day." Such a statement is shown on the next page.

Creamery Co.

IN ACCOUNT WITH

Mr. _____

For the month of _____ 190_____

Cr.	Dr.
No. lbs. milk delivered	Lbs. butter.....@.....
by you, - - -	Cans, @.....
Average test, -	Cash, " - - -
No. lbs. of butter fat,	Hauling, @.....
Price per lb. " "	per 100 lbs., -
\$.....	\$.....

Balance due you, - - - \$_____

Total lbs. milk delivered at creamery, - - - _____

Average test at creamery, - - - _____

Total lbs. of Butter fat at creamery, - - - _____

Sales of Butter.	{	_____ lbs. @ _____ \$_____
		_____ " " _____ _____
		_____ " " _____ _____
		_____ " " _____ _____

Less _____ cts. for making.

Balance due patrons, - - - \$_____

Per cent. overrun - - - _____

Testing witnessed by _____

 _____ Prest.
 _____ Sec'y.

FACTORY DIVIDENDS.

The different steps in calculating dividends at cheese factories are as follows: First find the total butterfat delivered by all the patrons. Let us suppose that during the first week of April Patron A delivered 700 pounds of milk testing 3.6% fat. $7.00 \times 3.6 = 25.2 =$ number of pounds of fat in the 700 pounds of A's milk. Let us suppose that during the same period Patron B delivered 36.5 pounds of fat and Patron C 42 pounds. The total fat furnished by the three patrons is $25.2 + 36.5 + 42$, or 103.7 pounds.

Having found the number of pounds of fat delivered, next find the net amount of money due the patrons. By referring to the sales book we find that the 103.7 pounds of fat made 270 pounds of cheese, which was sold at 18 cents per pound. $270 \times \$.18 = \48.60 , the total money received for the 270 pounds of cheese. We will suppose that $1\frac{3}{4}c$ was charged for making. The total charge for making would be $270 \times 1\frac{3}{4}c$, or \$4.72. Subtracting this from the total money, we have \$43.88, which is the net money due the patrons.

Next find the price per pound of fat by dividing the total net money by the total pounds of fat, thus: $\$43.88 \div 103.7 = \$.4231 =$ price per pound of fat.

Now we find each patron's share of the money by multiplying his fat by the price per pound of fat. Thus:

$$\text{A's money} = 25.2 \times \$.4231 = \$10.66$$

$$\text{B's money} = 36.5 \times .4231 = 15.44$$

$$\text{C's money} = 42.0 \times .4231 = 17.77$$

CHAPTER XXXVI.

MECHANICAL REFRIGERATION.

In warm climates and in localities where ice is not obtainable or only so at a high cost, cold may be produced by artificial means known as mechanical refrigeration. This system of refrigeration is also finding its way into creameries that are able to procure ice at a moderate cost but which are seeking more satisfactory means of controlling the temperature of their cream, refrigerator, make room, etc.

Refrigerating Machines. There are four kinds of machines used for refrigerating purposes: (1) vacuum machines in which water is used as the refrigerating medium; (2) absorption machines in which a liquid of a low boiling point is used as the refrigerating medium, the vapors being absorbed by water and again separated from it by distillation; (3) compression machines which operate practically the same as the absorption machines except that the vapors in this case are compressed instead of absorbed; and (4) mixed absorption and compression machines.

Most of the machines in use at the present time belong to the compression type; the following discussion will therefore confine itself strictly to this class of machines.

Principle. The principle employed in mechanical refrigeration is the production of cold by the evaporation of liquids which have a low boiling point, like liquid ammonia, liquid carbonic acid, ether, etc.

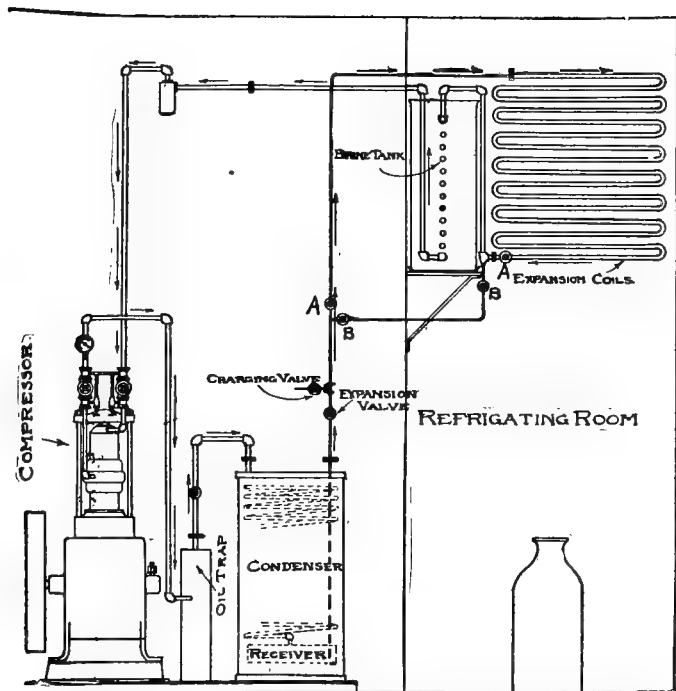

Fig. 56.—Showing circulation of ammonia in mechanical refrigeration.

When a liquid evaporates or changes into the gaseous state it absorbs a definite amount of heat called heat of vaporization or "latent" heat. Thus to change water from 212° F. to steam at 212° F. requires a considerable amount of heat which is apparently lost, hence the term latent (hidden) heat.

Ether changes into its gas at a much lower temperature than water which is illustrated by its instant evaporation when poured upon the hand. The heat of the hand in this case is sufficient to cause vaporization and the sensation of cold indicates that a certain amount of heat has been abstracted from the hand in the process.

Manifestly for refrigerating purposes a liquid must be used that can be evaporated at a very low temperature; for the cold in mechanical refrigeration is produced by the evaporation of the liquid in iron pipes, the heat for the purpose being absorbed from the room in which the pipes are laid. Anhydrous ammonia has thus far proven to be the best refrigerant for ordinary refrigeration.

Anhydrous Ammonia (Refrigerant). This substance is a gas at ordinary temperatures but liquifies at 30° F. under one atmospheric pressure. In practical refrigeration the ammonia is liquified at rather high temperatures by subjecting it to pressure. The ammonia is alternately evaporated and liquified so that it may be used over and over again almost indefinitely.

Circulation of Ammonia. The cycle of operations in mechanical refrigeration is as follows: The liquid ammonia starts on its course from a *liquid receiver*, and enters the *refrigerating coils* in which it evaporates, absorbing a large amount of heat in the process. By means of a *compression pump*, operated by an engine, the ammonia vapors are forced in the *condenser coils* where the

ammonia, under pressure, is again liquified by running cold water over the coils. From the condenser coils it enters the liquid receiver, thence again on its journey through the refrigerating coils.

The intensity of refrigeration is regulated by an *expansion valve*, which is placed between the liquid receiver and the refrigerating coils. This valve may be adjusted so as to admit the desired quantity of liquid ammonia to the coils.

Systems of Refrigeration. There are two ways in which the cooling may be accomplished by mechanical refrigeration: (1) by evaporating the liquid ammonia in a series of pipes placed in the room to be refrigerated; and (2) by evaporating the liquid ammonia in a series of coils laid in a tank of brine and forcing the cold brine into coils laid in the room to be refrigerated. The former is known as the direct expansion system, the latter as the indirect expansion or brine system.

Brine System. In creameries where the machinery is run only five or six hours a day the brine system is the more satisfactory as it permits the storing of a large amount of cold in the brine, which may be drawn upon when the machinery is not running.

The brine tank is preferably located near the ceiling in the refrigerator where it will serve practically the same purpose as an overhead ice box. In addition to this, the refrigerator should contain a coil of direct expansion pipes which may be used when extra cold is desired.

Brine from the above tank may be used for cooling cream by conducting it through coils which are movable in the cream vat; it may also be conducted through stationary pipes placed in the make room for the purpose

of controlling the temperature during the warm summer months.

The brine is kept circulating by means of a *brine pump*.

Strength of Brine. The brine is usually made from common salt (sodium chloride). The stronger the brine the lower the temperature at which it will freeze. Its strength should be determined by the lowest temperature to be carried in the brine tank. The following table from Siebel shows the freezing temperature as well as the specific heat of brine of different strengths:

Percentage of salt by weight.	Pounds of salt per gallon of solution.	Freezing point (F.).	Specific heat.
1.....	0.084	30.5	.992
2.....	0.169	29.3	.984
3.....	0.256	27.8	.976
4.....	0.344	26.6	.968
6.....	0.523	23.9	.946
8.....	0.708	21.2	.919
10.....	0.897	18.7	.892
12.....	1.092	16.0	.874
15.....	1.389	12.2	.855
20.....	1.928	6.1	.829
25.....	2.488	0.5	.783
26.....	2.610	-1.1	.771

The fact that the specific heat grows less as the brine becomes stronger shows it to be wise not to have the solution stronger than necessary, because the less the specific heat the less heat a given amount of brine is able to take up.

Refrigerating Capacity. When speaking of a machine of one ton refrigerating capacity, we mean that it will produce, in the course of twenty-four hours, the amount of cold that would be given off by one ton of ice at 32° F.

melting into water at the same temperature. Its actual ice making capacity is usually about 50% less.

Size of Compressor. In a moderately well insulated creamery handling from twenty to twenty-five thousand pounds of milk daily, a four-ton compressor will be large enough. With a compressor of this size the machinery will not have to be run more than five or six hours a day. If the machinery is run longer than this a smaller compressor will do the work.

Power Required to Operate. The power required per ton of refrigeration is less the larger the machine. With a four-ton compressor the power required is from two to two and one-half horse power per ton of refrigerating capacity in twenty-four hours.

Refrigerating Pipes. The refrigerating pipes vary from one to two inches in diameter. With moderately good insulation it is estimated that by the direct expansion system one running foot of two-inch piping will keep a room of forty cubic feet content at a temperature of 32° F. With brine nearly twice this amount of piping would be necessary.

For cooling the brine in the brine tank, about 140 feet of 1¼-inch pipes are required per ton of refrigerating capacity.

Expense of Operating. When a refrigerating plant has once been installed and charged with the necessary ammonia, the principal expense connected with it will be the power required to operate the compressor. This power in a creamery is supplied by the creamery engine. The ammonia, being used over and over again, will add but a trifle to the running expenses. Nor can the water used for cooling the ammonia vapors add much to the cost of operating. It is true, however, that the refrigera-

ting plant will require some of the butter maker's time and attention, but this is probably no more than would be consumed in the handling of ice in the creamery.

Charging and Operating an Ammonia Plant. This subject is so ably discussed in *The Engineer* by H. H. Kelley that the author feels he can do no better than present the following extracts from that article.

"When about to start an ice or refrigerating plant, the first thing necessary is to see that the system is charged with the proper amount of ammonia. Before the ammonia is put in, however, all air and moisture must be removed; otherwise the efficiency of the system will be seriously interfered with. Special valves are usually provided for discharging the air, which is removed from the system by starting the compressor and pumping the air out, the operation of the gas cylinder being just the reverse of that when it is working ammonia gas. It is practically impossible to get all the air out of the entire system by this means, so that some other course must be taken to remove any remaining air after the compressor has been started at regular work. This can be accomplished by admitting the ammonia a little at a time, permitting the air to escape through a purge valve, the air being thus expelled by displacement. The cylinder containing the anhydrous ammonia is connected to the charging valve by a suitable pipe, and the valve opened. The compressor is then kept running slowly with the suction and discharge valves wide open and the expansion valve closed. When one cylinder is emptied put another in its place, being careful to close the charging valve before attempting to remove the empty cylinder, opening it when the fresh cylinder is connected up.

"From sixty to seventy-five per cent of the full charge is

sufficient to start with so that the air may have an opportunity of escaping with as little loss of ammonia as possible. An additional quantity of ammonia may then be put in each day until the full charge has been introduced. When the ammonia cylinders have been emptied and a charge of, say, seventy-five per cent of the full amount has been introduced, the charging valve is closed and the expansion valve opened. The glass gauge on the ammonia receiver will indicate the depth of ammonia. The appearance of frost on the pipe leading to the coils and the cooling of the brine in the tank will indicate that enough ammonia has been introduced to start with. It is sometimes difficult to completely empty an ammonia cylinder without first applying heat. The process of cooling being the same when the ammonia expands from the cylinder into the system as when leaving the expansion valve, a low temperature is produced and the cylinder and connections become covered with frost. When this occurs the cylinder must be slightly warmed in order to be able to get all the ammonia out of it. The ammonia cylinders, when filled, should never be subjected to rough handling and are preferably kept in a cool place free from any liability to accident. The fact that ammonia is soluble in water should be well understood by persons charging a refrigerating system, or working about the plant. One part of water will absorb about 800 parts of ammonia gas and in case of accident to the ammonia piping or machine, water should be employed to absorb the escaping gas. Persons employed about a plant of this kind should be provided with some style of respirator, the simplest form of which is a wet cloth held over the mouth and nose.

“After starting the compressor at the proper speed and adjusting the regulating valve note the temperature of

the delivery pipe, and if there is a tendency to heat open it wider, and vice versa. This valve should be carefully regulated until the temperature of the delivery pipe is practically the same as the water discharged from the ammonia condenser. With too light a charge of ammonia the delivery pipe will become heated even when the regulating valve is wide open. As a general thing when the plant is working properly the temperature of the refrigerator is about 15° lower than the brine being used, the temperature of the water discharged from the ammonia condenser will be about 15° lower than that of the condenser, the pointers on the gauges will vibrate the same distance at each stroke of the compressor and the frost on the pipes entering and leaving the refrigerator will be about the same. By placing the ear close to the expansion valve the ammonia can be heard passing through it, the sound being uniform and continuous when everything is working properly.

“When air is present the flow of ammonia will be more or less intermittent, which irregularity is generally noticeable through a change in the usual sound heard at the expansion valve. The pressure in the condenser will also be higher and the effect of the apparatus as a whole will be changed, and, of course, not so good. These changes will be quickly noticed by a person accustomed to the conditions obtaining when everything is in order and working properly.

“The removal of air is accomplished in practically the same manner as when charging the system, permitting it to escape through the purging valve a little at a time so as not to lose any more gas than is absolutely necessary.

“The presence of oil or water in the system is generally detected by shocks occurring in the compressor cylinder.

“In nearly all plants the presence of oil in the system of piping is unavoidable. The oil used for lubricating purposes, especially at the piston rod stuffing boxes, works into the cylinders and is carried with the hot gas into the ammonia piping, where it never fails to cause trouble. The method of removing the air from the system has already been referred to, but the removal of oil is accomplished by means of an oil separator. This is placed in the main pipe between the compressor and the condenser, and is of about the size of the ammonia receiver. Sometimes another oil separator is placed in the return pipe close to the compressor, which serves to eliminate any remaining oil in the warmer gas and to remove pieces of scale and other foreign matter which, if permitted to enter the compressor cylinder, would tend to destroy it in a very short time.

“The oil, which always gets into the system sooner or later and in greater or less quantity, depending upon the care exercised to avoid it, acts as an insulator and prevents the rapid transfer of heat from the ammonia to the pipe that ought to obtain, and also occupies considerable space that is required for the ammonia where the best results are to be obtained.”

CHAPTER XXXVII.

WASHING AND STERILIZING MILK VESSELS.

Wash Sinks. A matter of importance in washing milk vessels is to have the right kind of sinks, three of which are needed for the most satisfactory work: One

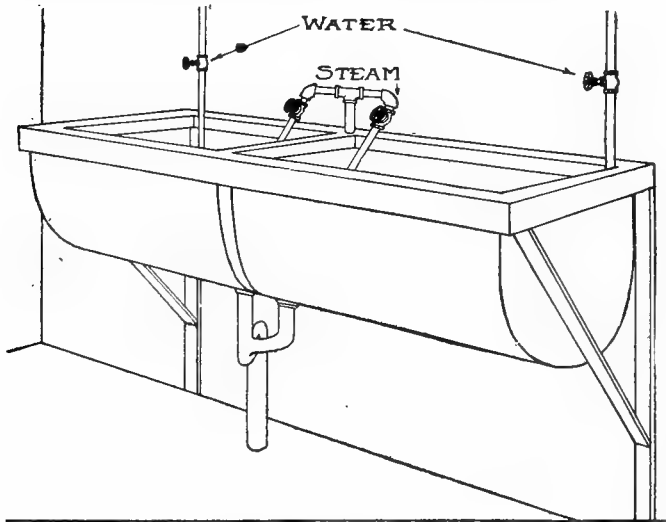

Fig. 57.—Wash Sinks.

for rinsing before washing, one for washing and one for final rinsing.

For convenience the wash sink should be thirty-six

inches long, twelve inches deep, and sixteen inches wide. The bottom should be round and two feet from the floor. When closer to the floor than this too much stooping is required.



A Good Cleaning Brush.

Milk Bottle Brush.

Galvanized iron furnishes one of the most suitable materials for the construction of wash sinks. They should be provided with steam (or hot water) and cold water pipes as shown in Fig. 57.

Method of Washing. All vessels should be thoroughly rinsed in warm water to remove small residues of milk and cream. The rinsing is followed by washing with moderately hot water to which a handful of some cleaning powder has been added. The washing should be done with brushes rather than cloths because the bristles enter into crevices which a cloth could not possibly reach. Finally rinse the vessels in clean water.

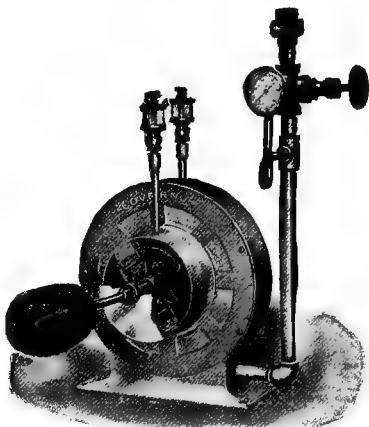

Fig. 58.—Bottle Washer.

A bottle washer, like that shown in Fig. 58, saves much

labor and does very efficient work. The motive power may be either steam or water.

Sterilizing. Vessels that have been washed in the manner described above may look perfectly clean, but may still be far from being free from bacteria. These can be destroyed only by exposing the vessels to the boiling temperature for some time.

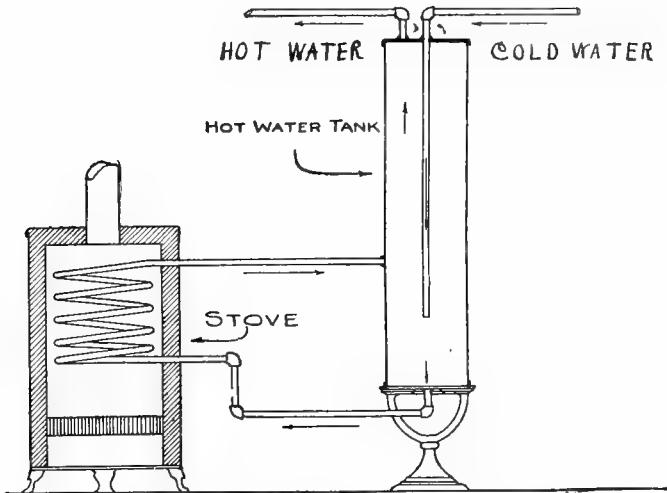

Fig. 59.—Cheap Arrangement for Securing Hot Water.

The simplest method of sterilizing is to place the vessels in boiling water for five minutes. This method commends itself especially to small dairymen who have no steam.

Where no steam is available, the best means of procuring hot water is the apparatus shown in Fig. 59.

The hot water tank is that commonly used in residences for heating water for the bath tub and can be obtained

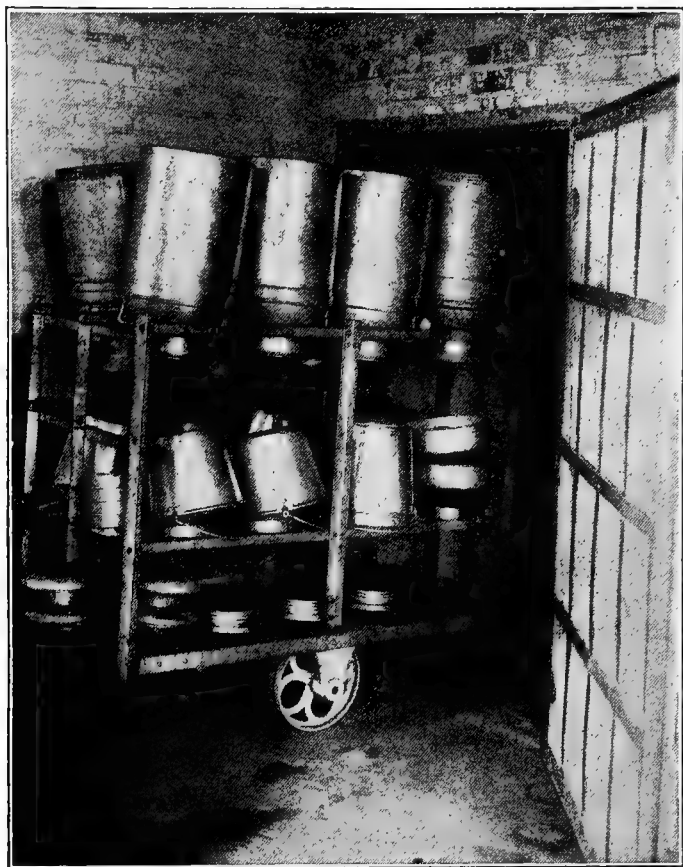

Fig. 60.—Sterilizing Truck and Front of Brick Sterilizer.

from plumbers for about \$7.00. Any stove in which iron coils can be heated will answer as a heater.

The best method of sterilizing is to place the vessels

in a steam chamber of sufficient strength to withstand a pressure of about fifty pounds to the square inch. These sterilizers are usually constructed of concrete or brick and

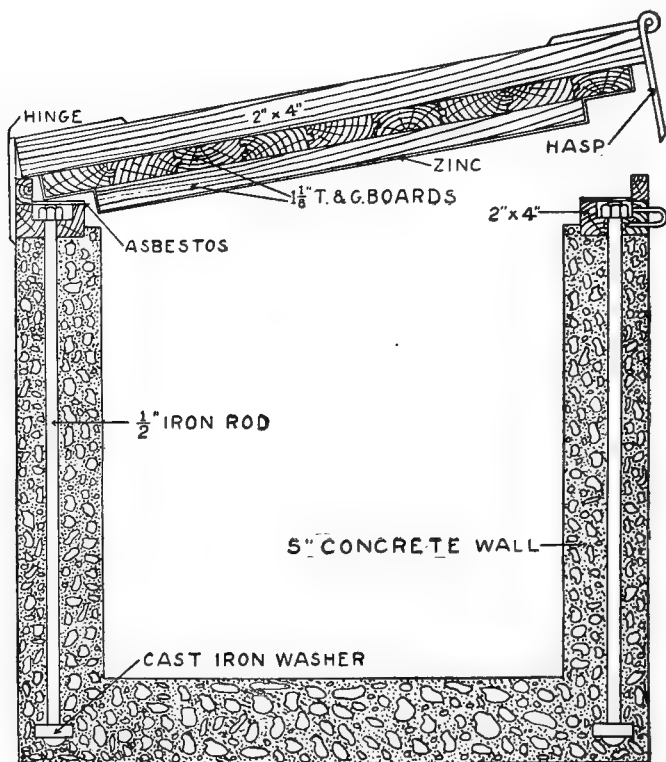

Fig. 61.—Cross-Section of Concrete Sterilizer.

are provided with a heavy iron door which is large enough to admit a truck bearing the pails, cans, bottles, etc. Other sterilizers of this type are constructed of galvanized iron.

The principal drawback to some of these sterilizers is

their high cost, which renders their use by small dairymen almost prohibitive.

Cheap Sterilizers. A cross section through a cheap concrete sterilizer is shown in Fig. 61. It is essentially a rectangular concrete tank with a wooden cover which is lined with zinc. The sides and bottom are five inches thick and are built of concrete, which is made up of one part cement, two parts sand, and two parts coarse gravel. A thin coat, consisting of one part cement and two parts sand, is used as an inside finish.

Fig. 62 shows a common galvanized iron sterilizer which answers the purpose for small dairymen.

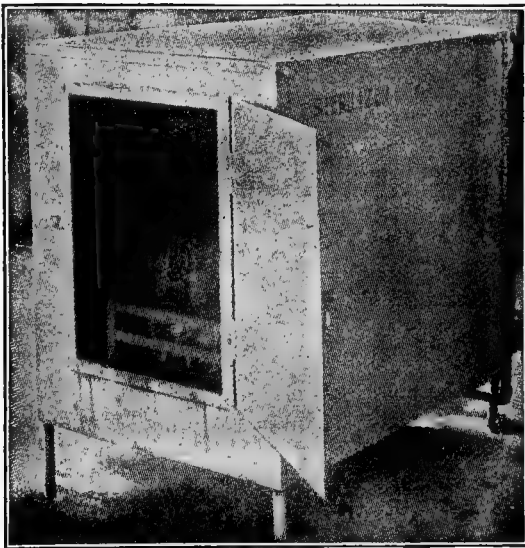

Fig. 62.—A Cheap Sterilizer.

CHAPTER XXXVIII.

DAIRY HOUSES.

Location. In selecting a site for a dairy house, convenience and sanitation should be given first consideration. A well drained spot, free from rubbish and bad odors, and within reasonable distance from the barn should be selected. An abundance of good, pure water must be available.

Floor Plans Designed by the Author. Dairymen who sell milk and cream occasionally have a surplus of these products on their hands, which is usually made into butter. Floor plans for dairy houses must therefore provide for small buttermaking outfits in addition to all the necessary apparatus for the handling of milk and cream.

The floor plan shown in Fig. 63 is designed to meet the needs of small dairymen. Figs. 64 and 66 illustrate plans which will answer the needs of dairymen having from twenty to fifty cows. The first two plans provide for retail milk; the last provides for farm buttermaking. There is no question that refrigerating machinery can be employed very advantageously in a great percentage of the larger dairies. See Fig. 68, page 318.

Details of Construction. The foundation for the walls may be constructed of stone, brick or concrete. It should rest upon firm, solid ground below the frost line, and the top must be at least one foot above ground.

In building the walls, place the studs two feet apart

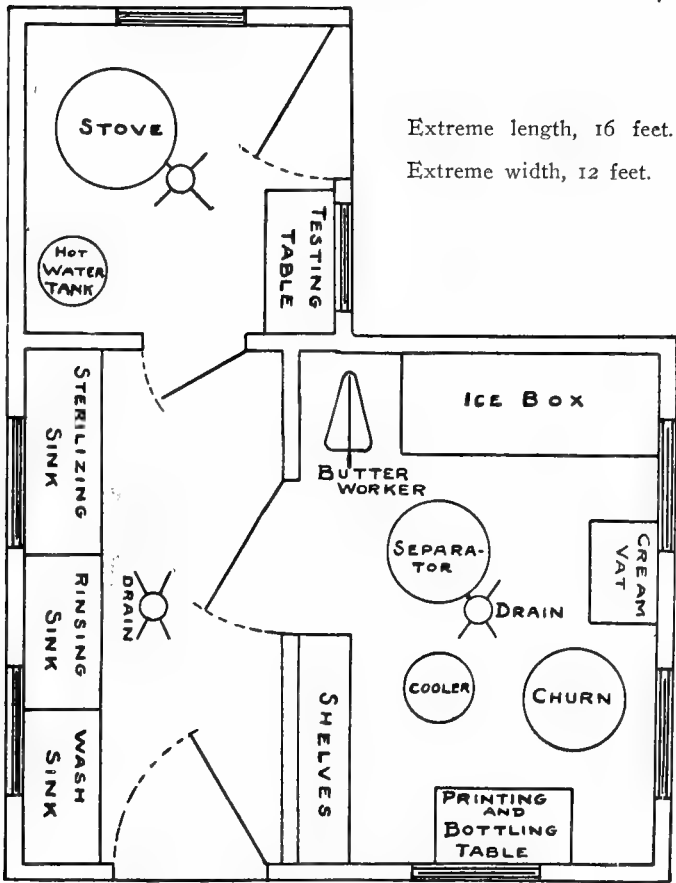

Fig. 63.—Floor Plan of Dairy House for Retail Milk.

and tack building paper on both sides. Weather board the outside and finish the inside as follows: Board up preferably with tongued and grooved lumber, and cover the boards with two thicknesses of

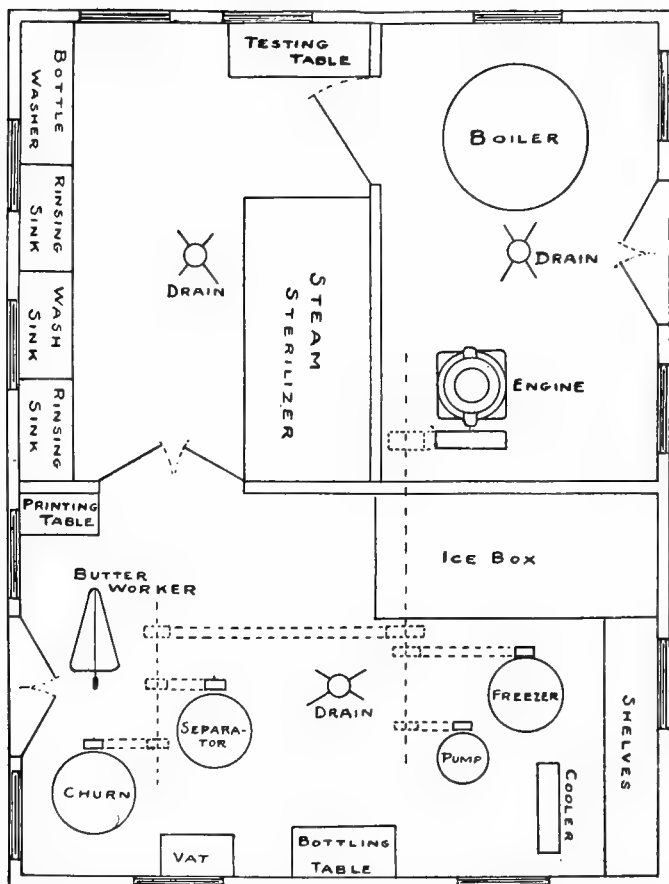

Fig. 64.—Floor Plan of Dairy House for Retail Milk Trade, Suitable for Fifty Cows. 18'x24'.

roofing paper. Next put on furring strips, one foot apart, and to these fasten wire lathing. If the lathing is provided with one-inch steel ribs the furring strips are not

needed. Next apply one and one-half inches of cement plaster consisting of one part cement, three parts clean, coarse sand, and one part slacked lime paste. Press the

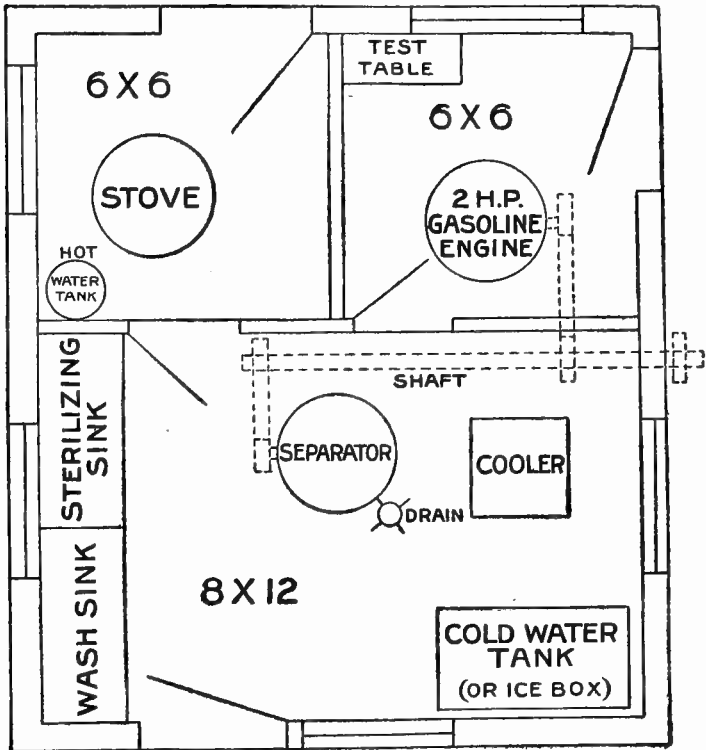

Fig. 65.—Milk House for Cream Patrons.

concrete partly through the wire lathing. Finish with one part cement and one part sand and trowel off as smoothly as possible. This construction provides one three-fourths inch and one four-inch dead air spaces.

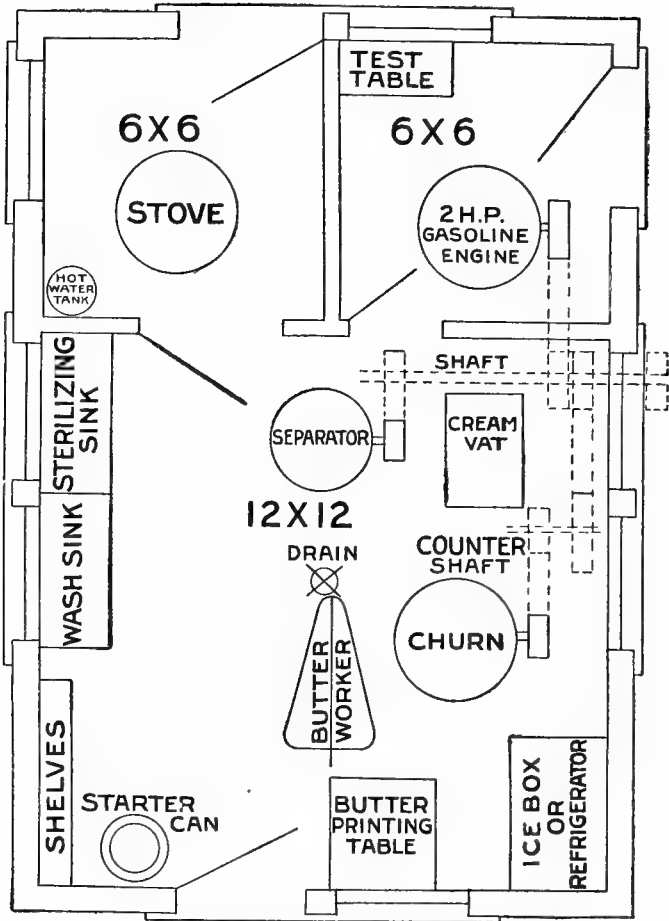

Fig. 66.—Floor Plan of Dairy House for Farm Buttermaking.

Construct a four-inch concrete floor upon a well tamped foundation consisting of gravel, cobble stones and cinders.

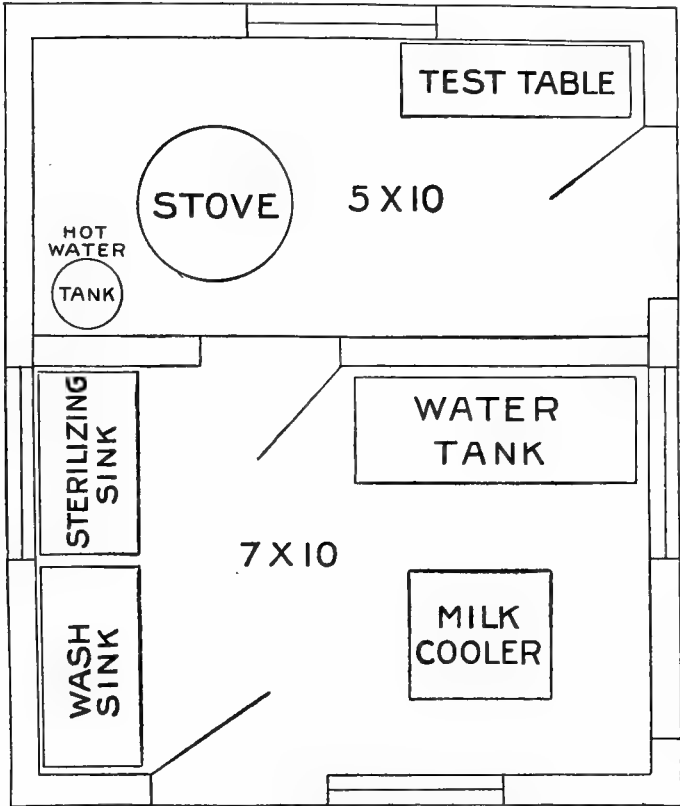

Fig. 67.—Milk House Whole Milk Patrons.

These materials afford good drainage and thus prevent the cold and dampness usually associated with concrete floors. In preparing the concrete for the floor use one part

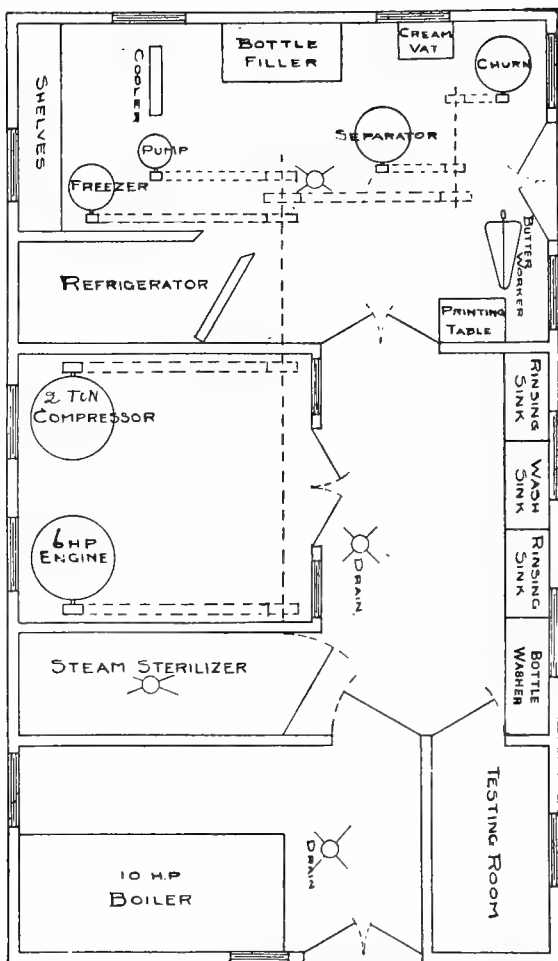

Fig. 68.—Floor Plan of Dairy House Suitable for Forty to Eighty Cows. (Mechanical Refrigeration.) 18'x30'.

cement, two parts clean, coarse sand and four parts gravel or crushed stone. Finish with one part cement and two parts sand.

All parts of the floor should slope toward the drain in the center. Round out the corners and edges of the floor with concrete to make them more easily cleanable.

The ceiling should be about twelve feet high and built of the best ceiling lumber. Keep the ceiling well painted.

Enough windows must be provided to afford ample light and to admit sunshine to all parts of the building.

Provide ventilation in the milk and wash rooms by running tight ventilating shafts from the ceiling through the top of the roof.

Sewerage. Effective sewerage must be provided at the time the floor is laid. A bell trap should be placed in the center of each room and carefully connected with the sewer. Conduct the sewage far enough away to keep its odors a safe distance from the dairy house.

Screening. Where proper sanitation is expected it is absolutely necessary to guard against flies, and this can easily be done by screening all doors and windows. Flies are a prolific source of milk contamination and must therefore be rigidly excluded from the dairy.

CHAPTER XXXIX.

CITY MILK AND ICE CREAM PLANTS.

Perhaps of all dairy buildings, the least uniformity of construction is found in city milk and ice cream plants. This fact was thoroughly impressed upon the author during a tour of inspection which included visits to some of the best plants in the country.

It is to be expected that the same method of construction cannot be followed in all its details under all conditions, yet it is believed that there are at least some principles that may be advantageously embodied in the construction of all buildings of this kind. The plans which accompany this article are, therefore, not submitted with the idea of meeting all conditions, but rather to furnish suggestions which it is believed will prove valuable to most prospective builders.

City Milk Plants. For sanitary reasons, it is desirable to eliminate pumps and piping as far as possible. Whatever piping is needed should be in short sections, easily detachable, smooth and well tinned, not galvanized.

In the gravity scheme shown in the illustration on page 322, the amount of piping is reduced to a minimum. The milk cans are raised to the second floor by means of an elevator. Here the milk is sampled and weighed and takes its course as shown in the vertical section. It will be noted that from the receiving vat the milk passes into a clarifier which removes any suspended foreign matter from the milk. Many milk plants do not

use clarifiers, but those who do, claim that the clarification of milk is a paying proposition. So long as milk is not produced under the sanitary conditions which now prevail upon certified dairy farms, just so long will clarification remain a desirable practice.

The plans submitted provide for pasteurization by the held or retarder process. When the heating is finished the milk is discharged over a large cooler of the tubular style which is most commonly used in milk plants.

It will be noted that the plan provides for a room devoted exclusively for making butter, ice cream, cultured milk, fancy cheese and modified milk, all of which can be profitably undertaken by milk dealers, and sufficient room should be provided to allow for expansion in these side lines.

One common mistake in milk plants is the failure to isolate the wash room. This is a very essential matter because milk is certain to become contaminated when the washing is done in the same room in which it is pasteurized or bottled.

The illustration shows the use of steam only as a source of power. In some of the larger plants, however, the machinery is run with gas power, which is far more economical than steam. It is estimated that a pound of coal burned in a gas producer will develop about *eight* times as much power as the same amount of coal burned under the boiler.

In a large and expensive milk plant recently constructed the gravity system of handling milk is used differently from that shown in the foregoing illustration. The different machines are elevated one above the other by a series of platforms arranged between the floor and the ceiling. Necessarily the ceiling is a considerable dis-

tance from the floor. An elevator brings the milk to the receiving vat from which it flows into the clarifier, thence into a standardizing vat, thence into the pasteurizer, and so on down the line. The space under the platform is used as a wash room.

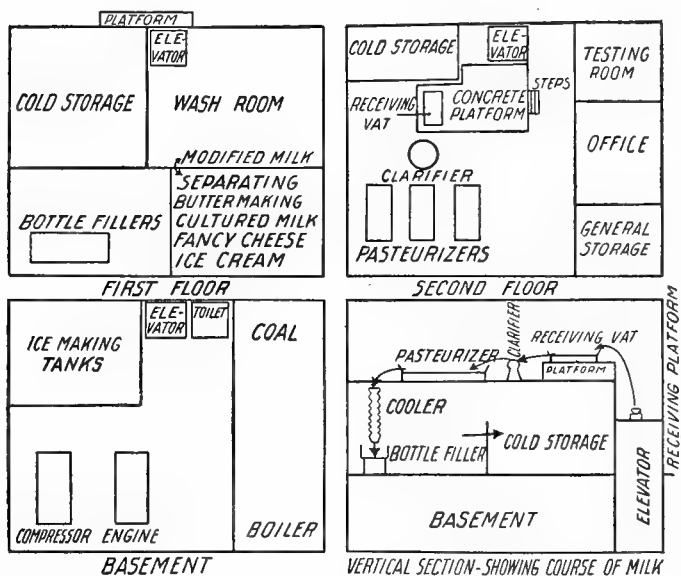

Fig. 69.—Plan for City Milk Plant.

In some large plants the milk is weighed in a can sunk in the first floor and from there run into a receiving vat in the basement. From this point the milk is pumped to the top floor.

In still other plants, all the work is done on one floor, the milk being pumped from one machine to another, three, and in some cases four, pumps being kept busy.

City Ice Cream Plants. In the construction of ice cream plants, the situation is similar to that of milk plants, in that each plant has its own peculiar arrange-

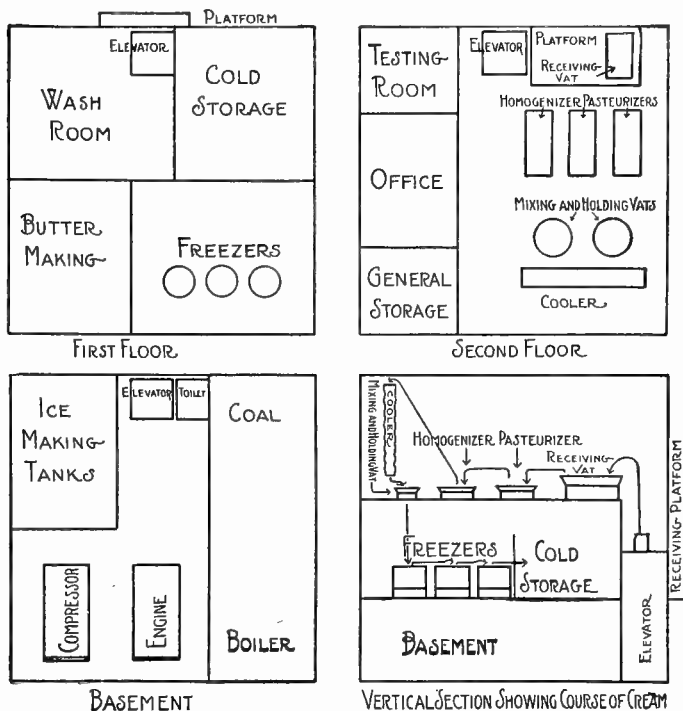

Fig. 70.--Plan for City Ice Cream Plant.

ment for handling the cream. Some ice cream manufacturers follow the one floor plan, others follow the gravity system entirely. The one floor plan in ice cream plants is open to the same objection as the one floor plan

in city milk plants, namely, requiring the use of pumps and too much piping.

The two floor plan, shown in the accompanying illustration, seems to furnish the best conditions for handling the cream. An elevator is used to raise the cream cans to the second floor where the cream is weighed and sampled and then emptied into a receiving vat placed upon an elevated platform. From the receiving vat the cream flows into a "held" process pasteurizer and from this it is discharged into the homogenizer, a machine which is at present used by most large ice cream manufacturers. The homogenizer forces the cream to the top of the cooler, which should be of ample size to permit reducing the temperature to near freezing. From the cooler the cream passes into the mixing vat in which it is standardized and the necessary ingredients added. From the mixing vat the "mix" flows directly into the freezers.

Most ice cream manufacturers prefer to keep the pasteurized cream in the refrigerator several days, and even a week, before freezing so as to give more body to the cream, thus increasing the "swell" in the freezing process. Storing cream in this manner is open to two serious objections: (1) the increased labor and expense of storing; and (2) the deterioration in the flavor of the cream. There is nothing to justify the prolonged storing of pasteurized cream before freezing, except the slightly increased overrun, and the best ice cream manufacturers have found that the extra cost of labor and cold will offset any advantage in yield. Every hour cream is held in cold storage the flavor suffers and for this reason some of the best ice cream manufacturers freeze their cream the same day it is pasteurized.

In the foregoing illustration the arrangement does not provide for holding cream in the refrigerator after pasteurization. Cream, however, could be held over a day in the mixing vat by providing the latter with the necessary cooling coils.

What has been said in regard to the economy of using gas power in milk plants applies with equal force to ice cream plants.

Sanitary Features. Matters of prime importance in the construction of milk and ice cream plants include an abundance of light and the use of material which can easily be kept clean. There is no better disinfectant than sunlight, and too many windows cannot be inserted in buildings used for handling milk and cream. To secure the maximum amount of sunlight some of the best milk plants use dormer windows or skylight.

To be sanitary, the floors, walls and ceiling should be constructed of concrete; in fact the entire building should be built of brick or concrete. Where it is desired to combine "showiness" with sanitary efficiency, more expensive material such as tile may be used for inside finish.

Reinforced Floors. To increase the wearing quality of concrete floors, perforated steel plates should be embedded in the surface of the concrete floor immediately after the cement finish has been applied.

CHAPTER XXXX.

THE BOILER AND ITS MANAGEMENT.

A boiler is indispensable in a well equipped dairy. The steam which it provides is important, not only in securing hot water and in sterilizing, but also in furnishing power. A steam engine will be found useful in most dairies for pumping water, separating milk, churning and freezing cream, and by extending the shaft through one side of the building its usefulness may be extended to sawing wood, washing clothes, running the grindstone, etc.

For the smaller dairies the upright form of boiler will be found the most satisfactory. But for dairies having upwards of fifty cows, the horizontal form of fire-tube boiler should be used. The latter style is laid in brick. The grates are supported upon brickwork and heat and smoke pass along the underside of the boiler toward the rear and return through the fire-tubes. To prevent radiation of heat the brick work must be built up to cover the entire boiler. The fire box must be constructed of the best fire brick.

The various boiler accessories will be described in the following paragraphs:

Glass Gauge. This is a glass tube attached to the side of the boiler to indicate the height of the water in it. It is so attached that its lowest point is about two inches above the highest part of the fire line of the boiler, its entire length being usually about fifteen inches. The

cock at the bottom is used to blow out the sediment that is liable to block the opening between it and the boiler. When this occurs the gauge becomes a false indicator. Frequent blowing out is therefore necessary. The cock next to the blow-out admits the water from the boiler. The cock above this admits the steam. When the glass breaks shut off the water first, then the steam. Always have a few extra glasses on hand so that the broken one can be immediately replaced. Owing to its tendency to clog, the gauge can not always be relied upon, hence the use of water cocks placed next to the glass gauge.

Water Gauge Cocks. There are three of these used. The water level should be kept as near as possible to the middle cock. It should never go below the lower cock, nor above the upper. These cocks should be opened many times during the day, and so long as steam issues from the upper and water from the lower cock, the water level is all right.

Steam Gauge. This shows the number of pounds of steam pressure per square inch on the boiler by means of a pointer moving around a dial. Below the dial is a loop which contains water to prevent injury to the gauge from the hot steam. The steam gauge is liable to get out of order and will then fail to show the true pressure. Such a condition is indicated by the safety valve.

Safety Valve. This is placed on top of the steam chamber and permits the escape of steam when the steam pressure reaches the danger limit. It is an indispensable boiler attachment as without it the boiler would be a dangerous thing. There are two kinds of safety valves, the "pop" and "ball and lever" types. The former is considered the more desirable because it is not so easily

tampered with. Both can be set to blow off at different pressures.

Water Feed Apparatus. There are two ways of feeding water into a boiler, namely, with injectors and with pumps.

Injector. This important boiler accessory is attached to the side of the boiler. It utilizes the steam directly from the boiler for forcing water into it against a pressure as great as that which sends it forth. The principle which makes this possible may be stated as follows: Steam issuing from a boiler under 70 pounds pressure has a velocity of 1,700 feet per second. When steam with this high velocity strikes the combining tube it produces suction which in turn induces a flow of water. As soon as the water enters the combining tube it is given motion by the high velocity of the steam, which immediately condenses and moves with the water into the boiler at a comparatively low velocity. The energy, therefore, by which steam can force water into the boiler against its own pressure is the latent heat resulting from the condensation of the steam in the combining tube.

From this it must be evident that the efficiency of the injector is dependent upon the completeness with which the steam condenses. This is clearly proven by every day practical experience. When, for instance, the feed water is too hot, the steam pressure too high, or the steam is wet, the injector fails to work properly because the steam does not sufficiently condense when it strikes the feed water.

Starting the Injector. This is done by opening the supply water valve one or two turns, then the steam valve wide. If steam issues from the overflow admit a little more water; if water overflows admit less.

Care of Injector. An injector will become coated with sediment or scale the same as the boiler and must, therefore, be frequently cleaned. This is best done by immersing it in a solution of one part muriatic acid and ten parts water. Allow to remain in this solution until the scale becomes soft enough to permit washing out. A clean injector rarely causes trouble but if trouble does occur it may be due to : (1) low steam pressure ; (2) too hot water ; (3) leaks in pipes and injector ; (4) clogging of water pipe ; (5) wet steam ; (6) poor working condition of check and overflow valves ; (7) clogging of feed pipe where it enters the boiler.

The injector is commonly used to feed water into the boiler because it is cheap and simple, and occupies little space.

Pumps. There are two kinds ; (1) those run with steam directly, and (2) those run by the engine. The latter is the more economical and handles hot water with less trouble. It has one disadvantage, however, and that is it does not work unless the engine is running. With good pumps, especially those run by the engine, good work may be expected when the feed water has been heated to 200° F. with the exhaust steam from the engine. With the injector such high temperatures are not permissible, hence the greater economy of the pump. The great saving of fuel by feeding water hot into the boiler is illustrated by experiments made by Jacobus which show that with a direct acting pump 12.1% fuel is saved by heating the feed water from 60° to 200° before pumping it into the boiler. With injectors the feed water used usually has a temperature of about 60° F.

Steam. Water is practically a non-conductor of heat. This means that it cannot conduct its heat to its neighbor-

ing particles. When, therefore, heat is applied to the bottom of a vessel containing water, the particles at the bottom do not communicate their heat to the particles next above them, but expand and rise, cool ones taking their places. This gives rise to convection currents which tend to equalize the temperature of the water in the vessel. When the water has reached a uniform temperature of 212° F. the particles begin to fly off at the surface in the form of vapor, and this we call *steam*. To generate steam in a boiler, then, it is necessary to impart to the water in it a considerable amount of heat, which is produced by burning fuel in the fire box.

FIRING OF BOILER.

The immense amount of heat stored in wood and coal is rendered effective in the boiler by burning (combustion). To understand how to fire a boiler intelligently one must first learn what the process of burning consists of.

Process of Burning. Anything will burn when the temperature has been raised high enough to cause the oxygen of the air to unite with it. Thus, in "striking" a match the temperature is raised high enough by the friction produced to cause the match to burn. The burning match will produce heat enough to ignite the kindling, which in turn, produces the necessary heat to ignite the wood or coal in the fire box of the boiler. Burning may, therefore, be defined as the union of the oxygen of the air with the fuel. In burning a pound of coal or wood a definite amount of air must be admitted to furnish the necessary oxygen for complete combustion. When oxygen is lacking part of the fuel passes out of the chimney un-

burned in the form of gases. If, on the other hand, too much air is admitted the excess simply passes through the chimney, absorbing heat as it passes through the boiler. The problem of firing becomes, therefore, a difficult one.

Burning Coal and Wood. When hard coal is burned the fire should be thin. A thickness of three to four inches on the grates gives very satisfactory results. For best results with soft coal a thickness of six to seven inches is recommended. Whenever fresh coal is added it should be placed near the front and the hot coals pushed back.

In case wood is burned the fire box should be kept well filled, care being necessary to keep every part of the grates well covered.

GENERAL POINTERS ON FIRING.

1. Boilers newly set should not be fired within two or three weeks after setting and then the firing should be very gradual for several days to allow the masonry to harden without cracking.

2. Never fire a boiler before determining the water level by trying the water gauge cocks. You can not entirely rely upon glass gauges, floats, and water alarms.

3. When starting the fire, open the upper water gauge cock and do not close it until steam begins to issue from it. This permits the escape of confined air.

4. Kindle the fire on a thin layer of coal to protect the grate bars.

5. Always examine the safety valve before starting a fire.

6. When starting the fire all drafts should be open.

7. The firing should be gradual until all parts of the boiler have been heated.

8. Never allow any part of the grate bars to become uncovered during firing.

9. Frequently clean the ash pit to prevent overheating of grates from the hot cinders underneath.

10. The coals upon the grates should not be larger than a man's fist.

11. Remember that firing up a boiler rapidly is apt to cause leaks.

12. Remember that too little water in the boiler causes leaks and explosions.

13. Remember that soot and ashes on heating surfaces always waste fuel.

14. When fire is drawn, close dampers and doors of furnace and ash pit.

15. Never open or close valves when the water is too low in the boiler, but immediately bank the fire with ashes or earth. Opening the safety valve at such a time will throw the water from the heated surfaces, resulting in overheating and possibly in explosions.

16. Use the poker as little as possible in firing.

17. Keep the grate bars free from "clinkers."

18. When the steam pressure goes too high, start the pump, open the doors of the furnace and close the ash pit.

19. A steady and even fire saves fuel.

GENERAL CARE OF BOILER.

1. Always close the steam and water valves of the glass gauge when you leave the building for half an hour or more.

2. Water gauges should frequently be blown out and cleaned.

3. Keep the exterior of the boiler dry. Moisture will corrode and weaken it.

4. The boiler should be blown off under low pressure every two or three days.

5. A boiler that is not used for some time should be emptied and dried. If this cannot readily be done, fill it full of water to which a little soda has been added.

6. Frequently examine the safety valve to see that it is in good working order.

7. Do not empty boiler while brick work is very hot.

8. Never pump cold water into a hot boiler. Leaks and explosions may be the result.

9. Leaky gauges, cocks, valves, and flues should be repaired at once.

10. Do not fail to examine the pressure gauge frequently.

11. It is good policy to have two means of feeding a boiler. The pump or injector may get out of order and cause delay and danger.

12. Feed pumps and injectors need frequent cleaning to keep them in good working order.

13. Look out for air leaks. If air is admitted anywhere except through the grates serious waste may result. Such leaks are to be looked for in broken doors and poor brick work.

14. Flues should be cleaned often, especially if soft coal is burned. This will prevent overheating of metal and at the same time save fuel.

15. Do not allow filth to accumulate around the boiler or boiler room.

16. Keep all the bright work about the boiler "shiny."

17. Do not fail to empty the boiler every week or two and refill with fresh water.

18. Have your steam gauge tested at least twice a year.

BOILER INCRUSTATION.

In all boilers after a period of use, there is deposited upon the parts below the water level a scale or sediment known as boiler incrustation.

Cause of Scale. The formation of scale is due to the impurities contained in the feed water. When impure water is fed into the boiler the impurity first manifests itself in the form of scum on top of the boiling water. The heavier particles of the scum slowly unite and sink to the bottom where they first appear as mud. By continued exposure to high temperature, this mud gradually forms into a hard impervious scale which usually consists largely of lime.

Objection to Scale. 1. The excessive formation of boiler scale is the immediate cause of most boiler explosions. The scale acts as a non-conductor of heat, so that in cases where the capacity of the boiler is severely taxed, the metal becomes overheated, thus materially weakening it. The scale is, therefore, not only dangerous, but by overheating the metal, also materially shortens the life of the boiler. 2. Another most serious objection to scale is its wastefulness of fuel. This becomes evident when we note that the heat before reaching the water must first be conducted through a non-conducting layer of incrustation.

Prevention of Scale. Since nearly all water used for boilers is more or less impure, it is evident that to prevent scale, boilers must receive frequent cleaning. How often

this needs to be done is, of course, dependent upon the amount and character of the impurity in the water. Boilers are kept clean in three different ways, (1) by blowing off at low pressure, (2) by cleaning through manhole, and (3) by using boiler compounds.

(1). By blowing the boiler off at low pressure most of the mud will be blown out. But care must be taken that the pressure is not above ten pounds and that there is no more fire in the fire box, otherwise the mud, instead of flowing out with the water, will bake on and form scale.

(2). A good way of removing mud is to allow the boiler to cool off and then run a rubber hose through the manhole. By working the hose and forcing water through it the sediment can be removed.

(3) Boiler compounds are used to keep boilers free from scale. The kind of compound to be used is determined by the character of the impurities of the water. Most dairies use well water for the boiler and the chief impurity in this is lime. The best compound for water of this kind is soda. Well water contains the lime in widely different proportions. In order, therefore, to ascertain the proportion of soda to feed water the following method is recommended by Hawkins:

“1. Add one sixteenth part of an ounce of soda to a gallon of the feed water and boil it. 2. When the sediment thrown down by the boiling has settled to the bottom of the kettle, pour the clear water off and add one-half drachm of soda to this. Now, if the water remains clear, the soda which was put in has removed the lime. But if it becomes muddy, the second addition of soda is necessary.” In this way the amount of soda to be added to the feed water can be calculated with sufficient accuracy.

Tan bark is very efficient in removing boiler scale but may injure the iron.

Kerosene answers the same purpose but renders the steam unfit for use in the dairy.

When the water is salt or acid, a piece of metallic zinc occasionally placed in the boiler will prevent corrosion. Water of this kind can usually be told by its corrosive effect on copper and brass. Acid water can also be detected with blue litmus paper, which it turns red.

WET AND DRY STEAM.

Wet Steam. This is steam holding in suspension extremely small particles of water which are thrown off from the water surface while steam is generating. The following are the causes of wet steam:

1. Impure water in the boiler.
2. Too much water in the boiler.
3. Too little evaporating surface for the amount of steam used. This is one of the chief objections to upright and too small boilers.
4. Violent agitation of the water in the boiler caused by too rapid a generation of steam.

Wet steam causes "priming" and is wasteful of heat.

Dry Steam. This is saturated steam holding no water mechanically in suspension. High steam pressure and a large steam space above the water level are conducive to dry steam.

CHAPTER XXXXI.

WATER AND ICE SUPPLY.

WATER SUPPLY

Importance of Pure Water. A great deal of disease in farm homes is directly traceable to infected water. Typhoid fever especially is so frequently caused by polluted well water that physicians at once look to this as the probable cause wherever this disease is found to exist.

Where wells infected with disease germs happen to exist on dairy farms that supply milk to neighboring cities, disease is not limited to the dairyman's own family, but may be spread along the entire milk route. Many typhoid fever epidemics have been positively traced to milk which has become infected through water containing the disease germs. Nowhere is pure water so important, therefore, as upon dairy farms.

The disease germs usually find their way into the milk through milk vessels which have been washed with infected water. The use of such water for washing cows' udders previous to milking may also be the means of infecting the milk supply.

Location of Well. The most satisfactory location for the well is at the dairy house where the coldest water is required and where it will be most convenient. Here the water for both the dairy, the home, and the stock can be pumped with the dairy engine. Further, the well, like

the dairy house, should stand on slightly elevated ground so as to insure drainage away from it.

Construction of Well. In a properly constructed well, no water should enter it except near the bottom. This compels the water to pass through a thickness of earth sufficient to purify it where the wells are of a reasonable depth.

Where there is no rock or hard clay and where the

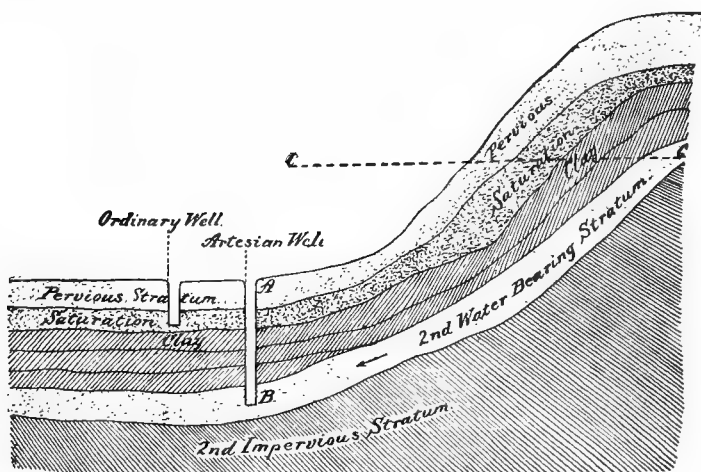

Fig. 71.—Soil Strata. (From Harrington's "Practical Hygiene.")

water can be had at a reasonable depth, the driven well, commonly known as the Abyssinian tube well, is the cheapest and one of the safest. This well is made by driving into the ground a water-tight iron tube, the lower end of which is pointed and perforated.

In case rocks and hard clay must be penetrated, or great depth must be reached to secure water, the bored or drilled well, piped from top to bottom with water-tight iron pipes, will be found most satisfactory.

Water from the upper pervious stratum should be avoided wherever possible, even with wells of the kind just described. Especially is this necessary where the wells are shallow. The purest water is obtained by sinking the well through an impervious stratum, like that shown in Fig. 71.

The most dangerous well is the common dug well with pervious walls and so located as to permit seepage into it from outhouses, barnyards and cesspools. Wells of this type are altogether too common on dairy farms.

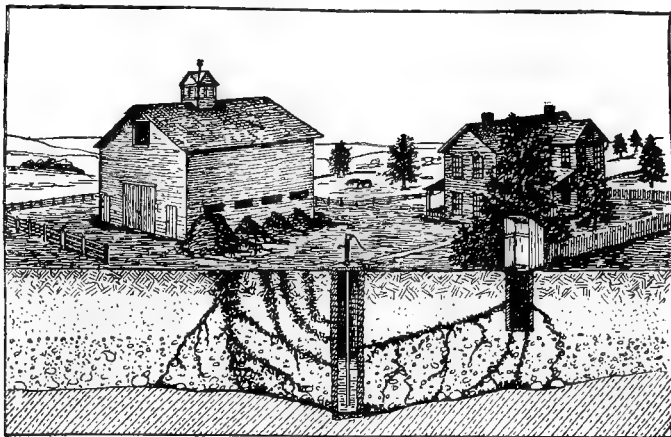

Fig. 72.—Sources of Well Water Contamination. (From Bul. 143 Kan. Exp. Sta.)

All wells, whatever their construction, must be provided with water-tight metallic or concrete covers to prevent the entrance of impurities into the shaft.

ICE SUPPLY.

Necessity of Ice. Where there is no equipment for

mechanical refrigeration, ice is indispensable in furnishing the best quality of milk and cream. A low enough temperature cannot be secured with water alone, neither can the cooling be accomplished as quickly as is desirable for best results. Furthermore, a satisfactory cold storage cannot be had without the use of ice.

Cooling Power of Ice. A great deal of cooling can be done with a comparatively small amount of ice. This is due to the latent or "hidden" cold in ice. Thus to convert one pound of ice at 32° F. into water at the same temperature requires 142 units of heat, or, in other words, enough cold is given out to reduce the temperature of 142 pounds of water one degree Fahr.

Construction of Ice House. To keep ice satisfactorily three things are necessary, (1) good drainage at the bottom, (2) good insulation, and (3) abundant ventilation at the top.

Good drainage and insulation at the bottom can be secured by laying an eight-inch foundation of stones and gravel and on top of this six inches of cinders, the whole being underlaid with drain tile. One foot of sawdust should be packed upon the cinders and the ice laid directly upon the sawdust.

Satisfactory walls are secured by using matched boards on the outside of the studs and common rough boards on the inside, leaving the space between the studs empty. The ice should be separated from the walls by one foot of sawdust.

Where no solid foundation walls are provided, earth must be banked around the ice house to prevent the entrance of air along the base.

The space between the sawdust covering on top of the ice and the roof should be left clear. Openings in the

gable ends as well as one or two ventilating shafts projecting through the roof should be provided to insure a free circulation of air under the roof. This will not only remove the hot air which naturally gathers beneath the roof, but will aid in drying the sawdust.

The ice must be packed solidly, using no sawdust except at the sides and bottom of the ice house and on top of the ice when the filling is completed. At least one foot of sawdust must be packed on top of the ice.

Size of Ice House. The size of the ice house will depend, of course, upon the amount of ice to be used. For a herd of 25 cows, in the North, an ice house 10 feet square by 14 feet high will usually answer. These dimensions provide storage for 22 tons of ice, allowing one-foot space all around the ice for sawdust. In the South about 50% more ice is required than in the North.

In calculating the amount of storage space needed for ice, it is necessary to know that one cubic foot of ice at 32° F. weighs 57.5 pounds.

As a matter of convenience in filling and emptying the ice house, doors should be provided in sections from the sill to the gable at one end of the building.

General Uses of Ice. Aside from the use of ice in cooling milk and cream, it can be employed to good advantage in several other ways. Its value in the household, in preserving meats, vegetables, and fruits cannot be overestimated. And what is so refreshing as cold drinks and frozen desserts during the summer months! Ice is also frequently necessary in case of sickness.

Cost of Making Ice. Where ice can be obtained within a reasonable distance, the cost of cutting, hauling, and packing should not exceed \$1.50 per ton.

Source of Ice. Always select the cleanest ice available.

Where the source of ice is at too great a distance from the dairy, an artificial pond should be made upon ground with a reasonably impervious subsoil and with a natural concave formation. If such a piece of ground is flooded with water during the coldest weather, an ample supply of ice will be available in a very short time.

Insulated Ice Houses. The present tendency is to use ice houses with insulation sufficient to dispense with the use of sawdust. With ice houses of this kind, the refrigerator is cooled by circulating the air directly over the ice in the ice house. See Fig. 37½, page 101.

CHAPTER XXXXII.

SEWAGE DISPOSAL FROM DAIRY AND DWELLING.

To secure a high degree of sanitation in and about the dairy house it is necessary to see that proper disposal is made of the sewage from both the dairy and the dwelling. Where the latter is situated close to the dairy house its surroundings may do fully as much harm as those of the dairy itself.

With open privies and the careless dumping of kitchen slops near the dwelling, we have a double means of endangering the dairy. If the ground near the dwelling and privy slopes in the direction of the water supply, the latter is likely to become contaminated through seepage in the manner indicated in Fig. 63. In addition to this there is the danger of flies carrying various kinds of bacteria from these places to the dairy house. Flies not only carry the obnoxious, putrefactive species, but too often also the deadly pathogenic kinds, such as cause typhoid fever, to say nothing of the offensive excrementitious matter conveyed in this manner.

Obviously the accumulation of sewage about the dairy house is attended by practically the same danger as that arising from the unsanitary surroundings of the dwelling. Moreover there is certain to be trouble also from bad odors.

SEPTIC TANK.

The best means of taking care of the sewage from

both the dairy and the dwelling is to run it into a septic tank (see Fig. 73, designed by the author) and from this into a net-work of tile laid underground where it will irrigate and fertilize the soil.

Object of Septic Tank. The main purpose of the tank, as its name indicates, is to thoroughly decompose all organic matter entering it. This is accomplished by numerous species of bacteria, and the tank may be properly designated as a germ incubator. Where the

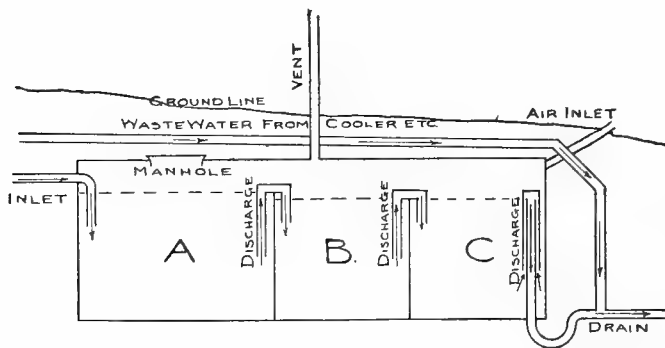

Fig. 73.—Septic Tank.

sewage is emptied into underground tile, the tank also serves as a storage, discharging its contents intermittently. This is necessary to force the liquid to all points of the system and to allow time for each discharge to soak away before the appearance of the next.

Construction of Tank. The general plan of construction is illustrated in Figs. 73 and 74. The tank is located in the ground with the top within a foot or two of the surface. For durability it is preferably constructed of brick, stone or concrete. The tank is so constructed as to

retain all sediment and floating material, since the discharges permit the withdrawal of the liquid from near the middle of the tank only. This is one of the main features of the tank. All inorganic matter entering the tank will gradually settle and, of course, remain in it. Some of the organic matter tends to settle during the first 24 hours,

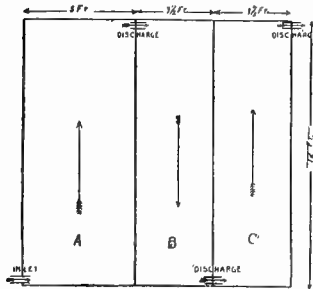

Fig. 74.—Cross Section of Septic Tank.

after which it comes to the surface to be gradually wasted away by the action of bacteria. This wasting away is naturally very slow, and since the slowly gathering organic matter nearly all remains in the first section of the tank, this must be large enough to provide for a considerable accumulation of it.

The tank should be built air tight, except in two places. At the right is an air inlet, consisting of a goose-neck pipe, which renders the vent at the top more effective. This vent consists of a long shaft extending beyond the top of the dairy, thus carrying off the foul gases caused by the decomposition of the material within. One-inch gas pipe, properly fastened, will serve as a satisfactory vent.

In order to afford communication of sections A and C with the vent, the two partitions should not be built quite as high as the tank. There should be at least one inch space between the top of the partitions and the cover.

A 1½-inch gas pipe should be laid over the tank through which the water from the cooler and vats may be discharged directly into the drain. This water

requires no purification and, if conducted through the tank, would necessitate one of too large dimensions. Moreover, the large amount of cold water needed for cooling milk and cream would cool the contents of the tank too much for a rapid decomposition of the material within.

Size of Tank. This must necessarily depend upon the amount of sewage run into it. In general it should have capacity sufficient to hold all of one day's waste in the smallest section (C). It will be noticed from the cut that section A is considerably larger than either of the other two. The reason for this is that nearly all of the inorganic matter remains in the bottom of this part of the tank, while the organic matter, as already stated, gradually accumulates at the surface in this section, in spite of constant decomposition. Where the tank receives the sewage from both the dairy and the dwelling, a tank 12 feet square by $4\frac{1}{2}$ feet deep will be large enough, provided the water used for cooling is not run into it. It is well to remember, however, that the larger the tank used the better the results that may be expected from it.

Flow of Sewage Through Tank. Four-inch tile, carefully laid, may be used to conduct the sewage from the dairy to the tank. A trap is placed near the dairy to shut off the odors coming from the drain. At the point at which the sewage enters the tank it is desirable to attach an elbow with an arm sufficiently long to keep the lower end always in the sewage. This prevents undue mixing of the incoming sewage with that already in the tank, a matter of importance in the successful operation of the tank.

When the sewage in section A has reached the dotted line, it begins to discharge into section B through three-

inch gas pipe as shown in Fig. 73. The liquid is withdrawn from a point near the middle of the tank as indicated by the discharge pipes. The eight-inch space above the discharge permits the accumulation of organic matter. The discharge from 'B into C, is the same as that from A into B; but the discharge pipes are of necessity lower by an amount indicated by the dotted lines. Compartment C discharges intermittently by means of an automatic syphon.

The sewage becomes gradually purified in its passage through the tank, and as it flows from the last section it is nearly as clear as water, but has a slightly sour odor, which it seems to retain and which is in no way objectionable. The purified sewage has been kept for weeks with no sign of the development of putrefactive odors.

The discharges should be arranged as shown in Fig. 65. This arrangement will cause the least mixing of old and new sewage. There is no discharge from A into B until the second day's sewage flows into A. Similarly there is no discharge from B into C until the second discharge into B, etc. The sewage, therefore, requires from three to four days in its passage through the tank.

Cost of Septic Tank. A double partition tank, 12 feet square and $4\frac{1}{2}$ feet deep, constructed of concrete consisting of one part cement, two parts sand and four parts gravel, will cost approximately \$50.00 when the walls are five inches thick.

SEWAGE DISPOSAL FROM DWELLING.

The open privy and the cesspool of kitchen slops are objectionable not only in so far as they affect the dairy house, but also in that they constitute a source of danger to the members of the family in ways entirely disconnected with the milk supply. With the dairy house

already equipped with power to pump and elevate water, there is apparently no reason why the dwelling should not be equipped with a water closet. And with a water closet in the house there would be practically no expense connected with the disposal of the kitchen waste, since this would be discharged directly into the soil pipe connected with the closet. What a convenience such an equipment would afford to the housewife and members of the family!

If the dwelling and dairy house are reasonably close together, one septic tank will answer for both. In such a case the tank is located between the two buildings. Where a great distance separates the buildings, a tank is provided for each and the outlets are brought together as near the tank as possible to save extra expense of tile.

SUBSURFACE IRRIGATION.

While the septic tank sufficiently decomposes the organic matter to leave the sewage from the tank without offensive odors, it is best to run the discharge into a system of underground tile where it will serve as a fertilizer and as an irrigating agent. The tile should be laid below the frost line. In loose soils one foot of tile per gallon of sewage will answer. Clayey soils require two to three times this amount.

Three-inch agricultural drain tile are best adapted for drainage work of this kind, the tile being laid with open joints and with a slope of three or four inches per hundred feet.

It is important that this subsurface irrigating system be located where there is no seepage into the water supply. In places where there is no danger from frost it is best to lay the tile only about one and one-half feet below the surface.

APPENDIX.

Composition of Butter. According to analyses reported by various experiment stations, American butter has the following average composition:

	Per cent.
Water	13
Fat	83
Proteids	1
Salt	3

Composition of Cream. Cream contains all the constituents found in milk, though not in the same proportion. The fat may vary from 8% to 68%. As the cream grows richer in fat it becomes poorer in solids not fat. This is illustrated in the following figures by Richmond:

Total solids.	Solids not fat.	Fat.
Per cent.	Per cent.	Per cent.
32.50	6.83	25.67
37.59	6.14	31.45
50.92	5.02	45.90
55.05	4.65	50.40
57.99	4.17	53.82
68.18	3.30	64.88

The same authority also reports the following detailed analysis of a thick cream:

	Per cent.
Water	39.37
Fat	56.09
Sugar	2.29
Proteids	1.57
Ash38

Composition of Buttermilk. According to Vieth, buttermilk from ripened cream has the following composition:

	Per cent.
Water	90.39
Fat50
Milk sugar	4.06
Lactic acid80
Proteids	3.60
Ash75

Creamery buttermilk should not average above .2% fat.

Composition of Skim-milk. Richmond has found the following average composition of separator skim-milk:

	Per cent.
Water	90.50
Fat10
Milk sugar	4.95
Casein	3.15
Albumen42
Ash78

COMPARISON OF CENTIGRADE AND FAHRENHEIT THERMOMETER SCALES.

Thermometer.	F.	C.
Boiling point (water).....	212	100
Freezing point (water).....	32	0
Difference between boiling and freezing point.....	180	100

From the above it will be seen that one degree Centigrade is equivalent to 9-5 degrees Fahrenheit. Hence the following rules:

1. To change C. into F. reading, multiply by 9-5 and add 32.

$$\text{Example: } 50^{\circ}\text{C} = (50 \times \frac{9}{5}) + 32 = 112^{\circ}\text{F.}$$

2. To change F. into C. reading, subtract 32 and multiply by 5-9.

$$\text{Example: } 182^{\circ}\text{F} = (182 - 32) \times \frac{5}{9} = 83\frac{1}{2}^{\circ}\text{C.}$$

METRIC SYSTEM OF WEIGHTS AND MEASURES.

This system was devised by the French people and has very extensive application wherever accuracy in weights and measures is desired. Some of its equivalents in ordinary weights and measures are given in the following table:

Ordinary weights and measures.	Equivalents in metric system.
1 ounce (av.).....	28.35 grams.
1 quart.....	0.9464 liter.
1 gallon.....	3.7854 liters.
1 fluid ounce.....	29.57 cubic centimeters (c.c.)
1 pound (av.).....	0.4536 kilogram.
1 grain.....	64.8 milligrams.
1 inch.....	2.54 centimeters.
1 foot.....	0.3048 meter.

DETAILED SCORE CARD FOR JUDGING FARM DAIRIES

Owner or lessee of farm
 P. O. address State
 Total number of cows Number milking
 Gallons of milk produced daily
 Product is retained by producer in
 Sold at wholesale to
 For milk supply of
 Permit No. Date of inspection , 191.....
 REMARKS

EQUIPMENT	SCORE	
	Perfect	Allowed
COWS.		
Health	6
Apparently in good health	1
If tested with tuberculin once a year and no tubercu- losis is found, or if tested once in six months and all reacting animals removed	5
(If tested only once a year and reacting animals found and removed, 2.)		
Comfort	2
Bedding	1
Temperature of stable	1
Food (clean and wholesome)	2
Water	2
Clean and fresh	1
Convenient and abundant	1
STABLES.		
Location of stable	2
Well drained	1
Free from contaminating surroundings	1
Construction of stable	4
Tight, sound floor and proper gutter	2
Smooth, tight walls and ceiling	1
Proper stall, tie and manger	1
Light, Four sq. ft. of glass per cow	4
(Three sq. ft., 3; 2 sq. ft., 2; 1 sq. ft., 1. Deduct for un- even distribution.)		
Ventilation: Automatic system	3
Adjustable windows	1
Cubic feet of space for cow, 500 to 1000 feet	3
(Less than 500 ft., 2; less than 400 ft., 1; less than 300 ft., 0; over 1000 ft., 0.)		
UTENSILS.		
Construction and condition of utensils	1
Water for cleaning	1
(Clean, convenient and abundant.)		
Small-top milking pail	3
Facilities for hot water or steam	1
(Should be in milk house, not in kitchen.)		
Milk cooler	1
Clean milking suits	1
MILK ROOM.		
Location of milk room	2
Free from contaminating surroundings	1
Convenient	1
Construction of milk room	2
Floor, walls and ceiling	1
Light, ventilation, screens	1
Total	40

SCORE CARD - Continued.

METHODS	SCORE	
	Perfect	Allowed
COWS.		
Cleanliness of cows.....	8
STABLES.		
Cleanliness of stables.....	6
Floor.....	2	
Walls.....	1	
Ceiling and ledges.....	1	
Mangers and partitions.....	1	
Windows.....	1	
Stable at milking time.....	6	
Barnyard clean and well drained.....	2	
Removal of manure daily to field or proper pit (To 50 ft. from stable, 1.)	2	
MILK ROOM.		
Cleanliness of milk room.....	3
UTENSILS AND MILKING.		
Care and cleanliness of utensils.....	8
Thoroughly washed and sterilized in live steam for 30 minutes.....	5	
(Thoroughly washed and placed over steam jet, 4, thoroughly washed and scalded with boiling water, 3, thoroughly washed, not scalded, 2.)		
Inverted in pure air.....	3	
Cleanliness of milking.....	9
Clean, dry hands.....	3	
Udders washed and dried.....	6	
(Udders cleaned with moist cloth, 4; cleaned with dry cloth at least 15 minutes before milking, 1.)		
HANDLING THE MILK.		
Cleanliness of attendants.....	1
Milk removed immediately from stable.....	2
Prompt cooling (cooled immediately after milking each cow.....)	2
Efficient cooling; below 50° F.....	5
(51° to 55°, 4; 56° to 60°, 2.)		
Storage below 50° F.....	3
(51° to 55°, 2; 56° to 60°, 1)		
Transportation; iced in summer.....	3
(For jacket or wet blanket, allow 2; dry blanket or covered wagon, 1.)		
Total.....	60

Equipment..... + Methods..... =FINAL SCORE.

NOTE 1.—If any filthy condition is found, particularly dirty utensils, the total score shall be limited to 49.

NOTE 2.—If the water is exposed to dangerous contamination or there is evidence of the presence of a dangerous disease in animals or attendants, the score shall be 0.

SCORE CARD FOR SANITARY INSPECTION OF CITY MILK PLANTS

Owner or manager..... Trade name.....

City.....Street and No.....State.....

No. of wagons.....Gallons sold daily { Milk.....
 { Cream.....

Permit or License No..... Date of inspection....., 191..

EQUIPMENT	SCORE	
	Perfect	Allowed
Building:		
Location: Free from contaminating surroundings.....	2
Arrangement.....	6
Separate receiving room.....1		
Separate handling room.....2		
Separate wash room.....1		
Separate sales room.....1		
Separate boiler room.....1		
Construction.....	8
Floors tight, sound, cleanable.....1		
Walls tight, smooth, cleanable.....1		
Ceilings smooth, tight, cleanable.....1		
Provision for light.....1		
Provision for pure air.....1		
Screens.....2		
Minimum of shafting, pulleys, hangers, exposed pipes, etc.....1		
Apparatus.....	20
Boiler.....2		
Hot-water heater.....1		
Milk cooler.....2		
Refrigerator.....2		
Appliances for cleansing utensils and bottles.....2		
Racks, etc., for utensils and bottles after cleaning.....1		
Sterilizer for utensils and bottles.....2		
Bottling and capping machine.....1		
Wash bowl, soap, and towel for attendants.....2		
Protection during delivery.....2		
Condition of apparatus (make deduction for inaccessible parts, open seams, rusty ware, decayed or battered tables or sink, milk-carrying pipes with rough interiors and lack of frequent hand couplings, and for badly worn and poorly repaired material).....4		
Laboratory and equipment.....	2
Water supply.....	2
Clean, fresh.....1		
Convenient and abundant.....1		
Total.....	40

SCORE CARD—Continued.

METHODS	SCORE	
	Perfect	Allowed
Building.....	15
Cleanliness:		
Floors.....	3	
Walls.....	1	
Ceilings.....	2	
Doors and windows.....	1	
Shafting, pulleys, hangers, pipes.....	1	
Freedom from odors.....	2	
Freedom from flies and other insects.....	3	
Drainage.....	2	
Apparatus.....	16
Cleanliness:		
Thoroughly washed and rinsed.....	6	
Sterilized in live steam, thirty minutes (Thoroughly scalded after washing with water over 200° F. or live steam, 3.).....	5	
Bottle caps sterilized.....	3	
Protected from dirt.....	2	
Handling milk.....	16
Received below 50° F. (50° to 55°, 4; 55° to 60°, 3.).....	5	
Rapidity of handling in plant.....	3	
Freedom from undue exposure to air in the plant.....	2	
Capping bottles by machine.....	1	
Bottle top and cap protected by covering.....	2	
Storage 45° F. or below..... (45° to 50°, 2; 50° to 55°, 1.).....	3	
Inspection.....	9
Bacteriological work.....	4	
Inspection of dairies supplying milk..... (Once a year, 1; twice a year, 2; three times a year, 3; four times a year, 4.).....	5	
Miscellaneous.....	4
Cleanliness of attendants..... (General appearance, hands, etc., 1; clean washable clothing, 1.).....	2	
Cleanliness of delivery outfit.....	2	
Total.....	60

Score for equipment..... + score for methods..... = TOTAL SCORE.....

NOTE.—If the conditions in any particular are so exceptionally bad as to be inadequately expressed by a score of "0" the inspector can make a deduction from the total score.

....., Inspector.

RULES AND REGULATIONS RELATING TO THE SALE OF MILK IN NEW YORK CITY.

GRADE A.—FOR INFANTS AND CHILDREN.

GUARANTEED MILK.

Definition. Guaranteed milk is milk produced at farms holding permits therefor from the board of health, and produced and handled in accordance with the following minimum requirements, rules, and regulations:

1. Only such cows shall be admitted to the herd as have not re-acted to a diagnostic injection of tuberculin.
2. All cows shall be annually tested with tuberculin, and all re-acting animals shall be excluded from the herd.
3. No milk from re-acting animals shall be shipped to the city of New York for any purpose whatever.
4. The milk shall not contain more than 30,000 bacteria per c. c. when delivered to the consumer, or at any time prior to such delivery.
5. The milk shall be delivered to the consumer only in sealed bottles which have been sealed at the dairy, and shall be labeled with the day of the week upon which the earliest milking, of which the contents of the bottle form part, has been drawn.
6. The milk shall be delivered to the consumer within 36 hours of the time at which it was drawn.

CERTIFIED MILK.

Definition. Certified milk is milk certified by a milk commission appointed by the Medical Society of the County of New York, or the Medical Society of the County of Kings, as being produced under the supervision and in conformity with the requirements of that commission as laid down for certified milk, and sold under a permit therefor issued by the board of health.

No milk shall be held, kept, offered for sale, or sold and delivered as certified milk in the city of New York, which is produced under requirements less than those for guaranteed milk.

INSPECTED MILK—RAW.

Definition. Inspected milk (raw) is milk produced at farms holding permits therefor from the board of health, and produced and handled in accordance with the following minimum requirements, rules and regulations:

1. Only such cows shall be admitted to the herd as have not re-acted to a diagnostic injection of tuberculin.
2. All cows shall be tested annually with tuberculin, and all re-acting animals shall be excluded from the herd.
3. No milk from re-acting animals shall be shipped to the city of New York for any purpose whatsoever.
4. The farms at which the milk is produced must obtain at least 75 points in an official score of the department of health. These 75 points shall be made up as follows:

A minimum of 25 points for equipment, and 50 points for method.

5. The milk shall not contain more than an average

of 60,000 bacteria per c. c. when delivered to the consumer, or at any time prior thereto.

6. Unless otherwise specified in the permit, the milk shall be delivered to the consumer only in bottles.

SELECTED MILK—PASTEURIZED.

Definition. Selected milk (pasteurized) is milk handled and sold by dealers holding permits therefor from the board of health, and produced and handled in accordance with the following requirements, rules and regulations:

1. The farms at which the milk is produced must obtain at least 60 points in an official score of the department of health. Of these 60 points, a minimum of 20 points shall be required for equipment and a minimum of 40 points for method.

2. All milk of this grade shall be pasteurized, and said pasteurization shall be carried on under a special permit issued therefor by the board of health, in addition to the permit for "Selected Milk (Pasteurized.)"

3. The milk shall not contain more than an average of 50,000 bacteria per c. c. when delivered to the consumer, or at any time after pasteurization and prior to such delivery.

4. Unless otherwise specified in the permit, the milk shall be delivered to the consumer only in bottles.

5. All containers in which pasteurized milk is delivered to the consumer shall be plainly labeled "Pasteurized." Labels must also bear the date and hour when pasteurization was completed, the place where pasteurization was performed, and the name of the person, firm, or corporation performing the pasteurization.

6. The milk must be delivered to the consumers within 30 hours after the completion of the process of pasteurization.

7. No milk shall be pasteurized more than once

8. No milk supply averaging more than 200,000 bacteria per c. c. shall be pasteurized for sale under the designation Selected Milk—Pasteurized.

General Regulations for Grade A.

1. The caps of all bottles containing milk of Grade A shall be white, and shall contain the words "Grade A" in black letters, in large type.

2. If cans are used for the delivery of milk of Grade A, the said cans shall have affixed to them white tags with the words "Grade A" printed thereon in black letters, in large type, together with the designation "Inspected Milk (Raw)" or "Selected Milk (Pasteurized)," as the quality of the contents may require.

GRADE B.—FOR ADULTS.

SELECTED MILK—RAW.

Definition. Selected milk (raw) is milk handled and sold by dealers holding permits therefor from the board of health, and produced and handled in accordance with the following minimum requirements, rules and regulations:

1. Only such cows shall be admitted to the herd as have been physically examined by a regularly qualified veterinarian and declared by him to be healthy, and free from tuberculosis in so far as a physical examination may

determine that fact. Such an examination of all cows shall be made at least once each year.

2. The farms at which the milk is produced must obtain at least 68 points in an official score of the department of health. These 68 points shall be made up as follows: A minimum of 25 points for equipment, and a minimum of 43 points for method.

3. The milk shall not contain an excessive number of bacteria when delivered to the consumer, or at any time prior thereto.

PASTEURIZED MILK.

Definition. Pasteurized milk (Grade B) is milk produced under a permit issued therefor by the board of health, and produced and handled in accordance with the following minimum requirements, rules and regulations and in further accordance with the special rules and regulations relating to the pasteurization of milk:

1. All containers in which pasteurized milk is delivered to the consumer shall be plainly labeled "Pasteurized." Labels must also bear the date and hour when the pasteurization was completed, the place where pasteurization was performed, and the name of the person, firm, or corporation performing the pasteurization.

2. The milk must be delivered to the consumer within 36 hours after the completion of the process of pasteurization.

3. No milk shall be pasteurized more than once.

4. No milk containing an excessive number of bacteria shall be pasteurized.

moved, or from which any part of the water has been removed and to which sugar has been added.

Milk of this designation shall be sold only under a permit issued therefor.

GENERAL RULES AND REGULATIONS.

Permits.

1. A permit for the sale of milk or cream, of any grade or designation, may be granted only after an application has been made in writing on the special blank provided for the purpose.

2. A permit for the sale of milk, of any grade or designation, or of cream, may be granted only after the premises where it is proposed to care for and handle such milk shall have been rendered clean and sanitary.

3. Every permit for the sale of milk, or cream, from places other than wagons shall expire one year from the date of issue.

4. No wagon shall be used for the transportation of milk, condensed milk, or cream, without a permit from the board of health. Every such permit shall expire on the last day of December of the year in which it is granted. A wagon permit for the sale or transportation of milk, condensed milk, or cream shall be conspicuously displayed on the outside of the wagon so that it may be readily seen from the street.

5. Every permit for the sale of milk, of any grade or designation, in a store, shall be so conspicuously placed that it may be readily seen at all times.

6. All stores selling or keeping for sale milk, condensed milk, or cream will be frequently inspected and

scored by a system adopted by the department of health, and the revocation of the permit of any store may ensue if the score is found repeatedly below the required standard.

7. The revocation of a permit may ensue for violation of any of the rules and regulations of the department of health.

8. The revocation of a permit may ensue upon repeated conviction of the holder thereof of the violation of any section of the Sanitary Code relating to the adulteration of milk of any grade or designation.

Sanitary Requirements.

1. Milk, condensed milk, or cream shall not be kept for sale nor stored in any stable or room used for sleeping or domestic purposes, or in any room if in communication with such stable or room, or with watercloset apartments, except when such watercloset apartments are enclosed by a vestibule and are properly ventilated to the external air.

2. Milk, condensed milk, or cream shall not be sold or stored in any room which is dark, poorly ventilated, or dirty, or in which rubbish or useless material is allowed to accumulate, or in which there are offensive odors.

3. The vessels which contain milk, condensed milk, or cream, while on sale, must be so protected by suitable covers and so placed in the store that the milk, condensed milk, or cream will not become contaminated by dust, dirt, or flies.

4. Cans containing milk, condensed milk, or cream

shall not be allowed to stand on the sidewalk or outside of the store door.

5. Milk, condensed milk, or cream must not be transferred from cans to bottles or other vessels on the streets, at ferries, or at railroad depots.

6. Cans in which milk, condensed milk, or cream is kept for sale, shall be kept either in a milk tub, properly iced, or in a clean ice-box or refrigerator in which these or similar articles of food are stored

7. All containers in which milk, condensed milk, or cream is handled, transported, or sold, must be thoroughly cleaned before filling, but such cleaning shall not be done, nor shall such containers be filled in any stable or in any room used for sleeping or domestic purposes, or in any room having connection with such stable or rooms, or with watercloset apartments, except when such watercloset apartments are enclosed by a vestibule and are properly ventilated to the external air.

8. All dippers, measures or other utensils used in the handling of milk, condensed milk, or cream must be kept clean while in use, and must be thoroughly cleaned with hot water and soapsuds directly after each day's use.

9. The ice-box or ice-tub in which milk, condensed milk, or cream is kept, must be maintained in a thoroughly clean condition, and must be scrubbed at such times as may be directed by the department of health.

10. The overflow pipe from the ice-box in which milk, condensed milk, or cream is kept, must not be directly connected with the drain pipe or sewer, but must discharge into a properly trapped, sewer-connected, water-supplied open sink.

11. No person having a contagious disease, or car-

ing for or coming in contact with any person having a contagious disease, shall handle milk.

Labeling.

Each container or receptacle used for bringing milk or cream into the city of New York, from which the said milk or cream is sold directly to the consumer, shall bear a tag stating, if shipped from a creamery, the location of the said creamery and the date of shipment; if shipped directly from a dairy, the location of the said dairy and the date of shipment.

As soon as the contents of such container or receptacle are sold, or before the said container is returned or otherwise disposed of, or leaves the possession of the dealer, the tag thereon shall be removed and kept on file in the store where such milk or cream has been sold for a period of two months thereafter for inspection by the department of health.

Every wholesale dealer in the city of New York shall keep a record in his main office in the said city, which shall show the place or places from which milk or cream, delivered by him daily to retail stores in the city of New York, has been received; and the said record shall be kept for a period of two months for inspection by the department of health, and shall be readily accessible to the inspectors of the said department.

Pasteurization.

1. Milk, which has been subjected to the action of heat commonly known as "pasteurization," shall not be held, kept, offered for sale, or sold and delivered in the

city of New York, unless the receptacle in which the same is contained is plainly labeled "Pasteurized."

2. Only such milk or cream shall be regarded as pasteurized as has been subjected to a process in which the temperature and exposure conform to one of the following: See page III.

3. The milk after pasteurization must be at once cooled and placed in clean containers, and the containers immediately closed.

4. The said term "pasteurized" shall only be used in connection with the milk classified as "Grade A: selected Milk (Pasteurized)" and "Grade B: Pasteurized," or cream obtained from such milk.

5. Milk or cream which has been heated in any degree will not be permitted to be sold in New York City unless the heating conforms with the requirements of the department of health for the pasteurization of milk or cream.

6. Applications for permits to pasteurize milk or cream will not be received until all forms of apparatus connected with the said pasteurization have been tested and the processes approved by the board of health.

STORCH'S TEST.

This test makes it possible to determine whether milk, cream, skimmilk or buttermilk has been heated to 176° F. or above. It is made as follows: Put one teaspoonful of milk into a test tube, add one drop of 2% solution of peroxid of hydrogen and two drops of 2% solution of paraphenylenediamin; shake the mixture; if a dark violet color promptly appears, the milk has not been heated to 176° F.

De Laval Milk Clarifier

Next to the Cream Separator the most important invention in the history of Dairy progress—*Statement of a National Dairy Authority.*

☞ Milk clarified with the De Laval Milk Clarifier will keep sweet longer than milk not so treated.

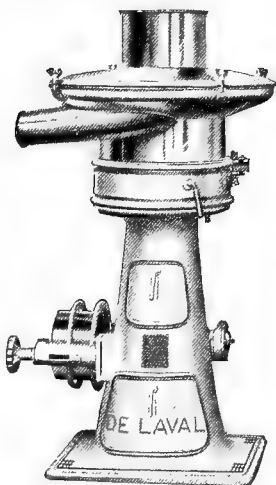

DE LAVAL MILK CLARIFIER—
Belt driven. Capacities 8,000 or 12,000
pounds per hour. Also furnished with
steam turbine drive with same capacities.

☞ Removes all free dirt, cow hairs and other objectionable foreign matter from milk, rendering it more wholesome and by the same token making it more marketable.

☞ The general introduction of these machines will greatly increase the consumption of milk.

☞ Requires less than one horse power to operate the 12,000 lbs. per hour machine and it requires but little attention.

☞ Large milk dealers, condenseries and cheese factories will find it greatly to their advantage to investigate the merits of this machine.

SEND FOR COMPLETE CATALOG

De Laval Separator Company

165 Broadway, NEW YORK

29 E. Madison St., CHICAGO

INDEX.

Page		Page
Acid measures, sulphuric		52
Acids tests for milk and cream.		83
Acid test, rapid, for milk and cream		87
Aeration of milk and cream...		39
Air, dust free		35
Albumen		13
Albumenoids		12
Appendix		349
Ash		13
Babcock test		48
apparatus for		50
Babcock tester, calculating speed of		57
Babcock testers		49, 58
Babcock test, making a		53
sample for		48
Bacteria, description of		20
Bacterial counts		232
Barn, sanitary		30
Bedding, clean		36
Bitter fermentation		25
Boiler and its management		326
Boiler, care of		332
firing of		330
pointers on		331
scale		334
Boric acid, detection of.....		195
Bottles as disease carriers.....		234
Bottling milk		122
Bulgaricus, bacillus		150
preparation and propaga- tion		150
Butter, composition of.....		349
dairy, marketing of.....		271
as a side line.....		133
granules		255
judging		202
marketing, creamery		267
dairy		271
overrun		274
Butter packages, paraffining....		265
packing of		263
salting of		255
score card		203
washing of		255
working of		258
Butterfat		9
composition of.....		10
globules		7, 9, 19
physical properties of.....		9
Buttermaking		239
Buttermilk, composition of....		350
Butyric fermentation		24
Cans, shipping		129
Casein		12
Certified milk		183
Cheddar cheese making.....		278
cheese, marketing of		272
Cheese, cheddar, judging of....		207
making		278
club		180
cottage		175
cream		180
factory dividends		295
neufchatel		178
paraffining		283
pimento		182
ripening of		282
score card		208
whey or ricotta		181
Churning		249
conditions influencing		249
difficult		260
operations		253
Churns, cleaning		260
City milk plants		320
City milk supply		226
Cold storage		97
air, forced circulation		99
anteroom for		97
insulation		98
natural circulation in.....		100

	Page		Page
Coloring butter	254	Cream tickets	220, 225
Colostrum milk	14	weighing, at creamery.....	69
Composite sampling	59	at farm	68
Coolers, milk and cream	41	Creamery dividends	287
Cooling milk and cream	39	floor plan for	270
Cottage cheese	175	statement	293
marketing	178	Creaming	90
methods of manufacture	175	centrifugal	92
packing	177	gravity	90, 91
Cows, clean	31	processes of	90
Cream, acid tests for.....	83	Cultured milk	147
aging	167	Curdling and digesting fermen-	
bottles, Babcock	50, 71, 72	tation	23
bottles, calibrating	57	Curd test, Wisconsin	191
cheese making	180	Dairy houses	312
composition of	349	Dirt, detection of	195
cooling of	39	Dividends	287
detection of taints in.....	190	Eggs as a side line	133
frequency of testing	70	Farrington's acid test.....	85
judging of	200	Fat globules	19
keeping account of	220	Fats, insoluble	11
pasteurization	104	soluble	12
regulating richness of	94	Fermentation test, Gerber	194
rich, advantages of.....	94	Flies	37
ripening	239	Fore-milk	36
control of	244	Formaldehyde, detection of....	196
methods of	241	Gassy fermentation	27
natural	242	Homogenizer	167
object of.....	239	Ice box	102
pasteurized	242	Ice cream, aging cream for...167	
starter	243	chocolate	162
ripeners	247	condensed milk for	168
samples, necessity of weigh-		cost of	165
ing	70	freezing process	158
sample, preparing of.....	73	fruit ice cream	163
samplers	66	lemon	162
samples, composite	64	making of	157
sampling	65	marketing	166
at creamery	69	nut	163
at farm	68	packing	163
scales	53, 71, 72	plants	323
shipping	128	swell in	165
standardizing	125		
standards for cities	233		
straining	254		
tests, making of	73		
reading of	73		

	Page		Page
Ice cream, use of gelatin in....	164	Milk, detection of taints in....	190
vanilla	161	gassy, in cheese making ..	283
Ice house, construction of....	340	heating before separating..	95
insulated	101	houses (see dairy houses)	
Ice supply	339	fermentations	20
Injector	328	from different breeds	17
Inspection at farm	228	judging of	200
in city	226	inspection at farm.....	229
Insulation, cold storage.....	98	keeping account of	220
Judging butter	202	microscopic appearance of..	7
cheddar cheese	207	modified	170
milk and cream	200	preparation of	171
Lactic acid cultures.....	135	modifying in home	218
Lactic fermentation	22	overripe, in cheese making..	285
Lacto	169	pail sanitary	33
Lactometer and its use.....	75, 76	paying for at creameries..	292
Manns' acid test	84	pasteurization of	104
Marketing butter	263	physical properties of.....	7
cheese	272	plants	320
dairy butter	271	preservatives	60
milk and cream	121	rules and regulations for..	356
pointers on	117	samplers	61
Metric system.....	351	sanitary production of	29
Milk, acid tests for.....	83	score cards	200
adulterations	236	secretion	14
bottle, Babcock	50	selling on fat basis	211
bottles, calibrating	56	shipping	128
bottling	122	skimming, detection of ..	80
buying on fat basis.....	211	specific gravity of.....	8
care of in home.....	216	solids	77
certified	183	calculation of.....	79
city, temperature and age		standardizing of	125
regulations for.....	235	standards for cities	233
colostrum	14	straining of	35
composition of	8	sugar	13
cooling of	39	supply, control of city ..	226
cultured	147	tickets	220, 225
as a side line	133	tests, reading of.....	54
marketing	152	value, compared with its	
method of manufacture..	149	products	186
therapeutic value of..	147	variations in quality of ..	15
value as a drink	149	watering of	80
detection of dirt in	197	Modified milk	170
detection of preservatives		Neufchatel cheese	178
in	195	methods of manufacture..	178
		packing and marketing ..	179

	Page		Page
Overrun, butter	274	Side lines	132
ice cream	165	Skimmilk bottle	51
Pimento cheese making	182	Skimmilk—Buttermilk, manufac- ture of	154
Pipette	52	as a side line.....	134
Preservatives, detection of.....	195	Skimmilk, composition of.....	350
Preservatives, for composite samples	60	Skimming milk, detection of ..	80
Packing butter	263	Slimy or ropy fermentation ...	26
Pasteurization	104	Standardizing milk and cream.....	125
advantages of, in butter making	242	Starters	135
for milk and cream.....	104	commercial	138
growing popular	105	preparation of	138
held process	111	mother	143
home	217	natural	136
necessity of clean milk for.....	112	natural vs. commercial.....	139
objections to flash process	106	Steam	329
of milk and cream	104	wet and dry	336
processes	106	Sterilizing vessels	308
Pasteurized milk, low tem- perature for	112	Strainers	35
Pasteurizing chart	107	Straining cream	254
in bottles	114	Straining milk	35
regulations	111	Test bottles, cleaning of	56
Refrigeration, mechanical	296	Tester, Babcock	49, 58
Refrigerator connected with ice house	101	sediment	197
ice box end	100	Testing composite samples ...	63
Ricotta cheese making	181	cream	65, 70
Salicylic acid, detection of.....	196	milk	48
Salting butter	255	Testjars	64
Samplers, cream	66	Themometer scales	350
Samples, taking milk.....	59	Titration	83
Sampling, composite	59	Toxic fermentations	27
cream	65	Tubercule bacilli in milk	231
Sanitary milk production	29	Tuberculin test	229
Score card for butter	203	benefits of	231
for cheese	208	Vanilla beans	160
for city milk plants	354	flavor	159
for farm dairies	352	Vessels as disease carriers.....	234
for milk and cream	200	clean	32
Sediment tester	197	washing of	306
Separators, fastening	95	Viscogen	113
Septic tank	343	Washing butter	255
Sewage disposal	343	vessels	306
Shipping cans	129	Wash sinks	306
milk and cream	128	Water supply	337
		Whey cheese (see ricotta cheese)	
		Wisconsin curd test	191

The Vilter Manufacturing Co.

(Established 1867)

877 Clinton Street ::: MILWAUKEE, WIS.

"THE CREAM CITY"

Builders of **CORLISS STEAM ENGINES**

Any horse power, Girder or Heavy Duty Type for Belted or Direct Connected Service. Medium or high speed, Vertical or Horizontal *Slide Valve Engines*, any size, *Boilers, Heaters, Pumps, Etc.*

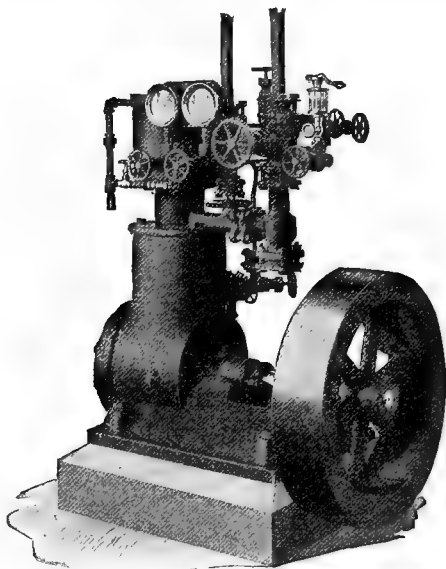

Vertical Single-Acting Refrigerating Machine for Belt Drive

REFRIGERATING MACHINERY

Vertical or Horizontal, for Dairies, Creameries, Ice Cream Plants, Cold Storage Houses, Markets or for Ice Making. Catalogs upon application.

If interested in above machine ask for Bulletin H.-16

Torsion Balance

CREAM AND BUTTER Test Scales

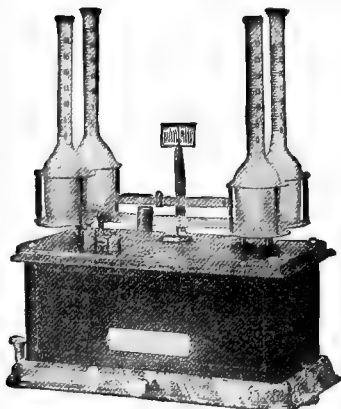

N21530

Style 1530

FOUR-BOTTLE CREAM TEST SCALE. Used with Babcock test. We make scales for one, two and twelve bottles.



N21700

Style 1700

BUTTER MOISTURE TEST SCALE. Percentage read direct from beams. No figuring. No small weights.

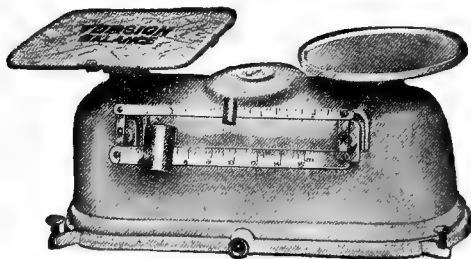

N2779

Style 779

BUTTER PRINT SCALE for weighing pound prints. No weights required.

We make
Special
Scales for
Special
Purposes

Our scales are
sold by all
leading
jobbers.

The Torsion Balance Company

Office

92 Reade St., NEW YORK





Factory

147-9 Eighth St., JERSEY CITY, N. J.



The **C.P. LINE**



*For Dairy Farmers, Milk
Dealers, Creamerymen, Ice
Cream Makers and all who
produce and deal in Dairy
Products*    

YOU cannot meet modern demands with out-of-date equipment. Take advantage of our 25 years' experience designing and manufacturing the highest grade appliances for dairymen. C. P. equipment puts you in position to get top prices and the cream of the trade.

Drop a line to our nearest office for a copy of our complete catalog—filled with descriptions of modern, efficient and economical machinery and the highest quality supplies.

**The Creamery Package Mfg.
Company :: :: Chicago, Ill.**

Philadelphia, Pa.
Waterloo, Ia.

Omaha, Neb.
Kansas City, Mo.

Minneapolis, Minn.
Albany, N. Y.

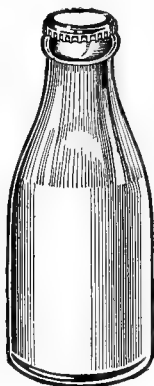

The Dacro Crown

Makes an hermetically sealed milk bottle possible—insures continued cleanliness after filling and crowning—facilitates transportation and refrigeration—makes tampering with the contents of the bottle impossible without immediate detection by dairyman or consumer—provides a seal, which, after its initial removal from the bottle, is sufficiently intact for use as an odor proof temporary covering for the bottle while any portion of its contents remains—deters bacterial development—permits the accomplishment of pasteurization within the bottle.

Manufactured by
The Crown Cork & Seal Co.
Baltimore, U. S. A.

Michels' "Creamery Buttermaking"

==== And ====

Michels' "Dairy Farming"



Standard Text Books

