

RURAL TEXT-BOOK  
SERIES



SOUTHERN  
FIELD  
CROPS



J. F. DUGGAR

L. H. BAILEY  
EDITOR

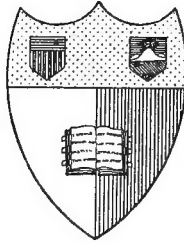

New York  
State College of Agriculture  
At Cornell University  
Ithaca, N. Y.

---

Library

Cornell University  
**SB 185.D8**

**Southern field crops (exclusive of forag**



3 1924 003 042 078

012004



THE MACMILLAN COMPANY  
NEW YORK · BOSTON · CHICAGO  
SAN FRANCISCO

MACMILLAN & CO., LIMITED  
LONDON · BOMBAY · CALCUTTA  
MELBOURNE

THE MACMILLAN CO. OF CANADA, LTD.  
TORONTO

# SOUTHERN FIELD CROPS

(EXCLUSIVE OF FORAGE PLANTS)

BY

JOHN FREDERICK DUGGAR

DIRECTOR OF THE ALABAMA AGRICULTURAL EXPERIMENT STATION  
AND PROFESSOR OF AGRICULTURE IN THE ALABAMA  
POLYTECHNIC INSTITUTE

New York

THE MACMILLAN COMPANY

1916

*All rights reserved*

COPYRIGHT, 1911,

BY THE MACMILLAN COMPANY.

---

Set up and electrotyped. Published April, 1911. Reprinted  
September, 1911; November, 1912; September, 1913; September,  
1914; April, 1915; September, November, 1916.

Norwood Press

J. S. Cushing Co. — Berwick & Smith Co.  
Norwood, Mass., U.S.A.

To

MY PARENTS

DR. REUBEN HENRY DUGGAR

AND

MARGARET LOUISA (MINGE) DUGGAR

THIS BOOK

IS AFFECTIONATELY INSCRIBED

AS A SLIGHT TOKEN OF APPRECIATION OF

THEIR HIGH IDEALS AND CAREFUL

PARENTAL TRAINING



# Cornell University Library

The original of this book is in  
the Cornell University Library.

There are no known copyright restrictions in  
the United States on the use of the text.



## EDITOR'S PREFACE

THERE are many types of text-books in agriculture. Three types have now found their places in The Rural Text-Book Series: One type, represented by Warren's "Elements of Agriculture," expounds the general basis and practice of the agricultural pursuit; another type, represented in Lyon and Fippin's "Principles of Soil Management," presents in detail one of the large fundamental subjects; and another type, represented in the present volume, explains the reasons and practices underlying the raising of particular crops.

These three honest books also represent three ranges of presentation: the Warren, a high school method; the Lyon and Fippin, a distinctly college method; and the Duggar, an intermediate method, designed for both advanced high school and college.

A book may be adapted at the same time to college work and to reading and reference by the best farmers. The practicing farmer is increasingly requesting books that give him real reasons and real facts. Text-books will increase in use among farmers, not only among those farmers who have had college instruction, but also with those who have come to their work by other routes, but who desire to proceed substantially. These text-books open new fields of observation. How many farmers really know how the roots of the wheat plant look, or what is their mode of growth, or how these roots compare with those of oats? How many know

the form and features in detail of the leaves of wheat and barley and oats and rye? And yet all good farming rests on good observation, and on sound reasoning from the facts and phenomena that one observes.

I have been struck with the suggestions for original and painstaking observation that the pages of this book contain. It presents a type of teaching method that was well put in book form by Hunt in his "Cereals in America," — the method that sends the learner directly to the plant in the field, to make careful observation from tip of root to tip of top. Most farmers do not even yet really know the plants that they till. This volume by Duggar will discover his cotton and his cane to many a man who long has grown them, but who has known them not. These makers of observation text-books, that present the crops and the animals in their real and living details, will set going a great quiet movement to examine minutely the conditions of agricultural failure and success.

L. H. BAILEY.

## AUTHOR'S SUGGESTIONS TO TEACHERS AND ACKNOWLEDGMENTS

THIS book has been prepared to fill the needs of two classes of individuals, — students desiring a full and practical, yet logical and pedagogical treatment of the staple crops of the South, and farmers seeking a simple presentation of the scientific principles underlying agriculture, together with a condensed statement of the results of recent experiments and experience.

Scientific terms have been excluded, except when demanded by accuracy and clearness, so that farmers having no training in the use of such terms may be able to read the volume understandingly. The meaning of every unfamiliar term may be found in the glossary. Farmers will usually omit the reading of the Exercises except when pursuing a course of instruction, as in some study-center, or short-course, or correspondence-course.

As a text-book, this volume is intended especially to serve for classes in high-schools and normal schools. It is also intended to constitute an outline of the subject for college use. In high-school classes, it is expected that the teacher will direct the students to omit all the matter printed in small type, all technical names in parentheses, and such of the exercises as deal with crops of which specimens cannot be found in the neighborhood.

For high-school use, the matter may be further abridged by the omission of the study of those particular crops that are unsuited to the locality.

College students are expected to prepare all the matter in this book, including that in fine print, and all Exercises. Their instructors will probably assign additional work on the crops of chief interest to the locality. These additions will usually take the form of supplementary lectures and of collateral reading selected from the literature cited under each crop.

It is scarcely necessary to point out that the use of a text-book to afford at least the outline of the subject-matter on crops will enable the student to cover much more ground than would be possible if he relied exclusively on lecture notes. The use of a text-book is also advantageous to the instructor, since it permits him to devote a larger proportion of his time to supplementary lectures, which will direct increased attention to local problems and practices, suggest methods of agricultural investigation, and discuss the most effective methods of teaching the subject of agriculture.

The author desires to express his thanks to the numerous friends who have assisted him in this work, and especially to the following: To Messrs. C. A. Cauthen, H. P. Agee, W. R. Dodson, J. N. Harper, and C. R. Ball for reading the manuscript of certain chapters; and to Dr. L. H. Bailey for editorial work and for the use of certain illustrations from his *Cyclopedia of American Agriculture*.

Grateful acknowledgment is made to Dr. W. E. Hines for a number of photographs of insects; to Professor L. N. Duncan for making the photographs of corn ears; and to Miss C. M. Cook, who made most of the drawings prepared especially for this book. In the List of Illustrations credit

*AUTHOR'S PREFACE AND ACKNOWLEDGMENTS* xi

is given in detail to the U. S. Department of Agriculture and to those Experiment Stations that contributed photographs for this volume.

J. F. DUGGAR.

AUBURN, ALABAMA,  
January 2, 1911.



# CONTENTS

## CHAPTER I

	PAGES
OATS — <i>Avena sativa</i> . . . . .	1-31
Structure, 1 ; Varieties, 6 ; Climate, Soils, and Fertilizers, 13 ; Cultural Methods, 16 ; Enemies, 23 ; Laboratory Exercises, 29 ; Literature, 31.	

## CHAPTER II

WHEAT — <i>Triticum sativum</i> . . . . .	32-67
Structure and Composition, 32 ; Species and Varieties, 40 ; Soils, Rotation, and Fertilizers, 45 ; Preparation and Sowing, 50 ; Harvesting, 58 ; Enemies, 59 ; Laboratory Exercises, 64 ; Literature, 67.	

## CHAPTER III

RYE AND BARLEY . . . . .	68-77
Rye — <i>Secale cereale</i> . . . . .	68
Barley — <i>Hordeum sativum</i> . . . . .	74
Laboratory Exercises, 77 ; Literature, 77.	

## CHAPTER IV

CORN OR MAIZE — <i>Zea mays</i> . . . . .	78-97
Structure, 80 ; The Corn Grain or Kernel, 92 ; Laboratory Exercises, 95 ; Literature, 97.	

## CHAPTER V

CORN — COMPOSITION AND JUDGING . . . . .	98-111
Judging Corn, 101.	
Laboratory Exercises, 102 ; Literature, 111.	

	PAGES
<b>CHAPTER VI</b>	
CORN—RACES AND VARIETIES . . . . .	112-126
Laboratory Exercises, 125 ; Literature, 126.	
<b>CHAPTER VII</b>	
CORN—BREEDING OR IMPROVEMENT . . . . .	127-149
Laboratory Exercises, 148 ; Literature, 149.	
<b>CHAPTER VIII</b>	
CORN—SOILS, ROTATIONS, AND FERTILIZERS . . . . .	150-157
Soils, 150 ; Rotation, 151 ; Fertilizers, 153 ; Laboratory Exercises, 157 ; Literature, 157.	
<b>CHAPTER IX</b>	
CORN—THE TILLAGE OR CULTIVATION . . . . .	158-188
Laboratory Exercises, 188 ; Literature, 188.	
<b>CHAPTER X</b>	
CORN—HARVESTING . . . . .	189-205
Laboratory Exercises, 204 ; Literature, 205.	
<b>CHAPTER XI</b>	
CORN—ENEMIES . . . . .	206-216
Insects, 206 ; Fungous Diseases, 214 ; Laboratory Exercises, 216 ; Literature, 216.	
<b>CHAPTER XII</b>	
RICE— <i>Oryza sativa</i> . . . . .	217-230
Laboratory Exercises, 229 ; Literature, 230.	



## CHAPTER XIII

	PAGES
THE SORGHUMS — <i>Andropogon sorghum</i> . . . . .	231-247
The Sorghums in General, 231; Saccharine or Sweet Sorghums, 234; Kafir, 239; Milo, 240; Broom Corn, 244; Laboratory Exercises, 245; Literature, 246.	

## CHAPTER XIV

COTTON — STRUCTURE AND GENERAL CHARACTERISTICS . . . . .	248-266
Laboratory Exercises, 265; Literature, 266.	

## CHAPTER XV

COTTON — COMPOSITION AND THE PRINCIPAL USES . . . . .	267-273
Laboratory Exercises, 273; Literature, 273.	

## CHAPTER XVI

COTTON — THE PRINCIPAL SPECIES . . . . .	274-281
Laboratory Exercises, 281; Literature, 281.	

## CHAPTER XVII

COTTON — VARIETIES OF AMERICAN UPLAND . . . . .	282-299
Laboratory Exercises, 299; Literature, 299.	

## CHAPTER XVIII

COTTON BREEDING . . . . .	300-314
Laboratory Exercises, 313; Literature, 314.	

## CHAPTER XIX

COTTON — SOILS AND FERTILIZERS . . . . .	315-340
General Considerations on Fertilizing Cotton, 315; Nitrogenous Fertilizers, 325; Phosphatic Fertilizers, 329; Potash Fertilizers, 332; Miscellaneous Fertilizers and Effects of Fertilizers, 335; Laboratory Exercises, 339; Literature, 339.	

	PAGES
CHAPTER XX	
COTTON—THE CULTIVATION OF THE AMERICAN UPLAND GROUP	341-360
Laboratory Exercises, 360 ; Literature, 360.	
CHAPTER XXI	
COTTON—HARVESTING AND MARKETING . . . . .	361-376
Laboratory Exercises, 376 ; Literature, 376.	
CHAPTER XXII	
COTTON—HISTORY AND STATISTICS . . . . .	377-387
Laboratory Exercises, 387 ; Literature, 387.	
CHAPTER XXIII	
COTTON—INSECT ENEMIES . . . . .	388-410
Cotton Boll-worm, 388 ; Mexican Cotton Boll-weevil, 392 ; Insects of Minor Importance, 407 ; Laboratory Exercises, 410 ; Literature, 410.	
CHAPTER XXIV	
COTTON—FUNGOUS AND OTHER DISEASES . . . . .	411-420
Laboratory Exercises, 420 ; Literature, 420.	
CHAPTER XXV	
HEMP— <i>Cannabis sativa</i> . . . . .	422-424
Laboratory Exercises, 424 ; Literature, 424.	
CHAPTER XXVI	
SWEET-POTATO— <i>Ipomœa batatas</i> . . . . .	425-456
Composition and Uses, 428 ; Varieties, 431 ; Soils, Fer- tilizers, and Rotation, 434 ; Cultural Methods, 438 ; Har- vesting and Storing Sweet-potatoes, 447 ; Enemies, 452 ; Laboratory Exercises, 455 ; Literature, 455.	

## CHAPTER XXVII

	PAGES
CASSAVA — <i>Manihot utilissima</i> . . . . .	457-462
Laboratory Exercises, 462 ; Literature, 462.	

## CHAPTER XXVIII

PEANUT — <i>Arachis hypogæa</i> . . . . .	463-483
Laboratory Exercises, 482; Literature, 483.	

## CHAPTER XXIX

SUGAR-CANE — <i>Saccharum officinarum</i> . . . . .	484-522
Composition, 492 ; Soils and Fertilizers, 494 ; Cultural Methods, 499 ; Varieties, 506 ; Harvesting and Uses, 508 ; Sirup Making, 515 ; History and Statistics, 518 ; Enemies, 520 ; Laboratory Exercises, 522 ; Literature, 522.	

## CHAPTER XXX

TOBACCO — <i>Nicotiana tabacum</i> . . . . .	523-547
Cultural Methods, 530 ; Harvesting and Curing, 539 ; Enemies, 545 ; Laboratory Exercises, 546 ; Literature, 547.	
GLOSSARY . . . . .	549
INDEX . . . . .	563



## LIST OF ILLUSTRATIONS

FIG.	PAGE
1. Part of an Oat Plant, showing the Absence of Clasps . . . . .	2
2. A Panicle of Oats . . . . .	3
3. Oak Spikelet in Bloom. (L. H. Bailey) . . . . .	4
4. Spikelets of Red Rust-proof Oats . . . . .	7
5. A Panicle of Red Rust-proof Oats . . . . .	8
6. Burt Oats . . . . .	10
7. Spikelets of Burt Oats . . . . .	11
8. Oats destroyed by Smut . . . . .	23
9. Green-bug ( <i>Toroptera graminum</i> ). (S. J. Hunter) . . . . .	25
10. Two Stages of a Lady-bug which destroys Green-bugs. (S. J. Hunter) . . . . .	25
11. Oats and Wheat grown with Crimson Clover. (Alabama Experiment Station) . . . . .	27
12. Part of a Young Wheat Plant . . . . .	34
13. Floret of Wheat. (L. H. Bailey) . . . . .	35
14. A Head, Spikelet, and Grain of Bearded Wheat . . . . .	36
15. A Typical Head of Beardless Wheat . . . . .	37
16. A Good Sample of Wheat. (California Experiment Station)	38
17. Heads of Wheat . . . . .	41
18. Heads of Wheat . . . . .	42
19. Shocks of Wheat from Equal Areas. (Alabama Experiment Station) . . . . .	49
20. Double-disk Grain Drill . . . . .	54
21. Loose Smut of Wheat . . . . .	62
22. The Angoumois Grain-moth. (W. E. Hinds) . . . . .	63
23. Heads of Southern Rye . . . . .	69
24. Part of a Young Rye Plant, showing the Small Clasps of the Leaves . . . . .	70
25. A Mixture of Rye and Crimson Clover . . . . .	72
26. Ergot in a Head of Rye. (L. H. Bailey) . . . . .	73

FIG.	PAGE
27. A Head and Grains of Bearded Barley . . . . .	74
28. The Large Clasps of Barley Leaf . . . . .	75
29. Head and Spikelet of Beardless Barley . . . . .	76
30. Roots of Corn 47 Days after Level Planting. (Kansas Ex- periment Station) . . . . .	79
31. Showing Roots of Corn 47 Days after Planting in Deep Furrows. (Kansas Experiment Station) . . . . .	81
32. Brace-roots on the Corn Plant . . . . .	82
33. Part of a Corn Leaf showing Wavy Margins . . . . .	84
34. An Ear of Corn on which Leaf-blades are borne on the Tips of many of the Shucks . . . . .	85
35. Differences in Height and Position of Ear in the Same Va- riety . . . . .	87
36. Diagram showing Course of the Pollen-tube from Silk to Ovary. (C. S. Ridgway) . . . . .	89
37. The Embryo-sac of Corn at the Time of Fertilization. (F. E. Lloyd) . . . . .	90
38. A Well-proportioned Ear of a Hard Yellow Variety . . . . .	91
39. Transverse Section through Corn Grains . . . . .	94
40-45. Ears of Henry Grady Corn to be criticized by pupils. (L. N. Duncan) . . . . .	102-103
46-57. Ears of Corn with Various Defects. (L. N. Duncan)	104-107
58. Ear with Long, Well-formed Grains . . . . .	108
59. Ear with Short Grains . . . . .	108
60. An Ear having too much Space between Grains near the Cob . . . . .	108
61. An Ear in which there is no Lost Space between Grains near the Cob . . . . .	108
62. Showing Variations among Corn Grains . . . . .	109
63. Various Shapes of Corn Kernels. (Michigan Experiment Station) . . . . .	110
64. Sections across Grains of Dent, Flint, Pop, Sweet, and Soft Corn . . . . .	112
65. Longitudinal Sections through Grains of Dent, Flint, Pop, Sweet, and Soft Corn . . . . .	113
66. Showing an Ear with Tip well covered by Shucks . . . . .	115
67. Showing an Ear Tip not well covered by Shucks . . . . .	115

*LIST OF ILLUSTRATIONS*

xxi

FIG.	PAGE
68, 69. Varieties of Corn. (Alabama Experiment Station)	123, 124
70. Showing the Immediate Effects of crossing a White Pop Corn with Pollen from a Yellow Dent Corn . . . . .	127
71. Relative Yields of the Same Variety of Corn from 2 Breed- ing Rows of the Same Length. (Oklahoma Experiment Station) . . . . .	132
72. Diagram showing Arrangement of Rows in Corn Breeding- plot . . . . .	134
73. Germinator made from a Soap Box. (Office of Experiment Stations, U. S. Dept. Agr.) . . . . .	139
74. Showing Injury from In-breeding Corn. (U. S. Department of Agriculture) . . . . .	141
75. Showing Larger Yield on Row not In-bred. (U. S. Depart- ment of Agriculture) . . . . .	141
76. Young Corn Plants, from Tip, Middle, and Butt Kernels. (Michigan Experiment Station) . . . . .	146
77. A Stalk-cutter. (B. F. Avery & Sons Co.) . . . . .	158
78. A Subsoil Plow. (L. H. Bailey) . . . . .	163
79. A Turn-plow . . . . .	164
80. A Disk-plow. (B. F. Avery & Sons Co.) . . . . .	165
81. Combined Lister and Corn Planter. (U. S. Department of Agriculture) . . . . .	165
82. A One-row Corn Planter. (B. F. Avery & Sons Co.) . . . . .	167
83. Diagram of Young Corn Plants . . . . .	168
84. Hand Corn Planter, for Replanting . . . . .	169
85. A Spike-tooth Harrow. (B. F. Avery & Sons Co.) . . . . .	171
86. A Weeder. (L. H. Bailey) . . . . .	172
87. A One-horse, Spring-tooth Harrow. (B. F. Avery & Sons Co.) . . . . .	173
88. Check-row Corn Planter with Double Disks to open a Deep Furrow. (U. S. Department of Agriculture) . . . . .	175
89. Cowpeas growing between Rows of Corn . . . . .	182
90. The Williamson Method of Corn Culture . . . . .	186
91. Condition of Surface after "Laying by" Corn according to the Williamson Plan . . . . .	187
92. Showing "Throw-board" on Wagon-body used in Harvest- ing Corn. (Oklahoma Experiment Station). . . . .	190

FIG.	PAGE
93. Shocking Horse . . . . .	194
94. Corn well Shocked. (Oklahoma Experiment Station) .	196
95. Sled Corn Cutter, with Automatic Knife Guards. (U. S. Department of Agriculture) . . . . .	197
96. A Home-made Sled Corn Cutter. (U. S. Department of Agriculture) . . . . .	197
97. A Corn Harvester. (International Harvester Co.) . . .	199
98. Corn Husker and Shredder at Work. (L. H. Bailey) . .	200
99. A Field of Corn in Alabama that yielded 103½ Bushels per Acre. (Farmer's Coöperative Demonstration Work) .	203
100. The Budworm of Corn ( <i>Diabrotica 12-punctata</i> ). (After Chittenden) . . . . .	206
101. Eggs of Corn Ear-worm on Corn Silks. (A. L. Quaintance, U. S. Dept. Agr., Bureau of Entomology) . . . . .	208
102. The Corn Ear-worm at Work in the Tip of an Ear of Green Corn. (A. L. Quaintance, U. S. Dept. Agr., Bureau of Entomology) . . . . .	209
103. The Corn Ear-worm preying on the Tender Leaves of Corn. (A. L. Quaintance, U. S. Dept. Agr., Bureau of Entomology) . . . . .	210
104. The Rice Weevil, most Destructive in Stored Corn. (Photo by W. E. Hinds) . . . . .	211
105. An Ear of Corn injured by Weevils. (Photo by W. E. Hinds) . . . . .	212
106. Larva of Angoumois Moth in a Grain of Corn. (Photo by W. E. Hinds) . . . . .	213
107. The Indian Meal Moth. (Photo by W. E. Hinds) . . .	214
108. Corn Smut. (L. H. Bailey) . . . . .	215
109. Bundles of Two Varieties of Rice . . . . .	218
110, 111. Two Types of Rice. (L. H. Bailey) . . . . .	220
112. Preparing for Rice in Louisiana. (Louisiana Experiment Station) . . . . .	222
113. An Experimental Field of Rice at Crowley, La. (Louisiana Experiment Station) . . . . .	224
114. A Rice Field after Harvest. (Louisiana Experiment Station) . . . . .	227
115. Heads of Amber Sorghum and of Red Kafir . . . . .	234



FIG.	PAGE
116. Orange Sorghum. (Bureau of Plant Industry, U. S. Department of Agriculture) . . . . .	235
117. Goose Neck Sorghum. (Bureau of Plant Industry, U. S. Department of Agriculture) . . . . .	236
118. A Field of Black-hulled White Kafir. (E. B. Voorhees) .	238
119. Heads of Milo and of Black-hulled White Kafir. (E. B. Voorhees) . . . . .	239
120. Broom-corn Brush . . . . .	242
121. A Vegetative Branch from near the Base of a Cotton Plant	249
122. A Fruiting Branch of a Cotton Plant . . . . .	250
123. A Cotton Plant . . . . .	251
124. Cotton Plant, on which the Vegetative Branches are Suppressed . . . . .	252
125. A Cotton Plant, having only Fruiting Limbs . . . . .	253
126. Cotton Leaves . . . . .	255
127. Cotton Bolls. (U. S. Department of Agriculture) . . . . .	258
128. A Cotton Plant deficient in Storm-resistance . . . . .	260
129. Storm-resistant Boll and Burs; Bolls and Burs lacking Storm-resistance . . . . .	261
130. Various Shapes of Cotton Bolls . . . . .	277
131. A Sea Island Cotton Plant . . . . .	278
132. Where Sea Island Cotton is Grown. (U. S. Department of Agriculture) . . . . .	279
133. A Cotton Plant of the Cluster Type. (U. S. Department of Agriculture) . . . . .	284
134. A Fruiting Limb of a Cluster Cotton Plant. . . . .	285
135. A Cotton Plant of the Semicluster Type . . . . .	286
136. The Peterkin Type of Cotton Plant . . . . .	287
137. A Cotton Plant of the King Type . . . . .	288
138. A Cotton Plant of the Big-boll, Storm-proof Type . . . . .	289
139. A Cotton Plant of the Long-staple, Upland Type. (U. S. Department of Agriculture) . . . . .	291
140. Fibers of Several Varieties of Cotton . . . . .	292
141. A Productive Cotton Plant of the Toole Variety . . . . .	297
142. A Productive Cotton Plant. (University of Georgia) . . . . .	303
143. An Unproductive Cotton Plant. (University of Georgia) . . . . .	304
144. Diagram showing a Breeding Plot of Twenty Rows of Cotton . . . . .	311

FIG.	PAGE
145. Diagram showing Method of selecting Cotton. (H. J. Webber) . . . . .	312
146. Cotton Plants, showing Retention of Leaves; and Shedding of Leaves . . . . .	316
147. A Field of Cotton, Fertilized and Unfertilized . . . . .	322
148. A Field of Cotton, showing the Effects of Potash in retaining the Leaves . . . . .	334
149. A Middle Burster, or Double Moldboard Plow. (B. F. Avery & Sons Co.) . . . . .	346
150. An Inexpensive Cotton Planter . . . . .	349
151. One Form of Plow-stock . . . . .	352
152. A Young Cotton Plant, showing Two Seed-leaves and Two True Leaves . . . . .	353
153. Various Forms of Sweeps and Scrapes used in cultivating Cotton. (L. H. Bailey) . . . . .	354
154. An Alabama Cotton Field. (Farmer's Coöperative Demonstration Work) . . . . .	362
155. The Worswick-Hardt Cotton Picker at Work . . . . .	364
156. The Dixie Cotton Picker . . . . .	366
157. Vertical Section through the Dixie Cotton Picker when at Work . . . . .	367
158. Section through a Ginney. (Continental Gin Company) . . . . .	368
159. Transverse Section through a Cotton Gin. (Continental Gin Company) . . . . .	369
160. Foreign and American Bales . . . . .	370
161. Cotton Bales left unprotected from Rain . . . . .	372
162. Side View of Cotton Bales . . . . .	372
163. Bales from a Gin Compress. (Farmers' Gin Compress Company) . . . . .	373
164. The Propelling Mechanism of an Old Horse-power Gin. (From D. A. Tompkins' "Cotton a Factor in Progress") . . . . .	378
165. Percentage of the Total American Crop of Cotton grown in Each State in 1908. (U. S. Census Bureau) . . . . .	382
166. Percentage of World's Mill Supply of Cotton contributed by Each Country in 1908. (U. S. Census Bureau) . . . . .	385
167. Moths of Cotton Boll-worm and Corn Ear-worm. (U. S. Dept. Agr., Bureau of Entomology) . . . . .	390

*LIST OF ILLUSTRATIONS*

XXV

FIG.	PAGE
168. The Cotton Boll-worm on the Outside of a Cotton Boll. (U. S. Dept. Agr., Bureau of Entomology) . . . . .	391
169. Pupal or Chrysalis Stage of the Cotton Boll-worm and the Corn Ear-worm. (U. S. Dept. Agr., Bureau of Entomology) . . . . .	392
170. Pupa of Boll-worm in its Underground Burrow. (After Quaintance and Brues, U. S. Department of Agriculture) . . . . .	393
171. The Mature Boll-weevil. (W. E. Hinds) . . . . .	394
172. Cotton Square, showing Boll-weevil Larva in Position. (After W. D. Hunter, U. S. Dept. Agr., Bureau of Entomology) . . . . .	395
173. Punctured Cotton Square. (After W. D. Hunter, U. S. Dept. Agr., Bureau of Entomology) . . . . .	396
174. Cotton Stalk Cutter. (Louisiana Crop Pest Commission) . . . . .	400
175. Side View of Cotton Stalk Cutter. (Louisiana Crop Pest Commission) . . . . .	400
176. Cotton Plant in the "Budding" Stage. (Louisiana Crop Pest Commission) . . . . .	402
177. The Hinds Chain Cultivator. (W. E. Hinds) . . . . .	403
178. Map showing the Areas infested by the Boll-weevil. (U. S. Dept. Agr., Bureau of Entomology) . . . . .	404
179. Cowpea-pod Weevil. (After Chittenden, U. S. Dept. Agr., Bureau of Entomology) . . . . .	408
180. Cotton Plants attacked by Wilt . . . . .	412
181. Section through Wilted and Healthy Cotton Stalks . . . . .	413
182. Root-knot or Nematode Injuries on Cotton Roots. (C. F. Atkinson) . . . . .	416
183. Anthracnose on Cotton Bolls. (C. F. Atkinson) . . . . .	417
184. Diseased Leaves, Boll, and Stem of Cotton Plant. (W. A. Orton, Bureau of Plant Industry, U. S. Department of Agriculture) . . . . .	420
185. A Field of Hemp. (Bureau of Plant Industry, U. S. De- partment of Agriculture) . . . . .	422
186. Leaf and Flowers of Hemp. (L. H. Bailey) . . . . .	423
187. Shocking Hemp. (L. H. Bailey) . . . . .	425
188. A Field of Sweet-potatoes in Alabama . . . . .	427

FIG.	PAGE
189. A Branch of a Vineless Sweet-potato Plant. (After Price, Texas Experiment Station) . . . . .	434
190. Three Shapes of Sweet-potato Leaves. (After Price, Texas Experiment Station) . . . . .	434
191. Sweet-potato Slips ready to be set. (U. S. Department of Agriculture) . . . . .	442
192. Devices employed in Setting Sweet-potato Slips and Vine Cuttings. (U. S. Department of Agriculture) . . . . .	444
193. Transplanting Machine setting Sweet-potatoes. (L. H. Bailey) . . . . .	444
194. Sweet-potatoes attached to a Section of Planted Vine . . . . .	445
195. Special Plows for Digging Sweet-potatoes. (U. S. Department of Agriculture) . . . . .	449
196. End View of House for Storing Sweet-potatoes . . . . .	452
197. Cross Section through Sweet-potato, showing Injuries by Borer. (After Conradi, Texas Experiment Station) . . . . .	454
198. Black-rot on Root and Slip of Sweet-potato. (After B. Halsted, New Jersey Experiment Station) . . . . .	455
199. The Cassava Plant. (U. S. Department of Agriculture) . . . . .	458
200. Method of Preparing Bed for Keeping Cassava Seed-stems over Winter. (S. M. Tracy, U. S. Department of Agriculture) . . . . .	462
201. The Lower Part of a Peanut Plant. (U. S. Department of Agriculture) . . . . .	466
202. A Peanut "Popper." (W. N. Roper) . . . . .	471
203. A Field of Spanish Peanuts grown from Selected Seed. (W. N. Roper, <i>American Nut Journal</i> ) . . . . .	473
204. Pods and Peas of Three Varieties of Peanuts. (U. S. Department of Agriculture) . . . . .	476
205. A Bunch of Spanish Peanuts. (W. N. Roper) . . . . .	478
206. Stacking Peanuts. (U. S. Department of Agriculture) . . . . .	481
207. A Part of a Stem of Sugar-cane. (W. C. Stubbs) . . . . .	487
208. Cross Section of Part of a Stem of Sugar-cane. (W. R. Dodson) . . . . .	488
209. Cross Section through a Bundle from the Stem of Sugar-cane. (W. R. Dodson) . . . . .	488
210. One Form of Cane Loader. (L. H. Bailey) . . . . .	500

*LIST OF ILLUSTRATIONS*

xxvii

FIG.	PAGE
211. A Field of Velvet Beans . . . . .	504
212. Cutting Sugar-cane in Louisiana. (W. R. Dodson) . . . . .	508
213. A Cane Stripper . . . . .	509
214. Diagram of Tobacco Flower. (After Shamel and Cobey) . . . . .	527
215. Showing the Results of Breeding a Strain of Tobacco Resistant to Disease. (Bureau of Plant Industry, U. S. Department of Agriculture) . . . . .	528
216. Young Tobacco Plants. (Bureau of Plant Industry, U. S. Department of Agriculture) . . . . .	528
217. A Tobacco Seed Blower. (A. D. Shamel) . . . . .	529
218. A Cloth Shade or Tent. (Bureau of Plant Industry, U. S. Department of Agriculture) . . . . .	530
219. A Transplanting Machine for Setting Tobacco. (Bureau of Plant Industry, U. S. Department of Agriculture) . . . . .	534
220. Young Tobacco Plants growing under a Lath Shade in Alabama . . . . .	536
221. Diagram showing how Leaves of Wrapper Tobacco are Cut. (U. S. Department of Agriculture) . . . . .	543
222. Southern Tobacco Worm. (U. S. Dept. Agr., Bureau of Entomology) . . . . .	545



# SOUTHERN FIELD CROPS

## CHAPTER I

### OATS — AVENA SATIVA

THE oat plant is included in the great family of the grasses (*Gramineæ*), as are all the grains. It came into use at a later date than did wheat and barley.

The seed or grain of oats is used chiefly as food for horses. It is also employed, in the form of oatmeal and other cereal dishes, as human food. The oat plant is useful for hay and for pasturage. Its straw is utilized as food and bedding for animals and as packing material.

### STRUCTURE

**1. Roots.** — The oat, as the other grains, is a fibrous-rooted plant, having no tap-root. The crown from which the main stems originate is usually within about an inch of the surface of the ground.

**2. Stems.** — The stems of the oat plant originate in the same way as those of the wheat, each as a developed bud or branch, from an older stem. At each underground node of every stem a bud may develop into another stalk and its lower nodes in turn may send out additional shoots. Hence a single plant may bear an indefinite number of stems, the usual number, however, being two to six. A large number is formed by thin sowing and by abundance of moisture and plant-food, or by hilling up earth around

the lower nodes. The conditions that hinder tillering (sometimes limiting the number of stems to one or two to the plant) are thick sowing, late sowing, and deficiency of moisture or plant-food.

**3. Leaves.** — The leaf-blade of the oat is wider than that of wheat or rye, and on its margins are scattering hairs so fine as to be noticed only on careful examination.



FIG. 1. — PART OF AN OAT PLANT.

Showing the absence of clasps where leaf-blade and sheath join.

At the junction of the leaf-blade and sheath there are no clasps or auricles (Fig. 1), which absence serves to distinguish the young oat plant from that of any other small grain.

**4. Pollination.** — The oat in nature is self-pollinated; hence there is practically no danger of crossing between different varieties. Several varieties may properly be sown in adjacent fields, if care is taken to prevent mixing by mechanical means, as in harvesting and threshing.

**5. The panicle and spikelets.** — The grain-bearing part of the plant, though usually called a head, is really a panicle, or widely branched terminal part of the stem (Fig. 2). The branches of the head originate at the upper nodes or joints of the stem, several usually springing from each node. Each branch may bear a single spikelet (that is, a group of grains) or several spikelets.





FIG. 2.—A PANICLE OF OATS.

The type here shown is Kherson, an early variety.

Each spikelet (Fig. 3) consists of two or more flowers, of which usually only two develop into perfect grains.

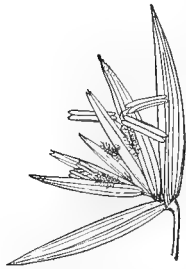

FIG. 3. — OAT SPIKELET IN BLOOM.

Showing 2 outer pieces of chaff inclosing 2 flowers, each one containing 3 pollen cases (anthers) and 2 plume-like stigmas.

Those that usually develop are the two grains nearest to the branch, the nearer or lower one being almost invariably the larger seed. Hence an oat spikelet may be said to consist in most instances of twin grains which may or may not be separated in threshing.

The third flower coming from the branch sometimes develops into a small grain, but more frequently it is abortive, or undeveloped.

**6. The grain.** — Each grain consists of a nearly cylindrical kernel and of an inclosing hull. This hull is tightly wrapped about the kernel, and is usually not removed in threshing; but the two parts are not grown together, as shown by the fact that by pinching the grain between the fingers the inner part can readily be forced out, free from any hull.

In most states the legal weight of a bushel of oats is 32 pounds. A measured bushel usually weighs 30 to 36 pounds. Oats are sold by the bushel of legal weight.

Saunders found that in the cool climate of Canada oats germinated well even when the seeds were three years old, after which time the percentage of germination rapidly decreased.

#### COMPOSITION

**7. Analyses.** — According to Hunt ("Cereals in America") the average of American analyses is as follows: —

	OAT GRAIN	OAT KERNEL	OAT STRAW	OAT HAY CUT IN MILK	OAT HULLS
	%	%	%	%	%
Water . . . .	11.0	7.9	9.2	15.0	7.3
Ash . . . .	3.0	2.0	5.1	5.2	6.7
Protein . . . .	11.8	14.7	4.0	9.3	3.3
Crude fiber . . . .	9.5	0.9	37.0	29.2	29.7
Nitrogen-free extract . . . .	59.7	67.4	42.4	39.0	52.0
Fat . . . .	5.0	7.1	2.3	2.3	1.0

Since the percentage of hulls varies in different varieties and in different seasons, the composition of different lots of oats is naturally variable. A sample of oats with slender or incompletely filled grains is inferior in composition and food value to a sample of plump oats. The hull averages about 30 per cent of the total weight of the grain.

**8. Draft on soil fertility.**—The following table<sup>1</sup> shows the amounts of nitrogen, phosphoric acid, and potash removed from the soil in a crop of 40 bushels of oats and the accompanying amount of straw:—

	NITROGEN	PHOSPHORIC ACID	POTASH
Oat grains, with hulls, per cent . . . . .	1.76	0.59	0.48
Oat straw, per cent . . . . .	0.56	.28	1.62
Oat grain removes in a crop of 40 bu. (1280 lb.), lb. . . . .	22.53	8.83	6.14
Oat straw (1500 lb.) removes, lb. . . . .	8.40	4.20	24.30
Total crop of 40 bu. and 1500 lb. of straw removes, lb. . . . .	30.93	13.03	30.44

<sup>1</sup> Calculated from data in Hopkins' "Soil Fertility and Permanent Agriculture."

From the above table it may be seen that the oat plant makes considerable demands on soil fertility; that the greater part of the nitrogen and of the phosphoric acid is removed by the grain; and that by far the greater part of the potash is removed by the straw.

These figures should impress the fact that the straw should be returned to the land in the form of stable manure, after having been used either as food or bedding. In case it is impracticable to make either of these uses of the straw, the stacks should not be burned nor left to rot in one place, but immediately or after partly rotting the straw should be distributed over the galled spots in the fields.

In spite of the fact that a good crop of oats, if the straw be carried off, removes a considerable amount of plant-food, yet experience shows that the occasional introduction of an oat crop into the rotation increases the yield of succeeding crops. This is chiefly because of the vegetation occupying the land after oats are harvested. Even the growth of a mass of weeds may be helpful to some soils. However, the oat crop gives opportunity to improve the land still more rapidly, due to the succeeding growth of cowpeas, which is usually the best crop to follow oats.

#### VARIETIES

**9. Types of Southern oats.** — In Europe, Canada, and the northern part of the United States, the number of varieties of oats in cultivation is considerable. However, nowhere does the number equal that of varieties of wheat.

In the Gulf States, few varieties of oats are grown. The types most commonly raised in the South are:—

- (1) Red Rust-proof;
- (2) Burt;
- (3) Turf or Grazing.

Each of these may be known under several names, or may have several strains. For example, among the sub-varieties or selections of the Red Rust-proof type are Appler, Culberson, and Bancroft.

**10. Red Rust-proof oats.** — This is the most popular type of oats from North Carolina to Texas, and is variously called Red oats, Rust-proof oats, and Texas oats. It and its strains may be recognized, or distinguished from other varieties, by the following characteristics: When a bunch of slender bristles is present at the base of the lower grain of a spikelet, they are of greater length than those sometimes occurring on other varieties growing in the South (Fig. 4); and almost invariably both of the developed grains in a spikelet are armed with beards, while in most other varieties the beards, if present, usually occur only on the larger grain in each spikelet. The usual means of distinguishing Red Rust-proof oats is by the reddish or yellowish appearance of the grains that have not been stained by bad weather, and the greater plumpness of the grains as compared with those of other Southern varieties. The head or panicle is rather compact, and the branches short (Fig. 5).



FIG. 4.—SPIKELETS OF RED RUST-PROOF OATS.

Note length of bristles at base of spikelet.

The straw of Red Rust-proof oats is stout or large, and on poor or medium land the plants do not grow as tall as do those of Burt and Turf oats. This stout straw makes Red Rust-proof oats less liable to fall or lodge than are the

varieties just mentioned. In crops yielding 15 to 30 bushels per acre, there is usually about the same weight



FIG. 5.—A PANICLE OF RED RUST-PROOF OATS.

of straw as of threshed grain; as the yield increases the percentage of straw increases.

The Red Rust-proof variety and its various strains—Appler, Culberson, and Bancroft—may be sown either in the fall or after Christmas. In hardiness toward cold, or ability successfully to withstand a severe winter, this variety is superior to Burt but less hardy than Turf, and decidedly less hardy than barley, wheat, or rye. In spite of the occasional winter-killing of a crop of Red oats sown in the fall, it is usually more profitable throughout the greater part of the cotton-belt to sow in the fall than after Christmas. Means of decreasing winter-killing are indicated in paragraph 22.

In maturity, the Red Rust-proof group of varieties is earlier by two to three weeks than Turf oats sown at the same time in the fall. When sown after Christmas, Red oats are at least a week later than Burt oats sown at the same time.

Red Rust-proof oats are not really completely rust-proof, but strongly rust-resistant. In years when rust is especially severe, this variety is attacked and occasionally rather severely injured, but never to the same extent as other varieties.

In yield of grain, the Red Rust-proof type has on the whole been more satisfactory in the cotton-belt than any other. It is especially more productive than Turf oats where the soil is poor or when the weather conditions are unfavorable.

Appler is a popular variety of the Red Rust-proof type, which sometimes has proved slightly more productive than an unselected strain of the Red Rust-proof.

**11. Burt oats.**—This variety (Figs. 6 and 7), sometimes known as “May oats,” has a slender, bearded grain, usu-



FIG. 6. — BURT OATS.

ally of a grayish or light dun color. The branches of the head are long. In the greater part of the cotton region



the Burt oat cannot safely be planted in the fall, for it is frequently winter-killed. It is essentially a variety for sowing after Christmas. It is the earliest of the commonly grown varieties of the Southern region. Its earliness, together with its great height of straw, are in its favor when the date of sowing is late. The grain weighs less per bushel than Red oats, and shatters much more easily when harvested.

**12. Turf or Grazing oats.**—Among the names given to this variety, or to strains of it, are Gray, Virginia Gray, Winter, Turf, and Myers' Turf. This is the hardiest of the varieties, and has been known to survive the winters a little higher than the latitude of northern Virginia. It is practically safe against winter-killing throughout the cotton-belt; yet it is not so hardy as wheat.

The grain is slender and of a gray or light dun color. Usually there are beards on one grain in each spikelet. This oat branches or stools freely, thus making it especially valuable for pasturing, and winning for it the name of "grazing oats." The straw is tall and slender.

This variety ripens about two weeks later than Red Rust-proof oats sown at the same time. It is much more susceptible to rust; and on poor land or with unfavorable seasons it often fails to produce plump, well-filled grains. Its best place is in the region just north of the cotton-belt.

Turf oats are unsuitable for sowing after Christmas. This variety requires earlier planting in the fall than Red oats.



FIG. 7.—SPIKELETS OF BURT OATS.

Note shortness of basal bristles, which are barely visible.

Turf oats are suitable for sowing with hairy vetch when both vetch and oats are to be threshed for seed. On rich land, the two plants ripen together, and usually enough seed of both are shattered in harvesting to reseed the land the next fall. On poor and medium land Turf oats grow off too slowly to be ready to cut for hay when hairy vetch is in the best condition for hay making. Therefore, for purposes of making hay it is usually better to sow vetch with Red Rust-proof oats than with Turf oats.

The weight of straw is usually about double that of grain.

**13. Improvement of varieties.** — Much less work has been done in improving the oat by selection and breeding than in cotton, corn, and wheat. Breeding experiments at the Alabama Experiment Station with the Red Rust-proof variety have shown clearly that most samples of seed of this variety are badly mixed; that even in apparently uniform samples there are numerous strains or elementary species; and that careful selection of individual plants may result in modifying the yield, the time of maturity, and other qualities.

Desirable improvements in the Red Rust-proof variety are: (1) increased yield; (2) greater uniformity; (3) elimination of the beards and of the black grains; and (4) increased resistance to rust.

Desirable improvements in the Burt oats are: (1) larger yields; (2) increased uniformity; (3) elimination of the tendency to shatter; (4) greater plumpness of grain; and (5) adaptation of this variety to fall sowing, by selection of plants that withstand the cold of winter.

For sowing in the fall, preference should be given to seed from a strain which has been repeatedly sown at this season.

## CLIMATE, SOILS, AND FERTILIZERS FOR OATS

**14. Climate.** — The oat plant is most at home in a cool moist climate. Yet in the Southern States, with a moist but hot climate, it is successfully cultivated, although the yield per acre and the weight per measured bushel are reduced. In the South, climate is most important in determining whether Red Rust-proof oats, the kind most extensively grown, should be sown in the fall or after mid-winter.

That part of the South in which by far the greater part of the crop of Red Rust-proof oats is sown in the fall lies south of a line drawn nearly through Birmingham in Alabama, Atlanta in Georgia, Charlotte in North Carolina, and Norfolk in Virginia. Yet, experience shows that it is profitable to sow Red Rust-proof oats in the fall considerably northward of this line, though at the risk of more frequent failures from winter-killing. Even in the northern third of the Gulf States, this class of oats, when sown in the fall, is not seriously injured by cold in one winter out of three. Since two crops of fall-sown oats usually yield more than three crops of oats sown after Christmas, fall sowing should be more generally practiced. North of the line indicated above, Turf oats are hardy in most winters, at least as far northward as Maryland.

**15. Soils.** — The oat is adapted to a wider range of soils than is wheat. In fact, it may be grown on almost any soil on which other ordinary field crops succeed. The low yields of oats as shown by statistics are largely due to the fact that the crop is often sown on land too poor for other profitable use.

Moreover, the oat crop is less frequently fertilized than are the other staple crops. Land that is too poor for cotton is usually too poor for oats sown after Christmas, but such land

can often be profitably utilized by sowing oats in the fall and fertilizing in March with nitrate of soda.

One difficulty in growing Red Rust-proof oats without fertilizer on poor and rocky land is the fact that the short straw made by this variety under such conditions makes it difficult to save all the heads in harvesting the crop. This difficulty is largely overcome by the use of nitrate of soda and other fertilizers rich in nitrogen.

Oats thrive on a moderately rich soil, and fertility is especially important when sowing is done after Christmas. On land excessively rich in nitrogen, and at the same time quite moist, there is danger that the straw will grow so tall and weak as to fall or lodge, and thus reduce the yield. The same danger may occur from excessive use of stable manure or other nitrogenous fertilizer.

**16. Place in the rotation.** — The usual position of the oat crop in a rotation in the cotton-belt is immediately after corn, the oats being followed by cowpeas the same year, and the cowpeas being followed by cotton the next year. This is the logical practice for fall-sown oats, since the corn crop can be removed in October in time for the sowing of oats, while cotton is usually not removed in time for the largest yield of fall-sown oats. However, in regions where spring sowing of oats is practiced, this crop may just as well follow cotton as follow corn.

In the usual practice of fall-sowing of oats after corn, the oats get the advantage of the fertilizer produced by the cowpeas that are usually planted between the rows of corn.

Inquiry is sometimes made whether it may not be practicable to grow oats continuously on the same land with a catch-crop of cowpeas each summer, the cowpeas to be used for hay. This would be advisable only under exceptional conditions and when phosphoric acid and potash could be restored to the soil in the fertilizer, especially in the fertilizer for the cowpea crop.

**17. Fertilizers.** — Too frequently oats are sown on poor land without being fertilized. Experiments in several Southern States have shown that it pays to fertilize oats growing on medium or poor lands. On many of these lands, acid phosphate should be used. This may be applied at the rate of 100 to 200 pounds per acre at the time of sowing. It may be run through the fertilizer attachment of the grain drill, and its contact with the seed will not injure germination. However, it would not be safe thus to sow through the grain drill and with the seed any considerable amount of cotton-seed meal, or other nitrogenous fertilizer or of potash salts.

While some sandy soils may require for the maximum growth of oats a small amount of potash, it is not usually necessary to apply this fertilizer constituent to the oat crop.

The most universal need of oats on the average soils of the cotton-belt is for nitrogen. Since the oat makes its growth in the cooler part of the year when vegetable matter does not rapidly nitrify or become available as plant-food, the best form of nitrogenous fertilizer is nitrate of soda. This fertilizer does not require further change, but is immediately available.

Experiments have shown that it is usually profitable to apply any amount of nitrate of soda between 40 and 160 pounds per acre. About 80 pounds per acre is usually advisable. The lumps should be carefully crushed and the fertilizer sown broadcast as a top-dressing at least two months before the average date of harvest. As a rule, the first half of March is a suitable time for applying nitrate of soda to fall-sown oats, and the latter half of the month for spring-sown oats.

No covering of soil is necessary in using nitrate of soda, but the

use of a light harrow or weeder immediately after sowing the fertilizer would often be advantageous, especially if the surface should be quite dry, or if a heavy rain should fall soon after the application.

#### CULTURAL METHODS FOR OATS

**18. Preparation of land.** — The usual preparation of the land for the oat crop is poorer than for most other crops. Too often the seed is sown broadcast on unplowed land and then covered with a one-horse or two-horse turn-plow. The danger in this procedure is that the seed may be covered too deeply or by large clods, either of which prevents the germination of some of the seeds. A method that insures more thorough preparation is the following: plowing, then sowing the seed broadcast, and covering by the use of a disk-harrow. A still better method consists in first plowing the land and then sowing with the grain drill.

Either of these methods permits deeper plowing than is advisable when the seed is covered with the turn-plow.

On clean, friable soil oats are sometimes merely disked in without plowing. This method is not so well suited to Southern soils, deficient in vegetable matter, as it is to regions farther north.

**19. When to sow.** — Repeated experiments have shown that throughout the greater part of the cotton-belt the yield secured from fall-sown oats is at least 50 per cent greater than from crops sown after Christmas. Frequently fall-sown oats yield twice as much as those sown in February.

The exact date of planting that is most likely to give the maximum yield varies with the latitude and climate, and even with varieties. The earliest practicable date for fall-

sowing is in the first half of September. In the central and southern part of the cotton-belt, this is too early for sowing Red Rust-proof oats, since it tends to make the plants form stems and to head too early the latter part of the winter, at which stage the oat is easily killed by freezing temperatures. However, very early sowing may be practiced when the oats are to be rather closely grazed throughout the winter.

The period that is generally preferred for sowing Red oats extends from October 1 to the middle of November; sowings made in the earlier part of this period usually afford the larger yields. If sowing is postponed much beyond the latter date, the young plants do not have time to become firmly rooted and anchored before they are subjected to heaving by the alternate freezing and thawing of the soil.

In sowing oats after Christmas, custom varies greatly, the usual limits being from January 1 to April 1. In the central part of the cotton-belt, probably the first few weeks in February is a safer period than is an earlier date, and any delay after this time is likely to reduce the yield greatly.

**20. Drilling versus broadcast sowing.**—Some experiments have shown advantage in yield from sowing oats with a grain drill as compared with broadcast sowing. Drilling has the advantages: (1) of saving at least half a bushel of seed per acre; (2) placing the seed at a more uniform depth, thus favoring uniformity in ripening; and (3) leaving the plants in a very shallow depression, which affords a slight degree of protection against cold and heaving.

Extensive experiments in the cotton-belt have proved that, on an average, drilling affords a larger crop than broadcast sowing. The Illinois Experiment Station found the smaller yield with broadcast oats to be due in part to the more uneven and generally shallower depth at which the seed were placed in broadcast sowing.

In countries where it is customary to sow red clover with the small grains, it has been noticed that the clover is thriftier and less injured by hot weather when the rows made by the grain drill extend north and south rather than east and west.

**21. The open-furrow method of drilling oats.** — This consists in sowing the seed, not with a two-horse grain drill, but with a one-horse planter, which deposits the seed in the bottom of a deep furrow or trench previously opened by a large shovel plow. The seeds are barely covered by the small amount of soil which falls into the trench as the planter passes along. Therefore, the plants grow from the bottom of a rather deep furrow which remains unfilled throughout the winter. Here they are somewhat protected from cold and greatly protected from heaving, since the soil and the plants in the bottom of a furrow are not easily lifted by alternate freezing and thawing.

These deep furrows are 18 to 24 inches apart. Fertilizer is drilled in with the seed.

An incidental advantage of the open-furrow method is the fact that it permits thorough harrowing in early spring. This affords all the usual advantages of cultivation and partially fills the open furrows so as to make easier the operation of the binder or mower.

At the Alabama and Georgia Experiment Stations, this method has given larger yields than were secured from broadcast sowing, besides almost complete protection from winter-killing. However, this method is not adapted to very stiff or poorly drained



soil. It is also a slow method, but the reported invention of a machine for sowing several rows at one time may possibly overcome this objection.

**22. Prevention of winter-killing.** — Since Red Rust-proof oats are sometimes thinned, or even killed completely, by cold weather in winter, methods of decreasing this injury are important. Oats are more frequently winter-killed on account of heaving, or lifting of the soil and of the young plants when the ground freezes, than from the direct effects of low temperatures. Heaving is due to the expansion in freezing of the water in the soil. Every one has noticed on a frosty morning the little icicles projected upward from a spot of wet clayey land. Often these icicles lift on their summits particles of soil. By this same process of expansion of soil-moisture in freezing, young plants are lifted. This heaving is worst in soils that contain the most water; that is, in clay spots and where the drainage is poor.

Means of decreasing winter-killing of oats are: (1) planting in depressions or unfilled furrows (the open-furrow system); (2) improved drainage; (3) selection of hardy varieties or strains; (4) the use of the roller to settle the lifted plants into closer contact with the soil.

**23. Quantity of seed.** — On account of the ability of the oat plant to throw out an indefinite number of shoots or culms, and thus to utilize whatever space may be available, the thickness of sowing does not directly determine the rate of yield. From 4 to 16 pecks to the acre may be taken as the extreme limits. The quantity of seed usually advisable for broadcast sowing is between  $1\frac{1}{2}$  and  $2\frac{1}{2}$  bushels per acre. By using the grain drill, this may

be reduced by about half a bushel per acre, and the open-furrow method makes possible an even greater reduction. The earlier the date of sowing and the more complete the preparation of the land, the smaller may be the quantity of seed employed.

**24. Size of seed.** — Scores of experiments have been made to determine the size of seed or grain to sow for the best agricultural results, most of which show a distinct advantage from sowing large or heavy seed.

Zavitz secured the following results (American Breeders' Association, Vol. II, p. 121): —

After selecting seed for thirteen years, the large seed being taken each year from the plot sown with large grains, the small grains continuously from the plots sown with small seed, the crop from the large seed yielded 65.5 bushels per acre as compared with 44.7 bushels from the small seed; the crop from the large seed weighed 35.5 pounds per bushel as compared with 24.3 pounds per bushel from the continuous sowing of light seed. The deterioration due to sowing poor seed is still better shown by the fact that the crop from the large seed required only 1149 grains to weigh an ounce while that from the light seed required 2066 grains.

Among the publications summarizing the experiments on this point are the following: —

Nebraska Expr. Station Bull. 104.

Ohio Expr. Station Bull. 38.

Kansas Expr. Station Bull. 74.

Canada Expr. Farms, Rpt. 1901.

Ontario Agr. College and Expr. Farms, Rpt. 1903.

**25. Separation of grains by fanning.** — It should be borne in mind that there is a tendency for any one oat plant to bear as many heavy seeds as light seeds. This is because each spikelet usually matures one large and one

small grain. Hence separation by fanning machines tends to place among the large seeds and among the small seeds, grains from the same parent plants. This indicates that for most rapid improvement of the oat, reliance cannot be placed chiefly on selection by the use of the fanning machine, but rather on the selection of individual plants.

However, seed oats should be fanned for the following reasons: (1) to eliminate many grass and weed seeds; (2) to remove those oat grains that are too light to germinate or to make vigorous plants; (3) to decrease the danger of clogging the grain drill with broken straw and trash and beards, especially in the Red Rust-proof variety.

**26. Change of seed.** — There is a widespread belief that some indefinite and mysterious advantage results from changing the seed of almost any crop. In the case of oats, all available evidence is against this notion and seems to indicate that the varieties do not “run-out,” or degenerate, from being grown continuously in any part of the cotton-belt. Oats grown in the locality where they are to be planted are best for sowing.

The advantages of home-grown seed are usually the following: (1) A yield equal or superior to that secured from seed grown in a different latitude. (2) The ability to select a strain of seed adapted to fall sowing, whereas the seed obtained from other localities is frequently from a spring-sown strain, and hence less able to escape winter-killing. (3) Greater freedom of home-grown oats from admixture with seed of Johnson-grass or noxious weeds that might be introduced from abroad.

In itself there seems to be no virtue in changing seed. However, a farmer should not hesitate to change seed to procure another strain grown in the same latitude, if his own seed is especially light or poor; or if, by changing seed, he can secure a better or purer variety suited to his soil or climate.

**27. Cultivation or inter-tillage of oats.** — It is unusual to till oats after germination occurs. It is probable that in the South, especially on soils inclined to bake, it will be generally advantageous to harrow drilled oats. Harrowing is seldom injurious to the stand of oats sown with the grain drill and not at all hurtful to the stand of oats sown in open furrows.

But few tests have been made to determine whether inter-tillage of small grains is profitable. At the Nebraska Experiment Station (Bulletin No. 104) the yield of oats sown with a grain drill was increased by harrowing, in three dry years out of five. With oats sown broadcast, harrowing reduced the yield every year, because it thinned the stand. Drilled oats, tilled, yielded more grain than broadcast oats without tillage. At the same station the yield on the harrowed plots decreased as the space between rows was widened from 6 to 12, 18, and 24 inches.

**28. Pasturing oats.** — During periods when the soil is so dry as to be uninjured in its mechanical condition by the tramping of live-stock, there may be no harm in pasturing oats intended for grain.

Cautions to be observed in pasturing any small grains are: (1) Keeping the stock off the land while wet; (2) discontinuing pasturage early enough to afford abundant time for the plants to tiller and head; (3) avoidance of pasturing too closely while there is danger of severe freezes.

For oats sown rather early in the fall, pasturing may be a distinct advantage in preventing the formation of stems while there is still danger of freezing weather, which would be especially injurious to oats in the "booting" stage, that is, after the stems have begun to lengthen rapidly.

## ENEMIES

29. **Weeds.** — The same weeds are troublesome in oats as in wheat. Chief among these is cheat or chess. The use of clean seed, that has been carefully fanned and screened, is the best means of avoiding weed pests.

In purchasing seed oats, care should be taken that they contain no seed of Johnson-grass.

30. **Fungous diseases of oats.** — Chief among diseases caused by fungi is *rust*, for which there is no treatment. The Red Rust-proof variety and its various strains are the most rust-resistant varieties, but even these are not entirely exempt. Rust is worse in damp weather.

*Oat smut* (Fig. 8). — This disease usually reduces the yield of oats 10 to 20 per cent. Unlike rust, it is entirely under the control of the farmer. It appears as blackened heads in which no grains develop, but in the place of which are



FIG. 8. — OATS DESTROYED BY SMUT.

conspicuous masses of black, powdery material or spores. These spores answer the purpose of seed in carrying smut to the next crop of oats. This particular fungus originates from a tiny spore (or particle of black dust) which has found its way during ripening, or harvesting or threshing to the seed grain. The fungus grows in the form of threads through the entire length of the oat plant and finally bears what may be called its fruit or spores at the time of heading.

To prevent smut, all that is necessary is to destroy the life of the tiny spore that may have found lodgment on the surface of the seed grain. There are several methods, the simplest and most convenient of which is the formalin treatment, the directions for which follow:—

For each three gallons of water add one ounce of formalin. With this liquid, wet or thoroughly moisten the seed, either by dipping the sacks of grain or by thoroughly sprinkling the seed while it is being stirred. Then leave the damp seed in a pile for at least two hours, covering it meantime with a sheet, or old carpet, which has also been dipped in this liquid. The purpose in thus covering the pile is to enable the vapors formed by the evaporation of the formalin to completely envelop every seed. Dry the oats before sowing them, and do not let them come in contact with old sacks or floors that have not been disinfected with formalin.

Another method of entirely preventing smut in oats is by the hot-water treatment:—

Dip the bags of seed oats into a vessel of water kept constantly at a temperature of about 133° F. and always between 130° and 135°. Keep the seed in this hot water for ten minutes. It may then be cooled by being dipped in cold water, or it may be spread out to dry. The temperature of the hot water is most conveniently kept at a constant point by the addition of cold

or hot water as required, and by first heating the oats for a few minutes in warm water at about 120° F.; for if the cold seed were dipped into water at 133°, they would too rapidly lower its temperature. This method requires the use of an accurate thermometer.

**31. Insect pests.**—Insects are the same as those of wheat, except that the oat is not attacked by the Hessian fly, and that granary insects do less harm to the oat grain, protected as it is by its enveloping hull. A serious pest of the oat plant in the West and Southwest is the green-bug (*Toxoptera graminum*, Fig. 9).

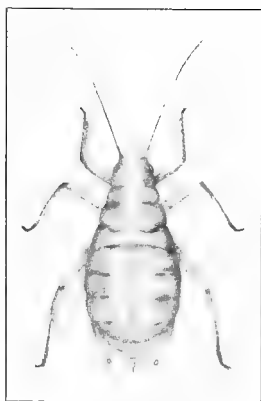

FIG. 9.—GREEN-BUG (*Toxoptera graminum*); WINGLESS ADULT.

Greatly enlarged. (After S. J. Hunter.)

The green-bug is a plant-louse of green color and very small size, that sucks the juices from the young plant. It has many natural enemies which, after the early cool part of the season, usually keep it in subjection. One of these enemies, a lady-bug beetle (Fig. 10), has sometimes been artificially bred and distributed as a means of combating the green-bug, especially before the weather has become warm enough to bring forth naturally many of the enemies of this pest.

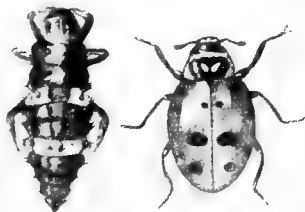

FIG. 10.—TWO STAGES OF A LADY-BUG WHICH DESTROYS "GREEN-BUGS."

Right, adult beetle; left, larva. Enlarged. (After S. J. Hunter.)

Another parasite on this plant-louse is a tiny four-winged insect

which lays its eggs in the body of the green-bug, where they hatch and kill the host.

**32. Harvesting and marketing.** — Oat grains mature from the top of the panicle downward. Most of the grains should change color and be in the late dough stage, or riper, before being harvested for grain. The harvesting of oats is done with the self-binder or the mowing machine, or on small areas of rough land with the grain cradle.

It is an advantage in threshing if the grain is tied in bundles, as is done by the self-binder or by laborers following the cradler.

Oats are marketed without any special preparation beyond that of sacking.

It is customary in some communities for oats to be bound into bundles and shocked, left for a week or more in the shocks, and then stored for several weeks in a stack or barn before being threshed; however, oats are often handled directly from the shock to the threshing machine. Damp or rainy weather during threshing renders this operation slower and more incomplete.

**33. Yields.** — For the first few years in the twentieth century the world's oat crop averaged approximately 3,500,000,000 bushels, of which more than one fourth was produced in the United States, on about 28,000,000 acres. The average for the United States is usually between 30 and 35 bushels per acre. This yield is much below that in Germany and Great Britain.

For oats sown in the fall in the cotton-belt a yield of less than 20 bushels may be regarded as poor; of 20 to 30 bushels as fair; and a good yield is one exceeding 40 bushels per acre.

A medium yield of oat hay is about one ton per acre, which may be greatly increased by the liberal use of nitrate of soda or by sowing seed of hairy vetch or crimson





FIG. 11.—GRAINS GROWN WITH CRIMSON CLOVER FOR FORAGE AT ALABAMA EXPERIMENT STATION.

On left, oats; on right, wheat.

clover with the seed oats in September or October (Fig. 11).

For oats sown after Christmas in the Gulf States the yields may be taken as not quite two thirds of the figures for fall-sown oats on the same land.

In several instances yields of more than 100 bushels per acre have been reported in the Southern States.

At the Alabama Experiment Station on poor, sandy loam soil the yield averaged about one and one half times as many bushels of fall-sown oats as of corn similarly fertilized. Considering that oats weigh 32 pounds per bushel, as compared with 56 pounds per bushel of corn, there was nearly an equal weight of grain produced whether the crop was corn or oats.

In the case of a medium yield of Red Rust-proof oats there is about one pound of straw for each pound of threshed grain. That is, a yield of 32 bushels of oats, weighing 960 pounds, is usually accompanied by a yield of about half a ton of straw.

**34. Teams and labor for oat culture.** — The oat crop requires little expenditure for hand labor. Machinery and horse tools perform most of the work. By sowing oats in the fall, the farm teams are kept employed at a time when, on cotton-farms, there is usually no large amount of other work for them. However, the date of harvesting occurs during the busy season when teams and laborers are needed in the early tilling of cotton and the tillage of corn. Therefore any farm on which a considerable proportion of the acreage is devoted to oats should be well stocked with teams and so situated that additional laborers can be hired for a few days during harvest.

When additional day labor cannot be hired to shock a large area of oats in a brief time, the harvest season can be spread out over a longer period by sowing a part of the

area in Red Rust-proof oats and a part in some variety ripening either earlier or later.

### LABORATORY EXERCISES

#### Young plants in the field.

(1) From a number of plants of wheat, oats, rye, and barley, pulled and mixed together, separate all the oat plants by the absence of clasps (auricles) on the leaves. Repeat until young oat plants are readily recognized.

(2) With specimens used in (1) or growing in the field, write out other means of distinguishing leaves of oats from those of each of the other small grains.

(3) Compare several varieties of oats, if available, as to differences in appearance of the young plants.

(4) Dig four young plants sprung from seed buried deeply and four others from seed lightly covered; record for each plant of each class the length of that section of root between the parent grain and the crown, or place where most stems originate.

#### Examination of bloom.

(5) Pinch off the smaller flower in a spikelet, and treat the larger as follows: With pin or small forceps open the incurved transparent inner hull, or palet, before the pollen has been shed, and make a drawing, showing the number and position of stamens and stigmas.

#### Crossing oat flowers.

(6) If practicable to execute No. (5) at 8 to 10 A.M., practice opening several flowers in such a way as to give least injury to the transparent inner covering or palet; when successful, remove with a pin the three unopened anthers; carefully replace the palet; cover with a very small paper bag; about 5 in the afternoon of the same day reopen the same flower and insert on the stigmas an anther that shows loose grains of pollen; replace the palet, and a week later note whether a crossed grain has formed. Repeat this exercise several times.

**Smut.**

(7) Insert a barrel hoop, or sides of a bottomless box, over a number of oat plants in the field; count the number of smutted and healthy heads; calculate the percentage of smutted heads, and the apparent loss per acre from smut if the yield of the field would have been thirty bushels per acre had there been no smut.

**The oat panicle and stems.**

(8) Compare the form of panicle of Red Rust-proof oats with that of Burt or Turf oats.

(9) Record the number of whorls (sets of branches) and the number of spikelets in each of five heads of oats.

(10) Record the total number of stems of ten plants with abundant room and of ten plants in a part of the field where the plants are thick.

**Samples of threshed seed.**

(11) Carry out directions for prevention of smut by the formalin treatment (paragraph 30).

(12) Practice the hot-water treatment for smut.

(13) Save some seed in both treatments above and make a germination test, in soil or in germinating box, of 100 seeds treated with formalin, 100 with hot water, and 100 not treated.

(14) Make a germination test of 100 small seeds from upper grains of spikelets and of 100 large grains, each of the latter being the lower grain of its spikelet; notice results in 7 or 14 days as to percentage of germinated seed and character of sprouts or young plants. (In a good sample, 97 per cent should germinate.)

(15) Note all differences between seeds of Red Rust-proof, Burt, and Turf types of oats.

(16) Make drawings of a spikelet of Red Rust-proof freed of chaff, showing number and position of beards. Do likewise for some other variety.

(17) Determine the weight of a measured bushel of several samples of oats, by weighing a gallon or peck.

**Scoring.**

(18) Score as many samples of threshed oats as practicable, by the following score-card:—

1. Trueness to type . . . . .	15
2. Uniformity of kernel in size and shape . . . . .	10
3. Purity of color . . . . .	15
4. Cleanliness, or freedom from weed seeds, trash, etc. . . . .	10
5. Seed condition, or germinating power . . . . .	15
6. Proportion of hull . . . . .	10
7. Weight per bushel . . . . .	25
Total points . . . . .	<u>100</u>

## LITERATURE

**Cultural Methods.**

DUGGAR, J. F. Ala. Expr. Sta., Bul. No. 137.

REDDING, R. J. Ga. Expr. Sta., Buls. Nos. 44 and 72.

TEN EYCK, A. M., and SHOESMITH, V. M. Kan. Expr. Sta., Bul. No. 144.

**Composition.**

PETER, A. M. Ky. Expr. Sta., Bul. No. 99.

STORER, F. H. Agriculture in its Relation to Chemistry, Vol. II, p. 400.

**Breeding.**

NORTON, J. B. Am. Breeders' Asscn., Vol. III, pp. 280-285.

**Score-card.**

LYON and MONTGOMERY. Examining and Grading Grains. Lincoln, Neb.

TEN EYCK, A. M. Kan. Agr. Col., 1907. Rules for Judging and Grading Small Grains.

**Enemies: Green-bug.**

HUNTER, S. J., in Kan. Bd. Agr., 1907.

U. S. Bur. Entomology, Bul. No. 38, and Circs. 81, 85, and 93.

## CHAPTER II

### WHEAT—TRITICUM SATIVUM

WHEAT belongs to the grass family, and is thus closely related to all the other cereal grains and to the forage grasses. All the various wheats are included in the genus *Triticum*, which term thus forms the first word in the botanical name of wheat. All kinds of wheat are annuals.

Wheat is chiefly used for the manufacture of flour. From the wheat grain are also made breakfast foods, macaroni, and other articles for human nourishment. When the price of wheat is low, the grain is sometimes fed to all classes of live-stock. It is especially prized as a food for poultry.

The wheat plant affords valuable winter pasturage, and when cut before ripening, it makes hay of good quality. For use as hay a variety having no beards is, of course, preferable. In the southern parts of the Gulf States, wheat is more valued for forage than for grain.

### STRUCTURE AND COMPOSITION

**35. Roots.** — The wheat has fibrous roots, and in this respect it is entirely unlike such plants as the legumes, cow-peas, clovers and cotton, which have tap-roots. The roots of wheat do not extend so widely as do those of corn and cotton. The roots originate at the crown, which is usually

within an inch of the surface of the ground, whatever may have been the depth of planting.

However, before the crown and the main or permanent system of roots are formed, three short temporary roots develop from the sprouted grain; thus the depth of these temporary roots depends upon the depth of planting. They serve no further use after the development of the numerous permanent roots originating chiefly at the crown. Hence, the depth at which the wheat roots and feeds is independent of the depth at which the seed is sown.

**36. Stems.** — The stems or culms of wheat are hollow, with closed or solid joints. The usual height is three to five feet. When the straw grows to great length, there is danger that the plant may “lodge” (fall), thus interfering with the perfect development of the grain and making harvesting difficult and incomplete. As a rule, wheat grows taller than barley and not so tall as rye. The weight of straw is usually nearly twice the weight of grain, but it may vary widely from this.

A single wheat grain may give rise directly to a single culm and indirectly to a score or more of stems, as explained below. The buds at the lower nodes (joints) of each culm may themselves develop into additional culms, and from the lower nodes of these still other stems may spring. This formation of culms from lower buds at the underground nodes of each stem explains how and why wheat and other small grains tiller; that is, they produce a number of stems from a single seed. The greater the space between plants and the greater the rainfall and supply of plant-food, the greater is the number of culms from a single crown.

**37. Leaves.** — The leaves of wheat vary in width, and even in the shade of green. As a rule, they are narrower than the leaves of barley and oats. Young wheat plants of the species usually cultivated in the United States (*Triticum sativum*) may be distinguished easily from those of the other small grains by the two small clasps (auricles) that partly encircle the stem where the blade, or free part of each leaf, unites with the sheath (Fig. 12). In



FIG. 12.—PART OF A YOUNG WHEAT PLANT.

Showing clasps bordered with hairs.

the young wheat plant these clasps bear on their margins a few very inconspicuous hairs. No hairs occur on the larger clasps of barley nor on the smaller auricles of rye. Oats have no auricles.

Young plants of the four small grains, therefore, may be distinguished by the following leaf characters, as well as by others:—

Oats have no auricles or clasps (Fig. 1).

Rye has very small auricles (Fig. 23).

Barley leaves are provided with large auricles (Fig. 28).

Wheat has auricles intermediate in size between those of rye and barley, and on the outer margin of each auricle on American wheats are a few hairs (Fig. 12).

**38. Pollination.** — Although wanting in showy colors, the part from which each wheat grain develops is a true flower. On carefully opening the husk-like inclosing parts in a newly formed head of wheat, within each flower are found three



stamens, which soon afford the yellow powder or pollen. There is also a pair of small glistening plumes (Fig. 13), corresponding to the silks in corn. These are the stigmas or divisions of the pistil, and in these delicate plumes the pollen must lodge and grow before a seed can form.

The plume-like stigmas are snugly inclosed by the chaff, thus preventing the access of any pollen except that which develops within the same flower. Hence wheat is a self-pollinated plant. Therefore, two varieties of wheat sown side

by side do not cross or mix, unless the seed be mechanically mixed by careless handling.

Two varieties of wheat can be crossed or hybridized by removing the pollen-cases (anthers) before they burst, and then, a little later, by applying to the stigmas pollen from a plant on which the anthers have just set free the pollen. The best time for hybridizing wheat is before daybreak.

**39. The spike and the spikelets.**—“Spike” is the name given to the entire head of wheat, and spikelet is the name of a group of flowers or grains springing from the same place on the stem. The head or spike is borne at the top of each completely developed stem or straw. In wheat there is only one spikelet, or flower-cluster, at each node or joint. The spikelets are arranged alternately on the zigzag stem (or rachis). The spikelets are arranged flatwise to the stem.



FIG. 13.—FLORET OF WHEAT. Showing two stigmas and two of the three anthers.

The shape of the spike differs in certain species and varieties of wheat and may be (1) tapering, or (2) nearly uniform in size, or (3) club-shaped (that is, decidedly largest at the extreme upper end) (Fig. 17). The shape of the spike or head depends largely on the size to which the spikelets in different parts of the spike develop.

Comprising each spikelet are usually three or more flowers (Fig. 14). From them, when all conditions are favorable, may develop three grains. More frequently, only two flowers develop, and the spikelet yields only two grains, sometimes only one. A crop with "three grains to the mesh," as some farmers express it, should make a large yield.

In some varieties, beards project from the tips of certain of the chaff-like parts which inclose the seed. It has not been proved that bearded varieties of wheat are any hardier or

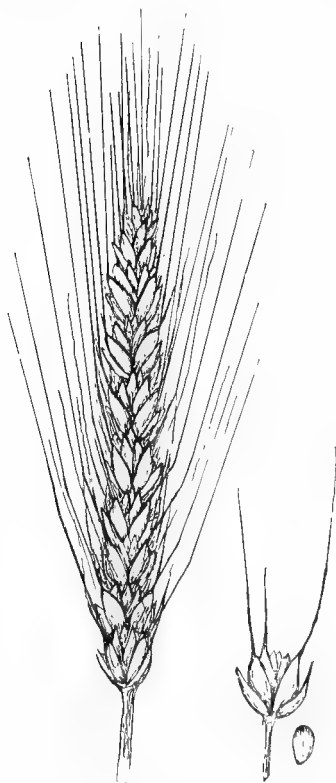

FIG. 14.—A HEAD, SPIKELET, AND GRAIN OF BEARDED WHEAT.

any more productive in the South than beardless varieties (which are also known as "smooth" or "bald" wheats) (Fig. 15). On farms where it is sometimes desirable to utilize at least a part of the wheat crop for hay, beardless varieties are decidedly preferable, and also probably just as good when the sole aim is the production of grain.

**40. The grain.** — When wheat is threshed, the grain is freed from the chaff that has enfolded it. The same is true of rye. On the other hand, the hull of oats continues to enfold the grain after threshing, and in barley the hull grows fast to the grain.

A single grain of wheat is usually about a quarter of an inch long. A deep furrow or crease extends nearly the length of the grain on the side opposite the germ or embryo. The greater depth of this furrow, together with the shorter, plumper grain (Fig. 16), readily distinguish a wheat kernel from a grain of rye.

In color wheat grains vary from a light, almost creamy yellow (called white) through an amber tint to dark red. Red and amber-colored wheats are more commonly grown in the South than those of the lighter shades, and probably the former are hardier under Southern conditions.



FIG. 15. — A TYPICAL HEAD OF BEARDLESS WHEAT.

The kernel of wheat is divided into three principal parts: (1) the germ, or embryo; (2) the starchy part, or endosperm; (3) the several outer layers constituting the bran. The germ, which may be located by a tiny scar, constitutes only a very

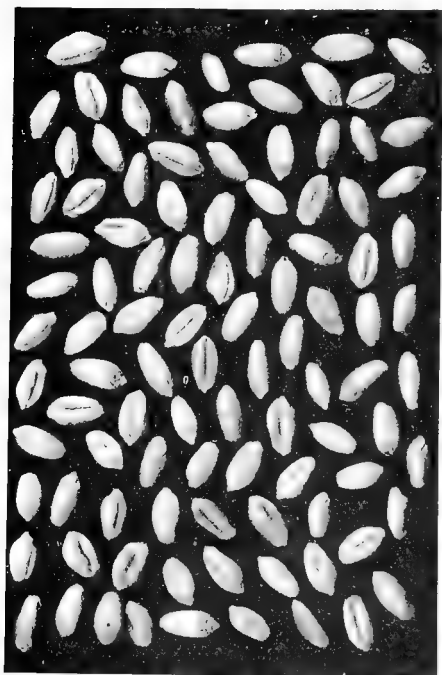

FIG. 16.— A GOOD SAMPLE OF WHEAT.

small proportion of the grain, occupying only about one thirteenth as much space as the endosperm. The starchy portion, or endosperm, is the part from which flour is made. This is a reserve supply of food material stored by the maturing plant for the nourishment of the young seedling before the roots of the latter are able to furnish a full supply of plant-food. The bran consists of several coats, the outer of which corresponds botanically to the pod that covers a pea or bean.

Wheat grains are of such size that usually from 500,000 to 1,000,000 are contained in a bushel, though the number is occasionally below and sometimes above these limits. The legal weight of a bushel of wheat is 60 pounds, but a measured bushel often weighs several pounds less, and sometimes a few pounds more than the standard.

**41. Composition.** — In round numbers, the entire wheat grain has the following average composition: —

	PER CENT
Water . . . . .	10.5
Gluten and other nitrogenous constituents (protein) . . . . .	12.0
Fats, etc. . . . . a little more than	2.0
Crude fiber . . . . . a little less than	2.0
Ash . . . . . a little less than	2.0
Starch and other nitrogen-free extract . . . . . more than	71.5
Total . . . . .	<u>100.0</u>

The higher the percentage of protein in normally matured wheat grains the higher, as a rule, are the quality and breadmaking value of the wheat. The protein is often as much as 2 per cent either above or below the average just given, and still greater extremes in composition sometimes occur. Any climatic or other condition that prevents the complete maturity of the wheat into plump grains tends to reduce the proportion of starch, which is the material last to be added to the grain; this reduction in the percentage of starch naturally raises the percentage of nitrogen. It has been found at the Tennessee Experiment Station (Bul., Vol. XVI, No. 4) that wheat grown in the South contains a high percentage of protein. Hard grains, which present a horny appearance, are usually richer in protein than those which have a less flinty appearance.

Gluten, the principal nitrogenous constituent in wheat, is not only prized for its high nutritive value, but also because to its presence is due the "rising power" possessed by wheat flour as compared with flour or meal from Indian corn. Gluten is the sticky residue left in the mouth when one chews unground wheat grains. The favorable action of this sticky gluten in making flour bread to rise, or to

become "light," is due to the fact that the gluten entangles and holds in the dough the bubbles of carbonic acid gas formed by fermentation when yeast is added to dough.

### SPECIES AND VARIETIES

**42. Species and subspecies.**—The genus *Triticum*, to which all forms of wheat belong, includes eight species or subspecies. Only one of these is generally cultivated in the South, namely, the winter-growing form of common wheat (*Triticum sativum vulgare*). Spring wheat is unsuited to the South.

*Macaroni wheat* (*Triticum durum*) is adapted to a semiarid climate. At least one of its varieties, under the name of Nicaragua wheat, has been successfully grown in the drier portions of Texas. Macaroni wheat in that climate makes a large yield of grain, which is suitable either for the manufacture of macaroni or vermicelli, or for stock food. Macaroni wheat is bearded. In its early growth it is more erect, and the plant is less inclined to stool or tiller than common wheat.

Other forms of wheat, not grown in the South, are the following:—

*Club wheat* is the favorite kind in Oregon and Washington (Fig. 17).

*Spelt* is one form in which the chaff clings to the grains after threshing.

*Emmer* is useful for its resistance to drought and to rust, and is especially promising as a forage plant in the semiarid Northwest. It seems to be unpromising for the South because most of the varieties require sowing after winter has passed.

*Poulard wheat* is closely related to macaroni wheat.

*Branching wheat* is so named because the head is branched. In this class belongs the variety recently advertised under the name of Alaska wheat, which has generally proved an inferior kind.

*Polish wheat* is characterized by very large kernels. It is not suitable for breadmaking, but for the manufacture of macaroni.

One-grained wheat (*einkorn*) is another unpromising kind.

#### 43. Varieties of winter wheat.

— Although more than a thousand varieties of wheat are known, those extensively grown in the cotton-belt are probably less than a score in number. Among

the most popular and productive varieties are the following:—

*Blue Stem or Purple Straw.*— This is so named because of the purplish tint on the upper part of the ripened straw. It is beardless, and hence suitable for



FIG. 17.—HEADS OF WHEAT.

On left, Golden Chaff; in center, Currell; on right, Club.

hay as well as for grain. When the seeds are continuously grown in the South, it is one of the earliest varie-



FIG. 18.—HEADS OF WHEAT.

On left, Fultz, then Blue Stem; on extreme right, Fulcaster, next to which is Club.



ties. The grain is amber-colored or reddish, and of medium size.

*Fultz* (Fig. 18).—This variety is widely grown in the South. It is practically beardless, though very short beards are found in the upper part of the head on a few of the glumes, or chaffy parts. It may be used for hay as well as for grain.

*Red May*.—An early beardless variety.

*Fulcaster* (Fig. 18).—A bearded variety widely grown in the South, and generally found to be comparatively hardy and productive.

**44. Most productive varieties of wheat.**—There is no one variety of wheat that is best for all seasons and for all localities in the South. This explains why variety tests present such different results in different years.

In experiments made at the Test Farms in North Carolina, during several years, Golden Chaff, Bearded Fulcaster, and Improved Amber were among the most productive varieties.

At the Alabama Experiment Station, a local strain of Blue Stem has been the earliest and one of the most productive varieties tested. Fulcaster has also made good yields of grain.

At the Oklahoma Station, Sibley's New Golden was one of the best varieties. This is a bearded variety with soft grains. At the same station good yields were also made by Blue Stem and Fulcaster, and by some of the hard wheats, including among others, Turkey Red. (Okla. Expr. Sta., An. Rpt., 1908-1909.)

**45. Means of distinguishing varieties.**—Varieties are distinguished by the presence or absence of beards; by the

color of grain; by the color of chaff; by the presence or absence of hairs ("velvet") on the chaff; by the height of straw; by the time of maturity; and by other characters. Hence, it is evident that a variety cannot be identified merely by an inspection of the grain itself. Indeed, positive identification of the variety is almost impossible, even when the mature plants are examined in the field. Yet it is important that growers keep each variety pure, to insure uniformity in ripening and in quality of grain, and in order to propagate only the best varieties.

**46. Qualities desired in varieties for the South.** — The qualities chiefly desired in varieties of wheat for the South are the following: —

(1) High yield.

(2) Rust-resistance, and earliness, as a means of minimizing the injury from rust.

(3) Resistance to drought, though marked differences in this respect among American varieties have not been demonstrated.

(4) More than the average percentage of protein, and good quality of the flour produced.

**47. Improvement of varieties.** — Wheat can readily be improved by selecting for seed the best individual plants; for example, those affording a larger yield than other plants having an equal amount of space and fertilizer, or those most resistant to rust, or the earliest productive plants. Improvement will be more rapid if farmers specially interested in breeding up their wheat would set apart small areas, for use as breeding nurseries, where the seed from each selected plant could be sown in a separate row. The seed from the best of these rows should be planted the next

year on a larger area. By the third year, there should be enough seed to plant a small field.

In selecting for rapid improvement, it is much more important to choose the *best plants* than to pick out the largest grains or the best single heads.

Hand selection of the best plants, even without separate breeding rows, will improve the variety and increase the yield. Hunt expresses the belief that the most promising means of increasing the yield is by selecting to increase the number of spikelets on a spike. Breeding should also be directed towards increasing the size of grain and the resistance to rust. (See 58.)

#### SOILS, ROTATION, AND FERTILIZERS

**48. Soils.** — Wheat thrives better on a clay or loam soil than on one that is sandy. Most suitable of all is a lime soil, if it also contains considerable clay.

Wheat does not thrive on acid soils. Hence, the acid areas so often found among the sandy soils of the Gulf States should be avoided for this crop, or else limed with from 1000 to 1500 pounds of slacked lime per acre as a preparation for wheat. Liming is best done through the grain drill, several weeks before the seed are planted. When applied on the surface, lime should be well harrowed in.

In choosing a field for wheat, wet, undrained spots should be avoided. The crop is less likely to suffer severely from rust if grown on upland than if sown on lowland completely surrounded by higher land and from which field there is consequently no air drainage. Yet, bottom lands of suitable character in favorable years afford large yields of wheat.

In the northern part of most of the Gulf States are found many soils suitable for wheat, after they have been somewhat improved

by the addition of vegetable matter. Among such soils may be especially noted the limestone valleys, and also the reddish clay or clay-loam soils of the Piedmont region or foothills, the latter being designated in the soil survey reports as belonging to the Cecil series of soils.

Likewise, the waxy lime lands of central Alabama, north-eastern Mississippi, and of Texas, offer suitable conditions for the growth of wheat when sufficient vegetable matter is incorporated with the soil. On all of these and on many Southern soils, now seldom or never utilized for wheat, this crop should become an important one when the presence of the boll weevil or other incentive shall make imperative a more diversified agriculture.

Wheat needs a rich or fairly rich soil. More economical than the use of most forms of commercial fertilizer is the improvement of the soil for wheat by a preceding crop of cowpeas or of other legumes. This is the cheapest means of adding nitrogen, the most expensive plant-food purchased in commercial fertilizers. The preceding crop of legumes should be fertilized with acid phosphate, so as to enable the legumes to make a more luxuriant growth and thus to add to the soil a larger amount of nitrogen than would be possible if this crop had been grown without fertilizer. If the preceding crop of cowpeas is luxuriant, it will often suffice to plow under merely the stubble as a fertilizer for wheat, utilizing the tops of the legume for hay.

Among the legumes that may be used to fit the land for a profitable crop of wheat are the following: cowpeas and soybeans, as summer growing legumes, on any soils; red clover on lime soils; sweet clover (*Melilotus alba*) on the waxy lime soils; and crimson clover, a winter-growing annual that is adapted to almost any soil suitable for wheat.

**49. Place in the rotation.**— In the cotton-belt, the crop preceding wheat is usually cowpeas, either grown alone or as a catch-crop between rows of corn. It is not unusual for a growth of cowpeas to add 4 to 10 bushels of wheat per acre to the yield of the following wheat crop.

In those parts of the South where red clover is grown, a good three-year rotation is:—

First year: wheat, with red clover seed.

Second year: red clover.

Third year: corn.

Wheat is again grown the fourth year.

Where neither red clover nor cotton succeeds, crimson clover may be used instead of red clover, as follows:—

First year: late corn, cultivated late, and the middles seeded to crimson clover in September.

Second year: tobacco, late corn, or other summer crop not requiring early planting.

Third year: wheat, followed by cowpeas.

In those parts of the cotton-belt where red clover does not thrive, the following four-year rotation is often desirable:—

First year: cotton, with crimson clover seeded in September between the rows.

Second year: cotton.

Third year: corn, with cowpeas between the rows.

Fourth year: wheat, followed by cowpeas.

**50. Fertilization.**—A crop of 25 bushels of wheat, with its accompaniment of say 2500 pounds of straw, removes from the land approximately the following amounts of plant-food:—

	IN GRAIN	IN STRAW	IN GRAIN AND STRAW
Nitrogen . . . . .	25.9	10.8	26.7
Phosphoric acid . . .	14.4	3.3	17.7
Potash . . . . .	5.3	18.5	23.8

These figures indicate that the grain depletes the land of considerable quantities of nitrogen and phosphoric acid, while the straw removes a large quantity of potash and also considerable nitrogen. The straw, after being used as food or bedding, should be restored to the farm in the form of manure. This, however, will usually not be applied to the field from which the straw was taken.

Phosphoric acid is very generally deficient in Southern soils. Phosphate is the fertilizer usually applied to wheat. Two hundred to four hundred pounds per acre may well be employed. The time to apply acid phosphate to wheat is at the time of sowing the grain. It may be sown through the fertilizer attachment of the grain drill and while the seed is being sown. The germination is not injured by phosphate in contact with the seed.

Since wheat makes most of its growth during the cooler part of the year, while decay and nitrification are least active, this plant responds profitably to applications of nitrogenous fertilizers. For the reason just indicated the most readily soluble form of nitrogen, namely, nitrate of soda, is usually the most effective form in which to convey at least a part of the supply of nitrogen to the wheat plant (Fig. 19). On account of its ready solubility, nitrate of soda should not be applied until winter is past and the plants have a well-developed root system ready to appropriate the soluble nitrates. It is well to apply nitrate of soda at least two months before the date of anticipated harvest.

This usually means that in the Gulf States nitrate of soda should be used by or before the twentieth of March, or in higher latitudes at proportionately later dates; 80 pounds per acre is the amount most generally advisable, — though profitable use can

often be made of amounts smaller or larger by 50 per cent. Nitrate of soda should be very uniformly sown, after all lumps have been pulverized. No covering is required, but when harrowing can be done without serious injury to the stand of plants, it



FIG. 19. — SHOCKS OF WHEAT FROM EQUAL AREAS.

On left, fertilized with nitrate of soda; on right, no nitrogen in the fertilizer.

will often be helpful, both as a means of hastening the absorption of the nitrate of soda and also for its effects as a cultivation.

It should always be borne in mind that the application of very large amounts of nitrogen in any form, even in barnyard manure, may cause the straw to grow so tall and weak that it may fall, or lodge. The application of phosphate and kainit is believed to have a tendency to strengthen the straw and to reduce the danger of lodging.

Formerly when cotton-seed was worth less than twelve dollars per ton, it was largely used as a fertilizer for wheat. Cotton-seed was plowed in when the wheat was sown, and its use, especially when combined with acid phosphate, was effective. Cotton-seed is now in most localities too

high-priced to be used as a fertilizer for wheat in competition with cotton-seed meal or nitrate of soda.

Cotton-seed meal is a common ingredient of a fertilizer mixture for wheat. It is usually less effective and economical for wheat than an equal value of nitrate of soda. When cotton-seed meal is used, it should be applied before the wheat is sown, and the seed should not be permitted to come in contact with it, since the meal, in its decay, has an unfavorable effect on the germinating seed. Hence, to avoid injuring the stand, no considerable amount of cotton-seed meal should be applied while the seed are being drilled in. The meal may be first drilled in, or sown broadcast and harrowed in, and then the seed sown. The same caution may well be exercised when the fertilizer contains any considerable amount of kainit, or muriate of potash, dried blood, or tankage.

Most fertilizer tests show smaller gains from the use of potash as a fertilizer for wheat than from the use of nitrogen or phosphoric acid. For soils not in the best condition for wheat the following formula will often prove profitable:—

200 pounds acid phosphate per acre and

25 pounds of muriate of potash (when the seed are sown).

100 pounds nitrate of soda (early in March).

In case the preceding crop is cowpeas, the nitrate of soda may be reduced or omitted.

The cowpea plants, which usually follow wheat, may utilize some of the phosphate not used by the grain crop.

## CULTURAL METHODS

**51. Preparation of land.**—Wheat requires a carefully prepared seed-bed, moderately compact in the lower layers and loose and fine near the surface. In order to permit the



soil to settle or become moderately compacted by rain, plowing for wheat should be done, if practicable, at least several weeks before the anticipated date of sowing the seed. In Oklahoma it has been found advantageous to plow for wheat as early as midsummer. Plowing three to six weeks before seeding is often advisable; but when wheat follows catch-crops of cowpeas, it is often necessary to sow it soon after plowing under the cowpea stubble and to rely upon harrowing and rolling to compact the soil. Immediately after plowing and before the upturned soil has dried into clods, the field should be harrowed. Harrowing should be repeated at such intervals between the dates of plowing and sowing as to prevent the formation of a crust or the growth of vegetation.

If no rain falls near the time of plowing, it will be advisable to employ the roller or plank drag in addition to the harrow, in compacting and pulverizing the seed-bed for wheat. In case the soil is excessively dry, it may be necessary to use the roller after sowing the seed, to enable moisture from the subsoil to be conveyed more easily by capillary attraction through the rolled soil to the seeds, which, by means of the roller, are pressed into close contact with the particles of soil.

However, the same compactness that makes it easier for the moisture in the rolled soil to rise from the subsoil to the seed also makes it easier for this moisture to continue to rise to the surface, where it would be lost by evaporation. Hence, evaporation must be decreased by forming a mulch, or layer of loose soil on the surface, which is most easily done by using a harrow or weeder after the roller.

The sowing of wheat on land which has not been plowed, but merely disked, is sometimes practiced on clean mellow soil in higher latitudes. This procedure has been found insufficient in the South.

**52. When to sow wheat.** — The kind of wheat grown in the South should be sown in the fall. In the Gulf States some wheat is sown as late as the first part of December. This is too late for the maximum yield, even in the central or southern parts of the Gulf States.

The best date for sowing wheat depends on the following considerations: —

(1) The average date when killing frost occurs in each locality.

(2) The latitude and altitude.

(3) The fertility of the soil.

**53. The date as determined by killing frost.** — In North Carolina and the other parts of the cotton-belt in which the Hessian fly, or “wheat-fly” occurs, sowing is postponed, if practicable, as late as necessary to insure that the young wheat plants do not come up until after a killing frost has occurred. This is because a killing frost stops the laying of eggs by the Hessian fly, and because if young wheat plants should appear above the ground before that time, the eggs would be deposited on them and the crop subsequently injured by the insects developing from the eggs. It was found that in the northern part of Georgia (Ga. Bd. Entomology, Circ. 7), wheat sown during the last 10 days in October practically escaped injury.

**Average dates of first killing frost.** — The average dates of first killing frosts for typical southern localities, as determined by the Weather Bureau, are as follows: —

Blacksburg, Virginia, Sept. 30.	Asheville, North Carolina,
Lynchburg, Virginia, Nov. 1.	Oct. 20.
Knoxville, Tennessee, Oct. 27.	Charlotte, North Carolina,
Nashville, Tennessee, Oct. 24.	Nov. 4.

Greenville, South Carolina, Nov. 6.	Montgomery, Alabama, Nov. 8.
Atlanta, Georgia, Nov. 7.	Columbia, South Carolina, Nov. 8.
Decatur, Alabama, Oct. 15.	Shreveport, Louisiana, Nov. 11.
Memphis, Tennessee, Oct. 28.	Dallas, Texas, Nov. 15.
Opelika, Alabama, Nov. 9.	

The average date of killing frost will usually prove a satisfactory date for sowing wheat in the northern and central parts of the cotton-belt. North of the cotton-belt, a date slightly ahead of the average date of killing frost may afford a larger yield. South of the area where the Hessian fly occurs, the sowing of wheat may be several weeks earlier than the average date of first killing frost.

**54. Climate and soil as related to the best date for sowing wheat.** — The cooler the climate, — that is, the higher the latitude and the greater the altitude, — the earlier must wheat be sown to afford the maximum yield. Early sowing usually affords the largest yield, since it provides a longer time for the plant to develop a strong root system, to tiller or thicken more completely, and to collect plant-food. However, extremely early sowing is inadvisable, even in regions where the Hessian fly is not present, since this causes the plants to enter the boot stage — that is, to form stems — before all freezing weather is past. In this stage plants of all of the small grains are especially liable to injury by a degree of cold that would not prove harmful to plants that had not begun to form stems.

The poorer the land the more urgent the need for a rather early date of sowing, so that the early sowing may encourage tillering, which is not favored by poor soil.

For the central part of the cotton-belt, the first half

of November may be regarded as a generally satisfactory date for sowing wheat.

**55. Drilling versus broadcast sowing.**—Experiments in the principal wheat-growing states show a larger yield from

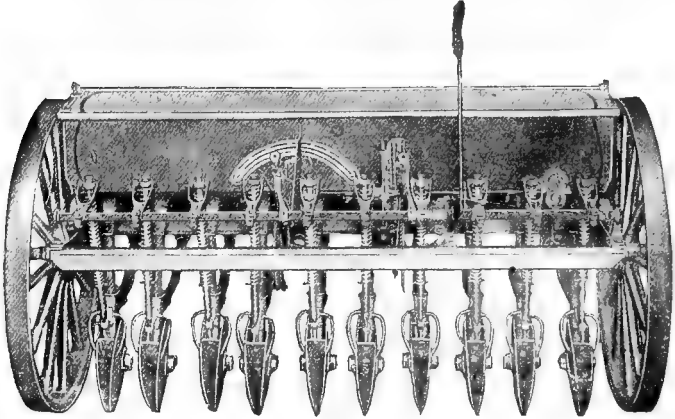

FIG. 20.—DOUBLE-DISK GRAIN DRILL.

drilling wheat by the use of a grain drill (Fig. 20), sowing the seed in rows, 6, 7, or 8 inches apart, than from sowing broadcast. The advantages of drilling are the following:—

- (1) Usually a somewhat larger yield.
- (2) Planting at a more uniform depth and hence greater uniformity in the ripening of the plants.
- (3) Slightly increased protection from winter-killing through heaving, that is, the lifting of the young plants above the surface by the expansion of the moisture in the soil when it freezes; the plants growing in the slight depression left by the drill are in the position where there is

least tendency for the soil and the plant to be pressed upward.

(4) A saving of 1 to 2 pecks of seed wheat per acre when the seed is drilled.

The increased yield from drilling at the Kentucky Experiment Station averaged 4 bushels per acre.

The slight ridges left by the grain drill are advantageous in the colder parts of Virginia and Kentucky, and still more so further north, since they hold the snow and thus keep the plants warmer than they would be if exposed to very severe cold, without the covering of snow. This consideration does not apply to most Southern States, in which snow normally lies on the ground for only a small portion of the winter.

**56. Seeding machines.** — Of the several types of grain drills, the disk drills (Fig. 20) are preferable, especially where there is much litter, stone, or other obstruction. For land that is clean and in excellent condition, the hoe drill and the shoe drill are also satisfactory. Most drills are provided with fertilizer attachments, and attachments for sowing grass or clover seed can also be purchased.

Broadcast sowing is usually done by hand. Yet there are cheap and efficient broadcast seeders that may be hung from the sower's shoulders; there are also broadcast seeders that may be attached to the rear end of a wagon and driven by the revolution of the wagon wheels.

**57. Quantity of seed.** — In the wheat-growing states, great numbers of experiments have been made on this point. The results have been variable from year to year, with different soils and climates, and with different varie-

ties. In general the highest yields have seldom been made with less than 5 pecks of seed, and usually 6 pecks or more per acre have afforded larger yields than have smaller quantities of seed.

The earlier the sowing and the better prepared the land, the smaller may be the quantity of seed. Varieties with large seed require a greater number of pecks per acre. The richer the soil the greater the number of plants that an acre will provide with food and moisture, and also the greater, with early sowing, will be the amount of tillering. While no general rule is universally applicable, a safe average amount is 5 pecks per acre for drilling and 6 pecks for broadcast sowing.

**58. Large versus medium and small seed.** — (See 47.)

In numerous experiments in Europe and America comparisons have been made between the large and the small seed of wheat, as separated by sieves, and ordinary seed. The results have been variable. Apparently it pays to select the largest grains by means of sieves or other devices connected with fanning machines, — provided a larger volume of the larger seed be sown, so as to afford the same number of plants as a smaller weight of lighter seed. Separation of seed by this means is especially important in the South, where small and shrunken grains frequently occur, often as the result of injury by rust.

However, to improve a variety one must not rely exclusively on sowing the larger grains. Not all of these occur on the best plants, and it is the entire parent plant, rather than an individual seed, that determines the character of the offspring. Fanning and screening should be practiced with the general crop, but to improve wheat rapidly there is also needed a special

seed patch, the seeds for which are all from plants selected as the best.

**59. Change of seed.** — As a general rule, there is no advantage, and often a decided loss in yield, in bringing seed wheat from a different latitude, instead of sowing grain grown in the same climate. Southern seed wheat for Southern fields should be the rule, except where the home-grown crop has been a failure, resulting in small, shrunken grains. There is no inherent advantage in change of seed. Acclimatized seed is more productive and, in the case of wheat, earlier.

**60. Tillage.** — Since wheat is usually sown either broadcast or else in rows 6 to 8 inches apart, it usually receives no tillage after the plants come up. Yet occasionally farmers have drilled wheat in rows far enough apart and have cultivated the crop, with resulting large yields. Such tillage, if given at all, should be extremely shallow, especially in the latter part of the growing season, since many of the roots of wheat are near the surface. It is practicable to till wheat by the use of a light spike-tooth adjustable harrow, or weeder.

The stiffer the soil and the smaller its supply of vegetable matter the greater is the benefit from harrowing wheat before the booting stage. Wheat sown by a grain drill is more satisfactorily harrowed than broadcast wheat. But in neither case is the stand materially thinned by the use of a weeder or harrow when conditions are favorable; for example, — stones and litter absent and plants several months old, but not with stems of any considerable length.

**61. Pasturing wheat.** — Since wheat makes an excellent winter pasture for practically all kinds of live-stock, it is

sometimes grazed in winter, and later used for grain production. Experiments for three years at the Oklahoma Experiment Station resulted in little or no reduction in the yield of grain from judicious pasturing of wheat in winter, when pasturing was not continued beyond March 1. (Okla. Expr. Sta., Rpt., 1906, p. 31.)

When stock was kept on wheat as late as April 15, the grain yield was notably reduced.

In pasturing wheat in winter care should be taken to exclude the stock while the ground is wet. In the case of wheat that is too forward, or in danger of forming culms before freezing weather is past, moderate pasturing is usually advantageous, since it delays growth. Pasturing early in the winter is thought to increase the number of stems to the plant and thus to thicken the stand.

#### HARVESTING

**62. Time to harvest wheat.**—The proper time for harvesting wheat is indicated both by the color of the straw and by the degree of hardness of the grain. Wheat should be cut when the individual grains are soft enough to be indented by the finger-nail, but too hard to be easily crushed between the thumb and finger. At this stage of maturity, the straw of most plants will have turned yellowish. However, when rust is prevalent and increasing, earlier harvesting of the grain crop is advisable. Indeed, should rust become very serious before the grain reaches the milk stage, it will often be advisable to mow the crop promptly for hay. In the Gulf States wheat harvest occurs late in May and early in June, or a little earlier than the harvest of fall-sown red oats.



Wheat is best cut and tied by the self-binder. It should be promptly shocked and capped. Some farmers thresh from the shock a few weeks after harvest, but it is safer to place the sheaf-wheat in stack or barn until ready to thresh. Threshing is usually done by threshing crews that travel from farm to farm.

**63. When to cut wheat for hay.** — Wheat for hay is probably best cut when in the "late milk stage," but if rust is absent, mowing may be deferred until the grain is in the "early dough" stage. If rust promises to be severe, wheat may be mown while still in bloom.

**64. Yields and prices.** — The legal weight of a bushel of wheat is 60 pounds. A measured bushel may weigh a few pounds above or below this weight. The heavier a bushel of wheat, the better is the quality. The average yield of wheat in the entire United States for the ten-year period ending in 1906 was 13.8 bushels per acre. The average of the cotton states is considerably below this figure; but individual farmers in the cotton states sometimes produce an average of more than 20 bushels per acre. The usual price of wheat is from 80 cents to \$1.20 per bushel.

#### ENEMIES

**65. Weeds.** — Numerous weeds grow in wheat fields, either because the seeds were sown as impurities in the seed wheat, or because the weed seeds were already in the ground. Among the most important of these are the following: —

*Cheat or chess.* — A winter-growing annual grass liable to be troublesome in all kinds of grain. It is most abun-

dant and injurious when unfavorable conditions result in a thin stand of wheat. There is no foundation for the belief that wheat may turn to cheat. The cheat comes only from cheat seeds, which are much smaller and lighter than wheat grains. Hence, cheat seed can be separated from wheat by the fanning machine, or by immersing the seed in water, when the sound wheat grains sink, while the cheat seeds float and may be skimmed off.

*Cockle* is an annual plant with large pink flowers and black seeds. The latter are so nearly of the same diameter as grains of wheat that their separation is not easy, and their retention results in very inferior flour. Avoid sowing wheat with these black seed in it. If occasional plants of cockle appear, they should be pulled.

*Wild garlic* (wild onion) and *peppergrass* are among the other weeds often found in wheat fields. The fanning and screening of the seed wheat is the usual means of avoiding peppergrass and other weeds. Recent experiments have shown that millers can separate onion bulblets from wheat by artificially drying the wheat and then passing it through the ordinary cleaning machinery of the mills. (U. S. Dept. Agr., Bur. Plant Ind., Bul. No. 100, Part III.)

**66. Diseases.**—*Rusts* are the most injurious diseases of wheat. The rusts are caused by certain microscopic organisms (fungi). Both the leaves and stems may be affected and changed from a green color by a series of small reddish or black spots from which may arise clouds of powdery spores, or propagating bodies. The destruction of the green coloring matter in the leaf prevents the formation of starch, and results in poor yields of small, shriveled grains. Dampness and heat favor rust. Varieties ripening early

will usually suffer less than late varieties. On low damp land rust is most destructive. Attempts have often been made, with but little success, to breed a rust-resistant variety, that should also be productive and otherwise desirable. Such efforts should be continued. No effective treatment for wheat rust is known.

*Stinking or concealed smut.* — This disease changes the grain into a mass of powdery black spores, with offensive smell. It ruins the flour. As the chaff is not changed, the diseased grains may not be noticed. The spores of this fungus are conveyed by the seed wheat, hence the disease may readily be prevented by either of the following treatments of the seed wheat: —

(1) Immerse the seed or thoroughly dampen them with a mixture of one ounce of liquid formalin in each three gallons of water; keep the seed grains damp and the pile covered with cloth for at least a few hours; then dry and plant the grain.

(2) Or immerse the seed grain for ten minutes in a solution of one pound of bluestone (copper sulfate) in five gallons of water.

(3) Or immerse the seed wheat for ten minutes in water kept at about 133° F., then cool the seed promptly by stirring or by dipping the hot grain into cold water.

*Loose smut of wheat* (Fig. 21). — This disease is known by the occasional heads that contain no semblance of grains, but only small black masses of powder, consisting of spores, which are microscopic bodies serving the purpose of seed for the fungus that causes this disease. It is rarer than concealed smut, and like it, is conveyed by the seed wheat. The fungus causing loose smut of wheat is much less easily



FIG. 21.—LOOSE SMUT OF WHEAT.

destroyed than the organism causing concealed smut of wheat or the loose smut of oats. Treatment is not recommended unless the disease has been injuriously present in the crop from which seed is taken. When treatment is necessary, it kills many of the seed, so that 50 per cent additional seed should be sown.

The treatment when necessary is as follows: Soak the seed wheat for 4 hours in cold water; then scald for 5 minutes at a temperature of 133° F.

In treating seed wheat or other seed grain by any of the above-named methods, the grain after treatment should not be allowed to come in contact with floors or sacks that have not been disinfected; such contact would again infect the treated grain with spores, which would cause the disease.

**67. Insect pests of wheat.**—The *Hessian fly* is the most serious of insect pests and is widely spread. From the egg, laid on the leaf blades of the young plants, hatch tiny insects which

find their way to a point within the leaf-sheath, where their injuries cause many of the stems in spring to break and fall over. The name "flaxseed" is applied to the pupal or transforming stage of the insect because of the resemblance of the pupa in color and shape to a flaxseed. This pest spends the summer on the wheat stubble. Hence the usual means of combating the insect is to burn the stubble, or to plow it in thoroughly. Postponement of sowing until a severe frost occurs greatly decreases the number of eggs deposited in the fall. Rotation of crops is an important means of decreasing the injury.

*Chinch bugs.*— Small insects that undergo a number of changes in size and color; are sometimes injurious to wheat. When warfare is made against them, it is usually after they have emerged from the wheat field and are invading corn fields.

*The wheat plant-louse or "green-bug"* (Fig. 9).— This small greenish plant-louse has in some years proved very injurious to wheat in the south-



FIG. 22.—THE ANGOUMOIS GRAIN-MOTH.  
Enlarged 6 times. (W. E. Hinds.)

western part of the wheat-growing region. Its injury is done by sucking the juices from the plant. Its natural enemies among insects are relied on to keep the green-bug in subjection. One of these, a lady-bug beetle (Fig. 10), has sometimes been propagated by entomologists and sent into the infested regions.

In the shock, stack, or bin the wheat grain is attacked by weevils and by the larva, or worm stage, of the small, gray grain-moth (*Galechia cerealella*) (Fig. 22). The remedies consist in prompt threshing of the grain and in placing near the top of the tight bin of threshed grain one pound of carbon-disulfide for each 30 bushels of grain. This liquid promptly vaporizes. The vapors are destructive to insect life. They are also quite inflammable, so that no fire, or light, or smoking is permissible about the granary while grain is being thus fumigated.

### LABORATORY EXERCISES

#### The young plants.

(1) Repeated tests should be made of the student's ability to distinguish the young plants of wheat, oats, barley, and rye by the auricles (Figs. 1, 12, 23, and 28). If no young plants are available, leaves of mature plants may be used for the same purpose, after dampening them.

(2) Select five young wheat plants, each having abundant space around it, and record (a) total number of stems and (b) average number of stems per plant.

(3) Repeat exercise (2) with five plants closely crowded by other plants. Compare figures for (2) with those for (3).

(4) Plant 25 kernels of wheat at each of the following depths:  $\frac{1}{2}$  inch, 1 inch, 2, 3, 4, 5, and 6 inches. Keep the soil moderately moist; at intervals of a week record the number of plants that have come up from each depth of planting.

(5) After the plants from the deeper depths have been up for two or more weeks, and again at a much later date, carefully dig several plants from plantings made at each depth, and record the distances below the surface at which the principal roots are growing, or depths at which the crown is forming.

#### The mature plants.

(6) If drilled and broadcast wheat are both available, ascertain (by digging the plants) the average number of plants and of stems per square foot of ground surface with each of these two methods of sowing.

(7) From wheat heading in the field or from dried specimens, record the following data for as many varieties of wheat as are commonly grown in the locality :—

- (a) Average height of plant.
- (b) Average number of stems bearing heads.
- (c) Bearded, beardless, or partly bearded.
- (d) Estimated percentage of upper leaf surface covered by rust.
- (e) Has rust attacked the stems slightly, considerably, or not at all?

(8) From dried mature plants in the laboratory, after being moistened, or from nearly mature specimens from the field, describe in writing each of the varieties indicated by the instructor, as to the following points :—

- (a) Bearded, beardless, or partly bearded.
- (b) Average length of head.
- (c) Average number of spikelets per head.
- (d) Difference, if any, in usual number of grains per spikelet in tip, middle, and base of head.
- (e) Difference, if any, in size of grains in tip, middle, and base of head.
- (f) Difference in size of middle grain in a mesh compared with the two outer grains.

#### Character of grain.

(9) For varieties commonly grown in the locality record a description as to each of the following points :—

- (a) Prevailing color, — whitish, amber, or reddish.  
 (b) Hard, medium, or soft, in crushing.  
 (c) Plump, shriveled, or medium-plump.  
 (d) Size of grain, — large, medium, or small.  
 (e) Crease, — deep, medium, or shallow.

(10) Standards for wheat grown in the South have not been agreed on. Until this is done, the following standard for Fultz wheat used in Kansas may prove a useful basis for the formulation of Southern standards.

Fultz. Type : red, soft, winter.

Length of berry : inches,  $\frac{7}{8}$  to  $\frac{8}{8}$ .

Thickness of berry : inches,  $\frac{3}{8}$  to  $\frac{4}{8}$ .

Shape and plumpness : very plump, rounded sides ; shallow groove.

Moisture content : per cent, 10.

Weight per bushel : pounds, 60.

Percentage of soft grains, 90.

Practice scoring wheat grain by the following score-card, or such modification of it as the instructor may direct :—

	PERFECT SCORE	DEDUCT FOR EACH % UNDESIRABLE	1	2	3	4	5
1. Trueness to variety	10	$\frac{1}{10}$					
2. Uniformity in size and shape of kernel	10	$\frac{1}{10}$					
3. Color of grain	10	$\frac{1}{10}$					
4. Freedom from mixture with other grain	15	$\frac{1}{2}$					
5. Size of kernel	10	$\frac{1}{2}$					
6. Per cent and nature of weed seed, dirt, etc.	15	1					
7. Per cent of damaged, smutty, or musty kernels	5	1					
8. Weight of grain per bu.	10	1					
9. Germination	15	1					
Total	100						



## LITERATURE

- BESSEY, C. E. The Structure of the Wheat Grain. Neb. Expr. Sta., Bul. No. 32.
- KILGORE, B. W., and others. Culture and Variety Tests of Wheat. N. C. Dept. Agr. Bul., Vol. 30, No. 8, Aug. 1909.
- HUNT, THOMAS F. The Cereals in America. New York, 1908.
- ELLIOTT, E. E., and LYON, T. L. Wheat. Bailey's Cyclo. Am. Agr., Vol. II, pp. 660-670.
- CARLETON, M. A. The Basis for the Improvement of American Wheats. U. S. Dept. Agr., Div. Veg. Phys. and Path., Bul. No. 24.
- CARLETON, M. A., and others. Field Methods in Breeding Wheat. Am. Breeders' Assen., Vol. V, pp. 185-207.
- SCOFIELD, CARL S. The Description of Wheat Varieties. U. S. Dept. Agr., Bur. Plant Ind., Bul. No. 27.
- HAYS, WILLETT M. Plant Breeding. U. S. Dept. Agr., Div. of Veg. Phys. and Path., Bul. No. 29.
- SOULE, A. M., and VANATTER, P. O. Tenn. Expr. Sta. Bul., Vol. 14, No. 3, and Vol. 16, No. 4.
- LYON, T. L. Improving the Quality of Wheat. U. S. Dept. Agr., Bur. Plant Ind., Bul. No. 78.
- LYON and MONTGOMERY. Examining and Grading Grains. Lincoln, Neb.
- DONDLINGER, P. T. Book of Wheat. New York, 1908.

## CHAPTER III

### RYE AND BARLEY

RYE and barley are not more closely related than the other small grains treated in this book, but they are thrown together in one chapter because they are relatively unimportant in the South. Rye is a cool-season crop, whereas north of the cotton-belt barley is a warm-season crop. Both are members of the grass family (*Gramineæ*).

#### I. RYE—SECALE CEREALE

Rye is an annual winter-growing grain. The acreage in the South is very small compared with that of oats or wheat. The chief use of rye in the South is for pasturage and for soiling (that is, to be used as cut green food).

Other uses of various parts of the plant are the following: The grain is used in the manufacture of alcoholic liquors; it is utilized to a small extent in this country for human food and as a food for live-stock. The straw commands a higher price than that of any of the other small grains. Its principal use is for bedding; for the manufacture of horse collars; and as packing material. Most of the rye grain threshed in the Southern States is used as seed for the succeeding crop. The rye plant makes hay of very poor quality.

**68. Description.**—The grain of rye, like that of wheat, has no adhering hull after it has passed through the thresher.

It may be distinguished from a wheat grain by the longer, slenderer, more wrinkled appearance, and by the fact that the crease is more shallow.

The head of rye (Fig. 23) is longer than that of wheat or barley, and long beards are borne on the tips of the glumes. The heads are usually slightly flattened, the beards being arranged loosely in two rows and not spreading so widely as in bearded wheat and barley.

The young plant of rye may be distinguished from young wheat and barley by the very small auricles at the points where leaf-blade and leaf-sheath join (Fig. 24).

Young rye plants usually show considerable reddish color in the stem, and the foliage

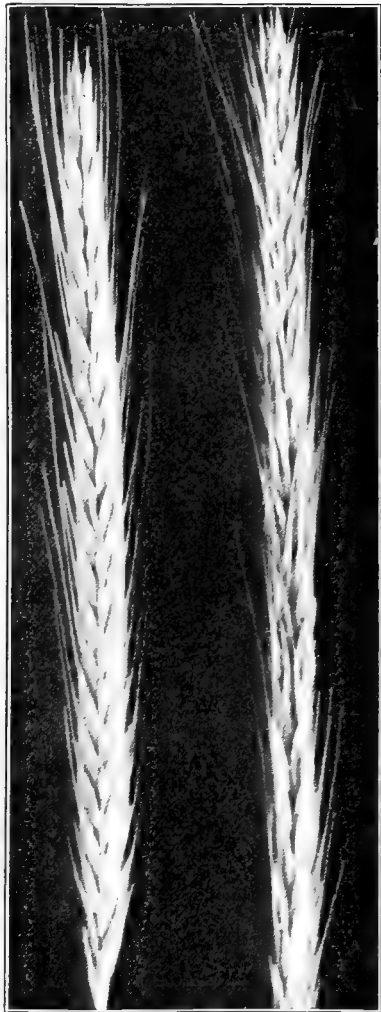

FIG. 23.—HEADS OF SOUTHERN RYE.

is commonly of a grayer green than that of the other small grains.

**69. Varieties.** — There is but a limited number of varieties of rye, even in European countries. Practically only one kind or variety is successfully and generally grown in the warmer portion of the South, which is known simply as Southern rye.

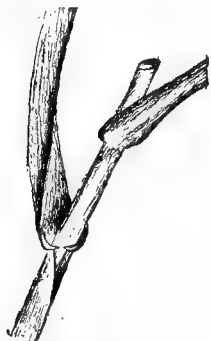

FIG. 24. — PART OF A YOUNG RYE PLANT, SHOWING THE SMALL CLASPS OF THE LEAVES.

The rye flower, unlike that of wheat, oats, and barley, is cross-pollinated, so that it would not be desirable to sow two different varieties near together.

**70. Climate.** — The rye plant is adapted to a wide range of climate. It is hardier towards cold than any of the other small grains and is practically never injured in the South by winter-killing. Rye can be sown suc-

cessfully in a latitude too far south for general success with wheat. However, in growing rye in the South it is very important to use seed grown as far south as practicable. It is thought that seed from the central and lower parts of the Gulf States is better for sowing in the South than that from the extreme northern parts of the same states, and far better than that from still higher latitudes. Northern rye spreads out so closely on the ground that it does not afford the best early winter pasturage, and seed from higher latitudes produces a smaller plant that is more subject to rust than Southern rye.

**71. Soils and fertilizers.** — Rye can be grown on almost

any soil, provided it be fairly well drained. It has been found to endure a greater amount of acidity in the soil than oats, wheat, or barley plants. (R. I. Expr. Sta., Rpt. 1907, p. 359.)

While rye will grow on poor soils, it is possible to make large yields of forage only on rich or highly fertilized land. With rye intended for soiling, a liberal use of stable manure constitutes the best fertilization. If commercial fertilizers alone must be used, it is usually advisable to apply acid phosphate; in addition cotton-seed meal may be applied at the time of planting and not in contact with the seed, or else nitrate of soda may be employed as a top dressing before the stems have formed. On very sandy soils there may be need for a small amount of potash.

**72. Preparation and sowing.** — Rye may be sown either (1) broadcast, or (2) in drills 6 or 8 inches apart by the use of a grain drill, or (3) it may be sown by hand or planter in drills 18 to 24 inches apart. For soiling purposes it is preferable to sow in drills, but for grazing, broadcast sowing is the most common. Rye may be sown through a longer period than any of the other small grains. September 1 is not too early for a sowing on rich land with the purpose of furnishing soiling food in December, January, and February. Sowings may be made at intervals throughout the fall and even up to December 15, the later sowing making a smaller yield. When sown broadcast, the amount of seed needed for grain production is 4 to 5 pecks per acre, and for pasturage 6 to 8 pecks. In planting rye in 18-inch drills, one bushel per acre is usually sufficient. For pasturage, rye may be sown with crimson clover (Fig. 25) or with other winter-growing legumes.



FIG. 25 — A MIXTURE OF RYE AND CRIMSON CLOVER.  
Showing the height to which rye grows.

**73. Utilization.** — On rich land rye sown early in the fall may be cut three or even four times as a soiling crop, the first cutting being made in December or January. In order to secure several cuttings, the plant must be cut just

before the heads appear. The later the sowing and the poorer the land the later the date at which rye can first be used as a soiling crop. Under average conditions this is from February 15, to March 15 in the central part of the Gulf States. Southern rye is somewhat earlier in maturing than most varieties of wheat or oats.

Rye for pasturage must be kept rather closely grazed in the spring or else some of the plants will develop tall stems, and in this condition these plants will not be readily eaten by live-stock.

Rye for grain may be harvested with a self-binder, or if too long for this, with a self-rake reaper. There is usually about twice the weight of straw as of grain. Good yields in the South are from 10 to 18 bushels per acre.

If rye straw is to be sold at the highest price in the Northern cities, it should be threshed on a special machine or rye beater. This does not tangle the straw, which is subsequently bound into bundles and baled in a special press, for which doubtless an ordinary cotton press could be substituted.

**74. Enemies.** — Rye, like wheat, is injured by the Hessian fly, but has a smaller number of insect enemies than most grains. Among its fungous diseases is *ergot* (Fig. 26), which causes the affected grains to enlarge and project conspicuously from the head, such grain constituting a poisonous food. Preventive measures consist in avoiding the use of seed rye containing such diseased grains and in sowing



FIG. 26. — ERGOT  
IN A HEAD OF  
RYE.

rye on a field where there has not before been ergot on rye, nor on any of the related wild grasses. Fortunately, ergot is not very common in the South.

## II. BARLEY — HORDEUM SATIVUM

Barley is an annual grain of comparatively slight importance in the cotton-belt. In regions where it is grown for seed production, the grain is utilized chiefly in the production of beer, and great pains is taken to produce a grain of the highest quality and free from weather stain or other injury.

The chief use of barley in the South is for pasturage and as a soiling plant. It is sown in the same way as rye. Green barley is considered to be more palatable than pastures of any of the other small grains, but the amount of pasturage per acre is usually smaller than that from rye.

**75. Description.** — Barley has the shortest straw of any of the small grains. The heads are usually armed with strong, long, spreading beards, that grow from the tips of the glumes (Fig. 27). In spite of this objection, barley is used in California as a hay plant, but its use necessitates the frequent removal of the beards from the gums of the horses consuming it.

The clasps at the junction of leaf-sheath and leaf-blade are larger on

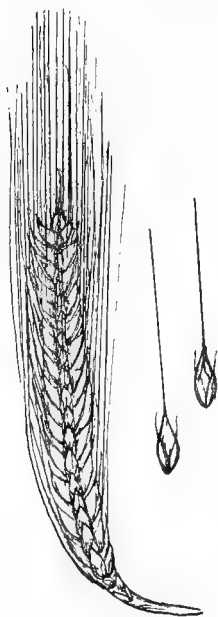

FIG. 27. — A HEAD AND GRAINS OF BEARDED BARLEY.



the barley plant than on any other of the small grains (Fig. 28).

The hull of the barley grain grows tight to the kernel, and the grain, instead of being roundish, as in oats, has a distinctly ribbed or angular appearance.

The weight of barley is 48 pounds per bushel.

**76. Composition.** — The following figures are quoted from H. R. Smith's "Profitable Stock Feeding" to show the relative composition of the seed or grain of barley, rye, wheat, oats, and Indian corn: —



FIG. 28.—THE LARGE CLASPS OF BARLEY LEAF.

	PROTEIN	FAT	CRUDE FIBER	CARBOHYDRATES
Barley, grain . . . . .	12.4	1.8	2.7	69.8
Rye, grain . . . . .	10.6	1.7	1.7	72.5
Wheat, grain . . . . .	12.0	2.0	2.0	71.5
Oats, grain . . . . .	11.8	5.0	9.5	59.7
Corn, dent . . . . .	10.3	5.0	2.2	70.4

These figures show that barley is a nutritious grain. In cooler countries where its yield is greater than in the South it is prized as a food for hogs, since it produces a firm and excellent quality of pork.

**77. Species and varieties.** — Some authorities divide barley into several species, depending on whether the grains are arranged in 2, 4, or 6 rows, thus giving the name of 2-rowed, 4-rowed, and 6-rowed barley. There is also

a form of naked barley in which the hulls do not adhere to the kernels; unfortunately, the yield of this kind is small.

Beardless barley has excited some interest. Its chief advantage is its earliness and the absence of beards (Fig. 29).

Its disadvantages are small yield of grain, weak straw, small number of stems produced, and extreme tenderness, or susceptibility to winter-killing. Even in the central part of the Gulf States this variety requires sowing after Christmas. It is the earliest of any of the small grains tested at the Alabama Experiment Station, but is scarcely practicable except on a small scale and on rich land.

**78. Soils and fertilizers.** — Barley requires a richer soil than any of the other small grains. It prefers a limestone soil, and on acid lands the use of lime is usually advantageous. The fertilizer should be either stable manure or a mixture of commercial fertilizers containing nitrogen, phosphoric acid, and potash.

**79. Sowing.** — In the central part of the cotton-belt, barley may be sown at any date between September 1 and December 1. For sowing broadcast to afford pasturage it is advisable to use  $2\frac{1}{2}$  bushels of seed per acre. For grain production, or for sowing in drills as a soiling crop,  $1\frac{1}{2}$  to 2 bushels per acre is sufficient.



FIG. 29. — HEAD AND SPIKELET OF BEARDLESS BARLEY.

80. **Enemies.** — Since barley is the first of the small grains to ripen, it is devoured by birds. It is subject to two kinds of smut. For the prevention of the loose smut of barley, evidenced by conspicuous black heads, without grain, the Wisconsin Experiment Station recommends the following treatment of the seed: "Soak for 12 hours in cold water; then scald the seed at 130° F., for not over 6 minutes. Sow the seed the same day."

### LABORATORY EXERCISES

- (1) Make a drawing of a spikelet of rye.
- (2) Make a drawing of a spikelet of barley.
- (3) Practice the separation of a mixture of grains of barley, rye, wheat, and oats.
- (4) Write out the two most conspicuous differences between a head of rye and one of barley; the one most conspicuous difference between a head of bearded wheat and of bearded barley.

### LITERATURE

#### Rye.

KILGORE, B. W., and others. N. C. Dept. Agr., Bul. Vol. 30, No. 8.  
VAN WAGEMAN, J., JR. Bailey's Cyclo. Agr., Vol. II, pp. 559-563.  
SARGENT, F. L. Corn Plants. Boston.

#### Barley.

SARGENT, F. L. Corn Plants. Boston.  
MOORE, R. A. Bailey's Cyclo. Agr., Vol. II, pp. 202-206.

## CHAPTER IV

### CORN OR MAIZE (*ZEA MAYS*) — STRUCTURE

CORN belongs to the great family of grasses, which also includes, besides the ordinary grasses, sorghum, sugar-cane, and the small grains. It is a large annual plant, making its growth in the warmer part of the year and is easily killed by freezing temperatures.

The word "corn" in Europe means any kind of grain. In the United States, the word applies only to Indian corn or maize. Most authorities think that this plant originated in the southern part of Mexico. It has few near relatives among either wild or cultivated plants. Its nearest cultivated relative is teosinte, a tropical forage plant which is of some value in the southern part of the United States.

Corn is the largest and most valuable single crop grown in the United States, occupying more than twice the acreage devoted to wheat and three times that occupied by cotton. Its most important use is as a food for live-stock, for which both the grain and all parts of the vegetative portion of the plant are employed.

Corn also constitutes an important article of human food. In the South corn-bread is largely consumed, and in all parts of the United States numerous other articles for human consumption are made from the corn grain, such as breakfast foods and cornstarch. The oil extracted

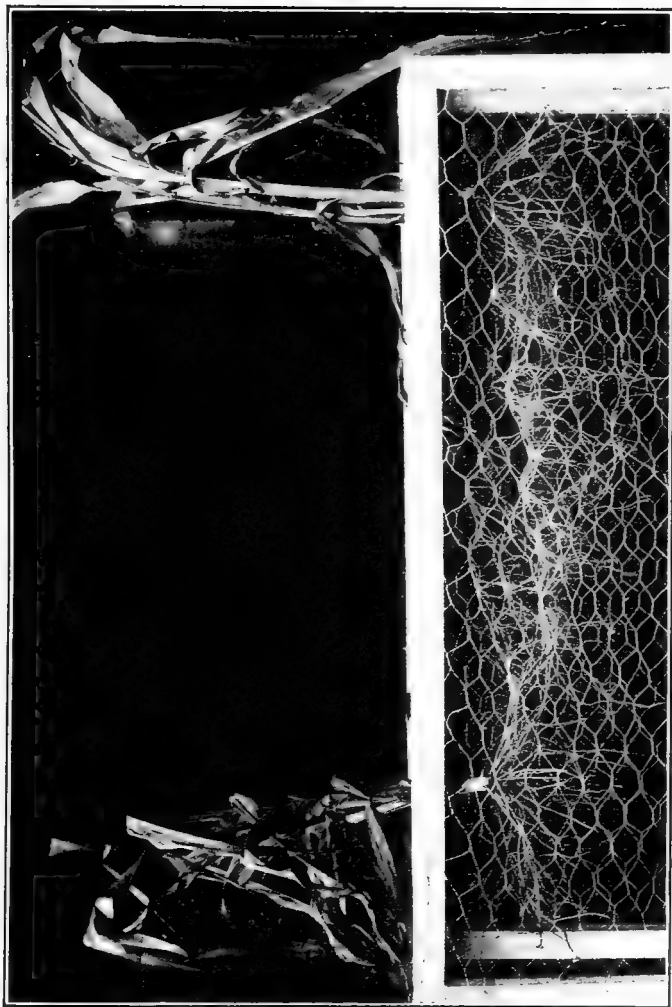

FIG. 30. — ROOTS OF CORN 47 DAYS AFTER LEVEL PLANTING.

from the grain is used as a lubricant and for the manufacture of a substitute for rubber. The pith from the stalk is employed as a packing material in the construction of warships. Corn and its by-products are also used in many other ways.

### STRUCTURE

**81. Roots.** — The root system of the corn plant consists of a number of long, slender, branched, fibrous roots. There is no tap-root. A whorl of roots develops near the germinating grain, but the main system springs from the crown of the plant, which usually develops about 1 inch below the surface. Therefore, the depth of rooting of corn is largely independent of the depth at which the grain is planted.

As a rule, most of the main feeding roots originate in the stratum comprised between 2 inches and 4 inches below the surface of the ground (Figs. 30 and 31). These usually grow out almost horizontally for some distance, and then, if the soil permits, many of them bend downward, while some of the smaller, secondary roots occupy the surface layer of soil. Corn roots do not penetrate so deeply in most Southern soils as in other parts of the country. The depth at which roots feed seems to depend chiefly on the supply of moisture and air in the soil.

The roots of corn are frequently as long as the plant is tall. Indeed, the roots may lap across the rows before the plant is 1 foot high, so that deep cultivation, even at this early stage, may break many roots.

Besides the feeding roots just mentioned, the corn plant usually develops, at the first few nodes or joints just above

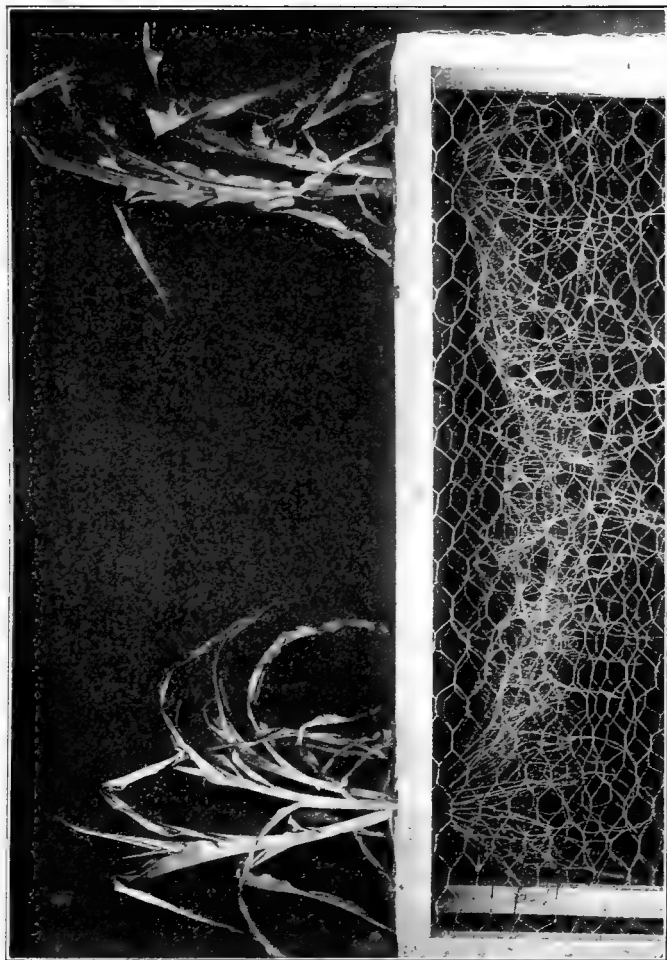

FIG. 31. — SHOWING ROOTS OF CORN 47 DAYS AFTER PLANTING IN DEEP FURROWS.

the surface, a series of brace-roots (Fig. 32). These slope downward and outward, and on reaching the soil they serve the purpose of bracing the plant. On entering the soil, the brace-

82. **Stem.** — The stem solid or filled with pith, and help to supply the plant. The usual height is 5 to above 10 feet is probably an

the plant. On entering the soil, the brace-

of the corn plant is and tapers to the top. 15 feet. A height indication of wasted

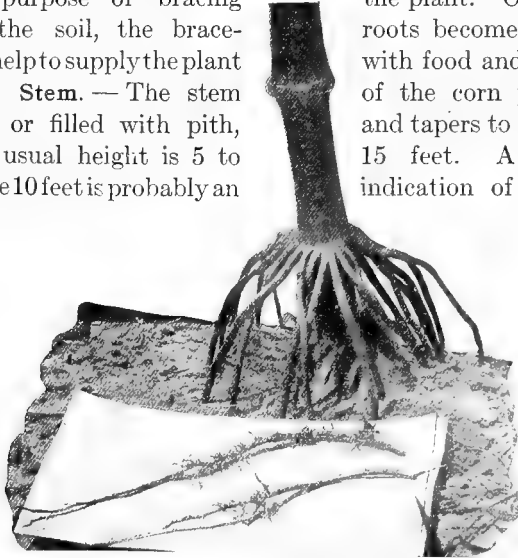

FIG. 32. — BRACE-ROOTS ON THE CORN PLANT.

On the paper at the bottom of the picture are two detached brace-roots, showing how they branch in the soil.

energy, the proportion of stem being larger than necessary to the production of the maximum amount of grain.

Since the corn plant must stand much strain from wind, it is so constructed as to resist or escape or withstand wind pressure. For example, devices for this purpose are found in the tapering stem, the presence of brace-roots, the strength of the outer layer or rind, the solid partitions at the nodes, and the peculiar form of the leaf.



The stem consists of internodes of variable length, separated by solid partitions at the nodes or joints. The internodes on certain parts of the plant are grooved, which seems to be a provision for accommodating the shank, or ear branch. When shoots or ears arise, they spring from a bud at the base of this groove. This bud is completely enwrapped by the leaf-sheath, which serves to protect it.

Under some conditions, partly dependent on variety, character of season, and distance between plants, "suckers" or basal branches spring from the buds on the main stem near the crown. These suckers afterwards develop independent root systems. Removal of such suckers is an important cultural operation in the South, since they take up water and plant-food needed by the parent plant. Their removal from Northern corn-fields is less important, for there several plants may be safely grown in each hill.

The tendency of individual corn plants to sucker is hereditary; thus Hartley found that when both the male and female parents produced suckers,  $14\frac{1}{2}$  per cent of the offspring developed suckers; while only  $2\frac{1}{2}$  per cent of the plants bore suckers in the case of those stalks neither of whose parents had produced suckers. Therefore, in selecting corn plants for seed, preference should be given in the South to those free from suckers.

**83. Leaves.** — The corn plant is supplied with a considerable number of long, broad, tapering leaves. The number is most frequently twelve to eighteen; and a leafy plant is probably desirable. The main uses or functions of leaves are (1) to take up from the air its carbon dioxid for use in building up the tissues of the plant, and (2) to throw off the surplus water into the air, thus helping to lift other supplies of soil moisture to the leaves with the contained plant-food. For these two purposes, the leaf is provided with immense numbers of minute openings or pores (stomata). These stomata are especially numerous on the under sides of leaves; each pore or stomate is

provided with an arrangement by which, in dry weather, the size of the opening is reduced, thus decreasing the amount of water thrown off by the leaf.

The corn leaf has also another means of economizing in the transpiration of moisture. This is seen in the rolling together of leaves in the middle of a hot dry day. This curling, or rolling, of the leaves is due to the presence of special cells, which, on parting with a portion of their moisture in dry weather, cause the leaf to fold inward.

In the South, the corn plant is especially liable to lose prematurely the use of its leaves through their drying, or "firing." This may be due to dry weather, to inadequate preparation of the soil, to lack of proper cultivation, to root pruning, or to other causes.

The leaf consists of two principal parts: the sheath, or that part which is clasped around a portion of the stem, and the blade,



FIG. 33.—PART OF A CORN LEAF, SHOWING WAVY MARGINS.

or free part of the leaf. The outer margin of the blade is wavy or scalloped (Fig. 33). This permits the leaf to turn from the wind like a windmill thrown out of gear, and thus to avoid throwing too great a strain on the stem.

**84. Ear-branch and shucks.** — The shank on which the ear is borne represents a branch. That this is a branch is apparent (1) from its position in the angle between the stem and the leaf-sheath; (2) by the fact that the shank has nodes similar to those of the main stem; and (3) by

the fact that most of these nodes bear a shuck or husk, which is only a modified leaf, as will readily be seen by noting that many shucks are tipped with a small leaf-blade (Fig. 34).

It is supposed that the shank which now bears the ear was once a long branch, and that shortening of the branches occurred both



FIG. 34. — AN EAR OF CORN ON WHICH LEAF-BLADES ARE BORNE ON THE TIPS OF MANY OF THE SHUCKS.

by man's selection and by natural selection. For example, those plants with shortest branches would be the ones most likely to propagate their kind in nature, because these branches would less frequently break off before maturing the seed. For the same reason, selection by man would also tend to preserve the plants with shortest branches,

**85. Number of ears.** — The number of ears to a plant varies greatly, according to the race of corn, the variety, the soil and fertilization, and the character of the season. In the ordinary or dent varieties, the number seldom exceeds seven and is more frequently one or two ears for each plant.

Many experiments at the Alabama and North Carolina Experiment Stations have indicated that in the South those varieties of dent corn are most productive of grain that ordinarily bear two ears to the plant.

**86. Position of the ear.** — Large yields of corn are made from varieties bearing ears at a medium height from the ground, while equally large yields are made from other varieties, the ears of which are borne at a greater distance above the ground. Other things being equal, a moderate height of ear is preferable, say, four feet above the ground in the case of a tall plant, or even less in the case of a low plant (Fig. 35). The chief advantages of a low or medium position of ear are the following: (1) a decreased tendency for the ear to pull the plant down, and (2) greater ease in harvesting the ear in the lower position. A low ear is also apt to accompany a stalk of only medium size, which is desirable. A low ear, also, usually implies earlier maturity.

The shank of the ear should be of such size and length as to let the ear droop, or bend straight down, so as to protect the tip of the ear from rain and to avoid the tendency exerted by an outward-pointing ear to pull down the stalk. This means that the shank should be of medium diameter. It should not be very long.

**87. Tassel.** — The tassel consists of a panicle, or spread-



FIG. 35.—DIFFERENCES IN HEIGHT AND POSITION OF EAR IN THE SAME VARIETY.

On right, ears low and hanging down ; next, ears too high ; next, ear-shanks too long ; on extreme left, the shank is too short and stocky, causing the mature ears to point upward.

ing flower-cluster, usually borne at the extreme top of the plant. This panicle carries the male or pollen-bearing flowers, which are usually in groups of two flowers in a spikelet. Each flower, on maturing, pushes forth three anthers, or pollen cases, from which, on maturing, the fine particles of pollen are set free, to be borne by the wind to the silks of other corn plants. It has been estimated that a single tassel may bear more than 40,000,000 pollen-grains.

The tassel usually appears two to four days before the first silks are visible on the same plant; this is a device to prevent the pollination of the silk by the pollen from the same plant.

Numerous experiments have shown that the removal of the tassels on half of the plants in a field does not materially influence the yield.

**88. Silks.** — Each silk originates where a grain should be borne on the cob, from which position it grows until its outer part reaches the air, beyond the tip of the shuck. This free part of the silk is supplied with very minute hairs, the purpose of which is to entangle and hold the grains of pollen. (See Fig. 36, A.) In case a silk fails to receive pollen, it may continue to grow to unusual length. In case no pollen lodges on any particular silk, no grain is formed at the point on the cob where that silk is attached.

**89. Pollination.** — Pollination is the transfer of pollen to the sticky surface of the stigma, which in this case is the silk. Along the entire length of the silk grows the pollen-tube (Fig. 36), thrown out by the pollen-grain after lodgment on the silk.

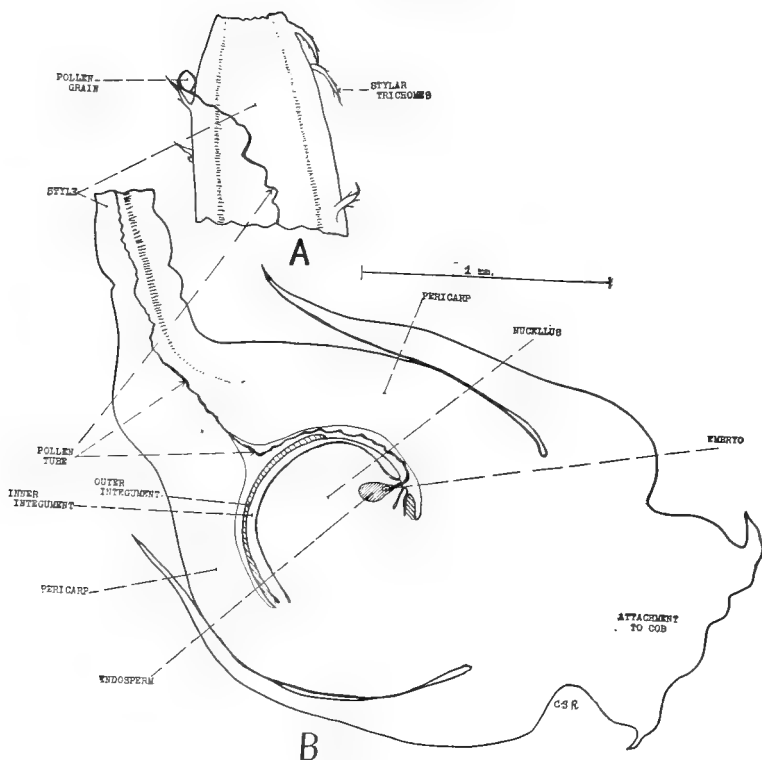

FIG. 36.—DIAGRAM SHOWING COURSE OF THE POLLEN-TUBE THROUGH SILK TO OVARY.

A, section near outer end of silk, showing pollen-grain and pollen-tube; B, section through base of silk and through young grain. (Drawing by C. S. Ridgway.)

The pollination of corn is effected almost entirely by the wind, which may carry the pollen great distances.

Hence, fields of two different varieties of corn, which the farmer desires to keep unmixed, should not be planted at about the same date, within less than half a mile of each other, unless there be intervening woods or other obstacles to the blowing of the pollen.

**90. Impregnation or fertilization of the grain.** — The word "fertilization," as used in this paragraph, does not refer to the supplying of food or fertilizing material to the plant. Fertilization of the flower consists in the growing of the pollen-tube along the entire length of the silk and into the embryo-sac (Fig. 36), and its union there with the egg-cell of the mother plant to produce the seed (Fig. 37). Without such a union, no seed is formed.

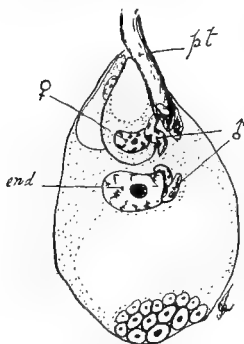

FIG. 37.—THE EMBRYO-SAC IN CORN AT THE TIME OF FERTILIZATION.

*pt.*, pollen-tube which has just discharged 2 male nuclei, ♂; ♀, egg-cell which, after union with one of the male elements, forms the germ; *end.*, nucleus of the endosperm, with which the second male nucleus may unite. (Drawing by F. E. Lloyd.)

After the pollen-grain has lodged on the sticky surface of the protruding end of the silk, it grows into that silk and through its entire length to the point where the silk originates. There the pollen-tube enters the embryo-sac and sets free two male nuclei. One of these unites with the egg-cell, effecting true fertilization and producing the *germ* of the grain; the other male nucleus unites with the nucleus of the endosperm (Fig. 37). When this second union occurs, the result is an endosperm that derives



its qualities from the pollen-bearing parent as well as from the mother plant.

It is this second union of *double fertilization*, which occurs in some plants, that enables the pollen of a yellow variety of dent corn to produce yellow kernels a few weeks after fertilizing the silks of a white variety. This is because the yellow quality has been given by the male parent to the endosperm, or main part of the grain, which color shows as yellow through the transparent hull or bran that covers the grain.

**91. The ear.** — The ear varies greatly in length, diameter, and number of rows of grain. Among ordinary or dent varieties, the usual number of rows ranges between twelve and twenty-four, fourteen to eighteen being most common in productive varieties. A good ear of corn should bear about a thousand grains. The number of rows is always even, a fact which has a satisfactory explanation in the structure and evolution of the cob and pistils. (See Hunt's "Cereals in America," p. 148.)

The best ear is one having a cob not extremely small, since this would not allow a sufficient number of rows. Neither should the cob be very large, since this tends to late maturity and to the rotting of the ear in a wet fall.

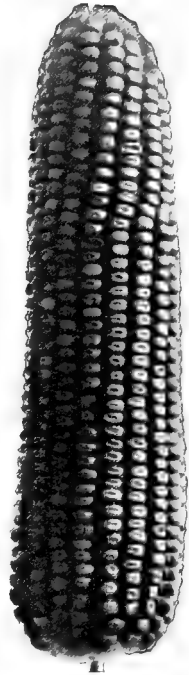

FIG. 38. — A WELL-PROPORTIONED EAR OF A HARD YELLOW VARIETY.

Many corn-breeders in the Northern States prefer that the circumference of the ear at one third the distance from the butt be three fourths the length of the ear. However, the best proportions of an ear cannot be regarded as having been determined for Southern varieties (Fig. 38).

### THE CORN GRAIN OR KERNEL

**92. Shape.** — The kernel of corn varies greatly in shape and size with the different races of corn. There are even great differences within the same variety and on the different parts of the same ear. In the dent varieties, practically all of the grains are flattened and somewhat wedge-shaped, their smallest diameter being the one parallel to the cob. Sturtevant found that in each of the races of corn there are grains of three different subtypes:—

Subtype A, grain broader than deep;

Subtype B, grain as broad as deep;

Subtype C, grain much deeper than broad.

The typical grain in the most popular dent varieties has the last shape; that is, it is much deeper or longer than broad.

**93. The structure of the grain.** — The grain is made up of a number of parts having distinct functions and separate origins. As a means of simplification, these are here grouped into three parts:—

- (1) the chit, germ, or embryo;
- (2) the endosperm, or main bulk of the grain;
- (3) the seed coats or bran.

The *embryo*, or germ, is situated at the cob end of the

grain, under the depression or groove, which faces the tip of the ear. It comprises about one eighth of the weight of the grain. It is especially rich in fat.

The *endosperm* (from *endon*, around, and *sperma*, a seed) is that large portion of the seed lying around and between the embryo and the several outer layers or coats of the kernel. The endosperm constitutes about 73 per cent of the weight of the entire grain and is that part of the grain which gives to corn its value as a starchy food. The endosperm consists chiefly of starch, but contains also some protein, ash, and other materials.

This starch of the endosperm is arranged in two different ways, giving two very different appearances to the different parts of the same endosperm. When this starch is loosely arranged, the color of that part is a pure snow-white, of an opaque floury appearance. On the other hand, when it is arranged in compact form, the appearance is that of a horny or nearly translucent substance, which is called the horny, or corneous layer.

The *coats* of the kernel, which are usually together removed in the form of bran, are several in number, each having separate function and origin.

**94. Judging the composition of the kernel by its cross-section.** — The investigations of Hopkins and of Willard have shown that by cutting transversely through a grain of corn, one may judge of its probable richness in fat, in starch, or in protein, by the thickness of the several layers constituting the germ, the loose floury starch, and the compact horny starch (Fig. 39). A large germ indicates a high percentage of fat, which is important when the corn is used for the manufacture of corn oil. A thick layer of the

loose floury material indicates a high percentage of starch. Unusual thickness of the horny layer implies a relatively high percentage of protein; this is because this compact layer, though composed chiefly of starch, is also rich in protein. In the selection of seed corn practical use can be made of the facts just mentioned.

In spite of these differences in appearance, accompanied



FIG. 39.—TRANSVERSE SECTION THROUGH CORN GRAIN; LARGE GERMS IN 2 KERNELS ON THE LEFT AND SMALL GERMS IN 2 KERNELS ON THE RIGHT.

by differences in composition, in the different grains of the same variety, analysis shows little difference between different varieties, even when they

differ considerably in the appearance of cross-sections of their grains.

There is probably no necessity for the Southern farmer to select corn with special reference to increasing the yield of protein or of fat. For it is easy for him to grow legumes for feeding with corn to counteract its deficiency in protein. The manufacture of corn oil is not important in the South.

**95. Location of the color in the corn kernel.** — It is important to learn in what layer the color is located in the different classes of corn, so that one may understand that part of corn breeding which relates to the heredity of the color of the grain.

The hull, or bran, of the grain of white and yellow varieties of dent corn is colorless or translucent; hence the color of white or yellow grains lies deeper, namely, in the endosperm. The pollen from a yellow variety may

promptly, or in the current cross, give a yellow color to the endosperm of the cross-pollinated grains of a white variety (see Par. 90). Since the hull in this case is transparent, the yellow endosperm shows through and the grain appears yellow.

On the other hand, the red color sometimes appearing in dent varieties is due, not to a colored endosperm, but to red color in the *hull*. Hence the red in the hull obscures whatever color there might be in the endosperm (for example, yellow), and determines the color of the grain. But the pollen does not in the current cross affect the hull, so that impregnation of white grains by pollen from red varieties does not, like the use of yellow pollen, show a few months after fertilization, but must wait to show the red color of the male parent in the next generation.

The color that is responsible for the blue, purple, or lead-colored appearance of certain kinds of sweet and soft corns, which are different races from ordinary or dent corn, is located in the outer part of the endosperm, or just beneath the hull. The color, being in the endosperm, is subject to double fertilization, and hence to the immediate display of the color of the pollen-bearing parent. A lead-colored corn planted near a white may immediately cause colored grains to appear on white ears all over the field.

### LABORATORY EXERCISES

#### Roots.

(1) Plant 10 grains of corn 1 inch deep and other similar lots at depths of 1, 2, 4, and 5 inches below the surface, either in a box of soil or in the garden or field:—

- (a) Record the number of days after planting before each plant appears.

- (b) In about 4 weeks dig some plants resulting from each depth of planting, making drawings showing the position of the principal roots developed from each depth of planting.

(2) Carefully dig well-grown or even mature corn plants, washing the earth from around the roots.

- (a) At what distance below the surface do most of the roots originate?
- (b) Count and record the number of main roots.
- (c) From how many of the joints or nodes do the true roots and brace-roots spring?
- (3) Make two sketches, one showing
- (a) location of main roots where corn was planted in a furrow and earth subsequently thrown to it, and
- (b) location of main roots on a plant which has not been planted in a trench nor had earth thrown to it.

#### Brace-roots.

(4) On well-grown corn plants or on old corn stalks, examine the brace-roots, noting

- (a) their number ;
- (b) number of nodes from which they spring ;
- (c) diameter just above the ground, and
- (d) diameter 1 or 2 inches below the surface.

#### Stems.

(5) Examine the bent portion of a number of well-grown corn plants or old corn stalks which have been blown down, and subsequently straightened, to discover how the plant effected this bending by growing more rapidly on one side than on the other. Make a sketch of one such uneven node.

(6) Strip the leaves and leaf-sheaths from a corn stalk and record the length of

- (a) the lowest internode ;
- (b) the internode just below the shank of the lower ear,
- and
- (c) the length of the internode next to the tassel.

(7) Record the total number of internodes and their average length on

- (a) a tall plant and on
- (b) a low plant in the same field.

#### Leaves.

- (8) (a) Record the number of leaves on an average corn plant.
- (b) In how many vertical ranks are these arranged?
- (9) (a) Measure the midrib of an average full-grown leaf and the margin of the same, to determine how much longer the margin is.
- (b) By moving the leaves about, try to ascertain how the margin helps the leaves to avoid the pressure of the wind.
- (c) Measure the approximate surface in square inches on the two surfaces of a grown corn leaf of average size.
- (d) From (8 a) and (9 c) calculate the probable number of square feet of leaf surface on 4000 corn plants borne on an acre.

#### Ear-shanks.

- (10) (a) Record the number of nodes between main stem and cob on a long ear-shank.
- (b) Record the average length of five short ear-shanks bearing mature ears, and note whether most of the ears point up or down.

#### Grains.

- (11) (a) Soak grains of corn and separate the coats, the germ, and the endosperm.
- (b) Cut cross-wise through a number of kernels of dry corn and compare them as to thickness of the horny layer and as to size of germ.

#### LITERATURE

- SARGENT, F. L. Corn Plants. Boston.  
HARSHBERGER, J. W. Bailey's Cyclo. Agr., Vol. II, pp. 398-402.  
HUNT, T. F. Cereals in America. New York. 1904.  
HOPKINS, C. G. Ill. Expr. Sta., Bul. No. 87.

## CHAPTER V

### CORN — COMPOSITION AND JUDGING

THE composition of dent and of flint corn, and of yellow and white varieties of dent, is practically the same. The corn grain contains a large proportion of carbohydrates, or starchy material, which constitutes its chief value as food. The percentage of protein is so low that for some classes of live-stock corn should be fed in connection with some food rich in protein. This is specially true for growing pigs, for working teams, and for poultry. Useful foods for feeding with corn are the following: —

To growing pigs: skim milk, soybeans, cowpeas, dried blood, tankage, and pasturage consisting largely of the clovers and related plants.

To horses: hay of the clovers, alfalfa, cowpea, vetches.

To poultry: beef scrap, cowpeas, and fresh bone.

**96. Composition of corn and its products.** — The following figures represent the average of American analyses: —

	WATER	ASH	PROTEIN	CRUDE FIBER	NITROGEN — FREE EXTRACT	FAT
Grain, dent varieties	10.6	1.5	10.3	2.2	70.4	5.0
Grain, flint varieties	10.3	1.4	10.5	1.7	70.1	5.0
Corn blades	30.0	5.5	6.0	21.4	35.7	1.4
Corn stover	40.1	3.4	3.8	19.7	31.9	1.1
Corn fodder	42.2	2.7	4.5	14.3	34.7	1.6
Corn silage	79.1	1.4	1.7	6.0	11.1	0.8
Corn bran	9.1	1.3	9.0	12.7	62.2	5.8
Husks (Shucks)	17.2	3.2	4.3	29.5	44.9	1.0



**97. Parts of the corn plant.** — *Corn stover* is the residue of stalk, leaf, and shuck after the removal of the ear. *Corn fodder* is the entire plant when grown thickly and cured for forage. *Corn blades*, very generally known in the South simply as “fodder,” are the leaves stripped from the plant just before the ears mature. The blades make a very palatable and nutritious food, but the yield is small, the labor of harvesting considerable, and the stripping of the blades reduces the yield of grain.

Corn stover, when shredded, has somewhat the same value as cotton-seed hulls, the composition of the stover being superior but the hulls mixing better with concentrated foods and being eaten with much less waste. Stover should be fed in connection with cotton-seed meal or other food rich in protein.

Corn silage consists of the entire plant cut, while still green but after the roasting-ear stage, into short lengths and stored in an air-tight compartment, called a silo. Here it keeps with but slight loss and in green, succulent condition until winter. This is the best way to utilize the corn crop for dairy cattle, and often for fattening cattle.

*Silage* is the material that is stored; *silo* is the receptacle in which it is stored; *ensilage* is the verb, as “to ensilage corn,” with the accent on the middle syllable. The terms are variously used and confused in current speech and writing, however.

**98. Proportion of parts in the corn plant.** — The Georgia Experiment Station (Bul. No. 30) found that in every 100 pounds of the above-ground part of the corn plant, after being thoroughly air-dried,

the grain constituted . 38.8 per cent,	the shucks . 11.1 per cent,
the stalks . . . . 29.3 per cent,	the tassels . 1.3 per cent,
the blades . . . . 9.8 per cent,	and the cobs 9.7 per cent.

**99. Corn products.** — From the corn plant are made great numbers of products. Among those made from the grain are corn meal, grits, hominy, and corn flakes, — all for human food; also whisky, corn oil, glucose, starch, and many others; and for stock food, gluten meal, corn hearts, corn bran, and others.

The pith of the stalk is used as a packing material in the construction of warships. From the stalk cellulose is manufactured. All parts of the plant are used as food for live-stock.

**100. Draft on soil fertility.** — A crop of 40 bushels of corn and 2500 pounds of stover removes approximately the following amounts of plant-food: —

	NITROGEN	PHOSPHORIC ACID	POTASH
40 bu. grain . . . . .	37.0	15.9	12.8
3000 lb. stover . . . . .	18.3	11.4	32.7
Total in grain and stover .	55.3	27.3	45.5

From the above table it may be seen that every bushel of grain removes about one pound of nitrogen, two fifths of a pound of phosphoric acid, and about one third of a pound of potash.

These figures impress the need of the corn plant for nitrogen, which is most economically supplied in a preceding soil-improving or leguminous crop (as cowpeas), or in manure.

It should be noticed that the stover removes about three times as much potash as does the grain; and also practically half as much nitrogen. Hence the removal of the stover greatly increases the need for nitrogen and potash in the fertilizer for succeeding crops.



## LABORATORY EXERCISES

Practice in scoring ears of corn.

Each ear, or each exhibit of 10 ears, should be scored by the score-card above used in the state nearest the reader's home, or by

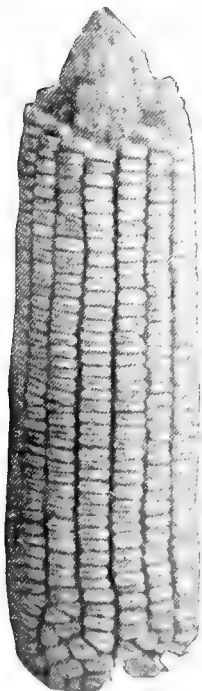

FIG. 40.

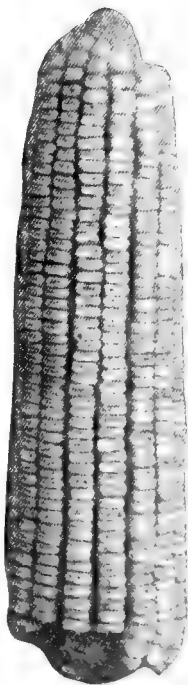

FIG. 41.

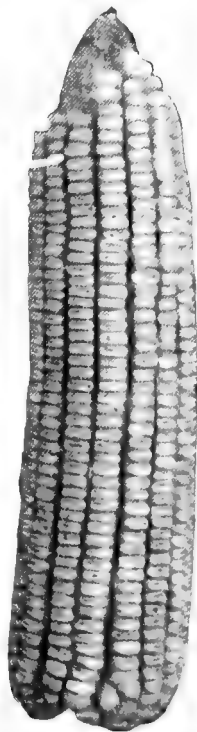

FIG. 42.

any other score-card that may be preferred. Let each student, after noting the excellencies and defects of all ears shown in this

chapter, score a number of ears of corn, entering the figures representing his estimate of each quality in the proper space in a table ruled or printed like the table on page 101. Figs. 40-45 show defective ears of Henry Grady corn to be criticized by the pupil.

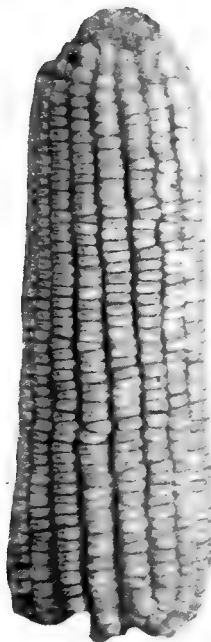

FIG. 43.



FIG. 44.

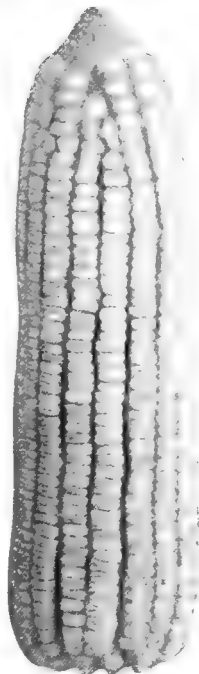

FIG. 45.

The following paragraphs indicate some of the most important considerations in scoring each character:—

(1) **UNIFORMITY.**— The ear examined should be like other ears of the same variety, and all ears of one exhibit should be uniform in size and appearance. Criticize Figs. 40-45 as to uniformity.

(2) **VITALITY AND MARKET CONDITION.** — Good germinating power and market condition is shown by the soundness of the grain and freedom of the tip of the grains from dark spots, adhering particles of husk, shriveled appearance, or undue slenderness at the tip near the cob. Germination tests may be made.

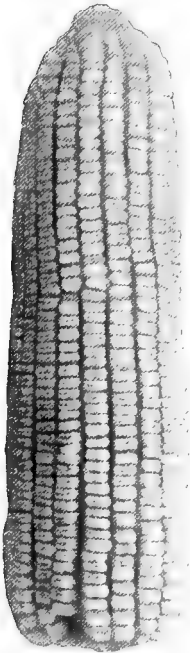

FIG. 46. — A GOOD EAR, BUT NOT FREE FROM SLIGHT DEFECTS.

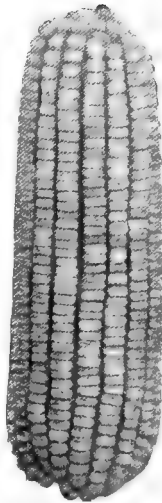

FIG. 47. — TOO SHORT.

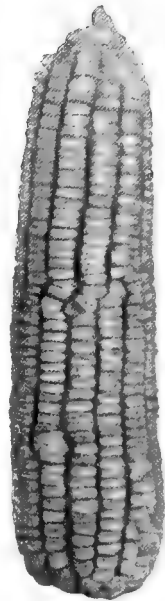

FIG. 48. — DEFECTIVE IN SHAPE, TIP, AND BUTT.

(3) All grains on an ear should be of the same color.

(4) **COLOR OF COB.** — A white cob is preferred for white varieties. Most score-cards prescribe that a yellow variety shall

have a red cob, which, however, is merely a fancy point. However, the color of cob should be uniform for every ear in an exhibit.

(5) SHAPE OF EAR. — It is generally assumed that a nearly

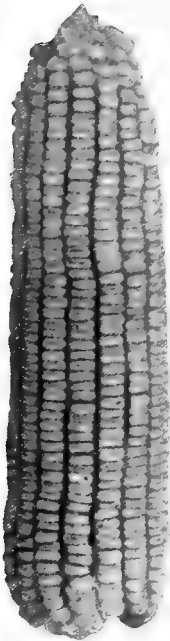

FIG. 49.—Too Small.

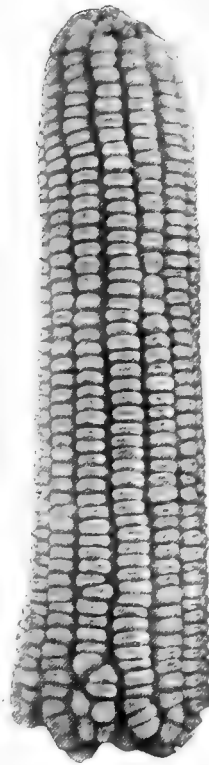

FIG. 50.—EAR WITH ENLARGED BUTT AND WIDE FURROWS BETWEEN ROWS.

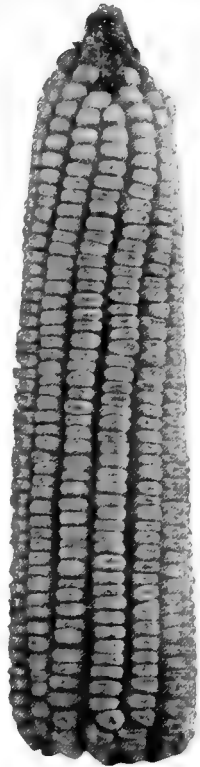

FIG. 51.—EAR WITH BARE TIP AND WIDE FURROWS.

cylindrical shape is best; but at the Ohio Experiment Station tapering ears were quite as productive as cylindrical ears. The

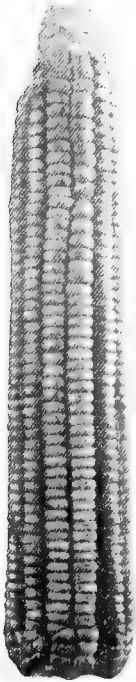

FIG. 52.—AN EAR TOO LONG AND SLENDER, WITH AN INSUFFICIENT NUMBER OF ROWS.

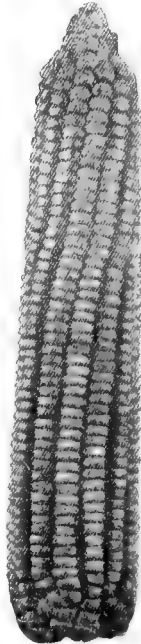

FIG. 53.—A TOO SLENDER EAR, WITH SHORT GRAINS, BARE TIP, AND WIDE FURROWS.

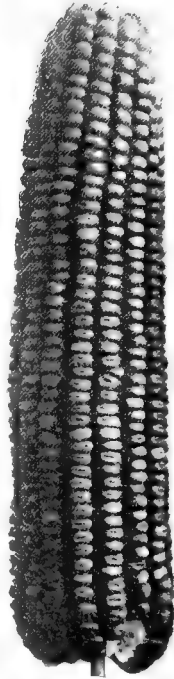

FIG. 54.—AN EAR OF ONLY MEDIUM QUALITY, BUT WELL-COVERED TIP.

ear should be straight and even, without undue swelling at the butt, and the rows should be straight.



(6) The preferred length at present is about  $1\frac{1}{2}$  times the circumference, taken one third the distance from the butt. Yet

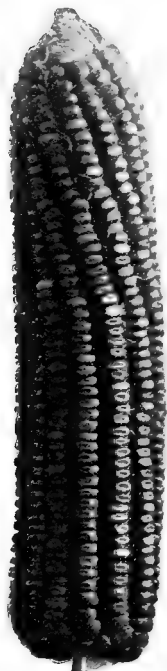

FIG. 55.—EAR WITH CURVED ROWS, BARE TIP, AND OTHER FAULTS.

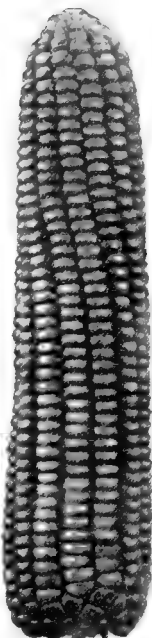

FIG. 56.—AN EAR WITH FLINTY GRAINS OF EXPERIMENT STATION YELLOW CORN.

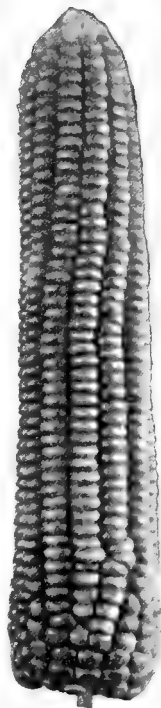

FIG. 57.—AN EAR WITH VERY HARD SHORT GRAINS AND A DEFICIENT NUMBER OF ROWS.

this varies with different varieties. Compare Fig. 46 with Figs. 47, 52, and 53.

(7) **BUTTS OF EARS.** — The grains on the butts should project slightly and evenly beyond the cob, forming an even, well-rounded butt, with grains not very variable in shape and size. The place

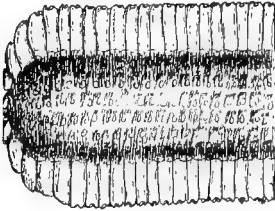

FIG. 58.—EAR WITH LONG, WELL-FORMED GRAINS.



FIG. 59.—EAR WITH SHORT GRAINS.

of attachment of the ear shank should be of moderate diameter. Compare Fig. 46 with Fig. 50.

(8) **TIPS OF EARS.** — The grains should as nearly as possible hide the cob at the tip of the ear and should there be of fair size.

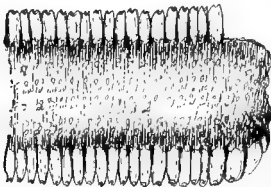

FIG. 60.—AN EAR HAVING TOO MUCH SPACE BETWEEN GRAINS NEAR THE COB.

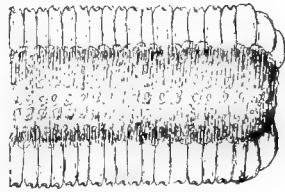

FIG. 61.—AN EAR IN WHICH THERE IS NO LOST SPACE BETWEEN GRAINS NEAR THE COB.

Some authorities regard a well-covered tip as rather a fancy point, while others consider it as closely related to a high yield. Compare Fig. 54 with Figs. 51, 52, 53, and 55.

(9) **SPACE BETWEEN ROWS.** — The spaces, furrows, or sulci are the depressions between adjacent rows of grain near the crown of the kernel. The deeper and wider are these spaces, the more defective

is the ear in this respect (Figs. 51, 52, 53, and 54), since deep furrows imply rounded grains with a low percentage of grain to cob.

(10) PROPORTION OF CORN ON EAR. — Medium to small cobs and long grains indicate a high percentage of corn and are desirable. Compare Figs. 58 and 59. A cut or deduction may be made where the shelled grain constitutes less than 86 per cent of the husked ear.

(11) TRUENESS TO TYPE. — Every ear should possess the qualities common to that variety.

(12) SPACE BETWEEN KERNELS NEAR COB. — This is judged by removing several rows of grains and viewing the remaining rows from a position showing the edges of the kernels (Figs. 60 and 61). Much space between the grains near the cob indicates grains of poor shape and an ear of low percentage of grain, and sometimes this also indicates immaturity.

(13) KERNELS (Figs. 62, 63). — The best shape is a cut-off wedge, the edges of the grain touching the adjacent row throughout nearly its whole length. The shoulders near the tip should be broad and plump. The kernels should be long and free from an excessive amount of beak or shriveled portion at the crown. Excepting those at the extreme butt and tip, the grains should be of uniform size and shape and of nearly uniform denting. The color of all grains on one ear should be identical. Yellow varieties should have grains free from white caps and grains on white varieties should be free from a yellowish or amber tint.

(14) and (15) LENGTH AND CIRCUMFERENCE OR WEIGHT OF EAR. — This refers to the weight of grain and cob after thorough air drying. In most score-cards this is covered by measurements of the length and circumference of each ear. The standard or ideal



FIG. 62. — SHOWING VARIATIONS AMONG CORN GRAINS.

Those in the upper group are well-shaped; in the middle group, ill-shaped; the lower group shows one very large and one very small germ.

should be a larger ear in the case of one-eared than in the case of two-eared varieties.

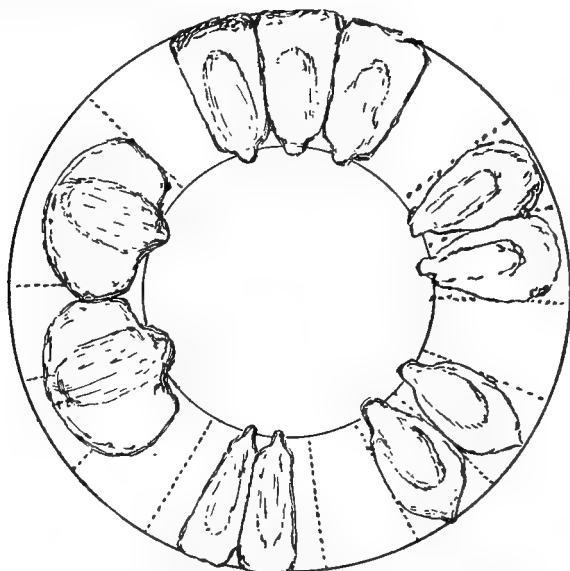

FIG. 63.—VARIOUS SHAPES OF CORN KERNELS.  
Upper kernels have good and all others poor shapes.

#### Composition of grains.

(1) From a crib of corn select

(a) 2 ears having a high percentage of protein, as shown by thickness of horny layer (see Par. 94) in grains near the center of the ear ;

(b) 2 having a low percentage of protein, and

(c) 2 having a high percentage of fat.

(2) Make drawings of a cross-section of 3 grains representing the ears selected under (a), (b), and (c).

## LITERATURE ON JUDGING OF CORN

Iowa Expr. Sta. Bul. No. 77.

Indiana Expr. Sta. Bul. No. 110.

Missouri Expr. Sta. Circ. No. 19.

Publications of a number of other experiment stations and agricultural colleges.

SHOESMITH, V. M. *The Study of Corn*. New York, 1910.

LYON and MONTGOMERY. *Examining and Grading Grains*.  
Lincoln, Neb.

## CHAPTER VI

### CORN — RACES AND VARIETIES

MAIZE has varied into almost numberless forms, ranging from the tall corn of the Southern States to the dwarf of high latitudes, and has given rise to many shapes and sizes and colors of kernel and ear. Some corn is very early, some late; some kinds have flinty kernels and others have very soft grains.

**102. Races of corn.** — Corn is divided into at least six great divisions, or races, which cross freely with each other. These races are



FIG. 64. — SECTIONS ACROSS GRAINS OF CORN, SHOWING ARRANGEMENT OF HORNY (SHADED) AND FLOURY (DOTTED) LAYER IN EACH.

From left to right, dent, flint, pop, sweet, and soft corn.

of the grains (Figs. 64 and 65), as well as by other distinctive characters.

Dent corn comprises all the varieties commonly grown in the fields in the Southern States. Indeed, the bulk of the American corn crop belongs to this race.

(1) In *dent corn* a cross-section of the grain shows that the floury or soft part, consisting chiefly of loosely arranged starch grains, comes quite to the top of the grain. The shrinkage of this soft loose starch during ripening causes the

depression, or dent, which gives the name to the dent race. The grains of dent corn are usually much flattened and wedge-shaped, and longer or deeper than broad. The plant may be small, medium, or very large, Southern varieties being almost invariably large.

(2) In *flint corn* the layer of soft loose starch does not come to the top of the kernel but is surrounded, over the



FIG. 65.—SHOWING, FROM LEFT TO RIGHT, SECTIONS THROUGH GRAINS OF DENT, FLINT, POP, SWEET, AND SOFT CORN.

The shaded area represents the horny layer; the dotted portion shows the floury starch.

top as well as on the sides, by a horny layer, which is also made up chiefly of starch, compacted into a dense, almost translucent mass. The difference between the horny and the loose starch has been likened to that between ice and snow. The complete arch of horny starch over the top of the grain insures the ripening of the kernel without uneven shrinking or denting. The grains of flint corn are usually less flattened, shorter, and more rounded and smooth over the top and broader than dent corn. The stalks are usually small and the ears are borne near the ground. The flint corns mature quickly and are best adapted to regions near the northern limits of corn production. In the South they are little grown and comparatively unproductive.

(3) *Sweet corn* may be known by its wrinkled, horny grain, due to the presence of sugar in the endosperm, and by the absence of floury white starch. The plant is very small and bears many small ears, which mature early. Sweet corn is generally grown in Southern gardens, but is less productive here than in higher latitudes.

(4) *Pop corn* may be recognized by the entire absence of floury starch, the whole endosperm being compact and horny. This compactness explains why the grain swells or pops so completely. The plant is extremely small, the ears numerous and of diminutive size, maturing early.

(5) *Soft corn* bears a grain in which all of the endosperm is soft and white. This is the original kind cultivated by the Indians. It suited their needs by reason of the ease with which it could be ground. It is not now cultivated to any extent in the United States. The ears are small and the grains usually small and rounded, without dents.

(6) *Pod corn* is rather a curiosity than a race of any value. Each single grain is inclosed in a small shuck, while the whole ear or collection of grains is wrapped in an outer shuck. This is probably nearer to the original form of the plant than are any of the other races.

**103. Characters needed in Southern varieties.** — Varieties of field corn in the South must be chosen within the dent race. The primary consideration is a large yield of grain per acre. Among the other desirable qualities of a variety for the South are the following: —

(1) Medium or late maturity, in order that there may be a maximum yield and to escape the great injury done by grain weevils to the early varieties.

(2) At least a medium degree of hardness of kernel to





FIG. 66. — SHOWING AN EAR WITH TIP WELL COVERED BY SHUCKS.

A condition unfavorable to injury by weevils.



FIG. 67. — SHOWING AN EAR TIP NOT WELL COVERED BY SHUCKS.

A condition favorable to injury by weevil.

avoid the excessive injury inflicted by weevils on varieties with very soft grains.

(3) Tight and complete covering of shuck around the tip of the ear, to retard the entrance of weevils and to prevent injury from wet weather (Figs. 66 and 67).

(4) Ears falling or bending down, so as to escape severe injury from wet weather.

(5) Ears at medium height from the ground, so that the stalk may not be so easily blown or pulled down as if the ears were high.

(6) Small or medium-sized cobs, to decrease the danger from rotting in the field or in the crib.

(7) Ear-shank of only moderate length and size.

(8) Uniformity in character of plant and ear, this being usually an indication of purity and of careful breeding.

**104. Qualities accompanying high yield.** — The following characteristics usually accompany large yields of grain in varieties adapted to the South: —

(1) A tendency to produce two ears per stalk;

(2) A small or medium-sized cob, long grains of a wedge shape, and a rather high percentage of grain;

(3) Medium or late maturity.

**105. General considerations regarding varieties.** — The color of the grain is not of importance in the case of a variety intended for stock-food. However, for the making of corn meal, the Southern markets prefer white corn. Among white corns, there is a slight preference among millers for the varieties having white cobs. The reason for this is the experience of some millers that in the case of varieties with red cobs, the reddish scales from the tip of the grain are not all removed by cleaning machin-

ery, and that those remaining make discolorations in the meal, which are undesirable.

The color of the grain does not affect the composition, in spite of the preference of some feeders for yellow corn as stock-food. Color probably has no relation to yield; yet a summary made by the Mississippi Experiment Station, relative to 490 varieties tested at 7 experiment stations, showed that white varieties averaged 2.5 bushels more per acre than the yellow varieties.

Regarding the best degree of hardness or softness of the grain, there is a wide difference of opinion. Soft grains are more readily eaten by horses, but are subject to greater injury from weevils. Hard grains, while more resistant to weevils, are not weevil-proof. There is a tendency for hard grains to be of a shorter, more rounded form than soft grains. Soft grains of the long shoe-peg type have an undesirable amount of roughness on the top of the grain.

**106. Shapes of grains.**—Sturtevant (U. S. Dept. Agr., Office Expr. Sta., Bul. No. 57) has divided varieties of dent corn into three classes, according to the width of the grain compared with its length. In his first class, A, having grains broader than long, there is not mentioned a single variety that has been productive in the South.

In his second class, B, having grains as broad as long, the only two varieties that have generally proved in the South even near the first rank in productiveness are Cocke Prolific and Blount Prolific.

His third class, C, having grains longer than broad, includes three times as many varieties as are listed in classes A and B combined. In this long-grained group, we find

the names of a number of varieties that have ranked high in tests at Southern Experiment Stations.

Yet it must be added that in tests made in the South since 1899, the year of the publication of Dr. Sturtevant's descriptions, the most productive kinds have included a number of varieties not mentioned in his list. Many of these new, so-called varieties probably represent merely new names for old kinds; others are the result of such an amount of selection and improvement as to deserve their new and separate names. Unfortunately, in the renaming of varieties of either cotton or corn, there has too often been a failure to regard the rights of the originators and of the public, and an unjustifiable duplication of names for the same variety.

More than 1000 names of varieties have been listed. Many of these are merely names for the same variety; yet there are enough possible combinations of qualities to justify the naming of several hundred varieties, each differing from every other in at least one easily recognizable character.

**107. Yields of varieties.** — An examination of the yields of corn made in variety tests at the Southern Experiment Stations shows that there is no one best variety of corn for all conditions of soil and climate, even within the limits of the cotton-belt. However, it appears that in the greater number of experiments, but by no means in all, the most productive varieties belong to the class of prolific corn; that is, having a tendency to produce from 160 to more than 200 ears for each 100 plants.

For example, in four years' tests at the Alabama Experiment Station, the prolific varieties averaged 33.8 bushels per acre;

the varieties of medium prolificacy averaged 27.7 bushels; and the non-prolific varieties averaged only 27 bushels per acre. If we should exclude from the two latter classes all the early Northern varieties, which have proved decidedly unproductive in this climate, the yields of the three classes would come closer together, but the average would still favor the prolific kinds.

In North Carolina, a prolific variety, Cocks, at all distances yielded more grain than one of the best of the one-eared, large-eared kinds, Holt Strawberry. This superiority ranged from 9.6 to 14 bushels when the single plants stood 30 inches apart or nearer, and between 3 and 9.9 bushels when the distance between plants was 35 or 40 inches.

In the following catalogue are brought together the names of the varieties which have most frequently stood at or near the head of the list in yield of grain at the various Southern Experiment Stations:<sup>1</sup>—

STATE OR STATION	VARIETY
Alabama (Auburn)	Sanders
	Mosby
	Marlboro
	Henry Grady
	Experiment Station Yellow
	Cocks Prolific
	McMackin
Arkansas (main and branch stations)	Bradbury
	Johnson County White
	White Wonder
	Boone County White
	Southern Beauty
	Marlboro
Williams Prolific	

<sup>1</sup> Data obtained chiefly from correspondence, and partly from publications of the Experiment Stations.

STATE OR STATION	VARIETY
Georgia	Marlboro Sanders Cocke Prolific Boone County White Mosby McMackin Bradbury Stone
Louisiana	Mosby Hasting Prolific Shaw Calhoun Red Cob Laguna Georgia Gourd Seed Heard
Mississippi (Agricultural College Station)	Mosby Cocke Marlboro
Mississippi (Delta Branch Station)	Mosby Cocke Sanders
Mississippi (Coast Region, McNeill Branch Station)	Cocke Eureka Early Breadfield Holt Strawberry Blount Mosby
North Carolina (Piedmont Section)	Biggs Seven-ear Sanders Weekly Cocke Marlboro

STATE OR STATION	VARIETY
North Carolina (eastern North Carolina)	Cocke Prolific Biggs Seven-ear Weekly Sanders Hickory King
North Carolina (above 2800 feet)	Flint varieties
Oklahoma (eastern and central parts)	Mammoth White Boone County White Hildreth Yellow Dent Golden Eagle
Oklahoma (western part, with deficient rainfall)	Dwarf Mexican June Hickory King
South Carolina (Piedmont Section)	McGregor Hayes Marlboro
Tennessee	
Knoxville (poor upland)	Hickory King Leaming Iowa Silver Mine Reid Yellow Dent
Knoxville (fertile land)	Webb Improved Watson Hickory King Huffman Boone County White Albemarle Cocke
Knoxville (rich bottoms)	Huffman Webb Improved Watson Cocke Albemarle Hickory King Boone County White

STATE OR STATION	VARIETY
Texas (College Station)	McGaillard Yellow Dent White Superior Munson
Virginia (Mountain Section)	Boone County White Leaming Collier Excelsior
Virginia (Tidewater Region, bottom land)	Coeke
Virginia (poor uplands)	Hickory King

**108. Southern varieties by classes** (Figs. 68 and 69). — Among the productive varieties mentioned in the preceding list and belonging to the *prolific* type are the following: —

Mosby	Sanders	Blount
Albemarle	Coeke	Marlboro Weekly

All the above varieties usually bear between 160 and 200 ears for each hundred plants. The cobs are small, the ears small, and the grains usually rather long and slender, but somewhat shorter in Albemarle and Blount.

Among the large-eared varieties with red cobs are

Henry Grady	Tennessee Red Cob
Arnold	St. Charles White

Among the large-eared or medium-eared varieties with white grains and white cobs are the following: —

Shaw	McMackin	Boone County White
Renfro	Bradbury	

Among the large or medium-eared varieties with yellow grains are the following: —

Experiment Station Yellow, having a short, flinty grain, and usually a white cob; and Evans.



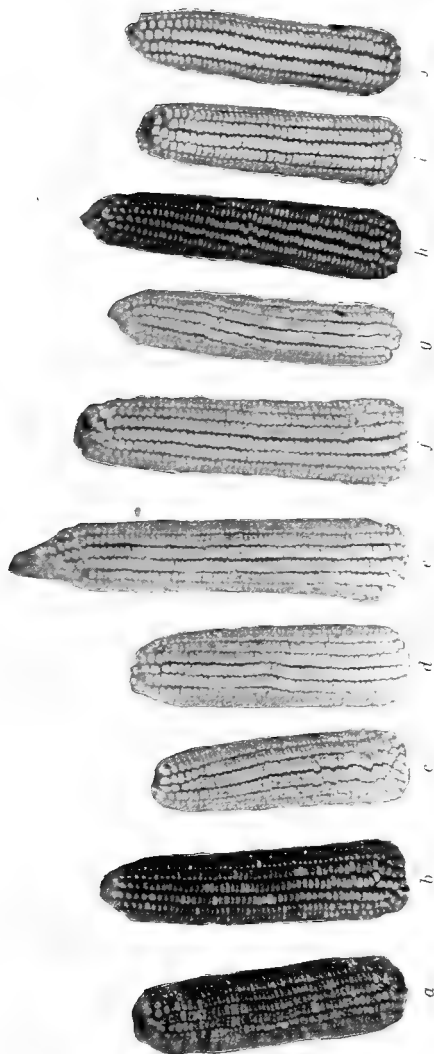

FIG. 68.—VARIETIES OF CORN.

*a*, Riley's Favorite ; *b*, *b*, Experiment Station Yellow ; *c*, Sanders ; *d*, McMakin ; *e*, Local White ; *f*, Henry Grady ; *g*, Mosby ; *h*, Marlboro ; *j*, Cocke.

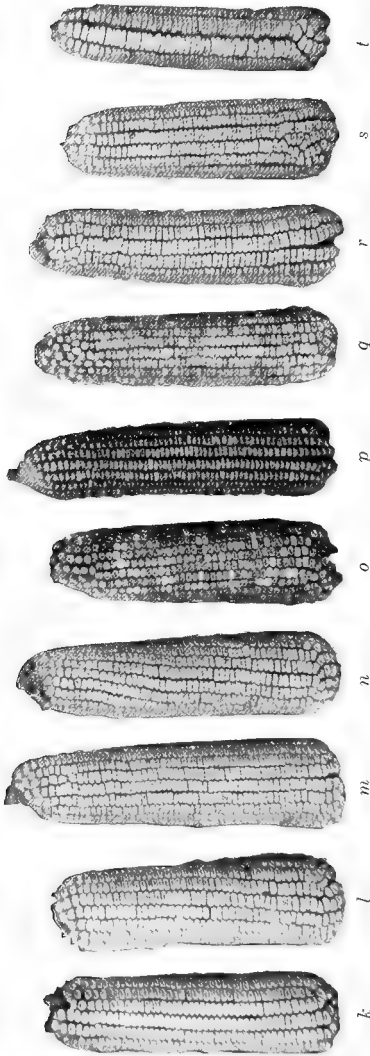

FIG. 69.—VARIETIES OF CORN.

*k, l, m, n*, Boone County White; *o*, Leaming; *p*, Experiment Station, Yellow; *q*, Reid Yellow Dent; *r*, No. 77; *s*, Iowa Silver Mine; *t*, Hickory King.

Among the early-maturing varieties, but not extremely early and better suited to the South than most early varieties, are the following: —

Hickory King	St. Charles
Blount Prolific	Cocke (some strains)

Mexican June corn is in a class by itself. It is chiefly valuable because of its strong root and leaf systems and its notable endurance of the heat and drought of late summer. The stalk grows to immense size, usually 11 to 15 feet. The stem is of large diameter and rich in sugar. The strain of Mexican June most commonly grown east of Texas has a small, white ear with soft grains, loosely arranged on the cob. It is not very productive of grain, but when the ears are in the hard dough stage, the entire plant makes a good green food for hogs or horses. This variety is recommended only for late planting; that is, in May or June, usually on land where small grain has been harvested.

There are other forms of Mexican June corn, among them a dwarf variety.

### LABORATORY EXERCISES

#### Races.

Make drawings from nature of the cross-sections of the grains of as many races as can be found, especially of dent, flint, pop, and sweet corn.

#### Main characteristics of varieties.

Study and write descriptions of as many as practicable of the most important Southern varieties, recording especially, —

- (a) habit of bearing one, or two, or more ears;
- (b) form of ear;
- (c) shape and size of grain;
- (d) size and color of cob.

## LITERATURE

- DUGGAR, J. F. Ala. Expr. Sta., Buls. Nos. 111 and 134.  
WILLIAMS, C. B. N. C. Expr. Sta., Bul. No. 204.  
KILGORE, J. B., and others. N. C. Board Agr., Bul. Vol. 29, No. 2, and later.  
STURTEVANT, E. L. U. S. Dept. Agr., Office Expr. Sta., Bul. No. 59.

## CHAPTER VII

### CORN — BREEDING OR IMPROVEMENT

CORN breeding is concerned with determining (1) what qualities of grain, ear, or plant are hereditary; (2) the best method of finding hereditary qualities; and (3) the means of improving or modifying hereditary qualities.

In other words, the plant-breeder's task is to maintain desirable qualities now in existence, and to add to them or so to combine them as to make subsequent crops more productive, or otherwise better suited to the farmer's needs.

#### 109. Improvement of varieties.

—Corn is so easily cross-pollinated and mixed with inferior kinds (Fig. 70), that few of the so-called varieties are strictly pure or uniform. Indeed, until within the

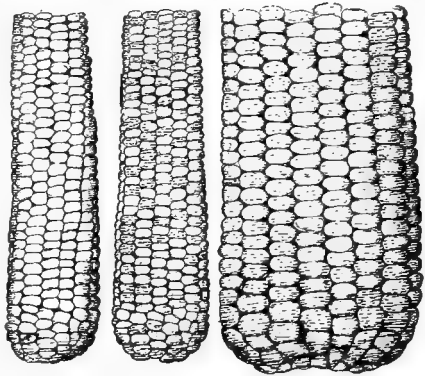

FIG. 70.—SHOWING THE IMMEDIATE EFFECTS (IN THE CURRENT CROSS) OF CROSSING A WHITE POP CORN (ON LEFT) WITH POLLEN FROM A YELLOW DENT CORN (ON RIGHT).

The resulting hybrid ear with both white and yellow grains is shown in the center.

past few years but few attempts have been made in the South to improve varieties by breeding or even to keep pure the best existing varieties. Almost any local kind, now found to be productive and otherwise valuable in its special locality, is worthy of being improved by careful and scientific methods of breeding.

The first effort of the breeder should be directed towards increased yield, to secure which he should select chiefly those plants which carry the greatest weight of grain. Next he should aim at uniformity, and at the other qualities usually considered desirable. Rather than to attempt to create an entirely new variety by crossing two existing kinds, he should start with one existing variety that is nearest to his ideal, or that best suits his local needs.

**110. Selection and crossing.** — The plant-breeder improves plants by two means: (1) by selection and (2) by crossing. Selection is generally more important for the breeder, and this is the only means of improvement that the average farmer can advantageously practice. Crossing occasionally serves a useful purpose in the hands of a skilled breeder; but it usually destroys uniformity and must always be followed by years of selection before its results become of practical value.

Selection of seed corn should be practiced by every farmer, and it gives results even in the first crop.

**111. Qualities needing improvement.** — Among the qualities for which selection should be made in developing varieties of corn for the Southern States are the following:—

- (1) Increased yield.
- (2) Production of two ears per plant.
- (3) Improvement in the shape of ear and kernels.

- (4) More uniformity among kernels, ears, and plants.
- (5) Increased closeness and firmness of grains on the cob.
- (6) Strength, or power of the plant to stand up.
- (7) Lower position of ear on the plant.
- (8) More complete covering of the tip by shucks.
- (9) Tendency for the mature ear to turn downward.
- (10) A decrease in the size of the plant in some varieties.

**112. Hereditary qualities.** — Among the stalk characters which have been found to be hereditary are the following: —

Height of plant; height of ear; length of shank; direction in which the mature ear points; number and width of blades; tendency to bear more than one ear; tendency to produce suckers; and ability of the mature plant to stand erect instead of being blown down. Practically all the peculiarities of ear and grain are hereditary.

**113. Height of ear.** — It is desirable that the ear or ears be borne at a medium height above the ground (Fig. 35). It has been found in breeding experiments (Ill. Expr. Sta., Bul. No. 132) that the height can be raised or lowered by selection with this definite end in view. In the fourth generation the average position of the ears was twice as high where selection had been made for high ears as in the strain selected for low ears, the difference in height of ears being about three feet.

Accompanying the lower position of the ears was earlier maturity, a decreased number of internodes and leaves, a decrease in the length of the internodes, and a decided diminution in the height of the plant.

**114. Angle of the mature ear.** — The Illinois Experiment Station has determined (Bul. 132) that the tendency

for the mature ears to remain erect or to bend downward is an hereditary quality, and that this tendency can be intensified by selection. The drooped ear, which is preferable because of its increased protection against rain, was found to accompany a long shank. One strain had shanks averaging 12 inches in length, the other 7 inches. The diameter of the shank did not, in this case, determine the direction in which the mature ear pointed.

**115. Barren plants.** — Barrenness, or the tendency for a considerable proportion of the plants to bear no ear, is usually regarded as hereditary.

Hartley (U. S. Dept. Agr. Year Book, 1902, p. 549) found that the removal of barren stalks from the field where seed was saved reduced the percentage of barren stalks in the next crop from 8.11 to 3.43. Since barrenness is difficult to detect before tasseling, it is advisable to remove the tassels from all poor stalks before they shed any pollen, whether these plants are entirely barren or merely weak and poor. The remaining tassels will furnish an abundance of pollen.

**116. Influence of size of ears.** — At the Virginia Experiment Station (Bul. 165, p. 170), the crop from large ears averaged 5 bushels more per acre than that from small ears of the same strain of corn. Likewise greater yields were obtained from large ears at the Ohio Station; the percentage of germination was higher for the grains on the larger ears, and the young plants from the larger ears grew more rapidly.

**117. Selection in the field better than in the crib.** — Selection of seed ears can better be made in the field than in the crib, especially in the case of two-eared or prolific



varieties. Selection in the crib tends to reduce the proportion of plants bearing two ears, and thus it may even be the means of reducing the yield. This is because in the crib, the largest ears are chosen, and these are most frequently from plants that produced only one ear. Selection in the crib is of more value when only one ear per plant is desired. But even in this case, crib-selection may serve to perpetuate plants with ears borne too high on the stalk or having other serious faults.

**118. Selection without an ear-to-row test.** — Those who cannot take the pains and time needed to plant an ear-to-row seed patch (see Par. 120) will profit by paying to some one else even a high price for corn thus improved. Such seed corn should be bought on the ear, so that all the qualities of the ear may be known.

It may be possible to maintain the excellence of a variety, but scarcely to effect rapid improvement, by simply selecting in the entire field ears from the best and most productive plants. To do this, the farmer should himself go through his field before harvest time and in a bag or basket gather as many ears as will be needed for seed. In making these selections, harvest the ears from the most productive plants, but not from those the productiveness of which is due to richer soil, to unusual distance from the next plant, or to other temporary advantage. Excellence due to these accidental causes is not transmitted to the next generation.

**119. Accidental versus inherited excellence.** — Great improvement in the yield of corn may be effected through the process of selection with a view to identifying and propagating those individual plants that have strong

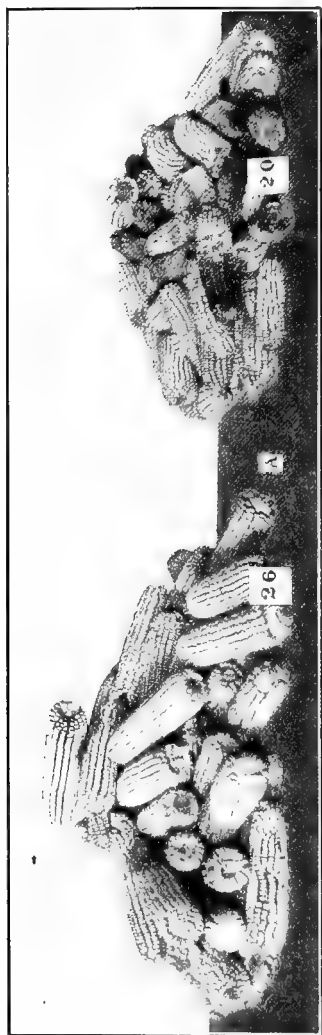

FIG. 71.—RELATIVE YIELDS OF THE SAME VARIETY OF CORN FROM 2 BREEDING ROWS OF SAME LENGTH.

hereditary qualities. The separation of such worthy individuals is by no means as easy as it may seem, for individual excellence may be due merely to favorable surroundings, as extra space or heavy fertilization, in which case the superiority is not transmitted to the offspring. On the other hand, it may be due to inherent power in the plant itself, independent of environment; such inherent excellence is hereditary.

The breeder's first task, then, is to devise a system by which he can determine which plants are accidentally productive and which are in themselves superior. In other words, he must find which good plants are able to transmit their good qualities. This is best done by means of the "ear-to-row" system of field testing.

**120. Ear-to-row system.** — This method consists in planting in one row only the seed from a single ear or from part of a single ear. At harvest time the yield of each row is determined separately. The best rows indicate which parent ear was best able to transmit its good qualities (Fig. 71). By selecting for seed the best plants on these best rows, and again planting each ear on a separate row, improvement is rapid, — provided the breeder, year after year, aims at the selection and perpetuation of the *same* good qualities.

Moreover, since self-fertilization year after year causes corn to deteriorate, it is advisable to prevent this by removing, as soon as they appear, the tassels from the rows on which seed-ears are to be selected.

In a breeding-patch in which this system is pursued proceed as follows: —

**121. Details of ear-to-row system of corn breeding.** — Select about 100 of the best ears obtainable from the given variety. From these discard all except 48, or other larger number, of the heaviest, best, and most uniform. Secure very uniform land and lay off as many rows as there are ears to be planted, say 48, noting that the two ends of all the rows are of apparently uniform fertility.

On each row, plant the greater part of a single ear, placing the best ears near the center of the plot (Fig. 72). The rows should be of uniform width and of such length as to contain at least 150 hills, the hills being in checks at a uniform distance apart. If practicable, preserve until after harvest time the unplanted grains on each ear, as the best of these remnants may be needed for planting the next year.

Around the edges of this breeding-plot, plant the best ears not used in the breeding-plot, these "general-crop rows" serving partially to exclude pollen of inferior plants and of other varieties. If practicable, let this breeding-plot

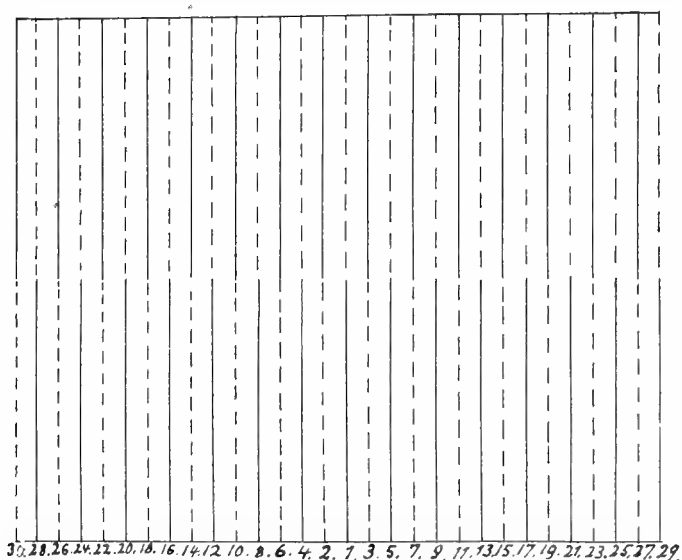

FIG. 72.—DIAGRAM SHOWING ARRANGEMENT OF ROWS IN CORN BREEDING-PLOT.

Dotted lines represent detasseled parts of each row, from which seed corn is selected; continuous lines represent parts of each row not detasseled; the best ears (1, 2, 3, etc.) are planted near the center of the plot.

be at least a quarter or half of a mile from any other field of corn, and preferably separated from any other corn by woodland.

If necessary, fertilize each half of each row with uniform weighed amounts of fertilizer.

As soon as the tassels show, and before they have discharged any pollen, remove the tassels on one half of every odd-numbered row (let us say the north half) and on the other (or south) half of every even-numbered row (Fig. 72). Seed is to be saved only from the detasseled plants, thereby insuring cross-fertilization.

From time to time as the crop grows, make note of and reject those rows on which the plants show undesirable qualities, as excessive growth of suckers, tendency to fall down, excessive height of ears above ground, and the like. At harvest, weigh the husked ears of each row separately and on each of the best ten rows place a label or tag on a number of ears from the best plants. On this tag should be entered the peculiar excellence, if any, of each selected plant.

For planting the breeding-patch of the second year, save the ears from the best plants on the 8 or 10 best rows. Use the remaining good ears from these best rows to plant larger fields next year. These steps are usually all that are necessary in the improvement of corn by most farmers.

The method of conducting the ear-to-row breeding-plot is the same year after year, obtaining seed each year from the best plants of the 8 to 10 best rows. All other good ears from detasseled plants of the most productive rows may be used as seed for a seed patch of several acres or for the general crop.

The limits of this book preclude an explanation of systems of numbering the ears and their offspring, for which the reader is referred to Illinois Experiment Station Bulletin, No. 100; Connecticut Experiment Station Bulletin, No. 152; and Bailey's *Cyclopedia of American Agriculture*, Vol. II, p. 424.

**The multiplication-plot.** — The ears from the most productive rows inherit productiveness on the side of the female or pistillate parent; but the pollen that fertilized these ears may have come from one of the most inferior rows. In order to insure the best pollen, careful plant-breeders sometimes take the additional step of planting each year a special multiplication-plot, or mating area of corn.

In this they plant the remnants of the best original ears saved from the planting of the preceding spring. These original ears in the intervening year have shown their ability to transmit productiveness to their offspring. These remnants of ears are pure; that is, free from admixture of pollen from inferior strains.

Hence, most rapid progress in corn breeding is made by having in the second year an isolated multiplication or mating-plot, in which are planted in alternate rows two or more of the best remnants of ears, as judged by the yields of the offspring of parts of the same ears in the ear-to-row test.

Half of the rows in the multiplication-plot should be detasseled. Thus self-fertilization is avoided and the union by cross-fertilization of two productive strains is insured.

When it is feasible to plant such a mating-patch, the ears from its detasseled rows constitute the seed for a seed patch of the third year, the product of which will plant the entire general crop of the farm, or be sold for seed. Since special equipment of ventilated, insect-proof jars or cases is needed in the South to preserve the remnants of the original ears for one year, most breeders omit the mating-plot, planted with such remnants of ears.

**122. Breeding for composition.** — Hopkins and Smith, at the Illinois Experiment Station (Bul. Nos 119 and 128), have proved that the composition of corn can be varied by selection of seed-ears. They selected for many years in succession kernels rich in the chemical constituent desired, as fat, protein, or starch. After continuing this work for a number of years, great variations were found in the resulting strains. For example, after ten years of

breeding, the strain continuously selected for its high percentage of oil contained 7.37 per cent of fat, or nearly three times as much as the strain selected for a low percentage of oil. The increase in oil makes this high-oil strain more valuable for the manufacturers who produce from it corn oil, and also gives to the grain a higher feeding value, but a tendency to produce softer, less desirable pork.

In ten years, the average percentage of protein in the grain was raised from 10.92 per cent at the beginning, to 14.26 at the end of the decade. The high-protein strain was then nearly twice as rich in this constituent as was the strain continuously selected for a low percentage of protein. The high percentage of protein gives to corn a higher feeding value, of a kind specially desirable when corn must be fed without being combined with other foods richer than itself in protein. Apparently, this strain was less able to resist drought, making a lower yield in a dry year than did the low-protein strain. It is highly probable that the high-protein strain more rapidly exhausts the soil.

In breeding for a high percentage of protein, the breeder should not be deceived if the percentage of this constituent should run abnormally high in a very dry season, a result which Hopkins and Smith found to be due to the failure of the grain, under these conditions, to assimilate its usual quantity of starch.

**123. Other effects of breeding for composition.** — The strain continuously selected in Illinois for low protein made larger ears and a larger yield of grain per acre than the higher protein strain; likewise, the strain poor in fat generally yielded more grain per acre than the strain rich in fat, and had larger ears than any other strain whatsoever. Its grains were broader, due to the larger proportion of starch, and consequently there was a smaller number of rows of kernels than on the ears of other strains.

**124. How to select grains according to composition.** — Those kernels, which, in cross-section, show a large proportion of germ, are rich in fat; those with an abundance of horny material are rich in protein; while those with the greatest proportionate development of loose floury material are richest in starch. It has been found that the composition of the kernels of the entire ear is about the same as that of any row of grains on the ear.

**125. Germination test.** — Care should be taken to select for planting only those ears on which nearly every grain will germinate. In a good sample, 97 per cent of the grains should sprout. A germination test of the ears planted is important, even when a larger number of grains is planted in each hill than will be left to grow there. This test becomes doubly important when thinning is to be avoided by planting in each hill only the number of grains expected to grow and to remain.

Many ears, apparently sound, afford but a low percentage of germination. Among the signs of poor germination are a dark area near the tip of the grain, or a shriveled tip; but many grains that appear to be sound fail to sprout.

Some farmers have found it profitable to test for germination every ear planted. The method used is the following: —

The seed-ears are spread out on the floor in order and a number attached to each by means of a small nail driven through a small pasteboard label and into the butt end of the cob. Each ear is given a number, and from each ear six or ten grains are removed, these being taken from different parts of the ear.

A germination-box is made by taking any shallow box of proper size, placing in it one or more inches of damp sand or damp sawdust (Fig. 73). The sand is covered with a white cloth, which is marked off with a pencil into squares about two inches each way,



each square bearing a number corresponding to the number on one of the ears. Six or ten grains taken from different parts of each ear are placed on the square bearing the same number as the ear. Another cloth (or cloth bag containing damp sawdust) is laid over the squares containing the grains to be tested, and over this second

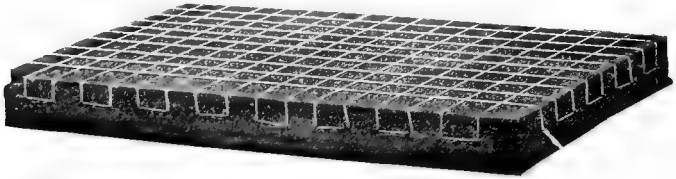

FIG. 73. — GERMINATOR MADE FROM A SOAP BOX, AND READY TO RECEIVE THE SEED.

cloth is spread about an inch of moist sand or damp sawdust. The box is placed in a warm room, and in seven to ten days a count is made to determine which ears sprout properly. Do not use for planting any ear which bore a grain that failed to sprout.

**126. Crossing versus selection.** — Crossing two distinct varieties results in variation (or a lack of uniformity) in the plants; uniformity may not again be completely established even after five or ten years of subsequent selection. Hence it is usually better for the farmer to improve his corn by selections among the individual plants of a single variety than to attempt to cross two dissimilar varieties.

However, since crossing in certain rare cases is advisable, and since it often takes place accidentally, a few of the simpler effects of crossing are briefly discussed.

**127. Definitions of degrees of relationship between corn plants.** — Self-pollination or in-breeding consists in placing the pollen of one plant on the pistil (silks) of the

same plant. This relationship is too close for best yields, especially if the process be continued for several years.

Close-breeding consists in crosses made among the silks and tassels of plants all of which sprang from grains borne in the next preceding generation on one ear. This relationship is so close as to incur the danger of reducing the yield of grain.

Cross-breeding consists in crosses made between plants that are not related. This may be

(a) Between unrelated plants of the same variety; or

(b) Between different varieties of the same race, as yellow and white dent corns; or

(c) Between different races, as sweet and dent corn.

As a rule, the most desirable relationship is cross-breeding between unrelated plants of the same variety.

**128. Effects of in-breeding and of cross-breeding on yield.** — Experiments have shown that continued self-fertilization of the corn plant reduces the yield; and when self-fertilization is practiced for several successive generations, it may dwarf the stalk and finally result in some measure of sterility (Figs. 75, 76). Halsted (N. J. Expr. Sta., Bul. No. 170) found that self-pollination in sweet corn tended to increase the percentage of albino plants; that is, those with white foliage — an undesirable quality.

*Cross-breeding*, on the other hand, invigorates the strain, and some recent experiments show that it may greatly increase the yield in the first generation of cross-bred plants. But it should be remembered that cross-breeding of dissimilar types has the serious disadvantage of destroying uniformity. It should be confined chiefly to plants of the same variety, or to very closely related varieties.



FIG. 74.—SHOWING BAD EFFECTS OF CONTINUOUS IN-BREEDING.  
Compare with Fig. 75.



FIG. 75.—SHOWING LARGER YIELD AND BETTER EARS  
FROM CORN NOT IN-BRED.  
Compare with Fig. 74.

129. **Inheritance of color.** — Any part of the ear or grain that develops when pollen is excluded is obviously merely the outgrowth of tissue from the mother plant. By in-

closing the young ear-shoot in a paper bag, it is found that among the parts that develop in the absence of pollen are the cob and the hull (or seed-coats) of the grain. These parts (cob and seed-coats) cannot be changed in the current cross (that is, in the generation in which the cross is made) by pollen from a plant having a different character in these parts (see Pars. 90 and 95).

Now whenever grains of corn are red, the red color is located in the hull. Proof of this is shown by the fact that meal from red corn is white, after the bran has been carefully sifted out. Hence if the female parent has red grains, the grains maturing soon after a cross is made will be red, no matter whether the pollen used be from a plant with yellow, with white, or with bluish grains.

In the same way if pollen from a red variety be placed on the silks of a white or yellow variety, the grains of the current cross will all be of the same color as that of the silk-bearing parent.

Very different is the way the yellow color of the corn grain is transmitted. The yellow color resides, not in the hull, but deeper in the structure of the grain; that is, in the endosperm. Proof of this is shown in the fact that meal from yellow corn is always yellow, even after the most complete removal of the bran.

Those parts of the kernel inclosed inside of the hull, that is, the germ and the endosperm (including the aleurone layer), may be visibly influenced by the pollen used in the current cross, that is, by "double fertilization"; these inner portions of the grain may display in a few weeks after the cross is made the color derived from the sire or pollen-bearing plant. Now the yellow color is located in the endosperm. The purple color is located in the thin aleurone layer just under the seed-coats. Both the endosperm and its aleurone layer are subject to double fertilization by pollen, and thus they are at once influenced in color by the male parent. Hence pollen from a pure yellow variety, falling on silks of a white kind, promptly makes the grains thus fertilized yellow. Likewise pollen from a lead-colored corn, falling on silks of a white variety, promptly makes the hybrid grains lead-colored.

This is because both the yellow and the lead colors, being in the endosperm, which may be influenced by the male parent, display their color through the transparent hull or bran of the white mother plant.

But in the next generation, these hybrid seeds produce grains of various colors or shades.

**130. Dominance of certain qualities in hybrids.** — According to Mendel's law, certain pairs of opposite qualities are not inherited in mixtures or blends, but separately, every individual descendant showing one or the other of these opposing qualities. The quality that shows in the greater number of the descendants is called *dominant*, while the quality showing forth in the smaller number of descendants of the cross is called *recessive*.

Experiments have shown, according to East (Conn. State Agr. Expr. Sta. Rept. 1907-1908, Part VII, p. 41), that in corn the following characters are dominant over their opposites:—

- Yellow is dominant over white color of kernels.
- Red is dominant over white color of kernels.
- Purple is dominant over white color of kernels.
- Flint quality of grains is dominant over dent.
- Flint quality of grains is dominant over sweet.
- Dent quality of grains is dominant over sweet.

Certain dominant qualities show in the current cross; among these are yellow or purple color of grains (when crossed on white varieties), and flintiness of grains, whether crossed on dent or on sweet corn. As a rule, the recessive grains, or those showing no effect of the cross in the second hybrid generation, are practically pure as to that quality, and these pure white or pure dent grains of the second hybrid generation subsequently come "true to seed." But the grains showing the dominant quality, yellow color or flint structure, cannot thus be selected as pure, because many of them have been influenced, though imperceptibly, by the recessive character (white color or dent structure). In other

words, of the seed showing dominant qualities some are pure dominants and some are mixed, though having the same appearance as the pure dominants.

**131. Practical results.** — Practical application may be made of the somewhat technical statements in the last few paragraphs in the following way, and in other operations in plant breeding: —

(1) After crossing pollen of a pure yellow variety on silks of a pure white variety, say in 1910, practically all of the grains of the current cross in 1910 may be expected to be yellow or yellowish; all the pure white grains found in the second generation among the descendants of this cross may be considered as pure-bred so far as concerns color, and these white grains may be expected in all future years to produce only white grains.

(2) After crossing pollen of a pure white variety on silks of a pure red variety, all the grains of that current cross will be red (because the hull of the grain is furnished by the mother parent, uninfluenced by the pollen used in the current cross); when these red grains are subsequently planted, the crop will contain a majority of red grains, most of which will be impure, as shown by their descendants, bearing both red and white grains.

On the other hand, the white grains, found in the second generation in smaller number among the red grains, are pure; and when these white kernels are planted, their offspring will consist entirely of white kernels.

**132. Relative value of top and bottom ears for planting.** — When there is any considerable inequality in size between two ears growing on one plant, the upper ear is generally the larger.

Using plants of identical parentage, Hartley<sup>1</sup> found that the yield of grain per plant grown from lower ears was equally as great as the yield from plants grown from upper ears. He found the plants grown from middle ears (on three-eared plants) to average 0.65 of a pound of ear corn per plant, as compared with 0.70 of a pound from the offspring of both upper and lower ears borne by the same parent plants.

Redding (Georgia Experiment Station, Bul. No. 55) obtained a slightly larger yield of grain from the offspring of bottom ears than from those of upper ears. The Alabama Experiment Station (Bul. No. 134) obtained in 1903 with St. Charles White a greater yield from upper ears, but in 1905, in a more extensive test with the Experiment Station Yellow variety, there was practically no difference in the grain yield of plants tracing to upper and to lower ears. At the Rhode Island Station (Bul. 116) Card found in sweet corn a tendency for the seed from upper ears to produce a greater number of ears per plant than seed from lower ears. This he assumed to be due to the more complete maturity and greater size of the upper ears of sweet corn.

On the whole, available evidence is not sufficient to show any material difference between top and bottom ears for planting; and on theoretical grounds we should expect top and bottom ears, if equally developed in size and maturity, to be equally valuable for planting.

**133. Seed from different parts of the ear.** — It is customary in the South to remove the grain for about an inch both at the tip and at the butt of the ear. Numerous experiments show little or no difference in yield of corn produced by planting grain from the tip, butt, and middle portions of the ear. Even when the experiment extended through a number of successive generations, there were no notable differences in the yields.

<sup>1</sup> American Breeders' Association, Vol. II, p. 124.

Hartley found that the small kernels, usually on the tip, gave a higher percentage of weak and unproductive plants than larger kernels. Jeffrey (Mich. Exp. Sta., Circ. 3) found that in most, but not in all varieties, the butt kernels germinated more slowly and the tip kernels more promptly than those from the middle of the ear (Fig. 76).

The Illinois Experiment Station has shown (Bul. 55, and Bul. 128, p. 460) that the tip kernels contain a slightly lower percentage

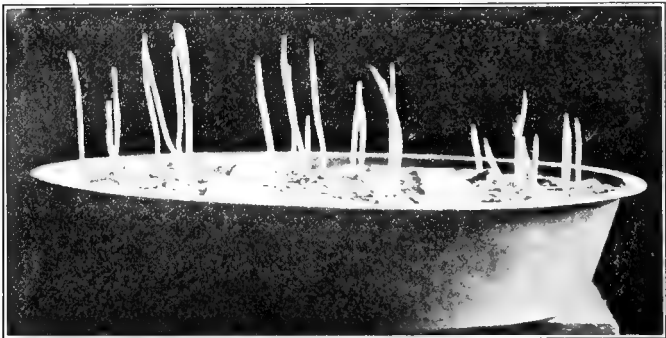

FIG. 76. — YOUNG CORN PLANTS.

On left, from tip kernels; in center, from middle grains; and on right, from butt kernels.

of protein than the middle or butt kernels, and that the butt kernels are slightly the richest in this constituent. The tip kernels contained a slightly larger proportion of starch than the others. Kernels from the tip, middle, and butt were practically alike in percentage of oil and ash.

On the whole, it seems advisable to remove the tip grains of the seed-ears: (1) so as to secure seed of more uniform size, an important consideration where a constant number of grains must be dropped by the planter in each



hill; and (2) so as to avoid injured and very small grains, which would either fail to germinate or else cause the young plants produced from them to grow off slowly.

**134. Grading the seed grains.** — When extreme care is taken to get all kernels of as nearly a uniform size as possible, in preparation for machine planting, each ear, after being “nubbed” and “tipped,” may be shelled separately into a pan, and the resulting grain grouped into kernels of three different sizes or shapes. This is more conveniently done by shelling all nubbed and tipped ears together and then separating the grains into three sizes by passing them through a series of sieves with meshes of different sizes.

**135. Effects of change of climate.** — Corn brought into the South from a cooler climate acquires year by year in its new home greater height of stalk and later maturity. With many highly improved varieties the grains apparently become shorter and the number of rows may be reduced.

As a rule, varieties from the corn-belt are not adapted to the cotton-belt. They mature too early, make a smaller yield of grain and stover than native varieties, and the grain is often unmarketable, being weevil-eaten and chaffy.

Among the relatively few varieties from the corn-belt which have in a few experiments shown fair yields of grain are Boone County White and St. Charles White. Even these afford a better grade of grain when the date of planting is rather late.

In the region just north of the cotton-belt, the Western varieties are nearer an equality with the native kinds.

As a general rule, the best seed corn is that produced in nearly the same latitude where it is to be grown. Usually corn of Southern varieties produced south of the Ohio and Potomac

corn succeeds anywhere in the cotton-belt. Corn growers just north of the cotton-belt are able to use seed from a still higher latitude, but here, too, native improved varieties and locally grown seed are usually more satisfactory than seed corn from a widely different climate.

### LABORATORY EXERCISES

#### Comparison of ears.

(1) Select 5 or 10 plants with ears high above the ground and record the average height above ground of the node bearing the upper ear.

(2) Make the same record for 5 or 10 plants in the same field with ears low on the stalk.

(3) If practicable, compare the maturity and weights of the shucked ears on the two types of plants just mentioned.

#### Upper and lower ears.

(4) Select ten plants, each bearing two well-developed ears. Shuck and compare the weights of

(a) the ten upper ears and

(b) the ten lower ears.

(c) Does the upper or the lower ear develop and mature first?

(5) TIP, BUTT, AND MIDDLE GRAINS. Make germination tests of 100 tip grains, 100 butt grains, and 100 from the middle of the ear.

(6) VARIATION. Record for two plants of the same variety as many points of difference as you can discover.

What does this suggest as to the advantages of seed selecting and breeding?

#### Color of grains.

(7) Soak kernels of red and yellow corn, separate the coats, and determine in what part of the grain each color is located.

#### Barren plants.

(8) Determine in any field the percentage of barren stalks.

**Silks.**

(9) Provided any corn in silking stage is available.

- (a) With a magnifying glass examine the fresh silk sticking out beyond the shuck for hair-like branches and for pollen grains that have lodged on the silk.
- (b) Tie large, strong paper bags over several young ear-shoots before any silks appear.
- (c) A few days after the silks appear under the bags, note how much longer they are than silks which have received pollen.
- (d) While the silks under one bag are still fresh, and before any pollen has reached them, cut all the silks on one side of the ear, just inside the shuck; apply corn pollen on the remaining silks. In three weeks note the number of grains of corn developed on each side of the injured ear.

## LITERATURE

- EAST, E. M. Conn. (State) Expr. Sta., Rpt. 1907-1908, Part VII, p. 41, and Conn. (State) Expr. Sta., Bul. No. 158.
- SMITH, L. H. Ill. Expr. Sta., Bul. Nos. 128 and 132.
- WILLIAMS, C. G. Ohio Expr. Sta., Circ. No. 71.
- HARTLEY, C. P. U. S. Dept. Agr., Farmer's Bul. No. 229.
- SOULE, A. M., and VANATTER, P. O. Va. Expr. Sta., Bul. No. 165.
- DAVENPORT, E. The Principles of Breeding. New York, 1907.
- DAVENPORT, E. Ill. Expr. Sta., Bul. No 119 and Circ. No 101.
- WEBBER, H. J. Plant Breeding. Bailey's Cyclo. Agr., Vol. II, pp. 53-69; and Xenia (double fertilization), U. S. Dept. Agr., Div. Veg. Phys. and Path., Bul. No. 22.

## CHAPTER VIII

### CORN — SOILS, ROTATIONS, AND FERTILIZERS

WHILE corn will grow on an extremely wide range of soils, yet good yields can be expected only on rich or highly manured land. The corn plant, with its abundant foliage, actively engaged in transpiring moisture, needs large supplies of water. Therefore, the best soil for corn is one which can furnish a large and regular supply of water during periods of dry weather. Such a soil is usually a deep, rather rich loam, well supplied with vegetable matter. As a rule, bottom lands afford larger yields of corn than uplands.

**136. Bottom lands and uplands for maize.** — Bottom lands on which corn makes its best yields should be well drained, since the corn roots need a constant supply of oxygen from the air, and air cannot penetrate saturated soil. Neither can the roots range to sufficient depth when the line of saturation is near the surface. The more poorly the land is drained, the later must the corn be planted and the greater the risk of failure, should the subsequent season be unfavorable. Uplands can be fitted for a maximum development of corn by gradually increasing the depth of plowing and by constantly adding vegetable matter, by judicious rotation of crops, or by the application of barnyard manure.

**137. Poor and acid soils.** — It is doubtful whether land so poor as to produce without fertilizers only 10 bushels of corn per acre is in condition to produce a profitable crop of corn, even when fertilized. It will usually be more profitable in such cases to grow first a crop of cowpeas or of some other soil-improving plant before planting the land in corn.

Corn makes a fair yield even on land that is slightly acid; but on such soils, the yield is usually improved by an application of about half a ton of slacked lime per acre. Corn is more intolerant of dryness in the soil than of any other condition. A dry or thirsty soil may cause the leaves to "fire" and the plant to be undersized, with only one ear or nubbin per plant. Moreover, on thirsty land, the distance between plants must be wide, resulting in a small yield per acre.

**138. Other corn soils.** — In selecting land for corn, deep sand beds should be avoided, as being too poor and dry. The stiffest clays are also not desirable, since they are often too compact for sufficient penetration by the roots and for thorough preparation, cultivation, and drainage. Corn is a favorite crop on new ground or land from which the timber has just been cleared.

#### ROTATION

**139. The place of corn in a rotation.** — On cotton farms there is too frequently no effort to practice rotation or systematic change of crop from field to field. Especially is there a failure to alternate any other crop with corn, for the reason that in the sandy and hilly country corn is generally planted on the narrow bottoms, which constitute the best

corn land of these regions. In these cases (on the richer bottoms), so long as the yield is satisfactory, and no undue amount of disease appears, it is probably better to violate the usual rules of rotation and to grow corn continuously than to change it to the shallow, dry soils of the hills. However, tracts that must for this reason be cropped annually with corn should be carefully supplied with vegetable matter by one of the following methods: (1) Either by sowing cowpeas thickly each summer among the growing corn plants, or else (2) by growing each winter a crop of crimson clover, bur clover, hairy vetch, or other winter-growing legumes, to be plowed under in April or May as fertilizer for the corn crop of the same year.

**140. A three-year rotation.** — When possible, corn should enter into the regular farm rotation. In the rotations best suited to the average cotton plantation corn usually follows cotton, and is followed by fall-sown oats or by wheat. This position is given to corn, not for its own advantage, but because corn can easily be removed in time for the fall sowing of the small grains, while cotton is not generally removed at so early a date.

Incidentally, corn grown after cotton gets the advantage of the clean and late cultivation given the latter, and this starts the young corn plants promptly into growth. Corn, following cotton on a field comparatively free from the seeds of weeds and grasses, can be produced with less labor than corn after corn. A good three-year rotation is the following: —

First year: cotton;

Second year: corn, with cowpeas between the rows;

Third year: oats or wheat, followed by cowpeas.

This places corn on one third of the cultivated area each year. When this rotation is repeated through the fourth, fifth, and sixth years, it is plain that cowpeas or cowpea stubble, following the small grains, is plowed under just a full year before corn occupies the land.

**141. A four-year rotation.** — The above scheme may readily be changed into a four-year rotation by growing two successive crops of cotton, the first of which may well be followed by a catch crop of crimson clover, plowed under about April 1, as fertilizer. This places corn on one fourth of the cultivated land and on fields where cowpeas were plowed under two years before and where, perhaps, crimson clover was plowed under one year before the corn was planted.

#### FERTILIZERS

**142. Need for a fertilizer rich in nitrogen.** — Corn must make a rapid development of stalk, leaf, and ear, and for this purpose there must be present in soil or fertilizer a large amount of plant-food. The rapid growth seems to make especially necessary large supplies of nitrogen. Those soils richest in nitrogen almost invariably produce the largest yields of corn.

In unpublished experiments made on a wide variety of poor soils in Alabama, nitrogenous fertilizers have increased the crop to a much greater extent than any other kinds. In these tests, potash was usually of far less value than when applied to the cotton plant. Acid phosphate was intermediate in value between the nitrogenous and phosphatic fertilizers. However, the results of fertilizer experiments vary greatly according to the nature and previous history of the soil.

**143. Leguminous plants an economical source of nitrogen.** — Recognizing the great need for nitrogen, the wise farmer will provide it in the most economical and effective manner. This is best effected by the use of cowpeas or other leguminous crops, grown on the land, and either plowed under as fertilizer or used as fertilizer after having been consumed by animals. When nitrogen is supplied in these bulky forms, the plant-food is accompanied by a large mass of vegetable matter, which has the effect of making the land more retentive of moisture in periods of drought. Thus fertilization with nitrogen, through rotation with leguminous plants, supplies the two greatest needs of the corn plant, namely, nitrogen and moisture.

**144. Suggestive fertilizer formulas.** — Proper fertilization is governed by soil, kind of tillage, previous treatment of the land, and other considerations. No one fertilizer formula therefore fits all conditions, but the following are suggested: —

(1) By the Georgia Experiment Station (Bul. 74). For corn on worn uplands, —

Acid phosphate, 1000 lb.  
Cotton-seed meal, 1218 lb.  
Muriate of potash, 32 lb.  
Total, 2250 lb. (for several acres).

This fertilizer analyzes about 10 per cent available phosphoric acid, 5 per cent nitrogen, and 2 per cent muriate of potash.

The author suggests the following as often applicable for loam and clay soils, —

- (2) 100 to 200 lb. acid phosphate per acre ;  
100 lb. nitrate of soda, the latter applied when the plants are 2 to 4 feet high, on one side of each row ; or,



- (3) 100 to 200 lb. acid phosphate,  
200 lb. cotton-seed meal.
- (4) For very sandy soils, —  
100 to 200 lb. acid phosphate,  
100 lb. nitrate of soda (or 200 lb. cotton-seed meal),  
50 to 100 lb. kainit.

For land that has been enriched in nitrogen by the plowing under of cowpeas or similar growth, it will usually suffice to fertilize with 200 lb. per acre of acid phosphate or of an ordinary cotton guano. But even here, it will often be profitable to add 50 or 100 lb. of nitrate of soda when the plants are 2 to 4 feet high.

When corn is grown in rotation on fairly good loamy or clay soil, it appears to be better policy in most cases to withhold potash from the corn, which is often unresponsive to it, and to apply if necessary an additional amount to the cotton crop grown in the same rotation, — thus getting the benefit of its specific effect in restraining cotton rust on soils subject to this malady.

**145. Time to apply fertilizers.** — When ordinary amounts of commercial fertilizer, say 200 to 400 pounds per acre, have been used, most experiments have shown at least as large yields from applying the whole before planting as from applying a part before planting and a part during the cultivation of the crop. This conclusion is summed up in a quotation from Bulletin No. 74, Georgia Experiment Station, by Redding: "The experiments conducted on this station long since proved that . . . (inter-cultural fertilization) is not profitable as a rule. On the other hand it is often advisable to withhold a part of the fertilizer for inter-cultural application, when the total amount to be applied is large; for example, 500 to 1000 pounds per acre."

In the Williamson method of corn culture (see Par. 175), all of the fertilizer is applied comparatively late in the life of the plant.

Whenever nitrate of soda is the nitrogenous fertilizer, it should be applied wholly or in part after the plants have begun growth and before they shoot, preparatory to tasseling. It is believed that nitrate of soda is more effective if applied when the plants are between 1 and 4 feet high than if placed in the soil at a later stage of maturity.

**146. Methods of applying fertilizers.** — When commercial fertilizer is applied to corn, it is usually drilled in. The Georgia Experiment Station found that about the same results were obtained from half a pound of fertilizer in the drill as from one pound sown broadcast. The method of distribution in the drill before the planting of the seed is by hand application or by the use of a fertilizer distributor, or by the use of a combined fertilizer distributor and planter, which performs both operations at one time.

When fertilizer is applied to corn after planting, it is usually placed in a furrow 2 to 4 inches deep and a few inches from the line of plants. With most fertilizers, it is desirable that this later application, when made at all, be at a depth of 2 to 4 inches, so that this layer of fertilizer and the roots congregating around it may not be disturbed by subsequent shallow cultivation.

When nitrate of soda is applied after the corn is 1 to 4 feet high, it is drilled 6 to 8 inches from the plant, the depth being of little consequence. Indeed, nitrate of soda requires no covering when applied on damp soil. However, it is generally advisable for it to be covered slightly by the next cultivating furrow, so that if a sudden heavy rain should occur, this fertilizer would not be so completely washed away as if it were caught by rain while still on the surface.

**147. Quantity of fertilizer.** — Until the recent agitation about the Williamson method of corn culture, it was the general opinion that it was ordinarily not advisable to use very large amounts of commercial fertilizer for corn, 400 pounds per acre being then considered a rather heavy application for this crop.

Experience shows that corn does not, as surely as cotton, pay a large profit on a large quantity of commercial fertilizer. There is more risk with the corn crop because its bearing season, from silking to hardening of the kernels, is shorter than the fruiting season of cotton; and drought at this critical time in the life of the corn plant is apt to ruin the crop, regardless of the amount of fertilizer employed.

#### LABORATORY EXERCISES

(1) Compare 10 corn plants grown on a rich bottom soil with 10 others of the same variety grown on a dry upland, recording:—

- (a) average height of plant;
- (b) average height of upper ear above ground;
- (c) average number of square feet of ground occupied by each plant, and
- (d) average weight of shucked ear or ears per plant.

(2) Apply a teaspoonful of nitrate of soda to each corn plant on one row and each week afterwards compare the size and color of plants on this row with those that received no nitrate of soda.

#### LITERATURE

- DUGGAR, J. F. (Rotation.) Ala. Expr. Sta., Bul. No. 134.  
DODSON, W. R. (Rotation.) La. Expr. Sta., Bul. No. 111.  
WHITNEY, MILTON. (Fertilizers.) U. S. Dept. Agr., Bur. Soils, Bul. No. 64.

## CHAPTER IX

### CORN — THE TILLAGE OR CULTIVATION

Southern lands are usually in extreme need of vegetable matter. Too often the stalks of corn or cotton are burned in preparation for the next crop. Whenever possible,

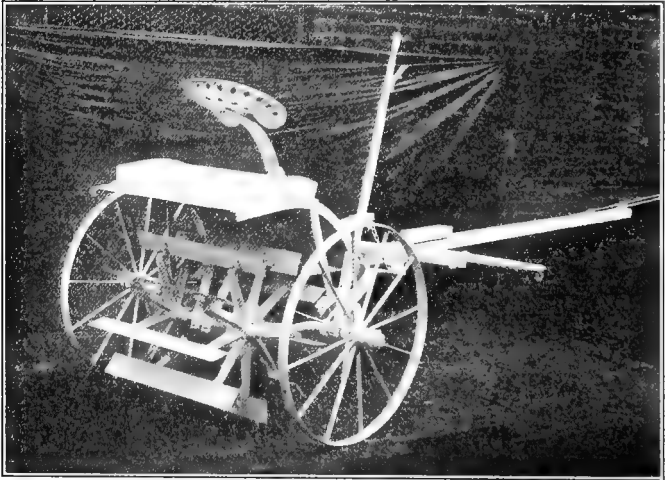

FIG. 77. — A STALK-CUTTER.

the stalks and weeds, instead of being burned, should be plowed under. To do this properly, it is often necessary to use a stalk-cutter (Fig. 77), which is usually drawn

by two horses. At each trip it cuts into bits, about a foot long, the stalks on one row. In the absence of the stalk-cutter, corn stalks are cut into two or three sections with the hoe, and large cotton stalks are chopped with a stalk-cutter or broken by beating them with a heavy stick, preferably on some frosty morning in winter.

In plowing under weeds or other litter, the work can be much better done by dragging the loop of a heavy chain, one end attached to the beam and the other end to the outer end of the single-tree on the same side as the moldboard. The loop of this heavy chain runs just in front of and above the share of the plow and bends the weeds down so that they can be completely covered by the inverted soil.

**148. Time of plowing.** — The time must vary with conditions. The stiffer the soil and the larger the amount of vegetation to be plowed under, the earlier should plowing be done. On stiff soil plowing may well begin in November and be completed before Christmas. While land plowed at this time will have become compacted on the surface by planting time, this surface crust can easily be lightened by the use of a disk-harrow just before planting.

There is considerable leaching, or waste of fertility, from plowed soils left bare during the winter, especially from sandy soils. This loss is greater the earlier in the fall the plowing is done. Hence the preparation of sandy soil may be postponed until the stiffer soils have been prepared, but even sandy soils should be prepared for corn before the teams are monopolized in the preparation of land for cotton.

**149. Ridging versus flush plowing.** — The main systems of preparing land for corn may be classified as follows: —

- (1) Ridging, or forming beds on which the rows of corn

are to be planted; (2) plowing land on the level, which is called flush or broadcast plowing; (3) preparing the land so that corn may be planted in the water-furrow or depression between the beds.

Ridging, or bedding, is confined to a few regions where the drainage is deficient; for example, the prairie or stiff, waxy lime lands of Alabama and Mississippi. Even here, while bedding is perhaps generally necessary for corn planted early on poorly drained soil, it can often be dispensed with, or the height of the beds can be reduced. The disadvantages of planting on elevated ridges are great, among them being the following:—

(1) More surface is exposed to evaporation and the row dries out more rapidly;

(2) The depth of soil left in the water furrow is insufficient to support plant roots, thus confining them largely to the limited area immediately under the ridge.

The one purpose and advantage of ridging is to secure increased drainage and warmth. Hence, even in the regions where usually regarded as necessary, the ridging of corn that is planted late is usually undesirable.

**150. A modified ridging system.**— A system that has not come into general use but that has been recommended for stiff, poorly drained soil, is the following, which affords drainage on one side of each row, and on the other side all the advantages of level planting.

Prepare the field by back-furrowing so as to make eight-foot lands, or lands of double the width desired for a single row. Plant two rows 4 feet apart on this eight-foot land. This places each row 2 feet from a water-furrow on one side. The other side of the same row can be tilled level.

**151. Level preparation and planting.** — There are numerous advantages in plowing the land level rather than into ridges. As a rule, the soil is thus more completely turned and a greater variety of improved implements can be used, — for example, the disk-plow, the row marker, and the check-rower, or two-horse corn planter. Moreover, except on very wet soils, the yield of corn is usually greater from level planting than from ridging. This is due to the greater ability of the level land to retain moisture during periods of drought and to the wider range of the roots, and to their more uniform covering with moist soil. Level planting is preferable for corn tilled in checks and for many loamy soils, whether the crop be checked or drilled.

**152. Planting in the water-furrow.** — On sandy upland soils in most parts of the Gulf States, it is the custom of many farmers to plant corn in the water-furrow formed by first bedding the land, thus placing the seed in a deep depression. It is asserted for this method that by placing the plants deeper it brings their roots into a moist layer of soil and increases resistance to drought. It also makes tillage easier, saving part of the work with the hoe, for the reason that the filling of the furrow by the cultivating implement readily covers and smothers young grass.

In a comparison of this method with that of planting on beds (doubtless low beds), the Georgia Station found no advantage from planting in a water-furrow on reddish clay-loam — a soil which is somewhat stiffer than in the regions where planting in the water-furrow is most customary.

At the Alabama Experiment Station (Bul. No. 111), on

permeable gray sandy soil (Norfolk sandy loam), the yield was one year favorable and one year unfavorable to this method as compared with level planting.

Planting corn in water-furrows is not to be commended for stiff soils; but for permeable sandy soils, this course seems to be advisable.

**153. Preparation for planting in the water-furrow.** — This system is the most popular one on sandy uplands and other dry soils. When the preparation is to be thorough, ridges are made by back-furrowing in such a way as to leave the water-furrows about 5 feet apart. The bed is not quite completed, but a narrow strip or balk, 6 to 8 inches wide, where the water-furrow will be, is left unplowed until the farmer is nearly ready to plant corn. Then with a shovel plow, he throws out this balk and plants the seed in the freshly broken furrow, often by means of a combined fertilizer distributor and planter, which places both fertilizer and seed at the bottom of the newly made water-furrow and 5 to 8 inches below the level of the highest part of the ridge.

During tillage, the soil of the ridge is worked toward the plants in the water-furrow, so that, when the crop is laid by, the field is practically level.

“Listing” is a special method of planting in a deep furrow; it is common in the dry regions of the Southwest.

**154. Depth of plowing.** — Naturally this should vary with the character of the soil and the depth of the previous plowing. In general, it may be said that most Southern corn fields are not plowed deep enough. The increase in depth is best made gradually, plowing each year one inch deeper than the preceding, until the desired



depth is attained. The earlier in the season the land is plowed, the greater is the increase in depth that can properly be made. Hence, fall plowing or early winter plowing may be deeper, sometimes an inch deeper, than plowing done in February or March. Usually the yield is decreased by bringing to the surface, especially near the time of planting, any very large amount of clay from the subsoil. But while this may reduce the first crop, the increased depth is apt to increase the yields of subsequent crops.

**155. Subsoiling.** — A method of suddenly increasing the depth of plowing consists in running a special subsoil

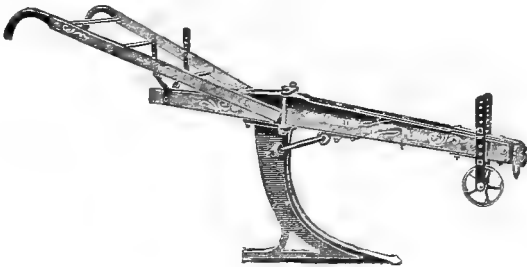

FIG. 78. — A SUBSOIL PLOW.

plow in the bottom of every furrow made by an ordinary turn-plow. This may double the depth of soil stirred. As a rule, subsoiling is best done in November or December, or before the beginning of the rainy season of winter. After the winter rains begin, the subsoil of most fields is usually too moist for the advantageous use of a subsoil plow. If subsoiling is done when the subsoil is too wet (and this may be the case while the surface soil is

abundantly dry for plowing), more harm than good will result.

Since the subsoil is compact, much power is needed to pull a subsoil plow (Fig. 78), making this a rather expensive operation. While there are many exceptions, the majority of experiments in subsoiling land subsequent to January 1 have shown no immediate increase, or not enough to pay for the extra cost of subsoiling. Subsoiling, when needed

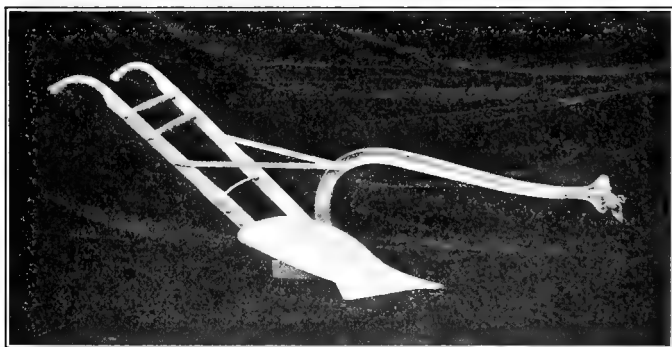

FIG. 79. — A TURN-PLOW.

at all, should not be done more frequently than once in two or three years. It is usually more practicable to increase the depth of ordinary plowing than to practice subsoiling.

*Implements used in preparation for corn.* — Besides the stalk cutter, the implements for preparation are usually either the turn-plow (Fig. 79), which may be of various sizes and patterns, or the disk-plow (Fig. 80). The latter is suited only to level plowing but does its work more completely than the turn-plow, though apparently at greater expenditure of horse power. Use is sometimes

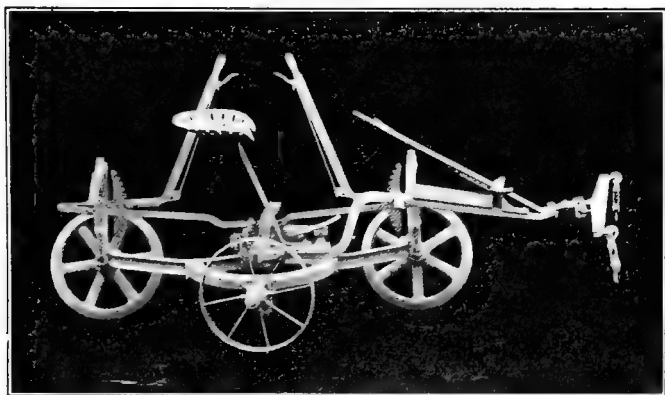

FIG. 80.-- A DISK-PLOW.

The disk which turns the soil shows only dimly beyond the frame.

made of a double moldboard plow or "middle burster," and, in the semi-arid Southwest, of a somewhat similar "lister." Doubtless some of the labor-saving implements of the latter region, such as "listers" and "combined listers and planters" (Fig. 81) could be effectively used on sandy soils in the South. Various forms of



FIG. 81.— COMBINED LISTER AND CORN PLANTER.

harrow (Fig. 85) are used by the best farmers to pulverize the clods after plowing.

*Partial preparation.* — Two methods of preparation deserve notice here, both involving the performing of only a part of the work before planting. Much of the corn in the limestone prairie region of Alabama and Mississippi is planted by making a list, or slight ridge, with two turn-plow furrows thrown on the seed dropped in the old water-furrow. Then the ridge is completed by throwing two or more additional furrows of a turn-plow against this "list." This method places the seed deeper in the ground than is probably advisable in such stiff soils but gives opportunity for a practice not yet in common use in that region, namely, the partial pulling down of the ridges and the cultivation of the field by using the spike-tooth harrow before the corn comes up.

Another system of partial or deferred preparation is practiced to some extent in the sandy or hilly region. A deep furrow is opened, in which the seed and fertilizer are placed; then a furrow on each side is thrown toward the seed, the greater part of the land remaining unbroken until cultivation begins. The combined breaking and cultivation is done gradually with a small, deep-running plow or shovel. This is obviously a laborious method, requiring the use of small, unsatisfactory implements. Its chief excuse is the occasional occurrence of continued wet weather at a time when land for corn should be prepared.

**156. Planting.** — Much corn is still dropped by hand, and in this case it may be covered by any kind of a plow. Much is planted by one-horse or single-row planters (Fig. 82), with which fertilizer distributors are often combined. The use of check-rowers (two-row planters) is restricted in the South to a rather limited number of localities where the land is comparatively level. Planters save labor, usually afford a more even and prompt germination, and leave the young plants in straighter lines, thus making tillage easier.

**157. Depth of planting.** — Corn may be planted and come up well at almost any depth between 1 and 4 inches. The general rule is to plant it just deep enough to insure a continuous supply of moisture. Hence, planting late in the season on a dry, loose seed-bed may require the seed to be covered with 3 or even 4 inches of soil. In the

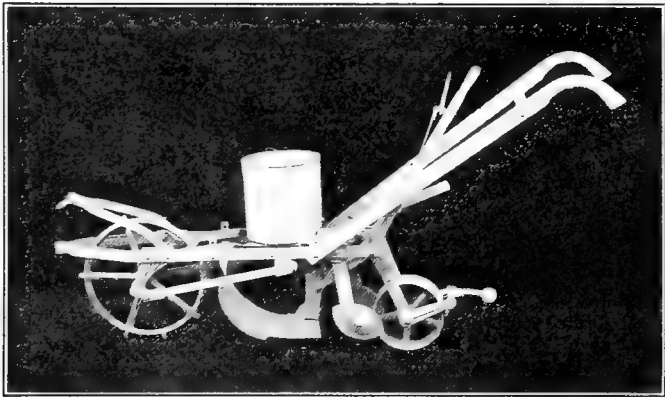

FIG. 82. — A ONE-ROW CORN PLANTER.

earlier part of the season  $1\frac{1}{2}$  to 3 inches may be considered the best depth for most conditions.

The depth of rooting is not strictly governed by the depth of planting, since the few roots thrown out near the sprouting kernel are not the ones from which the plant draws most of its water and food (Fig. 83). Most of the permanent roots originate at the crown, which is usually about 1 inch below the surface of the soil, regardless of the depth of planting.

158. **Date of planting.** — In the southern part of the Gulf States, east of Texas, corn planting becomes general about the first of March; and in the central part of the Gulf States it is in full progress about the middle of March.

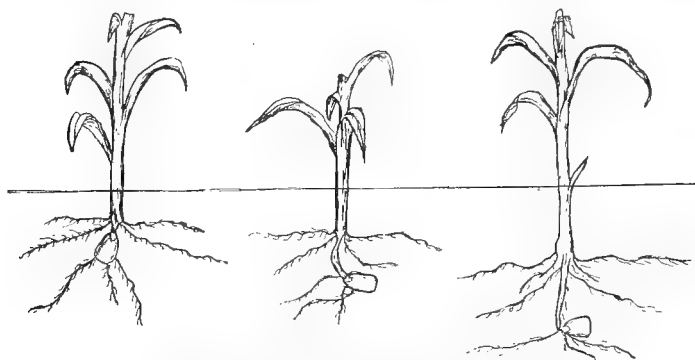

FIG. 83.—DIAGRAM OF YOUNG CORN PLANTS.

Showing that the depth of the crown, where most roots originate, is nearly the same with shallow, medium, and deep planting.

In the northern part of the same states most of the planting is done in April. The corn planting season in all states of the cotton-belt practically extends from about the first of March to nearly the first of July. Bottom lands are frequently not planted until May or later, while in the same locality the preferred date for planting the uplands may be some time in March. Plantings made in June, even on bottom lands, are usually less productive than those made in May or earlier. A part of the corn is sometimes planted late, in order to distribute the labor of cultivation through a longer period.

Only the seasons can determine whether in any given

year it is better to plant uplands very early or at a medium date. The general belief inclines to the advantage of the very early planting of uplands, or as soon as danger of killing frost is past. However, success is sometimes made by planting at almost any date between the last killing frost and the first of June.

Incidental considerations sometimes govern the date of planting. For example, on land that is especially liable to the injury of young corn plants by the small budworm (see Par. 189), it is regarded as advantageous either to plant very early, or still better, to postpone planting until about the first of May. The common idea in postponing planting is that the soil becomes so warm as to discourage the insects. Probably a truer explanation is found in the more rapid growth of the late-planted corn, which sooner grows beyond the stage in which it is attacked by the budworm.

Early planting has a tendency to produce a smaller stalk than late planting, a desirable result. Corn planted early requires a greater number of cultivations.

Late planting, while making a very tall stalk, reduces the injury from weevil by reason of the late date of maturity. Late-planted corn, if harvested before becoming thoroughly dry, requires more ventilation of the cribs than is generally necessary with early-planted corn.

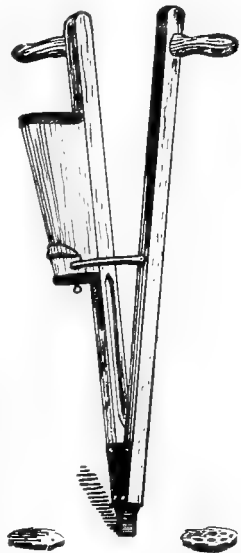

FIG. 84. — HAND CORN PLANTER, FOR RE-PLANTING.

**159. Replanting.** — This is generally done by dropping the seed by hand and covering with a hoe. This involves many unnecessary motions and much waste of time. An

improvement consists in using the rotary or other hand planter (Fig. 84), which, when thrust into the soil, leaves several grains covered at the proper depth.

The yield from hills that have been replanted is often unsatisfactory, probably because of their being crowded by the older plants and partly, perhaps, because of an inadequate supply of pollen for the few plants which produce their silks after most corn has ceased to tassel. Hence if the stand of corn is poor, it often pays better to plow up the remnant and plant again, rather than to replant the vacant spaces.

**160. Harrowing before and after planting.**—In the preparation of land for corn in the South, the harrow is not so generally used as it should be.

The disk-harrow can be advantageously used to slice large clods left by the plow. Another use to which it is seldom put, but which it serves admirably, consists in running it over crusted land to break the surface crust so that when plowed, large clods do not form. A large part of the tillage should be given to corn land before the seed is planted, and this is readily done by employing some form of harrow after plowing.

The best time to use any kind of harrow is within a few hours after plowing, so that there may still be enough moisture in the clods to cause them to pulverize readily. Harrowing not only breaks the clods, but also makes the land retain moisture better.

The spike-tooth harrow (Fig. 85) may often be used advantageously to pull down or flatten ridges or beds which have been thrown up higher than necessary, as is the custom in the prairie region of the South and on bottom



lands. The use of the harrow several weeks after plowing, and either just before planting corn or soon afterwards, kills young weeds and grass and thus reduces the subsequent cost of tillage. The principal change needed in the tillage of corn in the South is the more general use of the weeder or harrow. Its use should be begun about the

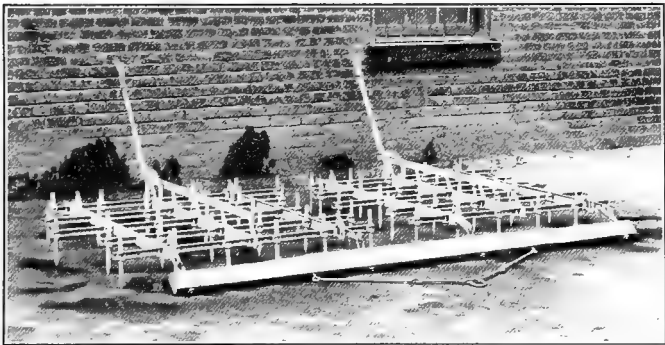

FIG. 85.—A SPIKE-TOOTH HARROW.

time of planting and be continued as long as possible. The harrow may be used until the corn plants are 4 to 6 inches high and the weeder (Fig. 86) until they are 8 to 12 inches high. The broadcast tillage with these implements is the cheapest method of cultivating young corn, since with either a harrow or a weeder 10 to 12 acres of corn can be cultivated in a day. This economical broadcast harrowing permits delay in beginning cultivation with other implements.

It is usually best to run the harrow or weeder diagonally

across the rows, though the direction is not always important.

**161. Usual tilling or cultivating implements.**— The implements most generally used in corn tillage in the South are such as can be drawn by one horse or mule. Among these are the following: heel scrapes, sweeps, cultivators

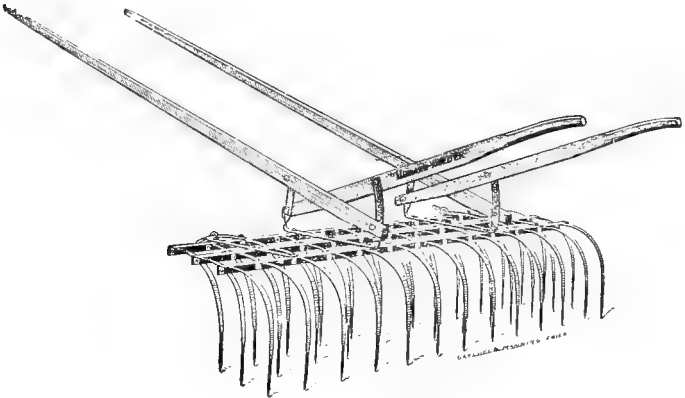

FIG. 86.—A WEEDER.

with many small points, and one-horse spring-tooth cultivators (Fig. 87). Too often the cultivating implement is a scooter, shovel or other implement tilling or cultivating but a narrow strip of ground and running so deep as to cut many of the corn roots.

The general rule should be to till corn shallow, that is, to a depth of  $1\frac{1}{2}$  to  $2\frac{1}{2}$  inches, unless there are special reasons for deeper tillage. Sometimes comparatively deep tillage may be justifiable while the corn is less than one foot high, especially on land that contains much clay and

that has been baked or run together by heavy rains, or that was imperfectly plowed in the beginning.

When "scrapes" or similar implements are used, it is customary for the first working to be made with scrapes of the smaller

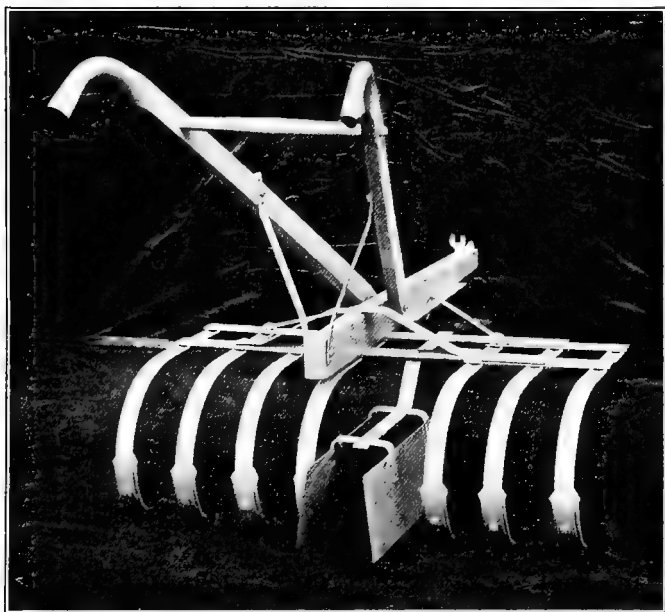

FIG. 87.— A ONE-HORSE, SPRING-TOOTH HARROW, WITH FENDERS.

sizes, usually 10 to 12 inches in width, gradually increasing the size up to 30 inches or wider. The first tilling of corn can be much more rapidly done if the cultivating implement is supplied with fenders (Fig. 87), which are usually strips of metal attached to the plow beam and trailing along the ground between the implement

and the young plant to protect the latter from being covered by the upturned soil.

It is usually cheaper to kill young grass along the line of the drill by smothering it with earth thrown on it than by the use of the hoe; yet this working of the soil towards the plants should not be carried to such an extent as to form high ridges along the line of the row.

As a general rule, tillage implements with small points answer well for the destruction of very young grass and weeds and for forming a surface mulch. But, if crab grass or other tough vegetation attains considerable size, it is usually necessary to destroy it with some form of *cutting* implement, such as a scrape or sweep.

**162. Two-horse cultivators.** — These implements are used to a considerable extent by the most progressive farmers. They are of two general types: first, disk cultivators, and second, cultivators armed with shovels, scrapes, or small points. The former are more apt to leave the land in high ridges and to cut rather deep. When two-horse cultivators constitute the main reliance, it is often advisable to give the last working with some form of one-horse cultivator, after the plants are too large to be straddled by the double cultivator.

**163. Use of the turn-plow.** — In the early years of Southern agriculture, the turn-plow was an ordinary implement of cultivation. As methods of farming have improved, farmers have largely discarded the use of the turn-plow as a cultivating implement. There are exceptional cases when its use is justifiable, for example, (1) where grass is too large to be uprooted by ordinary tillage and where it needs to be thrown away from the plants, and to be killed by smothering with earth; (2) when the land is cold and when budworms are injuring the young plants,

under which conditions the use of the turn-plow to "bar off" the corn rows, that is, to throw the earth away from the row, is justifiable. In such cases, the soil should be returned to its original position as soon as the grass has been killed.

164. **Checking corn.** — Checking consists in planting corn in such a way that it can be worked or plowed in two

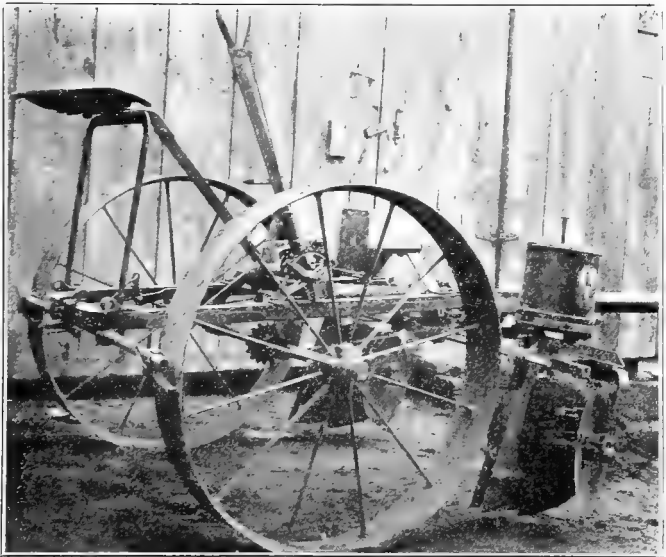

FIG. 88.—CHECK-ROW CORN PLANTER, WITH DOUBLE DISKS TO OPEN A DEEP FURROW.

directions. Most of the corn in the cotton-belt is not checked, because the land is too rolling to be cultivated in more than one direction. However, checking is in common

use on the less rolling lands, especially on the northern edge of the cotton-belt; and its use on level and gently rolling land should become more general throughout the South.

The chief advantage of checking consists in the saving of hand labor or hoeing. In order to practice checking, the land should be nearly level or very gently rolling and well drained, since checking cannot well be practiced where it is necessary to plant on ridges, as is done on poorly drained land. The yield of checked corn is nearly the same as that from drilling, provided the number of plants per acre be the same in each case.

Corn can be checked either by using a check-row planter, (Fig. 88), or by carefully marking off rows at uniform distances and opening the planting furrows at regular intervals and perpendicular to the first marking. The seed corn may be carefully dropped by hand in the furrows where they are intersected by the cross marks. In using a check-row corn planter, two rows are planted at once at uniform distances. This is done either by means of a wire attached to the planter and stretching across the field, or by having a second man to ride on the machine and regulate the distance for dropping the seed.

**165. Number of kernels to plant in a hill.** — It is customary throughout the cotton-belt to plant about three grains in each hill, even though only one plant is to be allowed to live. This thick planting is chiefly due to the fear of the budworms, which kill many young plants when 3 to 10 inches high. It is also partly due to the use of seed that germinates poorly and to insufficient preparation of the land. Attention to these points will often make it

practicable to plant only one or two kernels in a place, thus reducing the labor of thinning.

**166. Thinning corn.** — Since an excessive number of grains is planted, subsequent thinning becomes necessary. This should usually be postponed until after the plants are 10 to 12 inches high, by which time the young plants will have ceased to die from injuries inflicted by budworms.

Thinning is usually done when the ground is too wet for other work, by pulling the young plants, with the assistance of a long paddle to uproot any that may break. Some soils are injured if the thinning be done while the land is very wet. Thinning is also done with a hoe, in which case care must be taken to cut the young plant below the crown, else it will again grow out.

**167. Number of plants per hill.** — Throughout the greater part of the cotton-belt, except in its northern edge and occasionally on rich bottom lands elsewhere, it is customary to leave but a single corn plant in a hill, while in the North and West it is usual for from 2 to 4 plants to grow in one hill.

The Southern practice of leaving only one plant in a hill is due to the following conditions usually found in the South:—

- (1) A thirsty soil;
- (2) Comparatively shallow range of roots;
- (3) The large size of Southern corn plants and their consequent greater need for moisture; and
- (4) The fact that but little corn is planted in checks.

Under ordinary conditions and on land producing not more than 25 bushels of corn per acre it is doubtless best to leave only one stalk in a hill. However, where the land is capable of producing 35 or more bushels per acre and of being planted in checks, it will sometimes be advisable, in checking corn, to leave two plants in a hill.

168. Distances between rows and between plants. — With corn, the general rule as to distance between rows is the following: the poorer the land, the farther apart must be the rows and the individual plants; while the richer the land, the more closely may both rows and plants be crowded together. This rule is exactly the opposite of that for spacing cotton.

Varieties with small or medium-sized stalks may be planted more thickly than those with large stalks. On poor upland, where the yield is expected to be about 25 bushels per acre, it is best to allow not less than 15 square feet for each plant. This is equivalent to rows 5 feet apart and plants 3 feet, or to rows 6 feet apart and plants  $2\frac{1}{2}$  feet apart. On richer uplands, fairly retentive of moisture and where the yield is ordinarily from 25 to 40 bushels per acre, the Georgia Experiment Station found advantageous distances to be  $4\frac{1}{2}$  feet by 32 inches, which gives 3630 plants per acre in a perfect stand. Other distances that give practically the same number of plants per acre are 4 feet between rows and 3 feet between plants, or checks  $3\frac{1}{2}$  feet apart both ways.

Experiments at the Georgia and Alabama Stations indicate a slight advantage from so dividing the space allotted to each plant as to give practically the same distance between plants as between rows, that is, making the plants form a square. However, economy of cultivation requires that this slight increase be sacrificed in order that the rows may be made as wide as practicable. Wide rows and closer planting in the drills save hoeing. For example, one laborer can hoe 5 acres of corn planted in 5-foot rows in about the same time that he can hoe four acres if the rows are 4 feet wide. Horse cultivation is also economized by wider rows. Wide rows also permit the sowing and



cultivation of a row of cowpeas halfway between each pair of corn rows.

While the spacing best for any particular field must be decided by the farmer's judgment, the following distances are widely applicable in the cotton-belt: (1) for poor land, rows 5 feet apart and plants  $2\frac{1}{2}$  to 3 feet; (2) for good upland, rows 4 to 5 and plants 2 feet apart, or checks  $3\frac{1}{2}$  feet apart each way; (3) for good bottom land, rows 4 feet apart and plants at intervals of 1 to 2 feet. With improvement in preparation and in fertilization and in prize patches, corn may be planted considerably closer.

**168a. "Laying by" the corn crop.** — "Laying by" is the name given to the last cultivation or tilling. Most farmers cease tilling corn just before the first tassels appear. Experiments indicate that a later tilling, if quite shallow, is often profitable. On the other hand, if the last cultivation must be deep, or even moderately deep, it should not be late. Deep tillage doubtless explains the prejudice against late tillage.

In giving the final cultivation, care should be taken to leave the surface as nearly level as practicable. In this condition, there is a larger and more equally distributed supply of moisture for the plant roots than would be the case if the earth were heaped in ridges along the line of plants. Among suitable implements for the last cultivation of corn are scrapes and one-horse spring-tooth cultivators (Fig. 87).

**169. Planting other crops with corn.** — In the southern parts of Alabama and Georgia and elsewhere, corn and peanuts are often grown together by the following method:—

Two corn rows are planted early at distances of 3 or  $3\frac{1}{2}$  feet; an interval of 6 or 7 feet is left, and then two more corn rows are planted. In this interval is planted a row of peanuts.

The *Allison method* of growing corn and cotton together consists in the planting of two rows of corn and two rows of cotton, the rows all being narrow, that is, of the usual distance for cotton rows. Corn is planted more thickly in the drills than usual, the rule being, in this method, to grow on each half acre occupied by the corn rows as many hundred stalks as the number of bushels of corn that one acre of this soil would be expected to yield in solid corn, planted as usual. This alternation of the two crops is advantageous to the corn, which receives additional light, and probably more than its share of moisture and plant-food. There are corresponding losses to the cotton crop. Moreover, should the corn be blown down, the late cultivation of cotton would be prevented.

The same criticisms apply, but to a less extent, to the occasional practice of planting two adjacent rows of corn and then either six, eight, or ten rows of cotton, repeating this indefinitely.

"*Crossed corn*" is a method that seems to be localized in the waxy lime lands of Alabama and Mississippi. It consists in the planting in fields of cotton of a row of corn across or perpendicular to the cotton rows, at intervals of 16 to 30 feet, leaving 3 to 4 corn plants in each hill. This usually insures a crop of 4 to 10 bushels of corn per acre, in addition to the cotton crop. However, the presence of the corn greatly reduces the yield of cotton. In a test at the Georgia Station, "crossed corn" in a cotton field resulted in a financial loss, as compared with cotton grown alone.

Another objection to "crossed corn" is its interference with late cultivation of the cotton, should the corn be blown down. The principal justification of this practice lies in the fact that many careless renters fail to cultivate their corn properly when planted alone, but are more careful of the cultivation of cotton, and hence of the corn grown in the cotton field.

**170. Sowing cowpeas in corn fields.** — It is customary among the best farmers throughout the cotton-belt to sow cowpeas during the cultivation of corn. The objects aimed at are: —

(1) Soil improvement, or an increase in the next year's crop on the same land;

(2) The production of cowpeas for seed or for pasturage; and

(3) The making of cowpea hay, which is rarely the main object and which usually requires that the corn rows be about 6 feet apart.

There is need of investigation to determine whether there are any disadvantages resulting from the planting of cowpeas between the corn rows. In at least one experiment in a very dry year, the yield of corn was materially reduced by the presence of broadcast cowpeas. This indicates the possibility of cowpeas making undue demands for moisture in a year of scant rainfall. With ample rainfall cowpeas in the corn apparently do not reduce the yield of the latter. As a rule cowpeas should be sown in the corn field, using one of the customary methods.

**171. Broadcast planting versus drilling of cowpeas in corn.** — Both broadcasting and drilling are extensively used, but drilling is much more prevalent. The advantages of drilling are the following: —

(1) It permits earlier sowing of the cowpeas;

(2) It permits later cultivation of the corn;

(3) It economizes seed, 1 to 2 pecks sufficing for an acre, or less than half the seed necessary for broadcast sowing; and

(4) The cowpeas are more certain to produce a crop of seed.



FIG. 89.—COWPEAS GROWING BETWEEN ROWS OF CORN.

The disadvantages of drilling are noted below:—

(1) The smaller amount of hay or pasturage produced and the smaller amount of vegetable matter and nitrogen left on the soil for the next year's crop;

(2) Drilling cowpeas between corn rows may interfere with the use of certain cultivating implements.

The advantages of broadcast sowing (Fig. 89) are the larger amount of hay or pasturage and the greater amount of fertility left on the soil. Broadcast sowing has the following disadvantages:—

(1) Corn must be "laid by" early, sometimes too early;

(2) The cowpeas must be sown rather late;

(3) A much larger amount of seed is required, about 1 bushel of cowpeas per acre being customary;

(4) The stand of cowpeas may be poor, due to the enforced shallow covering and to the lateness of planting.

A good general rule is to give preference to broadcast sowing when cowpea seed are cheap and abundant, and to practice drilling this legume when a large yield of seed is desired.

**172. Method of sowing broadcast cowpeas in corn.**—In broadcast sowing, the work is usually done by hand, or with a broadcast seed-sower slung over the shoulder. Covering is effected by giving the usual last cultivation to the corn, which sometimes covers the cowpeas to an insufficient depth. It is not customary to fertilize the cowpeas grown in corn fields, whether sown broadcast or in drills. This is probably because there is no easy method of applying fertilizer in this case, unless it be found practicable to use between the corn rows a one-horse grain drill with fertilizer attachment. However, fertilizers are usually helpful

and they can be sown broadcast by hand, though the distribution is irregular and inconvenient.

**173. Methods of planting cowpeas in drills between corn.** — The methods employed in drilling cowpeas are numerous. Among them are the following: —

(1) Dropping a hill of cowpeas between each pair of corn hills, covering the seed either with a hoe or with the earth thrown toward the corn in cultivation. The use of a hand planter should supplant this method.

(2) Drilling cowpeas by hand in one of the siding furrows near the corn row, covering the seed with soil thrown by the next outer cultivating furrow. The chief inconvenience of this method is the inability in later tillings to run the cultivator close to that side of the corn row.

(3) Drilling by hand or planter a row of cowpeas in the water-furrow exactly halfway between the two adjacent rows of corn.

Of all drilling methods, the last mentioned is apparently the most common and practicable. It is usually done at the next to the last or even at the third from the last cultivation. The subsequent tillage of corn serves also to cultivate the cowpeas.

(4) A combination may be made of plan 3 with either 1 or 2, or with both, thus giving several rows of the legume between the two adjacent corn rows.

By using a combined planter and fertilizer distributor for sowing cowpeas, the crop can be fertilized at the same time. It will probably be profitable in most cases thus to fertilize cowpeas in the corn fields wherever they would profit by fertilization if sown alone; 100 to 200 pounds of acid phosphate per acre will usually be sufficient.

In the third method mentioned above, the rows should be at least  $4\frac{2}{3}$  feet apart. The first and second methods permit narrower corn rows.

**174. The Williamson method of corn culture.** — Recently a system of corn culture bearing the name of its originator, McIver Williamson, of South Carolina, has come into prominence on account of some of the large yields that have been produced by it or by modifications of it. The distinctive feature of this method consists in the stunting or dwarfing of the young corn plant (1) by withholding a part of the usual cultivation in the early period of the plant's life, (2) by postponing the application of any fertilizer until the plants are thoroughly stunted, and (3) by the root pruning of the young plants by means of deep cultivation.

While the intentional stunting belongs exclusively to this method, the Williamson system of corn culture includes many good features that form a part of the practice of the best farmers employing various methods. Among the strong points of this method, and of other methods as well, are the following: —

(1) Deep and thorough preparation;

(2) Frequent use in the rotation of cowpeas sown broadcast in the corn field, the effect of which is to enrich the land;

(3) The use of large amounts of fertilizers;

(4) Thick planting along the line of the row, which is rendered especially practicable in the case of the Williamson method by the small size of the plants, the abundance of the fertilizer, and the thoroughness of preparation.

The following condensed directions are quoted from an article by the originator of this method: —

“Lay off the land in rows six feet apart, and bed on these furrows with turn-plow until only a five-inch balk is left between these beds. When ready to plant, break out this balk with six-inch shovel or scooter, and follow deep in furrow with narrow plow. Ridge on this furrow with one round of same narrow plow. Plant in this ridge twice as thick as corn is to be left, one grain in a hill, and cover shallow. Plant as early as your seasons and the nature of the land will permit.

“When your corn first needs work, run on both sides with harrow or small plow (Fig. 90); when it is about eight inches high, give

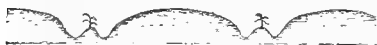

FIG. 90.—THE WILLIAMSON METHOD OF CORN CULTURE.

Showing condition of the ground after the first cultivation. (After sketch by McIver Williamson.)

second working by running around it on both sides, if on sandy land, with ten-inch scrape, or sweep, set on point, and if on stiff land use shovel. Thin now.

“Leave these furrows open and do not work corn again until it is so stunted as to prevent its ever growing larger than is necessary to make what corn the land is able to produce. On poor or cold land from ten to twelve days may be enough, while rich soil may take twice as long. When you think that it has stood long enough apply one half of mixed fertilizer in the open furrows next to corn, of every other middle, and cover by breaking out this middle with turn-plow. And side the corn at once in this middle with fifteen-inch scrape, pushing dirt around it, and covering any grass that turn-plow has left. Corn should now be about knee high.

“Within a week give other middle same treatment, then go back to first middle as soon as possible, and sow half of nitrate of soda in scrape furrows next corn, and cover as fast as sown with one round of turn-plow, shallow. Then sow peas broadcast in this middle at rate of a bushel per acre, unless very scarce, when they may be dropped, and cover by breaking out middle shallow.

“A few days later treat the other middle same way, which lays by corn on slight bed with dirt around the feed roots, before



bunching for tassel. Lay by early . . . (Fig. 91). No hoeing should be necessary.

"On sandy soils I would use for a 25-40 bushel yield, 100 pounds acid phosphate, 100 pounds cotton-seed meal and 200 pounds kainit per acre, mixed, and 75 pounds nitrate of soda at last plowing, leaving corn 16-20 inches in drill, rows 6 feet apart.



FIG. 91. -CONDITION OF SURFACE AFTER "LAYING BY" CORN ACCORDING TO THE WILLIAMSON PLAN.

(Redrawn after Mr. Williamson's diagram.)

For 40-60 bushel yield, I would double the amount of mixed fertilizer, and also use 125 pounds of nitrate of soda, leaving corn 14-16 inches in drill, rows 6 feet apart. Clay land is said to require more phosphoric acid and less potash."

In the majority of experiments published prior to 1910, and made at the South Carolina, Alabama, and Georgia Experiment Stations, the yield of corn was less under the Williamson method than with the best of the methods with which it was compared and in which equal amounts of similar fertilizers were employed. However, when various modifications of the Williamson method have been applied by farmers, frequently without notably stunting the corn, large yields have often resulted, — as has likewise been the case when farmers have employed any other system

of corn culture involving the use of higher fertilization than usual.

Apparently the best lessons impressed by the Williamson method are (1) the special value of nitrate of soda as a fertilizer for corn and (2) the possibility, under favorable conditions, of planting corn much thicker than is the custom in the cotton-belt.

It also possesses whatever advantages belong to the common system of planting corn in the water-furrow on well-drained sandy land. As before pointed out, the tendency is for most varieties of Southern corn to grow a larger stalk than is necessary for the production of the maximum amount of grain. A slight diminution in size is doubtless desirable, so as to reduce the demand on the soil for water and to increase the number of plants that may be grown advantageously on an acre; but whether this decrease in size of stalk should be brought about gradually by selection or suddenly effected by moderate checking of growth is yet to be determined by accurate investigation.

### LABORATORY EXERCISES

(1) If corn plants are available for this purpose, study the effects of root pruning on four sets of plants, by running a knife or hatchet or axe three inches on each side of the row and to depths of 2, 3, 4, and 5 inches respectively. This may be repeated with plants of different heights between 6 inches and 6 feet.

(2) Most of the practice to accompany this chapter should consist of observations and note-taking on such experiments as may be at hand, or on methods in local use by farmers.

### LITERATURE

- MYRICK, H. *The Book of Corn*. New York.  
HUNT. *The Cereals in America*, pp. 218-242. New York, 1904.  
DUGGAR, J. F. *Ala. Expr. Sta., Buls. Nos. 111 and 134*.  
WILLIAMS, C. B., and others. *N. C. Expr. Sta., Bul. No. 204*  
REDDING, R. J. *Ga. Expr. Sta., Buls. Nos. 55, 58, and 62*.

## CHAPTER X

### CORN — HARVESTING

IN the Southern States the usual methods of harvesting corn and corn forage are the following : —

(1) Pulling or jerking the ears, afterwards stripping the blades ;

(2) Pulling the ears, leaving the blades to be grazed by live-stock ;

(3) Pulling the ears, and cutting the tops for forage ;

(4) Cutting and shocking the stalks with ears and leaves.

**175. Pulling the ears.** — The first three methods of harvesting require the pulling of the ears from the standing plant, after they are thoroughly mature. It is customary in the cotton-belt to pull the ears with the greater part of the shuck attached. Here corn is usually placed in the crib without being shucked or husked. However, in some communities, the unshucked corn is thrown under a shelter adjoining the crib, and when other work permits, it is husked and thrown into the crib.

**176. Handling the ears.** — In the South, the most usual method is for each laborer to pull two rows of corn as he advances across the field, and to throw the ears into flattish heaps or piles on every sixth or eighth row ; the ears are picked up later and thrown into a wagon driven between two heap rows. This is a laborious method.

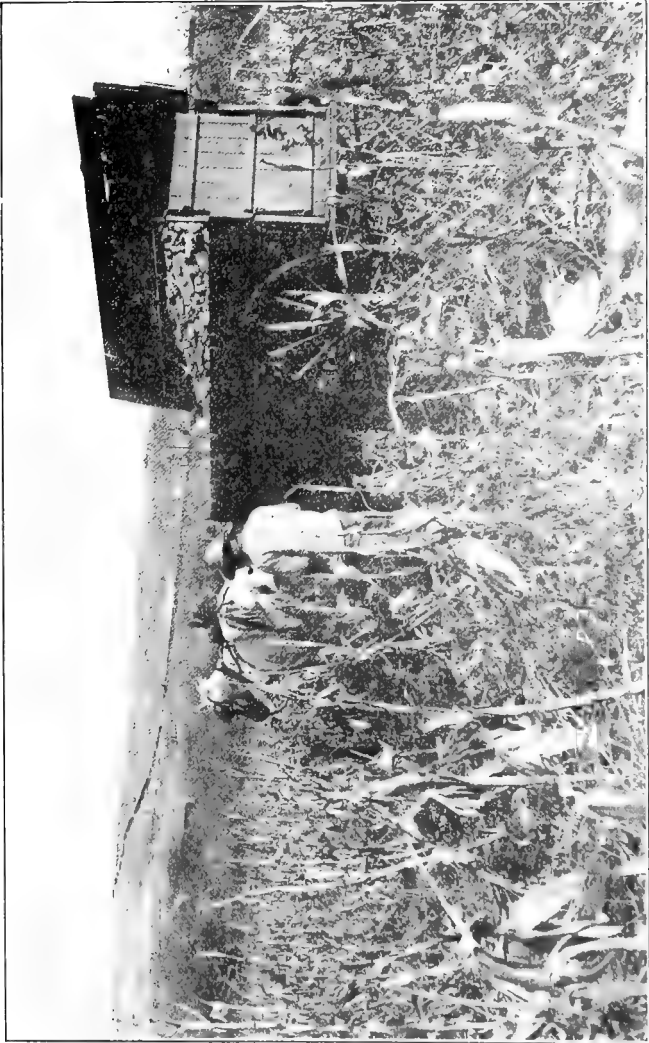

FIG. 92. — SHOWING 'THROW-BOARD' ON WAGON-BODY USED IN HARVESTING CORN.

An improvement consists in throwing the corn directly into the wagon as it is pulled. This is more readily done if a "throw-board," or side-board, 2 to 3 feet high, is placed on top of the side of the wagon-body farthest from the men. This necessitates loading the wagon from but one side and keeps the ears from being thrown beyond the wagon (Fig. 92).

The wagon should also have a hind-gate that is readily removable so as to permit the use of a grain shovel in unloading the ears.

When it is advisable to husk the corn as it is pulled from the stalk, a husking-pin, buckled to the hand, is helpful. The shucking of the corn before storing it is probably useful in reducing the number of weevil introduced into the crib.

**177. Stripping the blades.** — In order that the forage or "fodder," for which the blades are sometimes used, may be of good quality, the blades are usually stripped while most of the leaves are still green. The effect is to reduce the yield of grain. The loss, as shown in many tests, averaged nearly three bushels per acre. This reduction in yield of corn is due to the fact that some of the material in the green leaf, if it had been left on the plant, would have been carried in the circulation of the plant to the ear, which is not mature at the time of "fodder pulling."

Another objection to the common custom of pulling fodder is the cost of the labor. The usual yield of cured leaves ranges between 300 and 600 pounds per acre, or about one fourth as many pounds of dry leaves as of shelled grain. Fodder pulling is slow and extremely disagreeable work.

Usually it pays much better to employ the same labor in curing hay, in which operation a day's work will provide several times as much forage as one day spent in fodder pulling.<sup>1</sup>

**178. Topping corn.** — Occasionally corn stalks are cut just above the ears. The yield of tops is but little more than the yield of blades or "fodder" would be, and the quality of tops is poorer, while the labor is about the same. Topping does not greatly reduce the yield of grain, if postponed until quite late. On the whole, it is a very unprofitable operation.

**179. Cutting and shocking corn.** — When performed at the proper time, this does not materially reduce the yield of grain. The time to cut corn is when practically all outer shucks have turned straw-color, at which time the grains have hardened. This is usually about ten days later than the stage at which "fodder" is ordinarily pulled. The advantages of this method of harvesting corn are the following: (1) all the forage is saved; (2) the use of the land for the next crop, except a small space occupied by the shock, can be had at an earlier date; (3) it frees the land from corn stalks and hence puts it in better condition for seeding to small grain; and (4) it permits the harvesting of the corn crop by machinery.

**180. The extent of the saving by cutting and shocking corn.** — It is often stated that the stover (that is, the leaves, shucks, and stalks) are nearly equal in feeding value to the ears produced on the same area. This is not true for ordinary Southern corn, so large a proportion of

<sup>1</sup> For a financial statement relative to fodder pulling, see Georgia Experiment Station Bul. No. 74, page 278.

which consists of a coarse stalk having but little nutritive value. It would probably be a high estimate to say that 30 per cent of the total feeding value of the entire plant of large Southern corn is found in the stover. Yet corn stover is a source of forage well worth saving, especially where hay is scarce or expensive.

There is usually about one ton of stover for every 25 or 30 bushels of grain produced by large Southern varieties. If this stover is shredded, it may have a higher feeding value than an equal weight of cotton-seed hulls. In composition, corn stover is superior to cotton-seed hulls, but the former is less convenient for feeding in connection with cotton-seed meal.

In one experiment in South Carolina, the cost of cutting and shocking corn was no greater than the cost of pulling the ears from an equal area of standing plants. However, the usual experience is that the former operation generally requires somewhat more labor than merely pulling the ears.

Whether it is advisable to cut and shock corn or merely to pull the ears, leaving the blades to be grazed by cattle, depends upon (1) the abundance and cheapness of hay, and (2) the cost of shredding, including labor, cost of power, interest and depreciation on shredder, etc.

Cutting corn and subsequently shredding it will generally be profitable where the cost of shredding is less than \$2.50 per ton of stover in regions of cheap hay; or where it is less than \$4.00 per ton in regions of scarce and high-priced hay. To this rule there will obviously be many exceptions.

When no shredder is available, it is doubtful whether there is any advantage in cutting and shocking corn as compared with merely pulling the ears and grazing the field. The basis for this statement is the fact that it requires more labor to pull the ears by hand from the shocked corn than from the standing plants, and the further fact that quite a large proportion of the stover of large Southern corn, if fed without shredding, is not eaten by live-stock.

**181. Methods of cutting corn.**—Corn may be cut (1) by hand implements, as with a hoe or corn knife, (2) by a sled cutter, or (3) by a corn binder or harvester. The choice between these is chiefly determined by the cost of each method and by the acreage to be cut. Even when the cost of cutting by hand and by machinery is identical, the harvester has the advantage of making the owner less dependent upon hired labor, and of enabling him to do the work promptly and with less exertion.

**182. Cutting corn by hand.**—The usual implement for cutting corn is a heavy corn or cane knife. Sometimes

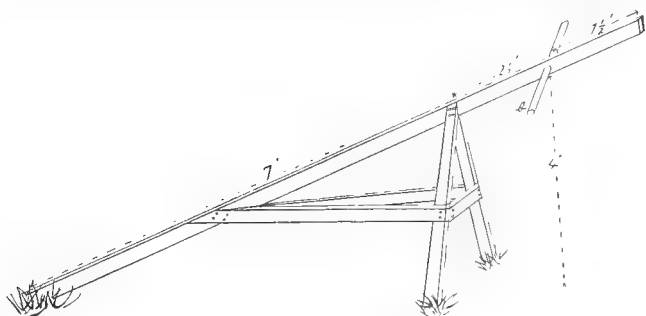

FIG. 93.—SHOCKING HORSE.

*b* is a broom handle or gas pipe; the stalks of corn are leaned in the four angles where it passes through the long board; after the shock is tied the broom handle is pulled out and the "shocking horse" withdrawn.

a sharp hoe is used. To form the shocks, one may either use a shocking horse (Fig. 93), or he may form a support for the shock by tying together the tops of plants on four hills, which plants are not cut. The row on which shocks are to be located is usually every tenth or twelfth row.



As each armful of plants is cut, it is carefully placed on the shock in a nearly upright position. Some farmers prefer to cut first the rows adjoining the shock row, so that after placing the plants from these rows on the shock, a few minutes are allowed for these to dry slightly before the layers of plants from rows farther out are added to the shock.

In the South shocks should not be very large, but should usually contain between 150 and 200 plants. One that is too large is liable to fall and to result in the molding of some of the immature ears in the center of the mass. A very small shock, on the other hand, exposes too large a proportion of its forage to injury from sun and rain.

The shock (Fig. 94), when completed, should be tied tightly with binder twine, about two feet from the top. The shock can be drawn together by a short rope, in one end of which is a hook. The other end of the rope is passed through this hook and by means of a slip-knot the shock is tightened while the string is being tied. About ten days later, after the plants have settled together, the tie should again be tightened in the same way. In making shocks, great care must be taken so to construct them that they will not later fall. This is best done by care in placing the plants against the shock, an equal number on all sides, and in a nearly upright position, and by keeping the top of the shock from twisting, when pulled together by a rope.

The corn should stand in the shocks or in a rick at least one month before it will be dry enough to be shredded.



FIG. 94. — CORN WELL SHOCKED. (Oklahoma Experiment Station.)

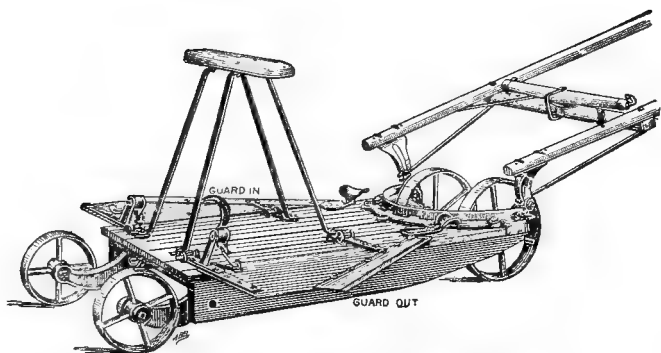

FIG. 95.—SLED CORN CUTTER, WITH AUTOMATIC KNIFE GUARDS.

183. **The sled cutter** (Fig. 95).—This implement consists essentially of a sled on wheels; on one edge of this sled or low platform is attached a long, sharp knife, sloping backward at an oblique angle to the row of corn. The sled is driven near enough to the row for the slanting knife to cut the corn with a sliding cut.

A man, standing on the platform, catches the cut corn in his arms; when he has an armful, he stops the team and places the corn on the nearest shock. The cost of

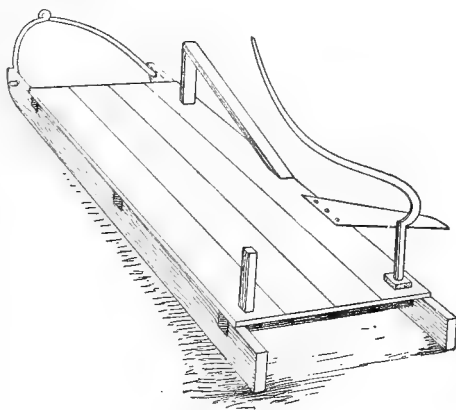

FIG. 96.—A HOME-MADE SLED CORN CUTTER.

this cutter made at home from a long scythe blade may be as low as \$10.00 (Fig. 96), while the cutters on wheels, with every facility for better work, cost about twice as much.

The sled cutter is drawn by one animal or by two, hitched tandem. If it be equipped with a blade on each side, so as to cut two rows at once, two men catch and shock the cut corn. For the convenient use of such two-row cutters, corn rows should be of a uniform width, suited to the width of the cutter. This is one of the cheapest methods of cutting corn.

**184. The corn binder or harvester** (Fig. 97). — This machine cuts the corn and binds it into large bundles. It is usually drawn by three horses or mules. The ordinary cost is about \$125. This limits its use to those farmers or groups of coöperating farmers who can use it each year to cut a considerable acreage, say 30 acres or more. It cuts a single row at a time and may cut 6 or 8 acres in a day. If a charge is made for the team, the cost of cutting and shocking and of twine is often about equal to the cost of cutting by hand and shocking. But the machine permits prompt work and economizes human labor. Where the height of the corn is excessive or the rows short, hand cutting is preferable.

The bundles from the machine must usually be stacked by hand. Some binders have a bundle-carrying attachment, which reduces the labor of shocking. In any case, it is easier and more satisfactory to shock bundles than to shock unbound corn cut by hand. The corn binder usually breaks off a sufficient number of ears to require that these be picked up by hand.

A *shocker* is a machine more complicated and costly than the corn binder. It carries on a platform all of the unbound corn plants, until it gathers enough for a shock, when the team is stopped and the driver, by means of a hoisting device or frame, transfers the corn from the machine to the ground, where it forms



FIG. 97.—A CORN HARVESTER.

a complete shock. This stopping of the machine greatly reduces the area of corn harvested. For this reason, and because of the greater cost and complexity of the machinery, the shocker cannot yet be generally recommended to Southern farmers. The latter criticism applies also to the recently invented machine for pulling the ears of corn from the standing plants.

**185. Shredding corn.** — A *shredder* is a machine that tears the stover into small fragments and which, at the



FIG. 98. — CORN HUSKER AND SHREDDER AT WORK.

same time, removes the ear and takes from it nearly all of the shuck (Fig. 98). To drive a shredder requires considerable power.

The following are among the advantages of shredding stover as compared with feeding it whole:—

(1) The removal of the ears from the stalks and the partial shucking of the ears;

(2) The larger proportion of shredded stover that is eaten;

(3) The greater economy in handling shredded stover, which can either be baled at once or blown by the shredder into the barn;

(4) The finer condition and greater value of the manure that is free from long corn stalks, and the cleaner condition of the field from which corn stalks have been removed.

Against these advantages must be placed the cost of shredding, including cost of power, labor, and interest, depreciation, and repairs on the shredder. These several charges have sometimes been found to range between \$1.50 and \$3 per ton of stover.

**186. Corn cribs.** — In cribs, or buildings intended for the storage of corn, three aims should be kept in mind: (1) ventilation, (2) prevention of injury by rats and mice, and (3) minimizing the injury from attacks of weevil and other grain insects. In most Southern cribs, the only care is usually to provide ventilation. This is done by making the sides of slats, or narrow planks nailed on the inside of the framing, in a horizontal position. Such a slatted construction is probably best for the storage of large amounts of unhusked corn, where there is the chance that some of it may be wet or immature when harvested. Even the slatted cribs can be made rat-proof by lining them throughout, on sleepers, studding, and joists, with strong wire netting, usually with meshes about one fourth inch in size. The additional expense is considerable, but in the end this expenditure is profitable.

Sometimes a small, detached crib is rendered rat-proof and mouse-proof by placing it on tall pillars, the upper

portion of each pillar being wrapped with new tin, or else each pillar being topped with an inverted tin pan, having no rim. An objection to this form of construction is the greater height to which the corn must be thrown in unloading the wagons.

**187. Prevention of injury by weevils in cribs.** — Weevils cause a greater loss than do either defective ventilation or rats and mice. The remedy for weevils is the vapor of carbon disulfide (Par. 194), which can only be applied in a tight crib. Yet the double provision for ventilation and for prevention of weevil injury cannot well be provided in a single crib of any of the ordinary kinds.

Probably the need for an extreme amount of ventilation has been overestimated. For many years the Alabama Experiment Station has stored annually several hundred bushels of unshucked corn in a tight crib made of 12-inch boards, with as small cracks between them as possible. In this crib it is practicable to destroy most of the weevil in unshucked corn by the use of carbon disulfide. In using such a tight crib, it would be necessary to store elsewhere, in some slatted crib, that part of the crop that is not thoroughly mature, or that is put into the crib when very wet.

It would probably also be advantageous, when practicable, to shuck the corn before storing it in such a tight crib, for the following reasons: (1) The crib would hold about twice as many bushels of shucked as of unshucked corn; (2) The weevils could be killed with a smaller amount of carbon disulfide.

In the case of a farmer putting part of his corn in a slatted crib and part in a tight crib, that from the slatted crib should be used first, since the corn in the tight crib could be kept sound through the next summer by the occasional use of carbon disulfide, while



the corn in the slatted crib would be severely attacked by weevils on the approach of warm weather, or earlier.

Single loads of corn, whether shucked or unshucked, that can be left in the wagon for three hours or longer, for example over



FIG. 99.—A FIELD OF CORN IN ALABAMA THAT YIELDED  $103\frac{3}{4}$  BUSHELS PER ACRE.

night, may be rendered weevil-free by the following plan, which is recommended by Dr. W. E. Hinds: Make the wagon-body

tight, preferably reënforcing it by folding a large grain sheet of osnaburgs over the bottom, sides, and top. Place about three pounds of carbon disulfide in shallow cans near the top of a large load of unshucked corn, or a smaller amount in each load of shucked corn. Such loads of fumigated corn should be placed in separate and detached cribs to be kept as the last corn used the next spring or summer.

Keep lighted pipes and all lights away from carbon disulfide, since the fumes are highly combustible.

**188. Yields of maize.** — The average corn crop of most Southern States is below 20 bushels per acre. Yet individual farms in the South sometimes average more than 50 bushels per acre. There are a number of authentic records of yields of more than 100 bushels of corn per acre made by Southern farmers on upland soil (Fig. 99).

Two of the largest yields on record were made in the South. These were 254 bushels and 49 pounds of shelled corn (or "239 bushels of crib-cured corn") per acre, made by Z. J. Drake in South Carolina (Kan. Board Agr., Dec., 1905, p. 208), and 226 $\frac{2}{3}$  bushels per acre obtained by J. F. Batts in North Carolina in 1909.

In the first case the manure, cotton-seed, and other fertilizers cost about as much as the value of the corn at the prices then prevailing. In the latter case also, very large amounts of manure and fertilizer were employed.

#### LABORATORY EXERCISES

When practicable, students should spend several laboratory periods in the field comparing different methods of harvesting, for example: —

(1) Determine the proportion of the weight of the shucked ear to the aggregate weight of shuck, leaves, and stalk, all thoroughly air-dried.

(2) Practice cutting and shocking corn; or if the crop is already in shocks, open and remake several of them.

(3) Examine a number of mature ears to ascertain whether the completeness of the covering by the shuck has any relation to the amount of injury by weevils.

## LITERATURE

DUGGAR, J. F. Ala. Expr. Sta., Bul. No. 134.

REDDING, R. J. Ga. Expr. Sta., Bul. No. 74.

HAYS, W. M., PARKER, E. C., and others. Minn. Expr. Sta.,  
Buls. Nos. 97 and 117.

MOOREHOUSE, L. A. Okla. Expr. Sta., Bul. No. 87.

HARTLEY, C. P. U. S. Dept. Agr., Farmer's Bul. No. 313.

ZINTHEO, C. J. U. S. Dept. Agr., Farmer's Bul. No. 203.

BOWMAN, M. L., and CROSSLEY, B. W. Corn, pp. 202-211; 370-  
381. Ames, Ia., 1908.

SCHULTE, J. I., and others. Rpt. Office Expr. Stas., 1904, pp.  
523-533; and Kan. Board Agr., Dec., 1905, pp. 105-113  
and 218-238.

## CHAPTER XI

### CORN — ENEMIES

MAIZE suffers from a number of insects and fungous diseases, although farmers usually do not find it necessary to treat the crop in the field. The most important corn enemies in the South are described in this chapter.

#### INSECTS

**189. Budworms.** — This is the larval or grub stage of a small beetle, the twelve-spotted lady-bug (*Diabrotica 12-punctata*). The beetle

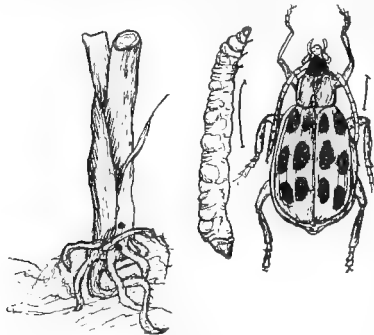

FIG. 100.—THE BUDWORM OF CORN (*Diabrotica 12-punctata*).

On right, adult beetle; in center, grub which bores into young plants; and on left, base of a young corn plant showing holes made by budworms. (Beetle and grub magnified.)

or mature insect feeds on almost any form of green vegetation and may specially be noticed early in the season on alfalfa, clover, and early vegetables. It is only about one fourth of an inch in length; its color is a greenish yellow, and on its wing-cases, or back, are twelve black spots (Fig. 100). The egg is laid on or near the young corn plant soon after germination, at a point

just under the surface of the ground. The egg develops into a small white grub, with a darker head, which bores into the central part of the young stem. As a result, the bud, or group of central leaves of the plant, wilts and usually dies. The injury is practically confined to the young plants between the heights of 2 and 12 inches.

No direct remedies have thus far been found for the budworm. The injury is worse in low wet land and in fields where weeds, corn, or certain other crops have grown. Rotation may be of some value, but the main reliance is in very late planting. Corn planted very early is also less apt to be seriously injured than when planting is done in mid-season. There seems to be an advantage in causing the plant to pass as rapidly as possible through the earlier stages of growth, during which it is subject to this injury. To this end, small amounts of nitrate of soda, applied at time of planting near each hill, are believed to be helpful. Fields where injury from budworm are expected are usually planted quite thickly. When many of the young plants are being injured by budworms it is sometimes considered advantageous to "bar off" the corn rows and thus warm the soil.

**190. Cutworms.** — There are many species of cutworms, all of which cut the young corn plant. They are worse where clover, weeds, or other rank vegetation has grown the preceding year. It is sometimes recommended that cutworms be poisoned just before the time of planting corn by scattering over the field the following preparation: 1 pound Paris green, 1 bushel wheat bran, thoroughly mixed and moistened with sufficient water to which has been added one quart of molasses.

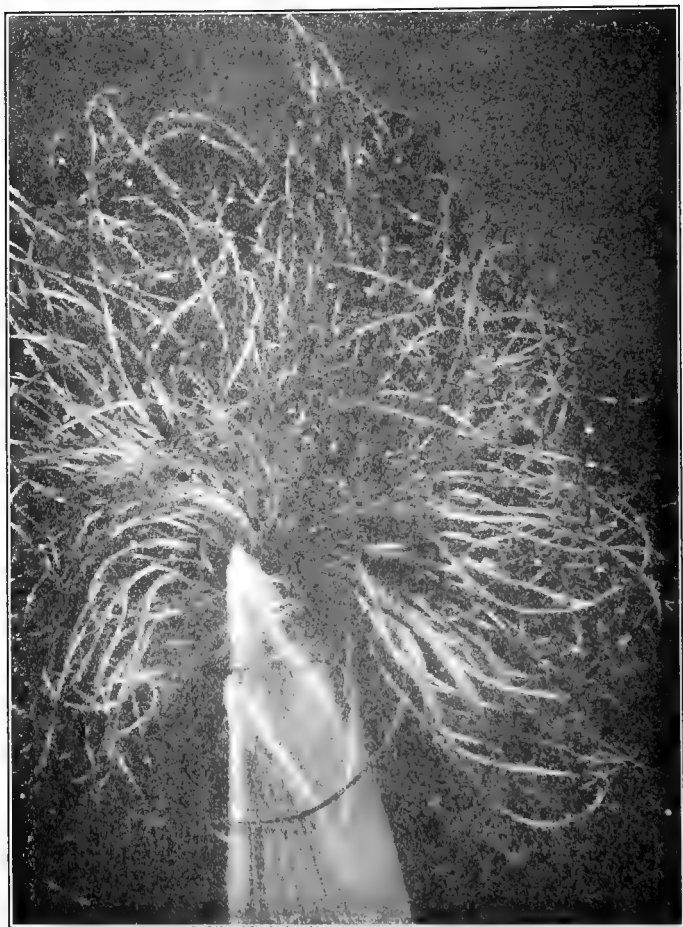

FIG. 101.—EGGS OF CORN EAR-WORM ON CORN SILKS.

**191. Grasshoppers.** — The usual means of combating these consist in driving special catching devices, called "hopper-dozers," through surrounding areas of meadow or weeds, where the grasshoppers congregate.

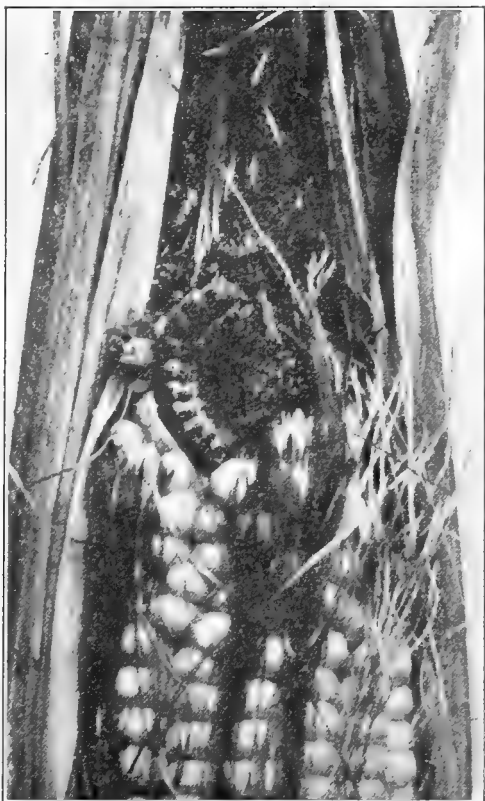

FIG. 102. — THE CORN EAR-WORM AT WORK IN THE TIP OF AN EAR  
P OF GREEN CORN.

192. Corn ear-worm, or cotton boll worm (*Heliothis obsoleta*).— This is the same insect as the cotton boll worm

(see Par. 359). The eggs are laid by a large grayish brown moth, which, especially towards evening, may be found hovering over fields of corn, cotton, and cowpeas. The eggs are placed on the silks (Fig. 101), leaves, or other parts of the corn plant. After these hatch, the young worms, or larvæ, find their way into the tip of the ear and destroy the tip grains. Their injury consists, not only in the grains destroyed (Fig. 102), but in admitting rain to the ear and possibly in giving easier access to weevils. The remedy usually recommended is plowing the land in the late fall or winter. The object in this is to break up the burrows underground in which this insect, in the chrysalis, or pupal condition, spends



FIG. 103. — THE CORN EAR-WORM PREYING ON THE TENDER LEAVES OF CORN.



the winter (see Par. 360). This insect sometimes seriously injures the "bud" or upper leaves of corn plants several feet high (Fig. 103).

**193. Chinch bugs** (*Blissus leucopterus*). Fortunately this pest, which is serious in the corn belt and sometimes in the Southwest, seldom occurs in the southeastern part of the United States. When present, chinch bugs crawl in hordes from the wheat fields toward the growing corn. The corn field may be protected by surrounding it by a narrow strip of plowed land, kept constantly cultivated, so as to form a deep layer of dust; or by surrounding the corn field with a deep furrow, the bottom of which is kept dusty by frequently dragging through it a heavy log. At intervals in the bottom of this furrow deeper holes may be made. When the small insects accumulate in these holes, they are killed by the use of kerosene.

**194. Weevils** (*Callandra oryza* (Fig. 104), and grain moths. — The rice weevil attacks the matured corn grain in the fields and continues its depredations in the crib, during almost every month in the year. Some eggs are laid while the ears

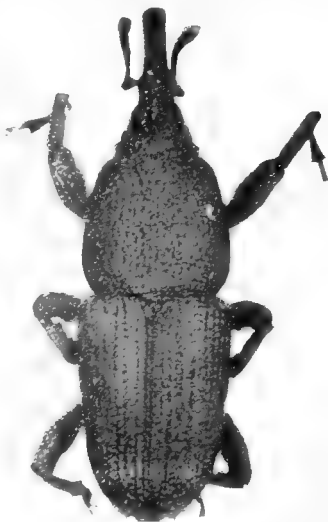

FIG. 104. — THE RICE WEEVIL, MOST DESTRUCTIVE IN STORED CORN. Greatly enlarged. (Photo by W. E. Hinds.)

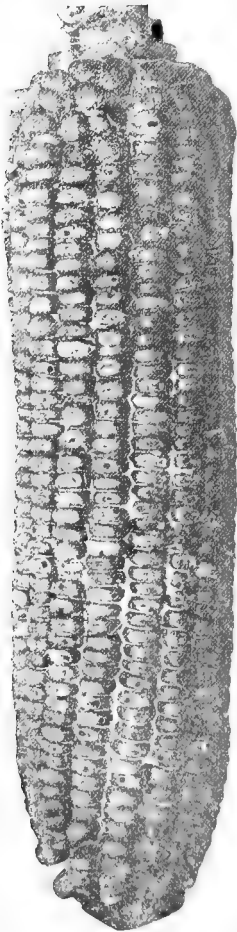

FIG. 105. — AN EAR OF CORN  
INJURED BY WEEVILS.  
(W. E. Hinds.)

are still in the field; and later generations develop in the crib. Early varieties and those with soft grains are most susceptible to injury (Fig. 105). Late planting of medium or late varieties escapes injury, or reduces the number of weevils finding access to the ears in the field. Doubtless much can be done to lessen the weevil injury by selecting corn with a view to weevil resistance. The qualities tending to decrease the number of weevil, but not entirely to avoid them, are (1) a shuck that fits tightly over the end of the ear and (2) a grain that is quite hard. Any means that decrease the number of corn ear-worms would indirectly reduce the injury from weevils, which often enter the ear through the openings made by the former.

However, the chief reliance must be on fumigating the stored grain with the vapors made by carbon disulfide. This liquid readily evaporates, or changes from a liquid to a gaseous form. This implies the necessity for tight cribs, or for other means of treating the grain in tight compart-

ments. A larger amount of carbon disulfide is needed for the treatment of unshucked corn than in treating an equal volume of shucked or shelled corn. The amount of liquid to use for each thousand cubic feet of space in a bin of shelled corn is from 10 to 20 pounds if the crib is very tight and the weather warm. Since these fumes are heavier than air, the liquid may be placed in shallow vessels near the top of the pile of grain; or it may be poured directly on the top of the pile of corn. It is best to cover the pile while under treatment with grain sheets or other heavy cloth, leaving it thus tightly covered for twenty-four hours.

The vapors of carbon disulfide are very inflammable, so that it is dangerous for a lighted pipe, cigarette, or lantern to be brought into the barn or crib while the odor of carbon disulfide is present. This liquid should be handled as carefully as gasoline. The fumes should not be inhaled for many minutes, but a few breaths of this gas do not injure men or domestic animals.

The larvæ of several tiny grain-moths, among them the Indian meal moth (Fig. 107), injure stored corn. The remedy for all of these consists in the use of carbon disulfide.



FIG. 106. — LARVA OF ANGOUMOIS MOTH IN A GRAIN OF CORN. Enlarged five times. (W. E. Hinds.)

## FUNGOUS DISEASES

While the corn plant is subject to a few diseases, these are not known to cause much injury in the South, with the exception of those mentioned below, which injure chiefly the ear.

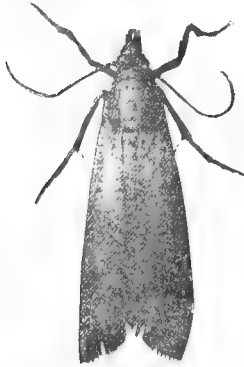

FIG. 107.—THE INDIAN MEAL MOTH.

The larvæ injure corn. Enlarged. (Photo by W. E. Hinds.)

195. Corn smut (*Ustilago maydis*). — The presence of this disease is first shown by a large swelling on the ear, the stem, the tassel, or the leaf (Fig. 108). At first, this protruding mass is covered with a whitish skin, which later bursts, setting free clouds of black powder. These powdery particles are the spores, or bodies answering the purpose of seed, and serving to spread the disease to the next year's crop. These spores gain entrance to the young plant after it has

appeared above ground. The spread of this disease is due to smut masses left in the soil by a preceding corn crop, or blown in by the wind from surrounding corn fields. No treatment of the seed is effective.

The method of spread of the disease suggests the means of decreasing it in subsequent crops, by gathering and burning the smut masses before the whitish skin breaks and sets free the spores. On the same principle, rotation of crops is advisable, especially if this results in growing corn on land where no surrounding fields in the preceding year matured smut spores.

**196. Ear rots of corn.**—These have been found to be due to minute organisms, most of them belonging to two groups of fungi (*Diplodia* and *Fusarium*), and in rarer cases to unidentified bacteria.

In some of the ear rots, the shuck, as well as the grain and cob, is discolored, while in others only the grains and cobs are reduced to a shriveled mass covered with white, pink, or reddish mold-like threads.

The Illinois Experiment Station (Bul. 133) has found these fungous rots to be spread by spores left on the *shanks* of the corn crop of the two preceding years. Hence, the remedy is planting of corn on a field



FIG. 108.—CORN SMUT.

on or near which no corn, injured by these diseases, has been grown for the last two years. Doubtless the burning of the diseased stalks promptly after harvest would tend to prevent the spread of ear rots to subsequent crops.

## LABORATORY EXERCISES

(1) Examine the tips of a number of ears of corn and make an estimate of the percentage of ears injured in that field by the corn ear-worm.

(2) Make germination tests, preferably in the open ground, of 100 weevil-eaten and of 100 sound kernels; determine

(a) the percentage of each that germinates, and

(b) the difference, if any, in the size of the young plants when a few weeks old.

## LITERATURE

BURRELL, T. J., and BARRETT, T. J. (Ear rots.) Ill. Expr. Sta., Bul. No. 133.

STEVENS, F. L. (Ear rots.) N. C. Expr. Sta., Rpt. 1907-'8, pp. 37-39.

BISHOP, F. C., and others. (Corn ear-worm.) U. S. Dept. Agr., Farmer's Buls. Nos. 212 and 290.

BOWMAN, M. L., and CROSSLEY, B. W. Corn (Diseases and insects), pp. 229-260. Ames, Ia., 1908.

CHITTENDEN, F. H., and others. U. S. Dept. Agr., Bur. Ent., Circ. No. 59; and Kan. Board Agr., Dec., 1905, pp. 258-264.

## CHAPTER XII

### RICE — *ORYZA SATIVA*

RICE is one of the grains included in the great family of the grasses. Its seeds are borne in loose heads or panicles at the top of each stem somewhat as in oats (Fig. 109). The root system is shallow and fibrous. Rice is grown along coasts, from the Carolinas south, and also in certain irrigable, low, inland regions. It is grown only in tropical and subtropical regions and in the southern part of the temperate zone. It is cultivated in practically all countries having such climates.

Rice serves as the principal food for a larger number of human beings than any other crop. In the densely populated countries of Asia, especially in China, India, and Japan, it is the principal article of human food.

Rice was introduced into South Carolina near the close of the seventeenth century. Until quite recently rice production in the United States was centered in South Carolina and in the adjacent coastal regions of North Carolina, Georgia, and Florida. After the civil war, rice culture developed in the Mississippi bottoms in Louisiana, where a small amount had been grown before the war. In the eighties, the rice industry was established in the southwestern part of Louisiana. At the present time, this latter region, with the adjacent portion of Texas, produces the greater part of the American crop, which, in recent years,



FIG. 109.—BUNDLES OF TWO VARIETIES OF RICE.  
218



has been about 600,000,000 pounds of rough rice annually. In the early years of the twentieth century, a third rice-growing area has been developed in the prairies in the southeastern part of Arkansas. In the United States the area devoted to rice increased threefold in the sixteen years ending in 1905, the area reported that year being nearly half a million acres, and the yield more than 13,600,000 bushels.

**197. Composition.** — Rice is a very starchy grain. A human diet made up largely of this cereal should also include foods rich in nitrogen, such as seeds of cowpeas and other legumes, fish, lean meat, eggs, or milk. The composition of rice and its products is shown below: <sup>1</sup> —

	WATER	ASH	PROTEIN	CRUDE FIBER	NITRO- GEN- FREE EXTRACT	FAT
	%	%	%	%	%	%
Prepared rice	12.79	0.40	7.33	0.33	78.84	0.24
Rice polish . .	9.73	5.50	12.73	2.20	59.40	10.44
Rice bran . . .	10.05	11.17	11.35	16.10	39.76	11.57
Rice hulls . . .	10.11	14.95	1.88	39.11	33.62	0.33
Rough rice . .	5.73	5.89	7.75	8.25	70.13	2.31
Rice straw . .	6.76	12.88	3.00	38.98	42.11	1.27

McDonnell's analyses <sup>2</sup> indicate that a rice crop of 35 bushels (nearly 9 bags) and 1800 pounds of ripe straw removes from the soil, in round numbers,

12 pounds of phosphoric acid,  
29 pounds of nitrogen,  
35 pounds of potash.

<sup>1</sup> La. Expr. Sta., Feed Stuff's Report, 1908-1909.

<sup>2</sup> S. C. Expr. Sta., Bul. No. 59

**198. Uses.** — The chief use of rice is to feed mankind, for which purpose it is specially prepared by the removal of the hull and by other manufacturing processes. However, the polishing of the grains results in removing some of the most nutritious part.

Rice polish, one of the flourlike by-products of the rice mill, is a nutritious and palatable food for any class of live-stock. Rice hulls have but little food value and even when ground, their use is undesirable. Rice bran usually consists of the seed coats to which adheres much of the nutritious layers of the grain, mixed with some ground rice hulls and polish. It is inferior in feeding value to rice polish.

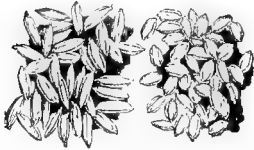

FIGS. 110 AND 111. — TWO TYPES OF RICE.

The Honduras on the left and the Japanese on the right. The short kernels of Japanese rice do not break in polishing so readily as the long grains of Honduras.

**199. Varieties.** — In oriental countries there are hundreds of varieties of rice, but few kinds are grown in the United States. Chief among the latter are types known as Honduras, Japan, and Gold Seed (Figs. 110 and 111).

The types generally grown in our southwestern rice fields are Japan and Honduras, which are described as follows: "The Japan has a short, thick kernel, a thick hull, and heavy grain. It is not so tall as the Honduras, and the straw is smaller and green when the grain is ripe. The percentage of bran in the Japan is small. Since the grains do not break so badly, it will mill more head rice (high-grade unbroken grains) than the Honduras. The market price for Japan, however, is a little less than for

Honduras, but the yield is greater. The Honduras has a large grain, a tall, stiff stalk, and is not so easily blown down." (S. A. Knapp, in Farmer's Bul. No. 110, U. S. Dept. Agr.)

**200. Soils and fertilizers.** — Since rice is usually grown on land subjected to irrigation and thereby enriched, fertilizers are seldom employed in the United States on this crop. Hence relatively little is known of the fertilizer requirements of rice. In oriental countries, rice is highly manured.

Experiments in Louisiana indicate that phosphate increases the yield and that potash probably helps to harden the grain and straw.

**201. Sowing.** — While broadcast sowing is not unusual, the best and most common method consists in planting rice with a grain drill. This causes the seeds to be covered to a more uniform depth than is possible by broadcast sowing. The quantity of seed generally employed is one to two bushels or one fourth to one half barrel per acre. Usually the grain drill should be preceded, and not followed, by the roller.

Occasionally in sowing rice that is to be irrigated immediately, South Carolina farmers mix the seed with clay and water, so that when water is admitted to the land, the seed will not float.

**202. Implements and labor.** — Only where preparation has been made for draining the land, can labor-saving implements be used in preparing for and sowing the crop and in harvesting. Plowing is usually done in spring, but a preliminary plowing is often desirable in the early part of the preceding fall. The depth of plowing must be governed

by local conditions. While deep plowing might otherwise be desirable, it risks inconvenience in harvesting, since in fields deeply plowed the wheels of the binder sink too deep if much rain falls just before harvest time. The land must be further prepared by harrowing (Fig. 112).

In the rice fields of South Carolina, which are very small and poorly drained, planting is done chiefly by hand labor.

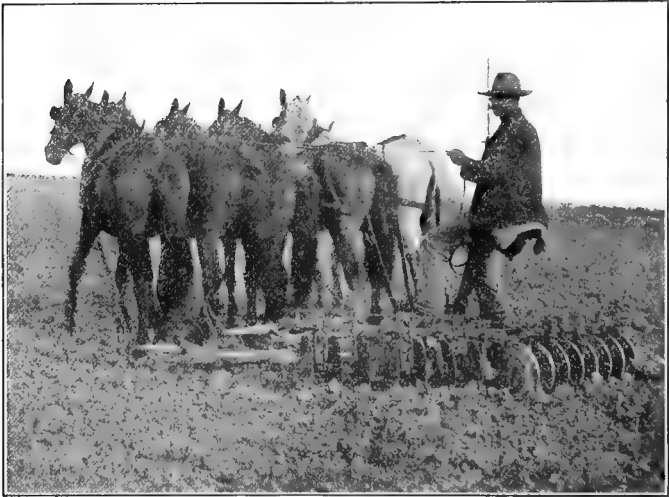

FIG. 112. — PREPARING FOR RICE IN LOUISIANA.

The employment of hand labor in this region for planting and harvesting the crop has caused the decline of the rice industry here, where the cost of production is necessarily much higher than on the prairies of Louisiana, Texas, and Arkansas, where machinery is used for all of these operations.

**203. Irrigation.** — No extensive rice industry has developed in the United States except where irrigation was possible. Irrigation is necessary to large yields and to the most economical production. Lands must be chosen that can easily be irrigated. For this purpose the main qualities desired are slight, if any, slope of the surface, and a retentive subsoil. The latter is important so that irrigation water may not be lost too rapidly through the soil, and also because such soils, after being drained, best permit the use of heavy machinery in the planting and harvesting of the crop.

Water for irrigation is supplied in the Louisiana and Texas rice districts by pumping, the source being either adjacent bayous and rivers or an underground supply, found in southwest Louisiana at no great depth. In the new Arkansas rice-growing region, water is secured from bored wells. In South Carolina, irrigation is accomplished by admitting the water of the rivers when the fresh water is raised by the high tide, while the drainage of rice fields is accomplished at periods of low tide.

After a supply of water has been provided and brought to the highest part of the fields by a system of canals, low levees must be constructed, chiefly with the plow, so as to maintain the water at almost a uniform depth throughout a given section of the field. This should range between 3 and 6 inches on any one section of the field (Fig. 113). Variations in the depth of irrigation water cause unevenness in the time of maturing and hence injury to the quality of the product.

**204. Irrigation practice.** — In Louisiana, the drained fields having been sown by the use of a grain drill, the

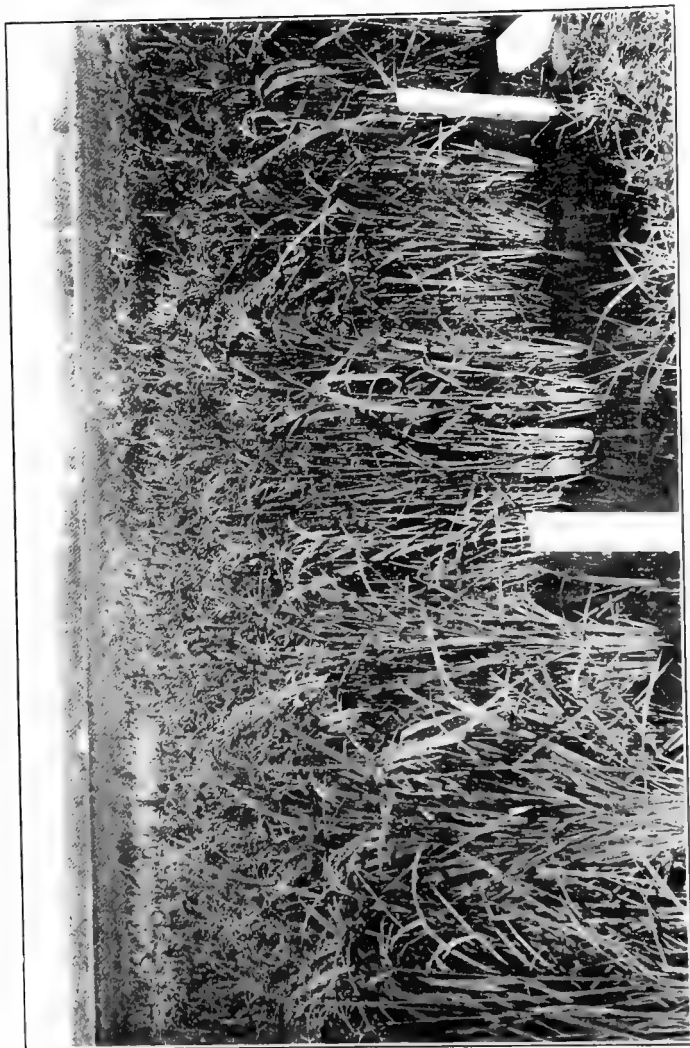

FIG. 113. — AN EXPERIMENTAL FIELD OF RICE AT CROWLEY, LA.

young plants are allowed to grow, if practicable, without irrigation until the rice is 8 inches high, since the very young plants are liable to scalding in shallow water. However, it is sometimes necessary to irrigate in order to cause the seed to germinate. When the plants have reached a height of 8 inches, the field is covered with water to a depth of 3 to 6 inches. Care should be taken that the water does not become stagnant, which is prevented by providing for a continuous inflow into the high part of the section and for a continuous outflow from the lower part of each section of the field.

Irrigation in rice culture largely takes the place of cultivation, since it prevents the growth of many weeds and encourages the growth of the rice plant.

Near the time of harvest, the water is drawn off so that the fields may become firm enough for the teams and machinery engaged in harvesting.

The practice in South Carolina differs from the above. The water is admitted as soon as the seed is sown, and it is kept on the land 4 to 6 days to sprout the grain. The field is then drained. When the plants are a few inches high, another brief watering is given and the land again drained. Soon afterwards, irrigation is repeated, the water being kept on the land 20 to 30 days. It is then drawn off and the field hoed. No more water is admitted until jointing of the plants begins, when they are hoed and the water again turned on, to remain until about 8 days before the harvest, when it is withdrawn. Care is taken to secure a constant change of water so as to avoid stagnation.

**205. Upland rice.** — There are upland strains of rice that have become accustomed to being grown without

irrigation, but which cannot be distinguished from lowland rice. This so-called upland rice succeeds better when irrigated. For the culture of rice without irrigation, the best soils are drained ponds or moist bottom lands.

Since the crop must be kept free from grass and weeds by tillage, upland rice should be sown in drills, as close together as practicable without preventing the use of cultivating implements. The usual distance between rows is two and one half to three feet. Custom varies as to the thickness of planting in the drill. It is most convenient for the seeds to be dropped, a number in a place at distances of seven to twelve inches apart.

Several cultivations and one or two hoeings are usually given. The yields are generally much less than on irrigated land, and the expense of tillage is greater than that of irrigation. However, on soils especially suited to this crop and where labor is not expensive, it may be advisable to introduce the culture of rice, especially for use in the immediate neighborhood.

The quality of upland rice is regarded as somewhat inferior to that of irrigated rice, probably because of imperfect filling of some of the grains, and differences in the time of maturity among the different plants. Moreover, the small rice hullers which are usually employed (in connection with a gin or grist mill), in localities where only small areas of rice are grown, do not turn out a product as highly polished as that obtained in the large and well-equipped rice mills. However, the dark and unpolished rice of the small mills is more nutritious than the pearly-white article of commerce, for the reason that the former contains more of the outer layers, which are the richest in protein.



Upland rice should usually be fertilized with acid phosphate, and, if thought best, with potash and nitrogen.

**206. Harvesting.** — The nature of the soil in Louisiana and Arkansas permits the drainage of the fields, so that the rice crop is there harvested by the use of self-binders.

After the grain has been somewhat further cured, it is carefully shocked (Fig. 114). "First, shock on dry ground; second, brace the

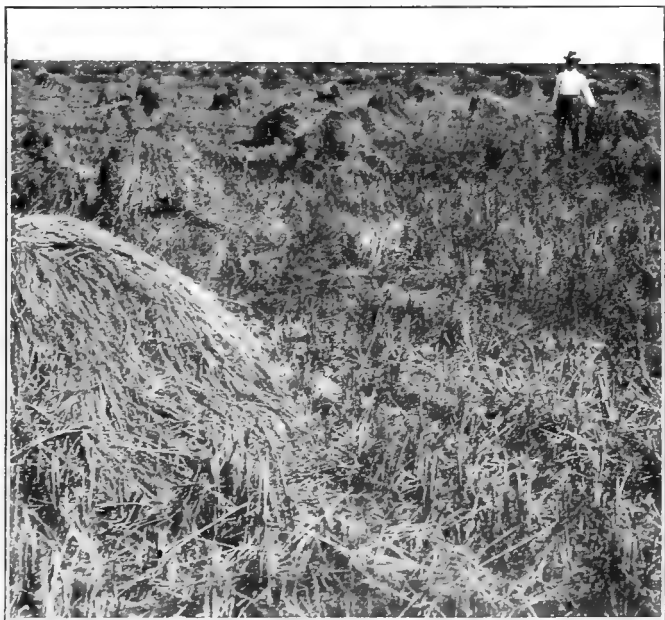

FIG. 114. — A RICE FIELD AFTER HARVEST.

bundles carefully against each other, so as to resist wind or storms; third, let the shock be . . . capped carefully with bundles. . . . Slow

curing in the shade produces the toughness of kernel necessary to withstand the milling processes. In the shock every head should be shaded and sheltered from storm as much as possible. The rice should be left in the shock until the straw is cured and the rice is hard." (S. A. Knapp, in Farmer's Bul. No. 110, U. S. Dept. of Agr.)

Threshing is done in the same way as with other grains, usually in Louisiana, directly from the shock. The rough rice, usually in bags or barrels of 162 pounds, is sold to the rice mills.

Rough rice weighs 45 pounds per bushel and yields about half its weight of marketable rice, besides cracked rice, polish, and other by-products.

A fair yield in irrigated regions is 10 to 18 barrels or bags per acre.

**207. Weeds.** — The rice planter encounters his greatest difficulties through the invasion of the field by a multitude of troublesome weeds. The general methods of control are plowing at opportune times and flooding. The most troublesome weed is red rice.

Red rice is frequently accidentally sown with seed rice. It is a strain different from the types of rice cultivated in the United States and comes only from red rice seed; but this plant is capable of crossing with cultivated rice. A method recommended for ridding the land of this and of other weeds is to plow the field soon after harvest, so as to cause the seed of red rice and of other weeds to germinate. The young weeds are then killed by frost, or, in some cases, mowed and burned.

Another method of fighting true weeds, other than red rice and other members of the grass family, consists in mowing the mass of young rice and weeds in the late spring or early summer, with the expectation that the rice will then develop a central shoot while the weeds will not make further growth.

Early spring plowing is sometimes practiced to induce the weed seeds to germinate; the young plants are then killed by culti-

vation before the rice is sown. But this may result in making the date of planting too late for best yields of rice.

Another method of fighting weeds consists in applying no water for a year or more, meantime not using the land for rice or even for any crop. In this way, the dry-land weeds crowd out the water-loving weeds, which latter are the most serious enemies of the Louisiana rice grower.

**Insect enemies.** — Rice is not greatly injured by many insects. Among insect pests is the larva or grub of a small gray beetle, the water weevil (*Lissorhoptus simplex*). The grubs in summer feed on the roots of the plants, giving to the clumps of plants affected a yellowish appearance. The remedy consists in preventing the stagnation of the water and, if practicable, in the temporary withdrawal of the water and the drying out of the land.

**Fungous diseases.** — Rice blast, also called "rotten neck," is thought to be caused by a fungus (*Piricularia oryzae*). The sheath node is attacked, that is the node in which the head is forming, and the head may fail to fill out or may break off. Experts are not agreed as to any practicable treatment for this disease.

*Rice rust* causes the leaves to die and the grain to be light. The cause is not definitely known. This trouble has been prevented by using 400 pounds of kainit per acre.

*Rice smut* (*Tilletia horrida*) occasionally occurs, filling the kernel with a mass of black spores. According to Anderson, it can be prevented either by (1) scalding the seed for 10 minutes in water kept at a temperature of 133° F., or (2) by moistening the seed for about 2 hours in a solution of one ounce of formalin to 3 gallons of water.

**Rice birds or bobolinks** (*Dolichonyx oryzivorus*).—These birds prey on the ripening grain. Men and boys armed with shot guns are employed in some localities to frighten these birds from the rice fields.

### LABORATORY EXERCISE

If seed heads or rough (unhulled) rice can be obtained, write a description of the seed and its covering, and of the arrangement of seeds on the branches.

## LITERATURE

- KNAPP, S. A. Rice Culture in the United States. U. S. Dept. Agr., Farmer's Buls. Nos. 110 and 417.
- KNAPP, S. A. Rice Culture in the United States. U. S. Dept. Agr., Div. Bot., Bul. No. 22.
- KNAPP, S. A. Rice. Bailey's Cyclo. Agr., Vol. II, pp. 534-539.
- STUBBS, W. C. La. Expr. Sta., Bul. No. 24.
- DODSON, W. R. La. Expr. Sta., Buls. Nos. 50, 61, and 77.
- DODSON, W. R. Red Rice, La. Expr. Sta., Bul. No. 50.
- ANDERSON, A. P. Rice Blast and Rice Smut. S. C. Expr. Sta., Bul. No. 41.
- METCALF, H. Blast of Rice. S. C. Expr. Sta., Bul. No. 121.
- McDONNELL, C. C. A Chemical Investigation of the Rice Plant. S. C. Expr. Sta., Bul. No. 59.
- NELSON, R. J. Rice Culture. Ark. Expr. Sta., Bul. No. 94.
- VINCENHELLER, W. G. Rice Growing in Arkansas. Ark. Expr. Sta., Bul. No. 89.
- BEAL, H. W. Extension of Rice Culture. U. S. Dept. Agr. Farmer's Bul. No. 305.
- AUSTIN, A. Rice. U. S. Dept. Agr., Div. Sta., Rpt. No. 6.

## CHAPTER XIII

### THE SORGHUMS — ANDROPOGON SORGHUM (OR SORGHUM VULGARE)

THE sorghums comprise a very interesting group of diverse sub-species grown over a wide range and used for a variety of purposes. Some kinds or races are used for the making of sirup, and are sometimes erroneously known as "sugar-millet"; some are grown for the grain in the top or head; one provides the material from which brooms are made; they all yield forage, of different degrees of excellence. The group belongs to the *Gramineæ*, or grass family.

#### THE SORGHUMS IN GENERAL

208. **Groups of sorghum.** — The sorghums may be divided into three groups, all of the same botanical species. These classes are: (1) *saccharine* or *sweet sorghums*, grown for forage and sirup; (2) *nonsaccharine* or *grain sorghums*, including kafir and milo, which latter are important grain and forage crops in the dry climate of the southwestern part of the United States; (3) *broom-corn*, from which brooms and brushes are made. There are a number of varieties of each class, only the most important of which can be mentioned here.

209. **General description.** — The sorghums are giant grasses with stout, solid, pithy stems. The leaves are long and broad, but smaller than those of corn. The heads are of considerable size and varying shape and are borne at the top of the stems. The sorghums have strong root systems, made up of numerous fibrous parts.

All kinds grow slowly during the first few weeks of life, at which time they are easily overrun by weeds; therefore they make their best growth on clean land.

**210. Effects on the soil.** — The sorghums are generally regarded as the most exhaustive among the ordinary crops of the farm. They leave the land in an unfavorable mechanical condition, which is due chiefly to the following causes: —

(1) The presence of clods held together by the matted roots of the stubble;

(2) The slowness with which the stubble and other remains of the crop decay;

(3) The dry condition in which the soil is left, due to the large amount of leaf surface engaged, up to the time of harvest, in throwing off moisture derived from the soil.

**211. Composition.** — In all classes of sorghum, the stems and leaves, which are the parts used for green or cured forage, are rich in carbohydrates (starch and sugar), and poor in protein. Likewise, the seeds of all sorghums are rich in carbohydrates and slightly richer than corn in protein.

*Composition of Forage and Seed of Various Sorghums*

	WATER	PROTEIN	FAT. ETC.	NITRO- GEN- FREE EXTRACT	FIBER	ASH
Saccharine sorghum, cured plant . . . . .	28.0	4.0	3.0	37.0	24.0	4.0
Kafir, cured stover . . . . .	13.3	5.5	1.7	42.0	27.9	9.3
Kafir grain . . . . .	9.9	11.0	3.1	71.2	2.8	1.6
Milo grain . . . . .	9.7	10.7	2.8	72.2	3.1	2.3
Saccharine sorghum seed . . . . .	12.8	9.1	3.6	69.8	2.6	2.1

**212. Origin and crossing.** — All three classes of sorghums are thought to trace back to the same ancestor and to be natives of tropical Africa. In some eastern countries, the seeds of some of the sorghums are important human foods.

The various sorghums were introduced into the United States in 1853, and at intervals throughout the next few decades.

Sorghums of all kinds freely cross with each other, the light pollen being spread by the wind. Therefore, varieties from which seed is to be saved should not be planted near any other variety or allowed to bloom at the same time.

**213. Enemies.** — In the Southern States, especially from Louisiana eastward, the yield of seed from any class of sorghum is quite uncertain, and complete failures to mature seed are not infrequent. The usual cause of such failures is the attack on the flowers and kernels by a minute insect, the *sorghum midge* (*Diplosis sorghicola*). For this no effective treatment is known. Probably some advantage would result by planting this crop in fields remote from where sorghum was grown the previous year.

*Sorghum kernel smut* (*Sphacelotheca sorghi*) is a disease caused by a fungus which destroys the individual grains. It is easily prevented by either of the following methods: (1) by soaking the seed for planting for one hour in a solution of 1 ounce of formalin for each 2 gallons of water; or (2) by scalding the planting seed for 10 to 12 minutes in water kept at a temperature between 134° and 140° F. Either of these treatments kills the germs of the disease without injuring the seed.

## SACCHARINE OR SWEET SORGHUMS

**214. Description and uses.** — The sweet sorghums are 8 to 12 feet high, and are distinguished from other classes of sorghum by the great abundance of sweet juice in the stem. "Sugar millet" is a local name sometimes given to the sweet sorghums, although this plant is not a millet. When the word "sorghum" is used alone, it usually refers to the sweet sorghum.

This group is used for the production of sirup as well as for green and cured forage. It is treated in this book



FIG. 115. — ON LEFT, THREE HEADS OF AMBER SORGHUM; ON RIGHT, TWO HEADS OF RED KAFIR.

only as a sirup crop, its cultivation and curing for feeding purposes belonging to books on forage plants. Sorghum has been used to a very limited extent as a source of sugar,



but in this respect it cannot compete with sugar-cane and sugar-beets.

As a sirup plant, sorghum is most extensively grown in the northern part of the cotton-belt and in the regions a little farther north. Even in the region where sugar-cane succeeds, some sorghum sirup is made, for two reasons: (1) that sorghum grows on poorer land than does sugar-cane, and (2) that it affords sirup 1 to 2 months earlier in the fall than does sugar-cane. The sirup from the latter is superior both in yield and quality.

**215. Varieties.** — There are many varieties, which may be divided into four sub-groups differing chiefly in the form of head and the color and covering of the seed:—

(1) Amber sub-group, having large loose heads with seeds borne on long, slender, flexible branches; seeds almost completely covered by black chaff (glumes), making seeds and head appear black (Fig. 115); one variety has red chaff.

(2) Orange sub-group, having heads neither very open nor very compact; seeds yellowish, projecting beyond the dark chaff (Fig. 116);

(3) Sumac, or Red-top, sub-group, having short, very compact heads; seeds small, brownish red, projecting considerably beyond the very small glumes.

(4) Goose-neck sub-group, so called because the top of the stem curves, permitting the head to hang down (Fig. 117). The stalks of this variety near the ground



FIG. 116. — ORANGE SORGHUM.

sometimes attain a diameter of  $1\frac{1}{2}$  inches. Where known, this is a favorite variety for the production of sirup, by reason of the large size of stalk, the large yield of cane, and the smaller amount of labor required in stripping it.



FIG. 117. — GOOSE-NECK SORGHUM.

The Amber varieties are early, requiring only about three months to reach maturity. The Orange is two or three weeks later, the stems larger and the yield somewhat greater than in the Amber varieties.

Sumac, or Red-top, sorghum is about as late as Orange.

The richness in sugar of any variety may be greatly increased by selecting seed a few years from those plants which, by chemical tests, show the highest percentages of sugar. The usual amount of sugar in the juice is 12 to 16 per cent.

**216. Soils and fertilizers.** — Sweet sorghum may be grown on soils of almost any character. Because of its drought resistance, it is often assigned to poorer soil than that given to any other crop outside of the class of legumes or soil-improving plants.

Sorghum is often grown without fertilizer; but on soils where it is necessary to fertilize other crops, this responds profitably to moderate applications of manure and to any commercial fertilizer suitable for corn on the same soil. Nitrogen seems to be the most important constituent in a fertilizer for sorghum, but it is often advisable to add moderate amounts of phosphoric acid and

potash. Fertilizer should be applied in the same way as to corn.

**217. Preparation and planting.** — Because of the slow growth of the young plants, preparation of the land should be thorough, to promote as rapid growth as possible of the young plant and to free the soil from all growing weeds and grass. On well-drained land, planting is usually practiced without ridging, which, however, may be necessary on poorly drained bottoms. In the dry climate of the Southwest, sorghum is sometimes “listed”; that is, planted in an un-filled furrow, considerably below the level of the field.

A customary distance between rows is  $3\frac{1}{2}$  feet, and between single plants grown for sirup, 3 to 8 inches. Seeding is performed with a planter, a few quarts sufficing for an acre.

When practicable, tillage should be given with a weeder or harrow before the plants appear and again when they are large enough to escape injury. Several cultivations or tillings with one- or two-horse cultivators, and in the Gulf States one or more hoeings, are usually given.

Sorghum should be planted several weeks later than the earliest corn. The greater part of the crop is planted in May. However, in the cotton-belt sorghum for forage may be planted as late as July, though such late planting reduces the yield.

**218. Harvesting.** — When the plant is thoroughly mature, as shown by the sweetness of the juice and the ripening of the grain, the heads are cut for seed, the leaves stripped from the stem and utilized for forage, and the stalks cut and made into sirup in practically the same way in which sugarcane is handled.



FIG. 118. A FIELD OF BLACK-HULLED WHITE KAFIR.

## KAFIR

**219. Description and uses.** — Kafir, also called “kafir corn,” has shorter stems, 5 to 8 feet in height, and more compact heads than have the saccharine sorghums (Fig. 118). The heads are always erect and the grain projects well beyond the chaff. There are red and white varieties;

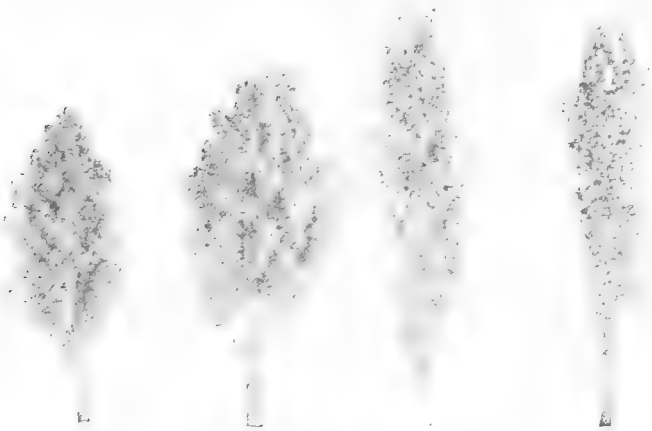

FIG. 119.—ON LEFT, TWO HEADS OF MILO; AND ON RIGHT, TWO OF BLACK-HULLED WHITE KAFIR.

the one most extensively grown is Black-hulled White kafir (Fig. 119).

The most valuable quality of this plant is its drought resistance, which makes it an important grain and forage crop in the dry climate of the western part of Kansas, Oklahoma, and Texas, where it is largely grown as a substitute for corn, which it exceeds in yield of grain in regions where the rainfall is scant. East of Texas the crop of grain, though

sometimes large, is uncertain, as a result of attacks by insects.

In feeding value, kafir grain is nearly equal to a corresponding weight of corn. It is fed to all classes of live-stock and is especially prized for poultry. There is more need to grind kafir than to grind corn. The forage remains green up to the time of the ripening of the grain.

Kafir requires about four to four and a half months to reach maturity.

**220. Soils and planting.** — The kafir plant thrives on a variety of soils. It succeeds especially well on sod land never before cultivated. Its cultivation is nearly the same as that of sorghum grown for sirup. In the Southwest, kafir is often listed, which is considered to be advantageous in a dry season. There it is sometimes planted with a two-row corn planter. The plants are left 3 to 5 inches apart in the row and the rows are ordinarily  $3\frac{1}{2}$  feet apart.

**221. Harvesting.** — This is usually done with a corn-binder, but sometimes with a header or device attached to a wagon and intended to cut and lift into the wagon body only the heads. Heads thus cut must be kept in thin layers to prevent heating. The seeds are threshed from the stalk by the use of an ordinary grain thresher.

## MILLO

**222.** This crop is also called "milo maize." The stems resemble those of kafir; the heads are shorter and more rounded and the seeds are more flattened than those of kafir (Fig. 119). Milo is even more drought resistant than

kafir and may make a crop where the rainfall is only 10 to 14 inches.

Other advantages over kafir are its earlier maturity and its freedom from attack by kernel smut. The disadvantages of milo as compared with kafir are: (1) the leaves are fewer and the stems more pithy; (2) the fact that the leaves of milo do not keep perfectly green up to the time of the ripening of seed, making its forage less palatable.

The methods of planting, cultivating, and harvesting milo are the same as for kafir. In experiments made in the northwestern part of Texas, a distance of 6 inches between plants in the row afforded the largest yield of seed.

Selection has resulted in a dwarf variety and also in strains having erect heads, thus making harvesting easier than with the pendant heads, usual in the plants of milo.

### BROOM-CORN

**223. Description.** — Broom-corn is a tall, nonsaccharine sorghum. It is distinguished from other sorghums by the great length and toughness of the branches that make up the panicle (Fig. 120). The valuable part of broom-corn consists of these long heads after the removal of the immature seed; this useful part is called the "brush," and from it brooms and various kinds of brushes are made.

A fair yield of cured and prepared brush of the standard varieties is about one third of a ton per acre. The dwarf varieties ordinarily yield about one fifth of a ton of brush per acre, but this dwarf brush commands a higher price. The price of broom-corn is subject to violent fluctuations; eighty dollars per ton of brush may be taken as an average, but the price sometimes sinks below this and sometimes rises to about double this figure. The fluctuations in price are largely due to the fact that only a relatively small area (usually less than 40,000 acres and some years less than 20,000 acres) is required to furnish the entire American

crop of broom-corn. Therefore an increase of a few thousand acres greatly depresses prices.

The chief centers of production are certain districts in Illinois, Kansas, and Oklahoma.

Nashville, Tennessee, is probably the most important southern market for broom-corn brush. If the crop is grown on farms in the South Atlantic and Gulf States, growers should aim rather to supply local broom factories than to compete on the larger markets with localities in which broom-corn culture is a long-established industry.

#### 224. Types of broom-corn.

— The varieties of broom-corn may be divided into two types or classes—standard and dwarf varieties. Standard broom-corn is a tall plant with brush 18 to 24 inches long. Dwarf broom-corn usually stands only 4 to 6 feet high and bears brush that is 10 to 18 inches long. From



FIG. 120. — BROOM-CORN: BRUSH.

On left, before removal of seed; and on right, after stripping.

brushes, hearth brooms, and brooms. The Dwarf varieties are considered to be especially suited to Oklahoma and Kansas.

225. Climate, soils, and fertilizers. — While the broom-corn plant can be grown under a wide range of climatic and soil conditions, yet it is most profitable in a climate



where there is but little rain at the time of harvest. Harvest occurs about the same time as with other kinds of sorghum; that is, in August and September. In the southeastern part of the United States the weather is more apt to be dry in September and October than in August; hence it is well to postpone the date of planting late enough into May or June to bring the harvesting season in September, rather than earlier.

Rain just before or at harvest time is likely to cause plant-lice to attack the plants and to discolor the brush, which, in order to command the highest price, should be of a green color.

Any land on which a good yield of corn is ordinarily made is suitable for broom-corn.

The same fertilization as for corn, or for sorghum grown for sirup, is advisable. The soil should be fertile enough and the fertilizer rich enough in nitrogen to insure a tall and rapid growth, which is favorable to length of brush.

**226. Culture.** — If seed is to be saved, broom-corn should be planted in a field remote from any other kind of sorghum, as all kinds of sorghum readily hybridize, or mix. For this and for other reasons, one should plant seed only from selected plants, grown in a seed patch where no mixing could have occurred and from which all poor heads were removed before the pollen was ready to be shed.

Planting in Oklahoma is done chiefly in May. Broom-corn may be planted earlier in the southern portion of the cotton-belt; but here it is probably well to delay planting late into May or even later, so as to bring the harvest season in September when there is a greater probability of dry weather than there is in August.

The seed should be planted in well-prepared land in rows about  $3\frac{1}{2}$  feet apart, one plant standing every 3 or 4 inches on rich land or at double this distance on poor land. Cultivation is somewhat more conveniently performed if the plants are left, 3 to 6 in a hill, at distances of about 16 inches apart for standard kinds, or at shorter intervals for dwarf varieties.

For planting on a seed-bed in perfect condition with the expectation of not thinning the plants, 2 quarts of good seed is sufficient for an acre. With land less perfectly prepared or where thinning is necessary, at least double this amount of seed is sometimes used.

Tillage is similar to that given to corn, or to sorghum grown for sirup.

**227. Harvesting and preparation for market.** — Harvesting of the brush occurs before the seeds form; that is, when the anthers are falling. The heads of the dwarf plants are pulled instead of being cut. Standard varieties must first be bent down or "tabled." This is done by bending down, about 3 feet above the ground, the stalks on two rows. These bent plants are brought together diagonally in a horizontal position, the brush of one row extending beyond the upright portion of the stalks on the adjacent row. The brush is then cut with a sharp knife at a distance of about 8 inches below the head. It is laid, for partial drying, on the tables made by the bending together of two rows of stalks.

After sorting the heads to separate all crooked and unmarketable brush, the immature seeds are removed by scraping or threshing on a special kind of thresher, the

brush not passing through the machine, but being held against the revolving cylinders.

Drying is done rapidly in the shade of special sheds and away from strong light, so as to retain the green color. In a shed for curing broom-corn, the layers of threshed brush are only 2 or 3 inches thick on flat supports, so as to insure ample ventilation and quick curing.

After curing, the brush is packed into bales weighing from 300 to 400 pounds.

**228. Enemies.** — The principal insect enemies are plant-lice and chinch-bugs. Sorghum smut is the most serious fungous disease. This is carried through the seed and can be prevented by soaking the seed for fifteen minutes in water kept at a temperature of 135° F.

### LABORATORY EXERCISES

(1) Write a description of each class and variety of sorghum of which specimens can be obtained, noting especially the following: —

- (a) Color of naked seed;
- (b) Color and size of chaff;
- (c) Whether seed is almost completely covered by chaff, or projects slightly, or is largely uncovered.

(2) Write a description of the heads of each class and variety of sorghum of which specimens can be obtained, noting especially the following: —

- (a) Compactness of head;
- (b) Shape of head, — oval, cylindrical, roundish, fan-shaped, or irregular, — illustrating the shape by drawing the outlines of each head;
- (c) Length of head in inches.

(3) If a field of any class or variety of sorghum can be inspected, make record of the following: —

- (a) The apparent impurity, or percentage of plants which seem to belong in a different class or variety;
- (b) Effects on the size of heads and size of stalk due to wide or close spacing of plants.

(4) If a field of kafir or milo can be inspected, note whether there is uniformity in the height of plants and time of ripening. If not, does this diversity interfere with the local method of harvesting the seed?

(5) If fields of saccharine sorghum are available, cut short sections of the same row when the plants are at different heights, or stages of maturity; record the weights and condition when cut, and a month or two after each cutting, note the effects of cutting at different stages on the height of the second growth.

#### LITERATURE

##### Saccharine sorghums.

- BALL, C. R. U. S. Dept. Agr., Farmer's Bul. No. 246; Circ. 50.
- NEWMAN, J. S., and others. Sorghum as a Sirup Plant. S. C. Expr. Sta., Bul. No. 88.

##### Nonsaccharine sorghums — kafir and milo.

- WARBURTON, C. W. The Nonsaccharine Sorghums. U. S. Dept. Agr., Farmer's Bul. No. 288.
- CONNER, A. B. Forage Crops in Northwest Texas. Tex. Expr. Sta., Bul. No. 103.
- BALL, C. R., and LEIDIGH, A. H. Milo as a Dry-land Grain Crop. U. S. Dept. Agr., Farmer's Bul. No. 322.
- FREEMAN, E. M., and UMBERGER, H. J. C. The Smuts of Sorghum. U. S. Dept. Agr., Bureau Plant Ind., Circ. No. 8.
- ROBERTS, H. F., and FREEMAN, C. F. Prevention of Sorghum and Kafir Corn Smut. Kan. Expr. Sta., Bul. No. 149.

- COBURN, F. D. The Sorghums. Kan. Bd. Agr., Rpt. 1st. Quarter, 1896.
- HUNT, T. F. The Cereals in America, pp. 383-399. 1904, New York.
- BALL, C. R., and WARBURTON, C. S. Bailey's Cyclo. Agr., Vol. II, pp. 574-582.

**Broom-corn.**

- HARTLEY, C. P. Broom-corn. U. S. Dept. Agr., Farmer's Bul. No. 174.
- NEWMAN, C. L. Broom-corn. Ark. Expr. Sta., Bul. No. 83.
- DODSON, W. R. Broom-corn. La. Expr. Sta., Bul. No. 67.
- WARBURTON, C. W. Bailey's Cyclo. Agr., Vol. II, pp. 216-217.

## CHAPTER XIV

### COTTON—STRUCTURE AND GENERAL CHARACTERISTICS

COTTON is the world's most important fiber plant. The cotton plant as generally grown in the United States is of erect or bushy form and usually three to seven feet tall. In this country it is an annual, being killed by frost in the fall. In its native home in the tropics the cotton plant is a perennial, living for many years. Suggestions of this perennial habit are afforded after a mild winter in the southern part of the cotton-belt by the sprouting of plants from the old root or stem.

**229. Stems and branches.** — The cotton plant consists of an erect central stem, usually three to six feet long, from the nodes of which branches arise. Stems and branches are woody and solid. The length and arrangement of branches are important as means of distinguishing varieties and as indications of productiveness and earliness.

The longest limbs of cotton are usually near the base of the plant, the length decreasing towards the top of the main stem. This gives to cotton plants of most varieties a cone-shaped, pyramidal, or sugar-loaf form. However, in varieties, known as "cluster cottons," there are a few long limbs near the base of the plant; all branches above these basal limbs are only a few inches long, thus giving a slender or "erect" appearance to the upper two thirds of



FIG. 121. — A VEGETATIVE BRANCH FROM NEAR THE BASE OF A COTTON PLANT.

Showing that the boll-stems are not borne directly on the vegetative branch, but on secondary branches springing from it.

the plant. Between cluster cotton and wide-spreading, long-limb kinds there are all gradations in length of branches.

Each branch arises from the main stem in the angle be-

tween a leaf and the main stem. Usually this leaf on the main stem falls before the branch attains much size, but its position is shown by the leaf-scar.

The plant has two classes of branches or limbs. The longer, ascending ones (Fig. 121) are sometimes called vegetative or primary branches, while slenderer or shorter branches on which bolls are attached directly by their flower stalks or boll-stems (peduncles) are called "fruiting limbs" (Fig. 122). The primary branches have also been

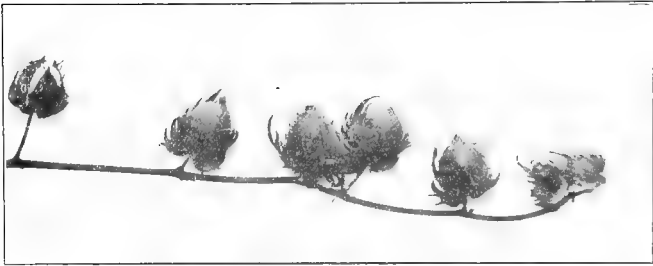

FIG. 122. — A FRUITING BRANCH.

Showing that the boll-stems are borne directly on the branch.

called sterile limbs; this is because no boll-stem or boll is borne directly on these vegetative limbs, though boll-stems, with attached bolls, spring from the subdivisions of these main branches.

In general, a primary branch supports numerous leaves, and, on its sub-branches, some bolls; while a fruiting limb usually bears several bolls and but few leaves.

Normally, two branches arise from the axil of a leaf on the main stem (Fig. 123). One of these twin branches, arising from the same node of the main stem, is a fruiting





FIG. 123.—A COTTON PLANT.

Showing the growth of two branches from each of certain nodes on the main stem.



FIG. 124.—COTTON PLANT ON WHICH THE VEGETATIVE BRANCH IS SUPPRESSED AT EVERY NODE EXCEPT WHERE THE TWO LOWEST (VEGETATIVE) BRANCHES ORIGINATE.

branch, and the other a vegetative or so-called sterile branch. At many of the nodes one or the other of these branches fails to develop conspicuously, and is represented merely by a tiny shoot or bud (Fig. 124.) If a vegeta-



FIG. 125.—A COTTON PLANT HAVING ONLY FRUITING LIMBS.

tive limb develops at nearly every node, the plant presents a very bushy, round-topped, leafy appearance, and the bolls may be relatively few and too much shaded.

It is probable that the yield will be increased by selecting seed from plants on which a large proportion of the fruit limbs develop fully, and on which there are relatively few fully developed vegetative branches (Fig. 125).

On the main stem of some plants the fruit limb is invariably on the left side of the sterile limb, while on other plants, the fruit limb is uniformly on the right side of its twin vegetative branch.

**230. Maturity or earliness.** — It has been found by Bennett that those cotton plants are earliest in maturity (as judged by the time when their bolls are formed) that are short-jointed and that throw out their lowest limbs from nodes very near the ground. For earliness and productiveness there should be numerous nodes on the main stem, — that is, points from which branches spring, — and these should be close together. Likewise on the limbs, the distance between bolls or secondary branches should be short, especially where earliness is important.

**231. Bark and stem.** — The bark of the cotton plant is fairly strong and tough. To a limited extent cotton bark has been used as a coarse fiber, once proposed as a covering for cotton bales, and in the making of paper.

The woody stem inside the bark is weak and brittle, so that after the plants are killed by frost the stalks can readily be broken or cut, and after being plowed under, they rot more rapidly than do corn-stalks similarly treated.

The color of the bark of the nearly mature plant is usually reddish brown, but the shade varies on different sides of the same stem and in different varieties and individuals. Some plants have a dark greenish bark. Such plants tend to drop their leaves early and to mature early.

**232. Roots.** — The cotton plant is supplied with a tap-root, or continuation of the stem, from which the lateral roots branch. In deep, well-drained soil, the tap-root may go deep into the ground, but on shallow soil or on that in-

sufficiently drained, the tap-root often turns and grows in a horizontal direction on coming into contact with a dense or undrained subsoil.

Most of the lateral roots arise at points two to four inches below the surface of the ground. Hence, deep cultivation after the plant is several inches high results in the destruction of many of the lateral roots.

**233. Leaves.** — The leaves of cotton are alternate in position on the stem or branch. They vary somewhat in size and shape, even on the same plant. In American varieties, both of the short-staple and long-staple upland classes, the leaves are usually three-lobed, sometimes five-lobed. In these classes the spaces between lobes are usually shallow. Certain groups of varieties, chiefly the big-boll kinds, have large leaves with quite shallow indentation, and short, broad lobes. Other groups, notably those of the King and Peterkin types, have smaller leaves with slenderer, more sharply pointed lobes. Between these groups are all gradations in size and shape of leaves. In Sea Island cotton the lobes are very slender and the indentations very deep (Fig. 126).



FIG. 126. — COTTON LEAVES.  
a, upland ; b, Sea Island.

There are usually three (sometimes more) prominent veins or ribs in each leaf. On one or more of these on the under side of the leaf are glands that may easily be seen. The leaves of upland cotton are covered, especially on the lower side, with numerous short, inconspicuous hairs.

**234. Boll stems, or peduncles.** — Connecting the flower or boll with the branch is a short flower-stem (Figs. 121 and

122), ranging in American upland and long-staple upland varieties from one half an inch to about two inches in length. This varies somewhat with the variety, but varies still more in different parts of the same plant.

The boll stem should be of such length and diameter as will prevent its bending abruptly, thus preventing the most complete development of the boll.

It would probably be an advantage if the boll-stem should be of sufficient length and strength to cause the boll to hang with its tip downward, so that the leafy bracts might act against rain as a roof, thus increasing the "storm resistance" of the seed cotton. This, however, has not been proved; for increased length may lead to a greater amount of breaking of boll-stems, rather than to a normal drooping of the boll. It should be added that the abrupt bending of the boll-stem is often due to a specific disease, "black arm."

**235. Flowers.** — The three green parts, which together make the "square," are bracts or flower leaves, and serve to protect the flower bud. The blooms are large and pretty, their size and color varying in different species.

In American upland and long-staple upland, the bloom is a pale cream color on the morning that it opens. On the second day it changes to a pink or red and later falls. The flowers open early in the morning and close late in the same day. In Sea Island cotton, the young bloom has a more yellowish tint than the flower of upland cotton.

The pollen is heavy and waxy, and apparently it is carried almost entirely by insects. However, cotton is capable of self-fertilization, as shown by the fact that if a hundred flower buds be inclosed by paper bags, bolls containing seed will develop in most cases. It is probable that cross-fertilization tends to increased vigor. At least the

seed from artificial hybrids between upland American varieties have been found to be larger than the average of the seeds of the parent varieties. (Ala. Expr. Sta., Bul. No. 56.)

There are five conspicuous petals and five inconspicuous sepals, the latter united into a shallow cup around the base of the flower and boll. The pistil, or central part of the flower, is divided into from 3 to 6 divisions or stigmas. Three is the prevailing number of stigmas in Sea Island cotton and four or five in American upland varieties. The number is the same as the number of locks of seed cotton that will develop in that particular boll. The stamens are numerous and are grouped closely around the pistil just below the stigmas.

The pollen is released from the pollen-cases (anthers) several hours after sunrise, or about the same time that the stigma is in condition to receive it.

Two varieties of cotton readily cross by the carrying of pollen by insects from one flower to another. Webber has estimated that only about 5 to 10 per cent of the seed from two varieties grown near together produce hybrid, or crossed, plants.

*Glands.* — Glands, or minute organs secreting a sweetish substance, are found both on the flowers and leaves of cotton. In the flowers of American cottons there are glands at the base of the bracts and also at the base of the petals. On the under side of the leaves the glands occur on one or more of the mid-ribs or veins. The glands are probably means of attracting insect visitors and thus of increasing the amount of crossing between varieties or between individual plants of cotton.

**236. Bolls** (Fig. 127). — The pod containing the seed and lint is called the boll. In short-staple cotton, there



FIG. 127. — COTTON BOLLS.

On left, American upland ; in center, Sea Island ; and on right, Indian cotton.



are usually four or five divisions of each boll; the content of each division is called a lock. While upland American cottons, both long- and short-staple, have usually four or five locks, a boll of Sea Island cotton contains only three or four.

In tests made at the Alabama Experiment Station, bolls with five locks afforded a larger yield of seed cotton to the boll than did bolls having only four locks.

The number of bolls varies somewhat with different varieties, but is chiefly dependent upon conditions of fertility, rainfall, and climate. The number may vary between a few and several hundred on a single plant. A field averaging 50 mature bolls per plant usually makes considerably more than a bale of cotton (500 pounds of lint) per acre. Cotton plants of medium size, 3 to 5 feet high, are apt to be more heavily fruited in proportion to size than very large plants. Short internodes, or spaces between branches, are favorable to productiveness. An ideal cotton plant should have a number of nearly horizontal fruiting limbs, beginning near the ground, and continuing to arise at each node until considerably above the middle of the plant. Each fruiting limb on the lower part of productive plants should mature at least four bolls.

Cotton bolls of the Sea Island varieties are usually less than one inch in diameter, and of slender, tapering shape. Bolls of American upland cotton vary greatly in size and shape according to variety, and the character of soil and season. The diameter usually varies between  $1\frac{1}{4}$  and 2 inches, and in most cases the bolls are considerably longer than thick. Rich land and high fertilization, together with abundance of moisture, tend to increase the size of bolls.



FIG. 128. - A COTTON PLANT DEFICIENT IN STORM RESISTANCE.

Bolls of upland cotton are usually of such size that from 40 to 110 are required to make a pound of seed cotton.

When the boll ripens, it splits usually into four or five divisions, exposing the seed cotton. The parts of the pod, or bur, separate more or less completely. If they open wide and the outer walls of the burs curl backward, the seed cotton may be held so slightly that it is easily blown out by wind or beaten out by rain (Fig. 128).

**237. Storm resistance.** — The structure of boll most favorable to “storm resistance,” or persistence of the seed cotton in the bur, is the following: —

(1) A firm stiff wall, which on drying does not curl backward, but serves to support and protect the seed cotton (Fig. 129).

(2) Sufficient separation of the parts of the bur to make picking easy, but not enough to permit each lock to hang separately.

FIG. 129. — STORM-RESISTANT BOLL AND BURS ABOVE; BELOW, BOLLS AND BURS LACKING STORM RESISTANCE.

Below, the walls of the bur are rolled back, permitting the locks of seed cotton to separate and fall backward; above, the walls of the bur do not curve backward, but support the seed cotton in a compact mass.



(3) A drooping position of the boll, which is partly dependent upon the weight of the boll, partly on the length and stiffness of the boll-stem, and partly on the position of the cotton plant; that is, whether standing erect or bent down by the weight of bolls.

(4) The presence of large bracts, or leafy parts of the square, which may serve to shed some of the water and thus to prevent the complete saturation of bolls, and dropping of seed cotton from bolls borne in a drooping position.

**238. Lint.** — Each cotton fiber consists of a single elongated cell. The fiber may be thought of as a tube, which, while immature, is cylindrical throughout more than three fourths of its length; thence it tapers to the end farthest from the seed. But as the fiber matures, the tube collapses and becomes twisted, somewhat like a collapsed and twisted fire-hose. This twisting, which is most complete when the fiber is thoroughly matured, is highly desirable because it adds strength to the cotton thread or yarn by causing the fibers to cling together when twisted. The advantage of the twisting in preventing the slipping of fibers in a thread or cloth may be understood by considering how much more difficult it would be for two chains twisted together to slip past each other than it would be for two pieces of smooth wire.

Based chiefly on the amount of twisting, there are in every lot of cotton three kinds of fibers: (1) ripe, (2) partly ripe, and (3) immature. In immature fibers there is little twist; consequently these make weak thread or cloth. Moreover immature fibers do not uniformly and satisfactorily absorb the dyes used in the manufacture of colored

cloth. Therefore, to secure the best grade and price, bolls of cotton should not be picked until well opened, thus giving an opportunity for sun and air to mature the fiber.

The value of cotton fiber is determined by (1) length, (2) strength, (3) maturity, (4) fineness, and (5) uniformity. The longest fiber is usually the finest, and such fibers may be used in the manufacture of the finest, thinnest, and most expensive cotton fabrics.

The following are approximately average lengths of the fibers of the principal kinds of cotton:—

- Sea Island, 1.61 inches ;
- Egyptian, 1.41 inches ;
- American upland, 0.93 inches ;
- American long-staple, 1.3 inches.

The fiber is longest on the larger or upper end of the seed.

The average diameter of American upland short-staple cotton is  $\frac{1}{1500}$  to  $\frac{1}{1200}$  inch. The cotton fiber attains its maximum length before reaching its maximum diameter and strength.

Williams (N. C. Bd. Agr., Bul. Sept., 1906) found that in 12 varieties of cotton, the average weight required to break a single fiber was 6.83 grams. Hilgard found the extremes of breaking strength of cotton to be 4 and 14 grams. Cotton is about three times as strong as wool in proportion to the size of fiber. In a pound of Russell cotton there were calculated to be more than 15,000,000 fibers, which, if placed end to end, would make a line about 2000 miles long. Cotton fiber is prevented from readily absorbing moisture by an oily covering of each fiber, which is said by Monil to make up about 2 per cent of the weight of the fiber. Absorbent cotton represents cotton from which this oily protection has been removed by treatment with chemicals. The oily covering must be removed before the yarn can be dyed.

It is thought by farmers that if seed cotton be stored for some time before ginning, the proportion of lint will increase and that it will then make a better-looking sample. If this be true, there

is need for investigators to determine whether there is an increase in the weight of this oily covering during storage.

**239. Seed.** — There are usually 6 to 12 seeds in each lock of seed cotton, or from 28 to 50 seeds in a boll. In varieties with small seed, the number per boll is usually greater than in varieties having large seed.

The legal weight of a bushel of seed is usually either 32 or 33 $\frac{1}{2}$  pounds. A bushel may be regarded as containing about 135,000 seeds of average size.

A bushel of Sea Island cotton seed is usually assumed to weigh about 44 pounds. In the author's classification, upland cotton seed, averaging 13 grams per 100 seed, are considered as large; those weighing 10 to 13 grams per 100 seed as medium; and those weighing less than 10 grams per 100 seed as small.

The seed of most varieties of upland cotton are covered with a short, dense fuzz which may be white, greenish, or brownish. There are some exceptional varieties almost free from this fuzz or so thinly covered that the black seed-coat shows through. Sea Island cotton has naked black seeds, free from fuzz except on the tip end of some of them. Constant selection is necessary to prevent an increase in the fuzz on Sea Island cotton seed.

Within the tough hull of the seed is the "meat," which consists chiefly of two fleshy seed leaves (cotyledons) enfolding the embryo sprout and the embryo root.

In the entire seed the following figures represent approximately the usual proportions of the different parts: —

Linters, or short lint, removed at the oil mill . . .	10 per cent
Hulls . . . . .	40 per cent
Meats . . . . .	50 per cent

*Germination.* — When planted in the field in the spring under favorable weather conditions, germination usually occurs in seven to twelve days. Cotton seeds retain their power to germinate for several years. The seed leaves, or first two thick leaves that

appear, serve to nourish the plant before the appearance of true leaves.

**240. Stages in the life of flower and fruit.** — When the plant is about 40 days old, the first squares or flower buds may usually be seen. If planting is done in hot weather, the squares mature more quickly. Mercier reports that 21 days is the time from the first appearance of the square to the opening of the bloom. From the open bloom to the open boll the time varies according to the season of year and the variety. As a rule in very hot weather, 42 days is sufficient; while in the cooler weather of the early fall, 50 or more days may be required. Therefore, blooms appearing 50 days before the average date of frost in a given locality may be expected, under average weather conditions, to mature.

#### LABORATORY EXERCISES

(1) Tie a string to the lowest branch of a well-grown cotton plant and wind it spirally around the plant, in such a way as to touch the base of each branch. By repeating this on several plants determine the number of the branch from the bottom that is directly above the lowest branch.

(2) Make a record of how many times the string passes entirely around the stem in being wound spirally from the lowest branch to the one directly over it.

(3) Compare, as to earliness of maturing, several plants with long internodes on main stem and branches with others of the same variety having short intervals between limbs or leaves.

(4) Weigh the mass of seed cotton from 50 bolls each having 5 locks, and that from 50 4-lock bolls; record and compare the weights.

(5) Find 5 storm-resistant bolls or old burs, and write down the apparent reasons for the storm resistance of each.

(6) Pull and break a small number of fibers of immature but

dry lint and note how much less force is required to break these than to break fully matured cotton fibers.

## LITERATURE

- MELL, P. H. Ala. Expr. Sta., Bul. No. 13.  
WILLIAMS, C. B. N. C. Bd. Agr., Bul. Sept., 1906.  
ALLARD, H. J. The Fibers of Long-staple Upland Cotton. U. S. Dept. Agr., Bur. Plant. Ind., Bul. No. 111, Pt. II.  
WATT, G. The Wild and Cultivated Cotton Plants of the World. London, 1907.  
WEBBER, H. J., and BOYKIN, E. B. Cotton. Bailey's Cyclo. Agr., Vol. II, pp. 247-257.



## CHAPTER XV

### COTTON — COMPOSITION AND PRINCIPAL USES

OF course, the great usefulness of cotton lies in the lint or fiber. In fact, when one speaks of "cotton," he usually refers to the fiber rather than to the plant as a whole. There are other uses, however, that must be considered; and it is important to know the chemical composition of the parts.

**241. The lint.** — Cotton lint consists mostly of woody fiber (cellulose), which is formed chiefly from the carbon dioxide of the air. A bale of cotton (500 pounds of lint) contains only 1.7 pounds of nitrogen, half a pound of phosphoric acid, and 2.3 pounds of potash. If these substances be rated at their prices in commercial fertilizers, the plant-food removed in a bale of cotton would be worth only about 42 cents.

In selling only the lint the farmer removes from the soil a smaller amount of fertility than in growing any other American crop. When cotton lands decline in fertility, it is not because of the lint removed, but chiefly on account of the failure to rotate crops and thus to replenish the supply of vegetable matter.

**242. The seed.** — The seed of cotton, unlike the lint, is rich in nitrogen, phosphoric acid, and potash. Hence the sale of cotton seed removes large quantities of these forms of plant-food.

For example, 1000 pounds of seed, which is approximately the amount usually accompanying one 500-pound bale of lint, contains about 31 pounds of nitrogen, 13 pounds of phosphoric acid, and 12 pounds of potash. To replace this quantity of precious plant-food would require commercial fertilizers costing about \$6.25. The draft on the fertility of the land made by other parts of the plant are indicated in later paragraphs of this book.

**243. Composition of cotton products.** — The most valuable products of the cotton plant, next to the lint, are those made from the seed. In round numbers there are produced annually in the United States half as many million tons of seed as million bales of cotton. More than two thirds of the seed is used by the oil mills and less than one tenth for planting; the remainder is either fed directly as seed to live-stock, or else employed as fertilizer. The oil in the seed has no fertilizing value; hence more wealth is created when the oil mills use the seed than when the seeds are employed as fertilizer, provided the farmer buys enough cotton-seed meal or other forms of commercial fertilizer to restore to his land the plant-food removed in the seed. At prices prevailing in recent years, a dollar buys a larger amount of plant-food in the form of cotton-seed meal than if invested in cotton seed.

A ton of cotton seed ordinarily produces approximately the following results at the oil mills: —

	POUNDS
Oil (38 to 45 gallons), average about . . . . .	300
Cotton-seed meal, average about . . . . .	750
Cotton-seed hulls, average about . . . . .	800
Linters, average about . . . . .	30
Waste, sand, trash, and evaporation, average about . . . . .	120
Total . . . . .	2000

The food and fertilizer constituents contained in one ton of cotton seed and of a similar amount of *high-grade* cotton-seed meal are as follows:—

*Pounds of Food and Fertilizer Constituents in One Ton of Cotton Seed and of high-grade Cotton-seed meal*

	FOOD CONSTITUENTS			
	Cotton seed, 2000 lb.	Cotton-seed meal, 2000 lb.	COTTON SEED RICHER BY	COTTON- SEED MEAL RICHER BY
	Lb.	Lb.	%	%
Principal food constituents				
Protein . . . . .	397	846		113
Nitrogen-free extract . . . . .	469	472		1
Fat . . . . .	398	204	95	
Fiber . . . . .	451	112	303	
Fertilizer constituents				
Nitrogen . . . . .	63	113		79
Phosphoric acid . . . . .	25	54		116
Potash . . . . .	23	36		57

**244. Utilizing cotton-seed products.**— From the above table it may be seen that, regarded as food, and overlooking slight differences in digestibility, cotton-seed meal is much more valuable than cotton seed, having more than twice as much protein, but less fat and fiber.

In fertilizer constituents, high-grade cotton-seed meal is practically twice as rich in nitrogen and phosphoric acid, and more than 50 per cent richer in potash, than cotton seed.

The farmer may act on the general statement that he is making a nearly even exchange in plant-food when he brings back to his farm half a ton of cotton-seed meal for each ton of seed sold. But in food constituents, cotton-

seed meal is not twice as rich as cotton seed. The exchange values of these two foods will depend upon many conditions, especially the kind of roughage to be fed in connection with either, the purpose in view, and other matters that find a place in textbooks on feeding animals. In tests at the Mississippi Experiment Station, a pound of cotton-seed meal was in one case equal as food to 1.6 pounds of cotton seed, and in another case to 1.7 pounds.

In general, one may expect a ton of cotton seed to have the same feeding value as an amount of cotton-seed meal varying between 1250 and 1500 pounds.

**245. Composition of the different parts of the plant.** — The stems contain nearly one fourth of the dry matter, the leaves and seeds each a little more than one fifth, and the lint only one ninth of the total dry matter in the mature plant. The seed and lint, which are usually the only portions of the plant removed from the land, together constitute one third of the total weight of dry matter. However, the proportion of seed and lint to other parts of the plant varies widely according to the luxuriance of growth and other conditions. Doubtless the seed and lint together often constitute less than one third of the total weight of the plant.

The above statements are based on the following figures, giving the average results of a chemical study of the different parts of the cotton plant as made by B. B. Ross at the Alabama Experiment Station (Bulletin No. 107), and by J. B. McBryde at the South Carolina Experiment Station. (See Bul., Vol. IV, No. 5, Tenn. Expr. Sta.)

These figures show the amounts, and proportions by weight, of the different parts of the mature dry cotton plants growing on an acre where the yield of lint is 300 pounds: —

	POUNDS DRY MATTER PER ACRE	PER CENT OF TOTAL WEIGHT OF DRY PLANT
Seed . . . . .	580	21.77
Lint . . . . .	300	11.35
Roots . . . . .	190	7.03
Stems . . . . .	631	23.80
Leaves . . . . .	571	21.58
Burs . . . . .	344	14.55
Seed and lint combined .		33.12

**246. Amounts of nitrogen, phosphoric acid, and potash in the different parts of the cotton plant.** — The following table shows that to produce a crop of 300 pounds of dry lint and the other parts associated with this amount of fiber there was required about 42 pounds of nitrogen, 13 pounds of phosphoric acid, and 35 pounds of potash. The figures are reached by averaging the analyses made by Ross and McBryde, and are here given merely for reference: —

*Amounts of Fertilizer Constituents required to produce a Crop of 300 Pounds of Lint*

	DRY MATTER PER ACRE LB.	NITROGEN LB.	PHOSPHORIC ACID LB.	POTASH LB.
Lint . . . . .	300	0.63	0.23	2.00
Seed . . . . .	580	19.01	6.88	6.68
Burs . . . . .	344	3.75	1.44	11.71
Leaves . . . . .	571	13.25	2.64	6.35
Roots . . . . .	190	1.21	0.36	1.96
Stems . . . . .	631	4.52	1.25	6.44
Total . . . . .	2656	42.37	12.80	35.14

**247. Uses.** — Cotton is used to a greater extent than any other vegetable fiber for clothing. Wool is the only

other fiber that approaches cotton in the extent of use for this purpose. Cotton is adapted to the manufacture of a greater variety of textile fabrics than any other fiber. When it is treated with certain chemicals, or mercerized, the fabric takes on a glossy appearance and becomes a fair imitation of silk.

One reason why cotton is so much more extensively used than linen, jute, and other vegetable fibers is found: (1) in the readiness with which cotton fibers absorb dyes, and (2) in the peculiar twisted structure of its fibers, so favorable to ease of spinning and strength of thread.

The seed constitute a valuable food for cattle and sheep. They are usually fed raw, though sometimes boiled when fed to dairy cows. After the seed are ground in the oil mills, the hulls are separated and used as cattle food.

From the "meats," or hulled and ground seed, cotton-seed oil is expressed by means of powerful hydraulic presses. This oil finds use as a human food, especially as a constituent of compound lard, oleomargarine, salad oils, etc., as a lubricant, as a constituent of paint, in the manufacture of soap, and in almost all ways in which other oils are employed. After the extraction of the oil, the residue constitutes one of the most nutritious of foods for cattle and sheep. It is fed either in the form of cake (lumps), or more frequently this cake is first ground, thus forming cotton-seed meal, which is one of the most valuable foods for cattle. Large amounts of cotton-seed meal are also used as fertilizer.

Cotton-seed meal as a foodstuff is chiefly used for cattle and sheep. It exerts a specific toxic effect on hogs when fed in quantity for a certain length of time. Ill effects are

seldom observed in less than four weeks, and they are usually shown in the periods between the thirtieth and fortieth day after the feeding of cotton-seed meal is begun. Fermenting the meal seems to decrease this danger, as probably does also the feeding of green or succulent food at the same time. Cotton-seed meal is injurious to young calves, and probably to most very young animals.

### LABORATORY EXERCISES

From the tables on page 271 calculate for an acre producing 500 pounds of lint what would be the probable weight of

(a) dry stems, or stalks;

(b) the number of pounds of nitrogen lost if the stalks, roots, and burs of a crop of this size be burned, assuming that these parts of the plant increase at the same rate as the yield of lint.

### LITERATURE

ROSS, B. B. Ala. Expr. Sta., Bul. No. 107, pp. 369-402.

HUTCHINSON, W. L., and PATTERSON, L. G. Miss. Expr. Sta.,  
Tech. Bul. No. 1.

SHIVER, F. S. S. C. Expr. Sta., Bul. No. 47.

McBRYDE, J. B. Tenn. Expr. Sta., Bul., Vol. IV, No. 5.

KILGORE, B. W. U. S. Dept. Agr., Office Expr. Sta., Bul. No. 33.

## CHAPTER XVI

### COTTON — THE PRINCIPAL SPECIES

COTTON may be annual or biennial, according to the particular species, and dependent upon the climate in which the plant grows. As cultivated in the principal cotton-producing countries, all the important species of cotton are annuals, maturing seed before cold weather, and being killed by frost. In very warm countries, plants of some species live for a number of years. This tendency toward a perennial habit still exists in the cotton grown in the United States, as is evident from its throwing out, after a mild winter, shoots from the roots or stem of the preceding year.

**248. Family and genus.** — The cotton plant is one of the Mallow family (*Malvaceæ*). This family also includes okra; a number of cultivated flowers, as, hollyhocks, hibiscus, and althea or "Rose of Sharon"; a considerable number of not very troublesome weeds; and certain plants the bark of which affords useful fiber. The Mallow family includes both herbs and shrubs or trees. All the plants within it have flowers with five petals and numerous stamens, the supports for the stamens forming a tube around the pistil; there are usually several leaf-like parts (bracts) just below and around the flower, three of these forming in cotton what is known



as the square. The leaves are alternate, and the veining of the leaves begins at a common point near the base of the leaf blade; that is, the leaves are palmately veined.

The genus, or subdivision of a family, to which the cotton plant belongs, is *Gossypium*. In this genus the stigmas, grown together, usually number three to five, according to the number of locks which will be contained in the mature fruit or boll. The leaves are lobed, the size and shape of the lobes varying in the different species.

**249. Principal species of cotton.** — Botanists differ widely as to the number of species of *Gossypium* and as to the name that should be applied to certain species. Moreover, some cultivated cottons are crosses or hybrids between two species, thus increasing the difficulty of properly naming each kind. For example, until recent years it was customary to refer to the present commonly grown upland cotton of the United States as *Gossypium herbaceum*, a name now given to one of the Asiatic cottons. Watt ("Wild and Cultivated Cotton Plants of the World") assumes that for a time the early colonists did grow this species in Virginia, but that before cotton became an important crop it was displaced by the present type of American upland cotton; the former, he thinks, still influences American upland cotton through its hybrids. The latest investigators favor the name *Gossypium hirsutum*, to include both the ordinary or short-staple cotton of the United States and also the long-staple upland cotton of this country.

As many as fifty-four species of *Gossypium* have been described and named, but most botanists reduce the species to a much smaller number.

The following may be regarded as the species most important to the world's agriculture, commerce, and manufacture.

#### American group.

(1) *Upland* cotton (*Gossypium hirsutum*). This is the ordinary cotton of the southern part of the United States, including the long-staple class.

(2) *Sea Island* cotton (*Gossypium barbadense*; so named from the Barbadoes Islands). This affords the finest, longest, and most valuable of all cotton fibers.

(3) *Peruvian* cotton (*Gossypium peruvianum*). Its importance is not due to its cultivation in its home in Peru, but to its having become the principal cotton of Egypt. Although transplanted to Asia, it retains a closer kinship to American than to true Asiatic cottons.

#### Asiatic group.

(4) *Indian* cotton (*Gossypium obtusifolium*; so named from the lobes or divisions of the leaves being rounded or obtuse) includes the best grades of Indian cotton, often called in commerce Broach or Surat cotton.

(5) *Bengal* cotton (*Gossypium arboreum*) is another important cotton of India.

The members of the American group, including Sea Island, ordinary upland, and Egyptian, cross freely among themselves. Most Asiatic kinds also cross freely among themselves. However, Gammie<sup>1</sup> in his experiments found that the American cottons did not cross with those of the Asiatic group. While there is undoubtedly difficulty in

<sup>1</sup> Gammie, "The Indian Cottons." Calcutta.

making most crosses between the American and Asiatic groups, Watt maintains that such crosses are possible.

**250. American upland cotton.** — This constitutes all of the cotton crop of the United States except the small amount of Sea Island cotton grown near the South Atlantic and Gulf coasts. It forms the largest single item of export, and brings into the United States more money than any other crop or single line of manufacture.

American upland cotton may be divided into two principal classes: (1) short-staple varieties and (2) long-staple varieties. The chief distinction between these is in the length of lint, that of short-staple being usually  $\frac{3}{4}$  to  $1\frac{1}{8}$  inches, while long-staple, or "staple cotton," usually has a length of  $1\frac{1}{4}$  to  $1\frac{5}{8}$  inches.

Between these two groups, which are somewhat sharply distinguished from each other, lies an intermediate class. The

cottons of this class are called commercially "Benders" or "Rivers." These names arise from the fact that this intermediate kind is grown chiefly on moist bottom land. Such soil has a tendency to lengthen the staple even of a short-staple variety. Moreover, there are varieties having intermediate lengths of lint, even when grown on upland.



FIG. 130.—VARIOUS SHAPES OF COTTON BOLLS.

On left, Sea Island; in center, a typical long-staple; and on right, a typical short-staple of the big-boll class.

There are usually other differences between long- and short-staple cotton, though these are by no means universal distinctions. As a rule the long-staple cotton plant is late in maturing, tall, and supplied with bolls that are slenderer and more sharply pointed than is the case with most short-staple varieties (Fig. 130). Long-staple cotton



FIG. 131.—A SEA ISLAND COTTON PLANT.

invariably has a lower percentage of lint ; the yield of lint is less, frequently below 80 per cent of that yielded by short-staple varieties on the same grade of land.

The difference in price between long- and short-staple cotton varies greatly from year to year. Generally this

difference, or premium, for long staple is between 3 and 5 cents per pound of lint.

251. **Sea Island cotton** (Fig. 131). — This cotton is grown only in limited areas on or rather near the seacoast in South Carolina, Georgia, and Florida. It is generally

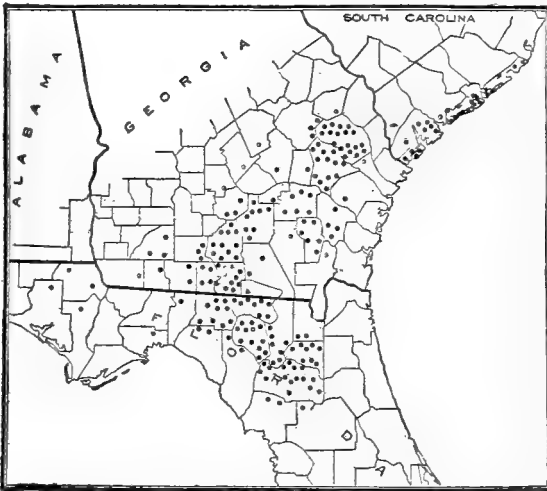

FIG. 132. — WHERE SEA ISLAND COTTON IS GROWN.

Each dot stands for an annual yield of 500 bales.

regarded as a profitable crop only within a distance of about 100 miles from the coast (Fig. 132).

The Sea Island cotton plant is distinguished from upland cotton chiefly by the following characteristics: —

(1) A taller plant, with longer, slenderer branches, and later maturity;

- (2) Leaves with much longer and slenderer lobes ;
- (3) The absence of hairs from leaves and stems ;
- (4) The yellowish color of the fresh blooms and the presence of red spots near the base of each petal ;
- (5) The much smaller, slenderer boll, with usually only three, or sometimes four, locks ;
- (6) The longer, finer fiber and the naked black seed nearly or quite free from fuzz.

The usual length of fiber is  $1\frac{1}{2}$  to 2 inches. In quality Sea Island cotton is fine and silky. It is used in the manufacture of the most expensive cotton fabrics, such as laces, fine hosiery, and lawns.

In recent years some grades of Sea Island cotton have commanded a price above 35 cents per pound, and especially fine strains a still higher figure.

**252. Peruvian and Egyptian cotton.** — True Peruvian cotton, including the leading varieties now grown in Egypt, have a brownish lint. The fiber of Egyptian cotton is longer than that of American upland long staple but shorter and less valuable than that of the Sea Island. It is an interesting fact that, though the United States exports millions of bales of upland or short-staple cotton, American manufacturers find it necessary to import annually about 150,000 bales of Egyptian cotton. This is because Egyptian cotton is needed for special purposes; for example, it is the kind best suited to the chemical treatment known as mercerization, by which a silky luster is imparted. Mercerization consists in treating the fiber with a solution of caustic soda, washing it, then treating the fiber with dilute sulphuric acid, and again washing it.

Some varieties of Egyptian cotton have white lint and

seem to be hybrids descended in parts from the American Sea Island species.

**253. Asiatic cottons.** — The cotton grown in India and elsewhere in Asia is less productive and has a shorter fiber than American short-staple cotton. The colors of the flowers are various, and the forms of plants and of the leaves differ from those of any of the American groups.

### LABORATORY EXERCISES

1. Make a drawing showing the stamens and stigmas of a cotton flower, after removing the bracts and petals.

2. If specimen plants of Sea Island cotton can be had, or if the seed and lint can be obtained, compare them with the corresponding parts of American upland cotton.

### LITERATURE

DEWEY, L. H. U. S. Dept. Agr., Yearbook, 1903, pp. 388-390.

EVANS, W. E. U. S. Dept. Agr., Office Expr. Sta., Bul. No. 33, pp. 67-76.

WATT, G. The Wild and Cultivated Cotton Plants of the World. London, 1907.

GAMMIE, G. A. The Indian Cottons. Calcutta, 1905.

## CHAPTER XVII

### COTTON — VARIETIES OF AMERICAN UPLAND

THERE are many hundred names to represent varieties of cotton. The Alabama Experiment Station has tested more than two hundred of these so-called varieties and has found that a large proportion of them are merely synonyms. However, it is probable that the number of distinct varieties, each differing from the other in one or more items of agricultural or botanical importance, exceeds one hundred.

**254. Reasons for variation.** — Among the causes which have led to this multiplication of varieties are the following: —

(1) Modifications of the plant resulting from continuous selection, or from special soil and climatic conditions;

(2) Artificial crosses intentionally made with a view to creating new varieties combining some of the qualities of both parents;

(3) Natural hybrids resulting chiefly from the carrying of pollen by insects from the flowers of one variety to the stigmas of another;

(4) Names have been needlessly multiplied, both intentionally and unintentionally, so that some varieties may be purchased under half a dozen different names.

**255. Varieties of cotton not easily recognized.** — The differences between the numerous agricultural varieties



are so slight that even an expert is unable to identify with certainty any but those varieties having the most definite characteristics. Indeed, the description of any variety will not apply to all the plants in it, but is to be taken rather as a general or average portrayal.

**256. Classification of varieties.** — The study of varieties may be much simplified by arranging them in a small number of groups, as is done in the subjoined scheme of classification. The American upland short-staple cottons may be divided into six classes; to this is added a seventh division to include short-staple varieties of a character intermediate between any other two groups. An eighth group differs from all the others because its members possess a long staple.

Group 1. — Cluster type.

Group 2. — Semicluster type.

Group 3. — Rio Grande type, of which the Peterkin is an example.

Group 4. — The early varieties of the King type.

Group 5. — The Big-boll type.

Group 6. — The Long-limbed type.

Group 7. — Intermediate varieties.

Group 8. — Long-staple Upland varieties.

The lines of separation between these groups are not distinct; one group gradually merges into another.

**257. Cluster group.** — The varieties belonging here are easily distinguished, (1) by the extreme shortness of the fruit limbs in the middle and upper parts of the plant (Fig. 133), and (2) by the tendency of the bolls to grow in clusters of two or three (Fig. 134). The few base limbs are usually long. The plant in general possesses an ap-



FIG. 133.—A COTTON PLANT OF THE CLUSTER TYPE.

pearance of slenderness or erectness. The bolls are usually small; the seeds are small to medium in size and thickly covered with fuzz.

On account of the peculiar shape of plant, cluster varieties may be left thicker in the drill than most other kinds.

This class of cotton is much less popular now than formerly. This is probably due to the deficiencies usually found in cluster cotton; namely:—

(1) A special tendency to shed or drop a large proportion of the fruit when conditions of soil and weather are unfavorable;

(2) The small size of boll; and

(3) The large proportion of trash which must usually be included with the seed cotton when picking, — this trash consisting largely of the bracts, which at an earlier stage formed the square. Examples of cluster varieties are Jackson and Dickson.

**258. Semicluster group.** — The varieties of this class present somewhat the appearance of cluster cottons, but the fruiting limbs in the middle of the plant are of short to medium length (Fig. 135). The bolls, while close together, are not borne in clusters. This characteristic is sometimes united with the qualities found in other groups, in which case the variety is classed, not as a semicluster, but in accordance with its other striking characteristic.



FIG. 134. — A FRUITING LIMB OF A CLUSTER COTTON PLANT.

Showing four bolls; also a branch terminated by a boll, and hence not capable of further growth.



FIG. 135.—A COTTON PLANT OF THE SEMICLUSTER TYPE.

There is much diversity among the semiclustertypes in size of boll, size of seed, and percentage of lint.

Among semiclustertypes are Hawkins and Poulnot.

**259. Rio Grande group.** — This is named for one of the earlier varieties, which had almost the same characteristics as the Peterkin,

now so extensively grown. Among the distinguishing marks of this group are (1) a large proportion of lint, usually 35 to 40 per cent of the weight of the seedcotton, and (2) small seeds, many of which are nearly naked; that is, thinly covered



FIG. 136. — THE PETERKIN TYPE OF COTTON PLANT.

with short fuzz, so that the seeds appear dark or even black.

The leaves are, as a rule, smaller and supplied with narrower, more sharply pointed lobes than in the case of many other varieties. The bolls are small to medium and the seed small to very small. The branches are usually slender and rather straight, and either medium- or long-jointed (Fig. 136).

**260. The Early King-like group** (Fig. 137). — The plants are small to medium in size. The fruit limbs, even near



FIG. 137. — A COTTON PLANT OF THE KING TYPE.

the top of the plant, are long, slender, and often crooked. The vegetative branches at the base of the plant are short or wanting. The bolls are small. The leaves are similar to those of the Rio Grande group. The seeds are usually small and covered with fuzz of various shades. A large proportion of the blooms

are marked with red spots near the inner base of each petal. The King and its synonyms and related varieties constitute the earliest of the commonly grown American upland cottons.

The chief faults of these varieties are the small size of boll, the short fiber, and the tendency of the seed cotton to fall from the burs.

**261. The Big-boll group.** — The one characteristic serving to identify the varieties of this group is the large size of the boll. While the size of boll varies with many conditions, an arbitrary division must be made somewhere; hence, in this scheme of classification, bolls are considered large if sixty-eight or fewer mature bolls yield one pound of seed cotton. This group may be further subdivided into the following overlapping subdivisions: —



FIG. 138. — A COTTON PLANT OF THE BIG-BOLL STORM-PROOF TYPE.

- (1) Storm-proof big-boll cottons (Fig. 138);
- (2) Big-boll varieties having plants of the shape that characterizes the semicluster group; and
- (3) Ordinary big-boll varieties having neither marked storm resistance nor semicluster shape of plant..

Examples of storm-proof big-boll cottons are Triumph, Rowden, and Texas Storm-proof. Among the semicluster big-boll varieties are some strains of Truitt, Bancroft, and individual plants of a number of big-boll varieties.

Among big-boll varieties of the third subdivision are the widely grown Truitt and Russell, the latter having green seed. Here, too, belong Cleveland and Cook, two very productive varieties, the bolls of which are sometimes scarcely large enough to admit these varieties into the big-boll class, where they usually belong.

**262. The Long-limbed group.** — In this class the plants grow to large size and have long limbs with long internodes; that is, they are “long jointed.” Apparently this is a disappearing class, represented chiefly by unimproved cotton. No existing variety of notable productiveness is included in this group.

**263. The Intermediate group.** — This group is provided merely as a matter of convenience to include varieties that are too nearly halfway between any other two groups to be assigned to one of them.

**264. The Long-staple Upland group** (Fig. 139). — The superior length of staple is the distinguishing characteristic of this group. The lint usually measures  $1\frac{1}{4}$  to  $1\frac{1}{2}$  inches. The percentage of lint in the seed cotton is low, usually less than thirty-one. Examples of this group are Allen Long-staple, in which the plants are tall and usually of a semi-



cluster shape. The bolls of Allen Long-staple are slender and small, and the seed are densely covered with white



FIG. 139.—A COTTON PLANT OF THE LONG-STAPLE UPLAND TYPE.

fuzz (Fig. 140.) Other examples are Griffin, which has a very long but weak lint, and bolls that are above the average in size for long-staple varieties.

On upland soils the long-staple varieties are usually less productive than short-staple cottons and afford a lint shorter than that produced on moist, rich, bottom land. However, the Blue Ribbon, a variety resulting from a cross between a long-staple upland and a short-staple kind, has proved well adapted to upland soils, especially in the Piedmont Region of the northern part of South Carolina. The chief fault of the last-named variety is its special liability to injury from boll-rot (anthracnose, see Par. 386).

**265. Productiveness of varieties.**—The most important fact brought out by a study of the numerous tests of

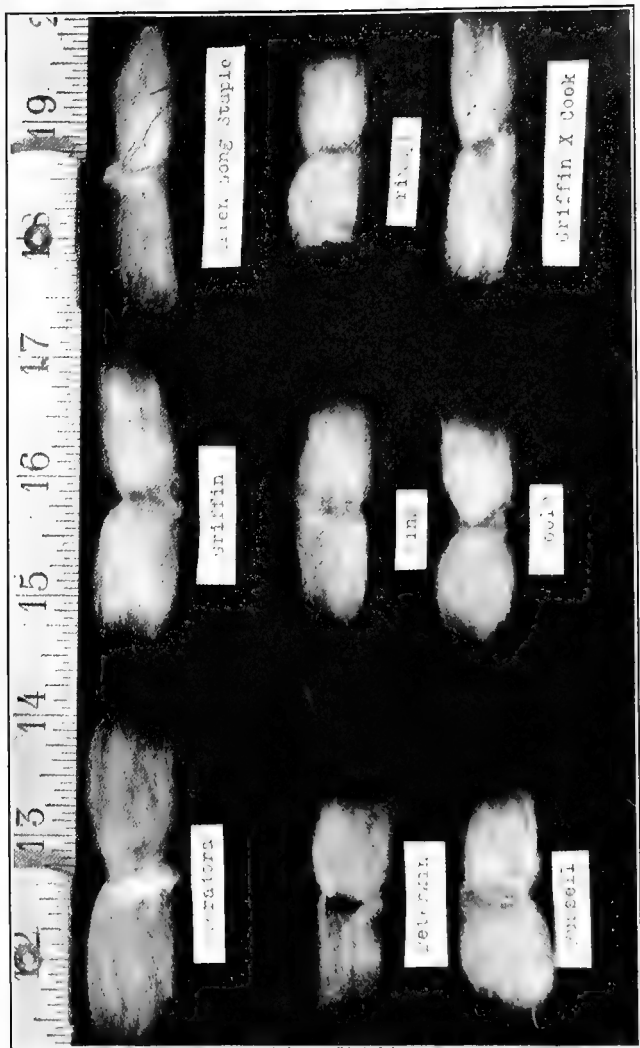

FIG. 140.—FIBERS OF SEVERAL VARIETIES OF COTTON.

Those in the upper row are long-staple ; the specimen on the right, below, is a hybrid between long- and short-staple varieties.

varieties of cotton made at all of the Experiment Stations within the cotton-belt is that there is no one variety that has proved most productive for all conditions of soil and climate. The reason for this is easily seen. A very early variety is usually the best for the extreme northern portion of the cotton-belt, because of the shortness of the season there; but this same variety, if carried farther south, is usually surpassed in yield by later varieties, which continue to make fruit through a longer season. Moreover, it is apparently true that varieties originating on one class of soil are placed at a disadvantage when tested on a widely different type of soil.

At the Alabama Experiment Station, the varieties which in recent years have usually taken highest rank in yield of lint per acre are Cleveland, Cook Improved, Toole, Layton, and Poulnot. It is notable that Cleveland, Cook, and Toole have also occupied high positions in tests made in Georgia and in several different parts of Mississippi. Cook has made a good record also in several localities in North Carolina.

**Leading varieties at Southern experiment stations.** — The following table makes mention of those varieties which have, as a rule, taken high rank in yield of lint per acre at the experiment stations in the cotton-belt: —

*List of Varieties making Largest Yields of Lint per Acre at Experiment Stations through a Number of Years*

Alabama (Auburn)	Cook Improved
	Toole
	Cleveland
	Layton
	Poulnot
	Jackson

Alabama (Canebrake)	Truitt Russell Peerless Peterkin
Georgia	Cook Improved Layton Cleveland Toole Jackson Jones Re-improved Peterkin King
Louisiana (Baton Rouge and Calhoun) (Boll weevil present)	Simpkins King Toole Triumph Ruble
Mississippi (Agricultural College Station)	Cleveland Cook Lewis Prize Hawkins Russell King
Mississippi (McNeil Substation)	Cook Toole Cleveland King Peterkin
Mississippi (Delta Substation)	Cleveland Lewis Prize Cook Triumph

North Carolina (Edgecomb, in Coastal Plain)	Cook Russell Culpepper Peterkin
North Carolina (Piedmont Region)	King Cook Shine Edgeworth
North Carolina (Red Springs)	Culpepper Excelsior King Russell
South Carolina (Clemson College Station)	Toole Texas Oak Bates Improved Peerless
South Carolina (Greenville, 3 years)	Texas Wood Peterkin Truitt
South Carolina (Columbia, 1883-1888)	Duncan Mammoth Jones Improved Dickson
South Carolina (Darlington, in Coastal Plain)	Peterkin
Texas (College Station)	Excelsior Triumph Beck Big-boll Bohemian Peterkin Texas Oak Sure Fruit Lowry

*Descriptions of Prominent and Typical Varieties*

*Jackson.* — The Jackson variety is one of the tallest and slenderest of the cluster group. It has also been known as African and Limbless, neither of which is correct; it did not originate in Africa, as once claimed, and only a small proportion of the plants lack the long base limbs.

The bolls are small, closely clustered, and very difficult to pick. These constitute the chief objections to this variety, which is quite productive, especially when the plants are crowded rather closely, and this can be done with this erect variety to a greater extent than with long-limbed kinds. The percentage of lint is above medium. The seed is fuzzy, of medium to small size, and usually covered with a brownish gray fuzz.

*Hawkins.* — This variety is typical of the semicluster group. It is rather early in maturity. The bolls are small to medium and the percentage of seed cotton medium.

*Peterkin.* — This variety is a type of the Rio Grande group, having some seed that are nearly naked or slightly covered with fuzz, which is often of a brownish tint. The plants are of medium size, abundantly supplied with branches. The percentage of lint is high, the size of bolls small, and the size of seed very small. This is one of the most widely grown varieties and is usually satisfactory in yield. As regards maturity, it is medium to late.

*Layton.* — This variety is similar to Peterkin except in having a smaller proportion of naked seeds and a thicker covering of grayish fuzz on most of its seeds. In several recent tests at Experiment Stations it has afforded a larger yield of lint per acre than Peterkin.

*Toole.* — This variety bears many points of resemblance to Peterkin and some resemblance to King. It is earlier and usually somewhat more productive of lint than Peterkin. The plant is of medium to small size and well suited to intensive fertilization (Fig. 141). It is one of the few varieties which generally in recent years have stood near the top of the list in productivity in most of the Experiment Stations where it has been

tested. Its chief weakness is the small size of the bolls. The percentage of lint is high and the size of seed small.

*King.* — This variety, like all the others of the same group, is distinguished by its extreme earliness, by the small size of the



FIG. 141. — A PRODUCTIVE COTTON PLANT OF THE TOOLE VARIETY.

plant, and by the occurrence in some blooms of red spots near the base of each petal. Near the northern edge of the cotton-belt this is one of the most prolific varieties, but elsewhere it is usually surpassed in yield of lint by later cottons. The chief objections to this variety are the readiness with which the seed cotton falls from the bur to the ground and the small size of bolls.

*Russell.* — This is one of the most widely grown varieties in

the central and southern parts of the cotton-belt. It is a big-boll cotton with very large leaves. It is characterized by the green color of most of its seed.

The bolls are large and do not readily drop the seed cotton. The seeds are large and the percentage of lint is low. The yield of lint per acre is usually satisfactory, but not exceptional. This variety is late and therefore, in the presence of the boll-weevil, likely to decline in popularity.

*Truitt.* — This is a typical big-boll variety with many of the plants assuming the semicluster form. The seeds are large and usually covered with grayish fuzz. *Truitt* is widely grown.

*Triumph.* — This variety was developed in the southern part of Texas from a cotton of the storm-proof group. Its special claim to prominence is its earliness combined with the large size of boll. This variety is very popular in Texas in the presence of the boll-weevil and has given general satisfaction to farmers east of the Mississippi River, where, however, its percentage of lint seems to be lower than nearer its place of origin. This variety combines a number of good qualities, namely relative earliness, large size of boll, and at least fair productiveness.

*Cleveland.* — This is a big-boll variety, though scarcely typical of that group, nor are the plants entirely uniform. Its special points of merit are the very high rank in yield of lint per acre which it has taken in most of the Experiment Stations where it has been tested, and its earliness, which is greater than that of most big-boll varieties. Its worst fault is the tendency of the seed cotton to fall from the bur. It appears to be promising for boll-weevil conditions.

*Cook Improved.* — The bolls of this variety are barely large enough to place it in the big-boll class. The plants are somewhat variable in form and appearance. The special merits of this variety are its earliness, its high percentage of lint, and the very high rank in yield of lint per acre which it has taken in most tests at the Experiment Stations. Its greatest fault is its special tendency to be injured by cotton boll-rot (anthracnose). A less notable fault is its lack of storm-resistance. The seed are small and rather thinly covered with a grayish fuzz.



*Allen Long-staple.* — The plant is tall with long, rather upright base limbs; the appearance is often that of a semicluster plant. The bolls are small, rather long and slender. The lint is long and fine, but the percentage is low. The seeds are covered with white fuzz. This is a standard variety in the Mississippi Delta.

*Griffin.* — This long-staple variety differs from many others of the same class in having larger bolls and somewhat longer limbs. However, the lint is weak.

*Blue Ribbon.* — This is a long-staple variety originated at the South Carolina Experiment Station and adapted to the northern and central portions of the cotton-belt. The length of staple is not equal to that in the Allen variety. The plant is of the semicluster shape. The percentage of lint is somewhat above that of most long-staple varieties. The greatest weakness of the Blue Ribbon is its susceptibility to boll-rot.

### LABORATORY EXERCISES

1. Write descriptions of at least five varieties of cotton, if available, noting especially shape of plant, size and shape of bolls, relative earliness, and colors of seed.

2. Ascertain the opinions of several farmers as to which varieties are thought to make the largest yields of lint in the locality of the school or near the pupil's home, and report in writing.

3. Students in advanced classes should make a detailed study of an additional number of varieties; and of the records of varieties as tested at their State Experiment Station.

### LITERATURE

DUGGAR, J. F. Ala. Expr. Sta., Buls. Nos. 107 and 140.

HARPER, J. N. S. C. Expr. Sta., Bul. No. 123.

MACNIDER, G. M., and others. N. C. Dept. Agr., Bull. Feb., 1909, pp. 37-63.

NEWMAN, C. L. S. C. Expr. Sta., Bul. No. 140.

TRACY, S. M. U. S. Dept. Agr., Office Expr. Sta., Bul. 33, pp. 197-224.

TYLER, F. K. U. S. Dept. Agr., Bur. Plant Ind., Bul. No. 163.

## CHAPTER XVIII

### COTTON BREEDING

AN important part of crop-growing is to maintain the excellence of types and varieties, and to improve the plants by constant attention to approved methods of breeding. Cotton is no exception to this rule.

**266. Deterioration of cotton is easy.** — A large proportion of the farmers of the cotton-belt plant impure, mixed, and otherwise inferior cotton seed. Even where a start is made with a pure variety the cotton usually “runs out,” or deteriorates, in a few years. This is not because soil or climate is unfavorable; the depreciation in productiveness and quality is generally due to one or more of the following reasons: —

(1) Failure to select plants as carefully for seed as did the person who originated or improved the variety;

(2) Mixing of the seed at public gins with inferior seed;

(3) Cross-pollination by insects bringing pollen from inferior varieties or from unimproved (scrub) cotton;

(4) The planting of seed obtained in the last picking, many of which are immature, light and defective, or from late, poor plants.

Nowhere in the cotton-belt is there any necessity for short-staple cotton to deteriorate. If it does become less valuable, the cause will be found in want of due care to secure good seed for planting.

**267. Improvement of cotton seed profitable.** — A study of the results of any tests of varieties of cotton reveals a wide difference between the yields of the most productive varieties and of the least productive. The difference is even greater between common or unimproved cotton and the best varieties. It is probably safe to estimate that a suitable improved variety will, as a rule, yield at least 20 per cent more lint per acre than will unimproved or scrub cotton.

**268. Crossing vs. selection as a means of improving cotton.** — In improving cotton or any other plant, reliance is placed on selection or on hybridizing, or on a combination of both of these processes. Selection attains the quickest results, especially if a beginning be made with an established variety. Selection is the only process that farmers, as a rule, need to practice.

Crossing of two widely different individuals or varieties is sometimes performed in the hope of uniting in the offspring the good qualities of both. The chances are much against securing this desired combination in the majority of the plants of the progeny; even when the combination is secured in one plant, it is not inherited by the majority of its offspring.

After a cross is made, the plants grown from such crossed seed must be carefully selected for a number of years before there is much uniformity between the different plants. One need scarcely expect the type to become well fixed in less than five years after making the cross. Therefore, crossing is scarcely practicable for most farmers; but it can be used to a limited extent by a plant-breeder, that is, by one who devotes a large proportion of his time to the improvement of plants.

**269. Directions for crossing cotton.** — Near sunset the pollen-cases (anthers) are removed from large flower-buds that would open the next morning. The removal of the anthers is most conveniently done by cutting away the greater part of every petal, and then carefully removing every anther, either with a small pair of pincers, a small pair of scissors, or with the blade of a pocket knife, taking care not to bruise the pistil around which the stamens grow. The anthers when removed are still closed; if any have begun to drop their pollen, the bud is too far advanced for crossing. As soon as the anthers are taken out, a small paper bag is pinned or tied over the mutilated flower to keep insects from bringing to the stigma the pollen from some unknown cotton plant.

Next, choose the plant that is to furnish the pollen, and over its buds, nearly ready to open, tie a paper bag to exclude insect visitors. The next morning, usually about nine o'clock, the stigma on the mutilated flower will be ready to receive the pollen from the chosen sire plant. This readiness will be shown by the stickiness of the upper portion of the pistil, that is, the stigmas. At about the same time that the stigmas become receptive, the anthers in other flowers will have begun to burst, setting free their pollen.

There are several methods of placing the pollen on the flower from which the anthers have been removed. One way consists in simply pulling the entire flower bearing the pollen, and rubbing its anthers lightly over the stigmas of the mutilated bloom, until some of the grains of pollen are seen to adhere to all sides of the pistil. Then the paper bag is again placed in position, to be left over the muti-

lated flower for about five days, or until a young boll has developed. This boll must be carefully labeled by means of a small tag, so that at harvest time the crossed boll may be distinguished from others.

**270. Variation and selection.** — The different individual plants within a single variety differ considerably (Figs. 142 and 143). Still greater is the

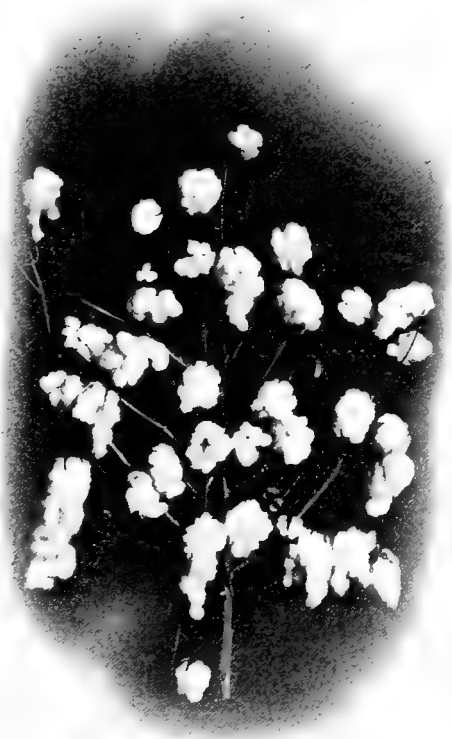

FIG. 142. — A PRODUCTIVE COTTON PLANT.

divergence between individual plants of unimproved cotton. This tendency to vary makes constant improvement possible. For as long as a few plants are distinctly superior in any quality to the majority of plants, there

is the possibility of bringing the average much nearer to the standard of the best plants.

It is highly desirable that any pure variety of cotton should possess the maximum degree of uniformity among the individual plants. This uniformity is much more quickly and completely secured by beginning with a variety already considered as pure. Hence any person desiring to improve cotton should first of all become familiar with the best varieties, and among these he should choose for improvement that one which possesses the greatest number

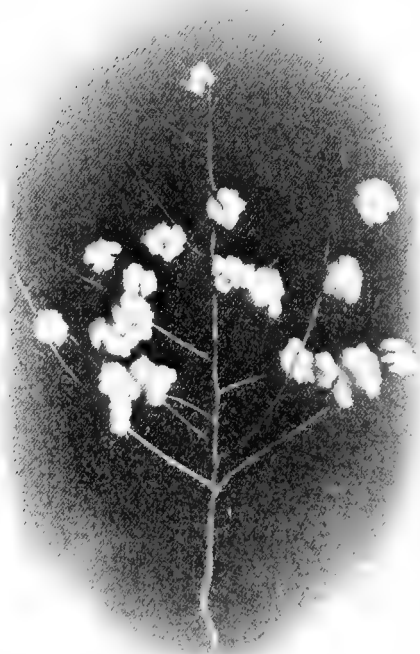

FIG. 143.—AN UNPRODUCTIVE COTTON PLANT.

of qualities desired and on which the fewest new qualities need to be engrafted.

**271. The simplest method of selection.** — The following method of selection is recommended as practicable for most farmers who cannot afford to devote much attention to cotton breeding, but who desire to maintain or slowly improve the purity and excellence of any good variety: —

At the first or second picking, let one of the most careful of the pickers precede the others and pick into one bag the seed cotton from the best plants.

The plants chosen by this picker must be very productive, and they should possess in addition the other qualities desired; — for example, earliness and a certain size of boll. Moreover, all plants chosen for seed should be uniform in the appearance of the plant and in the other qualities desired. Thus, in a big-boll variety, every plant having medium or small bolls should be rejected, no matter how numerous the bolls may be. Likewise in selecting seed of a semicluster variety, no bolls from a long-limbed plant, howsoever productive, should be picked into the sack intended for seed.

**272. Principal qualities desired in the plant.** — A careful person engaged in selecting cotton soon becomes so expert that, as he walks along the row, he can detect at a glance the most promising plants. Then he should make a hasty decision as to whether each productive plant combines the following important points: —

- (1) Desired size of bolls;
- (2) A large number of bolls;
- (3) The desired degree of earliness;
- (4) The shape of plant characteristic of that variety; and
- (5) Freedom from disease, such as boll-rot, rust, and cotton wilt.

Each farmer should decide for himself whether it is practicable for him, in selecting cotton, to consider other qualities not so readily detected, such as length of lint and proportion of five-lock bolls.

**273. Defects in bolls.** — In selecting seed for planting, either by the simple method now under discussion or by a more careful method to be described later, no boll should be picked for seed that has any of the following defects: —

(1) Spots on the hull or bur, due to disease;

(2) Any imperfectly developed lock, or any lock not fully open; and

(3) Diminutive size of boll.

A boll with disease spots or with a defective lock is apt to convey the germs of disease to the next crop.

**274. The seed-patch.** — The cotton picked for seed from the best plants as directed above should be carefully ginned, taking care to avoid any mixing at the gin. The next season the selected seed thus obtained should be planted thinly in a seed-patch having uniform soil and separated, if possible, by a quarter of a mile from any other cotton.

Each year a similar seed-patch should be planted with seed selected from the best plants of the preceding year's seed-patch. The remaining seed, after the best plants have been picked over once, will usually suffice to plant the entire farm.

The method of selection described in the last few paragraphs is practicable on almost any farm, whether large or small. However, this method alone will serve rather to maintain established excellence than to afford any notable and rapid improvement in the variety, which must be



effected by the more painstaking method described in paragraph 278.

**275. Qualities needing improvement.** — Selection or breeding is capable of improving the cotton plant in every desirable quality. Among those directions in which improvement should be sought are the following: —

- (1) Increase in the yield of lint;
- (2) Increased earliness;
- (3) Increase in size of boll;
- (4) Greater length of lint;
- (5) More uniformity in the length of lint;
- (6) Improvement in the form of plant or method of branching;
- (7) Increase in the percentage of lint of some varieties; and
- (8) Greater resistance to diseases.

**276. Some antagonistic qualities.** — Some of the qualities just mentioned tend to exclude other desirable ones. The following pairs of qualities are generally antagonistic; that is, rarely, if ever, found in the same individual plant: —

(1) Extreme earliness is opposed to extremely large bolls.

(2) Extreme earliness is usually not associated with the highest yields of lint, except when the fruiting season is shortened by early frost or by the presence of the boll-weevil.

(3) Great length of lint excludes the probability of a high percentage of lint.

(4) A high percentage of lint is seldom found in varieties or strains having large seeds.

As a rule, any progress in improving one of these characters

results in a decrease in its antagonistic quality. However, an occasional single plant may constitute an exception, and combine, to a certain extent, these opposing qualities. Such exceptional plants are exactly those that the plant-breeder is seeking to evolve or to discover, and then to perpetuate in their purity.

Although certain pairs of desirable qualities are antagonistic, yet the cotton plant has many useful characters that can readily be improved together without mutual injury.

**277. Breeding for a small number of qualities.** — The most rapid improvement in any character is secured when plants are selected for seed with chief reference to a very small number of desirable qualities. For example, if an increased size of boll is the only point aimed at, any given field will contain more plants filling this requirement than plants answering the needs of a man who wishes a combination in the same plant of three qualities, such as large size of boll, small seed, and long lint.

Therefore, it is wise to make one quality the leading one, so that every plant selected shall possess this to a high degree; but there should also be in mind several secondary qualities, which the selected plants should possess, to at least a moderate degree.

The important practical lesson from the above principle is to continue selection year after year with the same chief object in mind until that end is attained. Do not select one year chiefly for size of boll and the next year mainly for length of lint; but keep the same aim and desired quality in mind from year to year. After this character is fixed, it is time enough to take another one as the principal object through another series of years.

From all of the above it follows that it is important to start with a pure variety that already possesses most of the qualities desired.

**278. Plant-breeders' methods of improving cotton.**— In order to make very great or very rapid improvement in a variety or strain of cotton, it is necessary to practice a method requiring much more time and pains than can be spared by any except the few men who make a specialty of plant-breeding. This method is called the "plant-to-row method." It is based on the fact that plants may be excellent by reason of either :—

- (1) Favorable surroundings (environment), or by
- (2) Their inherent, or self-contained, excellence.

*Superiority due merely to favorable environment*, such as an extra share of fertilizer, abundant space, and other advantages, is not hereditary; but *inherent excellence is hereditary*. It is usually difficult or impossible to determine whether the superiority of a selected plant is accidental (due to favorable environment) or inherent. This question remains unsettled whenever seed from a number of plants are planted together, as in the simplest method of selection before described.

But by keeping the seed of each plant separate, and planting each on a separate row, the next year the parent plant of inherent or inheritable excellence is readily determined. For its offspring almost uniformly show the desired quality; while a row grown from a parent plant that was productive merely because of favorable environment does not show the good qualities of the parent. Hence, selection must be made thereafter only from those rows on which the plants exhibit the proof of having

inherited the good quality of their parent plant, this fact creating the presumption that they also are prepotent, or able to transmit their good qualities to the next generation.

**Details of the plant-to-row method of cotton breeding.** — In the best field of the desired variety select each year 100 plants, or as many as can well be separately ginned and planted. Place a tag bearing a number on each selected plant before picking. On a large, strong, paper bag write a similar number. Whenever a picking is made place the seed cotton from Plant No. 1 in Bag No. 1, and so on for each selected plant. After weighing the seed cotton from each plant, reject those that are far below the average productiveness. For accurate work it is desirable to gin the seed cotton of each plant separately, which is best done in a specially constructed very small gin.

If ginning is not practicable, selection must be made among the picked plants merely on the basis of the weight of seed cotton; in this case the unginned cotton may be planted in hills at uniform distances apart, a lock or half a lock in a hill. When thus planted extreme care must be taken to pack the moist soil over each piece of seed cotton, otherwise the stand will be poor.

In the fall, first select the best plants on what seem to be the best rows, and then weigh the remainder of the crop on each row separately, so as to determine which rows are really the best, as shown by the total yields.

The second year, plant on very uniform land a similar plant-to-row patch, usually containing 20 to 100 rows, each planted with the seed of one of the best plants from the few best rows of the year before. Make all rows of uniform width and plant the field in checks, so that every plant may have exactly the same amount of space. The breeding-patch should always be on uniform land and removed as far as possible from any other kind of cotton, so as to avoid cross-fertilization.

The following diagram (Fig. 144) shows the steps from year to year: —

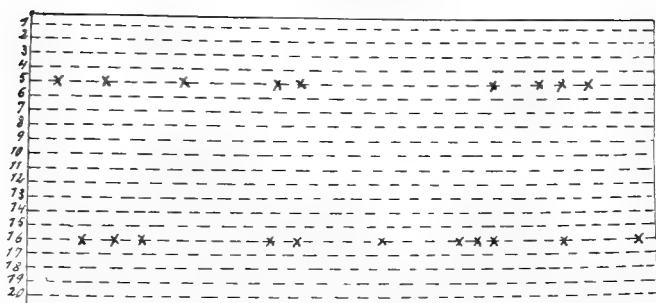

FIG. 144.—DIAGRAM SHOWING A BREEDING-PLOT OF TWENTY ROWS OF COTTON.

The best plants ( $x, x$ ) are selected on the best rows (Nos. 5 and 16) for planting the next year's breeding-plot of cotton.

Each horizontal line represents a row in the plant-to-row test each year. An " $x$ " represents a selected plant on one of the best rows. Each plant-to-row patch is planted with seed from these best individuals, the seed of each plant occupying a separate row.

The next diagram (Fig. 145) shows the possibility of obtaining in three or four years from a single original plant enough seed to plant an entire farm.

**279. Plant-breeding a specialty.**—Most farmers can practice the simple method of selection first described, but few will be able to give the time and pains to careful work with the plant-to-row method. Yet so much superior to average seed of even the purest varieties are seed produced by the plant-to-row method that farmers can better afford to pay a fancy price for small amounts of seed thus improved than to plant ordinary seed. Undoubtedly in the future the tendency will be for plant-breeding to become a business or a profession requiring the entire

time of painstaking, trained men, from whom farmers will find it more profitable to buy pedigreed seed than to

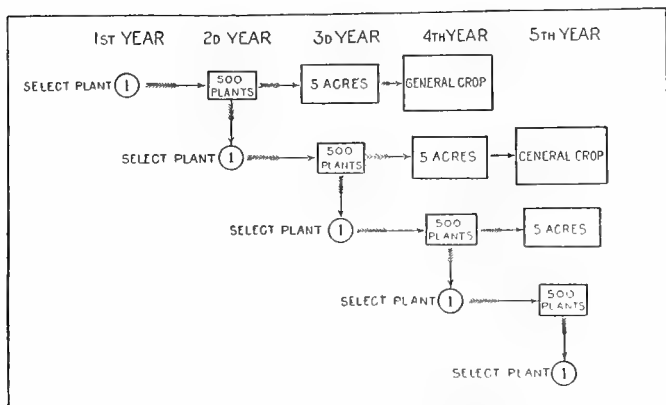

FIG. 145.—DIAGRAM SHOWING METHOD OF SELECTING COTTON.

attempt elaborate plant-breeding in connection with ordinary farm work.

**280. Size of seed for planting.**—Several experiments have shown that by separating and planting only the heavy seed, the percentage of germination is notably increased. A better stand results and a larger yield is sometimes obtained.

It does not follow that because the largest seed within a given variety are superior to the smaller seed, that variety is best which has the largest seed. Indeed the opposite is often true; the high percentage of lint that is frequently found in varieties with small seed often makes them more productive of lint than varieties with large seed.

**Methods of separating large and small or heavy and light seed.** — As cotton seed come from the gin, covered with a coat of fuzz, they tend to cling together in masses. This renders it difficult, without previous treatment of the seed, to separate the largest from the others.

Webber and Boykin recommend (U. S. Dept. Agr., Farmer's Bul. No. 285) the following treatment of the seed: A thin flour paste is poured on the seed, which are then stirred or otherwise agitated until every seed is covered. The fuzz is thus pasted down to the hull. After drying, the seed are in condition to be easily separated in a fanning machine especially constructed so as to blow out the lighter seed. Those which have been treated with paste can be planted more thinly than otherwise, which is an advantage in the subsequent thinning of the plant.

The delinting of the seed, which consists in reginning them, as is commonly done by oil mills, also makes it somewhat easier to separate the individual seeds.

### LABORATORY EXERCISES

1. If practicable, make a number of crosses, preferably among varieties having easily recognizable features; pupils who are especially interested may wish to plant the resulting seeds and to note the diversity among the plants.

2. Students should copy the score-card below and by its aid score the plants, — preferably by pairs, — of several varieties. This exercise needs frequent repetition, not so much to familiarize the pupils with the score-card (which may be considerably modified for special objects), but for the purpose (1) of directing more careful attention to the characteristics of the different varieties or strains, and (2) to train the eye and the mind to the prompt recognition of the defects and valuable characteristics of any cotton plant observed.

### SCORE-CARD FOR COTTON

The following is the score-card devised for the use of students of the Alabama Polytechnic Institute:—

FORM, short-jointed, well-branched, indicating fruitfulness . . .	15
YIELD (standard 1 bale or more per acre):	
(a) Size of bolls (standard 40 per pound; 1 point deducted for each additional 5 bolls required per pound of seed cotton) . . . . .	15
(b) Per cent lint (standard 40 per cent for short-staple varieties; 32 per cent for long-staple; 1 point cut for each 1 per cent below standard) . . . . .	10
(c) Number of mature bolls per plant . . . . .	15
(Standard, unfavorable conditions . . . . .	20)
(Standard, medium conditions . . . . .	60)
(Standard good conditions . . . . .	100)
Total yield ( <i>a</i> and <i>b</i> and <i>c</i> ); or weighed yield seed cotton times average per cent lint of that variety . . . . .	40
EARLINESS (standard being the earliest plants of King) . . . . .	10
HARDINESS of plant towards disease . . . . .	3
STORM RESISTANCE . . . . .	2
COMPLETENESS OF OPENING and ease of picking . . . . .	2
LINT	
Length of lint (standard, upland, 1 to 1 $\frac{1}{8}$ inches; long staple, 1 $\frac{1}{2}$ inches) . . . . .	8
Uniformity in length of fibers on same seed . . . . .	8
Strength . . . . .	3
Fineness . . . . .	3
Color . . . . .	2
Maturity . . . . .	2
UNIFORMITY OF SEED in size, color, etc. . . . .	2
Total . . . . .	100

## LITERATURE

- WEBBER, H. J. Improvement of Cotton by Seed Selection. U. S. Dept. Agr. Yearbook, 1902, pp. 365-389.
- WEBBER, H. J., and BOYKIN. U. S. Dept. Agr., Farmer's Bul. No. 285.
- BENNETT, R. L. Breeding an Early Cotton. Tex. Expr. Sta., Bul. No. 79.
- Proceedings American Breeders' Association.



## CHAPTER XIX

### COTTON — SOILS AND FERTILIZERS

COTTON is a most adaptable crop. Almost any land in the cotton-belt — from light sandy to stiff clay — will produce a crop, provided it be well drained, and, if poor, supplied with the necessary kind and amount of fertilizing materials.

**281. Soil range.** — A large proportion of the American cotton crop grows on land too sandy, dry, and poor to be thoroughly satisfactory for corn. Indeed, a large area of cotton grows on land too poor to yield a profit even from cotton. These unprofitable areas, these "robber acres," are the source of much loss to cotton farmers. They could be more advantageously devoted to pasture or to leguminous plants. On sandy land the plant is much more subject to injury from cotton rust than on loamy or clay soils.

On some very rich, moist, bottom land, cotton makes a stalk of excessive size without a corresponding development of fruit. Therefore, such lands are not favorable for cotton, but may be more advantageously devoted to the production of corn, hay, or pasturage.

#### GENERAL CONSIDERATIONS ON FERTILIZING COTTON

**282. Draft of cotton on soil fertility.** — The table in paragraph 246 showed that in certain experiments the seed and lint together contained about half the total nitrogen and

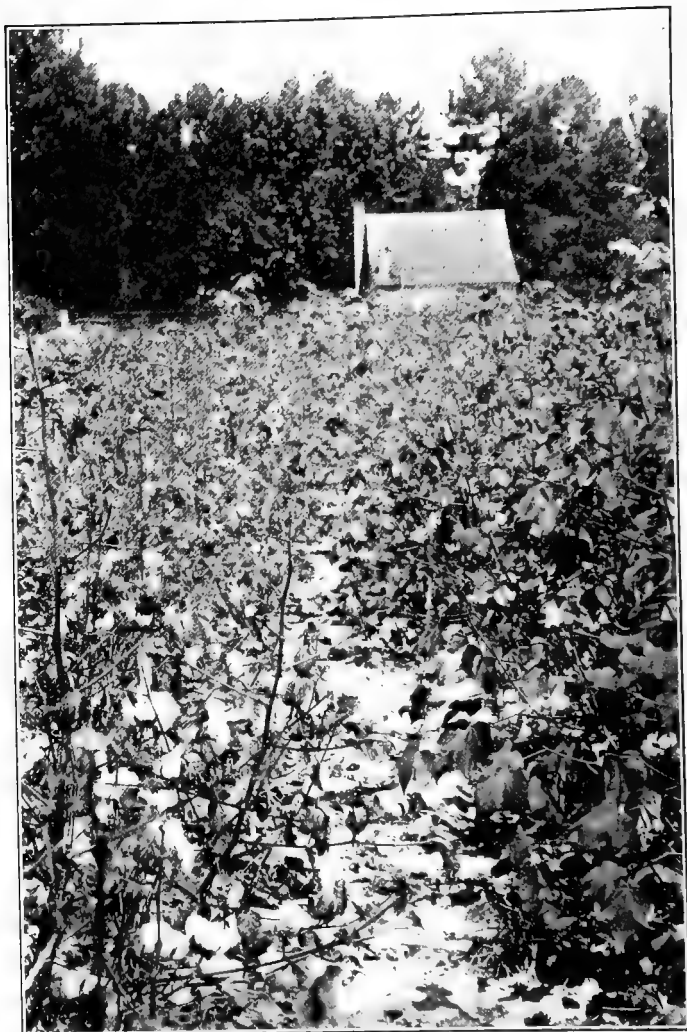

FIG. 146. — COTTON PLANTS.

Showing retention of leaves on the right, due to vegetable matter; and shedding of leaves on the left, where there was less vegetable matter in the soil.

phosphoric acid but only a quarter of the potash found in the entire plant. The composition of a plant or of the part removed from the soil is not a guide to the correct fertilization of that plant; yet it is well to know that the lint and seed together in a crop of 300 pounds of lint removed plant-food which at ordinary prices would be worth in commercial fertilizers about \$3.75. Of this amount, the fertilizer constituents in the lint alone are worth only 25 to 30 cents. Indeed, no other ordinary crop makes such slight demands on fertility as does the cotton fiber. If the seed and all other parts of the plant except the lint were returned to the soil, there would be no reductions in fertility except those due to extraneous influences, such as surface washing, loss of vegetable matter (Fig. 146) through clean cultivation, and loss of nitrates from the soil in the drainage water.

The seed and lint together, in the case of a crop of 300 pounds of lint, make a draft on soil fertility that is about the same as would be removed by the grain alone in a crop of 25 bushels of corn or of 35 bushels of oats.

**283. Amounts of fertilizer required to take the place of plant-food removed by lint and seed.** — Three hundred pounds of cotton-seed meal and twenty-seven pounds of kainit would furnish all the fertilizer constituents removed from the soil by a crop of 300 pounds of lint with its accompanying seed; this quantity of cotton-seed meal would supply not only the nitrogen, but all of the necessary phosphoric acid. If the nitrogen were drawn wholly from the decay of leguminous plants and no cotton-seed meal were applied, 51 pounds of acid phosphate, containing 14 per cent of available phosphoric acid, would

supply all the phosphoric acid removed in a crop of seed and lint of the size indicated.

In fact, such figures give no idea of the amounts and kinds of fertilizer actually found to be advantageous for the cotton plant. For example, in practice the usual amount of acid phosphate is at least 120 to 200 pounds per acre, which supplies several times the amount of phosphoric acid removed by seed and lint in a crop yielding 300 pounds of lint. The necessity for applying much larger amounts of phosphoric acid than apparently required by the composition of the cotton plant is largely due to the fact that a large proportion of the phosphoric acid is converted in the soil into compounds that are not promptly available.

Means of determining the fertilizer required by cotton on different soils are discussed in succeeding paragraphs.

**284. Phosphoric acid.** — There are no indications either from the appearance of the soil or from the appearance of the plant as to whether phosphoric acid is needed. However, in regions where the use of commercial fertilizers for cotton is general, experiments and experience have indicated that the need for the application of phosphates is almost universal. Usually a fertilizer for cotton should contain more acid phosphate than any other single chemical fertilizer.

**285. Potash.** — In determining the probable requirement of cotton for potash, note should be made of the proportion of clay or silt compared with the proportion of sand. Clay and silt are frequently formed from materials rich in potash; hence the more clay or silt the soil contains, the less, as a rule, is the need for potash.

However, some clay soils contain a large amount of potash, but in an unavailable form. In this case the potash can often be made available by improved preparation and cultivation and by the addition of vegetable matter. The sandier the soil and subsoil the greater is the need for potash. Even on sandy lands, this fertilizer may not be needed in any considerable amount unless cotton rust commonly occurs on such soil.

**286. Nitrogen.** — The proper proportion of nitrogenous fertilizer to acid phosphate in a fertilizer formula for cotton depends more on the recent cropping and manuring of the field than on the character of the rocks from which the soil has been derived. One can usually decide if nitrogen is needed by considering the following facts: —

(1) Small stalks (if not due to climatic influences, poor cultivation, etc.) are usually an indication that nitrogen is needed.

(2) Excessive stalk or "weed" growth of cotton is an indication that nitrogen can be dispensed with, wholly or partially.

(3) The fresher the land the less the need for nitrogen.

(4) Phosphate hastens maturity and may make more severe the injury from cotton rust.

(5) A luxuriant growth of cowpeas or of any other legume just preceding cotton largely dispenses with the necessity for nitrogen in the fertilizer; so does a recent heavy dressing of stable manure or cotton seed.

However, the only positive means of determining the exact fertilizer requirement of any soil is by making on it an experiment with fertilizers.

**287. Effects of commercial fertilizers on the soil.** — Commercial fertilizers are, on the whole, profitable, in spite of many misfits between soil, crop, and fertilizer. Indeed, in a large part of the cotton-belt they are indispensable. The profits from their use will increase with a more general knowledge of agricultural principles. Commercial fertilizers have been occasionally charged with being largely responsible for the impoverished conditions of the cotton fields and the scant profits of the cotton grower. This is not correct. They do not in themselves exhaust the soil. Reliance upon fertilizers alone may cause a farmer to keep his land too long in cotton, instead of letting cotton alternate with soil-improving crops, such as cowpeas. The exhaustion of the fertility of the cotton fields is due chiefly to leaching, washing, and loss of vegetable matter as the result of continuous clean cultivation.

For the scant profits too often secured in the culture of cotton, the chief causes are impoverished soil, purchased supplies, unintelligent use of fertilizers, scarcity of capital, deficiency of labor-saving machinery, unsatisfactory labor conditions, and the failure to master the principles which underlie a rational system of farming. What should be condemned is not the use, but the abuse, or purposeless use, of commercial fertilizers.

**288. Most popular factory-mixed fertilizers.** — The use of ammoniated guanos, that is, complete fertilizers containing nitrogen, is more general among cotton farmers than the use of chemicals bought separately and mixed on the farm. The most extensively used form of complete ready-mixed guano contains about 1.65 per cent of nitrogen (equal to 2 per cent of ammonia), 10 per cent of

available phosphoric acid, and 2 per cent of potash. This is spoken of as a 10-2-2 guano.

**289. Advantages of the home-mixing of fertilizers.**— If the farmer decides to buy the separate materials and do his own proportioning and mixing, he usually purchases cotton-seed meal, acid phosphate, and kainit. If he wishes to make a more concentrated fertilizer, that is, one of higher grade, he may buy the nitrogen in the form of nitrate of soda, or sulfate of ammonia, and the potash in the form of muriate or sulfate of potash. Those farmers who understand how to mix fertilizers find that it is much more economical to do so than to buy the average ready-mixed guano. The advantage of home-mixing are the following:—

(1) The mixture made at home usually costs several dollars less per ton than a factory-mixed fertilizer of exactly the same composition.

(2) Home mixing permits the farmer to suit the fertilizer to the particular soil on which each lot is to be applied, and to adapt the fertilizer to the different crops. For example, in purchasing a complete ready-mixed fertilizer, he applies this to all soils and all crops; yet the nitrogen in it is not needed by legumes, such as cowpeas and peanuts; and the potash in it may not be required by any crop on some clay soils. In making his own mixture the farmer would omit the nitrogen in the one case and the potash in the other, and thus save their cost. However, farmers who do not understand how to suit the fertilizers to the soil and the crop find it advantageous to use a factory-mixed guano. Its one slight advantage consists in being somewhat more evenly mixed.

290. Amounts of increase from commercial fertilizers. — The results of several hundred fertilizer experiments made on a great variety of soils in Alabama led to the conclusion that, as an average, each ton of fertilizer *adapted*



FIG. 147. — A FIELD OF COTTON.

The plot on the left was unfertilized and yielded only 460 pounds of seed cotton per acre; that on the right received 640 pounds per acre of a complete fertilizer and yielded 1206 pounds, an increase of 746 pounds of seed cotton per acre.

*to the soil* should afford an increase of about 1500 pounds of seed cotton, — or one bale increase per ton of fertilizer



(Fig. 147). Under unfavorable conditions, — as on prairie or waxy lime land, or with unsuitable fertilizer, or with the use of excessive amounts, — the increase was much less. These estimates are for appropriate mixtures of high-grade chemicals.

Smaller figures would probably represent the increase from a ton of ordinary cotton guano, or ready-mixed fertilizer.

If all the fertilizer experiments made by the experiment stations be averaged, including those on soils not needing fertilizers, the average increase drops far below one bale for each ton of fertilizer. (Bul. No. 62, Bur. Soils, U. S. Dept. Agr.)

**291. Profit returned by fertilizers.** — Assuming an increase of one bale (say 1500 pounds of seed cotton) for each ton of well-proportioned and appropriate fertilizer applied to four or five acres of land, an estimate can be made as to the profit, under favorable conditions, afforded by a judicious investment in fertilizer. Thus: —

	<i>Dr.</i>	<i>Cr.</i>
To one ton complete fertilizer, estimated cost in cash . . . . .	\$22.00	
To extra cost of picking and ginning the increased yield, 1500 pounds, at 60 cents per hundred . . . . .	9.00	
By value of increased amount of seed, 1000 pounds, at 75 cents per hundred . . . . .		\$ 7.50
By value of one bale of cotton, 500 pounds at 10 cents per pound . . . . .		50.00
Possible profit, from use of one ton of fertilizer . . . . .	\$26.50	
	\$57.50	\$57.50

**292. Advantages of high-grade fertilizers.** — Among either factory-mixed, or home-mixed fertilizers, those of higher grade, that is, containing higher percentages of

nitrogen, phosphoric acid, and potash, naturally cost more per ton than low-grade fertilizers. Yet the high-grade fertilizers are usually more economical. The true test in choosing between two fertilizers consists in calculating which one affords a pound of nitrogen, potash, and available phosphoric acid at the lower price.

The reason why a concentrated, high-grade fertilizer is usually more economical than a low-grade fertilizer is made clear by comparing a 12 per cent acid phosphate with a 16 per cent phosphate. To afford an equal amount of plant-food, say 960 pounds of available phosphoric acid, requires 4 tons of the low-grade fertilizer, but only 3 tons of the high-grade fertilizer. This extra ton of the low-grade article involves extra expense for freight, hauling, mixing, and sacking. Hence, the manufacturer or dealer must charge more for each pound of plant-food in the less concentrated fertilizer.

The advantage of using the highest grades of fertilizers increases with the distance that the fertilizer must be shipped and hauled. If, however, a fertilizer be made too concentrated, there is greater difficulty in mixing its constituents uniformly and in applying it evenly, because the amount to be used on each acre is so small.

**293. Quantity per acre of fertilizer.** — Experiments in several states have shown that an application of 400 to 600 pounds to the acre of a fertilizer adapted to the soil affords a larger profit to the acre than the use of smaller amounts. At the Georgia Experiment Station a complete fertilizer was used at the rate of 400, 800, and 1200 pounds per acre. Each increase made a decided and profitable increase in the yield. However, the smallest lot returned much the highest percentage of profit on the investment; the 800 pounds paid a higher dividend than the largest amount. This illustrates the usual rule, which is that the percentage of profit on the investment in fertilizers

decreases as the amount of fertilizer increases; but that the *profit per acre* is usually greater with the larger amounts, up to a certain point, which is often above 600 pounds per acre.

Probably 200 pounds or less per acre is the amount of fertilizer most generally applied to cotton.

Moderate to large applications pay best when the season is favorable, but involve the risk of loss should climatic conditions be extremely unfavorable. To render as safe as possible heavy or intensive fertilization, the soils on which it is employed should be in good mechanical condition, especially as regards drainage and power to retain sufficient moisture during drought. This latter condition may usually be brought about by a rotation that affords an abundance of vegetable matter and by judicious preparation and cultivation.

#### NITROGENOUS FERTILIZERS

**294. Nitrogen produced on the farm.** — The cheapest sources of nitrogen are barnyard manure and the leguminous or soil-improving plants, such as cowpeas, velvet beans, hairy vetch, and (when pastured by hogs) peanuts. Manure may pay even better for hay and other forage crops than for cotton. Cotton seed is too high-priced in most localities for use as fertilizer.

**295. Cotton seed vs. stable manure.** — In Alabama extensive comparisons of manure from horse stables with cotton seed were made on many soils, using an average of 835 pounds of fresh seed alone against a little over two tons of stable manure.

Increase due to stable manure, — seed cotton per acre . 444 lb.

Increase due to cotton seed, — seed cotton per acre . . 288 lb.

From a summary of the results of many tests made in Alabama during three years and on numerous soils, it appears that 5 pounds of stable manure exerted during the year when applied as fertilizer a greater influence on the yield of cotton than did one pound of cotton seed used without crushing or heating; that the average yield was increased by 101 per cent when stable manure was used and by 64 per cent when cotton seed was used; and that to obtain an increase of one pound in the yield of seed cotton there was required 3 pounds of cotton seed, or nearly 10 pounds of rich stable manure.

**296. Cotton seed vs. cotton-seed meal.** — Most tests show practical equality for a pound of nitrogen in cotton-seed meal and in crushed or rotted cotton seed. To furnish equal amounts of nitrogen requires the following amount of each: —

	NITRO- GEN	PHOS- PHORIC ACID	POTASH
2000 lb. of cotton seed contain . . . . .	62.6	25.4	23.4
963 lb. of cotton-seed meal ( $6\frac{1}{2}$ per cent nitrogen) contain . . . . .	62.6	26.5	16.3

The average of a number of experiments on many soils in Alabama showed that, as a fertilizer for cotton, one pound of high-grade cotton-seed meal was equal the first year to  $2\frac{1}{16}$  pounds of crushed cotton seed. Later experiments in Alabama and Georgia make a still more favorable showing for the meal. Cotton seed exerts a greater influence the second year than does the meal;

however, on sandy soils, most tests show the residual effect of both cotton seed and cotton-seed meal to be slight. It seems safe to conclude that on most soils half a ton of medium or high-grade cotton-seed meal is about equal as fertilizer to a ton of cotton seed.

Cotton seed may be applied in deep furrows in January without much danger that they will grow. If applied late, they should first be either crushed or composted or subjected to a high temperature caused by allowing them to be moistened and heated in bulk. When the seed germinate, the fertilizing value is apparently decreased, but not lost. Further experiments on this point are needed.

The oil is without value as a fertilizer, and the hulls contain but little plant-food. Therefore, the most complete value of the cotton seed is obtained by the public when the oil mill extracts the oil.

It has been shown that the meal and hulls from one ton of cotton seed is at least as effective a fertilizer as the entire seed. Hence, the farmer who can exchange one ton of his seed for the meal and hulls contained in it, namely, about 750 pounds of meal and 800 pounds of hulls, loses nothing in fertilizing value. When the farmer can get 1000 pounds or more of meal and no hulls for one ton of seed, he usually makes a nearly equal exchange, if the cost of hauling be disregarded. He should usually obtain in exchange for a ton of cotton seed, considering only the fertilizing value, as many pounds of meal in excess of 1000 pounds as will pay for hauling both ways and whatever profit he may see fit to charge.

**297. Other forms of nitrogen.** — Whenever the nitrogen in nitrate of soda is as cheap as that in cotton-seed

meal, the former may be profitably employed on cotton. The farmer should buy either nitrate of soda, cotton-seed meal, dried blood, or tankage, choosing that one in which a pound of nitrogen costs least. Most experiments fail to show any notable difference in the value of a pound of nitrogen from these different sources.

**298. General need of cotton soils for nitrogen.** — Cotton-seed meal or other nitrogenous fertilizer is highly beneficial to cotton on a large proportion of the cultivated area of every region where the soils have become poor. Apparently it is almost universally needed on uplands in such regions except on (1) new grounds, and (2) on soils containing considerable vegetable matter, as the result of proper rotation with cowpeas, or other humus-forming crops. Although cotton-seed meal is almost universally beneficial, it is not always profitable when applied to cotton at the rate of 200 pounds or more per acre. Poor physical condition of the land, resulting in a scarcity of moisture in the summer, is the greatest hindrance to the profitable use of large applications of cotton-seed meal. But even with poor physical condition, it is usually profitable on soils where the stalk is small to supply nitrogen in the mixed fertilizer for cotton.

**299. Cost of a pound of nitrogen.** — A pound of nitrogen in commercial fertilizers usually costs 15 to 18 cents. To learn the average cost each year, inquiry should be made of the State Commissioner of Agriculture, in the capital city of the state.

**300. Fertilizing value of cotton-seed meal and hulls before and after being fed.** — In an experiment at the South Carolina Experiment Station a definite amount

of cotton-seed meal and hulls was fed to dairy cows, and every particle of the resulting manure was returned to the soil as fertilizer for cotton. An exactly similar amount of cotton-seed meal and hulls was applied directly as fertilizer for cotton. The yield of cotton was much greater where the manure was used. This was probably due in part to the quicker decay of the manure than of the meal and hulls.

**301. A rational system of fertilization with nitrogen.** — Considering permanent effect, as well as influence on the crop immediately following, the cowpea and other leguminous plants must be ranked as a cheaper source of nitrogen than is any nitrogenous material which may be bought as commercial fertilizers. The aim of the cotton farmer should be to grow such areas of legumes as will enable him to dispense with the purchase of nitrogenous fertilizers for cotton, using the funds thus saved to purchase increased amounts of phosphates or other necessary non-nitrogenous fertilizers. The money that would have been necessary to purchase one pound of nitrogen will buy about three pounds of phosphoric acid, or of potash, which larger purchases of phosphate and potash will enable the farmer to grow heavier crops of legumes. And heavier crops of legumes trap larger amounts of otherwise unavailable atmospheric nitrogen and result in further soil enrichment and larger yields of cotton.

#### PHOSPHATIC FERTILIZERS

**302. Different kinds of phosphate.** — While there are a number of forms in which the farmer may obtain phosphoric acid, the one that is almost universally employed

in the cotton-belt is *acid phosphate*. This usually contains 14 to 16 per cent of available phosphoric acid, but both lower and higher grades than this may be obtained. *Acid phosphate* is manufactured by adding sulphuric acid to the finely ground phosphate rock, or raw phosphate. The sulphuric acid is employed in order to make the phosphoric acid promptly available to plants. As the sulphuric acid has no fertilizing value, it serves to dilute the original phosphate rock. Hence, acid phosphate usually contains only about half as large a percentage of phosphoric acid as the raw phosphate from which it was made. But nearly all of the phosphoric acid in acid phosphate is in a soluble or available condition.

*Raw phosphate* consists of the finely ground phosphate rock without treatment with any acid. Among the names given to it are crude phosphate, ground phosphate rock, and floats. It usually contains from 26 to 30 per cent of total phosphoric acid. All of this is insoluble, and hence not in a form to be immediately used by the roots of plants.

As ground phosphate rock contains about twice as much total phosphoric acid as does acid phosphate, and in some localities costs less than half as much per ton, it would be desirable to use the raw phosphate if it could be made available.

**303. Effects of different phosphates on cotton.** — Repeated experiments in many states have shown that cotton can make some use of raw phosphate, but that acid phosphate usually is much more effective. However, experiments have also shown that the raw phosphate becomes more quickly available if it is mixed with large



amounts of rotting vegetable matter. Hence, raw phosphate mixed with stable manure is sometimes as effective as an equal weight of acid phosphate. The use of raw phosphate for cotton should probably be restricted to cases where it can be thus used with manure or leaf-mold, or to soils on which a large amount of vegetable matter is being plowed under. Even in the latter case acid phosphate is usually the more profitable the first year.

It is generally believed that the residual effects, that is, the effects subsequent to the year when it is applied, are greater with raw phosphate than with acid phosphate; but the difference in residual effect is not sufficient to overcome the usual greater efficiency of acid phosphate in the year in which it is applied.

**304. Other sources of phosphoric acid.** — Another source of phosphoric acid is slag phosphate; this is more available than raw phosphate. Still another source of phosphoric acid is ground bone, which is not extensively used by cotton growers.

The principal phosphate mines are in South Carolina, Tennessee, and Florida. Some authorities estimate that unless new phosphate mines are discovered, or the export of phosphate to foreign countries decreased, the supply of high-grade phosphate rock will be exhausted long before the close of the present century. This is one of the considerations that should lead farmers to utilize on the farm the substances rich in phosphoric acid. Richest of these are the bones of animals. Cotton seed, and all other seeds, contain considerable phosphoric acid, which is retained on the farm when these seed are there fed to live-stock.

The cost of available phosphoric acid in commercial fertilizers usually ranges around 5 cents per pound.

**305. General need of cotton soils for phosphates.** — The need for phosphate as a fertilizer for cotton is apparently almost universal on poor land east of the Mississippi River. Exceptions are found in some of the soils of the Central Prairie Region of Alabama and Mississippi, as well as in the similar area of black waxy soil in Texas. Phosphate is also often needed on the rolling cotton lands west of the Mississippi, that have sandy and loamy soils.

#### POTASH FERTILIZERS

**306. Extent of the need for potash.** — Potash is more abundant in Southern soils than is phosphoric acid or nitrogen. Therefore, most crops make less demand for potash in the fertilizer. Cotton agrees with most other crops in less frequently needing artificial supplies of potash, or in needing it in smaller amounts as a plant-food than the other two fertilizer constituents.

This small demand for potash is notable in view of the fact that the entire plant contains about three times as much potash as phosphoric acid. The less frequent need for potash in the fertilizer seems to be due to the following causes: —

(1) To relatively greater abundance of potash than of phosphoric acid in the soils of the cotton fields.

(2) Probably to the action of the calcium sulfate (which constitutes about half the weight of acid phosphate), in rendering available the potash of the soil.

(3) To the fact that the seed and lint taken together remove nearly equal amounts of phosphoric acid and potash, thus first exhausting that one which is less abundant, — phosphoric acid.

At all events, healthy cotton plants frequently fail to make

profitable use of potash. At the several experiment stations and substations in Mississippi and Louisiana its use was unprofitable; the South Carolina and Georgia stations recommend it only in relatively small amounts; and the Alabama Station has found it often profitable, but more useful as a preventive of rust on certain soils than as an ordinary plant-food.

**307. Potash as a means of checking cotton-rust.** — On soils very liable to severe injury by attacks of cotton-rust the use of potash is recommended; for on such soils potash, ordinarily in the form of kainit, has conspicuously decreased the amount of rust and greatly increased the yields. Rust occurs most frequently on poor sandy soils, such as are especially common in the class known as the Norfolk soils, which constitute a large proportion of the area of the southeastern part of the cotton-belt. Hence, on such poor sandy soils, potash is more frequently than elsewhere needed for cotton.

In several hundred local tests conducted by the Alabama Experiment Station, 100 pounds of kainit per acre has been highly effective in restraining cotton-rust, apparently about as effective as 200 pounds.

In one test 60 pounds of kainit effected a noticeable decrease in the injury from this disease. Apparently it is safer to use at least 80 pounds per acre where the purpose is to combat rust.

In the fertilizer experiments in Alabama two facts relative to kainit and cotton-rust are noticeable, viz. (1) the usual favorable effect of kainit in checking rust, and (2) its occasional failure on some soils and in some seasons to reduce the injury resulting from this disease. Just how potash decreases rust is not well understood. It enables the cotton plant to remain green and thrifty through periods of unfavorable weather. Probably it

reduces the amount of water necessary to keep the plant in health, judging by the fact that potash has been found to reduce the amount of water transpired by the leaves of the corn plant. Potash in the fertilizer usually causes the later retention in the autumn of the leaves of the cotton plant (Fig. 148).

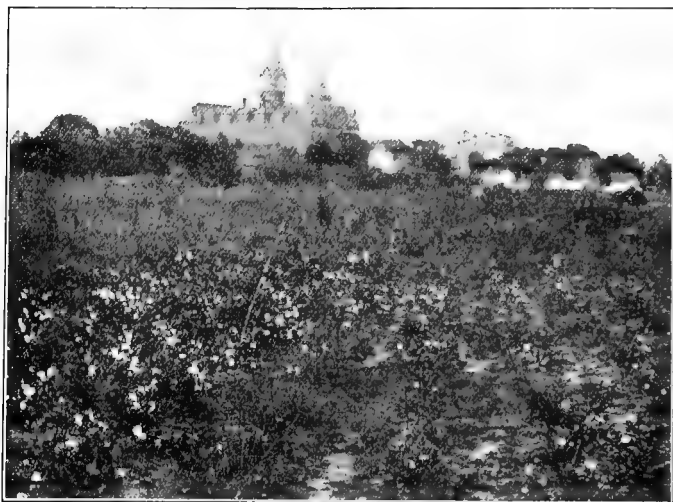

FIG. 148. - A COTTON FIELD, SHOWING THE EFFECTS OF POTASH IN RETENTION OF THE LEAVES.

On the right, the fertilizer contained no available potash; on the left, it contained 50 pounds muriate of potash per acre.

**308. Kainit, muriate and sulfate of potash.** — In experiments in Alabama, a pound of potash in the form of muriate was as effective in checking rust as when an equal amount was applied in the form of kainit. It is slightly less convenient to apply muriate of potash; for as this is four times as strong as kainit, it is advisable to use only

25 to 50 pounds of the muriate per acre, which small amount necessitates extreme care in pulverizing and evenly distributing this fertilizer. Aside from this slight consideration of convenience, the farmer should buy that one of these materials in which a pound of potash delivered at his farm costs him less. Where the freight rate and cost of hauling is high, the muriate will be the cheaper source of potash; near seaport cities, or where freight rates are low, kainit may be the cheaper form.

Kainit usually contains about 12 per cent of potash and muriate four times this amount. Another source of this plant-food is sulfate of potash, in which a pound of potash usually costs a little more than in kainit or muriate. The supply of potash salts comes from mines in Germany.

#### MISCELLANEOUS FERTILIZERS, AND EFFECTS OF FERTILIZERS

**309. Lime.** — Lime has shown very slight effect as a fertilizer for cotton in several tests in South Carolina and at Auburn, Alabama. At any rate, cotton is not conspicuously a lime-loving plant, like clover, wheat, timothy, and the like. Neither is cotton averse to lime, as shown by its successful growth on numerous limestone soils. In the Gulf States there are considerable areas of slightly acid upland soils. On some of these a light application of lime may be found profitable in connection with other fertilizers.

**310. Composts.** — As the word "compost" is used by cotton planters, it usually refers to a mixture of stable manure, cotton seed, and phosphate, which, after being brought together, are allowed to ferment 4 to 8 weeks.

Other coarse materials, and also other chemical fertilizers, often enter into a compost. The theory underlying the making of composts is that during the fermentation, materials previously insoluble are decomposed and converted into a soluble condition.

Taken as a whole, four experiments at the Alabama Experiment Station offer no argument in favor of composting such materials as cotton seed, fine stable manure, cotton-seed meal, and acid phosphate. Nor do the experiments along this line made at other experiment stations sustain the claim that these materials can usually be profitably composted for cotton when the price of this staple is low and labor expensive. With high-priced cotton and cheap labor, otherwise unemployed in winter, composting may be profitable.

It is not contended that experiments have definitely settled the question against composting stable manure and cotton seed. The point is that convenience and cost of labor should be the chief considerations in determining whether the composting of fine stable manure, cotton seed, and acid phosphate is advisable. Conditions may justify the making of compost heaps when coarse litter of any sort, as oak leaves, pine needles, or coarse manure are obtainable at slight outlay for labor. There are also good reasons for placing in the compost heap such cotton seed as cannot be applied in the drill early enough to prevent germination; many farmers find composting the most convenient means of killing the seed that are to be applied late in the season. The Furman formula for composting, very popular in the 1880's and still used, consists of

750 pounds stable manure,  
750 pounds cotton seed,  
367 pounds acid phosphate,  
133 pounds kainit.

The chemicals and cotton seed are spread in alternate layers, the cotton seed being dampened and mixed with the phosphate and then with the manure. In four to six weeks the compost

is removed in vertical layers, thus more thoroughly mixing the materials.

In view of the present high prices of cotton seed, and with a view of utilizing cheap raw phosphate, the following formula for making a compost for cotton is suggested:—

One load coarse stable manure, dampened,  
300 pounds raw phosphate,  
One load leaf mold from the woods, or other litter.

**311. Effects of fertilizers on maturity.**— Cotton growing on poor land is late in maturing, unless the process be hastened by the loss of leaves from rust, or by the premature death of the plants.

*Acid phosphate* decidedly hastens the maturity of cotton. Its use enables the farmer to obtain at the first picking, or at the first and second pickings, a larger proportion of the total crop of cotton than by the employment of any other single fertilizer. Other forms of phosphoric acid, including raw phosphate and basic slag, when used in connection with stable manure, have also been found to hasten maturity. At the Texas Experiment Station (Bul. 75) the plants fertilized with acid phosphate were 18 inches high when the plants on the unfertilized area and on the plots fertilized with nitrogen or potash were less than half that height; at the time when the phosphate plants bore 8 to 16 squares each, the other plants averaged only about 4 squares.

*Nitrogen* in commercial fertilizers in small or medium amounts somewhat favors early maturity. When a nitrogenous fertilizer is combined with acid phosphate, the highest degree of earliness is secured. On the other hand, ripening is retarded if the amount of nitrogen be

excessive or if a nitrogenous fertilizer be applied very late. It is a common observation that stable manure makes cotton late in opening. This can be overcome by caution in avoiding the use of excessive amounts and by supplementing the manure with any form of phosphate.

The use of *potash* usually causes the crop to retain its leaves and to continue growing late into the fall. Hence, potash does not promote early maturity, but in judicious proportions in a complete fertilizer it does not exercise an injurious retarding effect.

In North Carolina, C. B. Williams found that slacked *lime* hastened maturity when used in connection with a complete fertilizer.

Commercial fertilizers, judiciously employed, constitute one of the most effective means of insuring the early opening of cotton, and thus of securing a crop before boll-weevils become so numerous as to destroy all young forms.

By hastening the maturing of the cotton plant, commercial fertilizers have enabled farmers to grow cotton in higher latitude and in higher altitudes than was possible before their use became common.

**Effects of fertilizers on quality.** - In Egypt, where a cotton of very long, fine staple is produced, attention has been directed to the effects of fertilizers on the quality of lint. Observations on cotton, growing in the rich soils of that country, indicate that heavy applications of fresh or unfermented barnyard manure, or other fertilizers promoting a very rank growth late into the fall, injure the quality of lint; while phosphates, which hasten maturity, improve the staple. Partly on account of the more prompt action of nitrate of soda as compared with sulfate of ammonia or other nitrogenous chemicals, the former is there given preference as a supplement to an application of manure.



## LABORATORY EXERCISES

1. Assuming that nitrogen is worth 17 cents per pound, available phosphoric acid 5 cents, and potash 5 cents, calculate the commercial value of the plant-food in a ton of fertilizer of the following composition:—

- (a) 10 per cent available phosphoric acid, 2 per cent nitrogen, and 2 per cent potash;
- (b) 10 per cent available phosphoric acid, 3 per cent nitrogen, and 3 per cent potash;
- (c) 5 per cent available phosphoric acid, 4 per cent nitrogen, and 5 per cent potash.

2. Calculate the percentage of nitrogen, phosphoric acid, and potash in a mixture of

- 300 pounds nitrate of soda containing 15 per cent of nitrogen;
- 500 pounds kainit, containing 12 per cent of potash; and
- 200 pounds of acid phosphate, containing 16 per cent of available phosphoric acid.

3. Calculate how many pounds of each of the three fertilizers just mentioned would be required to make a mixture containing the same amounts and kinds of plant-food as one ton of guano analyzing 10 per cent available phosphoric acid, 1.8 per cent nitrogen, and 2 per cent potash.

4. Calculate how many pounds of the same kind of phosphate and kainit as in (2) and of cotton-seed meal containing 2.8 per cent of available phosphoric acid, 6½ per cent of nitrogen, and 1.8 per cent of potash, would be required to contain the same kinds and amounts of plant-foods as one ton of guano analyzing 10 per cent available phosphoric acid, 2 per cent of nitrogen, and 2 per cent of potash.

## LITERATURE

NEWMAN, J. S. Ala. Expr. Sta., Buls. Nos. 5, 12, 22.

BONDURANT, A. J., and CLAYTON, J. Ala. Expr. Sta., Buls. Nos. 34 and 42.

- DUGGAR, J. F. Ala. Expr. Sta., Buls. Nos. 78, 91, 103, 107, 113, 131, 145.
- REDDING, R. J. Ga. Expr. Sta., Buls. Nos. 11, 16, 20, 24, 27, 31, 35, 39, 43, 47, 52, 56, 59, 63, 66, 75.
- CALVIN, M. V., and KIMBROUGH, J. M. Ga. Expr. Sta., Bul. No. 79.
- MCBRYDE, J. B. S. C. Expr. Sta., Bul. (New Series) No. 2, and Rpts. 1888-1889.
- HARPER, J. N. S. C. Expr. Sta., Bul. No. 145.
- WILLIAMS, C. B. N. C. Dept. Agr., Bul. Jan., 1907; and Proc. Southern Asson. Commissioners Agr., 1909. Raleigh, N.C.
- WHITE, H. C. U. S. Dept. Agr., Office Expr. Stas., Bul. No. 33, pp. 169-196.
- WHITNEY, MILTON. U. S. Dept. Agr., Bur. Soils, Bul. No. 62.

## CHAPTER XX

### COTTON—THE CULTIVATION OF THE AMERICAN UPLAND GROUPS

THE modes of tilling and handling a crop of growing cotton, as of any other wide-area staple crop, come to be largely traditional and perfunctory. The fact that such labor is often left to ignorant or uninterested workmen tends to perpetuate this rule-of-thumb. Sometimes the methods are followed with the blindness of a superstition. The cotton-grower, however, must recognize that even the most common daily labor of tillage must rest on principles and reasons, if he is to secure the most satisfactory results; therefore, this subject is worthy of careful and detailed consideration.

**312. Disposal of litter.** — Where cotton is the preceding crop, the first step in preparing the field for another crop of cotton consists in reducing the old stalks to fragments fine enough to be plowed under. This is most economically done by driving a stalk cutter (Fig. 77) along each row, the blades on the cutter chopping the stalks into short pieces. A more common method consists in beating the old brittle stalks with a heavy stick; this is best done during dry weather or on a frosty morning late in winter. Sometimes the stalks are lifted by a plow or by hand and then raked and burned. This latter course

should be avoided except when it may be made necessary by the presence of the cotton boll-weevil.

**313. Methods of plowing.** — The greater part of the area intended for cotton receives only one plowing before the seed are planted. This usually consists in forming ridges or beds. More thorough preparation may be given by first plowing the land level or flush, afterwards forming the beds by a subsequent plowing. The conditions under which this double amount of preparation, namely, first broadcast plowing and then bedding, is especially advisable, are the following:—

1. When the soil is a stiff loam or clay inclined to form clods;

2. When the land has not been cultivated the preceding year, or when the preceding crop is one that has left much vegetation on the surface.

The practice of plowing land twice for cotton, first fallowing it, and then throwing it into beds, is on the increase among the best farmers.

**314. Time of plowing or breaking.** — February and March are the months in which the greater part of the plowing of cotton land is performed. The time of plowing is largely a matter of convenience. The general rule should be that the larger the proportion of clay in the soil, the earlier may plowing be done to advantage, provided the surface be freshened later. The larger the amount of trash to be buried and rotted, the earlier should be the date of plowing. Some farmers begin plowing for cotton in December or even in November. This permits freezes to aid in pulverizing the soil and killing some kinds of cotton insects that spend the winter in the ground.

Early plowing may cause clay land to become too compact before the time for planting. In this case it is desirable, shortly before planting, either to replot the land or to loosen the surface with a disk-harrow. Too early plowing of sandy land increases the loss due to the leaching out of plant-food in the water that drains through the soil. Hence, sandy land, as a rule, is not plowed in the fall. However, it is good practice to plow any soils except the sandiest in the fall, provided some winter-growing crop, such as the small grains, or clovers, or vetches, are sown. The roots of the growing plants largely prevent leaching by appropriating the plant-food that becomes available as the vegetable matter decays. These green crops can be plowed under in the late winter or early spring, or grazed, or otherwise utilized. Plowed soil should be kept covered during winter with growing plants. Fields covered with cowpeas or other dead leguminous plants should not be plowed very early, since early fall plowing would induce rotting and leaching before the cotton plants would be ready to utilize the nitrogen made available by the decay of the legumes.

A small proportion of the area in cotton is plowed only a few days before planting. This incurs the danger that some of the seed may fail to come up in the loose soil, which quickly dries.

**315. Depth of plowing.** — A large proportion of the cotton fields are plowed only 3 to 4 inches deep. It is generally advisable to plow deeper than this, so as to afford a larger amount of available soil-moisture for the benefit of the plants in periods of dry weather, and to increase the feeding area for the roots. However, extreme depth,

as well as extreme shallowness, is to be avoided. Plowing too deep may bring to the surface much of the subsoil, where, for a year or two, it remains infertile and subject to baking or clod-forming. Moreover, the cost of very deep plowing is excessive. A depth of 6 to 8 inches may be regarded as unusually good preparation; this depth should be attained only gradually, that is, by plowing each year only about an inch deeper than the year before. By a gradual and judicious increase in depth, a few farmers have advantageously stirred their soil to even a greater depth than 6 to 8 inches. For very deep plowing the disk plow is a favorite implement (Fig. 80).

When plowing is early, or several months before the time of planting the seed, the depth may well be greater than in late plowing. This is because the earlier plowing permits the upturned subsoil to be improved by the action of freezes and of the air, and because the deeper layer of stirred soil requires a longer time to settle to that degree of compactness most favorable to the germination of seeds and the growth of plant roots.

Even when deep preparation fails to increase the yield the first year, an increase is apt to result in succeeding years. The aim of the cotton grower should be gradually to deepen the layer of plowed soil.

**316. Subsoiling.** — This term means the loosening of the subsoil without bringing it to the surface. It is usually accomplished by first employing an ordinary turn-plow, and then in its furrow running a special subsoil plow (Fig. 78). This latter plow has no moldboard, and merely loosens the subsoil, without displacing it.

Subsoiling is a means of suddenly increasing the depth

of loosened soil. The benefits from subsoiling, when done under the most favorable conditions, are the same as those that result from any form of deep plowing.

However, subsoiling often fails to pay for the extra expense, especially the first year. Some of the conditions under which subsoiling is often unprofitable are the following:—

1. When performed while the subsoil is too wet; often when the surface soil is dry enough for plowing, the wet subsoil is simply "puddled," or injuriously compacted by subsoiling.

2. Subsoiling is usually injurious when it is accomplished so late that there is not afterwards sufficient rain to settle the disturbed subsoil and to destroy the large air spaces between the clods or small soil masses.

As a rule the most favorable time for subsoiling in preparation for cotton is in the late fall or early winter before the lower layer of soil has been saturated by the winter rains.

**317. Forming the ridge or bed.**—Most cotton fields are prepared by throwing together at least four furrow-slices turned up by a moldboard plow. This forms a ridge or bed which is usually 3 to 4 feet wide, and several inches high.

In regions where commercial fertilizers are used, there is first run a furrow in which the fertilizer is placed, and over which the bed is subsequently formed. This center furrow may be either (1) along the line of old cotton stalks, or (2) in the middle or water-furrow of the year before, or (3) it may be run in land already plowed broadcast.

When cotton follows cotton, the plowing to make a center furrow usually serves to lift out the roots of the old cotton plants. This is the first step in preparation and may be taken several weeks earlier than the other steps in plowing.

In certain stiff lands where fertilizers are seldom used, it is a disputed point whether a center furrow is advantageous. Experiments on this point are too few to be conclusive. The use of a center furrow and the consequent deeper and more thorough

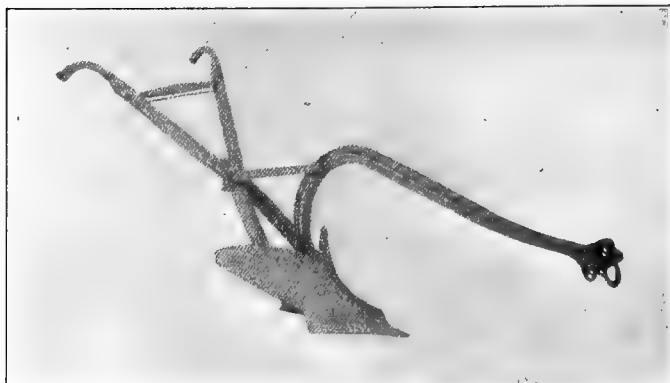

FIG. 149. — A MIDDLE BURSTER, OR DOUBLE MOLDBOARD PLOW.

preparation under the center of the bed is probably advantageous when plowing is performed early; while if plowing is done immediately before planting, a center furrow may leave the soil too loose for the maximum germination of the seed, and for the best growth of the young cotton plants.

In "bedding land" the first two furrows thrown together form a narrow ridge called a "list"; the soil, from the hitherto unplowed strip, or "balk," is usually thrown against each side of the "list" by a turn-plow. But this balk is sometimes split and thrown outward by a single trip of a double moldboard plow, called a "middle burster" (Fig. 149).



**318. Formation of beds by using a disk-harrow.** — A saving of labor may be effected by forming the beds with a disk-harrow instead of with a turn-plow. The use of the disk-harrow for this purpose is practicable only on a field previously plowed broadcast.

**319. Planting cotton level.** — Practically all the cotton of the United States is planted on ridges or beds. However, a few farmers, on well-drained sandy soil, plant late cotton on land that is not bedded, but merely "flushed," or "plowed broadcast." This requires very shallow planting, and also requires very careful early cultivation to prevent covering the plants. The object in planting on a level is to enable the plants better to endure drought.

A method that is generally an improvement on the last named consists in forming low beds; before being planted they are pulled down almost level, by harrowing or dragging them whenever a crust forms or whenever young weeds appear.

**320. Distribution of fertilizers.** — The rows having been marked off, usually with a shovel plow, the fertilizer (if any is to be used) is drilled in this furrow. It is most conveniently put in place by means of a one-horse fertilizer distributor, which also draws earth over the fertilizer. Immediately a "list" is formed. The bed may be completed at once, or more frequently not until the entire area intended for cotton has been thus fertilized and listed. On some farms the fertilizer is distributed by hand, either through a "guano horn" or without this inexpensive device.

**321. Time of planting.** — The usual date for the beginning of cotton planting is two to three weeks after the

*average* date of the last killing frost in that locality. Planting begins in March near the Gulf of Mexico; it begins about April 1 in the central part of the Gulf States; and in the extreme northern part of the cotton-belt it may be delayed until May. In the central part of the cotton-belt most of the crop is planted before May, but an occasional field is not planted until about the first of June. Extremely early planting increases the risk of injury by frost in spring and increases the labor of cultivation. Rather early planting is advisable in regions where the cotton boll-weevil is present. Extremely late planting reduces the labor of cultivation and usually also reduces the yield, many of the immature bolls being destroyed by frost in the fall.

**322. Cotton planters.** — There are numerous forms of planters for cotton. Most of them plant a single row at a time, opening the furrow, dropping the seed, and covering the seed, at one trip (Fig. 150). Probably the most important features about a planter are: (1) provision for constantly agitating the mass of seed, so that the feed may be uniform, and (2) provision for rolling or otherwise pressing the soil around the seed.

If the earth above the seed be rolled, or otherwise compacted, the depth of planting may be as shallow as one inch. The usual depth is from one to three inches.

Some planters drop the seed at regular intervals rather than in a continuous drill. Such dropper-planters may require that the seed be first treated by some method that will serve to lay the fuzz and enable the individual seeds to be separated from the mass. This may be done by adding a little thin flour paste to the dry cotton seed while being shaken in a revolving barrel; or,

on a small scale, by dipping the seed in full strength commercial sulfuric acid, for about two minutes, which removes the fuzz. Immediately the sulfuric acid must be thoroughly washed off of the seed, so as to prevent loss of germinating power.

The most common method of preparing the seed for very thin planting consists in "rolling the seed." This is done by dampen-

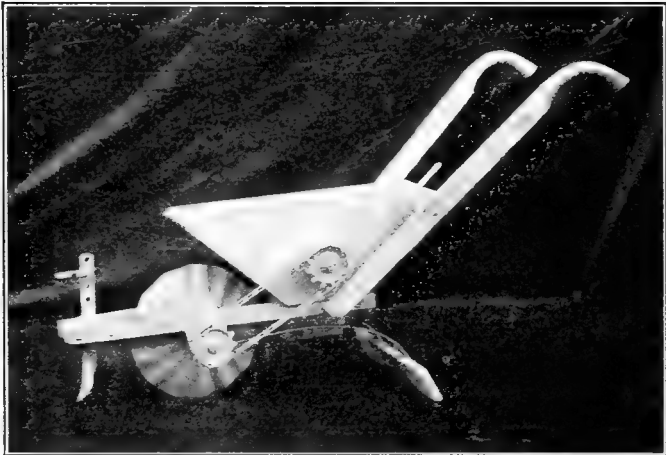

FIG. 150. — AN INEXPENSIVE COTTON PLANTER.

ing the seed, placing them in a barrel fitted with a frame and crank in such a way that it may be revolved; then dry ashes or dust is added, and the barrel revolved, thus causing the ashes or dust to coat each seed, and temporarily to paste down the fuzz.

**323. Quantity of seed.**—A bushel of cotton seed usually contains between 120,000 and 150,000 seeds, or enough, if each one developed into a mature plant, to suffice for fully fifteen acres. However, it is customary to plant 1 to  $1\frac{1}{2}$  bushels of seed per acre. An ideal

planter that places the seed in a narrow drill or in hills requires less; and still less is required when planting is done by dropping the seed by hand in separate hills.

On stiff land, it is regarded as advantageous to have a thick stand of plants, so that the combined strength of the young plants may be exerted to break through the surface crust, which might be too strong for a single plantlet. On the other hand, the presence of only one seed in a place greatly reduces the labor of chopping or thinning cotton.

**324. Broadcast tillage.** — One change which should be made in cotton culture is the introduction of broadcast tillage; that is, of cultivation or tillage across the rows by means of weeders (Fig. 86) or of light, spike-tooth, adjustable harrows (Fig. 85). This kind of tillage permits a larger area to be covered in a day's work of man and team than does any other kind of cultivation. It has the double object of breaking the surface crust before this has become very thick and hard, and of destroying weeds and grass while they are extremely small or merely sprouting. One horse drawing a weeder, or a double team drawing a light, spike-tooth harrow, may cultivate ten or more acres in a day.

As soon as a crust begins to form, there is need for the use of a weeder or light harrow at the following stages in the cultivation of cotton:—

(1) A few days or weeks before planting, in order to break the crust and save the moisture for the germination of the seed soon to be planted.

(2) Following a rain occurring soon after planting, which otherwise would leave too dense a crust to be easily broken by the young plants.

(3) Between the time when the young plants first take on their green color and the time when chopping or thinning is done.

However, it may be impracticable to use either weeder or harrow (1) on stony land, (2) on a field where there is much trash, and (3) where the stand is thin or very irregular.

The judicious use of the weeder or light harrow just before chopping cotton permits this operation to be postponed longer and to be effected with less labor.

**325. First tillage by separate rows.** — As soon as practicable after all the young plants have appeared above ground and have taken on a green color, the first tillage is given with some form of cultivator. The principal objects of this operation are the following:—

(1) To reduce the width of the strip that is subsequently to be thinned by the hoe;

(2) To destroy vegetation;

(3) To put the soil into the best condition for retaining moisture in dry weather and for the growth of the roots of the young cotton plant.

**326. Narrowing the strip to be hoed.** — Since the main purpose of this first operation is to prepare for the more expensive work of chopping, any implement now used must run very close to the line of young plants without throwing much earth toward them. Among the implements used in this operation, which is usually called scraping or barring off, are the following:—

(1) Any ordinary cultivating implement supplied with a fender to prevent the rolling of too much soil on the tiny plant (Fig. 87);

(2) Implements supplied with small points on the side next to the cotton;

(3) Moldboard- or turn-plows, with the bar side next the line of plants, so as to throw the soil away from the row.

While the use of the turn-plow in this first cultivation by rows is perhaps more common than that of any other

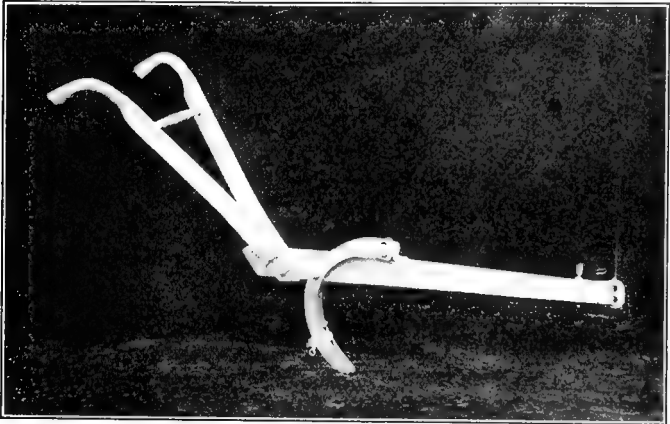

FIG. 151. — ONE FORM OF PLOW-STOCK.

Showing handles, beam, and foot, to the lower part of which sweeps, scrapes, or other implements may be attached.

implement, its use in "barring off" cotton is subject to the following objections:—

(1) It leaves the young plants on narrow high ridges, which quickly dry out.

(2) These narrow high ridges may crumble, pulling the plants down, if heavy rains occur.

(3) The deep plowing by the turn-plow cuts many roots.

Therefore, the turn-plow should be used for barring off cotton only under special conditions; for example:—

(1) When grass has become too large to be easily killed by “scrapes” or by other shallow-working implements. In this case the best means of killing the grass may be by burying it for a number of days, as is done by the moldboard plow.

(2) The deep tillage, such as that given by the turn-plow, may sometimes be desirable on clay soils prepared early and subsequently very greatly compacted by rains, hence needing stirring after the plants come up.

A widely used and generally satisfactory implement for this cultivation or scraping is a narrow sweep or scrape, especially when equipped with a fender. Such a cultivating implement may be one of several similar points attached to a two-horse cultivator or to a one-horse cultivator, or it may be the sole point on an ordinary cultivating “stock,” or plow frame (Fig. 151).



FIG. 152. — A YOUNG COTTON PLANT SHOWING TWO SEED-LEAVES BELOW AND TWO TRUE LEAVES ABOVE.

**327. Chopping or thinning.** — As soon as possible after the operation of scraping or barring off, the plants (Fig. 152) should be thinned by means of a hoe. This first hoeing is called "chopping." Usually either one or two plants are left at the desired distance apart. Much subsequent hoe work is saved if, at the time of chopping, the plants can be safely thinned to a single one at the required distance apart. However, it may be wise to leave two or

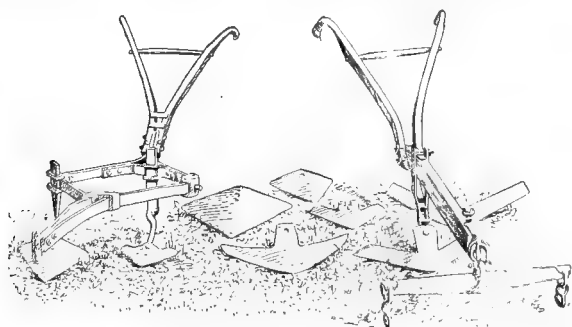

FIG. 153.—VARIOUS FORMS OF SWEEPS AND SCRAPE USED IN CULTIVATING COTTON.

more plants in a place, or twice as many hills as will finally remain, if chopping is done when the plants are extremely small, or if many of the young plants are expected to die as the result of disease or of unfavorable weather.

**328. Second cultivation or "siding."** — The objects in "siding" cotton are as follows: —

(1) To throw close about the plant, for its firmer support, earth that may have been removed from it in the first cultivation or in hoeing.



(2) To form a mulch that will retain the moisture in the soil layer just below it.

(3) To destroy weeds.

Since one purpose is to throw a little earth towards the plants, the scrape or sweep now used may be wider than that used at the first cultivation (Fig. 153). To prevent the small plants being covered, it may still be necessary to use a fender attached to the stock or cultivator (Fig. 87).

This second tillage or cultivation is done by running the cultivating implement close on both sides of each row of plants. Hence, for scraping, two furrows per row usually suffice, where a single scrape or sweep is used.

Siding should sometimes be done as soon as practicable after chopping. But in order to give time for grass to be smothered by the earth thrown on it in "barring off," siding may be delayed.

**329. Third tillage or cultivation, or "cleaning middles."**—If the "siding" just described has been performed with only two scrape furrows per row, there is usually left a low ridge of soil, called a "balk" or "middle," halfway between each two lines of plants. If this strip becomes compact or weedy, the next step is to cultivate it. This is usually done by a single furrow of a rather large sweep or scrape, which splits the "middle," lapping part of it on each of the adjacent rows. When a double cultivator is employed, it cultivates the plants on both sides and throws out the "middles" at the same time. Even when a single scrape is used in "siding," farmers often prefer to throw out the "middle" immediately.

**330. Subsequent tillage.**—The operation of "siding" is repeated as often as necessary to destroy all young weeds

and grass and to prevent the formation after each rain of a crust on the soil, which would hasten the loss of water by evaporation. Likewise, the middles are cleaned or thrown out as often as necessary for the same purpose. The larger the plant becomes, the wider, as a rule, are the scrapes or sweeps employed.

It should constantly be borne in mind that one of the principal objects of tillage is to form a mulch of loose dry soil through which the moisture from the lower layers cannot rise and be evaporated.

**331. Subsequent hoeing.** — The hoeings subsequent to chopping are necessary only when vegetation grows along the line of plants in spite of the earth thrown upon the young weeds in siding. Hoeing is a cleaning rather than a true tillage or mulching process. Next to picking, it is the most expensive operation in cotton culture; hence, as far as practicable, the horse implements should be made to lessen the necessity of hoeing.

**332. Amount and frequency of tilling.** — There can be no fixed rule as to how often cotton should be cultivated. The general rule is to cultivate it before the formation of a crust following each rain. Four "plowings" may be considered the minimum and six or more are often advisable. The total number of furrows per row required in good tillage is usually between twelve and sixteen. In addition to this, two or more hoeings are usually given.

**333. Late tillage.** — Practice varies greatly as to the stage in the life of the cotton plant when cultivation should cease. In most parts of the cotton-belt, tillage is continued through July and sometimes into August. The general rule is that cotton plants that are making less than

a normal growth of limbs and foliage should be cultivated late, while plants of large size may be "laid by" earlier, so as to check the growth of stalk.

After cotton has received what has been planned to be the last tilling, rains sometime occur within a few days, destroying the soil-mulch made by the last cultivation. In this case it is usually advisable to give an additional late cultivation, so as to reestablish the soil-mulch, and to retain the moisture in the soil.

At the final tillage of cotton, the middles are always thrown out.

**334. Depth of cultivation.**—The same principle applies here as in the tillage of any other crop. At the first cultivation, the depth may well be shallow, medium, or deep, as the judgment of the farmer dictates. But in the subsequent tillings, the depth should be shallow; that is, just deep enough to destroy vegetation and to form a soil-mulch thick enough to check evaporation.

Usually a depth of 1½ to 2 inches meets these requirements. The finer the soil particles forming the mulch, that is, the more complete the pulverization effected by the tilling implement, the less the thickness of soil-mulch required to check evaporation. A three-inch mulch of small clods is less effective than an inch mulch of well-pulverized soil.

**335. Sowing seed among growing cotton plants.**—When it is desired to improve the soil by growing, during the cooler months, some soil-improving plant, such as crimson clover or hairy vetch, the time selected for sowing the seed is usually immediately after the first picking. By choosing this time, no cotton is knocked from the

plants by the one-horse cultivator used in covering these seed. On some farms fall-sown oats are sown among the growing cotton plants and covered as just indicated. To permit the use of harvesting machinery in the oats, the cotton plants, if large, are loosened in winter by means of a narrow plow, or by the use of a subsoil plow, and then pulled and removed.

**336. Distance between rows.** — In deciding on the space between rows and between plants of cotton, the general rule is as follows: The richer the land, the wider must be the rows and the greater the distance between plants in the row. This rule is exactly the opposite of the practice in spacing Indian corn. The reason for planting cotton farther apart on rich land is the fact that cotton is a branching or spreading plant, and hence on rich land requires much space for the outward growth of its long branches. On the other hand, corn has no branches and may be crowded as closely together as is permitted by the supply of plant-food and of moisture, both of which are of course more abundant on rich land.

The usual distance between rows of cotton on upland, where a crop of one half bale or less per acre is expected, is  $3\frac{1}{2}$  feet. On highly fertilized upland, the distance may well be increased to 4 feet. On bottom land and other very rich land, a distance of 5 feet is advisable, and occasionally even wider rows are preferable.

The wider the rows can be made without reducing the yield, the cheaper is the cost of cultivation, since work with cultivators is cheaper than work along the rows with the hoe.

**337. Distance between plants in the row.** — Much of the cotton grown in the United States is unduely crowded in the row. A distance of 12 inches may be regarded as the minimum even for very poor land. With almost any character of medium or fair soil, capable of producing one half bale of cotton or more per acre, it is usually better to space the plant at least 18 inches apart.

To increase this distance beyond 2 feet is usually unwise, except when the soil is very rich; in this latter case, it is better to increase the width of the rows than to space the plants much more than 2 feet apart.

By giving ample distance between plants in the drill, the number of bolls per plant is greatly increased. Thus on well-fertilized land, plants spaced 1 foot apart averaged 12.6 bolls per plant, while with double this space, there was an average of 40 bolls per plant. (S. C. Expr. Sta., Bul. No. 140.) In this case the number of bolls per acre and the yield were much greater with the thinner planting.

**338. Results of distance experiments with cotton.** — Most of the experiment stations in the Southern States have conducted experiments on this subject. Naturally the results have varied greatly as influenced by differences in soil, in fertilizer, in rainfall, and in the variety of cotton under observation. In a series of experiments at the Georgia Station, where the yield was a little more than a bale per acre, slightly higher yields were made where the plants stood 1 foot apart than where they were 2 feet apart; a distance of 3 feet between plants afforded a slight reduction in yield; and where the space between plants was increased to 4 feet, the yield was notably decreased.

In the Piedmont region of North Carolina the King variety made as the average of a five years' test the greatest yield when

the plants were spaced 16 inches apart, the rows being 3½ feet wide; in rows 4 feet wide, larger yields were obtained when the spaces between plants were 12 or 16 inches than when the space was greater. In the coast region of North Carolina at the Edgecomb Test Farm, nearly similar results were obtained with the Russell variety.

### LABORATORY EXERCISES

The laboratory work to accompany this chapter should consist of participation in any of the operations connected with cotton culture that may be in progress at the time this subject is studied. In case this is not practicable, field observations on the results of such operations should be made by the student and presented to the instructor in the form of descriptions or drawings.

### LITERATURE

- DUGGAR, J. F. Ala. Expr. Sta., Bul. No. 107.  
REDDING, R. J. Ga. Expr. Sta., Buls. Nos. 43, 47, 52, 56, and 59.  
MACNIDER, G. M., and others. N. C. Dept. Agr., Bul., Feb., 1909.  
MCBRYDE, J. B. S. C. Expr. Sta., Bul. No. 2.  
HAMMOND, HARRY. U. S. Dept. Agr., Office Expr. Stas., Bul. No. 33, pp. 225-278.  
BURKETT, C. W., and POE, C. H. Cotton, pp. 147-168. New York, 1906.  
MERCIER, W. B. Bailey's Cyclo. Agr., Vol. II, pp. 257-258.

## CHAPTER XXI

### COTTON — HARVESTING AND MARKETING

PICKING, ginning (removing the lint from the seed), baling, and compressing into very hard and compact bales for long-distance transportation are the different processes in the harvesting and marketing of cotton; and to these is here added a brief discussion of grades, qualities, and market classes.

**339. Picking.**—The picking of the crop is the most expensive operation connected with cotton culture. The price paid varies greatly, but is usually between 40 and 75 cents per one hundred pounds of seed cotton. This is equivalent to about  $1\frac{1}{2}$  to  $2\frac{1}{4}$  cents per pound of lint, or \$6 to \$11 per bale. In localities where labor is scarce or expensive, the cost of picking is sometimes even above the highest figure just mentioned.

Picking begins in August or early in September. The greater part of the crop is picked in the months of September, October, and November. In some localities considerable cotton is picked in December and a small amount sometimes remains in the field until after Christmas.

A fair day's work for an experienced picker is 150 to 200 pounds of seed cotton; but very skillful pickers, under special incentives, and for a single day at a time, have picked more than double these quantities.



FIG. 154.—AN ALABAMA COTTON FIELD THAT YIELDED ABOUT TWO AND ONE-HALF BALES PER ACRE.



In picking, the principal aims are : (1) rapidity of work, (2) the inclusion of only the minimum amount of trash, and (3) completeness of work, so as not to leave in the bur an occasional lock or piece of a lock. In connection with the latter aim it should be borne in mind that it is sometimes more profitable to leave unpicked a lock of stained or diseased cotton than to include it with the main picking, since it would tend to lower the quality of the entire lot, and to perpetuate disease if the seeds are used for planting.

When locks lying on the ground where they have been stained by dust or mud are included with the main picking of white cotton, the selling price of the whole is lowered. It pays to harvest stained cotton separately or else to leave it unpicked. Cotton picked while wet, unless afterwards very thoroughly dried, makes a poor staple, which sells at a reduced price, because of the fibers broken in ginning damp cotton.

**Yields.** — The average yield per acre in the United States is about 200 pounds of lint, or two-fifths of a bale per acre. However, more than a bale per acre is often grown in productive fields. Occasional yields of more than two bales per acre are obtained (Fig. 154).

**340. Mechanical cotton-pickers.** — The models in the Patent Office at Washington show that numerous cotton-pickers have been invented and that most of these have never been brought into use. However, within the first decade of the twentieth century several cotton-picking machines have demonstrated that they can pick large quantities of cotton, that they can harvest 80 to 90 per cent or more of the cotton open at the time of operation, and that they can pick without including very much more trash than that included by careless hand-picking.

Many of these mechanical pickers are only partly automatic, and require human brains and hands to guide the separate picking devices.

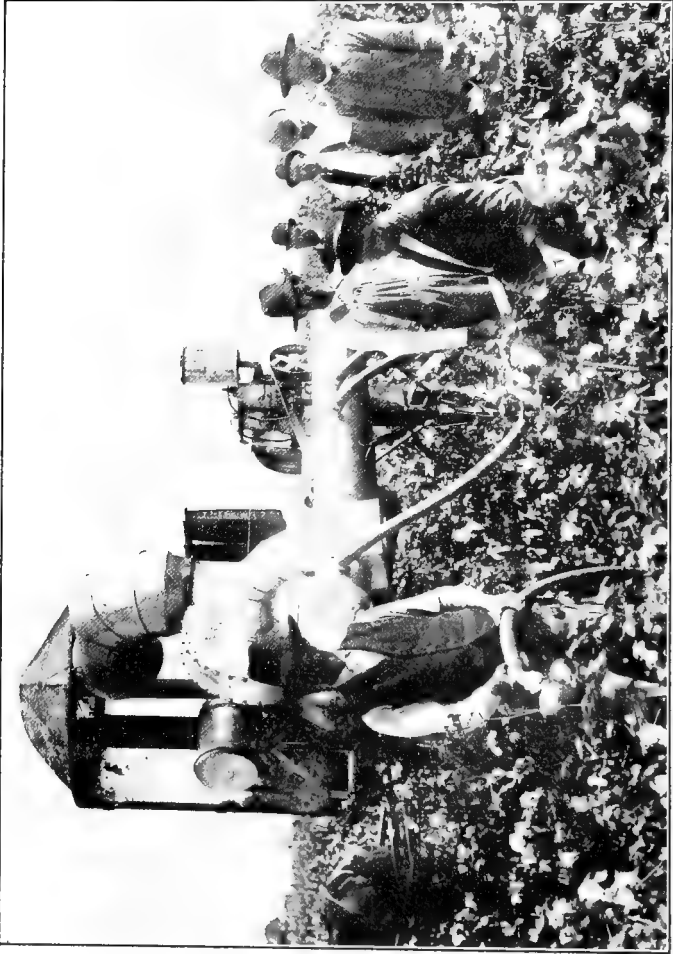

FIG. 155. — THE WORSWICK-HAARDT COTTON PICKER AT WORK.

Some of these machines operate on the suction principle; the open end of a hose pipe is directed by the human hand close to each open boll, when the suction created by a revolving fan on the machine draws the seed cotton through a tube and into a hopper. An example of this class of suction machines is the Worswick-Haardt picker, invented by J. E. Worswick, Montgomery, Alabama (Fig. 155).

Other mechanical pickers entangle the seed cotton by means of innumerable sharp, tack-like points embedded in narrow re-

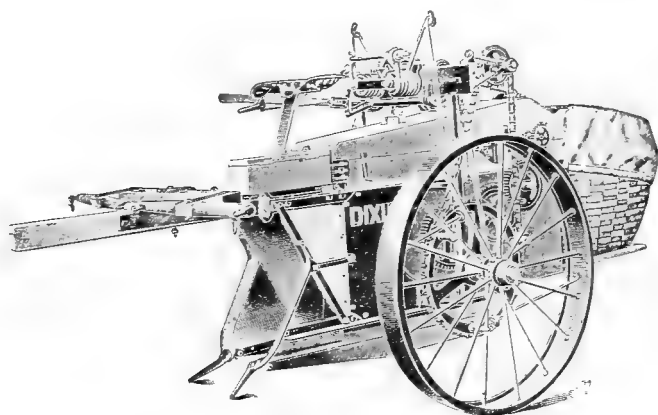

FIG. 156. — THE DIXIE COTTON PICKER.

volving belts, which are directed by human hands into contact with the open boll; the lint is instantly entangled and borne along the revolving belt to the hopper, where it is removed by brushes. An example of such a machine is the Lowry Cotton Picker, invented by George A. Lowry, Boston, Massachusetts.

Among other mechanical cotton-pickers recently advertised are the following:—

The Dixie Cotton Picker, invented by John F. Appleby, Chicago, Illinois (Figs. 156 and 157).

The Oliver Cotton Picking Machine, advertised by Stern & Sons Company, Chicago, Illinois.

The Thurman Vacuum Cotton Picking Machine, manufactured by Vacuum Cotton Picking Machine Company, St. Louis, Missouri.

The Price-Campbell Cotton Picking Machine, invented by Angus Campbell, Pittsburg, Pennsylvania, and exploited by Theodore Price, New York City.

It seems safe to predict that the time is near at hand when cotton-picking machines will harvest a part of the crop where

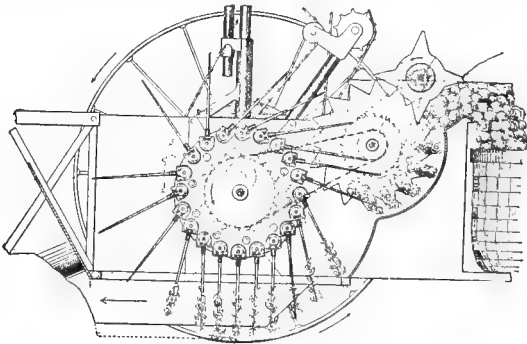

FIG. 157.—VERTICAL SECTION THROUGH DIXIE COTTON PICKER WHEN AT WORK.

the conditions for their work are most favorable and where labor is scarce or expensive. The chief difficulty in the way of their rapid introduction is the high price at which it is now proposed to sell these mechanical pickers.

**341. Ginning.** — After being picked, the seed cotton is hauled to the gin, which is usually a public ginnery, operated by steam power (Fig. 158). There suction pipes lift it from the wagon, and suitable devices carry it through

a cleaner, and thence through the gin, which breaks the lint from the seeds by means of circular saws which revolve at a speed of about 400 to 500 revolutions per min-

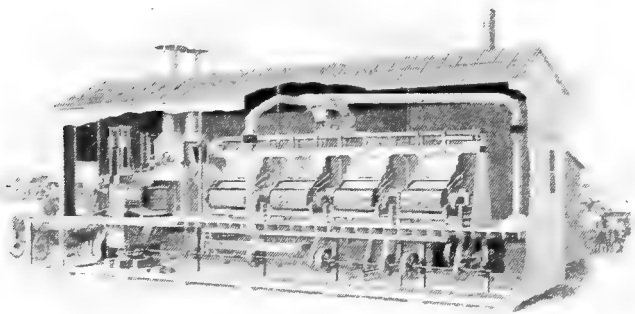

FIG. 158. — SECTION THROUGH A GINNEY.  
Showing four gins, press, suction pipe, and shafting.

ute (Fig. 159). A brush removes the lint from the saws and passes it to a condenser, which presses it into layers.

Cotton ginned when damp affords a poor sample because the gin cuts a considerable proportion of the fibers.

It is generally believed that a better grade or sample is afforded by storing the seed cotton for a few weeks than by ginning it soon after picking.

**342. Baling.** — The fleecy staple is then carried to the press and compacted into rectangular (so-called "square") bales, which usually weigh about 500 pounds each, or about 14 pounds for each cubic foot.

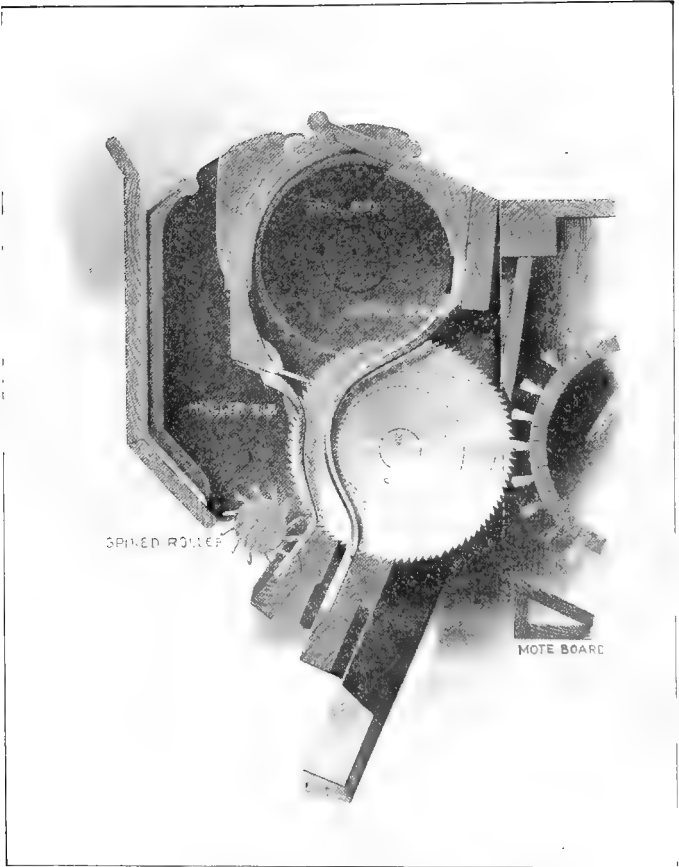

FIG. 159. — TRANSVERSE SECTION THROUGH A COTTON GIN.

The bales are covered with heavy coarse cloth or "bagging." One of the greatest wastes connected with the growing and marketing of cotton in the United States is the failure to use a sufficient amount of bagging and of a quality suitable to prevent the staining of the outer layers of the staple with mud and dust.

The amount of tare (or weight of bagging and ties) which the trade is supposed to allow is 30 pounds on a 500-pound bale; but only on a few bales do the bagging and ties weigh this much, and these are penalized or "docked"; the interest and influence of local buyers is in favor of a light or deficient covering. A general improvement in the amount and quality of covering of the bales of American cotton, which are now more poorly protected than those from any other part of the world, would, in time, redound to the profit of both the farmer and the spinner (Fig. 160).

The round bale, on the other hand, is usually covered very completely with cotton cloth, which affords satisfactory protection. Moreover, the round bale is dense and requires no further compression. But for various reasons the round bale has not been able to come into general use in the face of opposition in the interest of compress men and manufacturers of square-bale presses. The round bale usually weighs about 250 pounds, or half as much as the square bale.

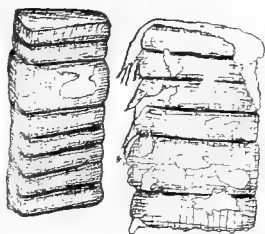

FIG. 160. — FOREIGN AND AMERICAN COTTON BALES.

Showing on the right the inferior covering and torn condition of an American bale, in contrast with the better covering of the foreign bale on the left.

**343. The cotton gin.** — There are two main types of gins, roller and saw gins. The former are used in ginning Sea Island cotton, the naked seeds of which are easily

separated by rollers from the lint. This general type of gin has been in use in India for centuries.

The saw gin, employed to gin short-staple cotton, is a modern machine, which has been second to no other agricultural invention in its effects on the world's wealth, commerce, and comfort. The saw gin has made possible the South's greatest industry, — cotton culture, — and has supplied with fleecy food the textile industries of all manufacturing nations. It was invented by Whitney and Holmes about 1792. Before that time a laborer with his fingers separated about one pound of lint cotton per day.

A single gin of average size accomplishes the work of about 4000 such laborers. Within one hundred years after its invention the saw gin made possible a four-hundred-fold increase in the cotton crop of the United States.

The saw gin is also used in ginning long-staple upland cotton; but to do this without injury to the staple, the usual speed of the saws should be greatly decreased.

When long-staple upland is ginned, care should first be taken to remove from the gin the roll of cotton left by the preceding bale of short-staple; for the mixing of even a little of this with long-staple cotton greatly lowers the selling value of the latter. This is because the spinning machinery in any one mill is arranged for a fiber of a definite length; the admixture of fibers of widely different lengths results in loss to the spinner, either by fibers wasted or by the making of thread of undesirable quality.

**344. Care of baled cotton.** — Since cotton does not readily absorb large amounts of moisture, farmers and warehousemen often leave bales of cotton exposed for weeks or months to the weather (Fig. 161). This results in darkening and weakening the fibers in the outer layers, and consequently in a decreased selling value. Cotton



bales should be kept continuously under shelter. If it becomes necessary to leave them uncovered, they should



FIG. 161. — COTTON BALES LEFT UNPROTECTED FROM RAIN.

rest on poles or timbers laid on the ground, so that no part of the cotton bale touches the moist soil.

**345. Compressing.** — Most cotton that is to be exported, or transported great distances, is first shipped to “compresses,” where the size of the bale is still further reduced by the application of enormous pressure (Fig. 162).

In some processes now coming into use, cotton, as soon as ginned, is immediately compressed into bales of very great density ready for export.

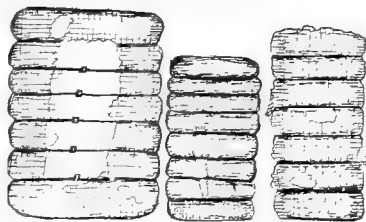

FIG. 162. — SIDE VIEW OF COTTON BALES.

On left, ordinary square bale; in center, bale from gin compress; and on right, ordinary compressed bale.

One great advantage of thus compressing it at the gin is the more complete and careful covering of the bale with new, closely woven cloth (Fig. 163). On the other hand,



FIG. 163. — BALES FROM A GIN COMPRESS.

the ordinary compress utilizes a part of the coarse, heavy, and usually cut or torn covering that was originally placed on the bale at the gin.

**346. Commercial classes or grades of cotton.** — Cotton is bought and sold according to quality or grade. When farmers sell, unless the number of bales be very large, a decision as to the grade or quality is usually made by the buyer, the seller being ignorant, as a rule, of the exact quality of cotton that he is selling. To better enable farmers to know what grade of cotton they sell, most agricultural colleges in the cotton-belt now employ ex-

perts to give instruction in cotton-classing to those students who are pursuing an agricultural course.

In large transactions, especially between business firms or corporations, experts representing both parties pass judgment on the grade, and any difference in classification is arbitrated by disinterested experts.

The classing of cotton cannot be learned without practice under an expert, and never very quickly. The basis or starting point is middling cotton. Contracts are based on this grade, and if other grades are delivered, the difference in grade is settled in cash. The seven principal or "full" grades of cotton, mentioned in order of value, are the following:—

- |                   |                   |
|-------------------|-------------------|
| (1) Fair          | (4) Middling      |
| (2) Middling fair | (5) Low middling  |
| (3) Good middling | (6) Good ordinary |
| (7) Ordinary      |                   |

Between each pair of the full grades mentioned above, are the "half grades," designated by prefixing the word "strict" to the name of the next lower grade; thus strict middling is a half grade better than middling.

In the larger markets use is also made of the "quarter grades," indicated by prefixing the word "fully" or "barely" before the term indicating the grade.

The grades "fair" and "middling fair" are comparatively rare. The greater part of the crop of the Southern States usually consists of the following grades and half grades arranged in order of value:—

- |                       |                  |
|-----------------------|------------------|
| Strict good middling, | Strict middling, |
| Good middling,        | Middling.        |

In years when continued rains occur during the fall, the crop may consist largely of the following still lower grades :—

Strict low middling,  
Low middling.

The grade of cotton is determined by a number of considerations, which have somewhat different weights in different markets. In general, the grade depends principally upon (1) the abundance of trash, (2) the color of the fiber, and (3) the amount of "nep," or tangled, immature fibers. In general, the grades from best to lowest are supposed to express in some measure a decreasing percentage of waste material in spinning.

The preferred color is snow white or slightly creamy, that is, with the faintest suggestion of a yellowish cast. In this matter of color, different markets vary. All markets, however, rate low the samples of cotton which possess even the faintest suggestion of blue, which is a quality usually due to long exposure of the open cotton to the weather, and hence an indication of weakness of fiber.

Strange as it may seem, length of fiber does not usually greatly influence the grade. But this does determine the price; length of staple is considered as "spinning quality" or "character," and is independent of the grade. Thus there is middling cotton of the ordinary short-staple kind, middling "benders," and middling long staple, the three selling at widely different prices.

**347. Tinges and stains.** — If lint cotton shows patches of faint color, it is designated as "tinged"; if the color is decided and distinct, it is classed as "stained." Both

tinges and stains are usually due to contact with red or other strongly colored soil or to injured bolls. The price of stains is somewhat below that of tinges, and considerably below the price of unstained or white cotton of otherwise the same grade. This emphasizes the folly of allowing pickers to mix with white cotton the stained locks that are usually found lying on the ground.

**348. Differences in value between the commercial grades.** — There is no fixed difference in the value of any two grades. The demand determines this difference, which varies from year to year. Usually the following general statements hold true: —

(1) The difference in price between any two adjacent grades of *good* cotton is less than between any two of the *lower* adjacent grades.

(2) When the greater part of any year's crop consists of the lower grades, the difference in price in favor of the upper grades is greater than usual, because of the strong competition, under these conditions, for the small amount of cotton of the upper grades.

(3) As the average price of cotton rises, the difference in price between grades increases, because the lower grades entail a larger percentage of waste in spinning than do the better grades; this waste can ill be afforded when even low-grade cotton sells at a comparatively high price.

The following categories give examples of approximate differences in price that frequently prevail among the usual grades and half grades. The (+) sign indicates a price in cents per pound above that of middling, while the (-) sign indicates that the price is below the middling quotations: —

Good middling . . . . .	+ $\frac{3}{8}$ cent
Strict middling . . . . .	+ $\frac{3}{16}$ cent
Middling . . . . .	0 cent
Strict low middling . . . . .	- $\frac{1}{4}$ cent
Low middling . . . . .	- $\frac{5}{8}$ cent

### LABORATORY EXERCISES

As part of the practice to accompany this chapter a ginnery should be visited, and inspection made of the parts of some gin while it is not in motion.

While it is not advisable for instruction in cotton classing to be given by any except experts of long experience in cotton buying and classing, it may be possible for samples of middling cotton to be procured by the school and for the pupils to become somewhat familiar with its characteristics.

College classes will doubtless be instructed by an expert, who will need a complete set of specimens, or types, which can usually be purchased from the U. S. Department of Agriculture.

### LITERATURE

- HUNT, T. F. *Forage and Fiber Crops in America*, pp. 364-378. New York, 1907.
- BURKETT, C. W., and POE, C. H. *Cotton*. New York, 1906.
- TOMPKINS, D. A. *Cotton and Cotton Oil*. Charlotte, N.C., 1901.
- ROBINSON, T. A. *Classing Cotton*. Stillwater, Okla., 1909.
- MILLER, T. S. *The American Cotton System*. Flat, Texas.
- HAMMOND, HARRY. U. S. Dept. Agr., Office of Expt. Sta., Bul. No. 33, pp. 264-268 and 351-384.
- EARLE, D. E. *Cotton Grading*. Clemson (S.C.) Agr. Col. Exten. Work, Vol. IV., Bul. No. 2.

## CHAPTER XXII

### COTTON — HISTORY AND STATISTICS

COTTON appears to be a native of the tropical parts of both hemispheres. The cotton plant was grown in India many centuries before the beginning of the Christian era. Until about a century ago, India continued to produce most of the world's supply of cotton; it now ranks as second only to the United States in the amount of cotton produced. Gradually the cultivation of cotton spread from India until at least small areas were grown in Egypt and other parts of northern Africa, in Spain (where cotton was probably introduced by the Moors), and in Italy.

Egypt, now the third largest producer of cotton in the world, probably learned cotton culture at a much later date than did the inhabitants of India.

England, which now manufactures more cotton than any other country, apparently did not manufacture cotton cloth until about the seventeenth century.

**349. History in America.** — Columbus found cotton growing in the West Indies in 1492, as did Cortez in Mexico in 1519. Indeed, at that time cotton constituted the principal clothing of the natives of Mexico. A few years later explorers found cotton growing in Peru and Brazil. It is interesting to note that the American Indians inhabiting what now constitutes the cotton-growing states of the Union appear to have been without cotton. But

their contemporaries of nearly all nationalities to the southward grew and used this plant in countries where in modern times its culture has made relatively little progress.

Cotton manufacturing was greatly stimulated by the inventions of Arkwright, Crompton, Cartwright, and Watt

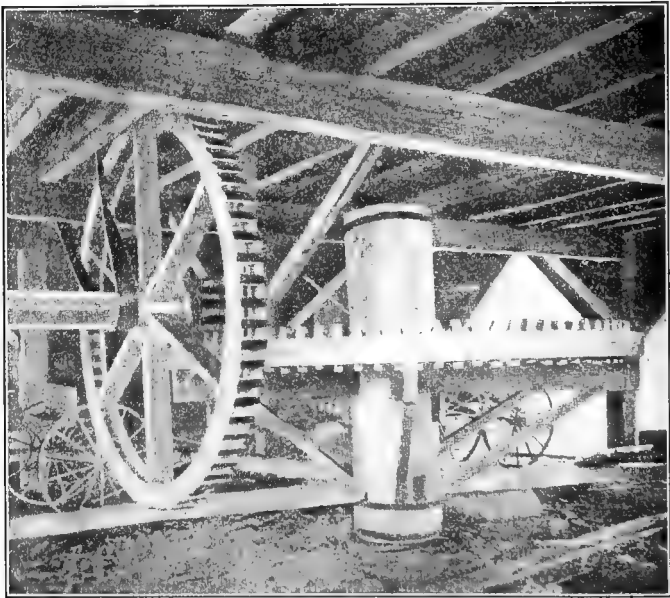

FIG. 164. — THE PROPELLING MECHANISM OF AN OLD HORSE-POWER GIN.

Showing large wheels with wooden cogs. (By permission of D. A. Tompkins.)

in the eighteenth century. To supply the demand for raw cotton thus stimulated, cotton culture was extended in India, along the shores of the Mediterranean, and in



Brazil. At that time the southern part of the United States was producing only a few bales for export and not enough to supply its own people with cotton clothing.

In 1764 the American colonies shipped eight "bags" of cotton to Liverpool, and this probably represented the entire export of that year from the American colonies.

**350. The invention of the cotton gin.** — In 1793, Eli Whitney, then living in South Carolina, applied for a patent on a saw gin. Prior to that time, hand-picking was the rule, and only a rude form of roller gin was known. The immediate effect of the invention of Whitney's saw gin was greatly to increase the production of American cotton. In the period of 116 years, from the invention of Whitney's gin to 1908, the cotton crop produced in the United States increased so that it was nearly six hundred times as large at the end as at the beginning of this period.

Before the general introduction, in the last quarter of the nineteenth century, of public ginneries operated by steam, practically all of the crop was ginned on small plantation gins, propelled by six or eight mules driven in a circle (Fig. 164).

**351. Value and extent of the American cotton crop.** — The American cotton crop is usually between 11,000,000 and 13,000,000 bales. The area of cotton picked in 1909 was estimated at 30,938,000 acres. The lint and seed of a single crop are usually worth about \$750,000,000. Less than two thirds of the lint is exported. Cotton shipped abroad, together with cotton-seed oil and meal, annually brings into the United States about \$500,000,000, or more money than foreign nations send into this country for any other single crop. Moreover, the remainder of the crop

made into cloth in the United States supports one of the most important American manufacturing industries, the cotton textile industry.

Year by year, cotton is coming into wider use. Production and consumption have both rapidly increased. The following table shows how rapidly the cotton production of the United States has increased:—

YEAR	BALES PRODUCED
1790 . . . . .	8,889
1810 . . . . .	269,360
1830 . . . . .	1,038,847
1850 . . . . .	2,454,442
1870 . . . . .	4,352,317
1890 . . . . .	8,652,597
1908 . . . . .	13,432,131

The production of cotton in the United States did not permanently rise above 1,000,000 bales until 1832, nor above 3,000,000 bales until 1851. The crop in round numbers was about 4,000,000 for each of the three years preceding the Civil War. During this war cotton culture was largely discontinued, the production dropping to 300,000 bales in 1864.

Not until 1875 did the annual cotton crop remain permanently above 4,000,000 bales.

From the last table, it may be seen that during the greater part of the past century the annual cotton crop of the United States has practically doubled every twenty years. In very recent years the rate of increase has been slower. Neither the world's market for cotton goods nor the productive capacity of the Southern cotton fields has nearly reached its limit.

**352. Production of cotton seed.**—For each bale of 500 pounds there is usually produced a half ton of cotton seed. The value of the seed produced in 1908 has been estimated<sup>1</sup> at more than \$92,000,000. More than half of the cotton seed produced are manufactured into cotton-seed oil, meal, cake, hulls, and linters,—the latter being a very short, low-priced fiber adhering to the seed after ginning. The remainder of the crop is used as food for cattle, as seed for planting, and as fertilizer.

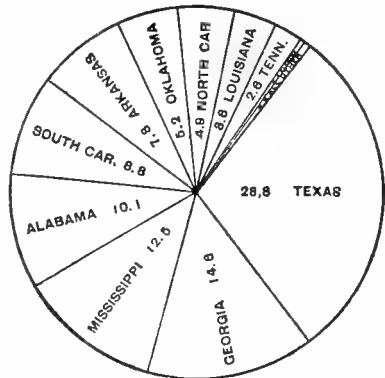

FIG. 165.—PERCENTAGE OF THE TOTAL AMERICAN CROP OF COTTON GROWN IN EACH STATE IN 1908.

**353. Production by states.**—Only ten American states produce large amounts of cotton (Fig. 165). These are the following, named in order according to the average percentage of the crops of 1906, 1907, 1908 produced in each state.

STATE	PER CENT OF AMERICAN CROP	STATE	PER CENT OF AMERICAN CROP
Texas . . . . .	27.0	Arkansas . . . . .	7.3
Georgia . . . . .	14.3	Oklahoma . . . . .	6.6
Mississippi . . . . .	12.4	Louisiana . . . . .	5.7
Alabama . . . . .	9.8	North Carolina . . . . .	4.9
South Carolina . . . . .	8.5	Tennessee . . . . .	2.5

Since Figure 165 gives the percentages for only one year, while the table states the average results for three years, the latter may

<sup>1</sup> U. S. Bur. Census, Bul. No. 100.

be regarded as more reliable. Students will find it interesting to make three-year averages of the crops of still later years in order to note the tendency for cotton culture to increase in certain states and to decrease in others.

Other states together produce about 1 per cent of the crop. In most of the states named above, cotton is the most valuable sale crop produced. The important cotton-growing states embrace less than one fourth of the area of the United States. Yet this small part of the country furnishes the most valuable article of export from the farms of the nation.

Within the past few years the extension of cotton culture in Oklahoma has proceeded more rapidly than in any other state, thus raising this state to a higher position than it occupies in the above table.

*Reports of cotton ginned each year.*—Both the Census Bureau of the United States and the Bureau of Statistics of the National Department of Agriculture devote much attention to the gathering of statistics relative to the production of cotton. Cotton crops grown in 1909, 1908, and 1907, expressed in running bales and in equivalent 500-pound bales, are given in the following table (*Crop Reporter*, Apr., 1910).

STATE	RUNNING BALES <sup>1</sup>			EQUIVALENT 500-POUND BALES		
	1909	1908	1907	1909	1908	1907
United States . . . . .	10,363,240	13,432,131	11,325,882	10,290,395	13,587,306	11,375,461
Alabama . . . . .	1,071,985	1,360,601	1,133,285	1,056,097	1,374,140	1,132,966
Arkansas . . . . .	715,670	1,020,704	770,214	729,329	1,058,089	793,415
Florida . . . . .	62,711	71,923	57,736	54,951	63,221	50,711
Georgia . . . . .	1,897,761	2,026,999	1,901,576	1,849,003	1,980,077	1,855,789
Louisiana . . . . .	268,800	481,979	679,782	263,909	486,350	694,066
Mississippi . . . . .	1,106,170	1,668,461	1,478,689	1,117,287	1,704,972	1,504,303
North Carolina . . . . .	647,747	701,356	652,930	613,799	663,167	619,650
Oklahoma . . . . .	571,370	705,200	870,238	563,170	706,815	882,984
South Carolina . . . . .	1,160,167	1,242,012	1,186,672	1,122,479	1,195,235	1,142,244
Tennessee . . . . .	248,778	349,525	277,114	255,193	359,859	286,301
Texas . . . . .	2,549,417	3,724,575	2,267,293	2,602,356	3,913,084	2,360,478
All other States . . . . .	62,664	78,796	50,353	62,822	82,297	52,554

<sup>1</sup> Counting round as half bales and including linters.

. "The statistics in this report for 1909 are subject to slight corrections. Included in the figures for 1909 are 49,448 bales, which ginner and delinters estimated would be turned out after the time of the March canvass. Round bales included are 150,690 for 1909; 242,305 for 1908; and 198,549 for 1907. Sea-island bales included are 94,566 for 1909; 93,858 for 1908; and 86,895 for 1907. Linter bales included are 314,597 for 1909; 346,126, for 1908; and 268,060 for 1907. The average gross weight of the bale for the crop, counting round as half bales and including linters, is 496.5 pounds for 1909, compared with 505.8 for 1908 and 502.2 for 1907. The number of ginneries operated for the crop of 1909 is 26,660, compared with 27,598 for 1908."

#### 354. Distribution of cotton culture in the United States.

— The northern line of the cotton-belt of the United States extends from near Norfolk, Virginia, in a southwesterly direction to the northeastern part of Georgia; thence in a northeasterly direction through Tennessee and into Kentucky, crossing the Mississippi River just south of the mouth of the Ohio. Thence the line extends almost directly west through the southern part of Missouri, excluding the northwestern part of Arkansas. The cotton-belt includes practically all of Oklahoma and all of Texas except the extreme western part. Small isolated areas producing small amounts of cotton are found in the irrigated regions of New Mexico, California, and other parts of the Southwest.

Within the territory mapped as constituting the cotton-belt, a large proportion of the counties produce only a few thousand bales. These areas in which cotton is a relatively unimportant crop are, (1) the country along the northern edge of the cotton-belt, especially in mountainous sections; (2) parts of the country on the Gulf coast where rice, sugar-cane, truck crops, and forest products supplant

cotton; and (3) the extreme western part of the cotton-belt, where the slight rainfall prevents the extensive cultivation of this crop.

**355. The principal foreign cotton-producing countries.**—The United States produces about two thirds of the supply of cotton used in the world's mills. Next to the

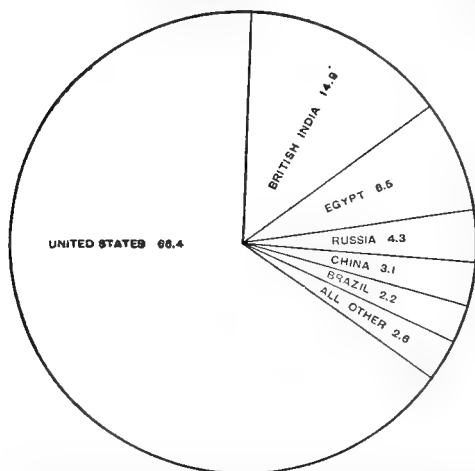

FIG. 166.—PERCENTAGE OF WORLD'S MILL SUPPLY OF COTTON CONTRIBUTED BY EACH COUNTRY IN 1908.

United States, with its twelve to thirteen million bales per year, comes India with an annual crop of about 3,000,000 bales, and Egypt with about 1,300,000 bales.

**356. Countries producing small quantities of cotton.**—Next, with

much smaller quantities, come Russia and its Asiatic provinces, China, Brazil, Mexico, Peru, Turkey, and Persia (Fig. 166).

If account were taken of the unknown quantities of cotton that never reach the mills, but that are converted into cloth in the homes of the people of China, the Celestial Empire would probably rank above Egypt as a cotton-producing country.

**357. Competition in cotton culture.** — It is often said that the United States has a practical monopoly of cotton culture. This is largely true, but changing conditions in all parts of the world make it possible for the foreign grower of cotton to become a more formidable competitor of the American cotton producer than has been the case in the past.

The following facts suggest the possibility of constantly increasing competition from abroad: —

(1) Great efforts have been made during the past few years, especially by the British and German governments in their African possessions, to build up centers of cotton production. These attempts, unlike those made during the Civil War, were made in countries believed to have climatic conditions well suited to the growth of the cotton plant. In some of these countries, notably in German East Africa, British East Africa, and Uganda, these efforts are resulting in a rapid increase each year in the number of bales produced, which suggests that the climatic and other conditions are favorable.

(2) A high price for American cotton always stimulates foreign cotton production. The American farmer expects high prices for cotton in the future, partly because of the injury inflicted on the American crop each year by the boll-weevil in its eastward march. The probable high prices would have the effect of increasing cotton production in Africa and Asia.

(3) Improvement in the methods of cultivation in India can greatly increase the cotton production of that country. Extension of the government's irrigation system will have the same effect. Improvement in the quality

of Indian fiber is possible. Moreover, even a cotton with very short staple, as that of India, is indirectly in competition with ordinary American cotton; for, being cheaper, it is used for many purposes where a staple of greater length could be employed. In 1910 (as a result of a short American crop, with consequent high prices) a small amount of Indian cotton was imported by American mills.

(4) In Egypt the government is extending the irrigation system, thus increasing the area of cultivated land, and making possible even larger yields per acre by reason of more frequent irrigation. However, Egyptian cotton is not directly in competition with American short staple.

On the other hand, among the facts which suggest the freedom of the American producer from serious rivalry by the foreign cotton grower are the following:—

(1) Stimulated by the high prices of cotton prevailing during and just after the Civil War, great efforts were made in numerous foreign countries to stimulate the production of cotton. As a rule these attempts were unsuccessful.

(2) The southern part of the United States is believed to be the only very large area of country having climatic conditions throughout its entire extent exactly suited to the cotton plant.

(3) India, the second in rank among cotton countries, produces chiefly a staple shorter than the American, and hence not generally used by the same mills.

(4) The cultivated part of Egypt is a country of limited area; moreover, the staple produced is longer than the staple of the bulk of the American crop, and hence is used in different mills and for different purposes.



**358. Program for the American cotton grower.** — The best steps for the American cotton grower to take in order to meet any foreign competition that the future may bring forth consist (1) in producing cotton by more intensive methods, which lowers the cost of producing each pound of lint, (2) in more largely employing machinery in the cultivation and harvesting of this crop, and (3) in improving the usual wasteful and slovenly method of covering and handling American bales.

#### LABORATORY EXERCISES

From the latest United States Census Reports on Agriculture, students should calculate: —

- (a) The proportion of the total crop produced by their state;
- (b) The proportion of the crop of their state produced by their county;
- (c) A list of the ten counties in their state producing the greatest number of bales;
- (d) The average yield per acre of lint cotton in the United States.
- (e) The average yield per acre of lint cotton in five selected counties in their state.

#### LITERATURE

- BURKETT, C. W., and POE, C. H. Cotton, pp. 13-74, 301-329. New York, 1906.
- U. S. Census Bur. Latest Publications on Agriculture.
- U. S. Census Bur. Buls. Nos. 100, 107 and later.
- U. S. Dept. Agr., Office Expr. Sta., Bul. No. 33, pp. 13-66, 266-270.
- U. S. Dept. Agr., Bur. of Statistics, Bul. No. 16 and later.

## CHAPTER XXIII

### COTTON—INSECT ENEMIES

THE most destructive insects attacking the flowers or bolls are the boll-worm and the Mexican cotton boll-weevil.

Among the insects most injurious to the foliage are the cotton caterpillar. The cotton red-spider also injures the leaves, and on the young seedlings a plant-louse is sometimes troublesome.

The roots are invaded by a very small animal called the nematode worm. The stems of the young plants are attacked by cutworms and the buds by cowpea-pod weevils.

#### THE COTTON BOLL-WORM.—*HELIOTHIS OBSOLETA*

**359. Life history of boll-worm.**—The boll-worm is one of the most widely distributed enemies of cotton. The only parts of the cotton plant injured are the squares or bolls, which are eaten into and the interior destroyed by the caterpillar stage of a moth. Other plants that are much injured by the same worm are corn and tomatoes. (See corn ear-worm, paragraph 192.)

The parent is a moth (Fig. 167) which may lay more than one thousand eggs. These are laid by preference on the fresh silks of corn, so that the young worm, as soon as hatched, may enter the tip of the ear, where it is commonly

known as the ear-worm. Eggs are laid on all parts of the cotton plant, but especially on the leaves. On hatching, the young worms, which are too small to be easily seen, wander about for a few hours or days, eating small amounts of the surface tissue of the cotton leaves and of the tender growing buds. This is the period in the life of the insect on cotton when it can be most easily poisoned and controlled.

On becoming strong enough to cut into a boll, the worm destroys the contents of one or more bolls (Fig. 168). On reaching full size, it drops to the ground, burrowing usually to a depth of two or three inches below the surface. Here it remains during the pupal stage (Fig. 169), while changing to a moth.

In most parts of the cotton region there are five generations annually produced by the boll-worm, the first three

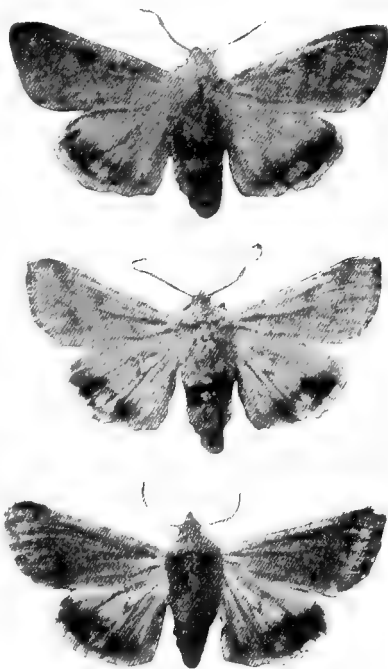

FIG. 167. — MOTHS OF COTTON BOLL-WORM AND CORN EAR-WORM.

Showing the variations in color between different individuals.



FIG. 168.—THE COTTON BOLL-WORM ON THE OUTSIDE OF A COTTON BOLL.

The mass of insect castings near the top of the picture suggests the injury already done to the interior of the boll.

appears, severe injury is done to the squares and bolls of cotton.

360. Preventive measures. - In spite of the great

of which usually feed upon corn. The first and second generations feed on the young leaves in the bud or growing part of the corn plant; the third generation preys chiefly upon the ears of corn in the green or roasting-ear condition, when the insect is known as the corn ear-worm or roasting ear-worm. This insect prefers corn to cotton. Hence it remains on corn as long as the ears are green. After the greater part of the corn hardens, usually in July, and after the third and more numerous generation of worms

injury done to cotton, prevention or poisoning is seldom attempted. Experiments have shown that dusting the plants with a light application of Paris green or other preparation of arsenic destroys many of the tiny worms on the day on which they are hatched and before they are large enough to enter the boll. For poisoning to be most effective, it should begin about the time that adjacent corn ears begin to harden, and it may need to be repeated several times. The poison adheres better if applied while the dew is on the plants.

The most generally practicable method of reducing the injury to cotton consists in using corn as a trap crop.

Strips of corn should be planted about the first of June, or at such times as to bring the corn into the roasting-ear condition about the first of August. Then the moths deposit their eggs on the corn rather than on the cotton plants. The trap crop of corn is still more effective if two plantings are made at intervals of a few weeks, so as to furnish a continual supply of roasting ears during the time when moths are most numerous. These strips of corn may be planted on oat patches adjacent to the cotton fields, or better, 2 to 4 rows of corn may be planted in alternation with 20 to 40 rows of cotton. In order for the corn to serve as a trap crop, it must be planted late, and not at the time when the cotton is planted.



FIG. 169. — PUPAL OR CHRYSALIS STAGE OF THE COTTON BOLLWORM OR CORN EAR-WORM.

Such corn may be cut and fed to live-stock when in the late roasting-ear condition ; or it may be left in the field as usual. In this latter case corn is still help-

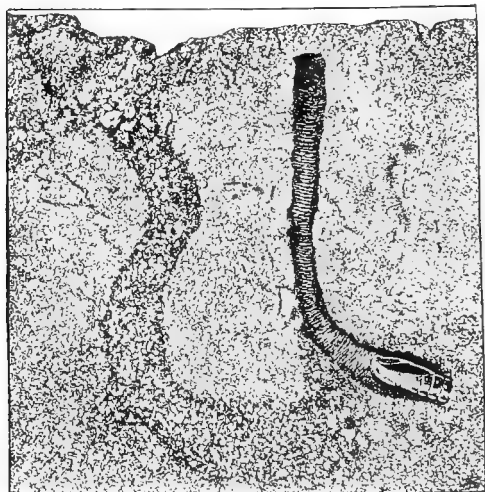

FIG. 170.—PUPA OF BOLL-WORM IN ITS UNDERGROUND BURROW.

ful in reducing the number of boll-worms, since it attracts a number of worms to each ear. Here they devour each other, leaving only one or two alive, instead of many.

Plowing in late fall or early winter

destroys the burrows (Fig. 170) in which the insect passes the winter, and turns the pupæ up to be killed by unfavorable weather.

#### THE MEXICAN COTTON BOLL-WEEVIL. — ANTHONOMUS GRANDIS

**361. Extent of injury.** — The boll-weevil is the most destructive insect enemy that has ever attacked cotton in the United States. When it first invades a new region it sometimes reduces the total production of cotton by

about 50 per cent. Such an enormous reduction as this is not due solely to the smaller amount of cotton produced per acre, but is partly due to reduction in acreage. Fortunately in most of the country west of the Mississippi River, where the boll-weevil has been present for a longer time than anywhere else in this country, farmers, within a few years after the arrival of this pest, have learned to change their methods so as to regain a part or all of this loss. However, even before the boll-weevil had extended beyond Texas and Louisiana, the injury to the cotton crop was estimated at more than \$22,000,000 in one year.

**362. Food of the weevil.** — The injury done by this insect is practically confined to the squares and bolls. The squares are decidedly preferred, and as long as these are present in abundance but little damage is done to the larger bolls. This preference for the squares, rather than for the older forms, makes it possible for farmers to grow cotton in spite of the boll-weevil. This is done by *hastening the early growth of the plants so that many bolls will form and pass the danger point before the weevils become very numerous.* After the weevils become very abundant in August, they sometimes destroy every square in a field, so that no late blooms appear.

The injury is effected both by the mature weevil (Fig. 171), feeding from the outside of the square or boll, and by



FIG. 171. — THE MATURE BOLL-WEEVIL.

Note the *two* projections at the outer end of the first joint of the front legs. (Photo by W. E. Hinds.)

the grub or larval stage within (Fig. 172). The mature insect can live for a short time on the tender leaves or grow-

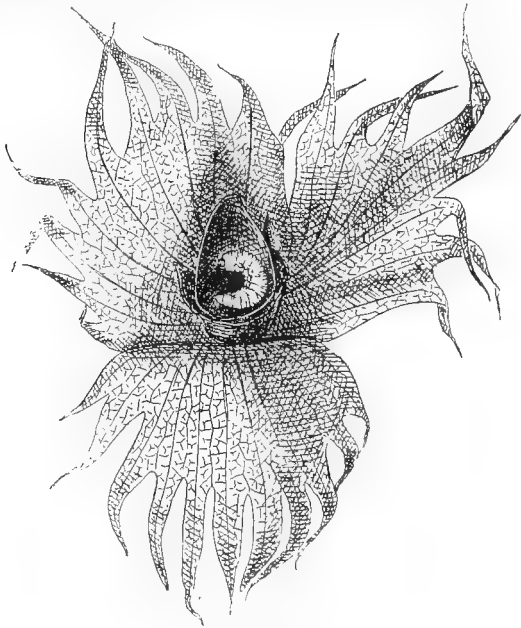

FIG. 172.—COTTON SQUARE SHOWING BOLL-WEEVIL LARVA IN POSITION.  
Natural size.

ing buds of the cotton plant, a fact which is important to remember in considering means of combating this pest.

The cotton boll-weevil does not eat any plant that is widely grown except cotton. This fact is utilized by depriving the insect, late in autumn, of green cotton plants, its only food.



**363. Stages in the life of the boll-weevil.** — In the life of the cotton boll-weevil, as in that of most other insects, there are four stages. These are, (1) the egg; (2) the larval, or grub stage, which is the growing period; (3) the

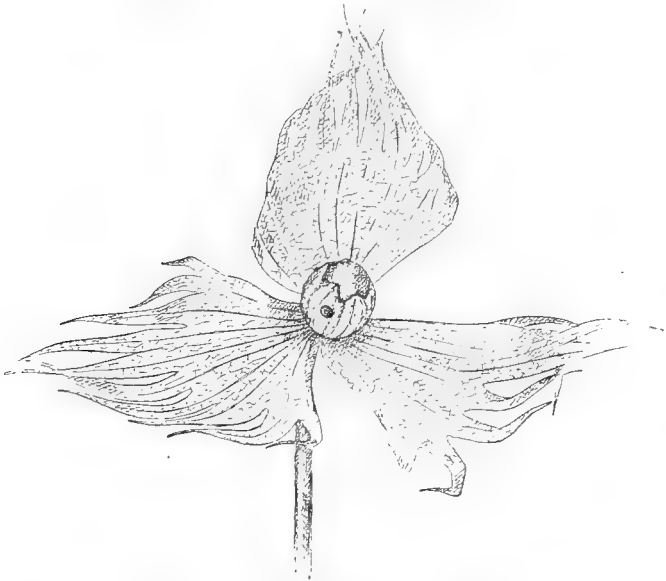

FIG. 173. — PUNCTURED COTTON SQUARE.

Showing egg puncture of boll-weevil and "flaring" of bracts.

pupal, or changing stage, in which this insect is comparatively inactive and in which no food is taken; and (4) the adult or mature stage, which, with the boll-weevil, is the period of activity and of egg-laying.

**364. How the injury is done.** — Injury to the forms,

or young fruits, of the cotton plant are due both to punctures made by the mature weevils for the purpose of obtaining a food supply for themselves, and to the young grubs, which develop within the square or boll where the egg has been laid by the mature weevil.

A few days after an egg has been laid in a square, the color of the latter becomes paler, and the surrounding leafy parts flare, or spread outward (Fig. 173). The square may remain hanging on the plant or it may drop to the ground, carrying the larva or grub within. It was found in experiments in Texas that among the immature insects in the fallen squares, about one third developed into adult weevils. The remainder were killed by their insect enemies or by the rapid drying of the squares where they lay in strong sunlight on the hot soil.

The dead squares that continue to hang to the plants bring forth a larger proportion of mature weevils than do the fallen squares, probably because in the hanging squares larvæ are less exposed to the attacks of their principal insect enemies, the ants. Hence some farmers attempt to brush off as many of these infested squares as possible, by attaching a brush, or a stick wrapped with cloth, to the cultivating implement. Some authorities regard this as impracticable.

The larvæ developing within the bolls may result in the destruction of only one lock or of the entire boll.

Feeding punctures may cause the square to die or the boll to rot.

**365. Rapid multiplication.** — One of the reasons why the cotton boll-weevil is destructive is because it multiplies very rapidly. The time from the laying of the eggs

to the appearance of the mature weevil is less than 25 days. Hinds and Hunter have estimated that the average time between the egg-laying period of any two generations is about 43 days, and that a single pair of weevils coming from their winter quarters in the latter part of spring in Southern Texas, may there, before the occurrence of frost, have 250,000 living descendants. In southern Texas there may be as many as five generations; but in the part of the cotton-belt farther north it is probable that the usual number of generations averages four per year.

**366. Where the winter is spent.**—The boll-weevil passes through the winter in the mature or weevil stage. Therefore the most effective means of fighting the boll-weevil aim at reducing as low as possible the number of adult weevils that live through the winter. Fortunately, of the weevils that go into winter quarters the greater portion die before spring. In Texas and Louisiana the percentage of weevils living through the winter has varied from less than 1 per cent to more than 50 per cent of those that entered winter quarters. The proportion of those that survive can be largely reduced by the destruction of the trash under which they usually take shelter throughout the winter.

The hiding places preferred are: (1) in the empty cotton burs and in other litter in the cotton field; (2) in the fallen leaves and in the bark and moss of the woods; (3) in corn stalks, grass, blackberry patches, and other litter or vegetation adjacent to the cotton fields; and (4) around and in buildings and haystacks.

All of this suggests the need of plowing under deeply,

or otherwise destroying, as much as practicable of the litter and vegetation adjacent to cotton fields and the advisability of keeping the fields in a clean and neat condition.

**367. Principal preventive measures.** — The boll-weevil in its different stages spends most of its life within the cotton forms, and when outside it takes so little food from the surface of boll or square or leaf, that the use of poisons (except in one special case, as indicated below) is useless. The warfare against this pest must be an indirect one, and its aim should be to prevent many insects from living through the winter.

When cold weather approaches, or on the occurrence of a killing frost, boll-weevils enter their winter quarters under all sorts of trash. Experiments have shown that if the weevils can be deprived of their food for a period of several weeks before cold weather occurs, they will be so weakened that most of them die before spring. Hence the best method of reducing the injury in the next crop of cotton consists in plowing, piling, and burning in October, or as soon as possible, the old cotton stalks and all litter adjacent to the cotton fields. Even later burning is beneficial, though to a less extent. Burning the stalks and burs destroys the immature insects inside the bolls and squares, destroys many of the adult insects, and deprives the remainder of food and shelter.

Preparatory to being burned, the cotton stalks are usually uprooted with a double moldboard plow. A special device for cutting the stalks below the ground is shown in Figs. 174 and 175.

A less effective treatment consists in turning a large number of cattle into the cotton fields before frost, so that

they may *quickly* consume all leaves and young forms; this should be followed by the thorough plowing under of the stalks, so as to prevent young sprouts from putting

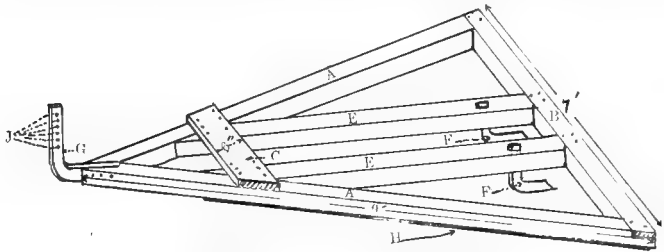

FIG. 174.—COTTON STALK CUTTER.

*H*, Steel blade, bolted to under side of  $4 \times 4$  side piece, and projecting  $1\frac{1}{2}$  inches. (Fully described in Circ. 30, La. Crop Pest Commission, Baton Rouge, La.)

out, for the weevils are able to subsist on these young sprouts. The early destruction of cotton stalks in the fall is advisable, even though one's neighbors should not prac-



FIG. 175.—SIDE VIEW OF COTTON STALK CUTTER.

*H*, Steel blade.

tice it. However, the more general this custom in regions where the boll-weevil is present, the better for every farmer.

**368. Forcing the crop to early maturity.**—Not only should the cotton grower reduce the number of weevils

surviving the winter as directed above, but *he should also force the growth of the cotton plant as rapidly as practicable. The purpose in doing this is to enable the cotton plants to set a large number of bolls before many generations of weevils have had time to come forth.* Bolls of rather large size are not seriously attacked so long as there is an abundance of squares for the weevils then present. Hence the earlier bolls escape injury, and there should be enough of these to make a satisfactory yield.

The methods of forcing the cotton plant rapidly forward are the following:—

(1) The use of varieties which set a large proportion of the bolls early;

(2) The liberal use of fertilizers rich in phosphoric acid, or the growing of cotton on rather rich, well-drained land.

(3) Thorough preparation of the land and frequent cultivation of the crop; and

(4) Early planting.

**369. Minor methods of combating the boll-weevil.**—

One of these consists in poisoning such mature weevils as are present on the growing points or tender buds of the cotton plants *just before the appearance of any squares.* Some of the weevils that survive the winter spend a short time in eating these tender parts of the cotton plant. The poison found most effective is powdered arsenate of lead. This should be applied at the rate of 2 to 2½ pounds per acre and by means of a “powder gun,” which forces the powder into the growing tips, where the weevils are feeding before the appearance of squares. This poisoning can be done advantageously but once, and only in the few days just before the first squares appear

(Fig. 176). While it kills most of the weevils then present, other weevils continue to come from their winter quarters for several weeks after the formation of squares begins. The use of any kind of poison after squares appear is ineffective.

Where the boll-weevil is present, the space between cotton rows should be increased so that the sunshine may more rapidly dry and destroy the fallen squares with the larvæ contained in them. A cultivator which col-



FIG. 176. — COTTON PLANT IN THE "BUDDING" STAGE.

Only at this stage can poison be used against the boll-weevil.

lects the squares in the "middle" where there is most sunlight, is shown in Fig. 177.

For at least a few weeks after the appearance of the weevils, and while there are but few in the fields, it is advantageous, where practicable, to pick the infested squares from the ground and from the plant. These should be burned, or else treated as shown in paragraph 371.

**370. Spread of the boll-weevil.** — Ordinarily the adult weevil flies but a few rods at a time. However, when food becomes scarce in the fall, distances of as much as fifty miles are traversed in a few days. This fall migration, apparently in search of food, explains the rapid spread of the boll-weevil. The weevil usually advances about fifty miles a year. However, in 1909 its eastward spread across

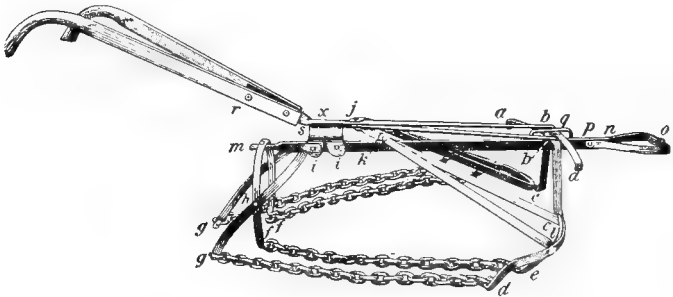

FIG. 177.—THE HINDS CHAIN CULTIVATOR FOR TILLAGE AND FOR DRAWING THE FALLEN SQUARES TO THE WATER-FURROW.

the southern part of Mississippi was more than twice this distance, bringing the weevil at the end of 1909 to within about ten miles of the Alabama line in the vicinity of Mobile. In the fall of 1910 this insect invaded several counties in the southeastern part of Alabama. Probably its extension northward will be somewhat less rapid than its eastward spread.

Crossing the Rio Grande from Mexico about 1892 it has persistently spread eastward and northward. The map (Fig. 178) shows that by the close of 1909 the boll-weevil occupied the greater part of the cotton-growing





FIG. 178. — MAP SHOWING THE AREAS INFESTED BY THE BOLL-WORM EACH YEAR FROM 1892 TO AUGUST, 1910.

areas of Texas and Louisiana, the southern portion of Mississippi, and the southern parts of Oklahoma and Arkansas. It may be expected to spread over the entire cotton-growing area of the United States within the next 15 to 20 years.

**371. Insect enemies of the boll-weevil.** — The weevil has fewer insect enemies than most crop pests. This is probably because the mature weevil is protected with a hard coat, and because in its stages of larva and pupa, when not thus protected, it is inclosed within the square or boll. However, there are some minute insects that lay their eggs in the body of the immature boll-weevil while the latter is still in the square. On hatching, these smaller insects cause the death of the pest. These minute parasites have not destroyed a large proportion of the boll-weevils in Texas, and it remains to be seen whether this class of insects will be more useful in the moister climate of the Mississippi Valley and eastward.

In order to utilize these most fully, the squares that may be picked during the few weeks after the weevils make their appearance, instead of being burned, should be placed loosely in boxes, one side of which is made of screen wire. This should be fine enough (14 meshes to the inch) to prevent the escape of the weevils that may hatch; however, it will permit the escape of their minute insect enemies. If these cages are placed at intervals in the cotton field, it is claimed that these parasites will be turned loose in such quantities as to reduce appreciably the damage done by the boll-weevil.

The *cotton leaf-worm* or caterpillar has been until recently a serious enemy of cotton. (See paragraph 376.) How-

ever, when the boll-weevil is present, the caterpillar should not be poisoned, but treated as an enemy of the boll-weevil, and hence as a friend of the farmer. This is because the cotton caterpillar, by consuming all the foliage of the cotton plant, prevents the formation of squares and thus deprives the weevil of its food in the fall at a time when starvation is most fatal to the insect.

**372. General suggestions on farming after the arrival of the boll-weevil.** — Unless there are special hindrances to the early maturity of the cotton crop, cotton should continue to be grown at a profit after the arrival of the boll-weevil. But this will be possible only for those farmers who practice intensive cotton culture, that is, such methods as in the absence of the weevil will produce nearly a bale per acre. The larger the yield, the greater, as a rule, is the proportion of the crop that matures early, and hence that may be expected to escape injury by this pest. It will be necessary to grow at least as many bales as at present but on a much smaller number of acres.

The presence of the boll-weevil causes farmers to produce their supply of food and forage and to grow for sale a greater variety of farm products and live-stock than before the coming of the weevil. This gives an opportunity for rotation of crops, which enriches the soil and thereby makes easier the production of larger yields per acre of cotton. Rotation is also a means of reducing the amount of injury inflicted on the cotton plant by the boll-weevil.

The wide distribution of this insect may be expected to raise the price of cotton. This higher price, together with the more intensive methods of fertilization and cultivation, and the diversification of crops, should compen-

sate for the greater cost of growing cotton in the presence of the boll-weevil. This insect brings about a revolution in agricultural methods. While the first effects are disastrous, the country in time recovers its usual range of prosperity.

**373. Loss from burning cotton stalks.** — As a means of depriving the boll-weevil of its food, the burning of the cotton stalks in the fall is generally recommended. This decidedly reduces the damage done by the weevil to the next crop on the same land. Since Southern soils are almost universally in need of vegetable matter, the necessity for burning cotton stalks is to be regretted. Should *thorough deep* plowing under of stalks prove effective, it would be far preferable. The loss of vegetable matter and of plant food by burning are considerable.

**374. Pounds of vegetable matter, nitrogen, phosphoric acid, and potash in the stems, roots, and burs on an acre yielding 300 pounds of seed cotton:—**

	AIR-DRY VEGETABLE MATTER LB.	NITROGEN LB.	PHOSPHORIC ACID LB.	POTASH LB.
Analyses at Ala. Expr. Sta.	1097	7.5	3.4	17.5
Analyses at S.C. Expr. Sta.		11.3	2.7	22.7
Average . . . . .		9.4	3.1	20.1

At the usual prices of commercial fertilizers this represents a loss per acre by burning stalks of about \$1.50 for nitrogen, or a total of about \$2.75 for all three constituents. The humus and the nitrogen are completely lost, and the potash and phosphoric acid are practically lost, since they are concentrated in the spots where the stalks are burned.

Cotton stalks should not be burned except where this course is recommended as a necessity in fighting the cotton boll-weevil. Then extra pains must be taken to compensate for the loss by introducing into the rotation at short intervals some humus-forming crop.

#### INSECTS OF MINOR IMPORTANCE

**375. The cowpea-pod weevil** (*Chalcodermis æneus*). — This is a small black beetle or weevil, with a long snout and marked with numerous tiny pits, or depressions (Fig. 179). It injures the young plants, especially the growing terminal buds and the young stems. As the plant grows larger this insect ceases to attack cotton.

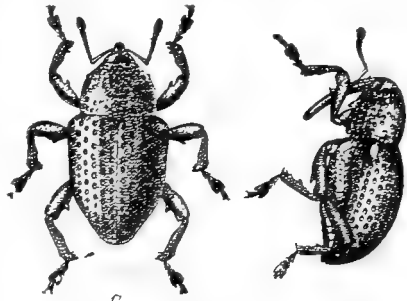

FIG. 179. — COWPEA-POD WEEVIL.

This is the insect most frequently mistaken for the boll-weevil. Conspicuous

differences exist in the shiny, black color and pitted appearance of the cowpea-pod weevil, in contrast with the brownish or grayish appearance of the boll-weevil, which is not conspicuously pitted.

Injury to cotton by the cowpea-pod weevil usually starts in areas where the previous crop was cowpeas. Hence, in some localities where this pest is a serious one, it may be desirable to change the rotation that is generally

advisable on cotton farms, so as to grow no cowpeas just before cotton, substituting some other legume, as velvet beans, or soybeans, or crimson clover.

Liberal fertilization and the use of a little nitrate of soda in the drill at the time of planting hasten the growth of the young plant and thus shorten the time during which it is subject to the attacks of the cowpea-pod weevil and of cutworms. When this insect is present before cotton is chopped, a thick stand should be left, to be thinned to a final stand after the attacks of this insect have ceased.

**376. The cotton caterpillar** (*Alabama argillacea*). — Formerly this was the most destructive enemy of the cotton plant. In recent decades the injury has been infrequent and never widespread. The damage is done by the larval or caterpillar stage of a grayish moth. Eggs are laid on the underside of the leaves, where the larvæ hatch and devour the foliage. On reaching the proper degree of maturity the larvæ fold the leaf together and surround themselves with a web in which the pupa or chrysalis form of the insect is passed. From the pupa emerges soon the adult moth prepared to lay eggs for a new generation of larvæ. The insect passes the winter as a moth.

Complete protection is afforded by dusting or spraying the plants with Paris green or other preparation of arsenic. The most usual method of applying the poison consists in tying a small sack of Paris green alone or mixed with flour, on each end of a stout stick as long as the rows are wide. A man on horseback riding between the rows shakes out a cloud of dust above the row on either side, thus poisoning about 20 acres in a day.

Where the cotton caterpillar and the cotton boll-weevil

are both present, the former may aid the farmer by depriving the boll-weevil of its food.

**377. The cotton red-spider or rust mite** (*Tetranychus gloveri*). — The reddening of the leaves of cotton, often called "red rust," is sometimes due to the attacks of a minute red mite. These tiny red insects, almost microscopic in size, may be seen on the underside of the leaves, usually surrounded by a thin web. Their injury is most severe in wet weather. They are easily spread by laborers or teams. If they are discovered early, before many plants have been attacked, the injured plants and adjacent ones should be pulled and burned. Dusting with powdered sulfur blown on the underside of the leaves has been recommended. However, treatment is seldom attempted. As soon as possible after being picked, the cotton plants on an infested field should be deeply plowed under.

**378. Cotton lice or aphids.** — These are the progeny of small, soft-bodied insects that suck the juices from the growing tips and leaves of the very young cotton plant. They are most troublesome in periods of cool weather. Treatment is not attempted; yet any insecticide that kills by contact would be destructive to the insects, though scarcely practicable.

**379. Cutworms** (*Noctuidæ*). — The cutworms are the larvæ or caterpillar stage of certain night-flying moths. These caterpillars cut down the very young cotton plants. They are most troublesome on land which has grown sod or weeds the previous year. By plowing such land early in the fall and planting it late in spring, the damage from cutworms is reduced. While treatment is not generally regarded as necessary, the worms can be destroyed

by the distribution, a little while before planting, of a mixture of Paris green with either moistened wheat bran or corn-meal, or by other kinds of poisoned bait.

### LABORATORY EXERCISES

Inspection of the cotton fields should be made for the purpose of observing any of the insect pests here mentioned which may be in evidence at the time this chapter is studied, or to note the injuries resulting from their work.

In the absence of such insects a laboratory period should be spent in examining pictures and descriptions of these insects in the publications cited below.

#### LITERATURE

##### **Boll-worm.**

BISHOP, F. C., and JONES, C. R. U. S. Dept. Agr., Farmer's Bul. No. 290.

QUAINTANCE, A. L., and BISHOP, F. C. U. S. Dept. Agr., Farmer's Bul. No. 212.

##### **Boll-weevil.**

HINDS, W. E. U. S. Dept. Agr., Bur. Entomology, Buls. 51 and 74; Ala. Expr. Sta., Bul. No. 146.

HUNTER, W. D. U. S. Dept. Agr., Farmer's Bul. No. 344.

NEWELL, W., and others. Numerous publications of La. Crop Pest Commission. Baton Rouge, La.

##### **Cotton insects in general.**

HOWARD, H. L. U. S. Dept. Agr., Office of Expr. Sta., Bul. No. 33, pp. 317-350.

SHERMAN, F., JR. N. C. Dept. Agr., Bul., June, 1908.

SANDERSON, E. D. U. S. Dept. Agr., Farmer's Bul. No. 223.

Numerous publications of the United States Department of Agriculture, Bureau of Entomology; of the Louisiana Crop Pest Commission, Baton Rouge; of the Georgia State Board of Entomology, Atlanta; and of most of the Experiment Stations in the cotton-belt.



## CHAPTER XXIV

### COTTON — FUNGOUS AND OTHER DISEASES OF COTTON

380. Cotton wilt or black-root (*Neocosmospora vasinfecta*). — This disease shows itself at any time after the cotton plants are about 6 inches high. It is most preva-



FIG. 180. — COTTON PLANTS ATTACKED BY WILT.

lent and destructive while they are loaded with blooms and bolls. Some of the diseased plants suddenly wilt, and these may die in a few days (Fig. 180). Wilting is first shown by the young and tender leaves at the top of the plant. Other diseased plants show a dwarfed, unhealthy

appearance, and may drop their leaves and die, or they may continue to live in an unthrifty condition.

Cotton wilt is caused by a fungus growth, which enters the plant from the soil through the roots. This fungus, or parasitic plant, consists largely of threads, which stop up the water-bearing ducts in the roots and stems. The

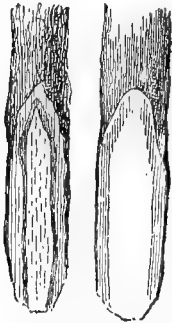

FIG. 181. — SECTION THROUGH WILTED AND HEALTHY COTTON STALKS.

On right, healthy plant; on left, a stem attacked by wilt.

wilting of the leaves is due to the cutting off of their water supply by the plugging up of these ducts with the threads of the fungus.

Cotton wilt may readily be detected by cutting through the main root or stem; the layer just under the bark is blackened, and throughout the stem the cut ends of the stopped-up water-carrying ducts appear as small dark dots (Fig. 181).

### 381. Spread and persistence of wilt. —

Cotton wilt occurs chiefly in the sandy soils of the southern half of the cotton-belt. This disease first appears in small spots in the field. It is extremely important for the farmer to recognize cotton wilt when it first appears and while it is confined to these small spots, for these diseased areas enlarge rapidly every year when cotton is planted on the field. In time the entire field becomes infected, and the majority of cotton plants of the ordinary varieties die. Thus the field soon becomes useless for the cultivation of the common varieties of cotton.

The germs of the disease live in the soil for four or more years, even when no cotton is grown.

**382. Treatment of wilt by means of rotation of crops.** — In spite of this long life of the germ of cotton wilt, the only effective treatment of the soil consists in starving the germs. This is done to a considerable extent by keeping cotton out of the field for three years; a longer banishment of cotton still more nearly gets rid of the disease. Meantime the field may be used for corn, oats, grasses, the Iron variety of cowpeas, and certain other plants.

It has been found that cotton wilt is most prevalent on soils which contain, not only the germs of the wilt fungus, but also the minute worms that cause root-knot (see paragraph 385) on the roots of cotton and of numerous other plants. It is thought that the wounding of the roots of cotton by these tiny nematode worms more readily permits the entrance of the germs of cotton wilt. Hence, in a field where both troubles occur, no plants should be grown on which nematode worms thrive and multiply.

**383. Use of resistant varieties.** — Not every cotton plant in a diseased spot dies. The plants that live and thrive are resistant, and the seed saved from them produce plants, the majority of which are resistant. Thus, by selecting for several generations healthy plants and growing them each year on diseased spots, a variety of wilt-resistant cotton may be bred up. This can probably be done with many varieties. However, present varieties differ greatly in the degree to which they resist cotton wilt. The varieties Dixie and Dillon have been thus bred up by the United States Department of Agriculture, until they are able to produce profitable crops in fields that have been ruined for most other varieties by the presence of this disease.

To maintain the wilt resistance in these or other varieties, it is advisable to grow them on infected land and to continue the selection each year from plants that are thrifty.

**384. Cotton root-rot** (*Ozonium*).— This disease, like cotton wilt, causes the sudden wilting of the plants while engaged in forming fruit. However, it is confined to the extreme western part of the cotton-belt, while cotton wilt is a disease of the southeastern part. Cotton root-rot is especially prevalent on the stiff, lime, "black-waxy" soils of Texas. It is caused by a fungus that develops threads both within and upon the surface of the roots. The roots of diseased plants are covered by whitish threads, which later become darker. Sometimes wartlike bodies appear on the surface.

No treatment of seed or soil is effective. However, very deep fall plowing and rotation of crops are helpful. In such a rotation the farmer must avoid the use of other plants attacked by this disease, among which are sweet potatoes and alfalfa; among the plants not subject to this root-rot are all the grains and grasses.

**385. Root-knot** (*Heterodera radicum*) (Fig. 182).— This is a special kind of enlargement on the roots of many plants, caused by the attacks of extremely small worms, called nematodes. Cotton is attacked, but less severely than are most varieties of cowpeas. Among the plants not attacked are the grains and grasses and the Iron variety of cowpea. The best way to combat this disease consists in starving the worms, by excluding from the field for two years all plants on the roots of which nematodes can develop, including ordinary varieties of cowpeas, and

all other plants having tender succulent roots. Meantime the land may be cropped with any of the grains, with any of the forage grasses, or with peanuts, or with velvet beans, or with the Iron variety of cowpeas, which are all practically exempt from attack.

The root-knot enlargements may be distinguished from the beneficial tubercles occurring on the roots of cowpeas and other legumes as follows:—

When small, root-knot swellings are generally longer than thick, and the swelling is on *all sides* of the root;

while tubercles are always formed on *one side* of the root.

**386. Boll-rot or anthracnose** (*Colletotrichum gossypii*). — This fungus is responsible for the greater part of the rotting of the bolls of cotton. In its worst form, which occurs during damp weather, small discolored depressions appear on the bolls; these spots become grayish and in time become covered with pinkish spores, which in effect are the seedlike parts of the fungus (Fig. 183). Either a single lock or the entire contents of the boll may be rotted. Or the disease may keep the boll from opening widely.



FIG. 182. — ROOT-KNOT OR NEMATODE INJURIES ON COTTON ROOTS.

Dry weather checks the progress of the disease, and it may then appear only as a reddening or spotting of the surface of the boll without serious damage to the crop.



FIG. 183.—ANTHRACNOSE ON COTTON BOLLS.

No method of spraying for the prevention of boll-rot has been devised. But since anthracnose develops most rapidly in the shade, preventive measures consist in (1) admitting the maximum amount of sunlight by widening

the rows; (2) avoiding the use of nitrogenous fertilizers, which induce a rank growth of the plant; and (3) planting those varieties which have not an excess of foliage, and which show partial resistance to this disease. Anthracnose of the bolls is most troublesome on rich land or on that which is highly fertilized, especially with nitrogenous fertilizer. While the worst injury is done to the bolls, this disease also attacks the young seedlings, the stem or branches of the larger plants, and the leaves.

Disinfection of the seed by dipping them in a 3 per cent solution of formalin has been recommended, but not generally practiced. This would have the effect of destroying such germs as might have lodged on the outside of the seed, and hence this treatment might reduce the amount of injury. However, no treatment of the seed can destroy all of the fungus, since this organism penetrates the parts inside the seed-coat or hull. Apparently the use of diseased seed constitutes one of the methods by which boll-rot is propagated. Hence seed from diseased bolls and even seed from badly infected fields should be avoided.

**387. Cotton-rust or black-rust.** — Cotton-rust causes the premature loss of the foliage. This reduces the weight or prevents the maturing of late bolls. It is probably the most widely prevalent destructive disease of cotton. The yield may be reduced by a severe attack of rust as much as 50 per cent.

Several different kinds of fungi are found in the diseased foliage, but these are thought to be unable to gain entrance into the leaves until unfavorable conditions of weather or soil have weakened the plant. Cotton-rust is usually worse in hot weather following a period of heavy rains.

It is much more prevalent on sandy soils than on clay soil, and on poor than on fertile land. It usually occurs in July, August, and September.

The disease comes on with variable symptoms. When the weather is dry, the leaves of the diseased plants usually show at first a mottled yellowish color. After wet weather there may be no yellowing but a sudden blackening, dying, and falling of the foliage.

No remedies can be employed after cotton-rust appears. Prevention, instead of cure, is needed. Any treatment of the soil and any application of fertilizers that promote a healthy but not excessive growth of the cotton plant increase its resistance to rust.

On poor soils of any kind, the addition of vegetable matter by proper rotation of crops is the most widely applicable means of warding off rust. On very poor sandy soils the application of potash usually enables the plant to resist the disease and to retain the greater part of its foliage until the crop is mature. For this purpose at least 80, and better 100 pounds of kainit per acre is advisable, applied in connection with the other fertilizers which may be required on that particular soil.

Where the unthrifty condition of cotton plants is caused by poor drainage, ditching is usually a means of decreasing the amount of rust.

**388. Minor leaf diseases.** — Other diseases of the leaves, which are less destructive than cotton-rust, are *angular leaf-spot* (Fig. 184), which appears earlier than rust; *leaf blight*, in which the diseased areas show as small whitish spots; and *cotton mildew*, appearing on the under side of the leaves. No remedies are in use for any of these diseases.



389. Sore-shin, or damping off (*Rhizoctonia*).—The fungus causing this disease penetrates the stems of the

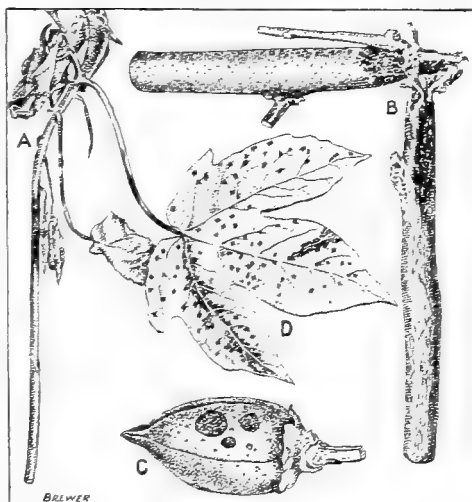

FIG. 184.—DISEASED LEAVES, BOLL, AND STEMS OF COTTON PLANT.

Showing several forms of bacterial blight, known on the leaves as angular leaf-spot; on the stems as black arm; and on the bolls as bacterial boll-rot.

very young cotton plants just below the surface of the soil. Some of the diseased plants die, while others recover. It is worse in wet weather. Any method of hastening the drying of the surface soil is believed to be helpful. This may sometimes be done by passing a weeder or harrow across the rows after the ground has dried sufficiently to permit this. The use of lime has been recommended as helpful in combating a similar disease on certain other crops, but its effects on cotton have not been investigated.

## LABORATORY EXERCISES

The object of any laboratory work in connection with this chapter should be to become acquainted with the appearance in the field of cotton plants attacked by any of these diseases that may be prevalent in the neighborhood of the school or near the students' homes.

## LITERATURE

- STEVENS. Diseases of Plants. Bailey's Cyclo. Agr., Vol. I, pp. 450-453.
- ATKINSON, C. F. U. S. Dept. Agr., Office of Expr. Sta., Bul. No. 33, pp. 279-316.
- ORTON, W. A. U. S. Dept. Agr., Div. Veg. Phys. and Path., and Farmer's Bul. No. 302.

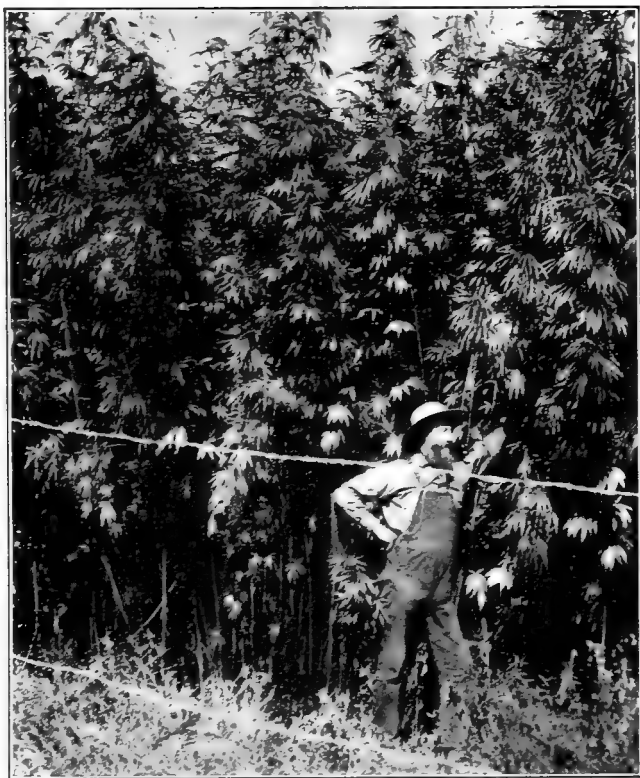

FIG. 185. — A FIELD OF HEMP.

## CHAPTER XXV

### HEMP — CANNABIS SATIVA

HEMP is a member of the mulberry family (*Moraceæ*). It is useful for the fiber, of which burlap bags and twine are made. The plant grows to a height of about ten feet (Fig. 185). It is annual, making its growth during the warmest months.

An interesting fact about hemp is that there are male and female plants. The male plants bear in clusters the flowers containing the stamens or pollen-bearing parts. On the other or female plants are borne the pistils or seed-producing parts. The male plants are preferred for cultivation.



FIG. 186. — LEAF AND FLOWERS OF HEMP.

*a* and *c*, pistillate or female flowers; *b*, staminate or male flowers.

joined together only at the point where the leaf stem ends (Fig. 186).

The most important hemp-producing district in the United States is the Blue-grass region of Kentucky.

**390. Soils for hemp.** — Hemp is at its best on a rich, moist, limestone soil. But it also thrives on other than lime soils if they are moist, but well drained.

**391. Cultural methods.** — The land is plowed flush or broadcast and thoroughly harrowed. The seed is sown through a grain drill run in two directions. This insures a more even stand and a more uniform germination and early growth, both of which are desirable in order to secure plants of the desired diameter, preferably half an inch. The quantity of seed required per acre is one bushel. The date of planting in Kentucky is late in April. No cultivation is given after sowing the seed. Seed originally from China is preferred, though in its first year in the United States it is believed to yield less hemp than during each of the next few years. The small area in Kentucky devoted to hemp grown for seed is planted in checks, with hills about seven feet apart each way, and with four plants in each hill.

The Kentucky Experiment Station found that the use of 160 pounds per acre of nitrate of soda and an equal amount of muriate of potash profitably increased the yield of fiber.

**392. Harvesting and preparing hemp for market.** — Early in the fall hemp is cut, most of it by hand, but part also by special machinery. The stalks are spread evenly on the ground for about a week. Then they are raked together, tied into bundles, and shocked (Fig. 187). The Kentucky Experiment Station found it profitable to stack the hemp, though keeping the hemp in shock saves expense.

Late in November or early in December hemp is retted. This consists in exposing it to cold and rain for about two

months, spread out on the ground for the purpose of favoring the separation of the fiber from the adhering materials.



FIG. 187. — SHOCKING HEMP.

When exposure to alternate freezing and thawing has effected its end, the hemp is again shocked.

The fiber is separated on the farm chiefly by the old device, called the hand-brake. In some regions this work is performed by machinery.

### LABORATORY EXERCISES

In regions where hemp is not grown, it is scarcely profitable to spend a laboratory period on dried specimens and on the literature of this crop. Instead, this laboratory period may well be devoted to some review or additional exercise relative to the principal crop of the region where the school is located.

#### LITERATURE

BOYCE. Hemp. New York, 1900.

DEWEY, L. H. The Fiber Industries in the United States. U. S. Dept. Agr. Yearbook, 1901, pp. 541-544.

HARPER, J. N. Hemp. Bailey's Cyclo. Agr., Vol. II, pp. 377-380.

HUNT, T. F. The Forage and Fiber Crops in America, pp. 394-397. New York, 1907.

## CHAPTER XXVI

### SWEET-POTATO — IPOMŒA BATATAS

#### INTRODUCTORY

THE sweet-potato belongs to the morning-glory family (*Convolvulaceæ*), which also includes a number of common weeds and cultivated flowers. This plant has long been cultivated in the tropical and semitropical regions of both the eastern and the western hemispheres. Its origin is somewhat doubtful, but most authorities regard it as a native of America.

**393. Distribution and climate.** — The sweet-potato is widely grown throughout the warmer regions of America and Asia, as well as to a smaller extent in other countries. This plant requires a warm climate. Its culture on a large scale is confined in the United States to the region lying south of the line drawn through central New Jersey to the southern part of Kansas. North of this line it is sometimes grown, but only on a small scale as a garden vegetable and without the best results in either quality or quantity. A number of the cotton-growing states each produces more than four million bushels annually.

The sweet-potato grows chiefly during the hottest part of the year. In contrast with the Irish potato, it may be called strictly a summer crop, a difference that has an important bearing on the character of fertilizers needed for these two crops.

In the cotton-growing states the sweet-potato may be regarded as a field crop, while north of this region it is treated as a garden crop. Conversely, the Irish potato is a field crop in the North and a garden crop in the South.

There is corresponding confusion in the use of the word "potato." This term, when used without modifiers, usually



FIG. 188.—A FIELD OF SWEET-POTATOES IN ALABAMA.

means, in the Southern States, sweet-potatoes; while elsewhere it signifies the Irish, round, or white potato.

The season that makes the maximum yield and best quality of sweet-potatoes is one in which frequent rains occur during the late spring and the greater part of the summer, but in which there is comparatively dry weather in September and October. Heavy rains near the time of harvest, especially if they follow a long period of drought, are apt to induce a new growth, which results in harm to the quality and keeping properties of the crop.



**394. Description.** — The sweet-potato is perennial, but in cultivation it is treated as annual; that is, new propagating material is placed in the soil each year.

The plant has prostrate stems (Fig. 188), many of which, in the latter part of the season, take root at the nodes. The leaves are extremely variable in shape, and these differences constitute one means of classifying varieties.

The valuable product is botanically an enlarged root. This is an organ for the storage of food, serving to hasten the growth of the young shoots, from which the plant is ordinarily propagated. Man converts this stored material to his own use.

Some confusion arises from the fact that the same word "root," when applied to the sweet-potato, may denote three parts: (1) the enlarged or edible root; (2) the slender, fibrous roots which absorb the plant-food and moisture from the soil, and (3) the potatoes that are too small for market, but which are used for planting. Therefore, in this chapter, the word "potatoes" will be used to designate the large roots, as well as to include the whole plant.

**395. Flowers and seeds.** — The sweet-potato seldom produces flowers in the American cotton-belt, and still more rarely, if ever, are perfect seed matured in this region. However, seeds are sometimes matured when the season of growth is prolonged by keeping the plants in a greenhouse. When sweet-potato seeds are planted, they give rise to young plants differing greatly among themselves and most of them unlike their parents. The best of these seedlings may be propagated in the usual way, and thus give rise to new varieties.

The blooms of the sweet-potato are purplish, and in shape and size resemble those of the larger wild morning-glories.

### COMPOSITION AND USES

**396. Uses.** — The principal present use of the sweet-potato is as a vegetable for human use. It is shipped to the Northern markets in enormous quantities. On farms it is also used as food for live-stock, especially for hogs.

*Analyses of sweet-potato roots, vines, and dried or desiccated sweet-potatoes*

	DRY MATTER	ASH	PRO- TEIN	FIBER	NITRO- GEN- FREE EXTRACT	FAT, ETC.
	%	%	%	%	%	%
Sweet-potatoes, edible roots <sup>1</sup> . . . . .	31.9	1.0	1.6	0.9	27.9	0.5
Irish potatoes . . . . .	21.1	1.0	2.1	0.6	17.3	0.1
Dried sweet-potatoes <sup>2</sup>	89.5	3.0	4.5	1.9	75.7	1.8
Sweet-potato vines, fresh <sup>3</sup> . . . . .	17.0	1.5	2.1	3.1	9.5	0.8

**397. Value as food.** — From the above table, it may be noted that the sweet-potato root is specially rich in nitrogen-free extract, which consists chiefly of starch and sugar. Therefore, in any diet for man or animal, sweet-potatoes should be supplemented by foods rich in protein.

<sup>1</sup> Average of 14 varieties grown at S. C. Expr. Sta. in 1908 (Bul. 146).

<sup>2</sup> Farmer's Bul. No. 129, U. S. Dept. of Agr.

<sup>3</sup> Calculated from average composition of dry matter found in four varieties; S. C. Expr. Sta., No. 146.

On the table, among the dishes rich in protein are peas, beans, milk, eggs, and lean meat. In the diet of animals, suitable foods for supplementing sweet-potatoes are peanuts, the seeds of cowpeas, soy beans, the hay of any of the legumes, and cotton-seed meal. The figures show that the sweet-potato root contains about one and one half times as much nutritive matter as an equal weight of Irish potatoes.

Moreover, the protein, or nitrogenous portion in Irish potatoes, is chiefly in the less valuable form, amides; while it has been found that amides are not present in the mature sweet-potato, all the protein here being in a more valuable form.

Compared with shelled corn, 300 pounds of sweet-potato roots afford slightly more total dry matter and carbonaceous material (as starch and sugar) and a little less protein; the theoretical nutritive value of sweet-potatoes is approximately one third that of an equal weight of shelled corn.

In order to make advantageous use of the sweet-potato as a hog food, it is necessary to use only the unmarketable roots; or else to require the hogs to harvest the crop, thus avoiding the principal item of expense for labor.

**398. Starch and alcohol.** — It seems probable that the sweet-potato will become an important crop for the manufacture of starch, an excellent quality of which has been made from this crop. Sweet-potatoes usually contain 15 to 20 per cent of starch. This is a higher percentage than in the Irish potato, which is now a standard source of starch.

Recent laws permitting, under certain restrictions, the manufacture of denatured alcohol for use as fuel and in the arts, make it probable that the sweet-potato will be advantageously manufactured into this product. A bushel

of sweet-potatoes is expected to make nearly one gallon of industrial alcohol. Moreover, in the manufacture of starch, after this substance is removed, alcohol could be made as a by-product from some of the waste material.

**399. Draft on soil fertility.** — The sweet-potato removes much potash and also rather large amounts of other plant food, as shown by analyses: —

	NITROGEN PER CENT	PHOSPHORIC ACID PER CENT	POTASH PER CENT
Sweet-potatoes, edible roots (N. J.)	0.23	0.10	0.50
Sweet-potatoes, edible roots (S. C.)	.25	.07	.45
Sweet-potatoes, edible roots (Cal.)	.30	.17	.63
Sweet-potatoes, edible roots, average of above	.26	.11	.53
Sweet-potato, fresh vines (Md., water 83 %)¹	0.42	0.07	0.73
Sweet-potato, fresh vines (S. C., 83 % water)²	0.34	0.05	0.48
Fresh vines, average of above	.38	.06	.60

¹ Farmer's Bul. No. 26, U. S. Dept. Agr.

² S. C. Expr. Sta., Bul. No. 146, p. 18.

The roots of sweet-potatoes remove about twice as much potash as nitrogen and about five times as much potash as phosphoric acid. The fresh vines have been found to weigh considerably more than half of the weight of the edible roots and to be richer in nitrogen.

According to the average figures in the above table a crop of 200 bushels would remove in the edible roots alone

31 pounds of nitrogen,  
13 pounds of phosphoric acid,  
64 pounds of potash.

## VARIETIES

**400. Terms used.** — Great confusion exists in the names and qualities of varieties of sweet-potatoes. This is partly due to the fact that many different names are locally applied to the same variety; partly to the ease with which the tubers of different varieties become mechanically mixed; and partly, perhaps, to natural variations occurring in the same variety under different conditions of climate and cultivation.

The word "yam" is used as a part of a name of some varieties. Often it is applied to those varieties having a soft, sirupy texture and flavor; it is also frequently used for varieties having deeply cut leaves; and it has even been applied to those potatoes which have prominent veins on the roots. Its meaning is so indefinite and variable that the term might better be dropped, especially since the word "yam" is properly applied to an entirely different genus of plants, *Dioscorea*, of the yam family, largely grown in the West Indies and elsewhere as food for the natives.

**401. Market demands.** — As a rule the Southern consumer, whether on the farm or in a city, prefers a soft, sirupy potato, which qualities are still further developed by baking, the common Southern method of cooking this vegetable. On the other hand, the Northern markets demand a dry, mealy, or starchy potato, probably partly because the more common method of cooking consists in boiling. It is stated that in the latter part of winter there is more demand than earlier in Northern markets for the sirupy type of potato.

Among varieties popular in the Northern markets are Nansemond and Big Stem Jersey. Probably the most

popular variety among the Southern consumers, when obtainable, is the Yellow Yam, also called Georgia Yam and Sugar Yam. Since this variety is so much less productive than others, it is seldom obtainable, and its place among Southern consumers is taken by the Dooley, which seems to be a synonym of the Pumpkin Yam.

**402. Desirable qualities.** — The qualities most desirable in a variety of potatoes are (1) texture and flavor of the kind demanded by the market for which the crop is grown; (2) productiveness, and (3) keeping qualities.

To supply the market for a few weeks in the latter part of summer, there is also need for early varieties, which, however, are usually inferior in quality to the standard kinds. Examples of early varieties are Nancy Hall and Strasburg.

When potatoes are grown chiefly as a stock food, yield is the main consideration. As a rule, the most productive varieties have a hard texture and high percentage of dry matter, and are not favorites for the table. Among the most productive kinds are Southern Queen, Hayman, Providence, and Shanghai. This class of varieties is also the type best suited to the manufacture of starch and industrial alcohol.

**403. Classification of varieties.** — No system of classification is thoroughly satisfactory. For the sake of convenience, varieties may be divided into four groups as follows: —

Group I. Bunch, or vineless varieties, having short vines, with leaf-stems closely crowded together (Fig. 189); leaves usually deeply cut (Fig. 190).

Group II. Leaves deeply cut ; vines long.

Group III. Leaves shouldered, or very slightly lobed (Fig. 190) ; vines long.

Group IV. Leaves with margins entire or nearly unbroken by lobes or shoulders (Fig. 190) ; vines long.

Each of these groups, except possibly the vineless varieties, may be subdivided into three classes, according to the texture



FIG. 189.—A BRANCH OF A VINELESS SWEET-POTATO PLANT.  
Showing crowded position of leaf-stems. (After Price.)

and flavor, which may be either sirupy, mealy, or intermediate. Each of these subdivisions may be further subdivided into three groups, according to whether the uncooked flesh is yellow, white

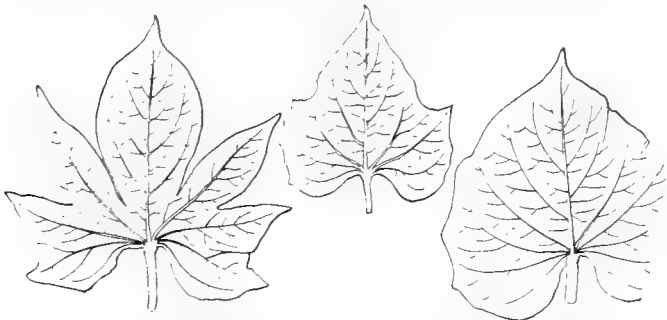

FIG. 190.—THREE SHAPES OF SWEET-POTATO LEAVES.

On left, cut-leaf type ; in center, shouldered leaf ; and on right, entire or "round" leaf.

or mottled white and yellow. Each of these last subdivisions can be still further separated into four divisions, according as the skin of the potato is white, yellowish, light red, or purple (dark reddish). If all of these classes should have representatives, there would be 144 different classes. However, the vineless has only a few subdivisions at the time when this is written.

Examples of the bunch varieties are found in the several strains of vineless, which appear to differ somewhat in quality and yield.

Among the varieties of the cut-leaf type, with long vines, are the following. Sugar, or Yellow Yam, and its synonyms, all of which have a sirupy quality, but are relatively unproductive; the Spanish has cut leaves and a mealy texture.

Among varieties having shouldered leaves is the Yellow Nansmond which has a mealy texture.

Among the varieties with leaves almost entire are Pumpkin Yam, or Dooley, which has a sirupy flavor; and among those with a starchy texture are Southern Queen and Hayman.

### SOILS, FERTILIZERS, AND ROTATION

**404. Soils.** — For the best results in quantity and quality, the soil for sweet-potatoes should have the following properties: (1) It should be mellow, so as not to bake, and so that the roots may easily penetrate it, and fully develop without undue pressure; (2) it should be warm, so as to promote a long period of active growth; and (3) it should be well drained, so that growth may be vigorous and the quality of the crop good. These conditions are best filled by a sandy loam or sandy soil. On a given farm, the soil which contains the largest proportion of sand is usually devoted to the cultivation of sweet-potatoes.

However, this crop is not confined to sandy land. On



some clay soils, especially if rich in lime, large yields are made; but here the crop is later, of somewhat poorer quality, and liable to be of inferior appearance by reason of adhering particles of soil. Moreover, harvesting is more laborious in clay than in sandy soils.

**405. Humus.** — If sweet-potatoes must be grown where there is much clay, there should be also an abundant supply of humus, so as to make the soil mellow and free from a tendency to bake. In fact, whatever may be the nature of the soil, humus is an important constituent for the best results with sweet-potatoes. A favorite method of applying it, especially in regions where sweet-potatoes are grown for market, consists in using pine or other leaves from the woods, which are first employed for a number of months as bedding in the stables or barn lots.

A still more economical method of supplying humus, and with it nitrogen, consists in plowing under a growth of crimson clover a few weeks before setting sweet-potato slips.

**406. Fertilizers.** — As shown in a previous paragraph, both the roots and the vines of sweet-potatoes contain much more potash than either nitrogen or phosphoric acid. Therefore, the fertilizer should be rich in potash. Moreover, sandy soil, the type usually selected for sweet-potatoes, is generally more deficient in potash than is stiffer land.

This crop makes heavy demands for nitrogen also. The cheapest means of supplying it consist in growing a preceding crop of crimson clover, cowpeas, or other legumes.

Acid phosphate has also been found by experience to be needed in fertilizer formulas for sweet-potatoes.

No one formula is best for all soils. The following is only suggestive for soils needing a complete fertilizer under conditions where moderate fertilization is desired:—

- 150 pounds per acre of high grade sulfate or of muriate of potash,
- 250 pounds acid phosphate,
- 150 pounds nitrate of soda (or 320 pounds of cotton-seed meal or tankage).

Potash salts, acid phosphate, and cotton-seed meal or tankage are applied before bedding the land, while nitrate of soda is drilled alongside of each row soon after the slips have rooted and begun to grow.

Farmers in the cotton states are sometimes afraid to use stable manure or other nitrogenous fertilizers, lest the crop "run chiefly to vines." When the fertilizer is properly balanced, — that is, made up of the proper proportion of nitrogen, phosphoric acid, and potash, — there is little, if any, danger that the growth of vines will be excessive. Only by the development of a large growth of vines can a maximum crop of roots be secured; for the starch and other valuable material, of which the roots largely consist, can be manufactured only by an abundance of leaves and other green portions of the plant.

In the parts of New Jersey where this crop is extensively grown for market and large yields are secured, it is not unusual for a farmer to apply 10 tons of manure per acre for sweet-potatoes, in addition to 500 to 1000 pounds of commercial fertilizer.

**407. Place in the rotation.** — Since a field of sweet-potatoes needs to be kept free from grass and weeds at the least expense, it is generally advisable for this crop to follow one which leaves the land clean; that is, relatively free from seeds of weeds and grass. One of the best of such crops to precede sweet-potatoes is cotton.

It is also advantageous that the preceding crop supply a large amount of humus. Cowpeas or velvet beans

answer this purpose well, if so grown as to keep down the growth of weeds. One of the best means of supplying both humus and nitrogen consists in growing a preceding catch-crop of crimson clover, to be plowed under in April as a preparation for sweet-potatoes. The clover seed can be sown among the bearing cotton plants in September, taking care to inoculate the soil, which is usually done by sowing with the seed some soil from a spot where any true clover, — such as crimson, red, or white clover, — has recently grown and developed tubercles on the roots.

**408. Effect on land.** — The large quantities of manures and fertilizers sometimes employed for sweet-potatoes tend to make this field produce good crops the next year, provided the vines be left on the land and somewhat evenly distributed. However, the sweet-potato in itself is an exhaustive crop on account (1) of the large amounts of potash and nitrogen removed and (2) of the leaching of the soil by winter rain, which is apt to be especially great on a field plowed in the fall and left bare of vegetation during winter. To prevent this leaching, it is advisable, where practicable, to sow small grain or some winter cover-crop after harvesting sweet-potatoes.

However, unless the field is securely fenced, stray hogs, rooting for the small potatoes, will often destroy the stand of any winter-growing plant. An additional reason for selecting a fenced field for sweet-potatoes is in order that the small, injured roots may be utilized by the landowner's hogs, without the expense of handling this unsalable part of the crop.

It is generally advisable not to grow sweet-potatoes for two years in succession on the same land. This is partly

because of the removal of large amounts of fertilizing constituents, but chiefly because the crop is subject to several very destructive diseases, which, after being once introduced into the soil, increase in injury to each successive crop.

#### CULTURAL METHODS

**409. How propagated.** — The sweet-potato is propagated without the use of seed. The most common method consists in placing the roots in beds, where, under the influence of proper amounts of heat and moisture, the buds or eyes develop into shoots. These shoots, variously called "slips," "draws," or "sets," are the means by which the greater part of the acreage is grown. A second method consists in cutting sections of vines from plants produced by slips and in setting these vines in the field rather late in the season. A third method, seldom employed, consists in cutting the potato into small pieces and planting these sections just as one would plant Irish potatoes.

**410. Bedding sweet-potatoes.** — About six weeks before setting the slips in the field, the enlarged roots are placed in specially constructed beds, for the purpose of stimulating, by means of heat and moisture, the development of buds and shoots.

The source of heat throughout the greater part of the United States is fermenting stable manure. However, flue heat is employed in the trucking region of New Jersey, Maryland, Delaware, and Virginia, and occasionally elsewhere.

**411. Manure bed.** — A bed to be heated by manure is usually made as follows: In a well-drained, sheltered

spot, the soil is excavated to a depth of six or more inches, and a simple frame made with side and end boards; a layer of moist stable manure, with a depth of four to eight inches, is packed in; and over this is placed a layer of about four inches of fine, loamy soil to keep the potatoes from coming in immediate contact with the manure, which would rot or dry them. It is best to let the excess of heat pass off, by waiting a few days before placing the potatoes in the bed. Then, or as soon as the bed is ready, they are pressed into the soft layer of earth, being placed as near together as possible without touching. They are then covered with a layer of loamy soil, which should cover the most exposed roots to a depth of at least two inches. For an early crop a movable covering of pine leaves, or of cloth, or even a glass sash is sometimes employed. If leaves are used, they must be removed as soon as sprouts appear, to avoid long, tender slips. If glass is used, care must be given to ventilation. A trench around the outside provides for drainage.

When necessary, this bed is watered. Excess of water should be avoided, especially before the sprouts appear above the surface, for watering is usually a cooling process, and it may be a means of baking the surface soil. Keep the surface layer pulverized, so as to decrease evaporation and permit the easy emergence of the young shoots. Of course all grass and weeds must be destroyed while young.

**412. Fire hot-beds.** — These consist of a board floor with an inclosed air space about two feet in depth under the entire area of the floor. The sides of this space are tightly closed by planks and by earth heaped against them; or by the earth walls left in excavating for the bed.

The floor is covered with about five inches of soil, in which the potatoes are bedded and covered with additional soil, just as in the common type of bed. Fire-heated flues are provided underneath the floor.

The slope of the floor should be about 1 foot in 20. The furnace, which is usually 6 feet long by about 2 feet 6 inches in the other dimensions, is made of brick and sunk to such a depth in the ground at the lower end of the bed as to give the necessary slope to the flues. The flues for a bed 12 feet wide usually consist of three lines of six-inch tiles and should extend about 30 feet from the furnace, at which point they empty their heat and smoke into the large air space under the floor. Over the furnace is a layer of soil about 1 foot deep; over the flue the depth of this layer gradually decreases. At the end of the hot-bed farthest from the furnace is a wooden flue about 10 feet long to create a draught and to carry off the smoke; this flue should be provided with a damper to regulate the draft. The effort is to keep the temperature of the soil in which the potatoes are bedded at about 80° to 85° F.

**413. Kind and quantity of potatoes to bed.** — A bushel of small potatoes affords a larger number of slips than does a bushel of roots of larger size. This is because the greater number of small potatoes possesses a greater total surface area from which buds grow out. Farmers give preference for bedding to roots of small to medium size. It has not been proved that small but well-shaped potatoes cause any decrease in the size of the roots of the next crop. However, in the case of a mechanical mixture of several varieties or strains, the exclusive use, year after year, of the ill-shaped, stringy roots would result in time in a crop consisting chiefly of the inferior strain or variety, having the greatest proportion of undesirable potatoes. So far

as present information goes, the small potatoes make just as good " seed stock " as large roots *from the same hill*.

A bushel of medium-sized potatoes covers about 15 to 20 square feet of surface when bedded; a bushel of small roots requires 25 square feet or more of bed. At the first drawing, a



FIG. 191.—SWEET-POTATO SLIPS READY TO BE SET IN THE FIELD.

bushel of bedded potatoes may be expected to afford 800 to 1500 slips, besides which it usually affords a smaller number at the second, and again at the third drawing. For each acre to be set out with the slips from three drawings, it is well to allow at least 2 bushels of very small potatoes and at least double this amount with roots of medium size. To plant the entire area early, that

is, chiefly from the first drawing, these amounts will need to be about doubled. By using vine cuttings, clipped from the plants set out early, the acreage can be increased without additional expenditure for "seed potatoes."

**414. Drawing or removing the slips.** — When the shoots show a length of about 4 inches above ground, or a total length of 6 or 7 inches, and when roots have begun to develop on the lower parts of these slips, they should be drawn and transplanted to the field (Fig. 191). The bed should first be watered. The slips should be so carefully pulled as not to move the "seed potatoes." While not generally practiced outside of the trucking regions, it is best promptly to dip the base of each slip in a stiff batter made of clay and fresh cow manure. The object is to supply moisture until the plant is rooted and to insure the closest possible contact of the plant with the soil-moisture.

By keeping the bed watered, it should be ready to afford a second drawing about 10 to 14 days after the first, and then after a still longer interval, a third drawing can often be made.

**415. Transplanting.** — The rows are first flattened with a harrow or board, so as to destroy the crust and young vegetation, and to insure a soft bed of soil. Then careful growers mark the rows with suitable devices so as to make the plants stand at uniform distances apart. One person drops the slip near its position, and another inserts it in place, carefully pressing the soil around the slip. In setting out potatoes, the farmer uses either a garden dibble or small trowel, or a short sharpened stick; on soft soil the slip is pressed into place by the use of special devices, about as long as a walking-stick, which usually consist of either (1) a



single lath, having a base hollowed out and covered with leather, or (2) wooden tongs made of two laths (Fig. 192).

On many farms, it is customary to wait for a rain and to transplant the slips or vine cuttings only after a rain. If the land has been well prepared and repeatedly harrowed, it is not necessary to wait on the weather. Some growers prefer to set slips without a rain. In the latter case, it is usual to water the plants. The water serves to settle the soil more closely around the stem than would be possible if reliance were placed entirely on the moisture in the soil. After watering sweet-potatoes or any other plant, one must be careful to cover the watered spots with a thin layer of dry soil, to prevent evaporation and baking.

#### 416. Transplanting machines. —



FIG. 193.—A TRANSPLANTING MACHINE.



FIG. 192.—DEVICES FOR SETTING SWEET-POTATO SLIPS AND VINE-CUTTINGS.

When a large acreage is cultivated in sweet-potatoes, it is profitable to employ a transplanting machine (Fig. 193). It sets and waters the plants as fast as the team pulls the machine along the rows. Two men

on seats at the rear drop the plants at the required intervals.

**417. Time of transplanting.** — Bedding may be done about three weeks before the time when the last light frost is expected. The soil must be well warmed before transplanted slips will thrive in the field. In the central part of the cotton-belt, transplanting about April 1 may be



FIG. 194. — SWEET-POTATOES ATTACHED TO A SECTION OF PLANTED VINE.

regarded as early. To determine the last date at which setting in the field may be done with the expectation of a fair yield, a period of at least  $3\frac{1}{2}$  months should be allowed before the usual date of the first fall frost. In this region, it scarcely pays to set slips or vines after July 15; and in general the yield from the late plantings are much smaller than from those made in mid-season.

**418. Propagation by the use of vine cuttings.** — When the bedded potatoes do not furnish enough slips for the desired area, they may be supplemented by setting out in June or early July sections of about 18 inches of vine cut from the early plants. Vine cuttings are usually set out just after a rain by a stick or lath with concave base, pressed down on the center of the vine (Fig. 192).

Roots produced by vine cuttings are preferred for bedding. This is because such potatoes usually escape black rot, a disease which, if present in the bed, is conveyed to the slips by the diseased potatoes. The preference for potatoes from vine cuttings (Fig. 194) may also be due to their greater soundness, sometimes attributable to the late date of planting.

**419. Distance between plants.** — In the cotton states, the rows are usually about  $3\frac{1}{2}$  feet apart. Truckers sometimes plant in narrower rows. In several experiments, a distance of 18 inches between plants afforded larger yields than were obtained either by closer or wider spacing.

**420. Preparation of land.** — It too frequently happens that the land is merely thrown into beds without any previous plowing. For this crop, which makes a large yield per acre and requires a soft, mellow soil for the easy transplanting of the slips and for the full development of the crop, it is profitable to give thorough preparation. This should consist of broadcast plowing, repeated harrowing, and the formation of beds, which are usually thrown up over a furrow in which fertilizer has been applied. Before bedding and after the fertilizer is drilled in, the latter should be thoroughly incorporated with the soil by running

some cultivating implement in the open furrow. It is usually better for the beds to be formed several weeks before the date of transplanting, so as to permit the soil to be settled by rain. The beds should be kept covered with a loose layer of soil and free from crust and vegetation by the repeated use of a light harrow.

To produce the largest yield, the depth of plowing should be considerable, and deep plowing should probably be the rule where the crop is to be used as stock food. However, the market prefers a rather short potato, and this shape is favored by rather shallow plowing; that is, to a depth of not more than 5 inches.

**421. High and low beds.** — While level tillage can be practiced for sweet-potatoes set out late on sandy, well-drained soil, it is probably advisable for the planting, as a rule, to be done on beds; however, these should be pulled down by the use of the harrow until elevated only 3 or 4 inches above the water-furrows. Planting on low ridges affords a warmer, more perfectly drained soil. The extremely high ridges sometimes seen add greatly to the cost of cultivation, and unless the season be very wet, high ridges do not materially increase the yield.

**422. Tillage.** — Cultivation should be given whenever a crust begins to form, or when the first appearance of young weeds or grass makes it necessary. Tillage should be shallow. The most satisfactory implements are those forms of one-horse cultivators equipped with small points, so as to be run as near as possible to the plants without covering them with soil. A scrape or any other implement doing shallow work is also suitable. Just before each cultivation, if the vines have begun to run, they

should be turned into alternate middles, using a stick, so as to get them out of the way of the implement. At the next cultivation, the position of the vines is reversed. Tillage usually ceases when the vines meet across the row, though it is still desirable to pull or remove with a hoe large weeds and bunches of grass.

Some cultivators are equipped with a vine-lifting attachment, which makes it unnecessary to move the vines into alternate middles by hand.

**423. Pruning the vines.** — Experiments have shown that pruning the vines in order to obtain vine cuttings for propagation reduces the yield. The few experiments so far made do not agree in showing any advantage from the custom of lifting or moving the vines late in the season to prevent their rooting at the joints or nodes.

#### HARVESTING AND STORING SWEET-POTATOES

**424. When to dig potatoes.** — The root of the sweet-potato has not reached maturity and condition for storage until, when a cut is made, the wound heals over with a whitish appearance. If the broken place becomes discolored, the potato is immature.

Since the price is much higher in August and early in September than during October and November, a part of the crop may be dug very early, even at a sacrifice of yield and maturity. The bulk of the crop is not dug until about the time of the first fall frost. Some prefer to dig potatoes before they are touched by frost, but the frosting of the vines does no harm if harvesting is then done before the decay extends from the vines to the roots. Late digging,

if the potatoes be not frost bitten, improves the keeping qualities of the crop.

**425. Methods of harvesting.** — The long vines must first be disposed of. They are usually pulled by running a plow on each side of the row. This work is done much more satisfactorily if the line of plants be barred off with a turn-plow, to the beam of which is attached a rolling

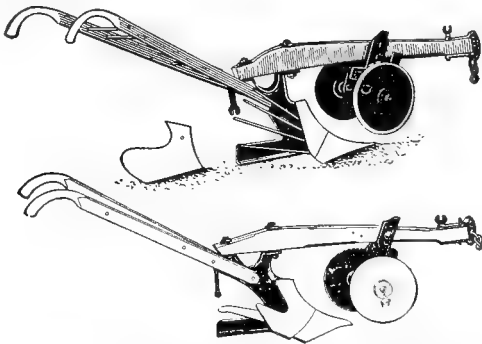

FIG. 195.—SPECIAL PLOWS FOR DIGGING SWEET-POTATOES.

coulter, which cuts the vines close to the row (Fig. 195). The potatoes are then upturned by the use of a large turn-plow.

If the work of harvesting is performed by careful laborers, sorting may be done in the field, the injured and unmarketable roots being gathered in different baskets from those containing the marketable potatoes. With less careful labor, it is better to gather all potatoes together, sorting them at the place of storage or of packing. Extreme care should be taken to avoid bruising the potatoes, since germs of decay enter through bruises and cuts. One means of reducing bruising consists in gathering the roots in small

baskets or boxes, which are not emptied until after these packages are hauled to the place of storing or packing.

Sweet-potatoes for market are generally packed in ventilated barrels covered with burlap cloth, though smaller packages are also used to a limited extent.

**426. Yields.** — The average yield for the entire acreage cultivated in sweet-potatoes in the United States is usually reported as about 100 bushels per acre. Good farmers expect to make fully 200 bushels per acre, and yields above 500 bushels per acre have been repeatedly reported.

The substitution for corn of sweet-potatoes (supplemented by peanuts or other crop rich in nitrogen) as a food for hogs in the fall months is often advisable on sandy soils. For very sandy soils are not well suited to corn, but, when properly fertilized, they make good crops of sweet-potatoes. On such soils it is sometimes as easy to make 200 bushels of sweet-potatoes as to produce 30 bushels of corn to the acre. In this case the amount of nutritive material in the potatoes is about twice as much as in the corn from a similar area.

The sweet-potato largely or entirely loses this relative advantage on richer soils, particularly on those consisting largely of clay.

**427. Conditions necessary in storing potatoes.** — In order that sweet-potatoes may keep in perfect condition throughout the winter, so as to prolong the time of use or to be sold at the higher prices prevailing after Christmas, they must fulfill the following conditions:—

(1) The potatoes when stored must be sound, all bruised, cut, or diseased potatoes being excluded from the storage place.

(2) The roots must be subjected to a certain degree of drying or evaporation, which may be induced either by ventilation alone while the potatoes are kept in the shade, or by exposure to artificial heat, combined with ventilation.

(3) Rats and mice must be carefully excluded.

(4) The potatoes must not be allowed to become so much colder than the air coming in contact with them as to cause the latter to condense or deposit its contained moisture upon the cold surface of the potatoes.

**428. Banking.** — The method in common use in the cotton states by those who store potatoes for home use, or in small quantities for market, consists in keeping them through the winter in conical banks or mounds, each containing 10 to 25 bushels.

To make a potato bank, cut a small circular trench around a well-drained, somewhat sheltered spot. With the excavated earth, slightly build up the ground on which the heap is to stand. Place a layer of straw over this, and on it build up a cone-shaped heap of potatoes around a central ventilator, made of several poles or boards. Cover the potatoes with pine needles or with clean, dry straw. Over the straw or leaves, place a layer of corn-stalks to support the weight of the outer covering of soil. A few weeks later, after the potatoes have gone through a sweat, and before cold weather, place a layer of soil over the corn stalks; and in cold weather, stop the ventilator with a capping of hay. The whole is best inclosed under a cheap shelter of boards, though sometimes the bank is left with no covering except a few boards placed over the ventilator.

**429. Keeping potatoes by the kiln-drying process.** — Where sweet-potatoes are extensively grown for marketing in winter, they are stored in houses of special construction. These are much more satisfactory than banks in all regions.



By the use of such storage houses, labor is economized, and the loss from decay is very greatly reduced.

In special potato houses, even in the cotton-belt, artificial heat is advantageous, especially during the sweating period and during the coldest weather in winter.

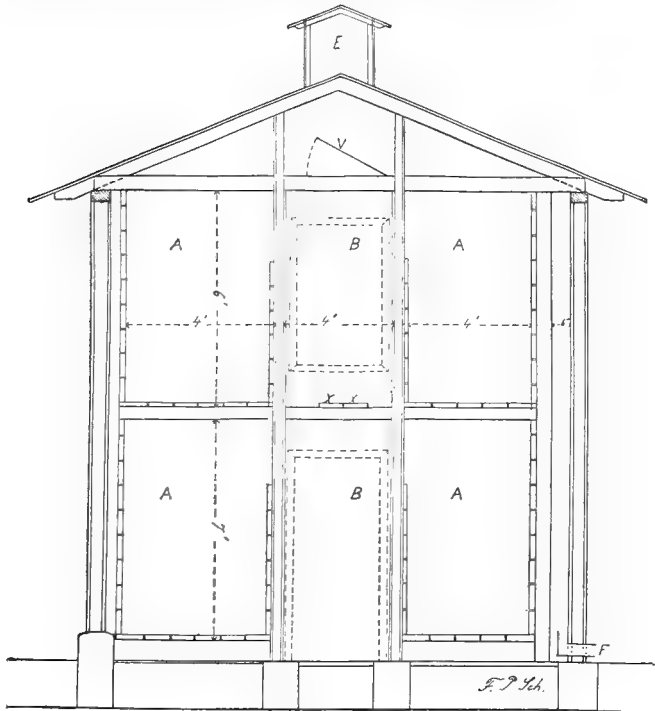

FIG. 196.—END VIEW OF A HOUSE FOR STORING SWEET-POTATOES.

*A, A, A, A*, Bins, four feet wide, with slatted floor and walls; *B, B*, passageways above and below, with doors at ends; *V*, ventilating door; *x, x*, loose boards forming floor of upper passageway.

**430. Example of a sweet-potato house.** — Storage houses may vary in capacity from a few hundred bushels to several thousand. The construction and management of such a house, used by an Alabama farmer, may serve as an example. The essential features of such a house are the following: (1) double walls filled with sawdust and a layer of sand or sawdust above the ceiling; (2) one or more ventilators, and transoms over the doors; (3) bins slatted on all sides and bottoms, so that the air has free access. Figure 196 supplies additional information regarding some of the details.

An ordinary stove is placed in this house, with stove-pipe and flue. For the first few weeks after the potatoes are stored, fire is kept burning to drive off surplus moisture and to prevent sweating. Again, in cold or damp weather in winter, fires are maintained in order to keep the air inside warmer and dryer than that outside. In this latitude the main purpose of fires and of a ventilator is to prevent the condensation of the moisture of the air upon the cool surface of the potatoes. The temperature within this particular house varies between 40° and 70°, after the curing process is complete. In the sweet-potato districts, where such houses are in common use, the temperature for the first few weeks is kept at about 90° F., during which time ample ventilation is given to carry off the evaporated moisture. The preferred winter temperature within a sweet-potato house is around 50° and always, if possible, below 65°.

## ENEMIES

**431. Insects.** — The sweet-potato has relatively few very injurious insect enemies. However, in some fields in Texas and Louisiana the sweet-potato root-borer or weevil (*Cylas formicarius*) is very destructive, since it tunnels

through and ruins the maturing potatoes (Fig. 197). No treatment is known except to avoid storing or bedding any infested roots, which may be recognized by the burrows within them. Care should be taken to avoid intro-



FIG. 197.—CROSS SECTION THROUGH A SWEET-POTATO, SHOWING INJURIES BY SWEET-POTATO ROOT-BORER.

ducing this serious pest on sweet-potatoes brought eastward from the infested regions.

For various leaf-eating insects, occasionally attacking the foliage of this plant, the recommendation is to dip the slips, before being set, in a solution of arsenate of lead,

and, if necessary, to spray the vines with this or with Paris green. Cutworms may be poisoned before setting the slips, as suggested in paragraph 379.

**432. Fungous diseases.**—The enlarged root of the sweet-potato is subject to various forms of decay, each one due to a different germ or disease-producing organism. The most serious of these is the following:—

*Black-rot* (*Sphaeronema fimbriatum*).—The presence of this fungus within the potato root causes black spots on the surface (Fig. 198). These spots are slightly depressed, and the dark color extends deep into the enlarged root, which completely decays in the field or during storage. If diseased potatoes are bedded, the slips are also diseased. The *remedies* consist in (1) bedding no tubers thus diseased; (2) destroying any slips on the white stems of which are found any dark spots; and (3) rotation of crops,

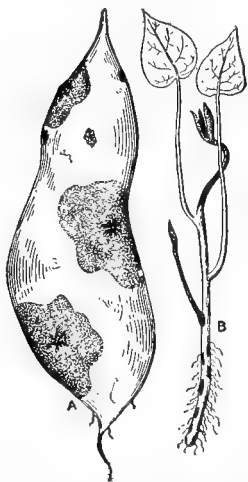

FIG. 198.—BLACK-ROT ON ROOT AND SLIP OF SWEET-POTATO.

avoiding the planting of sweet-potatoes for two years in succession on the same land and avoiding any land where this disease has occurred in recent years.

In addition to these measures, J. L. Winslow soaks the roots for five minutes just before bedding, in a weak solution of formalin, using 1 ounce of this liquid to 8 gallons of water. He also dips the slips into a slightly stronger solution of formalin. It is

improbable that this treatment destroys that part of the fungus lying below the surface, but it doubtless reduces the amount of disease. No slips should be purchased without a guarantee that they are grown from potatoes known to be free from black-rot.

*Soft-rot* causes stored sweet-potatoes to shrivel and decay. To minimize this injury, avoid bruising the sweet-potatoes and remove and burn all diseased roots as soon as seen.

For *dry-rot*, destroy all diseased roots. Sweet-potatoes are also attacked by other diseases. The general recommendation is to avoid growing this crop twice in succession on the same land or even at short intervals.

### LABORATORY EXERCISES

1. If practicable, prepare and plant a propagating bed of sweet-potatoes. If this cannot be done, place at least a few sweet-potatoes in damp soil in a box kept in a warm place. As soon as buds and shoots develop make drawings of

- (a) A sweet-potato, with sprouting buds, and of
- (b) A detached slip or shoot long enough to be transplanted, showing especially the location of the roots.

2. Make a drawing showing the position and direction of the enlarged roots (potatoes) as they grow in the soil.

3. Students should participate in any of the operations connected with the growing of this crop, which may be in progress when this chapter is studied.

4. If this subject is studied in the fall, a storage bank of sweet-potatoes should be made by the students, or else inspection made of a bank or potato-house on some farm in the neighborhood.

### LITERATURE

- FITZ, JAMES. Sweet Potato Culture. N. Y., 1890.
- PRICE, R. H. Sweet Potatoes. Buls. Nos. 28 and 36, Tex. Expr. Sta.
- DUGGAR, J. F. Sweet Potatoes. Farmer's Bul. No. 26, U. S. Dept. Agr.

- NESBIT, D. M. Sweet Potatoes. Farmer's Bul. No. 129, U. S. Dept. Agr.
- MORGAN, H. A., and BURNETTE, H. F. Sweet Potatoes. La. Expr. Sta., Bul. No. 22.
- BURNETTE, H. F. Sweet Potatoes. Bul. No. 30.
- NEWMAN, J. S. Southern Gardener's Practical Manual, pp. 120-155. 1906.
- WAITE, M. B. Sweet Potatoes. Bailey's Cyclo. Agr., Vol. II, pp. 613-623.
- DUGGAR, B. M. Fungous Diseases of Plants. pp. 344, 348-349. New York, 1909.

## CHAPTER XXVII

### CASSAVA — MANIHOT UTILISSIMA

CASSAVA, in tropical countries called manioc, is a shrub 4 to 10 feet high, which, in general appearance and foliage, somewhat resembles the castor bean plant (Fig. 199). Cassava belongs to the milk-weed family (*Euphorbiaceæ*). Its native country is Brazil, but it is now cultivated in many tropical and semitropical regions.

**433. Kinds.** — Cassava has been divided into two classes, namely, the bitter and the sweet. Bitter cassava is the kind generally grown in the tropics. It requires more than one year to make its best growth and has not been cultivated extensively in the United States. Sweet cassava is the kind grown in this country.

**434. Climate and distribution.** — The cassava requires a season of about seven months



FIG. 199. — CASSAVA PLANT, SHOWING STEMS AND ENLARGED ROOTS.

without frost, and the yield is larger if this period is still longer. While the plant has been grown north of the central parts of the Gulf States, yet its cultivation is scarcely practicable above the southern third of these states. The plant is very sensitive to frost. Moreover, its northward extension is limited by (1) the difficulty of saving through winter the stems, used as propagating material, and (2) by the fact that where the ground freezes it is impracticable to leave the roots in the ground until they are needed for use.

**435. Uses and composition.** — The only valuable portion of the cassava plant is the root. From each plant grow 4 to 8 roots in a cluster, each of which is usually 1 to 2½ inches in diameter, and 2 to 3 feet long. These roots are rich in starch. They are used for the manufacture of starch and of the human foods, tapioca and arrowroot. Their more common use, however, in the United States is as food for hogs, poultry, and other live-stock. Fresh cassava roots contain 25 to 30 per cent of starch, and the total dry matter averages about 34 per cent, or a little more than in sweet-potatoes. As cassava contains only about 1 per cent of protein (nitrogenous material) the roots should be fed in connection with foods rich in nitrogen, such as cowpeas, peanuts, and velvet beans.

**436. Poisonous constituent.** — The bitter varieties of cassava, as grown in tropical countries, contain in the uncooked fresh roots appreciable amounts of the poison, prussic acid. However, this poison is volatile, and is easily removed by heat or by exposure for a few hours to the air. The amount of this poison found in sweet cassava is too



small to be dangerous to man or to live-stock. The greater part of the prussic acid is contained in the bark or skin of the root and in its outer layers.

**437. Soils and fertilizers.** — Cassava requires a rather fertile, loose, sandy soil. A sandy soil is not only necessary for the best growth of the plant, but also in order that the roots may be easily pulled. The land must be well drained and warm, so as to make the season of growth as long as possible. Cassava thrives on soil too sandy and dry for corn and may be regarded as a drought-resistant crop.

It is best to furnish the nitrogen for cassava by growing a preceding crop of cowpeas or velvet beans. In case cassava is not preceded by a leguminous crop, it should be fertilized with a complete fertilizer, such as the following:—

200 lb. acid phosphate per acre,  
50 lb. muriate of potash or 200 lb. of kainit, and  
200 lb. cotton-seed meal.

In a single test in Florida, it was found better to apply all of the fertilizer before planting than to divide it into several applications.

**438. Preparation, propagation, and cultivation.**—Preparation consists in broadcast or level plowing and harrowing. Plowing need not be very deep, for this would have the effect of making the roots grow deeper in the soil and hence make the pulling of the roots more difficult. The land should be marked off in checks 4 feet each way, and the fertilizer drilled in and mixed. At the intersection of the furrows or marks, the sections of stem containing the eyes or buds should be dropped, stepped on, and covered with 2 to 4 inches of soil.

Cassava is propagated in the United States only by planting portions of the stem, which are usually cut into lengths of 4 to 6 inches, each section containing 2 or more buds or eyes. It has been found best to drop two short sections in each hill, though many farmers plant only one.

In a field of cassava there are usually a number of vacant hills, chiefly due to the killing of the buds during winter on the section of stem planted in those particular hills, but sometimes due to failure to press the cutting into close contact with the moist soil. On account of the difficulty in getting a perfect stand, some growers find it advantageous to sprout the cuttings in specially prepared beds similar to those used for sweet-potatoes, in which beds the necessary watering can be given. Sprouted cuttings require especial care in planting, so as to avoid breaking off the young shoots.

Tillage should be level and shallow, as this is a very shallow-rooted plant; it should be repeated until the plants thoroughly shade the soil. Usually one or two hoeings will be necessary, but the amount of hoe work can be decreased by using the weeder before the young plants appear.

**439. Harvesting.** — If the stems are to be used for planting, they should be cut before the occurrence of the first frost, since the buds are easily killed. The stem is cut 6 inches above the ground so as to leave a stub by which to pull out the cluster of roots. Pulling is done either by hand alone, or by the help of a grubbing hoe, or by the use of a cant-hook, such as is used in handling logs. This hook is caught under the center of the plant, the short end of the stick placed on the ground, and the long end lifted so as to raise the cluster out of the soil.

Cassava roots keep best when left in the ground until needed for use, provided the soil is well drained and does not freeze.

**440. Storing stems or "seed canes" for planting.**— One of the chief difficulties in growing cassava near the northern edge of the region in which it succeeds is that of keeping the canes or stems through the winter without injury to the bud, as the result of cold, excessive dryness,

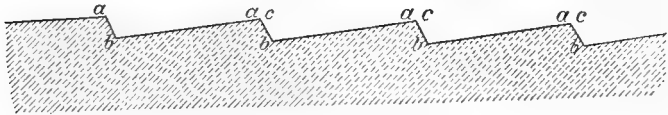

FIG. 200.—METHOD OF PREPARING BED FOR KEEPING CASSAVA SEED STEMS OVER WINTER.

or too much moisture. In general, the stems are kept through the winter by bedding them (Fig. 200) somewhat as sugar-cane is bedded.

The spot selected for a cassava seed-bed should be well drained, and a slight excavation should be made, forming a succession of sloping surfaces. Two or three layers of stems are laid on this in a nearly horizontal position, the base of each being pressed into close contact with the earth. The covering consists of 3 or 4 inches of straw, on top of which is placed at first a layer of about 2 inches of soil, which, before very cold weather, is increased to 4 inches.

Another method of storing cassava stems consists in standing the stems upright in a trench, the whole being covered with a thick layer of straw, weighted down with a small amount of earth. Cassava beds should be under a roof, and some growers build a permanent house, inside of which the canes are stood on end and covered as just stated.

**441. Enemies.**— Cassava has few serious enemies among insects or plant diseases. One of the most troublesome is "Frenching" (*Glæosporium manihot*). This fungus kills the tips of the branches and then spreads

downward. Injury can be prevented by planting only stems from plants that are entirely free from this disease.

### LABORATORY EXERCISES

1. In case cassava stems can be obtained, drawings should be made showing

- (a) how the stems branch;
- (b) locations of leaf scars and buds.

2. In a region where this plant is grown students should inspect a cassava "seed-bed" and should participate in, or at least observe, any processes of propagation, cultivation, or harvesting which may be in progress at the time.

### LITERATURE

- STOCKBRIDGE, H. E. Cassava as a Money Crop. Fla. Expr. Sta., Buls. Nos. 35 and 49.
- WILEY, H. W. Sweet Cassava. U. S. Dept. Agr., Bur. Chem., Bul. No. 44.
- WILEY, H. W. The Manufacture of Starch from Potatoes and Cassava. U. S. Dept. Agr., Div. Chem., Bul. No. 55.
- TRACY, S. M. Cassava. U. S. Dept. Agr., Farmer's Bul. No. 167, and Bailey's Cyclo. Agr., Vol. II, pp. 227-229.
- MOORE, C. C. Cassava: Its Content of Hydrocyanic Acid and Starch. U. S. Dept. Agr., Bur. Chem., Bul. No. 105.

## CHAPTER. XXVIII

### PEANUT — ARACHIS HYPOGŒA

THE peanut is the principal sale crop in a number of counties in the southeastern part of Virginia, in the eastern part of North Carolina, and in one section in Tennessee. Virginia and North Carolina produce more than half of the commercial crop of the United States. The peanut is grown for local use and as food for live-stock in every southern state, and in a number of states further north and west.

In America the principal use of the peanut is for eating after being parched. It is also extensively employed in confectionery. It is one of the best foods for hogs and poultry, and is also fed to other classes of live-stock.

**442. Range.** — The peanut is regarded as a native of Brazil, though an Asiatic origin has also been claimed for it. It became an important article of commerce in Africa much earlier than in the United States. In this country the growing of peanuts for the market is an industry that has grown up since 1866, partly due to the knowledge of the edible qualities of this nut spread throughout the country by the soldiers who had fought in the peanut-growing section of Virginia.

Although the American crop of peanuts probably approaches twenty million bushels, including those con-

sumed on the farm, this is only a fraction of the world's supply of peanuts. A single city in France, Marseilles, imports annually a larger amount of peanuts than was produced a few years ago in the entire United States. In Marseilles the principal use of these imported African and Indian peanuts is for the manufacture of oil, a use for which the peanut has not been extensively employed in the United States.

**443. Description.** — The peanut plant belongs to the pea family (*Papilionaceæ*), which also includes the clovers, vetches, and beans. Like the others just mentioned, the peanut is a soil-improving plant. Its roots bear numerous enlargements, or tubercles, through which the plant is able to draw its nitrogen from the air (Fig. 201).

This plant is peculiar in bearing its seed or fruit underground. The flowers are borne on small stems springing from the axil of the leaf. The flower stem turns downward, and after the flower is fertilized, the tip of the pistil, which is sharp, grows into the ground. Soon after the long slender portion, called the "peg" has pierced the ground, its lower tip enlarges and becomes the pod or shell. The inclosed seeds, which are commonly called nuts, are more properly peas.

The peanut plant is annual, making its growth in the warm season, and easily killed by frost. Each leaf consists of four leaflets, and these have the interesting habit of folding together at night or while rain is falling.

Each plant bears a number of branches, which in some varieties lie flat upon the ground, while in other varieties the branches are erect. The pod contains from one to three or sometimes even four seeds.

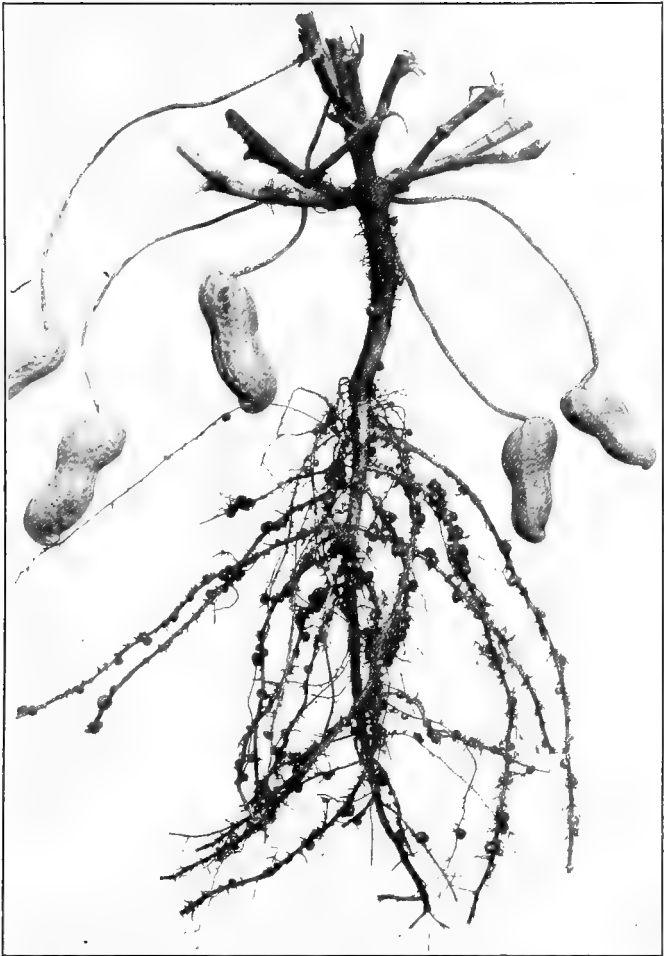

FIG. 201.—THE LOWER PART OF A PEANUT PLANT.

Showing roots, root tubercles, and nuts or seeds borne on the end of "needles," or elongated pistils.

2 H

**444. Composition.** — The following table shows that all parts of the peanut plant are rich in nutritive qualities :

PEANUT	WATER	PROTEIN	FIBER	NITROGEN-FREE EXTRACT	FAT
	%	%	%	%	%
Peanut with hull . . . . .	6.60	23.20	18.40	14.20	35.00
Peanut kernels . . . . .	7.85	29.47	4.29	14.27	49.20
Peanut hay . . . . .	7.83	11.75	22.11	46.95	1.84
Peanut hulls . . . . .	12.94	7.22	67.29	19.42	2.68
Peanut meal or cake . . . . .	10.74	52.49	5.93	27.26	8.84

A crop of 60 bushels of peanuts per acre, together with one ton of hay, has been found to contain approximately 85 pounds of nitrogen, 15 pounds of phosphoric acid, 32 pounds of potash, and 46 pounds of lime. Most of the lime and potash is contained in the hay, while the greater part of the phosphoric acid and more than half of the nitrogen are found in the nuts.

**445. Soils.** — A sandy or sandy loam soil is preferred. Nuts of the highest market quality, that is, with the brightest shells, are produced on light-colored, sandy soil. Red or dark soils, especially when containing much clay, stain the hulls, and hence reduce the market price. Such soils, however, are fully as good for peanuts that are to be consumed on the farm. While a stiff soil is usually avoided for peanuts, — partly because of the staining of the shells and partly because peanuts cannot be grazed by livestock on such soils while wet, — yet these heavier soils sometimes make larger yields of nuts than do very sandy fields.

In the choice of soils for peanuts it must be constantly remembered that a loose, friable condition of the surface layer is necessary in order that the "pegs," from which the pods will develop, may easily enter the soil.



**446. Liming soils.** — A considerable amount of lime in the soil increases the yield. However, the percentage of lime in the soils of the eastern peanut region is low, so that this element is usually supplied artificially. The absence of lime is generally believed to be one of the causes leading to a large proportion of "pops," that is, shells without nuts. Potash is said to reduce the number of "pops." Probably one of the good effects of lime is its well known effect of making available the potash in the soil. On soils extremely deficient in lime, as are most light-colored, sandy soils, an application of lime is usually advantageous. A minimum of 10 bushels or a maximum of 50 bushels of slaked lime per acre may be used. The smaller application repeated at frequent intervals is preferable to larger application once every four or five years. Where lime is used special care must be taken to maintain an abundant supply of humus in the soil. Lime is best applied broadcast and harrowed in, but when very small amounts are employed, it is sometimes placed in the drill, or even drilled on top of the ridge after the seed have been planted.

**447. Fertilizers.** — Other fertilizers for peanuts should be placed in the drill, though some farmers in Virginia apply a few hundred pounds of land-plaster per acre after the plants have made considerable growth. It seems to be better practice, instead of using plaster, to increase the amount of acid phosphate, since nearly half of the weight of acid phosphate consists of land-plaster. In either form, the plaster converts a part of the potash of the soil into a more available form.

The fertilizer most generally needed by peanuts is a

mixture of acid phosphate and some form of potash, such as kainit or muriate of potash. A good general fertilizer is at least 200 pounds of acid phosphate and 50 pounds of muriate of potash per acre.

If the land is extremely poor, there is some advantage in using a small amount of nitrogenous fertilizer, so as to promote the early growth of the plant before it is able to draw its nitrogen from the air. For this purpose about 40 pounds of nitrate of soda per acre may be placed in the furrow at the time of planting, or, better still, applied on one side of each row of plants at the first cultivation. The later application of nitrate has the advantage of not stimulating the growth of weeds and grass as early in the season as would be the case if it were applied at or before planting.

However, for the greater part of the supply of nitrogen reliance must be placed on that drawn from the air by the tubercles on the roots of the peanut plant.

**448. Preparation of the land.** — The first step in preparing peanut land is to remove any coarse litter, such as stalks of corn or cotton, which might interfere with germination and cultivation. The land should be plowed and thoroughly harrowed. The time of planting depends on the locality, the soil, and the nature of the preceding crop. Generally it is well to plant peanuts after some hoed crop which has been well cultivated, such as cotton. Some farmers find it advantageous to plow the land at least a month before planting. This gives time for weed seeds to germinate. This crop of young weeds should then be destroyed by the use of the disk harrow or other suitable implement.

Furrows should be opened at regular intervals and in these the fertilizer drilled, generally by the use of a machine.

A cultivator or other implement frequently follows the fertilizer distributor, in order to better mix the fertilizer with the soil. When planting on ridges is to be practiced, the land is next ridged, either by means of turn-plows, cultivators with suitable points, or by means of special implements. These ridges, just before planting, should be partially pulled down, and flattened by the use of a weeder or spike-toothed harrow.

**449. Method of planting.** — On this low, flattened list or ridge the seed are then planted either by means of a planter, — which opens, drops, and covers, all at one time, — or by means of hand-planting in a furrow opened by a scooter and covered by the use of a double foot or other suitable device.

On stiff lands a depth of  $1\frac{1}{2}$  inches suffices early in the season. The depth generally preferred is about 2 inches. When planting is done at a late date or on dry soil, a still greater depth is advisable.

On very dry soils, especially when planted late, no ridges are formed, the seed being planted about 2 inches below the surface level.

**450. Distance between rows and between plants.** — With the Spanish peanuts or other erect varieties, the distance between rows is usually 24 to 30 inches, and from 30 to 36 inches with the running kind. Spanish peanuts on good land may advantageously be planted as close as 4 inches apart in the drill, but cultivation is more economically done if more space is given, usually 8 to 12 inches between hills, with two peas in a place. In experiments at the Arkansas Experiment Station the yield of Spanish peanuts decreased as the space between rows was made

wider than 2 feet and as the distance between plants was increased above 6 inches.

**451. Seed.** — To plant an acre of either Spanish or running peanuts rather thickly, requires about two bushels of unhulled nuts, or about half a bushel of hulled peanuts.

The seed intended for planting should be harvested before the plants are killed by frost and so stacked and stored as to avoid heating. Varieties having large pods require the shelling of the seed peas, but shelling is not necessary with the Spanish variety. The latter is usually



FIG. 202. — A PEANUT "POPPER."

A device for shelling peanuts.

simply broken, each piece being planted with the inclosing shell. In this case, some growers find it advantageous to soak the Spanish peanuts for a few hours before planting, so as to hasten germination. Shelling affords a more nearly perfect stand and more rapid germination, thus giving the crop an opportunity to begin growth before grass and weeds start.

Shelling of seed peanuts should usually be performed by hand, since the use of machines for this purpose sometimes breaks the thin coat surrounding the nuts. Any injury to this thin layer is apt to interfere with germina-

tion. In the hand shelling of peanuts the work may be hastened and the fingers spared by the use of a simple device known as the "popper." This is a thin piece of white oak or other suitable material bent into the shape of a pair of tongs (Fig. 202). While the seed peas are being shelled, defective seed should be separated and rejected.

**452. Breeding.** — No form of plant-breeding has been generally applied to the peanut. However, since the selection of seed from the best plants largely increased the yield of other crops, a similar increase is to be expected by the process of saving seed from the best single plants of peanuts (Fig. 203).

**453. Time of planting.** — The time of planting varies greatly with the latitude. In Virginia the greater part of the crop is planted in May, and this is the preferred month for planting the running varieties throughout most parts of the cotton-belt. However, these varieties are often planted in April in the southern part of the United States. The Spanish peanut requires less than four months for maturing a crop. Hence, this kind can be planted at any date desired after cotton comes up, and up to the first of July. Even later plantings of this variety are sometimes made, but at the sacrifice of yield. Spanish peanuts can be planted after any of the small grains are harvested; but unless the season be especially favorable, maximum yields are not to be expected where grain stubble is plowed under in June, because of the tendency of such fields to dry out or otherwise get into poor mechanical condition.

**454. Tillage.** — After planting and before the plants



FIG. 203. — A FIELD OF SPANISH PEANUTS GROWN FROM SELECTED SEED.

appear above ground, the peanut field may be tilled with a weeder. As soon as the line of plants can be seen, tillage begins with some form of cultivator equipped with fine teeth or with scrapes. After the young plants have attained some degree of toughness, the weeder is brought into use at frequent intervals. It is best run diagonally across the rows. By this means much of the young grass along the line of the drill is destroyed, thus saving much work with the hoe. One hoeing, or, if necessary, a second one is given, but only when needed. Grass growing among the prostrate branches of the running varieties should be pulled by hand; large weeds in such positions are better cut off, since the pulling of large grass or weeds after the nuts form, disturbs the buried nuts and does more harm than good.

The cultivator is used as often as necessary. The first cultivation may be rather deep. Unless level culture is practiced, it is customary for the cultivator to throw some earth around and among the plants, thus making a low ridge or bed of loose soil in which the "pegs" may become imbedded.

**455. Rotation.** — Peanuts should generally follow a crop kept clean by the use of the hoe. Among such crops are cotton and sweet and Irish potatoes.

When the vines are returned to the land and evenly distributed, or when the crop is grazed on the land, the peanut enriches the soil, especially in nitrogen. However, when peanuts are grown for market, both the nuts and vines are usually removed from the land, making a heavy draft on soil fertility, and necessitating a judicious rotation. On some fields in the peanut region this crop is

grown without due attention to rotation. The result is a notable decline in yield, due to the exhaustion of the supplies of humus, potash, phosphoric acid, and lime, and in some cases to the occurrence of disease or insect injury.

The best rotation varies with a number of conditions. Where peanuts constitute the main sale crop, they are often rotated with corn. An improvement would be the sowing of either cowpeas or of crimson clover among the corn rows. Peanuts can also be rotated with small grain, the oats or wheat being followed by cowpeas and this crop by peanuts. When cotton is the preceding crop and when the germs of cotton wilt are not present in the soil (paragraph 380), crimson clover seed should usually be sown in the cotton plants in September, and the young clover plants can then be plowed under for fertilizer the next spring, in time for the growth of a crop of peanuts.

**456. A recommended rotation.** — A suitable rotation for those fields in the southern part of the cotton belt in which the presence of cotton wilt prevents the frequent growing of cotton, is the following:—

First year : corn with Iron cowpeas between the rows.

Second year : cotton.

Third year : peanuts.

Fourth year : fall-sown oats, followed by Iron cowpeas.

From such a rotation, crimson clover is omitted because it might be the indirect means of increasing the amount of wilt in the next cotton crop. This is because crimson clover is attacked by nematode worms (see paragraph 385); but the peanut is exempt from this injury, and hence the



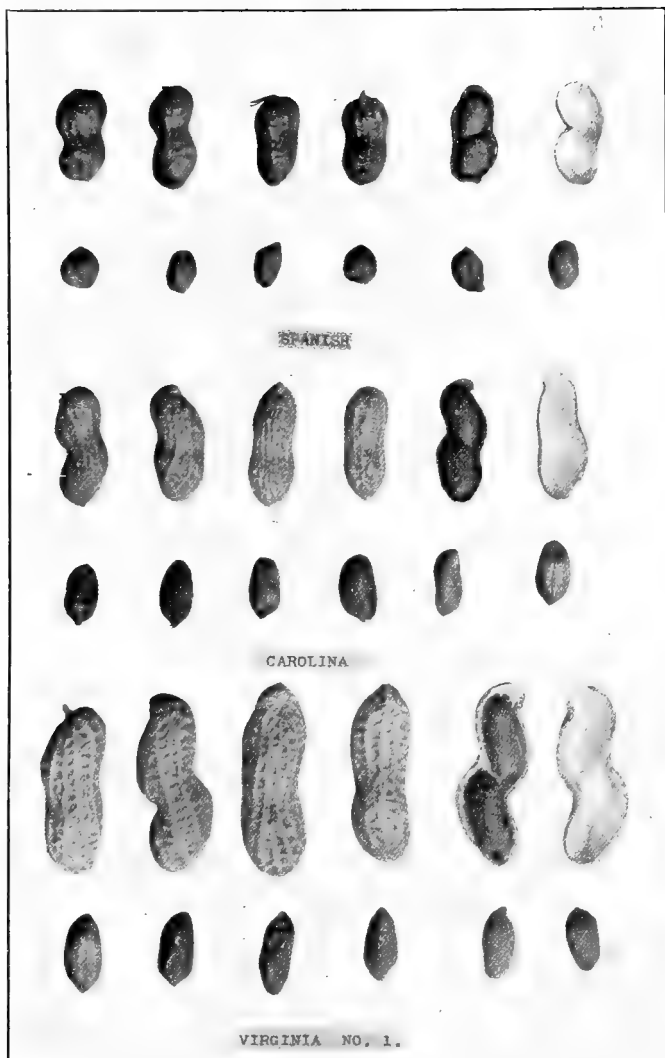

FIG. 204.—PODS AND PEAS OF THREE VARIETIES OF PEANUTS.

latter constitutes a good crop to grow on fields where the organisms of either nematode worms or cotton wilt are present.

**457. Varieties.** — There are but few varieties of peanuts grown in the United States. The most important are described below (Fig. 204).

*Virginia Runner.* — This is a variety having long branches flat on the ground, and bearing pods throughout the entire length. The pods are of light color and usually two or sometimes three in a pod. The pods do not adhere well to the vines in digging. The weight of this and of other large varieties is twenty-two pounds per bushel.

*Virginia Bunch* is an erect variety bearing its fruits only near the base of the plant. The nuts are similar to those of the Virginia Runner.

The *North Carolina*, sometimes called the *Wilmington* and sometimes the *African*, has spreading prostrate stems, and the plant is of somewhat smaller size than the Virginia Runner. The pods and peas are also smaller than those of the Virginia Runner, but larger than Spanish peanuts. The percentage of oil is high as compared with other American varieties, but lower than that of peanuts grown in Africa. The weight of the North Carolina variety is twenty-eight pounds per bushel.

The *Spanish* is the earliest variety of American peanuts. The branches grow upright, and the pods are clustered around the base of the plant (Fig. 205). Hence, in sandy soil practically all of the nuts adhere to the vines when the latter are pulled, after being loosened. The pods are short and slender, usually containing two nuts. The hull lies in close contact with the nut, so that moisture is quickly



FIG. 205.—A BUNCH OF SPANISH PEANUTS.

conveyed to the latter ; as a result, Spanish peanuts sprout more quickly, if left in the land after maturing, than do varieties with larger pods and more space between nut and shell. Hence, Spanish peanuts must be dug or used as hog feed soon after ripening, while the large-podded varieties may remain sound enough for hogs to eat throughout the first half of the winter.

Spanish peanuts require less than four months from planting to maturity, or at least a month less than most other varieties. Hence they may be planted later. They are sometimes planted after oats are harvested, but under these conditions the yield is reduced. The latest date for planting Spanish peanuts with the expectation of a fair yield is about July 1, in the central part of the cotton-belt. Spanish peanuts can be grown on poorer soil and on soil with less lime in it than can most other varieties.

**458. Uses.** — The peanut constitutes an important human food. It is eaten roasted, for which use the varieties having large pods are preferred. The shelled peas are extensively used in confectionery, and to this use the Spanish and the smaller peas of the other varieties are largely devoted. In Marseilles, France, and in other localities in Europe, large amounts of peanuts from Africa and India are converted into oil and peanut cake. Peanut oil commands a higher market price than cotton-seed oil and is largely used as a substitute for olive oil. There is need for further investigation to determine whether it is practicable for Southern cotton oil mills to manufacture peanut oil from some of the African peanuts, rich in oil, which could doubtless be successfully grown in the South.

Peanut butter, made from the ground peas or nuts, with or without the addition of oil, is a palatable and nutritious article of human food and is rapidly growing in popularity.

**459. The peanut and its by-products as food for livestock.** — Outside of those regions in which the peanut is grown as a sale crop, its principal use is as a food for hogs, the hogs doing the harvesting. To make the season in which peanuts are available as long as possible, there should be a succession of plantings of Spanish peanuts at intervals of a few weeks; this succession of Spanish peanuts should be planted in addition to the necessary acreage in the running varieties, the latter being grown largely with a view to use in December. Hogs make satisfactory growth on peanuts alone, but the addition of a small amount of corn makes the gain more rapid and improves the quality of the meat and lard produced.

Hogs fed on peanuts make very soft pork and lard that melts at a low temperature. Hence, it is advisable to remove peanuts from the ration at least a month before the animals are killed.

In growing peanuts as an article of sale, the nuts left in the field and the immature or unmarketable pods may be used in fattening hogs.

The Spanish and other varieties of peanuts having an erect habit of growth produce from 1 to 2 tons of excellent hay per acre. This must be mowed before many of the leaves fall or become spotted. The field may then be grazed by cattle and finally hogs turned in to consume the nuts.

Peanut meal is quite similar in composition to cotton-seed meal, and suitable for the same uses.

In some regions the entire plants — vines with attached nuts — are fed to horses.

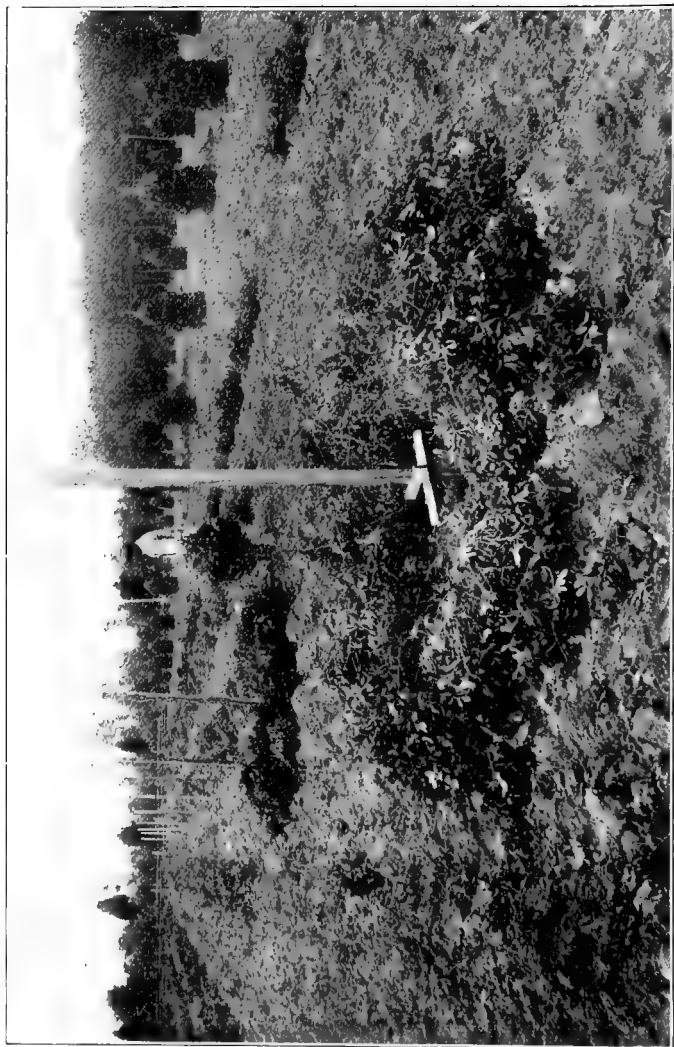

FIG. 206. — STACKING PEANUTS.

**460. Harvesting.** — The principal harvesting season is the months of September and October. Peanuts for market or for seed should be dug before frost. They are ready for harvesting as soon as the pods about the base of the plant show a tendency to shed, or easily become detached from the vine. Harvesting may be done in a variety of ways. The usual method is to remove the moldboard from a turn-plow and run the share under the row on each side at a sufficient depth not to sever the pods from the branches. The side from which the moldboard has been removed is kept next to the row.

Sometimes a special blade is attached to the plow in such a way as to run under the line of plants. The plants are then lifted by hand or by means of forks and thrown into small piles on every third row. They are stacked, usually on the same day as dug, and before the plants have thoroughly dried. The stacks are as slender as possible and only about five feet high (Fig. 206). They are made around poles seven feet long, driven securely into the ground. The tops are turned outward and the nuts inward, so as to protect the latter from rain, dew, and sunshine, and from the attacks of birds and other animals. Before making the stack, a few short poles are placed on the ground so as to keep the nuts from resting on the latter; a little space for ventilation is left around each stack-pole. The stack is capped with grass, hay, or other material suitable for shedding water.

**461. Yields of peanuts.** — At the branch Experiment Station at Newport, Arkansas, a yield of 172 bushels per acre was made by planting Spanish peanuts 4 inches apart

in drills 2 feet apart.<sup>1</sup> This is probably the largest yield on record. A yield of 60 bushels or more of any variety may be regarded as a good crop. The average of the entire country in most years is below 35 bushels per acre.

**462. Enemies.** — The peanut has few enemies either among insects or among the minute organisms usually concerned in the diseases of plants.

The most common disease is a form of leaf-spot (*Cercospora personata*). The symptoms are the appearance of brownish spots on the leaves. This disease is more frequently noted on sour or poorly drained land. If it appears late in the life of the plant, it will often be practicable to mow the erect varieties for hay before the disease has rendered the vines unfit for this use.

In a few localities, especially around old premises, the peanut plant is sometimes killed by a form of root rot (*Fusarium*). The symptoms are the presence of a mass of white threads on the stem just below the surface, together with the appearance of minute round, whitish, or brownish bodies, about the size of mustard seeds, clustered around the stem, close to the surface of the ground.

Doubtless rotation of crops, keeping off of the infected fields most of the legumes and other susceptible crops, is the best means of avoiding injury by this disease.

### LABORATORY EXERCISES

1. Determine the weight of 100 shelled nuts of the Spanish and of some larger variety.
2. Determine the percentage of hulls in the unshelled dry nuts of both the Spanish and some larger variety.
3. If growing peanut plants are available, make a drawing showing where the "pegs" or "needles" originate, and the enlargement which they undergo after penetrating the soil.
4. The principal laboratory work to accompany this chapter

<sup>1</sup> Ark. Expr. Sta., Bul. No. 58.



should be the actual performance or observation of the field operations herein mentioned.

## LITERATURE

- HANDY, R. B. Peanuts: Culture and Uses. U. S. Dept. Agr., Farmer's Bul. No. 25.
- BEATTIE, R. W. Peanuts. U. S. Dept. Agr., Farmer's Bul. No. 356.
- NEWMAN, C. L. Peanuts. Ark. Expr. Sta., Bul. No. 84.
- ROPER, WILLIAM N. The Peanut and its Culture. Petersburg, Virginia.
- CORBETT, L. C. Peanuts. Bailey's Cyclo. Agr., Vol. 2, pp. 514-519.

## CHAPTER XXIX

### SUGAR-CANE—SACCHARUM OFFICINARUM

SUGAR-CANE is one of the family of the grasses. Like all the grasses, sugar-cane has a jointed stem with a leaf originating at each node. The leaves are arranged in two vertical ranks, and are borne alternately on two sides of the stalk. The plant grows to a height of 8 to 12 feet, or, in tropical countries, to a greater height.

The stem is large and upright, except when bent or reclined by wind or by its own weight. A number of stalks usually grow together in a cluster, due to the fact that this plant throws up additional stems from the buds at its lower nodes below the surface of the ground.

**463. Duration.** — Sugar-cane is perennial. In some tropical countries a number of harvests are secured from a single planting. In Louisiana usually only two or three crops are grown before the stubble becomes too thin to produce profitable yields. In the pine-belt east of Louisiana and north of the latitude of Florida, a planting of sugar-cane usually affords but a single crop, annual planting being necessary. In this region the cane is usually cut and made into sirup within eight months after the date of planting. In tropical countries, the plants are often permitted to grow for fourteen months or more before being harvested.

**464. Leaves.** — The leaves of sugar-cane are broad and long, sometimes reaching a length of three feet. In some varieties minute prickles occur on the leaves, making the harvesting of the crop disagreeable. The leaves have a central midrib, which gives a moderate degree of stiffness to the lower part of the leaf-blade.

The leaf of the sugar-cane, like that of corn, has special cells which, when the supply of water is not sufficient, roll it together, thus reducing the loss of moisture. The leaf-sheath, or part that folds around the stem, serves to protect the bud, or eye, which it incloses. As the plant matures, the leaves unclasp from the stem and hang loosely or fall. The falling of any leaf is regarded as an indication of the maturity of the internode next below this leaf.

In the cells of the leaves the green coloring matter during daylight manufactures starch from the carbonic acid gas of the air and the water brought from the roots. This starch is then changed and conveyed to all parts of the plant, a large part of it being finally deposited in the pith cells of the stem in the form of sugar. Thus, sugar, the valuable product of cane, is made up almost entirely of water and of a gas occurring in abundance in the air; if only sugar were removed from the land there would be practically no exhaustion of the plant-food by the growing of sugar-cane.

**465. Roots.** — A small part of the main stem of cane is below the surface of the ground, connected below either with the cane that was planted or with another cane, from one bud of which it grew. The nodes, and hence the buds, on this underground part of the stem are very close together, making it possible for a number of stems

to spring up in a cluster or stool as the result of the growth of these underground buds into suckers, or young canes. In a band around the stalk at each node are a number of nearly transparent dots. From these dots spring true roots when this joint is kept moist by contact with the soil. The roots are fibrous and usually they do not penetrate to great depth.

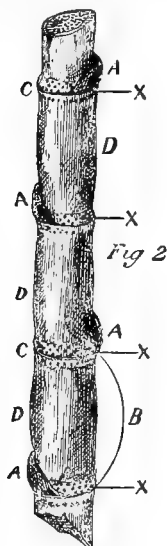

FIG. 207.—PART OF A STEM OF SUGAR-CANE.

A, buds or eyes; B, joints; C, nodes; D, internodes; X, dots where roots may originate.

is of various colors, depending on the variety. Among the most common colors are purple (or reddish), striped purple and white, and green. Yellow, white, brown, and other colors also occur, especially in varieties grown in tropical countries.

**466. The stem.**—The part most valued is the stem, from which sugar and sirup are manufactured. The stem is large and cylindrical, and consists of a series of internodes of variable length, separated by joints, or nodes (Fig. 207). The internodes (often popularly called “joints”) are short at the base and longer toward the middle or upper part of the stalk. The length of internodes varies greatly with different varieties and is decreased by drought, or by other condition unfavorable to growth. The

rind or outer portion of the stalk consists chiefly of strong fibrous tissue, giving strength and hardness to the stem. The rind, and hence the stalk,

**467. Structure of the stem.** — On cutting across a stalk of cane, one finds the greater part of the space within the rind occupied by white pith cells. It is within these

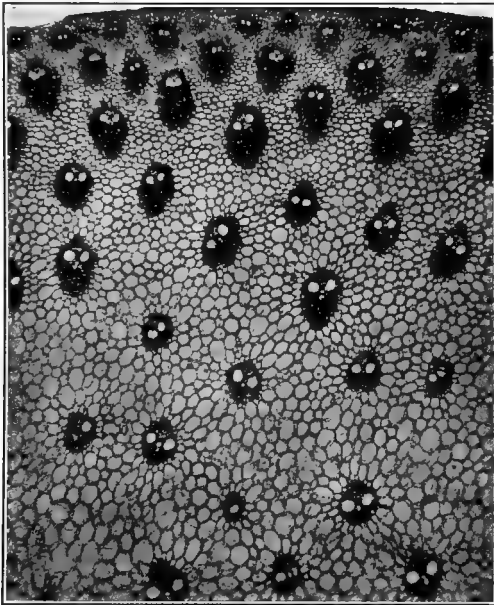

FIG. 208. — CROSS SECTION OF PART OF A STEM OF SUGAR-CANE.

The dark spots inclosing smaller white spots are the bundles which contain the tubes and vessels through which liquids circulate; the greater part of this section consists of pith cells. Greatly enlarged.

white pith cells that the sugar is contained. The enormous pressure of a mill is required to expel the juice in which the sugar is dissolved.

At intervals among these pith cells may be found strands of tougher tissue running parallel to the length of the stalk (Fig. 208). These tough, strong strands are the bundles of fibrous tissue that serve for the circulation of liquids within the plant. Each bundle (Fig. 209) contains (1) several *vessels*, that is, organs

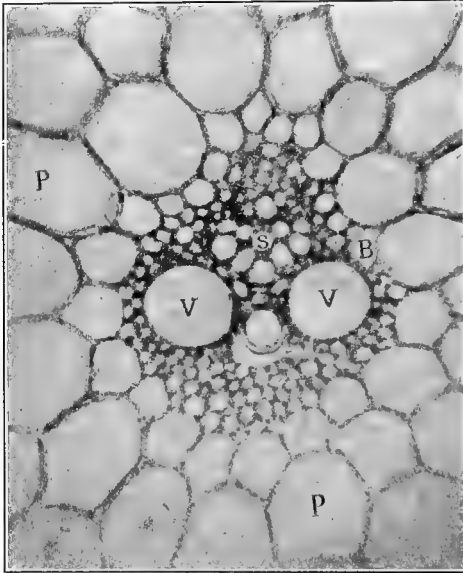

FIG. 209. — CROSS SECTION THROUGH A BUNDLE FROM THE STEM OF SUGAR-CANE.

V, vessels for upward current ; S, sieve tubes for the descending sap ; P, pith cells containing sugar. Greatly enlarged.

for the carrying of water and dissolved plant-food from the soil *upward* to the leaves ; (2) a number of smaller carriers, called *sieve tubes*, through which the digested sap is returned *from the leaves* to all the other parts of the plant.

The bundles are most numerous just beneath and within the rind, where they serve to give strength and stiffness to the stem. At the joints or nodes the bundles branch and intermingle, a part being continued into the leaves, and a part entering the next upper internode. The larger the amount of fiber, the smaller is the amount of sugar, and the greater the difficulty of expelling the juice. Therefore, canes with short internodes, and hence consisting largely of the fiber that constitutes the hard nodes, are less desirable than those with long internodes. The internodes are longer where all conditions are favorable to a luxuriant growth; for example, abundance of plant-food, an ample supply of moisture, and judicious cultivation.

**468. The buds or eyes.** — At each node or joint on the stem is borne a bud. This is the part of the plant from which the next crop must grow, just as the eye of the Irish potato serves instead of seed to perpetuate that plant. The buds occur alternately on opposite sides of the stem. A bud is about the size of half of a pea. It is closely enfolded and protected by the leaf-sheath. Moreover, each bud consists of the inner part, which is capable of growth, and of several outer protecting coats.

The aim in harvesting before frost that part of the cane crop intended for planting and the banking or windrowing of cane in winter is to protect the buds from freezing. The life of the bud is easily destroyed by freezing weather, especially if moisture has collected under the leaf-sheath and around the bud.

**469. Method of propagation.** — For commercial purposes, the only method of propagating sugar-cane consists in planting the stalks or sections of stalks on which are borne the eyes. Stimulated by the moisture and heat of the soil, the bud swells and grows into a sucker, or young

cane. This develops a stalk, with buds at each node. The growth of clusters of stalks results from the growth of several of the buds on the base of the young plant, usually from those nodes located below the surface of the ground. Thus, a cluster or stool consists of stalks of various sizes and ages, only one of which grew from the planted bud, but all indirectly tracing back to that bud. The percentage of the eyes of planted cane capable of growth varies greatly with different varieties, and is not the same for the buds growing on the upper and lower part of the stalk. Care in planting results in an increase in the number of buds that grow, thus affording a thicker stand. The young sucker draws its nourishment from the mother stalk (planted cane or older growing plant) until its own roots have sufficiently developed to supply it with the necessary food and moisture.

**470. Propagation of sugar-cane from seed.** — In tropical countries, some varieties of sugar-cane "arrow," or produce from the top of the stem, when a little more than a year old, a flower stalk, on the top of which is borne a silky head consisting of innumerable very small flowers. Each flower when mature resembles a small, chaffy grass seed. Until the latter part of the nineteenth century it was thought that no seed reached such a degree of development as to be capable of germination and growth. However, scientists have now learned methods by which a very small proportion of the seeds of sugar-cane produced in tropical countries may be made to grow. The plants produced by seed grow very slowly, requiring several years to attain the size that is ordinarily reached in a few months by cane propagated from buds.



**471. Improvement of cane.** — It has been proved that sugar-canes propagated from buds differ among themselves in the percentage of sugar and in other useful qualities. It has also been found that the selection for planting purposes of canes from clumps or stools the stalks of which are rich in sugar, results in an improvement in the quality of the next crop. By this mode of selecting good stalks, some improvement can be made in sugar-cane.

An experiment conducted at the Louisiana Sugar Experiment Station through six generations showed a decrease in yield from the repeated planting of small canes. Taking the average for all years the continuous planting of large canes produced an average crop of 30 tons of cane per acre. The repeated planting of medium-sized canes yielded 29.85 tons; and the continuous planting of small canes afforded an average crop of only 25.95 tons of cane per acre. The decrease from using small seed canes was greater in the first crop, or "plant cane," than in the second crop, or "stubble cane."

However, it is a general rule that plants grown from seed show greater differences among themselves than do the same kinds of plants when propagated from buds. Taking advantage of this, selection is made of those seedling canes which show especially desirable qualities, and these strains are thereafter propagated by planting the canes in the usual way, thus retaining and perpetuating the quality desired. The planting of true seed is now the first step in the usual method of bringing into existence new varieties of sugar-cane.

#### COMPOSITION

**472. Proportion of parts of the cane.** — At the Louisiana Sugar Station, for each ton of stripped cane of the

Red or Purple variety there was found about three quarters of a ton of tops, leaves, and roots. Nearly 90 per cent of the weight of the stripped cane may consist of juice. However, the small mills having only three rollers usually extract only about half of the total juice.

The large and powerful mills connected with sugar-houses extract from 75 to 80 per cent of the weight of the cane as juice.

A ton of stripped cane is expected to yield between 150 and 180 pounds of sugar. Exact data for the yield of sirup are not abundant, but the output may be roughly estimated at 12 to 15 gallons per ton of stripped cane crushed in small, poor mills, or as much as 22 gallons in good mills in Louisiana.

**473. Relative composition of sugar-cane in the sugar-belt and in the coastal pine-belt.** — The sandy uplands of the coastal pine-belt of the United States afford a cane fully as rich in sucrose, or crystallizable sugar, as the canes of Louisiana, the sucrose usually ranging from 10.50 to 14 per cent. But the shorter season in the pine-belt makes the percentage of glucose, or non-crystallizable sugar, greater here than in Louisiana. This higher glucose content would be a great disadvantage in manufacturing sugar, since glucose not only fails to crystallize, but its presence also causes some of the sucrose to fail to make sugar.

On the other hand, this high percentage of glucose is a positive advantage in sirup making, because the greater the amount of this substance the smaller is the tendency for the sirup to crystallize, or to turn to sugar, — a change that is extremely undesirable.

**474. Removal of plant-food from the land.** — At the Louisiana Sugar Station (Bul. No. 59) the following facts were learned as to the amount of plant-food removed by

a ton of stripped Red or Purple cane with the accompanying waste parts:—

	POUNDS PER TON OF STRIPPED CANE		
	Nitrogen	Phosphoric Acid	Potash
In 1 ton of stripped canes . . . .	1.08	1.04	1.22
In leaves and tops (1376 lb.) . . .	1.73	0.49	1.21
Total in cane, leaves, and tops .	2.81	1.53	2.43

In Louisiana, the tops and leaves are usually burned on the land, thus saving their quota of phosphoric acid and potash, but losing all of the nitrogen. Under these conditions the loss of plant-food represented by a crop of 25 tons per acre of stripped cane would be

Nitrogen . . . . .	61 pounds
Phosphoric acid . . . . .	26 pounds
Potash . . . . .	30 pounds

When the leaves and tops are burned, sugar-cane is an exhausting crop. It makes a demand for a large porportion of nitrogen in the fertilizer, or else for much nitrogen supplied by growing a preceding crop of cowpeas or velvet beans. Some analyses of cane grown in Hawaii and in foreign countries show a larger draft on the fertility of the soil than is indicated by the analyses of American cane.

### SOILS AND FERTILIZERS

**475. Soils.**—The sugar-cane bears a large number of broad leaves and presents a very extensive surface engaged in transpiring water. Hence, the most important requirement in a soil for sugar-cane is that it shall afford a generous supply of moisture throughout the growing

season. W. C. Stubbs says that the best soil for sugar-cane should be capable of holding 25 per cent of its weight of moisture.

In a hilly country alluvial bottoms make the best soil for sugar-cane, provided they are well drained, and the soil somewhat sandy, but fertile. Especially in the northern part of the region where sugar-cane is grown, a stiff or poorly drained soil is unsuitable for this plant. On such soils, the yield of cane and the quality of the sirup are unsatisfactory.

Soils for sugar-cane should be fertile, and well supplied with vegetable matter.

Stubbs states that the soils of the sugar-belt of Louisiana contain on an average

Lime . . . . .	0.5 per cent
Potash . . . . .	0.4 per cent
Phosphoric acid . . . . .	0.1 per cent

He calculates that if the entire growth were removed from the land, a soil of this composition contains enough of the above fertilizer constituents for the following number of crops, each of 25 tons of cane, besides tops and leaves:—

Nitrogen for . . . . .	70 crops
Phosphoric acid for . . . . .	150 crops
Potash for . . . . .	333 crops
Lime for . . . . .	1250 crops

As a matter of fact, the yield would decline to an unprofitable amount long before any one form of plant-food would be completely exhausted.

**476. Uplands for cane.** — Most of the uplands on which sugar-cane is sometimes grown east of the Mississippi River are much more sandy, and hence much more de-

ficient in plant-food, than the soils of the sugar-belt of Louisiana. Therefore, on such upland the yield of cane per acre is usually lighter. However, there is partial compensation in the fact that cane grown on the pine lands is ordinarily richer in total sugars than cane grown on the alluvial lands in Louisiana.

**477. Fertilizers.** — Under the system generally practiced in Louisiana, the tops and leaves are annually burned on the field, thus returning to the soil a part of the phosphoric acid and potash, but robbing the soil of practically all of the nitrogen contained in the above-ground part of the plant. Therefore, the principal fertilizer constituent needed is nitrogen. Experiments at the Louisiana Sugar Station have indicated that as much as 48 pounds of nitrogen per acre can be applied with profit in the form of commercial fertilizers. This amount is contained in about 340 pounds of nitrate of soda or in larger amounts of cottonseed meal, dried blood, or tankage. An application of 36 pounds of phosphoric acid per acre was found to be sufficient for Louisiana soils. This amount is contained in about 250 pounds of acid phosphate. Louisiana experiments showed that cane grown on the soils of the sugar-belt needed but little, if any, potash. No fertilizer was found to influence notably the percentage of sugar in the juice, when the fertilizer was used in moderation on rich alluvial soils.

Part of the commercial fertilizer is advantageously applied before the planting of the cane, and a part may be reserved for application soon after growth begins. If nitrogenous fertilizer is applied too late in the summer, it delays the ripening of the cane, and hence reduces the yield

of sugar, or injures the quality of sirup. Phosphates tend to hasten the ripening of cane, as also of other plants.

**478. Source of nitrogen.** — The demands for a large amount of nitrogen are met by the planters of Louisiana by plowing under, every third or fourth year, a luxuriant growth of cowpeas, usually grown in the corn in rotation with sugar-cane. In the pine-belt east of the Mississippi River, nitrogen should be supplied by plowing under, the year before planting cane, a luxuriant growth of velvet beans or of the Iron variety of cowpeas.

**479. Fertilizer experiments with cane in the pine-belt.** — An extensive series of fertilizer experiments was conducted for two years by the United States Department of Agriculture on sandy pine land in the southern part of Georgia.

This field had been in cultivation for a number of years. When cane was not preceded by a soil-improving crop, the results were as follows: —

(1) The fertilizer formula that can be recommended as the result of these tests consists of

600 pounds high-grade acid phosphate,
100 pounds cotton-seed meal,
300 pounds nitrate of soda,
<u>100 pounds sulfate or muriate of potash,</u>
1100 pounds, total per acre.

Such a fertilizer would contain about 86 pounds of available phosphoric acid, 50 pounds of nitrogen, and 50 pounds of potash, and would analyze approximately as follows: —

8.0 per cent, of available phosphoric acid,
4.5 per cent of nitrogen,
4.5 per cent of potash.

In these tests 1200 pounds, and even 2000 pounds, of a complete fertilizer was more profitable than 800 pounds on sandy

soil not previously improved. However, 800 pounds was sufficient on a similar soil where the entire growth of velvet beans had been plowed under a few months before planting the cane.

(2) These quantities of fertilizer were found more effective when divided into two applications, one before planting and one late in May, than when all the fertilizer was used at the time of planting.

(3) As a source of nitrogen, nitrate of soda was superior to cotton-seed meal; the nitrogen in cotton-seed meal was more effective and profitable than an equal weight of nitrogen in the form of cotton seed.

(4) For land where a crop of velvet beans had been plowed under, the results justified the recommendation of an application of

1100 pounds of high-grade acid phosphate,
100 pounds nitrate of soda,
<u>100 pounds muriate of potash,</u>
1300 pounds, total per acre.

This mixture would analyze about

11.5 per cent available phosphoric acid,
1.1 per cent nitrogen,
4.0 per cent potash.

**480. Forms of plant-food for sugar-cane.** — It is a common practice among the farmers of the cotton-belt who grow cane on a small scale, to fertilize it with 25 to 60 bushels of cotton seed per acre at the time of planting, in addition to some commercial fertilizer. At prices of cotton seed prevailing in recent years, the necessary nitrogen can be supplied more economically in the form of commercial fertilizer, and still more economically by plowing under a preceding crop of cowpeas, velvet beans, or other soil-improving plant. The use of much stable manure, while not unusual, is apt to give the sirup a dark color and inferior flavor.

For plants like sugar-cane, in which a high quality of product is important, it is usually regarded as better to employ sulfate of potash than muriate of potash or kainit. However, this point needs further investigation.

**481. Summary regarding fertilization of cane.** — On soil not previously enriched, sugar-cane requires a fertilizer rich in nitrogen. Potash is needed on the sandier lands, but apparently not on the rich alluvial soils of Louisiana. Phosphoric acid should generally be supplied, but acid phosphate need not constitute so large a proportion of the fertilizer for cane as for cotton.

#### CULTURAL METHODS

**482. Propagating material.** — Sugar-cane is propagated by planting the stripped stalk, from the buds or eyes of which grow suckers. In the sugar-belt the stubble of cane lives through the winter, so that there cane is usually grown two or three years in succession from a single planting. In the tropics one planting serves for many years.

In the greater part of the American sirup-belt, the stubble is so often killed that a good stand from this source is not expected. Yet at least as far north as Montgomery, Alabama, a small portion of the stubble lives through the winter, and this amount can be increased by plowing two furrows over the stubble before killing frosts occur in the fall. In this region the plants grown from stubble cane are usually small and short-jointed. Hence, stubble cane here is usually not ground, but used as seed material for the next crop.

**483. Preparation of the land in Louisiana.** — A crop of cowpeas grown with corn is plowed under with four-



six-, or eight-horse plows in August or September. Since the cane fields are flat and wet, drainage is here a most important matter. To improve the drainage, the land is thrown into high beds early in the fall, and about a month after the land was first plowed. These beds are usually 5 to 7 feet wide. Plowing is deep. Water-furrows are opened with a double moldboard plow, as an additional step in draining the land.

Throughout the season these beds are kept high and the water-furrows kept open. To better facilitate drainage, "quarter drains" are run across the rows at suitable intervals at a depth of about six inches below the level of the water-furrows. These "quarter drains" empty into narrow, deep ditches, which are about 100 or 125 feet apart and parallel to the rows of cane. Tile drains are in many respects preferable to open ditches, but in the sugar-belt they are liable to become stopped by sediment, deposited when water is backed up in them.

**484. Planting in Louisiana.** — In the top of each bed a furrow is opened with a double moldboard plow, the bottom of which should not be as deep as the water-furrow. In this newly opened trench is planted a double row of cane. The amount of "seed" required by this method of planting is about four tons per acre. The cane is then covered by the use of a disk cultivator. Fall-planted cane is covered with a considerable depth of earth as a protection from cold in winter.

In Louisiana, planting begins as early in the fall as the cane reaches sufficient maturity for the buds to germinate. It continues at least until the grinding season begins in November, when the laborers and teams are needed for

the cutting and hauling of the crop. Whatever areas are not planted in the fall or early winter are planted in February or March, using cane that has been protected throughout the winter in windrows.

Fall planting is usually considered better than spring planting, the former affording an earlier growth and a

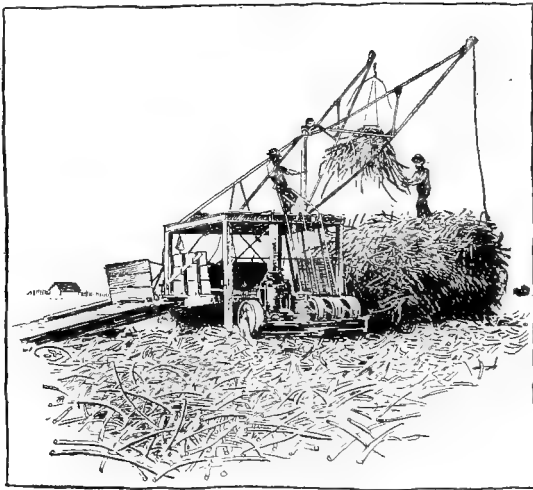

FIG. 210. — ONE FORM OF CANE LOADER.

larger harvest. In Louisiana the entire uncut stalk is used for seed. In some warm countries the tops are planted as soon as cut, thus utilizing for planting that part of the plant which is of least value for sugar-making.

**485. Planting in the pine-belt.** — The land is plowed into beds 5 or 6 feet wide. In the water-furrow is strewn commercial fertilizer, or frequently 25 to 50 bushels of

cotton seed per acre. Cotton seed is usually so high in price that other nitrogenous fertilizers may be profitably substituted for it. When cotton seed is used, it should be supplemented by acid phosphate, or phosphate and potash, mixed in the furrow with the seed. Where much fertilizer is used, a furrow should be made through it, so as to mix it with the soil, thus preventing the eyes of the cane from coming into immediate contact with the fertilizer; this is because the eyes or buds may be killed by contact with certain fertilizers. A single line of cane, the ends of the stalks slightly overlapping, is then planted in the water-furrow. The cane is covered and a list or bed formed above it. This covers the cane so deeply that it is desirable to remove a part of the soil before the young plants come up. This is best done by running a spike-tooth harrow on the rows and parallel with them. This removes the excess of soil, kills sprouting weeds, and, by retaining moisture below the layer of loosened soil, causes an increased number of eyes on the planted cane to grow.

Planting is done chiefly in the first half of March, but in parts of Florida, fall planting is sometimes practiced.

**486. Tillage.** — In Louisiana in the spring, a part of the soil is removed with the hoe from above the fall-planted cane and the row "barred off" and fertilized. Then the soil is thrown toward the rows. Subsequent tillage is effected chiefly by the use of a disk cultivator, supplemented by the use of some other suitable implement in the middles, or water-furrows, which must be kept open continuously to afford drainage.

In the sandy lands, the more common implements of tillage are the *sorape* or sweep and various styles of one-

horse cultivators. Here there is no need to use the hoe to remove the surplus soil, for on sandy land this can be done with a harrow before the young plants appear. Frequent cultivations and occasional hoeings are given up to the time when the cane affords shade enough to keep down weeds and grass. After the first one or two cultivations, the depth should be shallow. On well-drained soils in the pine-belt, there is not the same necessity as in the sugar-belt for making the beds high.

In Louisiana when a crop is grown from the stubble, the dried tops and leaves of the preceding crop are burned in winter; the first tilling then consists in loosening the soil with the "stubble digger." Previous to this, any stubble on which the upper eyes have been injured is cut off below the surface of the ground by the "stubble shaver." Fertilizer is applied in a furrow near the line of stubble, and the soil is then thrown back towards the row.

Dr. W. C. Stubbs thus describes the usual steps in the cultivation of sugar-cane in Louisiana: "As soon as a stand is secured in either plant or stubble cane, the dirt is returned and the middles split out with a two-horse plow and the latter then sent to the tool-room, to remain until the next season. The first cultivation is made by straddling the cane with the disk cultivator, using three unequal disks, running them very shallow and throwing very little dirt to the cane. The middle or diamond cultivator follows, working completely the middle of the row. In this operation, both mules walk between the cane.

"The next cultivation is made in the same way, or if the cane has grown considerably and requires more dirt, the three unequal disks are removed and two or three of equal size are substituted. These disks can be dished to throw much or little dirt. Having displaced the three unequal disks with those of equal size, the

cultivation continues with them, followed immediately by the diamond or middle cultivator until 'lay by' is desired. Then a single large disk is substituted on either side for the smaller equal ones on the disk cultivator, and the two forward shovels on the middle cultivator are turned up, leaving only three for work, and with these the cane is laid by."

**487. Burning.** — The burning of the dried tops and leaves results in the loss of all the nitrogen, but is considered advisable in the sugar-belt of Louisiana as a means (1) of destroying many cane borers; (2) of causing the land to dry out more rapidly than if the litter were left on it; and (3) of disposing of the unrotted vegetable matter that would interfere with cultivation.

**Suggested system of cultivation in Cuba.** — Earle ("Southern Agriculture," pp. 133-135) recommends for Cuba the following as an improvement over the system generally practiced in that country in the care of cane grown from stubble: —

"As soon as the cane is cut, take an ordinary horse hay-rake and drive so as to cross the cane rows, taking the trash from one middle and dumping it in the next one. This quickly and cheaply clears half the ground so that it can be plowed and cultivated, and it provides a double mulch of trash for the other half, so thick and heavy that practically no grass or weeds can come through, and these middles will require no further attention for the season.

"Keep the alternate middles well cultivated until the beginning of the rainy season, and then sow them down to cowpeas. . . . The next year, of course, the middles are reversed, so that all the soil is thoroughly aerated and pulverized every two years. . . . Plowed strips make an efficient fire break; . . . (fire) is an enemy more dreaded than any other by the Cuban planter."

**488. Rotation for sugar-cane.** — As a means of restoring the nitrogen removed in the stalks and in the burning of the leaves, the sugar planters of Louisiana grow and



FIG. 211. — A FIELD OF VELVET BEANS.

One of the best legumes for improving very sandy soils.

plow under cowpeas before planting cane. Their usual rotation is: —

First year: Corn with broadcast cowpeas sown as early

as practicable and at the rate of 1 to 3 bushels per acre.

Second year: Sugar-cane from planted canes.

Third year: Sugar-cane from the old stubble. If the stand of stubble is good and the land very rich, a third crop of sugar-cane may be harvested, this also springing from the old stubble.

The Louisiana Sugar Experiment Station found that when the *entire growth* of cowpeas was plowed under as usual, the subsequent yield was larger by 7.4 tons of cane per acre than where only the *stubble* of the cowpeas was used as fertilizer.

In the pine-belt north of Florida, annual planting of sugar-cane is generally necessary. In this region sugar-cane should usually be preceded either by the Iron variety of cowpeas or by a crop of velvet beans (Fig. 211), plowed under for fertilizer. Since the sugar-cane plant is attacked by nematode worms, this plant should not be grown on land where nematode worms and cotton wilt are found. (See paragraphs 385 and 380.)

#### VARIETIES

**489. Standard varieties.** — By far the most popular variety in the pine-belt is the *purple* or *red cane*. The *striped*, or true *ribbon cane*, is used to a limited extent. For sale in the local markets for chewing, the *green* variety is most popular, and the single stalks of this usually sell at about double the price of other kinds. Green cane is but little used for sirup-making, (1) because this variety matures later than purple cane, and the yield of sirup is believed to be less; (2) because green cane is more easily

injured while in the seed-bed; and (3) because it is regarded as less able to withstand drought.

**490. Other varieties.** — In the sugar-belt red or purple cane and striped cane are the standard kinds. In recent years two seedling canes introduced by the Louisiana Experiment Station have been extensively grown in Louisiana. These are *D 74* and *D 95*. Both have afforded in Louisiana greater yields, a greater per cent of crystallizable sugar, and higher purity than the ordinary purple cane.

*D 95* is a large, erect, purple cane. It has long joints, large stalks, and pale green foliage; it "suckers" or "ratoons" well and is fully as hardy toward cold as ordinary purple cane.

*D 74* is a tall, erect, green cane, with long joints, and a deep green foliage. It "suckers" abundantly and produces large stalks and heavy yields.

The leaves of both of the above varieties are upright in growth and adhere closely to the stalk, which habit may cause them to be topped too low. The yield of these varieties is greater than that of purple cane; the sugar produced has been found to average nearly \$30 more in value (La. Bul. 78, p. 21) than that from an acre of ordinary cane. Moreover, these varieties are more easily harvested, being straighter than ordinary cane.

The Louisiana Experiment Station made many field and sugar-house tests, comparing red or purple with striped cane. The *striped* cane had the following advantages: The stalks grew slightly larger, affording a large yield of cane; the stalks were softer and somewhat more easily crushed and manufactured into sugar.



The *red* or *purple* cane was hardier and multiplied better, producing about 16 per cent more suckers than did striped cane. The stalks of the former were smaller, due to the thicker stand.

**491. Japanese sugar-cane.** — This cane is quite distinct from the other kinds generally cultivated in the United States. The canes are more slender, which makes stripping of leaves more expensive and thus decreases the value of this variety for the manufacture of sirup. Japanese cane is much hardier toward cold than other varieties. The stubble, even as far north as latitude 33, puts out a sufficient number of shoots to insure a stand the next year. A single planting may suffice for a number of years. Only a thin stand is needed at the beginning of the season, since this cane suckers very profusely, fifty or more stems sometimes arising from the same cluster. Its hardiness makes Japanese cane available for sirup even above the central part of the Gulf States. However, its best use here is as a green soiling food for live-stock, especially for hogs.

#### HARVESTING AND USES

**492. Stripping, topping, and cutting** (Fig. 212). — Where cane is grown for sugar, the plant is mature enough to be stripped of its leaves when the lower leaves have become brown and partly loosened on the stalk. Another rule as to the best time for cutting cane for sugar-making is to wait, if practicable, until the fresh juice is thick enough to show a test of 8 degrees on the Baumé spindle. When the usual time for killing frost draws near, stripping and harvesting must be done, even though only a few leaves



FIG. 212.—CUTTING SUGAR-CANE IN LOUISIANA.

have loosened. Every additional week during which the cane grows now adds to its percentage of crystallizable sugar (sucrose) and to the purity of the juice and ease of manufacture into sugar.

Stripping and topping are usually done while the plants are standing. However, in the sirup-belt, the expectation of frost sometimes makes it necessary to cut the cane before stripping. In this case, the canes are piled and protected by their leaves and tops until the stalks can be stripped and ground. After lying thus in piles for a week or more, the leaves somewhat loosen their hold on the stalk, but this is more than overcome by the extra labor required in handling the cut stalks while stripping the leaves.

For stripping the standing plants of cane, a patented stripper enables the laborer in the pine-belt to work about twice as rapidly as by using only his hands, but the stalk is not stripped quite so



FIG. 213.— A DEVICE FOR STRIPPING THE LEAVES FROM SUGAR-CANE.

clean of green leaf-sheaths as by handwork. A stripper (Fig. 213) consists of a wooden handle, to one end of which are fastened two curved, flexible, dull blades, so arranged that they easily spring apart to admit the stalk between them. By a thrust against the stalk it slips into the space made by the curve in the blades; then a downward stroke removes the leaves from each side of the plant.

At the time of stripping, the tops also are removed, usually by a cane knife, at a point just above the uppermost joint that is mature or colored. The cut is made higher up for sirup making than for sugar making, because the uncrystallizable sugar

contained in the upper joints is not harmful in sirup, but undesirable in the manufacture of sugar. After being stripped and topped, the canes are cut near the ground with cane knives or sharp hoes, and piled at convenient intervals, ready to be hauled to the mill.

In a single test (U. S. Dept. Agr., Bur. Chem., Bul. 75, p. 29), it was found by chemical analysis that stripping ten days before topping and harvesting had the effect of reducing the percentage of total sugar. It probably also decreased the weight of cane.

By the use of ropes or hay slings laid in the wagon before loading the cane, unloading can be hastened, the large bundles being removed from the wagons by cranes.

In the pine-belt, stalks intended for planting are dug rather than cut. This is in order to save the eyes at the base of the stalk and to decrease the danger of decay of the cut cane. Experiments are needed to determine whether the extra labor of digging is justifiable and whether the cut cane would keep as well as dug cane if the ends were dipped in tar or in some disinfectant.

**493. Bedding the cane.** — In the pine-belt, before the occurrence of the first killing frost in the fall, that part of the crop intended for seed cane is dug, with its adhering leaves and tops, and piled in beds as follows : —

A layer of cane is placed on the ground, and over this is placed another layer, its roots also resting on the ground, the leaves and tops of this second layer covering most of the first layer. In this way the bed is formed, each layer projecting the lower part of its stalks about 10 inches beyond the layer beneath, the tops and leaves of each layer covering the canes below after the manner of shingles. The width of the bed is usually 6 to 10 feet, and the length varies with the amount of seed cane to be kept.

When all the cane has been put in, it is covered with cane leaves, and over all is thrown a layer of earth, completely cover-

ing the bed to a depth of 3 inches in the southern part of the cotton-belt and slightly deeper farther north.

A rule often followed is to save one sixth of the crop to plant an equal area the next year. The stalks saved for seed usually include all those that are too small to be profitably ground.

**494. Harvesting sugar-cane in Louisiana.** — Harvesting is done by hand, the laborers at one operation topping, stripping, and cutting the standing cane, using a cane knife. Cane loaders (Fig. 210) are now widely used in Louisiana. These usually consist of a swinging boom mounted on a heavy wagon; a grapple fork, lowered from the end of the boom and operated by a small gasoline engine, lifts the cane from the heaps on the ground to the carts, or from the carts into the railroad cars.

Several cane harvesters have been patented, but up to 1910 none of them has come into general use. One great difficulty in securing a satisfactory cane harvester is the crooked condition of many of the stalks.

There are elaborate devices for unloading cars at the sugar factories and for carrying the canes thence to the rollers of the mills. Much of the crop is transported by rail from the fields to the sugar house.

**495. Time of harvesting.** — That part of the crop intended to be planted in the fall is cut early, chiefly before the grinding season begins, and is promptly planted. The canes intended for planting in the spring are cut later, but before being injured by frost, and immediately placed, without being topped, in windrows in every second water-furrow, the tops and leaves of the uppermost plants covering and protecting the stems of those below, lapping like shingles.

Furrows are then thrown on the windrows and the covering of earth is completed by the use of hoes. In spring the surplus soil is removed, and the cane is pulled out by driving suitable implements across the windrows.

This method of keeping planting cane in Louisiana differs from the practice in the pine-belt.

**496. Yields of cane.** — The average yield for Louisiana is about 20 to 22 tons per acre; 25 tons is a fair yield and many fields produce 30 tons or more per acre. A good average yield of sugar is 150 to 160 pounds per ton, giving an average of more than 3000 pounds per acre, and under favorable conditions and in special cases, a yield of 4500 pounds of sugar. An average yield of sugar is accompanied by a yield of molasses amounting to about 100 to 120 gallons per acre. In making sirup alone an average yield in the alluvial lands of Louisiana would be 500 to 600 gallons per acre.

In the sandy uplands of the pine-belt, the yield is usually smaller, or 12 to 15 tons of cane per acre. However, on the sandier soil the cane is richer in total sugars. In this region, it is a poor yield or a poor mill that affords less than 300 gallons of sirup per acre. Under favorable conditions and with good mills, yields above 600 gallons per acre are sometimes made.

In Hawaii, by means of irrigation and the liberal use of fertilizers, yields of more than 100 tons of cane and 24,000 pounds of sugar per acre have been produced. The average yield of the irrigated plantations in Hawaii is said to be 7 tons of sugar per acre.

**497. Uses.** — Sugar-cane is more extensively used for the production of sugar than for any other purpose. This

is its almost exclusive use in countries where the warm seasons are long, as in Louisiana, Hawaii, and Cuba. In those regions where the climate is warm enough for the growing of sugar-cane, but where fall frosts occur too early for the plant to reach the degree of maturity necessary for profitable sugar-making, this plant is used for the production of sirup. Since, in the United States, sugar-cane can be grown for sirup over an area considerably larger than that suitable for profitable sugar production, a larger number of farmers are probably engaged in growing this plant for sirup than for sugar. However, the average sirup maker grows but a few acres at most, while in the sugar-belt, single plantations include hundreds or even thousands of acres of cane.

*Sirup* is the product obtained by boiling the juice from the cane. *Molasses* is a by-product in the manufacture of sugar, and, in its unadulterated form, much less extensively used on the table than is sirup. *Blackstrap* is the name of a very inferior grade of molasses, chiefly valuable as food for live-stock.

The chief difficulty in extending the market for sirup lies in the fact that there is such a wide variation in the quality of sirup made by different farmers. Certain improvements in the methods of making sirup as shown in later paragraphs would result in a more uniform product and in an increased demand.

**498. By-products.** — The tops and green leaves of sugar-cane make a satisfactory food for live-stock. The crushed stalks, called "bagasse," are seldom utilized in the pine-belt, but they are used as fuel in the sugar houses. From this material also paper has been successfully made.

## SIRUP-MAKING

**499. The equipment.** — Since the making of sugar is a highly specialized branch of manufacturing, and not a part of farm work, a discussion of sugar making would be out of place in this book. On the other hand, the making of sirup is usually a part of the farmer's operations; hence it will be briefly discussed here.

The usual equipment for the making of sirup is not expensive. It consists essentially of a mill for crushing the cane and of a shallow pan, heated by furnace heat or by steam, for evaporating the juice of the cane down to the density required in sirup.

The small roller mills operated by a single horse often extract only about half of the juice, thus causing an enormous loss. A first-class three-roller mill, properly set, will extract 60 per cent of the weight of the cane or 70 per cent of the total juice. More powerful mills with a larger number of rollers and usually driven by steam, may express more than 80 per cent of the juice.

The evaporator is usually a rectangular pan placed above a home-made furnace, in which wood furnishes the necessary heat. The bottom of the pan consists of a sheet of copper or galvanized iron, and the sides are usually of wood. In the pan are three divisions, separated by partitions, in which are gates or openings intended to regulate the flow of juice from one compartment to the next one.

When steam is available, it is more convenient to cook the sirup by means of the heat given off by coils of steam pipes laid in the bottom of the evaporating-pan. The advantage of steam heat consists in the ability to regulate



by a cut-off, the amount of heat, and thus to avoid any danger of scorching the sirup.

After being expressed by grinding, the fresh juice is strained. In addition, it is sometimes strained through a barrel of black moss. From the strainer the juice is conveyed to the evaporator. Here it is heated rather slowly. Heat causes the solid impurities to coagulate or collect in masses of scum. This scum is removed before boiling begins, and repeated skimmings remove all other scum that rises. The boiling is continued in the next two compartments of the evaporator until the hot sirup has a ropy consistency, or, better still, until a Baumé hydrometer, dropped into a slender deep vessel of hot sirup, sinks to the mark on the scale indicating a density of 34°. This instrument, costing only about \$1, is a far safer guide as to when to stop the cooking than is the eye, even of an experienced sirup maker. The use of a hydrometer is essential for all who would make a uniform grade of sirup.

**500. Preventing sirup from turning to sugar.**—The first aim in making sirup is to produce an article of an agreeable flavor and nearly clear, or of bright color. The use of immature cane or of cane injudiciously fertilized results in injury to the flavor and appearance of the sirup.

Another important aim in making sirup is to make a product that will not, at a later date, crystallize or turn to sugar. The larger the proportion of glucose (or non-crystallizable sugar) in the sirup the less is the danger of the sirup turning to sugar.

Conditions favorable to a large proportion of glucose, and hence to a sirup not easily crystallized, are the following:—

(1) Cane not thoroughly ripe in the upper joints, that is, cane topped rather high, since it is these partially ripened internodes that contain the largest proportion of noncrystallizable sugar.

(2) Juice that is slightly acid, as indicated by its changing blue litmus paper to a reddish color. If the perfectly fresh juice is not distinctly acid, it becomes acid after standing for a time, and after being repeatedly strained, by which it is brought into contact with acid-forming germs.

(3) Slow cooking is desirable, since crystallizable sugar may be changed to glucose when heated for a long time in the presence of an acid, as in the acid juice.

(4) Stopping the cooking before the sirup becomes very concentrated checks the tendency to crystallize.

(5) Exclusion of air, by canning or bottling while hot, is an effective means by which sirup is kept from turning to sugar.

**501. Effects of canning.** — The sirup that commands the highest price is that which, while still boiling hot, is placed in cans, jugs, bottles, or other air-tight vessels, and promptly sealed, using solder on tins or sealing wax on top of the corks of jugs or bottles.

The reason for placing sirup while hot in air-tight vessels is to prevent the entrance of germs, which would cause the sirup to ferment. Intense heat destroys whatever germs may be already present in the empty vessels. However, it is best first to sterilize these vessels, that is, to kill the germs in them, by the use of steam. It has been found possible to preserve sirup in an unfermented condition in tight barrels which had been sterilized by steam and sealed while the sirup was still very hot. However, it is usually not possible to keep barreled sirup in a completely sterile condition. Hence, barreled sirup should be consumed in winter, while that preserved in sealed cans, jugs, or bottles may be safely kept for use in warm weather.

**502. Use of chemicals in sirup-making.** — Certain simple chemical substances are freely used in the manufacture of sirup. The clear color and the degree of acidity desirable to prevent sugaring of unsealed sirup are sometimes attained by passing the juice downward in thin layers through a box or barrel in which it is exposed to the ascending fumes of sulfur, burned in a small furnace connected with the bottom of the sulfuring vessel.

Lime, slacked to a thin paste, is often added to clear the juice by causing the vegetable impurities in the juice to settle. Care is taken not to add enough lime to overcome the acidity of the juice unless means of overcoming the effects of lime are at hand. If the juice should become alkaline, its acidity may be restored by the addition of a little of a preparation called "clariphos," (a pure form of phosphate of lime, which also assists in clarifying the juice).

#### HISTORY AND STATISTICS

**503. Early cultivation.** — Sugar-cane is a native of Asia and probably of India. It was cultivated in India and China long before the Christian era. Yet not until after the discovery of America did sugar become a very important article of consumption among the inhabitants of Europe and America. The ancient Greeks and Romans seem to have lacked the luxury of sugar.

From Asia, sugar-cane was carried to the islands of Oceania and to Africa. The Portuguese carried it to the Madeira and Canary Islands, southwest of Europe, whence, soon after the discovery of the New World, it was brought to the West Indies.

From the West Indies, sugar-cane was introduced into Louisiana and Florida about the middle of the eighteenth century.

The first sugar from sugar-cane in what is now the United States was made in Louisiana in 1791, but so small was the quantity that the product was rather an article of curiosity than of use. In 1795 sugar was first manufactured in Louisiana on an extensive scale. De Bore, the pioneer in sugar-making in the United States, made a fortune in growing sugar-cane and in manufacturing sugar on his plantation in Louisiana.

**504. Production.** — From this small beginning the production of sugar increased so rapidly that at the beginning of the Civil War, within two thirds of a century after the first sugar was manufactured in Louisiana, the annual production of sugar in that state had reached about a quarter of a million tons. The Civil War reduced the yield to a small fraction of this amount. At the end of the first decade of the twentieth century Louisiana was producing annually about a third of a million tons of sugar. During this decade the sugar industry in the southern part of Texas has developed rapidly.

Hawaii produces somewhat more sugar, and Porto Rico somewhat less, than does Louisiana. Cuba manufactures considerably more sugar than the total product of all the American states and territories just named. Cuba and Java are the world's largest producers of sugar from sugar-cane.

In recent years the world's annual crop of sugar of all kinds is about 14,000,000 tons, more than half of which is made from sugar-beets. Sugar-cane affords about

5,000,000 tons of sugar annually. Sorghum, the sugar palm, and the sugar-maple tree afford relatively insignificant amounts of sugar.

**505. Home consumption.** — The United States consumes a larger quantity of sugar in proportion to population than any other country; it produces in the Southern States and in Hawaii and Porto Rico, less than half of the sugar consumed in the United States. Therefore, there is room for immense expansion in this country in the growing of sugar-cane for the manufacture of sugar.

#### ENEMIES

**506. Insects.** — The cane-borer (*Diatrea saccharalis*) is the principal insect enemy of sugar-cane in Louisiana, and this pest is widely distributed in cane-growing countries. It is the larva, or caterpillar form, of a yellowish moth. The full-grown larva measures about one and a quarter inches in length. The injury is done by boring into the stalks of cane. Sorghum, Johnson grass, and corn are also attacked; this insect is also known as the "larger corn-stalk borer."

The best treatment is merely preventive, and consists in burning the tops and other litter of the cane in those regions where this borer is found, and in destroying any Johnson grass in and near the cane-fields. Since the borer has not been reported extensively, if at all, in the American sirup-belt, where cane is not grown for several years in succession on the same land, care should be taken not to import this pest in seed canes from any infested region.

The Southern grass-worm (*Laphygma frugiperda*) is sometimes troublesome in Louisiana after overflows. Treatment consists in attaching a light piece of timber to the cultivating implement in such a way as to jar the cane, which causes the caterpillars to fall to the ground, where they are covered with soil by the cultivator. Dusting plants with one part Paris green to five parts of slacked lime is also recommended by Stubbs.

The *sugar-cane leaf-hopper* occurs in Hawaii, having been accidentally introduced in seed canes from Australia. The method of combating it consists in the importation of its insect enemies or parasites. This leaf-hopper is not known in the United States.

**507. Diseases.** — Red cane, a discoloration of the interior of the stem following cuts or bruises, is harmful if such injured canes are planted.

There are several serious fungous and bacterial diseases of sugar-cane occurring in tropical countries. Among the means of escaping many of these are the selection of varieties that show the greatest resistance to these diseases.

**Root disease.** — This is due to a fungus (*Marisnius sacchari*), which may live from season to season in the soil or in the dead and decaying parts of the diseased cane plants. The disease may be shown above ground by the formation of a white, mold-like growth on the lower leaves. The plants appear as if suffering from severe drought, due to the loss of many of the small roots, killed by this disease. Preventive measures consist in burning the cane litter or diseased areas and planting canes free from disease. It is best for the canes for planting to be grown in a special seed field, the "seed cane" for which has either been carefully examined, or perhaps disinfected (La. Expr. Sta., Bul. 100). Any methods of improving conditions for the growth of cane, as drainage and good cultivation, minimize the injury from this disease.

## LABORATORY EXERCISES

(1) Count and record the number of true roots from a node just under the surface of the ground; also the number of dots on a node about a foot above the ground. Do roots develop from most of the dots?

(2) Measure and record in order the length of each internode from the surface of the ground to the uppermost part of the stem.

(3) Cut a cross section through a stalk of sugar-cane and make a drawing showing the relative number of bundles near the center and near the rind.

(4) Dip the cut end of a cane bearing green leaves into diluted red ink, and a few hours later split the next few joints above, and trace the red liquid rising in the water vessels. Make a drawing of one such longitudinal section.

(5) When a cane mill is next seen at work, note the dropping of the liquid from one end of the cane as soon as the roller presses the other end.

(6) If cane that has been kept over winter or subjected to cold weather can be found, cut lengthwise through a live bud and through a dead bud, and make a drawing or description of the appearance of each.

(7) Wash away the soil from around a cluster of canes and attempt to determine which is the oldest and which the youngest cane in the cluster.

## LITERATURE

## General.

STUBBS, W. C. Sugar-cane. Vol. I. La. State Dept. Agr., Baton Rouge, Louisiana.

STUBBS, W. C., BLOUIN, R. E., and DODSON, W. R. La. Expr. Sta., Buls. Nos. 59, 66, 70, 78, 100.

EARLE, F. S. Southern Agriculture. (The Macmillan Co.), New York, pp. 117-141.

EARLE, F. S. Cuba Expr. Sta., Bul. No. 2 (English Edition).

COBB, N. A. Sugar-cane. Bailey's Cyclo. Agr., Vol. II, pp. 599-611.

WIGHT, J. B. Sugar-cane. Association of Commissioners of Agr. of Southern States, Proceedings of Fourth Annual Meeting (1902), pp. 66-75.

**Manufacture of sirup.**

ROSS, B. B. Ala. Expr. Sta., Buls. Nos. 66, 103, 133. (All out of print.)

STOCKBRIDGE, H. E. Fla. Expr. Sta., Bul. No. 44.

ROSE, R. E., and MCQUARRIE, C. K. Fla. Farmers' Institutes, Bul. No. 1.

WILEY, H. W., and others. U. S. Dept. Agr., Bur. Chem., Buls. Nos. 70, 75, 93, 103.



## CHAPTER XXX

### TOBACCO — NICOTIANA TABACUM

TOBACCO belongs to the nightshade family (*Solanaceæ*). This family also includes the Irish potato, tomato, and the Jimson weed.

Tobacco is used chiefly for human consumption, the habit of chewing and smoking being general throughout a large part of the world. Snuff, insecticides, and some other articles are also manufactured from tobacco. The stems and other cheap by-products make valuable fertilizers.

**508. Description.** — Tobacco is annual and makes its growth during the warm season. The plant has a stout stem, usually 4 to 7 feet high, from which grow large, thin leaves, which constitute the valuable part of the plant. The root system is rather shallow; the leaves vary in size and shape in different types and varieties of tobacco. They are arranged in eight vertical ranks, so that the ninth leaf is immediately above the first or lowest leaf, a fact which enables the farmer to top the plant to a definite number of leaves without stopping to count all of them.

**509. Distribution of tobacco.** — The first settlers in America found the Indians cultivating tobacco, and this crop soon became the leading cash crop of the Virginia and Maryland colonists. It even became the medium

of exchange, taking the place of money. Tobacco is now extensively grown in certain restricted sections from Connecticut to Texas. Among the Southern States Kentucky is the largest producer, followed by Virginia and North Carolina. In recent years, the production of a high-grade cigar tobacco has become a leading industry in the northern part of Florida and in other localities in the Gulf States.

**510. Composition.** — All kinds of tobacco contain varying quantities of the narcotic alkaloid, nicotine, which is a recognized poison. The heavier and stronger the leaf, the larger, as a rule, is the proportion of nicotine.

All parts of the tobacco plant are rich in potash and nitrogen and also contain considerable amounts of phosphoric acid. Tobacco is an exhausting crop.

**511. Soils and their relation to types of tobacco.** — None of the ordinary crops of the farm is so much influenced in quality by the soil on which grown as is tobacco. For this reason tobacco culture is largely confined to restricted areas and to particular soils. An exact description of the soils suited to each type is not easily made. In general, cigar tobacco and other kinds in which a thin leaf is desirable succeed best on rather light or sandy soils. On the other hand, heavy or dark tobacco is best suited to stiffer land. Burley tobacco is grown almost exclusively on limestone soils, chiefly in Kentucky and adjacent states.

For most grades of tobacco, newly cleared land is preferred, since an abundance of humus is desirable. For this reason, growers of this crop have cleared most of the forests from the best soils of the tobacco districts.

The dark export tobacco of Virginia is largely grown

on the reddish soils described as Cecil sandy loam and Cecil clay.

Cuban cigar tobacco thrives best on gray sandy soils and on the Orangeburg series, consisting of a fine sandy loam, or clay loam, with stiffer, reddish clay-loam subsoil.

For Sumatra tobacco in Florida, gray, sandy, hammock land, new and rich, is preferred. There are many other special kinds of soil suited to particular types of tobacco.

**512. Fertilizers.** — As shown before, tobacco removes from the soil a large amount of potash and nitrogen. For this and for many other reasons (including the desirability that the plant should make a rapid and continuous growth), tobacco is liberally fertilized. The chief reliance is on commercial fertilizers.

The form in which potash is applied is especially important. Muriate of potash and kainit should both be avoided, because of the large amount of chlorine found in both, which element is unfavorable to the burning qualities and other properties of tobacco. Instead, potash is best applied in the form of carbonate or sulfate of potash.

**513. Nitrogen supply.** — Nitrogen may be applied in several forms: Organic nitrogen, supplied by cotton-seed meal, dried blood, etc., is a preferred form. Nitrate of soda is also used in moderate amounts. A mixture of organic nitrogen and of nitrate of soda is apparently preferable to either alone. Barnyard manure usually makes the leaf coarser than it would otherwise be; yet cow manure has been advised for shade-grown Sumatra tobacco in Florida, especially with the view to supplying humus and making the growth of the root system so rapid as to cause the production of new roots more rapidly than

the nematode worms (paragraph 385) can destroy the older roots.

**514. Formula.** — A fair proportion of acid phosphate is customary in all tobacco fertilizers, but an excess of this constituent has been found to injure the quality of the leaf. A complete fertilizer similar in composition to one in common use in North Carolina may be made as follows:—

300 pounds acid phosphate per acre,  
 50 pounds nitrate of soda,  
 200 pounds dried blood, and  
 150 pounds high-grade sulfate of potash.

For shade-grown Sumatra tobacco, the amount of fertilizer used is several times larger than indicated above. For this purpose A. D. Shamel recommends the following kinds and amounts per acre:—

1000 pounds cotton seed,  
 1000 pounds cotton-seed meal,  
 300 pounds carbonate of potash,  
 700 pounds fine ground bone,  
 800 pounds lime,  
 3800 pounds, total.

**515. Types and varieties of tobacco.** — “The principal types of tobacco are the following: (1) Cigar wrapper and binder; (2) cigar filler; (3) chewing or plug; (4) smoking; (5) export tobaccos.” Types refer chiefly to the principal use made of each kind, and to the market for each.

Cigar wrapper and binder tobacco is produced from several widely different varieties, the kind commanding the highest price being the Sumatra, grown under cloth or slat shade, chiefly along the Gulf coast. The best of

the shade-grown Cuban tobacco is also sold as high-priced cigar wrappers. Cuban tobacco grown without shade is chiefly employed for cigar fillers; that is, for the body of cigars. In the United States it is grown chiefly in Connecticut and near the Gulf Coast.

The dark, heavy tobaccos of southern Virginia and of Tennessee, — for example, the varieties Blue Pryor and Orinoco, — belong chiefly to the chewing or plug and to the export types. The greater part of the bright tobacco of North Carolina and of the light-colored tobaccos of Virginia and Maryland are employed for smoking.

The White Burley, grown in Kentucky, is chiefly used for chewing tobacco, but also for smoking.

**516. Saving seed, and tobacco breeding.** — The large, conspicuous flowers (Fig. 214) of tobacco are borne in clusters. The flowers are either self-pollinated or cross-pollinated. Experiments have demonstrated that by inclosing the flower buds under paper bags so as to prevent cross-pollination, the plants from seed thus produced are more uniform, productive, and vigorous than when cross-pollination is permitted. Any variety of tobacco can be improved by careful selection of the

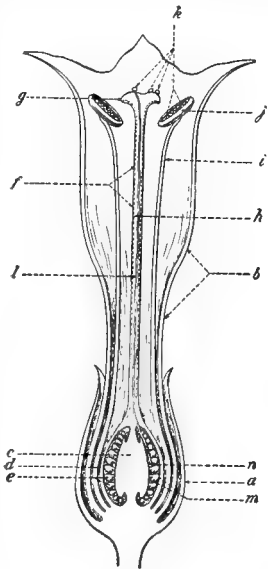

FIG. 214. — DIAGRAM OF TOBACCO FLOWER.



FIG. 215. — SHOWING THE RESULTS OF BREEDING A STRAIN OF TOBACCO RESISTANT TO DISEASE.



FIG. 216. — YOUNG TOBACCO PLANTS.  
The largest plant, on the left, is from the heaviest seed.

best plants (Fig. 215) and by thus bagging the flowers to insure self-pollination. Only the central cluster of flowers should be bagged, the others being removed.

The seeds of tobacco are extremely small. The largest of these produce much better plants than the smallest (Fig. 216). A special device or blower has been invented for use in removing the smaller seed from those to be planted (Fig. 217). This device consists of a glass tube about five feet long, with a fine-mesh wire screen near the bottom, and a small bellows connected with the lower end of the tube.

In growing Sumatra and Cuban tobacco, it is customary to import the seed every year or every few years from Sumatra and Cuba.

#### CULTURAL METHODS

**517. Seed-bed.**—The seed of tobacco are so minute, requiring about 5,000,000 to make one pound, that it is necessary to germinate the seed and start the young plants in a specially prepared

seed-bed, from which they are later transplanted to the field. The preferred location for a seed-bed is on recently cleared land, where the soil contains much vegetable matter and few seeds of grass and weeds. A well-drained spot, sheltered on the north, is usually best. The seed-bed should be convenient to water, since the bed must be

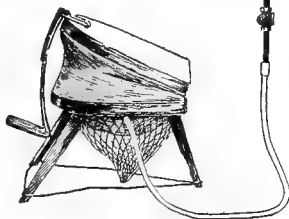

FIG. 217.—A TOBACCO SEED BLOWER.

watered often enough to keep it continually moist, in order to insure the prompt germination of the seed and the rapid growth of the young plants.



FIG. 218. — A CLOTH SHADE OR TENT, HERE USED AS A SEED-BED.

As a rule, brush and wood are burned on the chosen spot until the soil has been well heated to a depth of about



3 inches. The chief object in this is to destroy weed seeds. Then the soil is spaded or dug and thoroughly prepared by raking. The bed is inclosed on all sides by a frame made of inch boards placed on edge.

Since the burning drives off much of the nitrogen, and since the seeds are so small as to furnish practically no food to the young plant, the bed must be fertilized liberally, using quickly soluble, complete fertilizers rich in nitrogen. About 20 pounds of nitrate of soda for each 100 square yards of surface is especially helpful. Most of this may be applied before planting, but additional amounts of nitrate of soda may be added in very dilute solution in the water applied to the young plants.

After raking in the fertilizer, preferably a week or more before planting the bed, the seed are sown and the frame covered with light cotton cloth. The purpose of the canvas covering is to retain the moisture and heat and hence to hasten germination and growth. The cloth also keeps out some injurious insects. This covering should be removed about a week before the plants are to be set in the field, so that they may become toughened.

**518. Sowing the seed.** — The seed are sown in January or February, or, in the cooler parts of the South, in March. The seed are first mixed with wood ashes or corn meal, so that they may be more evenly distributed. To further insure uniformity of distribution, half of the seed are usually sown broadcast in one direction over the entire bed, and the remainder are then sown crosswise to the direction of the first sowing. The seed are pressed into the soil with a light roller or by the use of the feet, sometimes after the surface has been very lightly raked, brushed, or whipped.

The quantity of seed varies greatly with different growers. An amount frequently used is from 1 to 2 tablespoonfuls for each 100 square yards of tobacco bed

**519. Preparation of land.** — For tobacco the land should be thoroughly prepared a number of weeks or even months before the plants are to be set in the field. The first plowing is level or broadcast. Rows are opened at the desired distance apart, the fertilizer is drilled in these and mixed by the use of some cultivating implement. Then a ridge or "list" is thrown up above the fertilizer. The details of preparation vary greatly in different regions, the tobacco being sometimes planted on ridges and elsewhere practically on a level, the "list" which covered the fertilizer having been first pulled down with a harrow or board.

**520. Distance between plants.** — Practice varies greatly with different types of tobacco and in different regions. In the dark tobacco district of Virginia and Tennessee, the rows are usually  $3\frac{1}{2}$  feet apart and the plants about 3 feet apart in the rows. On the other hand, White Burley tobacco in Kentucky stands nearly twice as thick as this in the row; while under shade in Florida, Cuban tobacco is set 14 inches apart and Sumatra tobacco only about 12 inches apart in rows  $3\frac{1}{4}$  to 4 feet apart.

**521. Setting or transplanting.** — After the plants are of sufficient size, all danger of frost past, and the soil thoroughly warmed, the young plants are set in the field at the desired distance apart. In Florida, setting of Cuban tobacco should be finished by the middle of May and the transplanting of Sumatra tobacco should be completed by the middle of June, the bulk of each crop being set considerably earlier.

In Virginia the period for setting plants extends from the middle of May to the latter part of June. Here early

setting is much preferred, partly because, with tobacco cured with little or no artificial heat, conditions are much better for curing the early crop than for tobacco that ripens after cool weather begins.

Plants are usually ready to be set in the field 9 to 10 weeks after the sowing of the seed, or at a shorter interval when the seed-bed is planted late.

Before removing the young plants from the seed-bed, the latter is thoroughly moistened. Then the young plants are carefully lifted, carried to the field, and set with the least possible delay. Some Florida growers prefer to wash from the roots the adhering soil of the plant bed.

Setting of plants is usually done by the use of a short, sharpened stick or peg. For setting large areas, a transplanting machine is advantageously employed. This machine (Fig. 219), manned by a driver and by two men to drop the plants, sets, waters, and places soil around the plants at one passage along the row.

In three or four days after setting, or as soon as the dying plants can be detected, the field should be reset.

**522. Cultivation or tillage.**—About a week after the plants are set, the field should be tilled. The first cultivation may be deep, if loosening of the soil is rendered necessary by previous tramping while setting the plants or by the compacting of the soil as the result of heavy rains. All later tilling should be shallow and repeated at frequent intervals. With shade-grown tobacco, cultivation is given weekly. Usually two hoeings are required. Tillage usually ceases, especially in shade-grown tobacco, when the buttons or flower heads appear or when the leaves become too large.

**523. Topping.**—This practice consists in removing

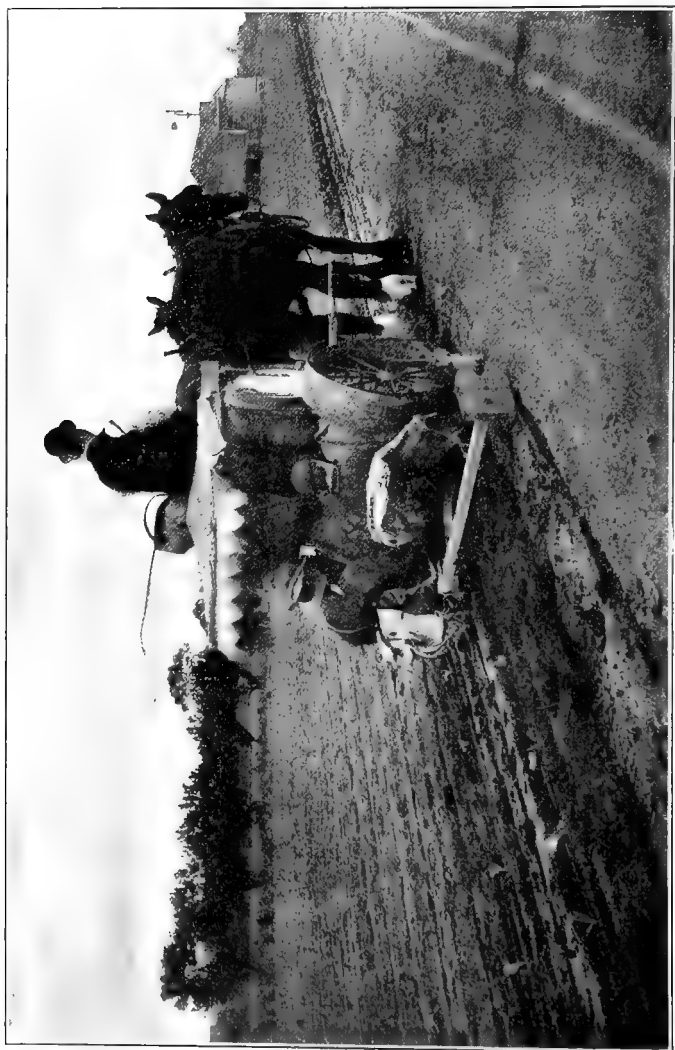

FIG. 219. — A TRANSPLANTING MACHINE FOR SETTING TOBACCO.

the main or central flower bud together with such a number of the upper leaves as will save, to mature on the plant, only the number of leaves found best for each variety of tobacco and for each class of soil.

The object of topping is (1) to increase the size of the remaining leaves, by concentrating in them more of the elaborated plant-food ; (2) to make the leaves thicker and of stronger quality ; and (3) to make the crop mature as uniformly as possible. The general rule is that the fewer the leaves left, the larger, thicker, and stronger in quality will they be. On the other hand, high topping results in leaves of reduced size, but having the thinness that is prized in cigar wrappers.

The number of leaves left varies greatly among the different types. In heavy tobacco, it is usually 8 to 10, in Burley at least 14, in Cuban at least 16 ; in shade-grown Sumatra 25 or more leaves may be permitted to mature. With Sumatra tobacco, grown under shade, topping is sometimes omitted if the land is very rich, the aim in this case being to make the leaves thinner than if the plants were topped.

**524. Suckering.** — Soon after the plants are topped, branches or suckers grow from the axils of the leaves. These should be pinched or broken off before they have received much of the plant's supply of nourishment. This process of suckering, or removing of suckers, should be done at such frequent intervals as to prevent their reaching a length of much more than 2 inches. The object in suckering is to prevent the diversion of plant-food and growth into these branches and to concentrate growth in the best or middle leaves.

**525. Growing tobacco under shade.** — It has been

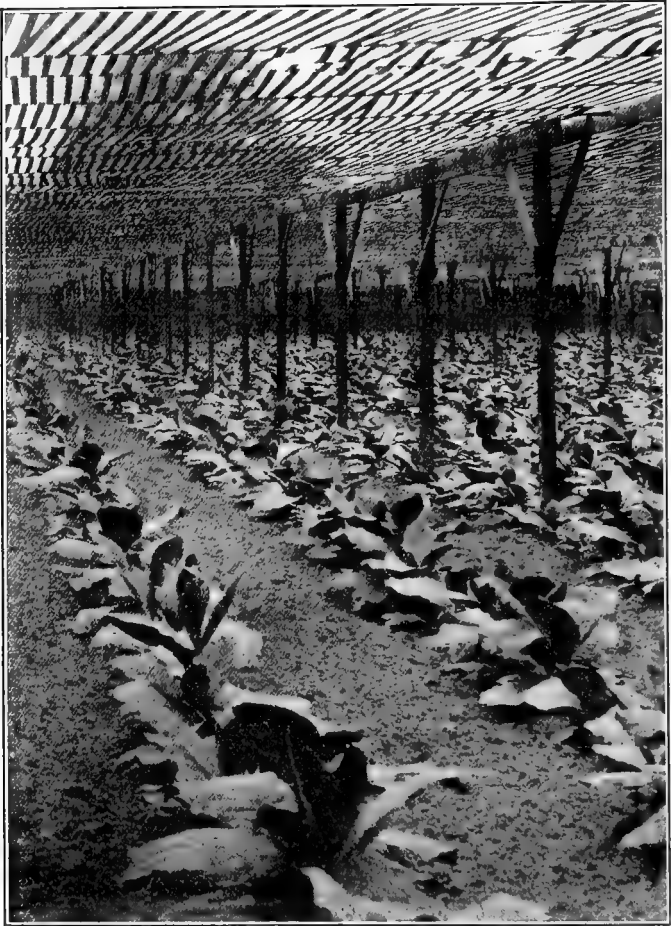

FIG. 220. — YOUNG TOBACCO PLANTS GROWING UNDER A LATH SHADE  
IN ALABAMA.

found by experience that tobacco grown under artificial shade affords the highest quality of cigar wrappers and the largest proportion of leaves fit for this use. This is the common method of growing Sumatra and Cuban tobacco for cigar wrappers.

A "shade" consists of a field inclosed by a solid wooden wall about 9 feet high, the entire area of the field being covered at this height with thin cotton cloth or with laths (Fig. 220). The purpose is (1) to exclude a part of the sunlight, thereby making the leaves thinner, and (2) to increase the amount of moisture in the air and the soil, the result of which is a luxuriant and rapid growth. Shade-grown tobacco plants grow tall, often standing 9 feet high. They mature a large number of thin elastic leaves.

When laths are used, they are usually so arranged as to afford half shade; that is, the space between laths is equal to the width of a lath. The covering of laths or cloth is supported by a suitable framework of wood and crossed wires. The cost of shading an acre with laths is several hundred dollars. Tobacco under shade is more highly fertilized than is customary with tobacco grown in the open, and extreme care is taken to make all conditions of preparation, fertilization, and cultivation favorable to rapid growth. The result is a large proportion of leaves free from any blemish, and possessing the size and quality to command the highest price that is paid for any American tobacco.

**526. Place of tobacco in the rotation.** — The following six-year rotation is recommended in Bulletin No. 165 of the Virginia Experiment Station for tobacco fields in the dark-tobacco district of Virginia.

First year: tobacco.

Second year: wheat.

Third and fourth years: mixed grasses and clover.

Fifth year: corn.

Sixth year: cowpeas.

This brings tobacco immediately after cowpeas, after which the rotation is repeated.

In the limestone region of Kentucky the best position for tobacco is believed to be after a blue-grass sod, which supplies the necessary vegetable matter. Tobacco is then grown two years. It is followed by wheat, in which is sown a mixture of the seeds of clover, timothy, and blue-grass, with a view to again getting the field, after a few years, into blue-grass. For the same region the following four-year rotation has been suggested, where it is not practicable for tobacco to follow blue-grass:—

First year: tobacco.

Second year: wheat with grass seed.

Third year: clover and timothy.

Fourth year: clover and timothy.

In the bright-tobacco districts of North Carolina a good plant to furnish the necessary vegetable matter and nitrogen is crimson clover, which may enter the rotation as a catch crop after cotton or corn and either immediately before, or a year preceding, the time when tobacco is to occupy the field.

### HARVESTING AND CURING

**527. Indications of maturity.**—Tobacco will usually be ready for harvesting in three to three and a half months after the plants are set, or somewhat more than a month after the date of topping. The ripening of tobacco is shown by the following symptoms: (1) The leaves change from a deep green to a lighter shade of green, with a faint tendency to yellowing or to yellowish mottling. (2) The leaf tends to crumple, especially along the edge. (3) The leaf veins become quite brittle, so that when the leaf is folded between the fingers, a clear, distinct break is made. (4) The leaf becomes heavier and somewhat less smooth to the touch.



**528. Two methods of harvesting.** — The two methods of harvesting are (1) priming, that is, removing the leaves separately, and (2) cutting the stalks. While the object of topping is largely to cause the remaining leaves to ripen more nearly together, yet they will not all arrive at the best stage for harvesting on the same date. On account of this difference in the time of ripening of the leaves on the same plant, it has become customary, especially with high-priced tobacco, to harvest each leaf separately, priming it, or going over the field several different times.

The other method of harvesting consists in cutting the entire stalk with the attached leaves. The stalk is then split from the top to near the base, and 6 to 10 of the split plants are then straddled over a split stick or lath, or otherwise strung on a stick which is about  $4\frac{1}{2}$  feet long. The plants are then allowed to wilt slightly, taking care that they are not injured by too much exposure to the sun. After wilting they are hung for a few days on a scaffold in the field, and later carried to the curing barn; or they are taken directly from the field to the barn, where they are to be cured.

When the leaves are harvested separately, or primed, they are strung on wires or strings, being arranged in pairs with the upper surfaces facing each other, so as to prevent excessive crumpling.

**529. Methods of curing.** — Methods of curing differ widely, varying with the type of tobacco and with other conditions. They may be divided into (1) curing with open fires; (2) flue-curing; and (3) air-curing. Special barns are built to suit the method of curing. Those intended for the flue-curing process are supplied with ven-

tilators in the top, with a furnace, and with flues of terracotta or other suitable material for conveying the heat through the barn. Structures in which air-curing is to be done should have numerous ventilators on two sides.

All curing barns are supplied with the necessary interior framing to support the sticks on which the tobacco is hung.

**Fire-curing.**—The method practiced in the dark-tobacco district of south-central Virginia is thus described in Bulletin No. 175 of the Virginia Experiment Station:—

“The yellowing stage is the first step in the curing process. The change to yellow is caused by a breaking down of the green chlorophyll granules during the first few days after the plant is cut. The riper the tobacco, the more quickly will this change take place. Therefore, to yellow uniformly, the plants should be cut as nearly as possible at a uniform stage of ripeness. This change in the leaf is favored and hastened by a gentle warmth (about 90° F.), by moderate moisture, and by dampness. It is not customary to use artificial heat in yellowing this type of tobacco, especially with early-cut tobacco. . . .

“The next change that takes place in the leaf is from the yellow to the brown stage, and for this purpose artificial heat is used. . . . The first fires built under this tobacco should be very small to avoid danger of premature drying of the tips of any of the leaves not yet fully yellowed. The temperature should not be raised above 95° F. or 100° F. at this first firing, and should be maintained only long enough to dry out the surface moisture and start the tips of the leaves, already well yellowed, to turn brown. A few hours at this time will generally be sufficient. . . . This process should be repeated every few days until all the gum has disappeared from the leaf and the tips of the leaves have begun to take on the brown color. After these conditions have been attained, a somewhat higher temperature may be used safely if the moisture supply is sufficient not to result in the dry-

ing of the leaf before the color changes have taken place. It will not usually be found desirable for the temperature to rise above 125° F. for any length of time. . . . After the barn has been fired three or four times, the leaf will require no further attention, until it is desired to take the tobacco down, perhaps several weeks later.

“As a general principle, to cure tobacco light it should be spread thinly in the barn and enough fires used to cause a quick cure without drying the leaf too rapidly. To darken or blacken tobacco, the principle is to delay the cure and not to dry off excessive moisture faster than is necessary to prevent actual damage. . . . Tobacco once darkened cannot be lightened again; it is possible for the manufacturer to take light tobacco and darken it.”

**530. Flue-curing.** — Most of the bright tobacco of North Carolina and Virginia is flue-cured in specially constructed barns, the process requiring only three or four days.

“As soon as the barn is filled with tobacco, fires should be started, and the temperature raised to 90° F., where it should remain for 24 to 30 hours, during which time the tobacco becomes a uniformly bright yellow. Then the temperature is raised from 90° to 120° F., from 15 to 20 hours. This process is commonly known as ‘fixing the color.’ The temperature may then be increased gradually to 125° F., at which point it should be maintained for about 48 hours. By this time the leaves should be almost, if not entirely, yellow, but the stalk will still be green. In order to cure the stalk, the temperature can be raised to 175° F., at the rate of 5° an hour, where it should remain until the stalks are thoroughly dried.” — A. D. SHAMEL in Bailey’s “Cyclopedia of Agriculture,” Vol. II, p. 652.

**531. The air-curing of Cuban cigar tobacco in Florida.** — Most Sumatra and Cuban cigar tobacco is subjected to air-curing, as are also many other types, including White

Burley. The curing of Cuban cigar tobacco in Florida is thus described:—

“When the tobacco is primed from the stalk, it should not take longer than two weeks to cure; when hung on the stalks, three or four weeks are necessary. . . . In a general way it may be said that if a barn is filled with green tobacco, and the weather is hot and dry, the ventilators should be tightly closed for about three days, by which time the tobacco will be quite yellow. The barn should then be opened at night and kept closed during the day. This is done to prevent rapid curing, as rapid curing destroys the life of the leaf and gives uneven colors. If there are frequent showers, and but little sunshine, the barn should be closed and the fires started in small charcoal heaters distributed throughout the barn. These fires should be continued as long as is necessary to keep the barn in proper condition. Where the charcoal heaters are not available, wood, which has little odor and as little smoke as possible, should be used. . . . To obtain the best results, the tobacco should become fairly moist and be fairly dried out once in every 24 hours.

“When the stems of the leaves are thoroughly cured, they are ready to be taken to the packing house. To get the tobacco in a condition to be handled, all of the places for ventilation are left open for one night. The next morning the tobacco will be in what is called ‘good case’; that is, it will have taken up moisture and become soft and pliable. The barn is then tightly closed in order to retain the moisture. The tobacco is taken from the poles and stripped from the stalk or taken from the string, as the case may be, and is packed in bundles that weigh from 35 to 40 pounds and delivered to the packing house as quickly as possible.”—M. L. FLOYD in Report No. 62, U. S. Dept. Agr.

**532. General remarks on curing tobacco.**—The methods of curing are so different in each section that no written directions will alone suffice. Tobacco curing is a matter of local experience. Whatever the method employed, it is

usually advantageous to fill the barn promptly so that all of the tobacco may at the same time reach a similar stage in the curing process. The changes brought about in the curing and subsequent fermentation of tobacco are largely the result of chemical ferments or enzymes.

**533. Further treatment on the farm.** — After curing is completed, tobacco cured on the stalk must be stripped from the stalk, and the leaves tied into bundles, after great pains have been taken to assort them into their different grades, which are usually four or five in number.

Subsequent treatment of tobacco, including several steps in the fermenting of certain types, are usually performed in the factory, and hence are not discussed here.

**534. Yields and prices.**

— A fair yield of cured tobacco in the dark-tobacco district of Virginia is 800 pounds or more per acre. The same figure represents somewhat above the average yield of the bright-tobacco region of North Carolina. In Kentucky a good yield of Burley tobacco is from 1000 to 1500 pounds per acre. In Florida, shade-grown Cuban or Sumatra tobacco is expected to yield between 1200 and 2000 pounds per acre.

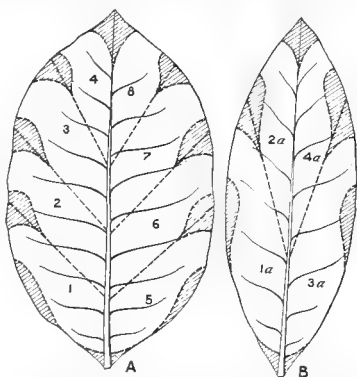

FIG. 221.—DIAGRAM SHOWING THAT BROAD TOBACCO LEAVES AFFORD A MUCH LARGER NUMBER OF WRAPPERS THAN DO NARROW LEAVES.

Prices are highest for the best grades of cigar wrappers, the farmer frequently receiving for such tobacco 40 cents to one dollar or more per pound, and the finished wrappers after proper treatment in the factory selling for several dollars per pound. However, by no means all of the crop of shade-grown tobacco consists of high-grade wrappers.

The coarser and heavier the type or grade of tobacco, the lower, as a rule, is the price. The price of tobacco has fluctuated widely in recent years.

### ENEMIES

**535. Diseases.** — A number of diseases attack the tobacco plant. Among them are wilt and the mosaic disease. Rotation of crops and disinfection of the seed-beds are the most common methods of combating the diseases of tobacco.

**536. Insect enemies.** — Among the insect enemies of this plant are the tobacco worm (Fig. 222), the budworm, cut-worms, and wire-worms. The nematode worm attacks the roots of tobacco plants. The methods of combating this pest, including rotations, are discussed in paragraph 385.

For the Southern tobacco worm (*Protoparce Carolina*) dusting or spraying with Paris green in very dilute form is employed. In addition, the plants must be "wormed" every few days; that is, examined for the purpose of killing any insects and eggs that may be found.

Paris green, diluted with some dry material, is dusted on the buds or young leaves as a means of destroying the budworms.

Cut-worms are combated by the use of poisoned bait placed in the field before the plants are set.

The wire-worm (*Chambus caliginosellus*) is injurious to tobacco plants in the Virginia tobacco fields. It is especially abundant on fields which have recently grown up in weeds. The means of reducing the amount of injury consists in preventing the growth of weeds, especially of the Iron weed (*Vernonia*), in fields where tobacco is soon to be grown. In case this weed is

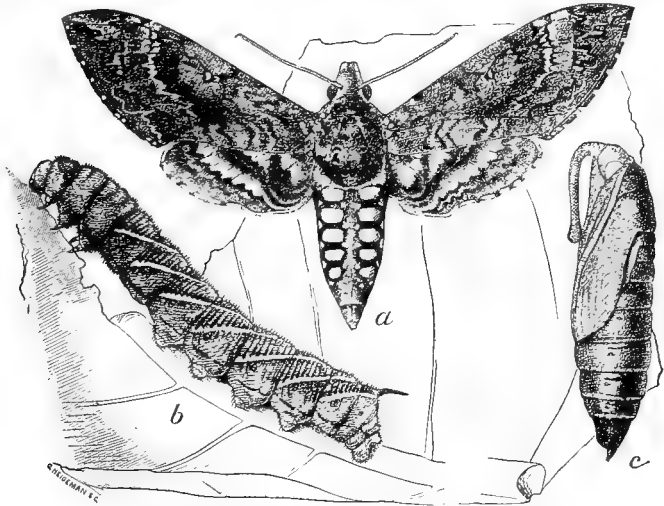

FIG. 222. — SOUTHERN TOBACCO WORM.  
a, adult moth; b, full-grown larva; c, pupa.

present, it is recommended that instead of plowing it under it should be mowed and burned. By setting tobacco very late, this enemy is largely avoided, but the yield of tobacco is reduced.

### LABORATORY EXERCIS S

In high schools located in regions where tobacco is not an important crop, it will usually be advisable to omit this chapter.

The fact that the tobacco plant makes most of its growth

during the period of school vacation renders it difficult to arrange for a comprehensive line of exercises on this plant. However, in regions where this is an important crop, it may be practicable for pupils to prepare and plant a small tobacco bed and to participate in the cultural operations connected with the early growth of the young plants.

Seeds of tobacco should be examined and germinated by planting a definite number of seeds by different methods, some on the surface, some in the shallowest possible furrows, and some in furrows about half an inch deep. From the results students should write conclusions as to the best depth for planting seed.

#### LITERATURE

- KILLEBREW, J. B., and MYRICK, H. *The Tobacco Leaf*. New York.
- KILLEBREW, J. B. *The Culture and Curing of Tobacco in the United States*. Tenth U. S. Census (1880), Agriculture.
- BONDURANT, A. J. *Tobacco*. Ala. Expr. Sta., Bul. No. 64.
- WHITNEY, MILTON. *Tobacco Soils of United States*. U. S. Dept. Agr., Bur. Soils, No. 11.
- FLOYD, M. L. *Cultivation of Cigar-leaf Tobacco in Florida*. U. S. Dept. Agr., Report No. 62.
- McNESS, G. T., and AYRES, L. W. *Experiments in Growing Cuban Seed Tobacco in Texas and Alabama*. U. S. Dept. Agr., Bur. Soils, Buls. Nos. 27 and 37.
- SCHULTE, J. I. *The Work of the Agricultural Experiment Stations on Tobacco*. U. S. Dept. of Agr., Report No. 63.
- McNESS, G. T., and others. *The Improvement of Fire-cured Tobacco*. Va. Expr. Sta., Bul. No. 166.
- DAVIDSON, R. J. [*Chemical Composition of Tobacco*.] Va. Expr. Sta., Buls. Nos. 14, 50, 51.
- CARPENTER, F. B. [*Chemical Composition of Tobacco*.] N. C. Expr. Sta., Buls. Nos. 90 A and 122.
- LEE, J. G. *La. Expr. Sta., Buls. Nos. 20, 25, 33.*
- GARMAN, H., and others. *Ky. Expr. Sta., Buls. Nos. 28, 45, 55, 63, 66, and 129.*



- SCHERFFIUS, W. H., and others. The Cultivation of Tobacco in Kentucky and Tennessee. U. S. Dept. Agr., Farmer's Bul. No. 343.
- HARPER, J. N. Syllabus of Illustrated Lecture on Tobacco Growing. U. S. Dept. Agr., Office Expr. Sta., Farmers' Institute Lecture 9.
- SHAMEL, A. D., and COBEY, W. W. Varieties of Tobacco. U. S. Dept. Agr., Bur. Plant Ind., Buls. Nos. 91 and 96.
- WHITNEY, MILTON. Methods of Curing Tobacco. U. S. Dept. Agr., Farmer's Bul. No. 60.
- LOEW, OSCAR. Curing and Fermentation of Cigar-leaf Tobacco. U. S. Dept. Agr., Report No. 59.
- SHAMEL, A. D. Tobacco. Bailey's Cyclo. Agr., Vol. II, pp 639-653.



## GLOSSARY

- Acid phosphate.** A fertilizer usually containing 12 to 18 per cent of available phosphoric acid; it is made by treating ground rock phosphate with sulfuric acid.
- Alabama *argillacea*.** The scientific name of the cotton caterpillar.
- Aleurone layer.** The thin layer just below the seed-coats and constituting a part of the endosperm of the seed.
- Amides.** Organic compounds rich in nitrogen, but not serving all the uses of certain other forms of protein.
- Analysis.** Statement of chemical composition.
- Andropogon sorghum*.** The scientific name of all the sorghums, including sweet sorghum, kafir, and milo.
- Angoumois moth.** The larvæ of this insect is a serious pest of wheat and corn grain.
- Anthers.** Pollen cases.
- Anthonomus grandis*.** The scientific name of the Mexican cotton boll weevil.
- Aphids.** Small insects, usually called plant lice, injuring young cotton and other plants.
- Arachis hypogea*.** The scientific name of the peanut plant.
- Ash.** Ashes, or the incombustible mineral residue left after burning vegetable or animal matter.
- Auricle.** Clasps, or small projections where leaf-blade and leaf-sheath unite.
- Axil of the leaf.** The angle between the leaf and the stem from which it springs.
- Back-furrowing.** That form of plowing in which successive pairs of furrow slices are thrown toward each other.
- Bacteria.** Minute vegetable organisms, some of which cause certain diseases of plants and animals.
- Bagasse.** The refuse or crushed stalk of sugar-cane or sorghum after the juice is pressed out.
- Bagging.** The common cloth covering around cotton bales.
- Bake.** To form a crust or clod.
- Balk.** A narrow unplowed strip of ground between rows.
- Barring-off.** Throwing the earth away from a line of plants by using a turn-plow.

- Beam. That part of the plow to the front end of which the team is attached.
- Beards. Long, stiff bristles projecting from the hull of certain seeds.
- Bedding. The act of so plowing land as to form considerable ridges, or elevated beds.
- Benders. A commercial term for cotton fiber intermediate in length between short-staple and long-staple lint; so called because it is largely grown on the bottom land in the bends made by rivers.
- Bin. A tight storage place for threshed grain.
- Binder, or self-binder. A machine for cutting and tying grain plants into bundles.
- Blade. See leaf-blade.
- Blissus leucopterus*. The scientific name of the chinch bug of the fields.
- Bluestone. See copper sulfate.
- Boll. The pod within which cotton seed and lint develop.
- Brace-roots. Roots of the corn plant originating at a node above ground. See p. 82.
- Bracts. In the cotton plant the three leaf-like parts that closely inclose the bud, bloom, or boll.
- Branching wheat. See p. 40.
- Bristles. Minute hairs, as at the base of a spikelet of oats.
- Broadcast. Scattered, not sown in drills.
- Budworm. See p. 206.
- Bur (of cotton). The hull of the open boll.
- Butt. The end of the corn ear near the point of attachment.
- Calcium sulfate. A chemical combination of lime and sulfuric acid. Gypsum or land plaster is nearly pure calcium sulfate.
- Calcodermis æneus*. The scientific name of the cowpea-pod weevil.
- Callandra oryza*. The scientific name of the weevil that is most destructive to corn.
- Canthook. A short pole with a hook attached used in handling logs.
- Capillary attraction. The force that causes moisture in the soil to move toward the surface or toward the dryer part of the soil.
- Capped. Covered, as with an extra bundle of grain placed on top of a shock of sheaf-grain.
- Carbon dioxid. Carbonic acid gas; a gas existing in the atmosphere and used by plants. It consists of one part carbon and two parts oxygen.

- Carbon disulfide.** A liquid which readily turns to a vapor that is fatal to insect life.
- Cereal.** Any edible grain.
- Chaff.** The inclosing portion of the wheat flower that is removed from the grain in threshing.
- Cheat.** An annual grass that is a serious weed in fields of wheat and oats.
- Check-rower.** A planter by the use of which corn can be planted in checks. See Fig. 88.
- Chess.** See cheat.
- Chinch bug.** An insect attacking corn, wheat, and other plants; it is entirely unlike the household pest of the same name.
- Chit.** The germ or heart of the grain, as in the corn kernel.
- Chrysalis.** The pupal or changing stage of certain insects.
- Clasps.** See auricles.
- Club wheat.** A class of wheat plants distinguished by the club-shaped head, which is largest at the upper end.
- Cockle.** An annual weed with large pink flowers.
- Colletotrichum gossypii.*** The scientific name of cotton anthracnose, which is the most common form of boll rot.
- Compresses.** Establishments where bales of cotton are again pressed and made denser and smaller.
- Convolvulaceæ.*** The name of the family to which the sweet potato belongs.
- Copper sulfate.** A chemical combination of copper, sulfur, and oxygen useful for destroying the germs of many plant diseases.
- Corn binder or harvester.** See pp. 198 and 199.
- Corn blades.** See p. 99.
- Corn stover.** See p. 99.
- Cotton, absorbent.** Cotton fiber so prepared by chemicals as to be able to absorb much water; absorbent cotton is largely used in medicine and surgery.
- Cotton caterpillar.** A caterpillar formerly very destructive to the leaves of cotton; it was often inaccurately called the army worm.
- Cotton-seed meal.** The meal made from cotton seed after the oil is pressed out.
- Cotton "square."** The young bud of the cotton flower, with its three surroundings leafy bracts.
- Coulter, rolling.** A revolving disk attached to the beam of a plow in order to cut the soil or the vegetation on it. See Fig. 195.
- Cowpeas.** A soil-improving forage plant, often called "peas," or "field peas."
- Crease.** The depression or furrow on one side of a grain of wheat or rye.

- Crossing. Hybridizing, or transferring pollen to the stigmas of a different plant, variety, or species.
- Crown. That part of certain plants, as grains and grasses, from which a number of stems spring.
- Crude fiber. The woody portion of plants.
- Culms. Stems or erect branches.
- Current cross. Immediate hybridization, as shown in the hybrid seeds developed in the same season in which impregnation occurs.
- Cylas formicarius*. The scientific name of the sweet-potato root-borer.
- Delinters. Used on p. 383 for establishments, such as cotton-oil mills, which delint cotton seed, that is, subject them to a second ginning.
- Delta Region. A region in the western part of Mississippi, consisting of rich river bottom land.
- Diabrotica 12-punctata*. The scientific name of the budworm, an insect attacking the stem of very young corn plants.
- Dibble. A small implement or sharpened stick for making holes in the ground.
- Diplodia*. The name of a genus of fungi causing some of the rotting of corn ears.
- Diplosis sorghicola*. The scientific name of the minute insect which destroys the seeds of the sorghums, and which is largely responsible for the failure of the crop of sorghum seed in the humid regions of the South.
- Disinfection. Destruction of the germs of disease, usually by treatment with chemicals or with heat.
- Disked. Tilled with a disk-plow or disk-harrow.
- Disk-harrow. A harrow consisting of a number of circular concave disks.
- Disk-plow. A plow in which the work of cutting and inverting the soil is done by a large, concave, circular disk which revolves. The supporting framework for the disk is shown in Fig. 80.
- Dolichonyx oryzivorus*. The scientific name of the rice bird or bobolink.
- Dominant quality. That one of a pair of contrasted qualities which shows in the larger proportion of the offspring. See p. 143.
- Double fertilization. That process occurring in the impregnation of some plants by which the pollen influences not only the germ of the seed, but also the endosperm.
- Dough stage. The stage of a maturing grain when the seed is in the stage of firmness represented by dough.
- Ducts. The channels through which the crude sap of plants circulates.

- Einkorn.** The German word for "one grain"; the name of one kind of wheat.
- Elementary species.** Groups of similar plants; often subdivisions of what has generally been assumed to be one variety.
- Embryo.** The germ of the seed or grain.
- Embryo-sac.** A part of the ovary which incloses the female germ cell.
- Emmer.** A kind of wheat. See p. 40.
- Endosperm.** The part of the grain or seed around the germ.
- Entomologists.** Persons skilled in the knowledge of insects.
- Environment (of plants).** Surrounding conditions, for example, soil, rainfall, fertilizer, distance between plants.
- Fertilization of corn grain.** The act or fact of union of the male and female elements; the usual result of pollination.
- Fibrous-rooted.** Having numerous fine roots without a tap-root.
- Firing.** The premature drying of leaves on growing plants.
- "Flaxseed."** The name given to the pupal stage of the Hessian fly.
- Floats.** See raw phosphate.
- Floret.** A flower.
- Flush plowing, or flushing.** Plowing land without forming ridges or deep depressions; "broadcast" plowing.
- "Fodder."** A term often applied in the South to corn blades or leaves. See p. 99.
- Forage.** Coarse food for live-stock; forage plants are those that afford pasturage, hay, etc.
- Forceps.** Pincers.
- Formalin.** A liquid consisting of water in which has been dissolved a pungent disinfecting gas, formaldehyde. This liquid readily evaporates, and the fumes destroy germs.
- Friable.** Easily crumbled.
- Fruit limbs or branches.** On the cotton plant those branches on which boll stems are directly borne. See p. 250.
- Fungous.** The adjective derived from *fungus*.
- Fung'us, plural fun'gi.** A class of vegetable organisms having no green coloring matter, and including the rusts, smuts, and most other plant diseases.
- Fusarium.*** The name of a class of fungi, some of which cause a part of the rotting of corn ears.
- Galechia cerealella.*** See grain moths.
- Galled spots.** Areas of soil which have been impoverished by the washing away of the surface soil.
- Garlic, wild.** A small onion growing wild; a troublesome weed.
- Genus.** A group of closely related species of plants.
- Germination.** The act of sprouting, as with seeds.

- Germination-box. A box in which seeds are sprouted to determine the proportion of seeds able to grow. See p. 138.
- Ginnery. The building, including the equipment, in which cotton is ginned.
- Glæosporium manihot.* The scientific name of the fungus causing the "Frenching" disease of cassava.
- Glucose. A non-crystallizable form of sugar.
- Gluten. See p. 39.
- Gossypium.* The scientific name of the genus that includes all kinds of wild and cultivated cotton plants.
- Gossypium arboreum.* The scientific name of a group of cottons largely grown in India.
- Gossypium barbadense.* The scientific name indicating first the genus and next the species of Sea Island cotton.
- Gossypium hirsutum.* The scientific name of the genus and species of American upland short staple and American long staple cotton.
- Gossypium obtusifolium.* The scientific name of one group of cottons grown largely in India.
- Gossypium peruvianum.* The scientific name of a species of cotton supposed to have originated in Peru and largely cultivated in Egypt.
- Grain drills. Implements for sowing grain and other seed in narrow rows.
- Grain moths. Several small moths, the larvæ of which attack wheat, corn, and other grain.
- Gramineæ.* The botanical name of the grass family.
- Granary. A place or bin for storing grain.
- "Green-bug." A small plant-louse injuring grain plants.
- Guano horn. A cheap metal tube with a funnel at the upper end, used in the application of fertilizer by hand.
- Head rice. Prepared rice of the highest grade.
- Heaving. Lifting of plants and soil as the result of freezing of the soil.
- Heliothis obsoleta.* The scientific name of the corn ear-worm and cotton boll-worm.
- Hessian fly. See p. 62.
- Hopper-dozers. Devices to be pulled through fields for catching grasshoppers. An essential feature is a vertical cloth, which the flying grasshoppers strike and thence fall into a large pan containing kerosene, which kills them.
- Hulls, oat. The part of the oat grain which tightly enfolds the kernel.
- Humus. Partly decayed vegetable or animal matter in the soil.



Hybridized. Crossed.

Impregnation. See fertilization.

Internodes. That part of a stem lying between two nodes or joints.

Intertillage. Cultivation among growing plants.

*Ipomœa batatas*. The scientific name of the sweet-potato plant.

Johnson-grass. A perennial grass, difficult to eradicate.

Kernel. In common usage, a grain or seed.

Kiln. A term usually applied to a house or room in which some article is to be dried by artificial heat.

Lady-beetle. See lady-bug.

Lady-bug. A group of small beetles, many of them preying on harmful insects.

Land plaster. An impure form of sulfate of lime. It is sometimes bought as a fertilizer; it is also obtained free as a necessary filler in acid phosphate, about half the weight of which consists of land plaster.

Larva, plural larvæ. The grub or caterpillar stage of any insect; this is the stage in which most insects feed most ravenously and in which they make most of their growth.

Leaching. The dissolving of plant food in the water of the soil and its removal in the water that drains away.

Leaf-blade. The expanded part of a leaf.

Leaf-sheath. See sheath.

Leaf-stem. The stalk, which supports the expanded part of a leaf.

Leaflets. The separate, complete, leaf-like parts that make up what is botanically a leaf of locust, pecan, etc.

Legume. A plant bearing a pod; the legumes in common use in agriculture, such as cowpeas, clovers, etc., are chiefly valuable because the enlargements (tubercles or nodules) on their roots store up nitrogen from the air for the enrichment of the soil. Moreover, most cultivated legumes are valuable forage plants.

Leguminous plants. See legumes.

Lint. The word commonly used to designate the fiber of cotton.

Linters. The very short lint removed from cotton seed subsequent to ginning; the removal of linters is usually done at the cotton oil mills.

*Lissorhoptus simplex*. The scientific name of the water weevil, which injures rice plants.

List. A small ridge formed by throwing two furrow-slices together.

- Lister. A double moldboard plow used in the Southwest for opening a deep furrow in which to plant crops.
- Lock of cotton. The seed and attached lint contained in one division or compartment of a boll of cotton.
- Lubricant. A substance used to oil machinery to reduce friction.
- Macaroni wheat. A class of hard or durum wheats, from which is manufactured the human food macaroni.
- Maize. Another name for corn.
- Malvaceæ*. The scientific name of the Mallow family, which includes cotton, okra, etc.
- Manihot utilissima*. The scientific name of the cassava plant.
- Mating area. A tract of land on which two or more valuable strains, as of corn, are planted in adjacent rows for the purpose of effecting cross-pollination.
- Maturity. Ripeness.
- Melilotus alba*. See sweet clover.
- Mendel's law. A principle discovered by Mendel, which explains the mathematical proportions in which certain qualities are inherited by hybrid plants or animals.
- Middle burster. A plow with both a right-hand and a left-hand moldboard, thus at the same time throwing the soil both to right and left.
- Middling. A certain commercial grade of cotton.
- Midge. A particular insect of small size. For the sorghum midge, see p. 233.
- Milk stage. The stage of ripeness of a grain in which the contents of the seed are of the consistency and color of milk.
- Mower. A mowing machine.
- Mulch. A covering, usually of loose soil or litter.
- Multiplication plot. An area of some crop grown chiefly with a view to increasing the amount of good seed for planting, without special reference to improvement in the quality of the seed. See p. 135.
- Muriate of potash. A salt-like fertilizer containing about 50 per cent of potash.
- Nematode worms. Minute worms which enter the roots of certain plants and cause harmful enlargements.
- Neocosmospora vasinfecta*. The scientific name of cotton wilt or black root.
- Nitrate of soda. A combination of sodium and nitric acid, forming a soluble and prompt fertilizer, containing 14 to 16 per cent of nitrogen.
- Nitrogen. A chemical element, which in certain combinations is

- an important fertilizing material and in other forms a valuable part of the food of men and lower animals.
- Nitrogen-free extract. In plants nutritive compounds containing no nitrogen and consisting chiefly of starch, sugar, etc.
- Noctuidæ*. The scientific name of one group of cut-worms.
- Node. A joint on a stem where a leaf is usually borne.
- Oryza sativa*. The scientific name of the rice plant; the first word is the name of the genus, and the second is the name of the species.
- Oxygen. A gas existing in the atmosphere and required in some form by all forms of life. Oxygen also exists in combination with numerous other elements, forming gases, liquids, and solids.
- Panicle. A branching seed-head, as of oats.
- Papilionaceæ*. The name of the family to which peanuts, clovers, and most other cultivated legumes belong.
- Parasite. An animal (or vegetable) organism which lives on and obtains nourishment from the body of another.
- Peduncle. In the cotton plant, the stem supporting the square, bloom, or boll.
- Peppergrass. An annual weed of the Mustard family, seeding about the same time as wheat.
- Phosphatic. Containing a large proportion of phosphorus or phosphoric acid.
- Phosphoric acid. The chemical compound of the elements phosphorus and oxygen that makes acid phosphate a valuable fertilizer.
- Piedmont section. The elevated country at the eastern base of the Appalachian Mountains.
- Pine needles. Pine leaves.
- Pistil. The central portion of a flower at the base of which seed may develop.
- Polish wheat. See p. 41.
- Pollen. The male element in the fertilization of a flower; usually dustlike or in the form of minute particles.
- Pollen tube. A slender outgrowth from the pollen grain after the latter finds lodgment on a receptive stigma.
- Pollination. The act or fact of conveying pollen to the receptive stigma.
- Pores. Openings.
- Potash. The compound of the chemical elements potassium and oxygen that makes kainit a valuable fertilizer.
- Pouland wheat. See p. 40.
- Protein. Certain compounds rich in nitrogen, found in plants and animals.

- Pupa, plural pupæ. See pupal stage.
- Pupal stage. That stage in the life of most insects which follows the larval or "caterpillar" or "grub" stage and which immediately precedes the stage of the mature insect. The pupal stage is not usually a period of growth, but of inactivity and of change of form.
- Quarter drains. Shallow cross-drains in a field of sugar-cane.
- Rachis. The portion of the stem on which flowers and seeds are borne.
- Raw phosphate. See p. 330.
- Recessive quality. That one of a pair of contrasting qualities that appears in the smaller proportion in the hybrid offspring.
- Red clover. Commonly called clover; a biennial forage plant with roundish, pinkish flower heads.
- Rhizoctonia*. The scientific name of the damping-off or sore-shin disease of young cotton plants.
- Rice bran. See p. 220.
- Rice polish. See p. 220.
- Rice weevil. Though named for the rice plant, this weevil does most injury to stored corn.
- Rick. A long stack.
- Ridging. See bedding.
- Rivers. See benders.
- Rotation of crops. The succession of crops that follow each other on the same field in regular order.
- Rust. Diseases of certain plants due to the presence of definite, minute, vegetable organisms.
- Score-card. A numerical standard of excellence.
- Screening. Separating by means of sieves.
- Sea Island cotton. The plant that produces the longest, finest cotton fiber; its name is taken from the fact that this species of cotton is grown chiefly on islands along the South Atlantic seacoast.
- Self-pollination. Conveyance of pollen to the pistil of the same plant. Oats and wheat are self-pollinated.
- Shank. In the corn plant, the support for the ear.
- Shatter. To drop the grains prematurely.
- Sheaf oats. Oat-plants not threshed, including grain and straw.
- Sheath. The lower or stem-encircling part of the leaves of grass-like plants.
- Shock. A collection of bundles of grain plants leaning together; a small pile of hay.
- Shocker. See p. 198.
- Shovel. A shovel plow is intermediate in width and shape be-

tween a scooter and a sweep. It is used to open a trench or furrow and is attached to the foot of a plow-stock.

Shredder. A machine for tearing into small pieces the coarse stems and other parts of corn stalks and other forms of coarse forage. See Fig. 98.

Shucks. Corn shucks, the leaf-like parts inclosing the ear.

Sieve-tubes. Plant structures for the circulation of sap.

Silo. See p. 99.

Single-tree. The short wooden bar to which the traces of each horse or mule are hitched.

Slips. The slips of the sweet potato are also called "sets" and "draws." They consist of the young shoots growing out of the potato that is bedded. See Fig. 191.

Small grains. A term applied collectively to wheat, oats, rye, and barley in distinction from the larger grain, corn.

Smut. A disease of certain plants due to the growth of certain minute vegetable organisms.

*Sorghum vulgare*. The scientific name which is used by some authorities to include all the sorghums.

Species. A group of plants having certain qualities in common.

Spelt. See p. 40.

*Sphacelotheca sorghi*. The scientific name of the fungus causing the kernel smut of the sorghums. See p. 233.

*Sphaeronema fimbriatum*. The scientific name of the organism causing the black-rot of sweet potatoes; until recently the first part of the name was usually written as *Ceratocystis*.

Spikelets. A small cluster of flowers or seeds.

Spores. Minute bodies which serve the purpose of seed for the fungi, that cause most plant diseases.

Stamens. Anthers or pollen cases together with their supports.

Sterility. In plants, failure to produce a normal number of seed.

Stigma. The upper part of the pistil on which pollen must lodge and grow to effect fertilization of the flower.

Stomata. Minute openings in the outer layer of plant tissue, especially on the under sides of leaves, through which openings the leaf gives off moisture and takes in carbon dioxide gas and oxygen.

Strains. Subdivisions of a variety.

Subsoil plow. A plow for loosening without inverting the soil. See Fig. 78.

Subsoiling. See p. 163.

Subspecies. A division of a species.

Suckers. In the corn plant, stems springing from some of the lower nodes of the main stem.

Sucrose. Crystallizable sugar.

- Sulfate of potash. A fertilizer containing 37 to 50 per cent of potash.
- Sweet clover. *Melilotus alba*; a biennial, summer-growing legume valuable for soil improvement, pasturage, and hay for home use.
- Tap-root. The main central root of such plants as cotton.
- Tare (in cotton). The allowance for weight of the covering, or bagging and ties, on a cotton bale; in practice it is usually 24 pounds or less in American markets.
- Tassel. The panicle of male flowers borne at the top of a flowering corn plant.
- Teosinte. A tropical forage plant closely related to corn.
- Tetranychus gloveri*. The scientific name of the red spider, a small mite that attacks cotton leaves.
- Threshing. The act of separating the grain of wheat, oats, etc., from the straw and chaff.
- Throw-board. See Fig. 92 and p. 191.
- Tillage. Cultivation.
- Tiller. To branch from the crown; to stool.
- Tilletia horrida*. The scientific name of the fungus causing black smut in rice.
- Tip. The end of a corn ear farthest from the point of attachment.
- Toxic. Poisonous.
- Toxoptera graminum*. The "green bug," a plant-louse injuring grain plants.
- Transpiration. The loss of water from plants by its passing into the air from the leaves, etc.
- Triticum*. The name of the genus to which wheat belongs.
- Turn-plow. The kind of plow most generally used for turning over the soil. It includes a concave moldboard for twisting, pulverizing, and inverting the furrow-slice.
- Ustilago maydis*. The scientific name of the fungus causing corn smut.
- Variety. A subdivision of a species; a group of individual plants possessing in common certain botanical or agricultural characteristics.
- Vegetable matter. Material now or recently existing in the form of plant tissue.
- Vegetative branches or limbs. On the cotton plant, those branches on which no boll stems are directly attached (see p. 250); common equivalent terms are "base limbs" and "suckers."

- Vermicelli. A form of macaroni, manufactured from wheat.
- Vetch, hairy. A winter-growing, annual, leguminous plant, suitable for soil improvement, pasturage, and hay.
- Vine cuttings. Sections of vines cut off and planted, as with sweet potatoes.
- Vitality. In seed, ability to sprout and to produce strong young plants.
- Vs., versus. Against, or in comparison with.
- Water furrows. The depressions or shallow trenches between two elevated beds of soil.
- Weeder. A form of light harrow, with long, flexible teeth. See Fig. 86.
- Whorls. Sets or groups.
- Wild onion. See garlic.
- Windrows. In sugar-cane culture this applies to the rows of heaped and covered cane intended for planting.
- Winter-killing. The dying of young plants from cold or heaving.
- Zea mays*. The scientific name of Indian corn.





# INDEX

[Numbers refer to pages.]

- Acid phosphate, how prepared, 330.  
*Alabama argillacea*, 408.  
Alabama Canebrake Experiment Station, 294.  
Alabama Experiment Station, 12, 18, 31, 119, 126, 145, 157, 161, 178, 187, 188, 205, 266, 270, 273, 293, 299, 313, 325, 326, 333, 339, 406, 522, 546.  
Alabama, productive varieties of corn in, 119.  
Alabama, productive varieties of cotton in, 293.  
Albino corn plants, 140.  
Alfalfa, root-rot on, 414.  
Allard, H. J., 266.  
Allison method of cotton and corn culture, 180.  
American Breeders' Association, 31, 145, 314.  
Anderson, A. P., 230.  
*Andropogon sorghum*, 231.  
Anthracnose of cotton, 415.  
*Anthonomus grandis*, 392.  
*Arachis hypogea*, 464.  
Arkansas Experiment Station, 119, 230, 247, 469, 483.  
Arkansas, productive varieties of corn in, 119.  
Atkinson, G. F., 420.  
Auricles of oats, 2.  
Austin, A., 230.  
Ayles, L. W., 546.  
Bailey's Cyclopaedia of American Agriculture, 67, 77, 97, 135, 149, 247, 266, 360, 420, 424, 456, 483, 521, 547.  
Ball, C. R., 246, 247.  
Barley, 74.  
    beardless, 76.  
    clasps, 75.  
    composition, 75.  
    description, 74.  
    enemies, 77.  
    fertilizers for, 76.  
    laboratory exercises, 77.  
    literature, 77.  
    smut, 77.  
    soils for, 76.  
    sowing, 76.  
    species and varieties, 75.  
    uses of, 74.  
Batts, J. F., yield of corn, 204.  
Beal, H. W., 230.  
Beattie, R. W., 483.  
Bennett, R. L., 314.  
Bessey, C. E., 67.  
Bishop, F. C., 216.  
Blackstrap, definition of, 513.  
*Blissus leucopterus*, 211.  
Blue stem wheat, 41.  
Bluestone, 61.  
Bobolinks, 229.  
Bondurant, A. J., 546.  
Bowman, M. L., 205, 216.  
Boyce, 424.  
Boykin, E. B., 266, 314.  
Branching wheat, 40.  
Breeding of cotton, 300.  
    of corn, 127.  
Broom-corn, 241.  
    climate, soils, and fertilizers, 242.  
    culture, 243.  
    description, 241.  
    enemies, 245.

- Broom-corn (*continued*)  
 harvesting and preparation for marketing, 244.  
 standard and dwarf, 242.  
 statistics and yield, 241.  
 varieties, 242.
- Budworms of corn, 206.
- Burkett, C. W., 360, 376, 387.
- Burnette, H. F., 456.
- Callandra oryza*, 211.
- Calvin, M. V., 340.
- Canada Experiment Farms, 20.
- Cannabis sativa*, 422.
- Carbon disulfide, 64, 202, 212.
- Carleton, M. A., 65.
- Carpenter, F. B., 547.
- Cassava, 457.  
 climate and distribution, 458.  
 cultural methods, 459.  
 enemies, 461.  
 fertilizers for, 459.  
 "frenching," 461.  
 harvesting, 460.  
 kinds, 457.  
 laboratory exercises, 462.  
 literature, 462.  
 poisonous constituent in, 458.  
 propagation, 460.  
 soils for, 459.  
 storing "seed canes," 461.  
 uses and composition, 458.
- Cercospora personata*, 483.
- Census, U. S. Bureau of, 287, 341.
- Chalcodermis æneus*, 408.
- Cheat, 59.
- Check-rower, 166.
- Chemistry, U. S. Bureau of, 462.
- Chess, 59.
- Chinch bugs, 63, 211.
- Close breeding in corn, 140.
- Clover, crimson, in rotation, 47.  
 red, in rotation, 47.
- Club wheat, 41.
- Cobb, N. A., 521.
- Cobey, W. W., 548.
- Coburn, F. D., 205, 246.
- Cockle, 60.
- Colletotrichum gossypii*, 415.
- Composts, 335.
- Connecticut State Experiment Station, 136, 143, 149.
- Conner, A. B., 246.
- Convolvulaceæ*, 425.
- Copper sulfate, 61.
- Corn, accidental *versus* inherited excellence, 131.
- Corn, albino plants, 141.  
 Allison method of culture, 180.  
 Angoumois moth in, 213.  
 barren stalks, 130.  
 binder or harvester, 198, 199.  
 blades, 99.  
 brace-roots, 82.  
 breeding, 127.  
 breeding for composition, 136.  
 breeding, laboratory exercises, 148.  
 breeding, literature of, 149.  
 breeding, systems of numbering, 136.  
 budworms, 206.  
 butts, 108.  
 characters needed, 114.  
 checking, 175.  
 cob, color of, 104.  
 color of grain, 94, 117, 141-144.  
 comparative yields of breeding rows, 132.  
 composition, 98.  
 composition influences shape, 137.  
 composition, laboratory exercises, 110.  
 composition, of grains from tip, middle, and butt, 146.  
 composition, varied by selection, 136.  
 cowpeas with, 181.  
 cribs, 201.  
 crossing *versus* selection, 139.  
 "crossed," 180.  
 cultivation of, 158.

Corn (*continued*)

- cultivation, laboratory exercises in, 188.
- cultivation, literature of, 188.
- cutting and shocking, 192.
- cutworms attacking, 207.
- dates of planting, 168.
- definition of, 78.
- dent, 113.
- depth of planting, 167.
- depth of plowing for, 162.
- distance between plants, 178.
- dominant and recessive qualities, 143.
- draft on fertility, 100.
- ear, 91.
- ear-branch, 84.
- ear, length and circumference, 109.
- ear, proportion of grain, 109.
- ear, rots, 215.
- ear, shank, 116.
- ear, shape influenced by composition, 137.
- ear, space between rows, 108.
- ear-to-row system of breeding, 133.
- ear-worm, 208, 209, 210.
- early varieties, 125.
- effect of change of climate on, 147.
- effects of cross-breeding, 14.
- effects of in-breeding, 140.
- enemies, 206.
- enemies, laboratory exercises, 215.
- enemies, literature of, 216.
- fertilizers for, 153, 187.
- fertilizer formulas for, 154.
- fertilizer, time to apply, 155.
- fertilizing, laboratory exercises, 147.
- fertilizing, with legumes, 154.
- fertilizing, literature of, 157.
- fertilization of the flower, 90.
- flint, 113.
- "fodder," 99.

Corn (*continued*)

- fungous diseases, 214.
- germination, test of, 138.
- grading seed grains, 147.
- grain, color in, 94.
- grain, composition, 93.
- grain, cross-section of, 93.
- grain, shapes of, 109.
- grain, structure of, 92.
- handling the ears, 189.
- hardness of grain, 114, 117.
- harrowing, 170.
- harvesting, 189.
- harvesting, laboratory exercises, 204.
- harvesting, literature of, 205.
- height of ear, 129.
- hereditary qualities, 129.
- implements for, 164.
- improvement of varieties, 127.
- Indian meal moth in, 213.
- in a 3-year rotation, 152.
- in a 4-year rotation, 153.
- inheritance of color, 144, 145.
- inheritance of flint or dent structure, 143.
- insects, 206.
- judging, 98, 101.
- judging, laboratory exercises, 102.
- judging, literature, 111.
- kernel, 92.
- kernels, best shape, 109.
- large-eared varieties, 122.
- "laying by," 179.
- leaves, 83.
- leaves, curling, 84.
- structure, laboratory exercises, 97.
- level preparation and planting, 161.
- literature, 97.
- maturity, 114.
- means of improvement, 128.
- Mendel's law applied to, 143.
- methods of applying fertilizers, 156.

Corn (*continued*)

- methods of cutting, 194.
- Mexican Junc, 125.
- modified ridging system, 160, 162.
- number of ears per plant, 86.
- number of plants per hill, 177.
- other crops with, 179.
- place in rotation, 152.
- planting, 166.
- planting in water-furrow, 161.
- pod, 114.
- pop, 113, 114.
- pop corn crossed with dent, 127.
- position of ears, 86, 87, 116.
- productive varieties of corn, 120.
- products, 100.
- prolific varieties, 122.
- proportion of parts, 99.
- "pulling fodder," 191.
- pulling the ears, 189.
- qualities accompanying high yields, 116.
- qualities needing improvement, 116.
- quantity of fertilizer, 157.
- races and varieties, 112.
- rat-proof cribs, 201.
- relationships between corn plants, 139.
- remnants of breeding ears, 135.
- removal of tip grains, 146.
- replanting, 169.
- ridging *versus* flushing land, 159.
- roots, 79, 80, 81.
- rotations for, 150.
- rotation, literature of, 157.
- saving by shocking, 192.
- score-card for, 101.
- seed from tip, middle, and butt, 145.
- selecting and crossing, 128.
- selecting according to composition, 138.
- selection in field or crib, 130.
- shanks, length of, 130.
- shape of ear, 105.

Corn (*continued*)

- shapes of grain, 92, 117.
  - shocker, 198.
  - shocking horse for, 194.
  - shredding, 200.
  - shucks, 84, 116.
  - silks, 88.
  - simple selection, 131.
  - size of ears for planting, 130.
  - sled cutter, 197.
  - smut, 214.
  - soft, 113, 114.
  - soils for, 150.
  - space between kernels near cob, 169.
  - stem, 82.
  - stover, 99, 193.
  - stripping the blades, 191.
  - subsoiling for, 163.
  - sweet, 113, 114.
  - tassel, 86.
  - thickness of planting, 176.
  - thinning, 177.
  - time of plowing, 159.
  - tips, 108.
  - top and bottom ears, 144.
  - topping, 192.
  - trueness to type, 109.
  - two-horse cultivators for, 174.
  - uses of, 78.
  - varieties, 116.
  - varieties, illustrations of, 124.
  - varieties, laboratory exercises, 125.
  - varieties, literature of, 126.
  - varieties, yields of, 118.
  - vitality, 104.
  - weevil-resistance, 114, 115.
  - weevils in, 202, 211.
  - Williamson method of culture, 185.
  - yellow varieties, 122.
  - yields, 204.
- Cotton, absorbent, 263.
- Allen Long-staple variety, 299.
- angular leaf-spot, 418.

Cotton (*continued*)

- annual crop of Egypt, 384.
- annual crop of India, 384.
- antagonistic qualities, 307.
- anthracnose, 415.
- Asiatic, 281.
- bacterial blight, 419.
- bagging, 369.
- bale, round, 369.
- bales, tare on, 369.
- baling, 367.
- bark and stems, 254.
- barring off, 352.
- belt, extent of, 383.
- "benders," 277.
- Bengal, 276.
- big-boll group, 288.
- Blue Ribbon variety, 291.
- boll-rot, 415.
- bolts, 257.
- boll-stems or peduncles, 255.
- boll-weevil, 392.
- boll-weevil, burning stalks against, 398.
- boll-weevil, extent of injury, 392.
- boll-weevil, food of, 393.
- boll-weevil, grazing stalks against, 398.
- boll-weevil, illustrations of, 171, 172, 173.
- boll-weevil, insect enemies of, 404.
- boll-weevil, minor methods of combating, 400.
- boll-weevil, map of region invaded by, 403.
- boll-weevil, nature of injury by, 395.
- boll-weevil, picking squares for, 404.
- boll-weevil, poisoning, 400.
- boll-weevil, principal preventive measures, 398.
- boll-weevil, rapid multiplication, 396.
- boll-weevil, rate of spread, 402.
- boll-weevil, stages of, 395.

Cotton (*continued*)

- boll-weevil, widening rows against, 401.
- boll-weevil, winter quarters of, 397.
- boll-worm, 210, 388.
- boll-worm, preventive measures, 390.
- breeding, 300.
- breeding, for a small number of qualities, 308.
- breeding, laboratory exercises, 313.
- breeding, literature, 314.
- burning of stalks, 397.
- burs, plant food in, 272.
- care of baled, 370.
- caterpillar, 404.
- causes of scant profits, 320.
- chopping, 354.
- classification of varieties, 283.
- classing, 372.
- cleaning middles, 355.
- Cleveland variety, 298.
- cluster group of, 283.
- color of lint, 374.
- commercial grades, 372.
- commercial grades, value of, 375.
- competition by foreign countries, 385.
- competition, means of meeting, 387.
- composition, 267.
- composition, laboratory exercises, 273.
- composition, literature, 273.
- composts for, 335.
- compresses, 371.
- Cooke Improved variety, 298.
- crop, statistics of, 379.
- crossing of American and Asiatic species, 276.
- crossing *versus* selection, 301.
- cultivation, 341, 351.
- cultivation, laboratory exercises, 360.

Cotton (*continued*)

- cultivation, literature, 360.
- culture in presence of the boll-weevil, 405.
- culture in U. S., 379.
- culture in U. S., distribution of, 383.
- defects in bolls, 306.
- depth of cultivation, 357.
- depth of plowing for, 343.
- description of varieties, 296.
- directions for crossing, 302.
- distance experiments, 359.
- distribution of fertilizer, 347.
- draft on fertility, 315.
- early King-like group, 288.
- easy deterioration of varieties, 300.
- effects of raw and acid phosphate, 330.
- Egyptian, 280.
- family and genus, 274.
- fertilizers, 309.
- fertilizers, advantages of home mixing, 321.
- fertilizers, amounts per acre, 324.
- fertilizers, amounts of crop increase from, 322.
- fertilizers, factory-mixed, 320.
- fertilizers, laboratory exercises, 340.
- fertilizers, profits from, 323.
- fiber, breaking strength, 263.
- fibers of several varieties, 292.
- fiber, size, 263.
- fiber, uses of, 272.
- flowers, 256.
- flowers, time required for development, 265.
- forming beds for, 345.
- frequency of cultivation, 356.
- fruit, stages in life of, 265.
- fruiting branches, 250.
- gin, 370, 379.
- gin, roller, 370.
- gin, saw, 370.

Cotton (*continued*)

- ginning, 366.
- ginning, Long Staple, 370.
- ginning, Sea Island, 369.
- glands, 257.
- grade, how determined, 374.
- ground phosphate rock for, 329.
- harvesting and marketing, 361.
- harvesting, laboratory exercises, 376.
- harvesting, literature, 376.
- hastening maturity against boll-weevil, 400.
- Hawkins variety, 296.
- history and statistics in America, 377.
- hoeing, 356.
- immature fibers, 262.
- implements used in cultivation of, 354.
- improvement profitable, 301.
- Indian, 258, 276.
- indications of need of nitrogen, 319.
- insect enemies, 388.
- Jackson, 296.
- King variety, 297.
- late cultivation, 356.
- Layton variety, 297.
- leaf-worm, 404.
- leaves, 255.
- leaves, weight of, 271.
- lime for, 335.
- lint, 262.
- lint, composition of, 267.
- lint, effect of storage on, 263.
- lint, plant food in, 271.
- lint, proportion of plant, 271.
- linters, 383.
- list of leading varieties, 293.
- literature, 339.
- locks, 257.
- long-limbed group, 290.
- long-staple upland, 290.
- maturity affected by fertilizers, 327.

Cotton (*continued*)

- maturity or earliness, 254.
- methods of plowing for, 342.
- methods of separating large seeds, 313.
- mildew, 418.
- minor leaf diseases, 418.
- nitrogenous fertilizers, 325.
- no indications revealing the need for phosphorus, 318.
- not fertilized according to composition, 317.
- pasting the seed of, 348.
- Peruvian, 280.
- petals and sepals, 257.
- Peterkin variety, 296.
- picker, Dixie, 365.
- picker, Lowry, 365.
- picker, Oliver, 366.
- picker, Price-Campbell, 366.
- picker, Thurman Vacuum, 366.
- pickers, mechanical, 361.
- pistil, 257.
- plant breeder's methods of improving, 309.
- plant, composition of parts of, 270.
- plant food in, 271.
- plant, habit of, 274.
- plant in budding stage, 401.
- plant-to-row method of breeding, 310.
- planters, 348.
- plants, weight of stems, leaves, etc., 271.
- pollen, 256.
- pollination of, 256.
- principal qualities desired in plant, 305.
- principal species, 274, 275.
- principal uses, 267.
- producing countries, 384.
- productiveness of varieties, 291.
- quality affected by fertilizers, 338.
- qualities needing improvement, 307.

Cotton (*continued*)

- reasons for variation, 282.
- Rio Grande group, 287.
- rivers, 277.
- roots, 254.
- roots, plant food in, 271.
- roots, weight of, 271.
- root-knot, 414.
- root-rot, 414, 415.
- Russell variety, 297.
- rust, checked by potash, 333.
- score-card for, 313.
- Sea Island, 276, 279.
- seed, 264.
- seed as fertilizer, 325.
- seed, composition of, 268.
- seed, effects on hogs, 272.
- seed, effects on young calves, 273.
- seed, germination of, 264.
- seeding, 381.
- seed, number per bushel, 349.
- seed meal, poisonous effects of, 272.
- seed meal *versus* manure, 328.
- seed meal, sometimes unprofitable, 328.
- seed patch, 306.
- seed, plant food in, 271.
- seed products, 270.
- seed, production and uses of, 381.
- seed, proportion of fiber, hulls, and meats in, 264.
- seed, proportion to entire plant, 271.
- seed, rolling, 349.
- seed, time to apply as fertilizer, 327.
- seed, uses of, 272.
- seed *versus* cotton-seed meal as fertilizer, 269, 326.
- semiclusture group, 285.
- size of seed for planting, 312.
- soils, 315.
- sowing seed in, 357.
- species, American group, 276.
- species, Asiatic group, 276.

- Cotton (*continued*)  
 species, laboratory exercises, 281.  
 species, literature, 281.  
 stalk cutter, 399.  
 stalks, loss in burning, 406.  
 statistics, laboratory exercises, 387.  
 stems and branches, 248.  
 stems, plant food in, 271.  
 stems, weight of, 271.  
 "storm resistance," 261.  
 structure and general characteristics, 248.  
 structure, laboratory exercises, 265.  
 structure, literature, 266.  
 subsoiling for, 344.  
 tillage by weeder and harrow, 350.  
 time of planting, 347.  
 time of plowing for, 342.  
 tinges and stains, 374.  
 Toole variety, 296, 297.  
 Triumph variety, 298.  
 Truitt variety, 298.  
 twist in fibers, 262.  
 upland species, 276.  
 variation and selection, 303.  
 varieties, 282.  
 varieties, laboratory exercises, 299.  
 varieties, literature, 299.  
 vegetative branches, 249, 250.  
 where potash is needed, 318.  
 wilt, description of, 412.  
 wilt, persistence of, 413.  
 wilt-resistant varieties, 414.  
 wilt, spread of, 412.  
 wilt, treatment of, 413.  
 young plants of, 353.
- Cowpeas, in corn, 181.  
 drilling *versus* broadcast sowing, 181.  
 fertilizer for, 184.  
 methods of drilling, 184.  
 methods of sowing broadcast, 183.
- Cross-breeding, effects of, in corn, 141.  
 in corn, 140.  
 "Crossed corn." See page 180.  
 Crossing *versus* selection in cotton, 301.  
 Crossley, B. W., 205, 216.  
 Current cross, 127.  
 Cutworms, 207.  
*Cylas formicarius*, 452.
- Davenport, E., 149.  
 Davidson, R. J., 547.  
 Doney, L. H., 281, 424.  
*Diabrotica 12-punctata*, 206.  
*Diatrea saccharalis*, 520.  
*Dioscorea*, 431.  
*Diplodia*, 215.  
*Diplosis sorghicola*, 233.  
 Disk-harrow, 16.  
 for forming beds, 347.  
 Dodlinger, P. T., 67.  
 Dodson, W. R., 157, 230, 247.  
*Dolichonyx oryzivorus*, 229.  
 Dominance of qualities in hybrids, 143.  
 Double fertilization, 90.  
 in corn, 142.  
 Drake, Z. J., yield of corn, 204.  
 Drilling *versus* broadcast sowing of wheat, 54.  
 Duggar, B. M., 456.  
 Duggar, J. F., 31, 126, 157, 188, 205, 299, 340, 360, 455.
- Earle, D. E., 376.  
 Earle, F. S., 521.  
 Ear-to-row system of corn breeding, 133.  
 East, E. M., 143, 149.  
 Einkorn, 40.  
 Elliott, E. E., 67.  
 Embryo-sac, 90.  
 Emmer, 40.  
 Endosperm, 90.



- Entomology, Georgia State Board of, 52.
- Entomology, U. S. Bureau of, 31.
- Evans, W. E., 281.
- Experiment Station, U. S. Office of, 117, 126, 205, 273, 281, 287, 340, 360, 376, 547.
- Fertilizers, advantages of high grade, 323.  
 advantages of home mixing, 321.  
 distribution of, 347.  
 effects of, on soil, 320.  
 for corn, 153.  
 for cotton, 315.  
 nitrogenous, 325.  
 time of application to corn, 154.
- Fitz, James, 455.
- Floats, 330.
- Florida Experiment Station, 459, 462, 522.
- Floyd, M. L., 546.
- Freeman, C. F., 246.
- Freeman, E. M., 246.
- Frost, date of first killing, 52.
- Fulcaster wheat, 42, 43.
- Fultz wheat, 42, 43.
- Furman compost formula, 336.
- Fusarium*, 215.
- Galechia cerealella*, 64.
- Gammie, G. O., 276, 281.
- Garlic, wild, 60.
- Garman, H., 547.
- Georgia Experiment Station, 18, 31, 99, 120, 145, 154, 178, 187, 192, 205, 294, 324, 333, 340, 360.
- Georgia, productive varieties of corn in, 120.  
 productive varieties of cotton in, 393.
- Germination box, 138.
- Glæosporium manihot*, 461.
- Gossypium*, *arboreum*, 276.  
*barbadense*, 276.  
*hirsutum*, 276.
- Gossypium* (continued)  
*obtusifolium*, 276.  
*peruvianum*, 276.
- Grain drill, 17.
- Grain-moths, 64.
- Gramineæ, 1, 68.
- Grasshoppers, 209.
- "Green-bug," 25.
- Guano horn, 347.
- Hammond, H., 360, 376.
- Handy, R. B., 483.
- Harper, J. N., 299, 340, 547.
- Harrow, spike-tooth, 171.  
 use in cultivating cotton, 350.
- Harshberger, J. W., 98.
- Hartley, C. P., 130, 145, 146, 247.
- Hays, W. M., 67, 205.
- Heaving, 19.
- Heliothis obsoleta*, 210.
- Hemp, 422.  
 cultural methods, 423.  
 fertilizer for, 423.  
 harvesting, 423.  
 laboratory exercises, 424.  
 literature, 424.  
 soils, 423.
- Hessian fly, 62.
- Heterodera radicolica*, 411.
- Hinds, W. E., 63, 203, 211, 212, 213, 214, 393.
- Hinds chain cultivator, 402.
- Hopkins, C. G., 5, 97, 136.
- "Hopper-dozer," 209.
- Hunt, T. F., 4, 67, 97, 247, 376.
- Hunter, S. J., 25, 31.
- Hutchinson, W. L., 273.
- Illinois Experiment Station, 129, 136, 215, 216.
- In-breeding, 139.
- Indiana Experiment Station, 111.
- Insect pests of oats, 25.
- Iowa Experiment Station, 111.
- Ipomæa batatas*, 425.

- Johnson-grass seed, 21.
- Kafir, Black-hulled White, 238, 239.  
 composition of grain and stover, 232.  
 description and uses, 239.  
 harvesting, 240.  
 Red, 234.  
 soils and planting, 240.
- Kansas A. & M. College, 66.
- Kansas Board of Agriculture, 205, 247.
- Kansas Experiment Station, 20, 31, 246.
- Kentucky Experiment Station, 546.
- Kilgore, B. W., 67, 126, 273.
- Killebrew, J. B., 546.
- Kimbrough, J. M., 340.
- Knapp, S. A., 221, 228, 230.
- Lady-bug, beneficial, 25.
- Laphygma frugiperda*, 521.
- Legumes a cheap source of nitrogen, 154.
- Leidigh, A. H., 246.
- Lime, 335.  
 for wheat, 45.
- Lissorhoptrus simplex*, 229.
- Litter, disposal of, 341.
- Lloyd, F. E., 90.
- Louisiana Crop Pest Commission, 399.
- Louisiana Experiment Station, 120, 157, 219, 230, 247, 294, 521, 546.
- Louisiana, productive varieties of corn in, 120.  
 productive varieties of cotton in, 393.
- Lyon, T. L., 31, 67, 111.
- Macaroni wheat, 40.
- Mallow family, 274.
- Malvaceæ*, 274.
- Manihot utilissima*, 457.
- Manure, increase in cotton from use of, 325.
- Marisnius sacchari*, 520.
- McBryde, J. B., 270, 273, 340, 360.
- McDonnell, C. C., 219, 230.
- McNess, G. T., 546.
- McNider, G. M., 360.
- McQuarrie, C. K., 522.
- Mell, P. H., 266.
- Mendel's law in corn, practical results of, 145.
- Mercier, W. B., 360.
- Metcalf, H., 230.
- Mexican cotton boll-worm, 392.
- Middle burster, 346.
- Miller, T. S., 376.
- Milo, 240.
- Milo compared with Kafir, 241.  
 composition of grain, 231.
- Milo maize, 240.
- Minnesota Experiment Station, 205.
- Mississippi Experiment Station, 111, 120, 273, 294.
- Mississippi, productive varieties of corn in, 120.  
 productive varieties of cotton in, 393.
- Molasses, defined, 513.
- Montgomery & Lyon, 31, 67, 111.
- Moraceæ*, 422.
- Morgan, H. A., 456.
- Moore, C. C., 462.
- Moorehouse, L. A., 205.
- Myrick, H., 188, 546.
- Nebraska Experiment Station, 20, 22, 67.
- Nelson, R. J., 230.
- Nematode worms, 474.
- Nesbit, D. M., 456.
- Newman, C. L., 247, 299, 483.
- Newman, J. S., 246, 339, 456.
- Nicotiana tabacum*, 523.
- Nitrate of soda, 15, 48, 156, 327.
- Nitrogen, a rational system of fertilization with, 329.

Nitrogen (*continued*)

- cost of, 328.
- need of cotton soils for, 328.
- sources of, 327.

North Carolina, Department of  
Agriculture, 67, 77, 119, 120,  
126, 263, 266, 295, 340, 360.

Experiment Station, 188, 216,  
546.

productive varieties of corn in,  
120.

productive varieties of cotton  
in, 394.

Nitrogen, effects on maturity of  
cotton, 367.

## Oats, Appler, 9.

Bancroft, 9.

Burt, 6, 9.

change of seed, 21.

composition, 4, 5.

Culberson, 9.

cultural methods for, 16.

diseases of, 23.

draft on soil fertility, 5.

drilling *versus* broadcast sowing,  
17.

fertilizers for, 13, 15.

fungous diseases of, 23.

grain, 4.

harvesting and marketing, 26.

heaving of, 19.

improvement of, 12.

in rotation, 14.

insect pests of, 25.

inter-tillage of, 22.

laboratory exercises, 29.

leaves, 2.

literature, 3.

"May," 9.

nitrate of soda for, 15.

open-furrow method, 18.

panicle and spikelet, 2.

pasturing, 22.

pollination of, 2.

preparation of land for, 16.

Oats (*continued*)

quantity of seed, 19.

Red Rust-proof, 6, 7.

roots, 1.

rotation for, 14.

rust of, 23.

size of seed, 20.

smut, 23.

soils for, 13.

stems, 1.

teams and labor, 28.

time to sow, 16.

Turf or Grazing, 6, 11.

types of Southern, 6.

varieties of, 6.

weeds in, 23.

winter-killing of, 19.

with crimson clover, 27.

Ohio Experiment Station, 20, 106,  
149.

Oklahoma Experiment Station, 43,  
51, 58, 121.

Oklahoma, productive varieties of  
corn in, 121.

Ontario Agricultural College and  
Experiment Farms, 20.

Orton, W. A., 420.

*Oryza sativa*, 217.

*Ozonium*, 414.

Parker, E. C., 205.

Pasturing oats, 23.

Pasturing wheat, 57.

Patterson, L. C., 273.

Peanuts, 464.

as stock food, 479.

breeding, 471.

composition of, 466.

hulls, 466.

kernels, 466.

meal, 466.

nut, 466.

cultivation, 471.

distance between plants, 469.

effects on pork and lard, 479.

enemies, 482.

- Peanuts (*continued*)  
   fertilizers, 467.  
   harvesting, 482.  
   in rotation, 473.  
   laboratory exercises, 482.  
   land-plaster for, 467.  
   leaf-spot, 482.  
   liming soil for, 467.  
   literature, 384.  
   method of planting, 469.  
   North Carolina, 476.  
   oil from, 464, 478.  
   plant, description of, 464.  
   preparation of land for, 468.  
   preparation of seed, 470.  
   soils, 464.  
   Spanish, 476.  
   time of planting, 471.  
   uses of, 476.  
   varieties, 476.  
   Virginia Bunch, 476.  
   Virginia Runner, 476.  
   yields, 481.
- Pepper-grass, 60.
- Phosphate, effect on maturity of  
   cotton, 337.  
   need of cotton soils for, 332.  
   raw or ground rock, 330.
- Phosphates, effects of different  
   forms of, 33.
- Phosphoric acid, cost of, 332.  
   sources of, 330, 331.
- Plant breeding a specialty, 312.
- Plant Industry, U. S. Bureau of, 60,  
   266, 299, 547.
- Planter, hand, 169.  
   check-row, 166.
- Plowing, depth of, 343.  
   time of, 159, 342.
- Plumb, C. S., 188.
- Poe, C. H., 360, 376, 387.
- Polish wheat, 40.
- Pollen-tube, course of, 89.
- Potash, effect on maturity of cot-  
   ton, 338.
- Potash fertilizers, 332.
- Potash (*continued*)  
   for checking cotton rust, 333.  
   need for, 332.  
   sources of, 337.
- Poulard wheat, 40.
- Price, R. H., 455.
- Protoparce Carolina*, 544.
- Prussic acid in cassava roots, 458.
- Raw phosphate in composts, 337.
- Red cane, 520.
- Redding, R. J., 145, 155, 205, 340,  
   360.
- Red May wheat, 43.
- Red rice, 228.
- Rhode Island Experiment Station,  
   444.
- Rice, 217.  
   amount of seed, 221.  
   birds, 229.  
   bran, composition of, 219.  
   composition of, 219.  
   distribution, 217.  
   fertilizers for, 221, 227.  
   fungous diseases, 229.  
   harvesting, 227.  
   Honduras, 220.  
   hulls, composition of, 219.  
   implements and labor, 221.  
   insect enemies of, 229.  
   irrigation, 223.  
   Japan, 220.  
   laboratory exercises, 229.  
   literature, 230.  
   polish, composition of, 219.  
   preparation of land for, 221.  
   production of, 217.  
   rust, 229.  
   smut, 229.  
   soils, 221.  
   sowing, 221.  
   straw, composition of, 219.  
   upland, 225.  
   varieties, 220.  
   water weevil, 229.  
   weeds in, 228.

- Rice (*continued*)  
 weevil, 211.  
 yield of, 228.
- Ridgway, C. S., 89.
- Roberts, H. F., 246.
- Robinson, T. A., 376.
- Root-knot, 413.
- Roper, W. N., 483.
- Rose, R. E., 522.
- Ross, B. B., 270, 271, 273, 522.
- Rotation for oats, 14.  
 for wheat, 45, 46.
- Rust of oats, 23.
- Rusts of wheat, 60.
- Rye and barley, 68.  
 and crimson clover, 72.  
 clasps on leaf, 69.  
 climate for, 70.  
 description, 68.  
 enemies, 73.  
 ergot in, 73.  
 fertilizers for, 70.  
 heads of, 69.  
 laboratory exercises, 77.  
 literature, 77.  
 pollination in, 70.  
 preparation and sowing, 71.  
 soils for, 70.  
 uses, 68.  
 utilization, 72.  
 varieties, 70.
- Saccharum officinarum*, 484.
- Sargent, F. L., 77, 97.
- Scherffius, W. H., 547.
- Schulte, J. I., 205, 546.
- Scofield, C. S., 67.
- Score-card for corn, 101.  
 for cotton plant, 312.  
 for oats, 31.  
 for wheat, 66.
- Seed, change of, 57.
- Seeding machines, 55.
- Seed wheat, best size of, 56.
- Self-pollination in corn, 139.
- Shamel, A.D., 547.
- Shiver, F. S., 373.
- Shocker for corn, 198.
- Shocking horse, 194.
- Shoemith, V. M., 111.
- Shredder, 193, 200.
- Silage, 99.
- Silo, 99.
- Sirup, defined, 513.  
 making, 513.
- Smith, L. H., 136, 149.
- Smut, of barley, 77.  
 loose, of wheat, 61.  
 of corn, 214.  
 of oats, 23.  
 of wheat, 61.
- Soils, acid, for corn, 151.  
 for oats, 13.  
 U. S. Bureau of, 157, 340, 346.
- Sorghums, 231.  
 laboratory exercises, 245.  
 literature, 47.
- Sorghum vulgare*, 231.  
 Amber, 234, 235, 236.  
 composition of, 232.  
 crossing, 233.  
 cultivation, 237.  
 effects on soil, 232.  
 enemies, 233.  
 fertilizer for, 236.  
 general description, 231.  
 groups of, 231.  
 harvesting, 237.  
 kernel smut, 233.  
 midge, 233.  
 Orange varieties, 235, 236.  
 planting, 237.  
 preparation for, 237.  
 Red Top or Sumac, 235.  
 saccharine, 234.  
 smut, 234.  
 soils for, 236.  
 sweet, composition of seed  
 and of cured plant, 232.  
 sweet, description and use, 234  
 varieties, 235.  
 where grown, 235.

- Soule, A. M., 67, 149, 188.
- South Carolina, Clemson College, 376.
- South Carolina Experiment Station, 121, 187, 219, 230, 246, 270, 295, 299, 333, 340, 359, 406.
- South Carolina, productive varieties of corn in, 121.
- productive varieties of cotton in, 394.
- Spachelotheca sorghi*, 233.
- Sphaeronema fimbriatum*, 454.
- Stalk cutter, 158.
- Statistics, U. S. Bureau of, 387.
- Stevens, F. L., 215, 420.
- Stockbridge, H. E., 462, 522.
- Stubbs, W. C., 230, 521.
- Sturtevant, E. L., 92, 117, 126.
- Subsoiling, 163, 343.
- Suckers on corn, 83.
- Sugar, consumption of, 519.
- production of, 518.
- Sugar-cane, 484.
- bedding, 510.
- borer, 519.
- buds, 489.
- burning refuse, 502.
- by-products, 513.
- composition, 492.
- cowpeas as fertilizer for, 505.
- cultivation, 501.
- in Cuba, 503.
- cultural methods, 498.
- digging, "seed cane," 510.
- diseases, 520.
- duration of, 484.
- extraction of juice, 492.
- fertilizer experiments, 496.
- fertilizers, 495.
- harvesting, 507.
- in Louisiana, 511.
- history, 517.
- improvement of, 491.
- insect enemies, 519.
- Japanese, 507.
- Sugar-cane (*continued*)
- laboratory exercises, 521.
- leaf-hopper, 520.
- leaves, 485.
- legumes as fertilizer, 497.
- literature, 521.
- on uplands, 489.
- plant food removed by, 492.
- planting in Louisiana, 50.
- planting in Pine Belt, 500.
- preparation for, 498.
- propagation, 489, 498.
- from seed, 490.
- proportion of parts, 492.
- roots, 485.
- rotation for, 503.
- sirup, effects of canning, 516.
- sirup-making, chemicals in, 517.
- sirup-making, equipment for, 514.
- sirup, prevention of sugaring, 510.
- soils, 497.
- source of nitrogen in, 496.
- source of potash for, 498.
- Southern grass-worm, 520.
- stem, 486.
- stripper, 509.
- stripping and cutting, 507.
- structure, 487.
- tillage, 501.
- varieties, 505.
- yields, 512.
- "Sugar millet," 231.
- Sweet-potato, 425.
- banking, 450.
- bedding, 438.
- black-rot, 454.
- classification of varieties, 432.
- conditions in storing, 449.
- cultivation, 446.
- cultural methods, 438.
- desirable qualities, 432.
- distance between plants, 445.
- draft on soil fertility, 430.
- drawing the slips, 442.
- dry-rot, 455.

- Sweet-potato (*continued*)  
 effect on land, 437.  
 fertilizers, 435.  
 fire hot-beds, 439.  
 flowers and seeds, 427.  
 fungous diseases, 454.  
 harvesting, 447.  
 high and low beds for, 446.  
 humus for, 435.  
 insects, 452.  
 kiln drying, 450.  
 kind and quantity to bed, 440.  
 laboratory exercises, 455.  
 literature, 455.  
 manure bed for, 438.  
 market demands, 431.  
 methods of harvesting, 448.  
 place in the rotation, 436.  
 preparation of land for, 445.  
 propagation of, 438.  
 pruning the vines, 447.  
 root-borer, 452.  
 root-rot, 414.  
 slips, 441.  
 soft-rot, 455.  
 soils, 434.  
 starch and alcohol from, 429.  
 storage house, 451, 452.  
 time to dig, 447.  
 time of transplanting, 444.  
 transplanting, 442.  
 transplanting machines, 443.  
 value as food, 428.  
 varieties, 431.  
 vine cuttings of, 445.  
 yields, 449.
- Tennessee Experiment Station, 39,  
 67, 121, 270.
- Tennessee, productive varieties of  
 corn in, 121.
- Teosinte, 78.
- Texas Experiment Station, 122,  
 246, 295, 314.
- Texas, productive varieties of corn  
 in, 122.
- Throw-board, 190, 191.
- Tillage of wheat, 57.
- Tilletia horrida*, 229.
- Tobacco, 523.  
 breeding, 527.  
 composition, 524.  
 cultivation, 533.  
 cultural methods, 529.  
 curing, 540, 542.  
   air, 541.  
   fire, 540.  
   flue, 541.  
   cigar, 541.  
 cut-worms, 544.  
 description, 523.  
 diseases, 544.  
 distance for, 532.  
 distribution, 523.  
 fertilizer formulas, 526.  
 fertilizers, 525.  
 harvesting, 538.  
 indications of maturity, 538.  
 insects, 544.  
 laboratory exercises, 545.  
 literature, 546.  
 nematodes, 544.  
 nitrogen for, 525.  
 preparation for, 532.  
 rotations for, 537.  
 seed-bed, 529.  
 seed-blower, 529.  
 seed, saving, 527.  
 setting, 532.  
 shade, 530, 536.  
 soils, 524.  
 sowing, 531.  
 stripping, 543.  
 suckering, 535.  
 topping, 533.  
 transplanting machine, 534.  
 two methods of harvesting, 539.  
 types and varieties, 526.  
 wire-worm, 545.  
 worm, Southern, 544, 545.  
 yields and prices, 543.
- Tompkins, A. D., 376.

- Toxoptera graminum*, 25.  
 Tracy, S. M., 462.  
 Tubercles, distinguished from root-knot, 415.  
 Turn-plow, in cultivating corn, 174.  
 Tyler, F. K., 299.
- Umberger, H. J. C., 246.  
 Upland rice, 226.  
 U. S. Department of Agriculture, 130, 149, 205, 216, 221, 228, 230, 246, 247, 281, 314, 462, 482, 522, 546, 547.  
*Ustilago maydis*, 214.
- Vanatter, P. O., 67, 149, 188.  
 Varieties of corn, yields of, 118.  
 Vegetable Physiology and Pathology, U. S. Division of, 67.  
 Vetch, hairy, 12.  
 Vincenheller, W. G., 230.  
 Virginia Experiment Station, 122, 130, 149, 188, 548.  
 Virginia, productive varieties of corn in, 122.
- Waite, M. B., 456.  
 Warburton, C. W., 240, 247.  
 Watt, G., 266, 281.  
 Webber, H. J., 149, 266, 314.  
 Weeder, 171, 172.  
   use in cultivating cotton, 350.
- Weeds in oats, 23.  
   in rice, 228.  
   in wheat, 59.
- Weevils in corn, 211.
- Wheat, Blue Stem, 41, 42.  
   change of seed, 57.  
   climate for, 53.  
   composition, 39.  
   cultural methods, 51.  
   diseases, 60.  
   drilling *versus* broadcast sowing, 54.  
   enemies, 59.  
   fertilization of, 47.
- Wheat (*continued*)  
   Fulcaster, 42, 43.  
   grain, 37.  
   hay, when to cut, 59.  
   Hessian fly, 62.  
   improvement of varieties, 44.  
   insect pests of, 62.  
   laboratory exercises, 64.  
   large *versus* medium and small grains, 56.  
   leaves, 34.  
   lime for, 45.  
   literature, 67.  
   means of distinguishing varieties, 43.  
   most productive varieties, 43.  
   pasturing, 57.  
   plant food removed by, 47.  
   plant-louse, 63.  
   pollination, 34.  
   preparation of land, 51.  
   prices, 59.  
   Purple Straw, 41, 42.  
   qualities desired in, 44.  
   quantity of seed, 55.  
   Red May, 43.  
   roots, 32.  
   rotation for, 45, 46.  
   rust, 60.  
   score-card for, 66.  
   size of grain, 38.  
   smut, 61.  
   soils for, 45.  
   species and subspecies, 40.  
   spikelets, 35.  
   standards for, 66.  
   stems, 33.  
   stinking smut, 61.  
   structure and composition, 33.  
   tillage, 57.  
   time to harvest, 58.  
   time to sow, 52.  
   varieties, 40.  
   with crimson clover, 27.  
   yields, 59.
- White, H. C., 340.



- |                                      |                                    |
|--------------------------------------|------------------------------------|
| Whitney, Milton, 157, 547, 548.      | Williamson method of corn culture, |
| Wight, J. B., 522.                   | 18.                                |
| Wild onion, 60.                      | Winter-killing, prevention of, 19. |
| Wiley, H. W., 462, 522.              | Wisconsin Station, 77.             |
| Williams, C. B., 126, 188, 266, 338, | <i>Zea mays</i> , 78.              |
| 340.                                 | Zintheo, C. J., 205.               |
| Williams, C. G., 149.                |                                    |



THE following pages contain advertisements of a few of the Macmillan books on kindred subjects



# THE RURAL TEXT-BOOK SERIES

EDITED BY L. H. BAILEY

A series of books primarily intended for the students in agricultural colleges, but exceedingly useful to any one who is willing to give the subject serious study.

*NOW READY OR IN PRESS*

## The Principles of Soil Management

By T. L. LYON AND E. O. FIPPIN

An interesting, easily understood general discussion of soils, drainage, mulching, irrigation, manures, fertilizers, etc. A book which every farmer should study.

*Cloth, 12mo, 531 pages, illustrated, \$1.75*

## Southern Field Crops

By J. F. DUGGAR

*In press*

## Plant Physiology

By B. M. DUGGAR

---

*TO BE ADDED TO THE SERIES LATER*

Manures and Fertilizers

By H. J. WHEELER

Animal Breeding

By F. B. MUMFORD

Cotton

By R. J. H. DE LOACH

---

*VOLUMES ON PLANT BREEDING, PLANT PATHOLOGY,  
AND SPECIAL PHASES OF FARM LIFE  
WILL PROBABLY BE ARRANGED FOR AT AN EARLY DAY*

---

PUBLISHED BY

THE MACMILLAN COMPANY

64-66 Fifth Avenue, New York

# BOOKS ON AGRICULTURE

## ON SELECTION OF LAND, Etc.

Thomas F. Hunt's How to Choose a Farm . . . . .	\$1 75
E. W. Hilgard's Soils: Their Formation and Relations to Climate and Plant Growth . . . . .	4 00
Isaac P. Roberts's The Farmstead . . . . .	1 50

## ON TILLAGE, Etc.

F. H. King's The Soil . . . . .	1 50
Isaac P. Roberts's The Fertility of the Land . . . . .	1 50
Elwood Mead's Irrigation Institutions . . . . .	1 25
F. H. King's Irrigation and Drainage . . . . .	1 50
William E. Smythe's The Conquest of Arid America . . . . .	1 50
Edward B. Voorhees's Fertilizers . . . . .	1 25
Edward B. Voorhees's Forage Crops . . . . .	1 50
H. Snyder's Chemistry of Plant and Animal Life . . . . .	1 25
H. Snyder's Soil and Fertilizers. Third edition . . . . .	1 25
L. H. Bailey's Principles of Agriculture . . . . .	1 25
W. C. Welborn's Elements of Agriculture, Southern and Western . . . . .	75
J. F. Duggar's Agriculture for Southern Schools . . . . .	75
G. F. Warren's Elements of Agriculture . . . . .	1 10
T. L. Lyon and E. O. Fippin's The Principles of Soil Management . . . . .	1 75
Hilgard & Osterhout's Agriculture for Schools on the Pacific Slope . . . . .	1 00
J. A. Widtsoe's Dry Farming . . . . .	1 50

## ON GARDEN-MAKING

L. H. Bailey's Manual of Gardening . . . . .	2 00
L. H. Bailey's Vegetable-Gardening . . . . .	1 50
L. H. Bailey's Horticulturist's Rule Book . . . . .	75
L. H. Bailey's Forcing Book . . . . .	1 25
A. French's How to Grow Vegetables . . . . .	1 75

## ON FRUIT-GROWING, Etc.

L. H. Bailey's Nursery Book . . . . .	1 50
L. H. Bailey's Fruit-Growing . . . . .	1 50
L. H. Bailey's The Pruning Book . . . . .	1 50
F. W. Card's Bush Fruits . . . . .	1 50
J. T. Bealby's Fruit Ranching in British Columbia . . . . .	1 50

## ON THE CARE OF LIVE STOCK

D. E. Lyon's How to Keep Bees for Profit . . . . .	1 50
Nelson S. Mayo's The Diseases of Animals . . . . .	1 50
W. H. Jordan's The Feeding of Animals . . . . .	1 50
I. P. Roberts's The Horse . . . . .	1 25
George C. Watson's Farm Poultry . . . . .	1 25
C. S. Valentine's How to Keep Hens for Profit . . . . .	1 50
O. Kellner's The Scientific Feeding of Animals (trans.) . . . . .	1 90
M. H. Reynolds's Veterinary Studies for Agricultural Stud- dents . . . . .	1 75

## BOOKS ON AGRICULTURE — *Continued*

### ON DAIRY WORK

Henry H. Wing's Milk and its Products . . . . .	\$1 50
C. M. Aikman's Milk . . . . .	1 25
Harry Snyder's Dairy Chemistry . . . . .	1 00
W. D. Frost's Laboratory Guide in <sup>1</sup> Elementary Bacteriology . . . . .	1 60
I. P. Sheldon's The Farm and the Dairy . . . . .	1 00
Chr. Barthel's Methods Used in the Examination of Milk and Dairy Products . . . . .	1 90

### ON PLANT DISEASES, Etc.

George Massee's Diseases of Cultivated Plants and Trees . . . . .	2 25
J. G. Lipman's Bacteria in Relation to Country Life . . . . .	1 50
E. C. Lodeman's The Spraying of Plants . . . . .	1 25
H. M. Ward's Disease in Plants (English) . . . . .	1 60
A. S. Packard's A Text-book on Entomology . . . . .	4 50

### ON PRODUCTION OF NEW PLANTS

L. H. Bailey's Plant-Breeding . . . . .	1 25
L. H. Bailey's The Survival of the Unlike . . . . .	2 00
L. H. Bailey's The Evolution of Our Native Fruits . . . . .	2 00
W. S. Harwood's New Creations in Plant Life . . . . .	1 75

### ON ECONOMICS AND ORGANIZATION

J. B. Green's Law for the American Farmer . . . . .	1 50
J. McLennan's Manual of Practical Farming . . . . .	1 50
L. H. Bailey's The State and the Farmer . . . . .	1 25
Henry C. Taylor's Agricultural Economics . . . . .	1 25
I. P. Roberts's The Farmer's Business Handbook . . . . .	1 25
George T. Fairchild's Rural Wealth and Welfare . . . . .	1 25
S. E. Sparling's Business Organization . . . . .	1 25
In the Citizen's Library. Includes a chapter on Farming	
Kate V. St. Maur's A Self-supporting Home . . . . .	1 75
Kate V. St. Maur's The Earth's Bounty . . . . .	1 75
G. F. Warren and K. C. Livermore's Exercises in Farm Management . . . . .	80
H. N. Ogden's Rural Hygiene . . . . .	1 50

### ON EVERYTHING AGRICULTURAL

L. H. Bailey's Cyclopedic of American Agriculture:	
Vol. I. Farms, Climates, and Soils.	
Vol. II. Farm Crops.	
Vol. III. Farm Animals.	
Vol. IV. The Farm and the Community.	
Complete in four royal 8vo volumes, with over 2000 illustrations.	
Price of sets: cloth, \$20      half morocco, \$32	

*For further information as to any of the above, address the publishers.*

## THE MACMILLAN COMPANY

Publishers

64-66 Fifth Avenue

New York

# Cyclopedia of American Agriculture

EDITED BY L. H. BAILEY

Director of the College of Agriculture and Professor of Rural Economy,  
Cornell University.

*With 100 full-page plates and more than 2000 illustrations in the text; four volumes; the set, \$20.00  
half morocco, \$32.00 carriage extra*

VOLUME I—Farms

VOLUME III—Animals

VOLUME II—Crops

VOLUME IV—The Farm and the Community

“Indispensable to public and reference libraries . . . readily comprehensible to any person of average education.”—*The Nation*.

“The completest existing thesaurus of up-to-date facts and opinions on modern agricultural methods. It is safe to say that many years must pass before it can be surpassed in comprehensiveness, accuracy, practical value, and mechanical excellence. It ought to be in every library in the country.”—*Record-Herald*, Chicago.

# Cyclopedia of American Horticulture

EDITED BY L. H. BAILEY

*With over 2800 original engravings; four volumes; the set, \$20.00  
half morocco, \$32.00 carriage extra*

“This really monumental performance will take rank as a standard in its class. Illustrations and text are admirable. . . . Our own conviction is that while the future may bring forth amplified editions of the work, it will probably never be superseded. Recognizing its importance, the publishers have given it faultless form. The typography leaves nothing to be desired, the paper is calculated to stand wear and tear, and the work is at once handsomely and attractively bound.”—*New York Daily Tribune*.

---

PUBLISHED BY

**THE MACMILLAN COMPANY**

64-66 Fifth Avenue, New York













