



LIBRARY OF THE
HORTICULTURISTS' LAZY-CLUB.
CORNELL UNIVERSITY.

PRESENTED BY

H. O. Gould
College Park
Md.

Cornell Univ. 96-99

N. B.—Inscribe the date, post-office address, course of study,
and the like.

Cornell University Library
SB 359.W64 1899

The California fruits and how to grow th



3 1924 003 391 384

mann

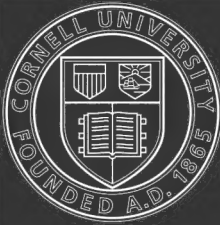

Cornell University Library

The original of this book is in
the Cornell University Library.

There are no known copyright restrictions in
the United States on the use of the text.

9293 C132 Apr.

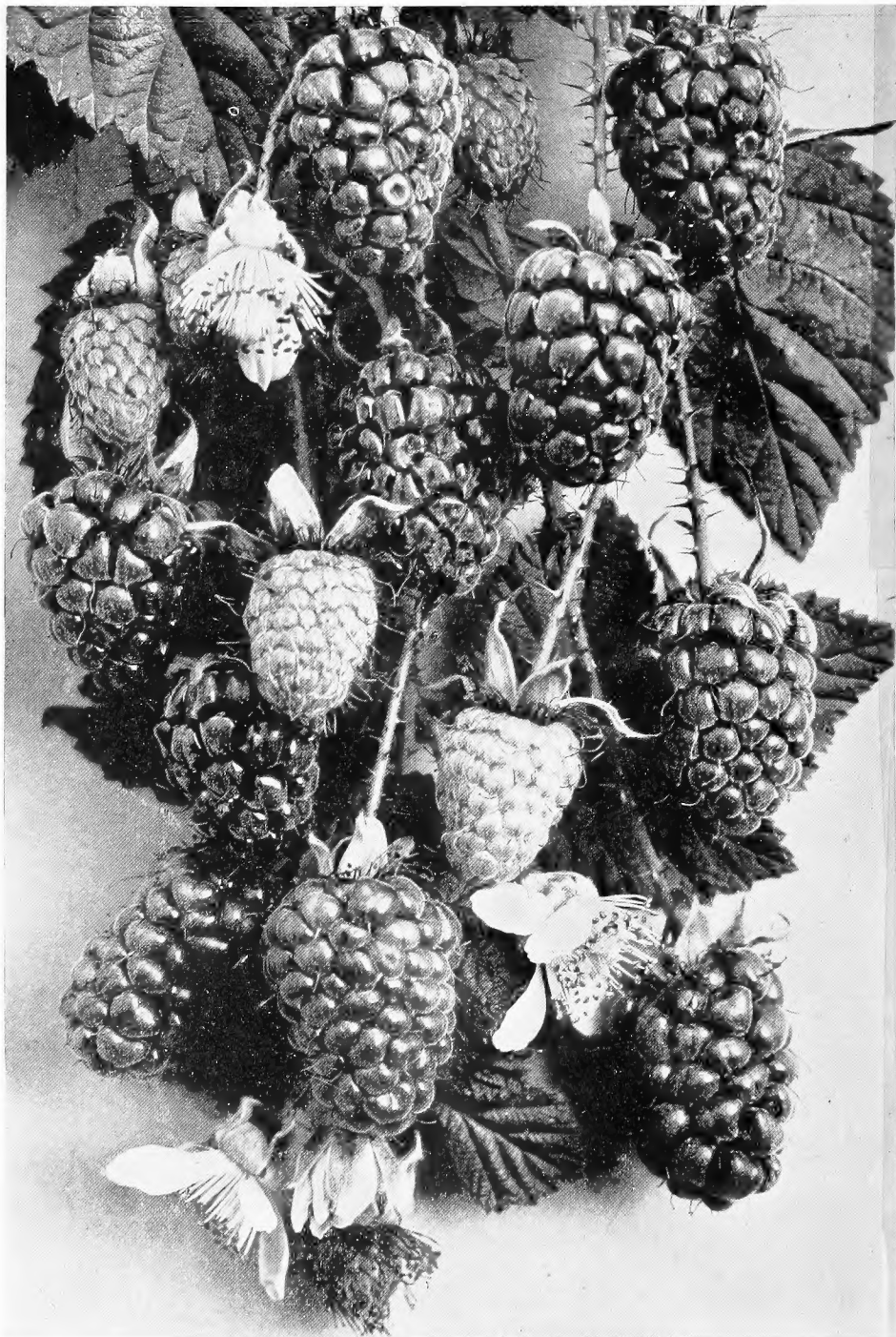

Actual size: photographed in Santa Cruz in January.

THE LOGANBERRY, A CALIFORNIA HYBRID, BY J. H. LOGAN. See page 40.

THE
CALIFORNIA FRUITS

AND
HOW TO GROW THEM.

A MANUAL OF METHODS WHICH HAVE YIELDED GREATEST SUCCESS; WITH LISTS OF
VARIETIES BEST ADAPTED TO THE DIFFERENT DISTRICTS OF THE STATE

BY EDWARD J. WICKSON, A. M.

Professor of Agricultural Practise in the University of California, and Horticulturist of the
Agricultural Experiment Station; Author of "California Vegetables in Garden
and Field;" President of the California State Floral Society;
Horticultural Editor of the "Pacific Rural Press"
of San Francisco, etc.

"The branch here bends beneath the weighty pear,
And verdant olives flourish round the year;
The balmy spirit of the western gale
Eternal breaths on fruits untaught to fail;
Each dropping pear a following pear supplies,
On apples, apples, figs on figs arise;
The same mild season gives the blooms to blow,
The buds to harden, and the fruits to grow."

—Pope's *Hom. Odys. Bk. VII.*

THIRD EDITION: LARGELY REWRITTEN.

PACIFIC RURAL PRESS, PUBLISHERS
SAN FRANCISCO, CAL.

1900.

E. V.

@
S B 359
W 64
18 99

A9.6931

ENTERED ACCORDING TO ACT OF CONGRESS, IN THE YEAR 1899, BY
EDWARD J. WICKSON AND PACIFIC RURAL PRESS,
IN THE OFFICE OF THE LIBRARIAN OF CONGRESS, AT WASHINGTON.

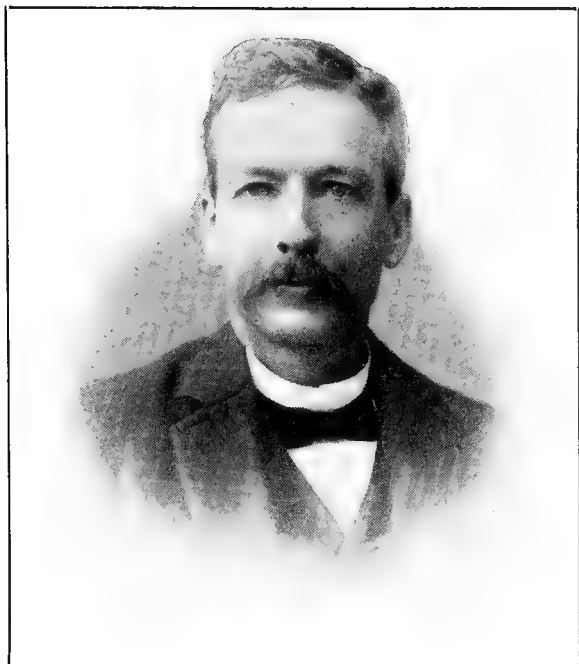

TO LUTHER BURBANK, OF SANTA ROSA,
WHOSE CREATIVE HORTICULTURAL
GENIUS HAS, BY NEW COINAGE OF
"BLOOMING, AMBROSIAL FRUIT OF VEGETABLE
GOLD," AMPLY REQUITED THE
WORLD'S GIFT OF THE CHOICEST FLOWERS
AND FRUITS FOR THE ADVANCEMENT
AND ADORNMENT OF CALIFORNIA
—THUS BESTOWING NEW HONORS UPON
THE STATE AND NEW RICHES UPON
MANKIND—THIS WORK IS CORDIALLY
INSCRIBED AS AN EXPONENT OF ESTEEM
AND APPRECIATION.

PREFACE TO THIRD EDITION

The writer desires to express sincere gratitude for the cordial welcome and patronage which the two earlier editions of this treatise have received, not only in California, but in other semitropical countries. At the time of the preparation of the first edition in 1889 there was no thought that it would find foreign fields of usefulness; it was merely the earnest hope of the writer that it would win its way as a safe guide to the extension of the fruit interests of California; and to that end no effort was spared to constitute the work an explicit and truthful statement of natural conditions attending fruit growing in California, and accurate descriptions of the practises which best minister to success under these conditions. The generous patronage bestowed upon the work by Californians for a decade is a demonstration that this purpose was attained, and it is largely owing to their cordial commendation that the work has extended so widely into foreign fields. It is profoundly satisfactory to the writer to have the assurance that the acceptance of the treatise as a faithful guide to practise in California has actually foreshadowed its popularity wherever the same fruits are grown; and, inversely, its acceptance abroad is indirect evidence of its accuracy and helpfulness in California.

With such inspiration as naturally proceeds from these facts, the writer has for two years devoted such time as could be spared from other pressing duties to a thorough revision of the work, condensing portions which were diffuse or merely of passing, local interest, and expanding other portions which are of deep and lasting importance and in which California experience and experiment really involve knowledge new to horticultural literature and of the widest applicability. The revision has required a rewriting of the most important chapters and a study of original data nearly equal to that involved in the preparation of the treatise in the first instance. The illustrations have also been largely replaced and the work brought up to the beginning of the century.

As was done in connection with earlier editions, the writer desires to extend to all readers an exhortation to correction of any statement which may seem unwarranted from their points of view and experience. The subject is varied, multifold, and involved, every new fact is important and will be welcomed.

EDWARD J. WICKSON.

University of California, Berkeley.

By the Same Author

· THE

California Vegetables in Garden and Field

A Manual of Practise With and Without Irrigation

CONTENTS:

Chapter

- I. Vegetable Growing in California.
- II. Farmers' Gardens in California.
- III. California Climate as Related to Vegetable Growing.
- IV. Vegetable Soils of California.
- V. Garden Irrigation.
- VI. Garden Drainage in California.
- VII. Cultivation.
- VIII. Fertilization.
- IX. Garden Location and Arrangement.
- X. The Planting Season.
- XI. Propagation.
- XII. Asparagus.
- XIII. Artichokes.
- XIV. Beans.
- XV. Beet.
- XVI. Cabbage Family.
- XVII. Carrot, Parsnip, and Salsify.
- XVIII. Celery.
- XIX. Chicory.

Chapter

- XX. Corn.
- XXI. Cucumber.
- XXII. Egg Plant.
- XXIII. Lettuce.
- XXIV. Melons.
- XXV. Onion Family.
- XXVI. Peas.
- XXVII. Peppers.
- XXVIII. Potatoes.
- XXIX. Radishes.
- XXX. Rhubarb.
- XXXI. Spinach.
- XXXII. Squashes.
- XXXIII. Tomato.
- XXXIV. Turnip.
- XXXV. Vegetable Sundries.
- XXXVI. Vegetables for Canning and Drying.
- XXXVII. Seed Growing in California.
- XXXVIII. Garden Protection.
- XXXIX. Weeds in California.

Large Octavo; 336 Pages; 12 Full-Page Plates

Price \$2.00 Including Postage to Any Part of the United States

PACIFIC RURAL PRESS, Publishers

330 Market St., San Francisco, Cal.

CONTENTS.

CHAPTER	PART FIRST: GENERAL.	PAGE
I.	The Climate of California and Its Local Modifications . . .	9
II.	Why the California Climate Specially Favors the Growth of Fruits	19
III.	The Fruit Soils of California	27
IV.	The Wild Fruits of California	38
V.	California Mission Fruits	44
VI.	Introduction of Improved Fruit Varieties	48
PART SECOND: CULTURAL.		
VII.	Clearing Land for Fruit	57
VIII.	The Nursery	66
IX.	Budding and Grafting	76
X.	Preparation for Planting	90
XI.	Planting the Trees	100
XII.	Pruning Orchard Trees and Thinning Fruit	113
XIII.	Cultivation	138
XIV.	Fertilizers for Fruit Trees and Vines	154
XV.	Irrigation of Fruit Trees and Vines	167
PART THIRD: ORCHARD FRUITS.		
XVI.	The Apple	187
XVII.	The Apricot	200
XVIII.	The Cherry	214
XIX.	The Peach	228
XX.	The Nectarine	245
XXI.	The Pear	248
XXII.	Plums and Prunes	261
XXIII.	The Quince	278
PART FOURTH: THE GRAPE.		
XXIV.	Vine Propagation and Planting	281
XXV.	Pruning and Care of the Vine	298
XXVI.	Grape Varieties in California	309
PART FIFTH: SEMITROPICAL FRUITS.		
XXVII.	The Date	316
XXVIII.	The Fig	321

XXIX.	The Olive.....	333
XXX.	The Orange	351
XXXI.	The Lemon, Lime, etc.....	373
XXXII.	Minor Semitropical Fruits	381
PART SIXTH: SMALL FRUITS.		
XXXIII.	Berries and Currants	389
PART SEVENTH: NUTS		
XXXIV.	Nut Growing in California	406
PART EIGHTH: FRUIT PRESERVATION.		
XXXV.	Fruit Canning, Crystallizing and Drying.....	420
PART NINTH: FRUIT PROTECTION.		
XXXVI.	Injurious Insects.....	434
XXXVII.	Diseases of Trees and Vines	456
XXXVIII.	Suppression of Injurious Animals and Birds.....	460
XXXIX.	Protection from Winds and Frosts	465
PART TENTH: MISCELLANEOUS.		
XL.	Utilization of Fruit Wastes.....	469
	INDEX	471

CALIFORNIA FRUITS.

PART FIRST: GENERAL.

CHAPTER I.

THE CLIMATE OF CALIFORNIA AND ITS LOCAL MODIFICATIONS.

In climatic conditions affecting horticulture we have in California almost an epitome of the whole United States, with added climatic characters peculiarly our own. We have high mountain valleys with wintry temperature-conditions, where only hardy northern fruits can be grown; we have hot valleys where the date palm confidently lifts its head to the fiery sunshine, while its feet are deeply planted in moist substrata beneath the sandy surface; but we cannot claim tropical conditions, because our dry air denies us many strictly tropical growths, although we have frostless sites for them. Intermediate between the cold and snow of the mountains and the heat and sand of the desert, we have every describable modification and gradation, and, naturally, it is between these extremes that our richest inheritance of horticultural adaptation lies. It is this infinite variety which gives us true title to the term *semitropical*.

When this breadth and scope of our horticultural adaptations is realized, it becomes apparent that an enumeration of the fruits we can grow successfully would be, in fact, a catalogue of the known fruits of the world, except those which are strictly tropical. Wherever there is a northern or southern departure from the equator sufficient to bring energy to mankind, or where the same is accomplished by elevation upon tropical mountain-side or plateau, there also are fruits which find a welcoming

home in California, and are improved by the intelligent cultivation and selection which here prevail. On the other hand, it has been abundantly demonstrated, during recent years, by official awards at great exhibitions and by the sharp criteria of the markets as well, that the fruits of wintry regions are quite as much benefited by transfer to proper locations in California as are the people who come to grow them. From north and south alike, then, California makes grand acquisitions, and includes within her area the adaptations of the whole country, with some which no other State possesses.

But while this horticultural scope is claimed for the State as a whole, it is necessary to add that local adaptations within the State must be very narrowly drawn. Our greatest failures have followed ill choice of location for the purpose intended. Whenever certain California fruits have been ill spoken of, they have been produced in the wrong places, or by ill-advised methods. It is possible, then, to produce both poor and perfect fruit of a given kind. It may be said this can be done anywhere by the extremes of culture and neglect, but to this proposition it must be added that in California equally excellent methods and care will produce perfection in one place and the opposite in another. One who seeks to know California well must undertake to master both its horticultural greatness and littleness; and so closely are these associated, and so narrow the belts of special adaptations, that there are many counties which have a range of products nearly as great as the State itself.

It is hard for the stranger to realize this. It is difficult for him to believe that the terms "northern" and "southern" have almost no horticultural significance in California; that northern fruits reach perfection, under proper conditions, at the south, and vice versa; that some regions of greatest rainfall have to irrigate most frequently; that some of greatest heat have sharpest valley frosts; that some fruits can be successfully grown through a north and south distance of 500 miles, but cannot be successfully carried a few hundred feet of either less or greater elevation; that on the same parallel of latitude within a hundred miles of distance, from coast to mountainside, one can continuously gather marketable Bartlett pears for three months—not to mention the second crop, which is often of account on the same trees in the same season.

Through the multitude of local observations, which seem perplexing and almost contradictory, it is possible to clearly discern certain general conditions of both nature and culture, which may be briefly advanced as characteristically and distinctively Californian.

The climate of the Pacific Coast is described by the meteor-

ologist as "insular or moderate," as contrasted with the "continental or excessive" climate of the regions east of the Sierra Nevadas. The west coast of Europe is also insular in its climate. The northern limit of an annual mean temperature of 50° Fahr. is about 51° 30' of north latitude on western coasts of both Europe and America. But though there is this similarity in mean annual temperature, there is a decided advantage pertaining to our climate over that of west Europe in that our range of temperature is less; that is, extremes of heat and cold are nearer together, and changes are therefore much less excessive. This characteristic of our local climates is due in the main to two great agencies, one active, bringing heat, the other passive, shielding us from arctic influences.

First: Our proximity to the Pacific Ocean. For three hundred days in the year the air currents from this vast body of warm, placid waters flow over California, moderating summer heat and winter cold, and, impinging on the western slope of the Sierra Nevada, give to the foot-hills, up to a certain elevation, a valley climate and a valley range of products, as will be noted later.

Second: Another agency contributing to the mild climate of the Pacific Coast consists in the mountain barriers upon our northern and eastern boundaries. Redding says it was Guyot who first called attention to the fact that the Sierra Nevada and the Cascade Mountains reach the coast of Alaska and bend like a great arm around its western and southern shore, thus shutting off or deflecting the polar winds that otherwise would flow down over the Pacific Coast States, while California has her own additional protection from the north in the mountain arch which has its keystone in Mount Shasta.

CHIEF TOPOGRAPHICAL AND CLIMATIC DIVISIONS OF CALIFORNIA.

California is usually divided into three main areas and climates, each distinct in typical conditions and yet separated by regions, more or less wide, in which these conditions merge and influence each other. Dr. Robertson says*:-

Isothermal lines which normally run east and west are, as they near the Pacific, deflected north and south, and define three distinct climatic belts. These may be named coast, valley, and mountain; and while they resemble each other in having only two seasons, they are dissimilar in other respects. These differences depend upon the topography of the country, and are of degree rather than of kind; altitude, distance from the ocean, and situation with reference to mountain chains, giving to each region its characteristic climate.

* Report of State Agricultural Society, 1886, p. 322.

How similar are the conditions which prevail in these belts may be learned from the data shown in the following table, which includes points separated by nearly the whole length of the State, the difference in latitude of the extreme north and south points being seven or eight degrees. Thus, through a north and south distance great as that which separates the States of Georgia and New York, similar climatic conditions prevail in California. In the following table the averages are deduced from observations by the United States Weather Bureau observers for a long series of years:—

SEASONAL AND EXTREME TEMPERATURES AND AVERAGE RAINFALL IN VARIOUS CALIFORNIA REGIONS, FROM THE RECORDS OF THE U. S. WEATHER BUREAU, TO THE CLOSE OF 1898.

STATIONS.	COUNTY.	Elevation, feet.	Average Winter Temperature.	Average Spring Temperature.	Average Summer Temperature.	Average Fall Temperature.	Average Annual Temperature.	Highest Temperature.	Lowest Tem.	Average Annual Rainfall, inches.
<i>Coast.</i>										
Eureka.....	Humboldt.....	64	47.0	51.0	55.7	52.0	51.2	84	20	46.14
San Francisco	San Francisco..	183	51.8	52.3	59.4	56.9	56.5	100	29	23.31
San Jose.....	Santa Clara.....	94	49.6	56.7	66.2	59.7	58.0	104	22	14.52
Salinas.....	Monterey.....	44	48.6	55.9	61.9	56.7	55.8	96	20	14.58
S'nta Barbara	Santa Barbara..	100	54.1	57.6	65.9	62.5	60.0	100	28	18.19
Los Angeles..	Los Angeles.....	293	54.2	60.1	69.7	64.0	62.0	109	28	18.31
San Diego.....	San Diego.....	93	54.4	59.4	68.4	63.7	61.5	98	32	9.86
<i>Valley.</i>										
Redding.....	Tehama.....	557	47.1	60.5	80.0	64.4	63.0	117	18	34.60
Marysville....	Yuba.....	67	50.0	62.9	78.3	65.4	64.2	116	20	18.09
Sacramento...	Sacramento.....	35	47.7	58.3	72.3	62.0	60.1	108	19	20.56
Merced.....	Merced.....	171	49.0	61.0	78.9	64.9	63.4	120	20	10.30
Tulare.....	Tulare.....	287	49.8	62.5	80.6	63.4	64.1	118	14	7.00
Colton.....	San Bernardino	965	52.5	62.4	77.2	65.6	64.4	114	22	10.93
<i>Foot-hill.</i>										
Auburn.....	Placer.....	1360	46.9	56.8	74.6	62.2	60.1	108	12	32.55

LOCATIONS FOR THE GROWTH OF DIFFERENT FRUITS.

It is intended to describe as definitely as possible the locations suitable for the growth of different fruits in the special chapters given to those fruits, but there are a few general conditions which should be outlined.

In discussing the choice of location for an orchard it is not intended to speak geographically. As has already been intimated, latitude, which is a prime factor in geography, is of exceedingly small account as an indication of horticultural adaptations in California. The fact becomes strikingly apparent

when it is known that the apple and the orange, fruit kings whose kingdoms lie at opposite borders of the temperate zone, so far distant that one may be called semifrigid and the other semitropical, have in California utter disregard for the parallels of latitude, which set metes and bounds upon them in other lands, and flourish side by side, in suitable localities, from San Diego to Shasta. Impressive as this truth may be, it is not so startling as another fact, viz., that fruits, in suitable interior situations, ripen earlier at the north than at the south—a complete reversal of the tenets of the geographer.

It is apparent then that the selection of locations for orchards must be made with a knowledge of special conditions governing the distribution of equal temperatures and other natural agencies contributing to the development of fruit. This distribution, as has been intimated, is not by straight lines, as in parallels of latitude, but by curves, which proceed in various directions, governed chiefly by topography. These are curves of temperature, of rainfall, of elevation, of soil formation and deposit. Geography retires from authority; topography and climatology govern.

Let these ruling conditions be reviewed, then, briefly: First, as to general areas; second, with reference to special situations and locations.

COAST CLIMATE.

The chief characteristics of the coast climate are equable temperature, increasing southward; summers cool and winters warm, as compared with the interior; abundant rainfall, decreasing considerably southward; a somewhat humid atmosphere, as compared with the interior; frequent fogs or overcast skies; prevailing westerly winds.

The extension of coast influences toward the interior is governed by local topography. Coast valleys open to ocean winds are cooler and moister and demand hardier fruits than valleys sheltered by intervening ranges. Gaps and passes in the ranges are subject to winds of considerable force and low temperature, and are not generally favorable for fruit; on the other hand, situations sheltered on the north and west favor growth of fruit even though quite near the coast. Sometimes a distance of a few miles, sometimes a windbreak of natural forest or of planted trees, so modifies coast influences that fruits do well. Elevation on the sides of coast valleys secures similar results. For example, the floor of the Pajaro Valley is well suited for apples, late pears, cherries, plums, prunes, and berries (except gooseberries), while on adjacent hillsides peaches do well.

In southern California, coast winds are warmer than in the

upper half of the State, but coast influences intrude farther, as a rule, because the hills near the coast in southern California are low; the high ranges, answering to the Coast Range of the upper part of the State, trending far into the interior. On the coast side of these ranges fruits ripen later than in sheltered interior points in the upper part of the State, but eastward of them, where soil and moisture favor, or irrigation is practised, extra early locations have been found.

Some of the horticultural effects of the conditions prevailing on the coast may be described as follows:—

Late Ripening of Fruits.—The late ripening of fruits in most parts of southern California has just been mentioned. Intrusion of coast influences has the same effect at the north. Directly on the coast, at Pescadero, San Mateo County, for example, fruits ripen about a month later than in Santa Clara Valley, which is just across the Coast Range. Napa Valley, though about forty miles inland and sheltered by ranges of hills, still is sufficiently affected by coast influences to mature fruits considerably later than Vaca Valley, ten miles further east, beyond a higher range, which completely bars out these influences. In Ventura County, in a cañon sixteen miles from the ocean, and at an elevation of sixteen hundred feet, fruits ripen three weeks earlier than on the coast or in the valleys opening thereon.

Failure of Certain Fruits.—Though killing frosts are few directly on the coast, the deficiency in summer heat and sunshine renders some fruits unsatisfactory. This is especially the case in the upper coast region. Grapes and figs ripen imperfectly, while but a short distance back from the coast, in sheltered situations, they do well. Elevation sometimes produces corresponding effects. The complete reversal of coast conditions by local topography is seen in the Happy Camp region, on the west side of Siskiyou County, and east of the range which is the eastern boundary of Del Norte County, the extreme north coast county of the State. Happy Camp is in a warm belt, at an elevation where peaches, apricots, and nectarines do well if irrigated. The apricot at that latitude in ordinary situations is a failure, as it also is for a certain distance farther south along the coast.

Pests and Diseases.—Certain blights are more prevalent under coast conditions. The scab blight of the apple, the curl-leaf of the peach, and some other blights, are prevalent on the coast and in coast valleys, on the river bottoms in the interior, and on the mountains, and less serious, or wholly absent, in the hot interior valleys. Some insects prefer the coast, notably the black scale, which, with the black smut which attends it, has long been a greivous pest of growers of olives and citrus fruits, and

has recently become prevalent on deciduous fruit trees in some regions. Directly under coast influences, moss and lichens gather quickly, and should be removed. Spraying with alkaline washes not only kills insects but cleans the bark from parasitic vegetable growth. Although fruit trees on the coast are not so subject to sunburn as in the interior, there is especial value in low heading to withstand winds; there should also be plenty of room given the trees, that sunshine may have free access to warm the ground all around the tree.

VALLEY CLIMATE.

The characteristics of the interior valley climate are higher summer and lower winter temperatures than on the coast, the range of temperature being very nearly the same both north and south; rainfall abundant in the north and decreasing rapidly southward, so that as a rule the interior valleys in the south half of the State require irrigation; very dry air and almost constant sunshine, freedom from fogs and from dew in summer-time; winds occasionally strong, hot, and desiccating in summer and cold in winter.

Local Modifications.—The term "valley climate" is broad, and includes everything, from the coast to a certain elevation on the slope of the mountains. Certain small valleys protected from cold northerly winds and from fog-bearing westerly winds and open to the spring sunshine, have a forcing climate which produces the earliest maturing fruit of the season; earlier not only than the coast and the mountain but also somewhat earlier than adjacent locations in the broad, open valley. Slight elevation, even on the sides of small valleys, frequently secures freedom from winter frosts and ministers to early ripening. Elevation above sea-level on the rims of great valleys also secures similar results and gives rise to thermal belts in which semitropical fruits are successfully growing even as far north as Shasta County. On the floors of great valleys moderating influences are secured on the lee side of wide rivers and by planting on the river bank or on slightly elevated swells rather than on the level, open plain. The river bottom lands of the great valleys, though subject to severe frosts, are freer from the effects of desiccating winds than the open plains; they are, however, more favorable to the spread of certain blights than the plains are.

Some of the horticultural effects of valley conditions are as follows: Early ripening and perfection of summer and autumn fruits, owing to continual sunshine and dry air; forced maturity of certain late fruits, as apples and pears, which destroys character and keeping quality; injury from sunburn and hot winds

in summer, which seriously affect both fruit and foliage of some varieties; occasional injury to tender fruits (semitropicals) and to young trees of hardy fruits, which have been kept growing late in the season, from low temperature, which sometimes is reached suddenly on the floor of the valleys; freedom from some blights and insects which are prevalent on the coast, but not from others. Many of these minor troubles are, however, counterbalanced by the earliness, size, beauty, and quality of certain fruits, and by the most rapid and successful open-air drying of fruits, owing to high autumn temperature, the freedom from fog, dew, and generally from rain during the drying season.

FOOT-HILL CLIMATE.

Foot-hill climate is usually considered as a modification of valley climate. It has been shown that up to about two thousand five hundred feet, on the western slope of the Sierra Nevada, the seasonal temperatures are quite like those of the valley, but the rainfall increases about one inch for each hundred feet of elevation. There are, however, in the foot-hills, places where early spring heat and freedom from frost give very early ripening fruits, and other places at the same elevation where winter temperature drops below the valley minimum, and where late frosts also prevail. This is governed by local topography. In many of the small valleys among the foot-hills, bordering upon the great central valley of the State, and in the Coast Range as well, frosts are more severe than on the hills adjacent. The portions of these highland valleys most affected are usually the very lowest, the moist lands of the creek bottoms, or the wet swales, where there are such. Growths on the black or dark-colored soils, which are so situated as to be well drained and warm, are liable to frost, while those on the red lands and those of a chalky or ashen hue escape. The direct rays of the sun upon the darker earth hasten the spring growth beyond that on soil of lighter color. Hence if, other causes combining, there comes a frost, the earlier vegetation of the dark land suffers more than adjoining lands of a different description. These sudden changes to either extreme occur on the low grounds of the foot-hills to a far greater extent than upon the surrounding hills and ridges, or in the broad valleys of the Sacramento and San Joaquin.

Of course the disposition of cold air to settle in low places and to flow down cañons and creek-beds while the warm air rises and bathes the adjacent hillsides, has much to do with the frost in the hollow and the freedom from it on the hills, irrespective of color or character of soil. The constant motion of the air on the slopes is also a preventive of frost, providing the gen-

eral temperature is not too low. It is not uncommon to find in deeper valleys, protected against the western wind, flecks of snow and a wintry chill, with dormant vegetation, while one thousand feet higher up the foliage is fast developing.

MOUNTAIN CLIMATE.

Above an elevation of two thousand five hundred to three thousand feet, conditions gradually intrude which resemble those of wintry climates. The tender fruits, the apricot, peach, etc., become liable to winter injury and give irregular returns, or, as greater elevation is attained, become wholly untrustworthy. Early blooming of these fruits during warm spells which are followed by severe frosts, renders the trees unfruitful. At four thousand to four thousand five hundred feet the hardy apple and pear flourish, ripening late, and winter varieties possessing excellent keeping qualities. Here, however, winter killing of trees begins and locations even for hardy fruits have to be chosen with circumspection.

There are elevated tracts of large extent among the Sierras, where the common wild plum, the choke-cherry, gooseberry, and California chestnut are produced abundantly. April frosts have killed the fruit of those same plums, transplanted to lower ground, while those left growing in their natural situation were quite unharmed. It has been observed that these plum trees, with other fruits and nuts in their original positions, invariably occupy the broad tops of the great ridges instead of the sides and bottoms of ravines or narrow, pent-up valleys. Follow nature in the choice of orchard sites (with due regard to a supply of moisture in the soil, either natural or artificial) and little hazard attends the culture of the hardier fruits of our latitude among the highlands of the State than is incident to other seemingly more favored localities. The beauty and quality of these mountain fruits are proverbial.

A RULE OF GENERAL APPLICATION.

What has been thus suggested of the great variation of temperature conditions within narrow limits should lead to the conclusion that not only must the kind of fruit to plant be determined by local observation and experience but often varieties of these fruits must be chosen with reference to adaptation to local environment. For this reason it is impossible to compile tables of varieties suited for wide areas—and yet it is true that some varieties have shown themselves hardy and satisfactory under all conditions. These facts will be shown by the discussion which will be given to each of the different fruits.

REST AND ACTIVITY OF FRUIT TREES.

Indication has already been made of regions adapted to the growth of early and of late fruits. There is, of course, difference in the time of rest and of returning activity in blooming. On the mountains under wintry conditions the trees leaf out and bloom late, following more or less the habit of Eastern trees. In the foot-hills, the valleys, and the coast, there is less difference in time of rest and of leaf and bloom. Even in regions where there may be a month's difference in ripening of fruit, as, for example, in the Vacaville district, fifty miles inland, and in Berkeley, two miles from the bay shore, trees bloom almost at the same date. The difference in ripening is due to the higher temperature and fuller sunshine of the interior situation, which have a forcing effect, while the low temperature and dull skies of the summer on the coast retard maturity.

The rest of the tree, in all save the mountain district, is not dependent upon the touch of frost. It comes rather from thirst than from cold. The immense weight of fruit, the vigorous growth of wood, and the exhaustion of moisture from the soil by the draught of the roots to compass this growth, are the chief causes which bring the sere and yellow leaf in California. It is not frost, for the petunias may be blooming and the tomato vines still green in the fields. But the time has come for a rest. The trees sleep; but it is merely as a nap at midday; the early rains wake them soon. The roots are active first, then the buds swell, and the blossoms burst forth—sometimes as early as January—the almond first heralding the advent of California spring-time.

Sometimes this season of rest is too short for the good of the tree or vine. The early rains, when followed by a spring-like temperature, as sometimes happens, induce activity in the top as well as the root, and the tree is not in condition to withstand cold weather, which may follow. It is probable that such stimulated activity, suddenly checked, is responsible for more ills to tree and vine than are usually attributed to it.

CHAPTER II.

WHY THE CALIFORNIA CLIMATE SPECIALLY FAVORS THE GROWTH OF FRUIT.

It was pointed out by the earliest students of meteorology, as related to horticulture, that perfect development of fruits depends upon certain atmospheric conditions, which are included in the term climate: First, temperature; second, light; third, humidity or atmospheric moisture,—considered wholly apart from soil moisture. It was also shown that temperature and humidity should be equable, or as free as possible from excessive extremes or rapid changes.

Obviously, the chief characteristics of the California climate are: First, freedom from extremes of low temperature; second, an abundance of sunshine; and third, an atmosphere with a low percentage of humidity. It will be interesting to introduce enough statistics to demonstrate these claims, and to cite reasons why these conditions are of special value to the fruit grower.

THE OFFICE OF HEAT IN FRUIT PRODUCTION.

Temperature conditions may preclude the success of a fruit tree either by destroying it outright, by dwarfing it, or by preventing it from ripening its fruit. Extremes of temperature accomplish the death of plants, and insufficient or excessive mean temperatures may prevent fruition without killing the plant. The first quality of the California climate to arrest the attention of fruit growers in the States east of the Rocky Mountains is the freedom from the effects of extremely low winter temperatures, to which is due the deplorable failure, in the eastern and western States, of many of the fruit varieties from the west of Europe, and to escape which such zealous effort is now being put forth to secure hardy varieties of native and foreign origin.

How slight is the injury from low temperatures in all parts of the State where fruit is largely grown may be seen from the following compilation of extreme low temperatures at different points approximately at the same latitude on the coast, in the interior valleys, and on the foot-hills.

LOWEST TEMPERATURE AT SEVERAL CALIFORNIA POINTS.

Coast and Coast Valleys.	Degrees Above Zero.	Interior Valleys.	Degrees Above Zero.	Foot-hills.	Degrees Above Zero.
Eureka	20	Redding.....	18
Cape Mendocino....	28	Red Bluff.....	16
Hydesville.....	24	Oroville.....	20
Napa.....	20	Marysville.....	20	Colfax.....	16
San Francisco.....	28	Sacramento.....	19	Auburn.....	12
San Jose.....	22	Merced.....	20
Gilroy.....	20	Fresno.....	18
San Miguel.....	17	Tulare City.....	14	Lewis Valley.....	22
Los Angeles.....	28	Colton.....	22
San Diego.. ..	32	Poway.....	21	Fall Brook.....	27

These records will show anyone familiar with winter killing of the leading orchard fruits that such disasters are not to be feared in the chief fruit regions of California. Local temperature is largely controlled by local conditions, as has been already pointed out, and in the districts named in the table there are special locations where the lowest temperature probably differed a few degrees from the figures given.

NECESSITY OF ADEQUATE SUMMER HEAT.

Passing beyond the freedom from winter killing, it may be remarked that the influence of certain degrees of heat upon the growth of the plant and the perfection of its fruit, has been the subject of much close observation. Boussingault conducted careful experiments, and showed that a temperature above a certain minimum of heat is found necessary for germination, another for chemical modification, and a third for flowering, a fourth for the ripening of seeds, a fifth for the elaboration of the saccharine juices, and a sixth for the development of aroma or bouquet.

Originally the mean annual temperature was alone observed, and the polar limits of plants, it was presumed, could be thereby determined. More recently it was taught that the mean temperature of seasons is of more importance than that of the year, and it is believed that to the relative distribution of heat over the seasons rather than to the absolute amount received during the year, we are to attribute the fitness or unfitness of a region for the growth of certain kinds of vegetation.

It is held in Europe that the mean heat of the cycle of vegetation of the vine must be at least 59° Fahr., and that of the summer from 65° to 66° Fahr. It is stated to be impossible, for instance, to cultivate the vine upon the temperate table-

lands of South America, where they enjoy a mean temperature of 62.6° to 66.2° Fahr., because these climates are characterized by a constancy of temperature, never rising to the higher heats necessary to the process of sugar forming, and the vine grows, and flourishes, but the grapes never become thoroughly ripe. Boussingault shows that, in addition to a summer and autumn sufficiently hot, it is indispensable that at a given period—that which follows the appearance of the seeds—there should be a month the mean temperature of which does not fall below 66.2° Fahr. As will appear presently, this temperature test should not be taken alone, but it will serve as a standard to show one feature of the horticultural adaptation of the California climate. Boussingault claims the need of 66.2° Fahr. for a single month. To be sure to include this, the following table gives the average summer temperature at the leading fruit-growing centers named:—

AVERAGE SUMMER TEMPERATURE AT VARIOUS CALIFORNIA POINTS.

Coast and Coast Valleys.	Deg. Fahr.	Interior Valleys.	Deg. Fahr.	Foot-hills.	Elevation.	Deg. Fahr.
Upper Lake.....	86.9	Redding.....	81	Auburn.....	1,363	74.6
Napa	69.6	Oroville.....	79	Colfax.....	2,421	76
Livermore.....	70.8	Marysville.....	78	Georgetown....	2,500	85
San Jose.....	66.2	Sacramento.....	71.7	Caliente.....	1,290	82.8
Hollister	67.1	Merced	78.4	Fall Brook.....	700	68.2
Santa Barbara..	65.9	Fresno	84.1
Los Angeles.....	69.7	Tulare.....	83.4
San Diego.....	68.4	Riverside.....	73.7

These points are selected because the European varieties of the grape reach perfection in the vicinity. Boussingault's measure of fitness would condemn points directly on the coast where the summer temperature is approximately that of San Francisco (59.4°), and it has been found by experience that such a summer temperature really does not favor the ripening of the grape, although early varieties may mature in sheltered places. The excess of heat above that required, as is found at all the interior points mentioned in the table, results in a very high sugar percentage in the grapes, and contributes to the ripening of a second and third crop, as will be noted presently. The superior length of the growing season in California, of course, is an important agency toward the same end.

DIRECT SUNLIGHT ALSO A REQUISITE.

Count de Gasparin was first to point out that not alone sufficient heat but abundance of continuous sunshine is a requi-

site of perfection in fruit growth and ripening, and on his authority may be based a claim of exceptional value to the fruit grower in the months of cloudless skies which are characteristic of the California summer.

"The solar rays," says Gasparin, "do not only produce heat but bring us light, and the effects of the heat and light rays differ in a very pronounced manner. Without light there is no fructification; it is not necessary that the want of light should be complete that there should be a failure of fruits. In fact, diffused light alone does not suffice for the greater number of plants; cultivated plants will not ripen their seed without the direct rays of the sun, and the longer they are deprived of it the smaller the quantity which they will mature."*

Again, referring to the grape, for in connection with the growth of this fruit the most careful researches have been made, Humboldt wrote: "If to give a potable wine the vine shuns the islands and nearly all seacoasts, even those of the West, the cause is not only in the moderate heat of summer upon the seashore, but it exists more in the difference which there is between direct and diffused light; between a clear sky, and one veiled with clouds."†

It is noticeable that at the California coast points the average cloudiness is almost twice that of the interior valleys, while at the East the interior fruit regions of western New York, Ohio, and Michigan, have a greater average cloudiness than the Hudson River, New Jersey, and Delaware regions near the Atlantic seaboard. The average cloudiness in the Eastern fruit regions is rather more than twice as great as in the regions of California where most fruit is grown.

This excess of advantage, as it may be termed, in connection with the high and protracted heat already mentioned, takes practical form in the successful ripening of a second and sometimes a third crop of these grapes in a season, from later bloom on younger cane growth. Another indication of excess of advantage in the interior valley is found in the development of high sugar contents, which is of direct value in raisin production. The same tendency, though perhaps of less commercial value, is seen in the fact that some grapes which yield a good claret wine nearer the coast develop too much alcohol when grown in the interior.

The advantage of California over Eastern and Southern fruit regions in the abundance of clear sunshine is shown by the records of the United States Weather Bureau in the following table.

* Cours d'Agriculture, t. II, p. 96.

† Cosmos, t. I, p. 349.

Cloudiness is rated from 0 to 10, three observations daily, and the figures in the table are the averages from these daily observations for a series of years:—

NORMAL CLOUDINESS AT CALIFORNIA AND EASTERN POINTS FOR NINETEEN YEARS (1870-98), FROM THE RECORDS OF THE U. S. WEATHER BUREAU.

CALIFORNIA.	March.	April.	May.	June.	July.	Aug.	Sept.	Oct.	Nov.	Average 9 Months.
Red Bluff.....	4.4	4.2	3.6	1.9	1.0	0.7	1.3	2.4	3.4	2.5
Sacramento.....	3.9	3.5	2.7	1.5	0.5	0.4	1.1	2.0	2.8	2.0
San Francisco.....	4.8	4.3	4.2	3.8	4.3	4.3	3.5	3.3	3.8	4.0
Fresno.....	4.3	2.9	2.7	1.5	0.7	0.9	1.4	2.2	2.8	2.1
San Diego.....	4.8	4.4	5.3	4.8	4.3	3.9	3.7	3.8	3.3	4.2
EASTERN.										
Rochester, N. Y..	6.6	5.4	5.2	4.9	4.6	4.6	4.9	6.0	7.6	5.5
New York, N. Y.	5.5	5.3	5.2	4.9	5.0	4.9	4.7	4.9	5.2	5.0
Philadelphia, Pa.	5.6	5.4	5.1	5.0	5.0	4.9	4.8	4.7	5.2	5.0
Baltimore, Md....	5.4	5.1	5.1	4.9	4.8	4.9	4.7	4.6	4.9	4.9
Cleveland, Ohio..	6.4	5.3	4.9	4.6	4.3	4.3	4.9	5.7	7.3	5.3
Grand Haven, M.	6.2	5.4	4.8	4.6	3.8	4.0	4.4	5.6	7.5	5.1
Jacksonville, Fla.	4.2	4.1	4.1	5.1	4.8	4.9	5.0	4.2	4.5	4.5
New Orleans, La.	4.8	4.8	4.3	4.7	4.9	4.7	4.3	3.5	4.5	4.5

RELATION OF ATMOSPHERIC HUMIDITY TO THE GROWTH
OF TREES.

There is another important condition of the climate of California which is intimately related to those which have been considered, and which is to be credited with no small influence in the perfection of our fruits, and that is the low percentage of humidity which our atmosphere contains. In California the percentage of humidity is high in the winter and low in the summer; in the East the condition is just reversed. For this reason summer heat is far more oppressive in the East than in California, and for the same reason certain serious fungoid diseases which prevail at the East, though found here in less injurious degree directly on the coast, are wholly unknown in the interior where the air is drier. The dry air also favors the access and action of light and heat, for Tyndall says that a sheet of vapor acts as a screen to the earth, being in a great measure impervious to heat.

It is not necessary then that there should be clouds to lessen the chemical effects of sun heat in fruit ripening. Not only do clouds intercept sunshine, but watery vapor in the air—when to the eye the sun is bright as ever—can absorb a large quantity of

the effective sun rays, and so retard fruit ripening. Hence an apparently sunny country which has much invisible watery vapor in the air, may prove defective in fruit-ripening qualities.

It is true that air free from humidity allows rapid escape of heat by radiation as well as free access of it, and in dry air frost is more severe, but at the time of the greatest fruit growth, from June to October, radiation down to a frost point is prevented by other natural agencies. In the early spring and late autumn the humidity percentage rises again and checks radiation just at the time of the year when it is most desirable to have it checked.

The following table, compiled from the records of the United States Weather Bureau, shows the prevailing relative humidity in the East and South and in California:—

NORMAL RELATIVE HUMIDITY AT EASTERN AND CALIFORNIA POINTS, 1888 to 1896, FROM THE RECORDS OF THE U. S. WEATHER BUREAU.

EASTERN STATIONS.	April.	May.	June.	July.	Aug.	Sept.	Oct.	Nov.	Average Eight Months.
Jacksonville, Fla.	72.3	73.0	77.6	78.6	80.9	82.9	79.8	82.2	78.3
Philadelphia, Pa.	63.4	68.9	69.2	68.6	71.2	75.2	70.7	73.6	70.1
Rochester, N. Y.	67.8	68.6	69.1	67.3	70.7	75.2	75.6	76.2	71.3
Grand Haven, M.	70.9	71.4	73.7	69.0	73.1	75.0	75.7	79.1	73.5
St. Louis, Mo	63.7	67.8	68.8	66.3	67.3	70.2	65.9	71.1	67.6
New Orleans, La.	76.0	74.2	78.1	78.3	78.8	77.3	74.0	79.4	78.0
Galveston, Tex...	84.6	78.0	79.3	77.4	78.1	77.2	75.6	80.4	78.5
CALIFORNIA STATIONS.									
Los Angeles.....	73.1	75.2	73.0	75.4	76.2	72.9	74.3	66.6	73.3
Fresno	59.3	52.7	42.4	34.7	34.7	43.6	55.1	64.1	48.3
Sacramento.....	67.6	67.6	66.1	59.8	59.8	59.0	62.4	66.8	63.6
Red Bluff.....	61.9	56.8	43.7	35.6	35.3	43.6	51.6	60.7	48.8

THE THREE POINTS COMBINED.

The three great advantages of the California climate,—abundant heat, continuous sunshine, and dry air,—taken in connection with the fitness of the soil and the great length of the growing season, insure the characteristic excellence of California fruit, and the early maturity, great growth, and abundant fruitage of our trees and vines. Heat, sunshine, dry air, and a rainless summer also minister directly to the curing of fruits in the open air. All things considered, it is doubtful whether any area of the world excels California in possession of natural adaptation to fruit production and preservation.

A RECAPITULATION OF CALIFORNIA'S CLIMATIC ENDOWMENT.

Through the multitude of local observations, which seem perplexing and almost contradictory, it is possible to clearly discern certain general conditions of both nature and culture, which may be briefly advanced as characteristically and distinctively Californian. Of these, perhaps the most striking is the length of the growing season.

Take, for instance, the peach in a good peach region. The bloom appears in February, followed by the grand foliage expanding to a leaf-size, marvelous to one unused to such peach leaves. The shoots of new growth rush out with vigor, promised by such a leaf, and yet the fruit below expands as though it would burst its skin in rapid enlargement—and still it grows. The new shoot, apparently weary of its several feet of extension, stops for a rest, and then, reviving, starts out its laterals—while still below the peach is growing. The laterals push out a foot or more—all carrying large, fresh leaves. While these are in full vigor, the fruit ripens, after having a full half-year's joint work of root and foliage, if it is a late variety. Is it any wonder it weighs a pound? But still the tree is active. It forms its terminal buds, and then all along the new main shoots and their laterals are formed the leaf and blossom buds for the following year. Still the foliage holds green and active, if the moisture below be adequate, and the leaves seem loth to fall in the ninth month from the time of blooming. Is it any wonder California peaches are large and the trees require pruning and thinning to enable them to carry the weight produced in such a season of growth? And what has been said of the peach is true of other trees, according to their nature and habits. The trees themselves are more eloquent of California's conditions for growth than descriptions or statistical tables can be made.

But the quality of the light and heat, if the term is admissible, is a factor as well as their duration. The air, free, not alone from clouds, but from the insensible aqueous vapor which weakens sunshine in its effort to serve vegetation in a humid climate, has a clearness and brilliance from its aridity which makes each day of the long, growing season more than a day in other climates, and thus adds to the calendar length of the growing season. The surplus light and heat also act directly in the chemistry which proceeds in the tissues of the plant, and we have not only size, but quality, color, aroma,—everything which makes the perfect fruit precious and beautiful beyond words.

It is true that for commercial purposes it is not possible to allow this process to go too far, for its later effects are higher sweetness, accompanied by such juiciness that the fruit cannot endure transportation. But go to the tree to apply the only test

which can be fairly put to a juicy fruit, and the demonstration of the service of clear, unobstructed sunshine through an adequate period is complete. But if this can not be done, place the judgment upon the mature peach carefully sun-dried and intelligently cooked, or upon the ripe peach skilfully canned, and the distinctive adaptations of California for fruit production will display themselves.

But there are other agencies involved in the perfection of fruit than intensity and duration of heat and light. Without adequate moisture in the soil, the air which we have credited with such benign power in carrying heat and light for perfection of fruit would transmit the same as agencies for the destruction of the tree which bears it. If this moisture comes from rainfall, it descends at the time of the year when the tree is least active, consequently is least retarded by a clouded sky and moisture-laden air, and least affected by atmospheric disturbances. Strong storm winds find the tree with reefed sails, and able to endure pressure which would tear it to pieces if they came upon its grand spread of foliage on branches heavy with fruit. It is a priceless horticultural endowment that no tornado can pierce our protecting mountain-barriers, and that it is exceedingly rare that our local winds disturb the confident swaying of the branches and leaf movement beyond the activity which ministers to the sap flow. And if the adequate moisture is not from rainstorm, but by irrigation, the same facts remain, for the water reaches the tree without interrupting its aerial activity. Temperature is maintained, light is unobstructed, and the tree is refreshed with moisture without the chill and darkness which favor fungoid parasites. Of all the ways by which moisture could come to soils supporting fruit tree or vine, the natural by its time, and the artificial by its method, endow California with the best.

The characteristics of the California climate which have been especially pointed out in this sketch are not propitious to fruit culture when they exist to excessive degree, as in some interior or continental climates. Local conditions of altitude, distance from the sea, and exposure to the sweep of arctic winds, induce sudden and great weather changes, which are serious in their effects. Excessively low percentage of atmospheric humidity, in connection with desiccating wind, often produce greater evaporation from the leaves than the roots can supply. Excessively dry air admits a parching sun heat at one time, and at another facilitates radiation of heat, until the rapid decline in temperature makes killing frosts frequent. It is evident that California has these agencies constantly held in check by her insular situation and protecting environment, and owes her wonderful adaptation to growth of tree and perfection of fruit not more to the possession of certain conditions than to the fact of their existence in moderation.

CHAPTER III.

THE FRUIT SOILS OF CALIFORNIA.

The favoring characteristics of the California climates, which have been described, find their fitting complement in the adaptation of the California soils to the perfect development of fruit-bearing tree and vine. In their wonderful variety and consequent great range of special adaptations within narrow limits of area, our soils also resemble our climates. As a man may sometimes find within the boundaries of an ordinary-sized farm such a difference of atmospheric conditions that the same fruit will thrive in one spot and not in another, so he may find differences in soil which will tend to produce the same results. For this reason the precise spot in which to plant any given fruit must be chosen with regard to both soil and exposure. In the chapters devoted to the several fruits, there will be an attempt made to describe the soil requirements of each, so that the inexperienced planter may not err seriously in choosing the location for each kind of fruit he desires to grow. While this is true, it will also appear in these special chapters that the choice of roots upon which to bud or graft gives the planter a certain latitude and independence. This is of greatest value in the planting of home orchards, or orchards for local markets, in regions where the soil is not what is usually preferred for fruit production. With proper choice of stocks and wisdom and diligence in cultivation, one need hardly despair of growing good fruit on any soil which will support any laudable plant growth. And yet in commercial orcharding, the secret of which is producing most abundantly and cheaply, too great attention can not be paid to choice of specially-adapted soils.

It is an interesting fact that more complete and exact knowledge exists of the soils of California than of any other State of the Union, and for this knowledge the public is indebted to E. W. Hilgard, Professor of Agriculture, and Director of the Agricultural Experiment Stations of the University of California. For the last twenty-five years he has given all the time he could spare from many other and pressing duties, to the examination, and, when needed, the analysis, of representative soil specimens, and to practical expositions of their nature, adaptations, and re-

quirements in the event of exhaustion from too long cropping. This information must be sought in a number of publications, and no condensed outline of the work in its present state is available. Professor Hilgard has now (1899) in preparation a general treatise entitled "Soils: Their Formation, Properties, Composition and Relations to Climate and Plant Growth," which will naturally include the results of his long study of California soils and climates. It is the purpose of the writer to undertake a compilation, from these sources, of information which especially relates to the fruit soils of California, now known and used as such. The plan will be to collate the descriptions of the soils and their composition with the practical deductions therefrom, rather than the detailed analyses, for which the reader must be referred to the original source.

DISTINCTIVE CHARACTERS OF CALIFORNIA SOILS.

One of the most interesting and important recent achievements in soil investigation consists in demonstrating distinctive differences between soils formed under arid and under humid climatic conditions.* In the development of this subject certain distinctive characters of California soils clearly appear and they are of direct relation to the thrift, productiveness, treatment and longevity of fruit trees. These characters are: (a) lightness and consequent permeability and ease of cultivation; (b) depth, admitting exceptional root extension and penetration; and (c) richness, containing some kinds of plant food in considerably greater amounts than are found in the soils of humid regions. These characteristics as demonstrated by Professor Hilgard may be outlined in this way with special reference to their relations to fruit growing.

Lightness.—California soils predominantly exhibit the sandy, silty or pulverulent nature of all soils formed under arid conditions, save in case of pre-existing clay formations of former geological epochs, as well as back-water deposits of the present epoch, all of which are substantially independent of climate. While "sand" in the humid regions means virtually quartz grains only, in the arid country it means very largely grains and powder of the other soil-forming minerals as well. While, therefore, in the humid region, sandy land as a rule means poor land, in the arid, on the contrary, sandy lands are at least as desirable as heavier ones, both on the score of high productiveness, durability and ease of cultivation, together with ready resistance to drouth.

Depth.—Another point of great importance is that the difference between soil and subsoil, which is so striking and im-

* Rep. Cal. Exper. Stations, 1893-4, p. 100.

portant in regions of abundant rainfall, is largely obliterated in arid climates. Very commonly hardly a perceptible change of tint or texture is found for depths of several feet; and what is more important, material from such depths, when thrown on the surface, oftentimes subserves the agricultural uses of a soil nearly or quite as well as the original surface soil. The unconcern with which irrigators proceed to level or otherwise grade their land, even though this may involve covering up large areas of surface soil with subsoil from several feet depth; the rapidity with which the red loam of the placer mines of the Sierra Nevada foot-hills is re-covered with the natural forest growth of the region, etc., are examples familiar to the residents but surprising to newcomers, who are accustomed to dread the upturning of the subsoil as likely to deprive them of remunerative crops for several years, until the "raw" subsoil has had time to be "vitalized" by the fallowing effect of the atmosphere, and to acquire the needful amount of humus or vegetable mold. Thus the surface soil, which in the humid regions supplies the bulk of the nourishment, becomes here of minor importance, serving chiefly as a mulch to prevent waste of moisture; while the active process of nutrition occurs in the deeper portion of the soil stratum, whose composition, as well as condition of disintegration and aeration, is substantially the same as above. The second foot is rarely found to differ materially from the first, even as to humus content; for the latter, being almost exclusively derived from the humification of roots, the leaves and herbage on the surface being mostly oxidized away under the intense heat of summer; it not uncommonly happens in very porous soils that the first six inches of surface soil are poorer in humus than the second foot.

Practical Results of Lightness and Depth.—The "lightness" and perviousness of the prevailing soils of the arid region permit of the penetration of roots to depths which in the humid region are inaccessible to them on account of the dense subsoils, which prevent the needful access of air. This deep penetration enables even annual plants to avail themselves directly of the stores of moisture in the substrata, at depths which in the humid region are scarcely reached save by the tap-roots of some perennials and trees; while the latter themselves reach depths never approached by them in the region of summer rains. Professor Hilgard has personally found the ends of the roots of grape-vines at a depth of twenty-three feet, in a gravelly clay-loam; and from ten to fifteen feet are ordinary depths reached by the root system of fruit trees. Such depth of rooting, when conservation of moisture is secured by proper surface cultivation, enables deciduous fruit trees to grow thriftily and bear fine fruit through six months of drouth while as many weeks of drouth may bring

distress and loss of fruit to surface-rooting trees on the shallow soils of the humid region.

Richness.—The foregoing conditions are rendered the more significant and effective through the third characteristic of soils formed in arid climates. The average aggregate amounts of plant-food ingredients are markedly greater in the arid than in the humid soils, wherever their derivation is at all generalized. Among the agriculturally important ingredients contained in larger average amounts in the arid soils than in the humid, lime stands foremost; its percentage in soils not derived from calcareous formations being from twelve to fourteen times greater in the arid than in the humid soils. Magnesia follows lime in this respect, but the average difference is only about half as great. The average content of potash in the arid soils exceeds that in the humid in about the proportion of one to three or four. But no such constant difference exists in respect to phosphoric acid. As regards humus, and the nitrogen of which it is the carrier and reservoir, its amount is usually considerably less than in the humid soils; but the total nitrogen percentage does not differ widely, because the humus of arid soils contains, on the average, from three to five times as much nitrogen as is found in the humus of humid soils, and therefore, the supply of soil nitrogen is very nearly the same in both regions, while from several causes, the humus-nitrogen of arid soils is more available to plants.

CLASSIFICATION OF CALIFORNIA SOILS.

Any attempt to classify the soils of California upon scientific lines or even to describe them in their wonderful variety, according to their geographical occurrence, would lead beyond the limitations of a treatise upon the practise of fruit growing. Rather let an attempt be made to designate certain grades of soil with brief characterization of their leading features as they are related to the growth of fruits. By such a course it may be made to appear that though the soils of the State are predominantly light, deep, and rich and thus eminently fitted for fruit growing, there are many degrees in the possession of these characters or any of them, in local soils, and upon this individual manifestation they rate all the way from perfection to defectiveness. Let a classification proceed then upon a descending scale.

Light, Deep Loams.—Admixture of clay with enough coarse materials to secure permeability to air and water, ease in cultivation, deep root penetration and free drainage of surplus water, produces soil of the highest adaptability to the growth of fruit trees and vines. These soils are popularly known as loams. They are designated as sandy loams, medium loams and clay

loams, according to the proportion of clay commingled with the sand or coarse materials.

Professor Hilgard has devised the following nomenclature of soils based upon their content of clay: Sandy soils, less than five per cent of clay; sandy loams, from five to ten per cent; ordinary or medium loams, from ten to fifteen per cent; clay loams, from fifteen to twenty per cent; clay soils, from twenty to fifty per cent of clay.

The coarse materials are sand grains of various sizes or rock particles in various degrees of disintegration. The fine materials are clay and rock powder, commonly designated as fine silt. Loam soils may result from deposits by flowing water or may consist of debris but little removed from local rock disintegration. They include a wide variety of materials but agree in the possession of striking adaptability to fruit culture. Some of the leading instances of such soils may be cited.

Loams of the Valley Plains.—On the east side of the Sacramento Valley low ridges and swales at right angles to the river's course come in from the foot-hills, forming a gently undulating plain with a fall of from fifteen to twenty feet per mile, sometimes right up to the river channels. Nearly all the soils of the east side have a reddish tinge, showing the admixture of the red foot-hill soil, and demonstrating, by the way, that all these lands are well drained. In cuts ten to twelve feet deep, made by the sloughs, the reddish plains loam is seen to reach from six to ten feet depth, being then underlaid by gravelly substrata. The width of this class of profusely fertile valley land, east and west, varies considerably, according to the meanderings of the rivers. Away from the water courses, the higher lands of the valleys are largely red or yellow loams, sometimes clayey and difficult of cultivation unless taken just in the right condition, sometimes gravelly and apt to dry out unless the natural water supply is supplemented by irrigation, but mostly a free-working, fairly retentive, light loam, very satisfactory for some kinds of fruit.

The soils of the San Joaquin Valley have, as a rule, a much greater admixture of sand than those of the Sacramento Valley; there is also a more distinct subdivision of the valley lands into upland or "bench" lands, and lowland or alluvial lands proper.

Upon the upland or plains soils, especially of Fresno and Tulare Counties, wonderful progress in fruit-growing by irrigation has been made during the last few years. Though its summer aspect is most forbidding and almost desert-like in lack of vegetation, the application of water has shown exceptional quickness of growth, early bearing, and lavish productiveness of tree and vine. These plains loams vary in appearance, and are from this fact locally named, "reddish loam," "white ash," and

"sand hill." All are distinctly calcareous. Even in the case of the latter, which is the lightest and is made of almost ninety per cent of inert sand, it is so deep and has its plant food in such highly available condition that it is producing very large crops of fruits where there is no rise of the bottom water to prevent root penetration. In the foot-hills of the Sierra Nevada there are some loose loams of light color resulting from the decomposition of granite, but they are as a rule inferior to the red foot-hill soils, which are more clayey, and will be mentioned among the clay loams later.

The soils prevailing in the valley of southern California, from Redlands at its head to Los Angeles at its opening out toward the sea, consist chiefly of granitic sand, which at some points on the slopes forms the soils exclusively, but everywhere constitutes a prominent ingredient of the valley and mesa lands. These mesa lands are conspicuous for their orange-red tint, and the red sandy loam of which they are composed, to depths varying from ten to as much as eighty feet, is evidently the choice soil for orange culture. It is manifest that at some remote epoch it filled the entire valley. Of the middle portion much has been washed away, but islands of it form red-land tracts of greater or less extent all over the region, traversed by and more or less commingled with, the granitic wash from the valleys and cañons of the Sierra Madre. The latter frequently consists largely of gravel, and were it not for the luxuriant natural vegetation borne by these gravel beds, few would have thought of devoting them to the costly experiment of orange planting, which, nevertheless, has proved eminently successful even on these unpromising-looking masses of debris. In the upper valley (San Bernardino Valley proper) the red loam is conspicuous, and gives its name to the flourishing settlement of Redlands, on the terminal slope; but the heavy flow of water from the upper cañons, notably from that of the Santa Ana River, has scoured it out of the valley itself, and left there, at least on the northern portion, gray and blackish granitic loams of great depth and productiveness, underlaid, and therefore underdrained, by the enormous gravel beds that hold the artesian water of this favored region.

The reddish mesa soils prevail through the smaller southern California valleys as well, and are similar in character, as they are derived from similar geological formations.

Where the surface descends gradually to the seashore, and not in bluffs, there are, as in Los Angeles and Orange Counties, coast flats several miles in width, where the soil is a dark-colored sandy loam, glistening with scales of mica, and more or less affected with alkali in the lower portions. Similar soils are found in tracts of greater or less extent up the coast as far as

PRUNE ON PEACH ROOT NEAR NILES: SHOWING DEEP ROOTING OF CALIFORNIA TREES.—(See page 27.)



Santa Barbara at least. As a rule, these seashore lands are very productive, but fruits for them must be chosen with reference to their low level and exposure to coast influences.

The light loams of the so-called desert region of southern California are not inferior in productive capacity to some of the best soils of the great valley, which it greatly resembles, save in the scarcity of humus, or vegetable matter. Only a detailed survey, however, can determine the tracts having an arable soil, as against those overrun by arid sand. The soil of the Colorado River bottom is highly productive, easily worked, being quite light. It is a highly calcareous soil, and is likely, whenever the water of the Colorado River shall be made available for irrigation, to yield rich returns for cultivation.

The valleys of the seaward slope of the Coast Range have mostly gray, light, and silty, rather than sandy soils, quite similar in appearance from Ventura to Humboldt County, though differing considerably in composition, those of the southern region being more calcareous, and apparently richer in phosphoric acid; as the coast region consists for the most part of low ranges with intervening valleys, the valleys are, as a rule, small, though a few show considerable area. In such a country the soil surface shows wide diversity within smaller areas than on the vast stretches of the great interior valley; consequently, so far as soil goes, the coast farms are often suited to a wider range of fruits than the interior valley farms of similar size.

ALLUVIAL OR SEDIMENTARY LOAMS.

These soils have been considered from the earliest plantings by Americans as par excellence the fruit soils of the great valley of central and northern California. They occur along the courses of existing streams, and extend back to variable distances, until they merge into the valley loams, or adobes. These deposits are considerably higher than the present beds of the streams, and are sometimes described as "next to river bottom." They consist of fine alluvium, with seldom any admixture of coarse materials. These river soils are usually very deep, and they are naturally well drained.

These deposits cross the valley in somewhat irregular courses; they are of greater or less width according to the drainage area whence they have come. They vary also in depth, and taper down on either side to the level of the red loam or adobe upon which they have been deposited. Such strips are first chosen by the fruit planters of the district in which they occur. In the valleys of the rivers crossing the eastern side of the San Joaquin Valley, there are, bordering the streams as well as Tulare Lake, considerable areas of brown to blackish

loam varying from heavy to light, but for the most part easily tilled and exceedingly rich. Considerable fruit has been grown for years on these situations, and some kinds do well on these bottoms which do not show adaptation to the plains. Some even of the higher lying portions of these "black lands" support thrifty orchards without irrigation. The wider stretches of alluvial soils in the upper part of the valley, as in the Mussel Slough country and the Visalia region, for instance, are notably well adapted to fruit growing. The occasional intrusion of alkali, which must be carefully avoided, is the chief obstacle to the general approval of these alluvial lands for fruit purposes.

Soil of similar character is found in some small valleys consisting of an alluvial wash from the bordering hills which in some places reaches a depth of thirty feet or more without notable change in character. Such soils have proved very fertile and durable.

In the coast valleys of the State there are also very extensive areas of alluvial soils which are largely used in fruit production, as well as upland loams formed in place by the disintegration of local rock formations. The famous fruit region extending from Oakland southward nearly one hundred miles, including the Alameda and Santa Clara Valleys, has very large areas of alluvial soil, ranging from deep, rich blackish loams used for vegetables and small fruits, to lighter loams resulting from intermixture of sediment brought by streams from adjacent hillsides with the clay of the valley bottom. It is to these deep, rich alluvial deposits that the region owes its great reputation in fruit lines.

Below the "river banks" sedimentary soils, which is another name for the soils previously considered, lies the rich river bottom, adjacent to the beds of the main rivers and sloughs of the valley. It is usually a dark, rich, and moist soil, easily tilled and not subject to baking and cracking. It is largely used for the growth of vegetables and alfalfa, but considerable areas have been planted with fruit trees, especially with pears, which do not suffer from submergence of their roots for considerable time.

CLAY LOAMS.

Of loams containing sufficient clay to render them somewhat heavy and tenacious, there is also a great variety in California. Their suitability for different fruits depends upon selection of roots adapted to their character and upon the depth and degree of retentiveness of the soils themselves. They are more difficult of tillage than the free loams, but offer some compensation therefor in their richness and durability.

Clay Loams of the Foot-hills and Valley Border.—The soils of the foot-hills of the Sierra Nevada, throughout its course along the great valley, vary from a moderately clayey loam to a heavy, though not uncommonly gravelly, often orange-red clay. This character seems to be sensibly the same, whether the soil be derived from the decomposition of the ancient slate bed-rock or directly from the dark-colored granites, thus creating a presumption that the two rocks are closely related. The soils are highly charged with iron to the extent of from seven to over twelve per cent, which being finely divided, imparts to them the intense orange-red tint. The soils of the foot-hills agree with the soils of the valley in having a good percentage of lime, while the supply of potash and phosphates, as well as of organic matter, is smaller, and sometimes low, though never apparently inadequate for present productiveness, in the presence of so much lime.

Along the base of the foot-hills of the Sierra there is in Fresno, Tulare, and part of Kern County, a belt of reddish or brown loam soils, corresponding to those similarly located in the Sacramento Valley, but generally more clayey, and hence frequently designated as adobe by contrast with the very sandy soils of the valley at large, although properly they should be classed simply as clayey loams. This belt is eight to ten miles wide in middle Tulare County, and narrows to the north and south. Here these lands have a gentle slope of ten to twenty feet per mile from the base of the foot-hills, and appear to be underlaid at a depth of twelve to fifteen feet by water-bearing gravel. The soil is a reddish, more or less sandy, loam, changing little in its aspect for several feet. Its adaptation to fruit is shown by the products of the Porterville region.

CLAY SOILS.

Thus far a very small area of true adobe* soil has been employed in horticulture. There is a great difference in the character of what is known as adobe in different localities. Its color varies, as the popular terms "black waxy," "black," "brown," and "gray" adobe indicate. Its physical condition and chemical composition also vary greatly. The black adobe of the east side of the Sacramento Valley is easily tilled as compared with the gray adobe on the west side, which is very refractory and often largely impregnated with alkali. To render soil of adobe character useful for fruit growing, this tendency to dry out and crack, thus allowing evaporation from below as well as

* This name has been erroneously applied to the loam commonly used in the construction of adobe houses. Agriculturally, it means "a heavy clay soil," such as could not be used in building.

from the surface, must be overcome. The discussion of this point belongs to the chapter on "Cultivation." Adobe soils are, as a rule, rich and durable and therefore promise long fruitfulness to trees and vines with roots adapted to heavy soils, but difficulty of cultivation, excessive retention of water, and other evils are always present. Some suggestions on the treatment of such soils will be given in the chapter on fertilization.

DEFECTIVE SOILS.

Although California soils are predominantly of the depth, lightness and richness best suited to the growth and bearing of fruit trees and vines, it should always be borne in mind that there are marked exceptions, and failure to observe this fact has resulted in considerable disappointment and loss. There is in California much land which is bad from a horticultural point of view and it is apt to occur even in the vicinity of lands of the highest excellence. It is, therefore, necessary to advise that the closest examination be made before investment be made in the planting of fruits.

Although there are instances of deficiency in plant food in California soils and considerable areas of land sterile through excess of saline and alkaline salts, these are usually indicated by the local reputation of the tracts, if the newcomer will take pains to make inquiry. It is rather the more obscure, subsoil conditions which lead to loss or failure, and they may be unknown even to men who have owned or farmed the land for years for ordinary field crops. These defects are, in the main, three:—

Hard-pan.—Good loams may be underlaid near the surface by hard-pan or by layers of heavy clay. These prevent root penetration; they also limit moisture reception to the shallow surface layer, which is apt to become water-logged for lack of drainage during the rainy season or by excessive irrigation, and to quickly lose its moisture by surface evaporation in the dry season, with no compensation from the tight layer below. In such a situation, then, the plant may suffer severely from excess of water at one time of the year and lack of it at another. Such lands may serve well for some of the small fruits, but not for trees or vines. Under certain circumstances the defects of these soils may be corrected, as will be suggested in the chapter on preparing lands for planting.

Leachy Sub-soils.—Good loams are also occasionally underlaid by layers of coarse sand or gravel, through which water flows away beyond the reach of roots which will only make measured progress through such materials. Trees in such situations are apt to come into distress in the dry season and can only be comforted by frequency and volume of irrigation and

fertilization, which are out of proportion to the returns they are able to make.

Rise of Ground Water.—Good fruit lands are also occasionally rendered defective by the rise of the ground water toward the surface so that only a shallow layer is left for root extension—the evil being aggravated by the fact that a temporary fall of the ground water induces deeper rooting, which a subsequent rise of the water destroys, and decay of the roots ensues. This trouble has occurred over large areas where excessive irrigation, or the course of leaky ditches, on higher lands, has filled the lower levels to such an extent that there is actual outcropping of swamps in the swales. The cure for these conditions is, obviously, drainage, which it is not always possible to secure at a warranted outlay.

Alkali.—Connected with this rise of the ground water the alkali evil may intrude. But little trouble arises from this cause in the high-lying, sandy tracts, where irrigation or the natural rainfall carries the soluble salts annually into the country drainage; but in the low-lying and less pervious soils of swales and valley troughs, which are at the same time intrinsically the richest in available mineral plant food, the accumulation frequently causes considerable trouble and difficulty.*

Prospecting for Soil Defects.—The University Experiment Station at Berkeley, undertakes to advise planters concerning the character of the land they propose to use. For subterranean prospecting, Professor Hilgard commends a steel rod not less than a quarter of an inch in diameter (round or square, preferably the latter), well pointed at one end, and provided at the other with a stout iron ring for the reception of a stout cross-handle, such as is used for post-hole augers. With such a prod, or sounding-rod, not less than five feet in length, the exploration of the subsoil for hard-pan or dense clay layers becomes a matter of a few minutes. It is easy also to detect thus the presence of underlying layers of quicksand, gravel, or other loose materials through which irrigation water would waste, or which would prevent the rise of bottom water within the reach of plant roots, by the large interspaces between their grains. Any remaining doubts as to the nature of such underlying materials at particular points can then quickly be solved by the use of a post-hole auger or by digging, as thorough inspection and the taking of samples for each foot of depth may be found desirable.

* University publications on alkaline soils and their treatment may be had by application to Agricultural Experiment Station, Berkeley.

CHAPTER IV.

THE WILD FRUITS OF CALIFORNIA.

The wild fruits of California are numerous, and for the most part peculiar to the region, being either of local genera or local species of more widely distributed genera. Very few are identical with the wild fruits common to great areas of the continent. For this reason our wild fruits constitute a very interesting subject for botanical study, and they are now, perhaps more widely than ever before, attracting the attention of botanical pomologists. Viewed from the standpoint of practical pomology or horticulture, our wild fruits can not be claimed, on the whole, to have attained any very great importance.

A few fruits, as will be noted further on, have demonstrated their culinary or household value, and are locally sought for, but none have any notable commercial value. This may be due to the fact that some of our most delicious wild fruits are very exacting in their choice of conditions, and can not be moved far, even within the limits of our own State, and presumably would not take kindly to longer journeys.

Another reason why we have made little of our own wild species is found in the fact that our climate favors the superior growth of the best improved fruits of nearly all parts of the world. Therefore, we have little occasion for recourse to the improvement of local wild fruits, because of superior hardiness and adaptation, as has been done in other parts of the country. Neither fruit planters nor propagators have given any special attention to the wild growths, either for fruit or for stocks, although a beginning has been made in both these directions, which may ultimately attain importance. The horticulture of California wild fruits is a thing of the future.

The distributions of our wild fruits is determined by limitations of areas of similar climatic conditions. In a general way it may be said that fruits are most abundant in foot-hill and mountain regions, and that our great valleys have always been practically destitute of them, except along stream borders. These fruits are most abundant in the northern portion of the State, but some exist throughout the State, usually thriving at higher elevations as they proceed southward.

Oregon Crabapple (*Pyrus rivularis*).—This fruit, though more abundant in the more northerly regions of the coast, as its name indicates, is found in the northwest counties of this State. It chooses a moist situation, becomes a tree fifteen to twenty-five feet high, shows white bloom, and red or yellow oblong fruit, about half an inch long. The flavor is rather acid, but the fruit is eaten by the Indians, and was sometimes used for jelly-making by early settlers.

Wild Plum (*Prunus subcordata*).—This must be regarded as one of the most useful of our wild fruits. Even now, when the plum varieties of all the world have been introduced, residents in some of the Sierra regions, where an excellent variety (*Kelloggii*) abounds, prefer it to the cultivated fruit, both for eating and preserving and jelly-making. The typical species is widely distributed over the mountainous regions of the State, and is a low shrub with white bloom and fruit three-quarters of an inch long, of red color and inferior pulp. The better variety has a narrower range, forms a larger shrub, and bears a yellow fruit, larger and better than the typical species. Some attempts have been made to improve this variety by cultivation and selection of seedlings, and the results are promising, as fruit has been shown at our fairs notably better than the wild gatherings. The roots have also been used to some extent as stocks, but seem to possess no marked advantage. Mr. Felix Gillet, of Nevada City, reports that grafting an improved plum on the wild stock seems to cause the root to grow to much greater size than natural to it. Observation upon grafted and non-grafted seedlings in the same nursery row convinced him of this behavior. Other experimenters have condemned the stock because of dwarfing and suckering. In early days the wild plums in the mining regions of the mountains were largely made use of and are highly praised by pioneers.

Oso Berry (*Osmaronia cerasiformis*).—This fruit is sometimes called the "California false plum." It has a plum-like form, and is of a rich, blue-black color, but is bitter, though not disagreeable to birds and animals, which feed upon it. The white bloom of the shrub has an almond odor. Used as a stock, the plum varieties grafted upon it have been dwarfed.

Wild Cherries (*Prunus* sp.).—Quite a group of wild fruits come under this generic grouping, and they have marked and widely different characteristics. One (*Prunus demissa*) closely resembles the Eastern choke-cherry, and bears its round, red, or dark purple fruit on a raceme. It is used for marmalade by housewives in the mountain districts. This species has proved of some utility both for its fruit and as a stock for grafting in early days when better cherry stock was not available. Another

species (*Prunus ilicifolia*) has evergreen foliage, and is a useful hedge plant.

Of species bearing fruit in umbels, or true cherry style, we have two. *Prunus emarginata* makes a handsome tree, sometimes thirty feet high, but its oval, dark red fruit is quite bitter and astringent. Another species bears bright red fruit, intensely bitter.

California Grape (Vitis Californica).—Along our streams the native grape-vine attains large size and fruits freely, the fruit resembling the "frost grape" of the East. The vine frequently covers and sometimes kills large trees with the density of its foliage. Some variation is reported in the species, but it is possible that some of the better kinds are seedlings from some imported species, bird planted. The species has attained something of a reputation as a phyloxera-resisting root for grafting, but it has proved exacting in its choice of soils and situations, and otherwise not desirable, and some Eastern species are now relied upon for this service.

Elderberry (Sambucus glauca).—The elderberry makes a fine tree in California, sometimes twenty feet or more in height, and with a trunk a foot and a half in diameter. The fruit is borne in large quantities and is used to some extent for preserves and pastry.

Raspberries (Rubus sp.).—In the mountains of the eastern part of the State is a scarlet hemispherical berry of pleasant flavor, which is called "thimbleberry" (*Rubus parviflorus*). It seems to have an advantage over a variety (*velutinus*) of the same species which is found near the coast and has a dry, insipid fruit. Another raspberry, which is found in all hilly and mountainous regions, both on the coast and in the interior, is *Rubus leucodermis*. It resembles the black-cap raspberry of the Atlantic slope, except that it has yellowish-red fruit. This fruit is quite largely gathered for domestic uses, and some efforts have been made to cultivate the plants.

Salmon Berry (Rubus spectabilis).—The beauty, size, and delicious flavor of this fruit are highly commended by all who have enjoyed it in the upper coast counties of California and farther northward. The plant makes a strong bush, five to ten feet high, and it delights in woods and shady banks of streams. The praise of all who know the fruit has led to frequent attempts to introduce the plant to warmer and drier parts of the State, but such efforts have thus far uniformly failed.

Wild Blackberry (Rubus vitifolius).—This fruit should perhaps be called a "dewberry," as it has a trailing, or, at most, but partially raised stems, which extend from five to twenty feet. The plant occurs abundantly on banks of streams and other sufficiently moist locations, both in the coast and interior regions

of the State. Around the margin of Humboldt Bay, on land cleared by fire or axe, blackberries spring up abundantly on the denuded land. Tons of the fruit are said to remain after the local housewives have done their utmost in preserving and jelly-making. In the lowland region around Stockton considerable quantities are sometimes gathered for sale. The fruit, which has been held in high repute ever since pioneer days, is oblong, black, and sweet. The species is variable, and the anomaly, a white blackberry, has been reported from Del Norte County.

Wild Strawberries (Fragaria sp.).—We have in California two Eastern species: *Fragaria vesca* and *F. Virginiana*. Thus far these have only been reported from localities in the Sierra mountain region. Another has been found identical with a South American species, *Chiloensis*, and it occurs along the coast, where the fruit is esteemed, and is sometimes abundant enough to gather in quantity. A fourth species is local, and is named *Californica*. It bears a small round fruit and is partial to the coast region. Recently some cultural attention has been given to the wild strawberry, and a variety worthy of propagation is reported by growers resident in the Sierra region. It is called "Honey," and is described by Watkins as small to medium size, exquisite flavor, glowing red color, productive, perfect bloom, and very hardy. Other varieties of the Alpine type have been brought to light in the Sierra region and to some extent distributed.

Wild Gooseberries and Currants (Ribes sp.).—Some of our currant species are achieving quite a reputation abroad as ornamental shrubs, but they bear insipid fruit. The fruit of *Ribes tenuiflorum* is, however, more agreeable, and is esteemed for jellies, etc., by dwellers in its region, which is the mountain region of the extreme north of the State. We also have a species (*bracteosum*) which has something of the black currant flavor and a fair-sized fruit, black with whitish bloom, and very sweet.

There are also several species of *Ribes* which are classed with the gooseberries, but only three bear edible fruit. One of these (*Ribes divaricatum*) is peculiar to this coast; another (*Ribes oxycanthoides*) occurs at an elevation in the Sierra Nevada and thence extends eastward beyond the Rocky Mountains. The berries are small to medium, of pleasant flavor, and well armed with spines. Another species (*Ribes quercetorum*), common in San Luis Obispo and Kern Counties, resembles the flavor of the cultivated gooseberry, and is free from spines.

Cranberries and Huckleberries (Vaccinium sp.).—We have several species belonging to the same botanical genus as the Eastern cranberry, but quite different from it both in growth

of plant and character of fruit. The fruit of two species is reddish, but insipid. Other species (*V. ovatum*, &c.) have dark blue or purple fruit. Some of these are locally esteemed, and the argument drawn from them is that the cranberry of commerce would succeed. It should be stated, however, that the situations in which these plants thrive are not at all according to the requirements of the bog cranberry. A huckleberry (*Vaccinium ovatum*) is largely gathered in the redwood region of northern California, for canning and pie-making. The berries are juicy and delicious, and the preserved fruit has a very agreeable flavor.

Other Berries.—There are many small, wild fruits, commonly designated as berries, which are of considerable botanical interest. The fruit, too, may be said to be edible, judging by the taste of Indians, birds, and wild beasts, but not likely to be much more than ornamental in the eyes of white people. They may be briefly enumerated:—

The “manzanita” (*Arctostaphylos manzanita*), the “little apple” of the Spaniard, bears a rather dry but sub-acid fruit.

The “bear berry” (*Arctostaphylos uvaurisi*) is esteemed by Indians both as food and medicine.

The “western buffalo berry” has small acid edible fruits.

The “salal” (two species of *Gaultheria*), small fruit, either red or purple, is also a favorite of the aborigines.

Of “barberries” we have three species of *berberis*. One, *aquifolium*, is called the “false Oregon grape,” chiefly notable for its handsome bloom, which has been chosen the State flower of Oregon. The fruit is dark blue, and the root is said to be a febrifuge. Another species (*nervosa*) has a larger fruit, which is esteemed in cookery; and a third species (*pinnata*) bears a small, pleasant-flavored fruit. It is the *Lenya amarilla* of the Spanish-Californians.

Our “service berry” (*Amelanchier alnifolia*) is from a quarter to a third of an inch in diameter and of a purple color.

The “lemon berry” is a fruit of *Rhus integrifolia*, and is coated with an acid exudation which is said to dissolve in water and make a pleasant drink. The fruit of *Rhus tri-lobata* is said to have both a sweet and an acid coating.

The berries of the “toyon” or “tollon” (*Heteromeles arbutifolia*), or “California holly,” are said to be eaten by Indians, but they serve the white people a better purpose in Christmas decorations.

The “jujube” of commerce (*Zizyphus jujuba*) has a local relative in *Zizyphus parryi*, which is, however, dry and mealy, rather than juicy.

The “beach strawberry” is the fruit of *Mesembrianthemum equilaterale*, a relative of the ice-plant. The good-sized fruit is

gathered along the sea-shore, and remotely suggests a strawberry.

Wild Olive (Forestiera neo-Mexicana).—This is a tall willow-like shrub, found in springy places on the borders of the Mojave Desert. It bears an abundance of small fruits which, from their botanical relationship to the olive, have attracted some attention. Experiments to determine its standing as a possible root for the olive have been suggested.

Wild Nuts of California.—The wild nuts of California are of very little commercial importance. The wild almond (*Prunus Andersonii*) of the eastern slope of the Sierra Nevada is only of botanical interest, and little more can be said of the California filbert (*Corylus rostrata*, var. *Californica*), which has none of the quality of the improved filberts nor even of the wild hazelnut. Our chestnut (*Castanopsis chrysophylla*) has a sweet kernel, but a hard shell, almost like a hazelnut. Our native walnut (*Juglans Californica*) is better in flavor than the Eastern black walnut, but its hard shell makes it of little commercial account in competition with better, cultivated nuts.

The one native nut which is regularly sold in the local market is the "pinenut"—seeds of several species of Pacific Coast pines. Their flavor is somewhat resinous, but is agreeable.

The seeds of two species of palms, *Washingtonia filifera* and the Lower California *Erythra armata*, are sought for by the Indians, who also eat the sweetish fruit of the *Yucca Mojavensis*, which somewhat resembles in shape the banana, and in flavor the fig, and is called the "wild date."

The Indians also use the acorns of several species of California oaks as food, extracting the bitterness by soaking in water, and then making a rude bread of the acorn meal.

The "jajoba" (*Simmondsia Californica*) is a low shrub, the fresh fruits of which, deprived of their seed-coats, are eaten like almonds, and when dried by fire and ground they are used as a beverage, in the form of tablets made up with sugar, or as a simple infusion. Fire-dried seeds contain 48.30 per cent of fatty matter; the oil is suitable for food and of good quality, and possesses the immense advantage of not turning rancid. In Lower California it is prepared by boiling with water. The French are recommending it for cultivation in their North African colonies.

Cactus.—The common cactus (*Opuntia Engelmanni*) bears a sweet edible fruit which the Indians dry in large quantities for winter use. By long boiling they make a sauce, which, after slight fermentation, they consider especially nutritious and stimulating.

CHAPTER V.

CALIFORNIA MISSION FRUITS.

Cultivated fruits were first brought into California from the south. Mission work among the Indians of Lower California was actually begun by the establishment of the mission at Loreto by Salvatierra, October 19, 1697. The following years horses and cattle were brought from Mexico, and from this introduction came ultimately the vast herds which roamed the hills and plains of California. Probably the first seeds and plants of cultivated vegetables and fruits came about the same time, for there was a small garden and a few fruit trees at Loreto in 1701. But Loreto was not fitted for horticulture, and in the same year an expedition in charge of Father Ugarte, who is called the founder of agriculture in Lower California, crossed over the mountain to a more suitable location at the mission of Vigge Biaundo, which had been destroyed some time before by hostile Indians. Ugarte restored the mission, made irrigating ditches, and planted fruit trees and vines. This effort was successful from a horticultural point of view, for in 1707 Ugarte made more wine than would suffice for mission use, and sent some to Mexico in exchange for other goods. Thus began the export trade in California wine.

The Jesuits continued their establishment of missions in Lower California until there were fifteen missions, at five of which there were vineyards, and presumably as many or more which had gardens with fruit trees.

The variety of fruits grown in Lower California was small. They had figs, oranges, citrons, pomegranates, plantains, and some olives and dates. There were no North European fruits, with the exception of a few peaches, which, however, did not appear to thrive.

The Jesuits were supplanted in Lower California, in 1768, by the Franciscans. The Franciscans, led by Junipero Serra, at once pressed northward, and entered the territory which is now the State of California. Their first establishment was at San Diego, in 1769. Thence they proceeded northward, braving many perils, and undergoing great hardships, establishing missions through the coast region of the State. Credit is given

to the secular head of the expedition to San Diego, Don Joseph de Galvez, representing the king of Spain, for ordering the carrying of seeds of fruits, grains, vegetables, and flowers into the new territory, and from the planting at San Diego the same varieties were taken to the twenty missions afterwards established.

Kinds of Fruit at the Missions.—It is of no little interest to ascertain how great a variety of fruits was grown in these mission orchards. Vancouver, in 1792, found a fine orchard at Santa Clara, with apple, peach, pear, apricot, and fig trees, all thrifty and promising. He also describes at the mission of San Buena Ventura apples, pears, plums, figs, oranges, grapes, and peaches and pomegranates. Robinson described the orchards connected with the Mission of San Gabriel as very extensive, having among their trees oranges, citrons, limes, apples, pears, peaches, pomegranates, and figs. There were also grapes in abundance. Edwin Bryant noticed at San Luis Obispo Mission the orange, fig, palm, olive, and grape. At the Mission San Jose he found an inclosure of fifteen or twenty acres, the whole of which was planted with trees and grape-vines. There were six hundred pear trees and a large number of apple and peach trees, all bearing fruit in great abundance and in full perfection. The quality of the pears he found excellent, but the apples and peaches indifferent. E. S. Capron, in a general enumeration of the fruits grown at the missions, includes cherries.

Early Planting by Others than the Padres.—Though the earlier Spanish population had the example of successful horticulture before them for half a century at the missions, they did not seem inclined to emulate the efforts of the padres upon their own grounds, except in occasional instances. General Vallejo planted fruit trees in Sonoma Valley as early as 1830, and of his place it is said: "It is an old and well-cultivated place, well known in all the northern portion of California while this State was still Mexican territory." Exceptions there were, also, at the south. The old fruit garden on the Cumulos Rancho, in Ventura County, has become famous. Fremont, writing of his observations in 1846, says that among the arid, brush-covered hills south of San Diego he found little valleys converted by a single spring into crowded gardens, where pears, peaches, quinces, pomegranates, grapes, olives, and other fruits grew luxuriantly together.

Scarcely had six years elapsed subsequent to the settlement of the pueblo of San Jose on its present site, before the inhabitants were enjoying the benefits of luxurious fruits. Before 1805 more was grown than could be disposed of in its natural state.

Decline of the Mission Orchards.—The decline of most of the mission orchards and gardens followed the secularization of the

establishments in 1834. There were a few exceptions, where the mission lands fell into enterprising Spanish or American hands. During the years of neglect, the more tender trees died, and the more hardy survived. The pear and the olive vied with the vine in withstanding drouth and the trampling and browsing of the cattle that roamed unmolested through the deserted gardens. These pears, as will be described presently, were turned to good account by the early American settlers; the olive and the vine furnished cuttings for most of the plantations made during the first twenty years or more of American occupation.

But it seems that not all the mission orchards were permitted to fall into decay after the secularization. In 1846 Bryant found at the Mission San Jose two gardens inclosed by high adobe walls. The area was from fifteen to twenty acres, all of which was planted with fruit trees and vines. There were about six hundred pear trees and a large number of apple and peach trees, all bearing fruit in great abundance, the quality of the pears being excellent, the apples and peaches indifferent. Other visitors to some of the mission orchards between the events of secularization and American occupation speak of being regaled with pears and milk, a dish which seemed to them ambrosial after the weary journeys overland across the deserts, or after months of ship fare.

Planting of Mission Fruits by Early Settlers.—There were quite considerable plantations, chiefly of mission grapes and oranges, by early settlers in the neighborhood of Los Angeles. General Bidwell says he saw in Los Angeles in 1845 the largest vineyards that he had seen in California, and the vines were the most thrifty. Wine was also abundant,—even the Angelica. Los Angeles had orchards, also, mostly of oranges. The largest orange orchards at that time were those of Wolfskill, Carpenter, and Louis Vigne.

Among the early planters of mission fruits in the northern part of the State was Yount, who planted vines in Napa Valley in 1838, and other fruits later. John Wolfskill, of Winters, saw grapes and peaches at Yount's in 1841, and J. M. Pleasant took peach pits from Yount's over into Pleasant's Valley, Solano County, in 1851. Dr. Marsh, on his place at the base of Mount Diablo, had, in 1842, a mission grape vineyard more than an acre in extent, and in good bearing. The vines were planted about 1838. Mr. Wolfskill planted a few vines on Putah Creek in 1842.

Partial Revival of the Mission Fruit Gardens.—After the incoming of Americans in 1849 some of the old mission trees were secured by enterprising men, and made to renew their youth by pruning, cultivation, and irrigation, that they might

minister to the great demand for fruit which sprang up among the gold seekers. The trees richly reciprocated the care and attention given them. The first fruits offered for sale in the San Francisco markets were from the pear trees of Santa Clara and San Jose Missions, and from the mission grape-vines of the same localities, and of Los Angeles County. These grapes, packed in sawdust, came up the coast by steamer, and were then re-shipped to the mining camps, arriving for the most part in good condition, and were very popular. It is recorded that one thousand five hundred tons of these grapes were sent from Los Angeles County to San Francisco and the mines in 1852. Another instance in which thrift followed neglect is seen in the fact that, in 1858, Don Andres Pico, who succeeded to possession of the orchard at the San Fernando Mission, did a considerable business in drying pears and other fruits, using the labor of the Indians.

At the present time vestiges of the old mission orchards still remain, the pears and olives still bearing, and in some cases the old date palms guarding the desolate scenes, or standing as reminders of the old *régime*, while the new life of California is surging up around them.

RUSSIAN FRUITS.

The second introduction of cultivated fruits to California was by the Russians. The exact date of their planting at Fort Ross on the ocean side in Mendocino County is not known, but is believed to have been as early as 1812. The present owner of the property is Mr. G. W. Call, who says the survivors of the original Russian planting look "very old and mossy, and are not very thrifty, but still bear some fruit every year." They were planted too closely, and have undergone periods of neglect, no doubt. The trees are apple for the most part, but there were also cherries, and some of both fruits survive. The trees are all believed to have been grown from seed, and if this be true some fortunate results were obtained, for there is still grown in Green Valley, Sonoma County, a medium-sized, bell-shaped apple, lightly striped with red, which is called the Fort Ross or Russian apple, and was probably propagated by grafts from the Fort Ross orchard. Seeds were also secured from this source for propagation of apple trees in early days in that section of the State.

CHAPTER VI.

INTRODUCTION OF IMPROVED FRUIT VARIETIES.

The first cultivated fruits of the old era came to California with the padres. The first fruits of the new era came with the American pioneers. Though not a little inquiry has been made, it is not yet possible to declare definitely who brought the first budded or grafted trees upon California soil, and it is hoped that this statement may induce someone to disclose this historic fact, which is of much interest in view of our wonderful growth in fruit production. Perhaps the first improved varieties of deciduous fruits arrived in 1846. B. M. Lelong, secretary of the California Board of Horticulture, says that it is a tradition in his family that his father, the late Martin Lelong, who came to California as a member of Stevenson's regiment, brought with him a small lot of French varieties of apples growing in a box, and that they were planted in Los Angeles.

In the fall of 1849 W. H. Nash, now a resident of San Francisco, joined with R. L. Kilburn in ordering from a nursery in western New York a small box of thirty-six fruit trees, which, packed in moss, well survived the journey around the Horn, arriving and being planted in Napa Valley in the spring of 1850. The shipment included Rhode Island Greening, Roxbury Russet, Winesap, Red Romanite, Esopus Spitzenburg apples; Bartlett and Seckel pears; Black Tartarian and Napoleon Bigarreau cherries.

Before this introduction of grafted fruit trees, and, indeed, for several years afterwards, there were many shipments of fruit-tree seeds from the eastern States to California. Mr. Barnett, of Napa, planted Kentucky seed as early as 1847. T. K. Stewart says that he brought to California with him, in 1848, about two hundred pounds of vegetable and fruit seeds, the latter including peach, pear, and apple, all of which were planted on the American River, within the present limits of Sacramento, in the spring of 1849. At the same time he planted figs and olives, and, in 1851, seeds of oranges. From all these he secured bearing trees.

But these early efforts at improvement of California fruits were but faint forerunners of the zeal and enterprise which followed the great invasion by gold seekers. As soon as the first

thought—to get gold directly from the soil—would admit the second—to get it indirectly, by agricultural and horticultural arts—there came a demand for something better than the wild fruits of the mountains, better and more abundant than the fruits from the mission orchards. At first everything in the line of fruit-tree seed which could be obtained was planted. Thus the immediate vicinity of the mines soon began to show growing fruit trees. But seedlings of any kind would not satisfy the planters, and effort was put forth in every direction after grafted trees of the best varieties. Oregon had a few years the start of California as an inviting field for immigration, and the advantage also of winning the attention of those who went out, not as gold seekers, but as agricultural producers. Oregon had grafted trees in bearing, and nursery stock as well, about the time the demand sprang up for it in California. Its introduction was then, however, of very recent date. Up to 1847 the cultivated fruit of Oregon consisted of seedlings introduced by the Hudson Bay Company. In that year occurred the first considerable, if not the very first, introduction of grafted fruit upon the Pacific Coast. The story of that venture has been so often wrongly told that it is well to record its interesting incidents in the words of one quite near to the event, if not actually participating in it. Seth Lewelling, of Milwaukie, Oregon, writes:—

In 1847 my brother, Henderson Lewelling, crossed the plains from Henry County, Iowa, to Oregon, bringing with him a pretty general variety of grafted fruits. He fitted up a wagon for the purpose, selected small plants, and planted them in soil in the boxes, and watered them to keep them alive. He told me that in some places he had to carry water a mile, up the mountains, to save his trees. When he arrived in Oregon, late in the fall, he had something over three hundred plants alive. The same fall William Meek arrived in Oregon with a few varieties of fruit trees. He and my brother put their stock together, and commenced the first nursery of grafted fruits on the Pacific Coast. It was situated five miles south of Portland, just below Milwaukie, on the east bank of the Willamette River. For want of seedling stock they could not increase their nursery much until, in 1850, my brother John and I crossed the plains, bringing with us some apple seed, which we planted that winter. We also found a gentleman named Pugh, in Washington County, Oregon, who had planted some apple seed in the spring of 1850, which had grown well, and we bought his stock. During the winter of 1850-51 we put in about twenty thousand grafts. In March, 1851, I went to Sacramento, taking with me a box of grafts of apple, pear, peach, plum, and cherry, and sold them in Sacramento. I believe I have the honor of being the first to distribute grafted fruit in California.

Other Early Introductions.—The introduction of grafted trees, for sale by Mr. Lewelling in the spring of 1851, was quickly followed by other commercial importations, and by shipments by planters for their own use, so that the plantings of 1851-52 were quite large. Still there was great doubt as to the success of the trees. The late G. G. Briggs, after his great

melon profits of 1851, went back to New York State for his family, and, returning to California, brought with him, as he says, "with no idea that they would succeed, but as a reminder of home," fifty peach and a few apple and pear trees. To his surprise the trees grew well in 1852, and the next year blossomed and bore some of the best peaches he ever saw. The pears also bore some fine fruit the same year.

Besides the introduction of grafted trees which have been mentioned there were others in 1852, for, at a fair held in San Francisco in 1853, there were several kinds of apples, grown by Isaac A. Morgan, of Bolinas, on trees planted the previous year. Apples were also shown from Napa. David Spence, of Monterey, showed the first almonds grown in California. During the winter 1852-53 the distribution of grafted trees must have extended widely over the State. Five dollars for a small tree was frequently paid at the nursery of Meek & Lewelling, in Milwaukie, Oregon, and the trees were carried overland into the mining districts of California, as well as brought to San Francisco for distribution through the valleys.

Fruit Gardens, not Orchards.—It is interesting to note that much of the pioneer effort was expended upon fruit gardens rather than fruit orchards. Two ideas, at least, led in this direction. One was the popular thought, which, however, was very early found to be erroneous, that frequent and copious irrigation was essential to the growth of fruit in this dry climate. Another was the ambition, which was correct, both from a horticultural and commercial point of view, to secure the fruit just as soon as possible, for the double purpose of determining what was adapted to the novel conditions, and to secure the magnificent prices which fruit commanded in the market. For these ends dwarfing stocks naturally suggested themselves, and were employed to an extent which seems wonderful when it is remembered that now hardly a fruit tree in the State is worked upon a dwarfing stock. Very early, say from '52 to '58, at San Jose, Oakland, Stockton, and Sacramento, small areas, which would now only be considered respectable house lots, were turned to great profit with dwarf pear and apple trees. The place of Mr. Fountain, near Oakland, was called, in 1857, "The finest orchard of dwarf trees in the State." It consisted of three acres set with one thousand six hundred apple and pear trees, all dwarf from root grafts, two years old, and four feet high, and most of them in good bearing. He started the branches from the ground, pruning severely, and heading in during the winter. He claimed that dwarfing gave him better and larger fruit, and from two to three years sooner than with standard trees. He did not irrigate, but plowed frequently, four inches deep, up to the first of June.

But though these dwarf-tree gardens were formally declared "to be the fashion," and though the list of stock of one Sacramento nurseryman, in 1858, included ninety-five standard and eight thousand and sixty-eight dwarf pear trees for sale, the foundations of the greater orchards were early laid upon the basis of standard trees. Thus the Briggs' orchard, of one thousand acres, on the moist land of the Yuba, was planted with trees sixteen feet apart each way, and Mr. Lewelling, and other early planters on the rich lands of central Alameda County, adopted about the same distance.

Quite in contrast, too, with the prevalence of dwarf trees, and contemporaneous with it, was the grand plan upon which the pioneer of pioneers, General Sutter, laid out his orchard on Hock Farm, on the west bank of the Feather River, eight miles from its junction with the Yuba, of which the following description was written about the time the trees were coming into bearing:—

Several acres were set apart for an ornamental fruit orchard, the trees and shrubs being so arranged as to present a unique landscape garden, nearly every article in which is productive of fruit. The arrangement of the fruit trees is peculiar, a large portion of them being set on either side of the broad avenues opening through the extensive grounds in various directions, imparting to the whole an air of picturesque beauty seldom seen.

But neither the narrow dwarf-tree garden plan nor the broad landscape-garden plan has survived. Neither of them harmonized with the commercial idea of orcharding—large production and economy of cultivation, and both are now but curiosities of the early horticulture of California.

Irrigation Abandoned.—The early abandonment of dwarf trees suggests also the early abandonment of irrigation in the valleys of Northern California—as early as 1856. Facilities which had been secured for irrigation of orchards were allowed to go unused, because it was seen that it was better not to use them. One case is reported in Napa County where means to furnish the orchard with thirty thousand gallons of water per day were allowed to lie idle. The substitution of cultivation for water, of course, attended this reform. The announcement of a practise, in 1856, "to plow deep, dig wide and deep holes for planting, and work the ground from February to July, allowing no grass or weeds to grow among the trees," shows that the thorough and clean culture, for which California is famous, is not a recent idea in our practise. Even the abandonment of the plow, and almost weekly use of the cultivator, was the practise of some growers in the San Jose district as early as thirty years ago. In fact, the descriptions of orchard management in that day include nearly the whole variety of methods which now pre-

vail. The experience of the last decade has shown that irrigation facilities are more valuable even for deciduous fruits than was once thought possible. This proposition will be discussed in the chapter on Irrigation.

Early Wisdom and Enterprise.—It is evident to anyone who studies the records, that California was very fortunate in numbering among the early settlers so many men with horticultural tastes, skill, and experience. The rapidity with which fruit trees were multiplied, and the confidence with which these early comers entered upon the nursery business, shows their training. Although there were many trees brought here from the East and from Europe, they constituted only a very small percentage of the plantings of the first few years, but the orchards, with the exception of a very small number of trees introduced to furnish grafting and budding stock, were the product of the soil. When this is borne in mind, it becomes all the more wonderful how so much could be done in a new country, in a distant part of the world, in so very short a time. It was an observation which was put upon record as early as 1856, that "some varieties of fruit are much improved by change to this State, and some are not benefited." The test seems to have been that if a variety was not better than at the East, it should be discarded.

The First Oversupply.—The wonderful stimulus given to the fruit interest by the results attained in growth and in marketing, soon induced larger plantings than the demand warranted. In 1857 it was publicly stated that "there are single farms in this State, containing each over half a million fruit trees in orange and nursery—one person owning enough trees, when fully matured, to produce as much fruit, other than grapes, as will be sold this year throughout our State. The day is not far distant when fruit will be an important crop for raising and fattening swine." This was, to a certain extent, a statement of a croaker, for plantations continued, rare varieties were brought from the East, the South, and from Europe; the growth of some fruits continued to be very profitable, and the nursery business, confined to fewer hands, was profitable also. The idea that quality rather than size should be striven for led to more discrimination in propagation and better treatment of trees.

The decade from 1858 to 1868 was one of quiet in the fruit interest of California. Many of the too hastily and carelessly planted trees died from lack of proper cultivation and pruning, and the borer wrought sad havoc. In 1860 and 1861 there was serious depression. It is recorded that peaches were worth but one cent a pound, and many were allowed to go to waste as not worth gathering. The flood of 1862 destroyed many trees along the Sacramento River, and replanting was slow until prices be-

gan to improve, as they did soon afterward. The rapid development of the mining interest in Nevada, and the construction of roads across the Sierras, opened the way for the disposition of much fruit grown in the foot-hills and in the region around Sacramento.

The imports of dried and canned fruits were large, and growers were exhorted to take steps to secure this trade for themselves. Something was done in this direction, for by 1867 the local product of canned fruit was equal to the demand. Drying did not advance so fast; for two years later there were imports of six thousand barrels of dried apples, while the hundreds of thousands of bushels of the fruit were rotting under the trees in our orchards.

The decade under review was also notable for the first appearance of cured raisins and prunes at the State fair of 1863. The raisins were from the Muscat of Alexandria grape, and the report states that so-called raisins exhibited previous to that time were merely dried grapes. Dr. J. Strentzel, of Martinez, was the first exhibitor of Muscat raisins, and he exhibited also dried grapes of four varieties to show the contrast between a raisin and a dried grape. J. R. Nickerson, of Placer County, exhibited the dried prunes, which were of the German variety.

Though this decade was one of uncertainty and doubt, there were rich lessons of experience learned, and the foundations for coming greatness were well laid. Many of our leading lines of production trace their beginnings to this period, and their later developments have been beyond any anticipations then cherished.

The New Era.—Another era in California may be marked as beginning with the year 1869, because then the first fresh fruits were sent East over the newly-opened overland line. This period of our growth is too recent to warrant prolonged discussion. The incidents, many of which are not pleasant to recall, are within the memory of many. The first season's shipments amounted to thirty-three tons of pears, apples, grapes, and plums; in 1870 seventy car-loads, or about seven hundred tons, were sent.

The Eastern shipment of fresh fruits began its new era with the year 1886, when the first full train load of fifteen cars of fresh fruit from deciduous trees went overland. Shipping train loads of oranges from southern California began at an earlier date.

During the present decade shipments of fruit and fruit products have increased until a very large aggregate in weight and value has been attained. The volume of shipments beyond State lines is shown by the following statement, compiled from the records of the State Board of Trade.

SHIPMENTS OUT OF THE STATE, BY RAIL AND BY SEA, OF CALIFORNIA FRUITS, WINE, BRANDY AND VEGETABLES, FOR NINE CONSECUTIVE YEARS, IN TONS OF 2,000 POUNDS AND IN CAR-LOADS.

KINDS.	1890	1891	1892	1893	1894	1895	1896	1897	1898
Fresh, deciduous	34,042.0	50,548.9	59,374.5	80,112.3	90,692.2	66,254.8	57,638.3	72,350.2	69,732.2
Citrus fruits.....	34,209.6	46,921.4	34,857.5	80,757.0	58,064.0	115,825.5	99,156.0	98,547.0	180,658.9
Dried fruits	32,297.5	32.9	29,762.2	45,386.2	51,828.2	61,386.4	48,522.8	75,159.7	76,662.7
Raisins	20,500.1	22,779.1	26,673.4	37,409.9	46,954.4	46,390.1	34,434.6	39,065.8	47,796.3
Nuts	787.1	1,358.9	2,061.9	1,796.5	3,953.5	3,234.7	4,972.6	5,808.6	5,815.8
Canned fruits	40,060.9	32,395.0	55,273.7	31,626.3	60,352.6	41,395.5	45,546.9	73,464.7	52,219.7
Total tons.....	161,957.2	186,922.3	208,003.2	277,088.2	312,744.9	334,487.0	290,271.2	364,396.0	432,885.6
Equal car-loads.....	16,195.7	18,692.2	20,800.3	27,708.8	31,274.4	33,448.7	29,027.1	36,439.6	43,288.5
Vegetables, car-loads.....	6,978.4	4,686.6	3,653.6	1,618.3	4,734.6	3,847.0
Wine & brandy, car-loads..	4,765.1	4,832.5	6,620.9	7,653.5	8,056.8	7,609.0	6,897.8	9,014.0
Total car-loads.....	16,195.7	23,347.3	25,632.8	40,928.5	43,624.7	45,257.4	38,254.0	48,072.0	56,149.6

APPROXIMATE CLASSIFICATION OF FRESH DECIDUOUS FRUIT SHIPMENTS.									
Pears
Peaches	1,187	1,624	1,640	1,594
Grapes	1,289	976	1,376	1,403
Plums	1,010	712	1,100	738
Apricots	465	407	742	542
Cherries.....	162	172	177	123
Apples	180	88	239	297
Quinces	105	53	61	730
Figs.....	13	8	24
Nectarines
Persimmons	5	1	10
Mixed
Totals.....	152	9	9	15
	4,568	4,052	5,323	5,120

The Fruit Interest in 1899.—The fruit interests of California have reached the calm, deep waters which lie below the rapids. Notable progress has been secured in planting, in the growth, preparation and marketing of the product, in the contest with injurious insects and plant diseases, and, in fact, in all things which contribute to success. It is true that there are problems still unsolved, and there have been grievous losses to individuals who have proceeded upon too great expectations or have erred in location for various fruits. Such mishaps will be less frequent in the future. At present there is a disposition to proceed more cautiously and to profit by the lessons which have been learned, many of which will be mentioned in their proper places in later chapters.

Some dimensions of the present fruit interests may be suggested by the following summaries and estimates based upon the returns of the County Assessors to the State Board of Equalization of the latest available date:—

NUMBER AND ACREAGE OF FRUIT TREES AND VINES IN CALIFORNIA
MARCH 1, 1898.

FRUIT.	Bearing	Non-bearing.	Total.	Acreage.
Apple	1,068,362	532,067	1,600,429	21,339
Apricot.	1,279,510	835,691	2,115,201	28,202
Cherry	303,923	122,467	426,390	5,685
Fig.....	143,331	63,619	206,950	2,759
Lemon	488,885	865,044	1,353,929	18,052
Orange	2,318,481	1,608,202	3,926,683	52,355
Lime *	250	100	350	3
Pomelo*.....	2,233	22,227	24,460	326
Olive.	420,791	782,570	1,203,361	16,044
Peach	3,514,429	1,695,124	5,209,553	69,454
Nectarine *	15,625	257	15,882	212
Quince*.....	4,988	692	5,680	56
Pear.....	1,086,194	487,984	1,574,178	20,989
Prune, French	4,612,293	2,295,633	6,907,926	92,105
Prunes, other.....	573,729	400,649	974,478	12,993
Plum *.....	7,632	4,406	12,038	160
Almond	959,179	538,378	1,497,557	19,967
Walnut.....	282,381	257,733	540,114	19,289
Unclassified *	123,284	133,243	256,527	2,565
Grapes, acres.....	144,070	15,774	159,844
Totals.....	17,205,500	10,646,086	27,851,586	542,399

* From the records of March 1, 1897.

It is customary to add about 20 per cent to the summaries from the assessors' reports, because their figures are likely to be below the facts. There have been, however, so many reductions of area during the last two years, either from natural

causes or of disappointment in returns from the trees, that it is doubtful whether the effective acreage of fruits should be counted any higher than that given.

VALUATION OF A YEAR'S HORTICULTURAL PRODUCTS.

The California State Board of Trade estimates the gross value of a year's shipments beyond State lines as follows:--

KINDS.	Pounds.	Selling price per lb.	Value.
Fresh, deciduous.....	139,464,400	2c	\$ 2,789,288
Citrus	361,317,800	2c	7,226,356
Dried, deciduous	153,325,400	4c	6,133,016
Raisins	95,592,600	3¼c	3,584,723
Nuts.....	11,631,600	6c	697,896
Canned, deciduous.....	104,439,400	5c	5,221,920
Vegetables, fresh	57,127,600	¾c	428,457
Vegetables, canned	3,786,000	2½c	94,650
Wine.....	136,488,000	2½c *	3,412,200
Brandy	6,765,600	7½c †	507,420
Total valuation			\$30,095,926

* Basis of 20c per gal.

† Basis of 60c per gal.

These amounts are of available surplus for export. They do not include the local consumption by a million and a quarter of fruit-loving people.

PART SECOND: CULTURAL.

CHAPTER VII.

CLEARING LAND FOR FRUIT.

The greater part of the orchard and vineyard area of this State was naturally almost clear for planting. The removal of large trees, which paid the cost of the work in firewood, or the grubbing out of willows on some especially rich bottom land, was about the extent of clearing which our earlier planters had to undertake, and by far the greater part of them perhaps never had to lift an ax. Still there has always been some clearing done, here and there, even since the earliest days, especially upon hill lands, the peculiar value of which for some fruits is generally recognized.

The lands which need clearing are in the main the foot-hill slopes of the Coast Range and the Sierra Nevada. In the south there is besides, sometimes, the *debris* of the desert flora to clear away when water is secured and the rich wilderness is subdued. This work is, however, so easily accomplished that it hardly rises to the dignity of "clearing," as understood by the Eastern mind.

It is not possible in this connection to enumerate all of the great variety of shrubs and trees which the settler lays low in his clearing. The grand trees which figure most largely in lumbering operations are not met with as a rule in foot-hill clearings. The trees which the settler encounters are rather the degraded valley growths, which, though assuming grand proportions in the valleys, become "scrubs" amid the harsher environment of the hillsides. This is notably true of the oaks and of some other trees.

Chamisal and Chaparral.—Of true shrubs to be removed, it will only be possible to name a few of the most abundant. The common manzanita (*Arctostaphylos manzanita*) occurs on dry ridges everywhere, both on the coast and at great elevations, sometimes only growing a few inches from the ground, sometimes rising eight or ten feet. Next to this, perhaps, the two

terms which the land clearer has most to use are "chaparral" and "chamisal." To distinguish between them it may be said, however, that the term chamisal properly applies to the shrub *Adenostema fasciculatum*, var. *obtusifolium*, which is abundant on dry soils in the Coast Ranges and more rarely in the foot-hills of the Sierra Nevada, often covering extensive areas with dense and almost impenetrable growth, producing an effect on the landscape like that of the heaths of the Old World. Another species, *A. sparsifolium*, with narrow, scattered leaves, is sometimes abundant on the mountains east of San Diego.

By chaparral is generally meant shrubs of several species of *Ceanothus*, forming dense thickets and giving its name to certain soils on which it most abounds, both in the Sierra foot-hills and the hillsides of the Coast Range, where it is known as California lilac. The genus includes the "flat brushes," as they are called, from their trailing on the ground, or low, horizontal shoots.

Other Small Growths.—Shrubs of frequent occurrence also are the poison oak (*Rhus diversiloba*), chiefly on the north sides of hills in all parts of the State, but most abundant in the Coast Ranges, and other species of *Rhus* which are not poisonous; the hazel-nut (*Corylus rostrata*), which has been mentioned in the chapter on wild fruits; the buckthorns, several species of *rhamnus*, well distributed on the hillsides and mountains of the State.

In some parts of the State there are also large areas of sage-brush or wormwood made up of several species of *Artemisia*, sage or chia, two species of *Salvia*, and the famous white and black sages of the bee-keepers, which are species of *Audubertia*, occurring chiefly on the mountains of southern California. Add to these the spireas, the azaleas, the rhododendrons, the sweet-scented shrubs (*Calycanthus*), etc., and include nearly all the wild fruit trees, bushes and vines mentioned in a previous chapter, and one will gain the idea that though California is widely considered a bare State, the land clearer has a host of plants confronting him and disputing his right to the soil.

Cost of Clearing.—The cost of clearing on the foot-hill slopes of the Sierra Nevada and the Coast Ranges is too variable to admit of estimates except such as may be made on the spot by experienced persons. The cost varies, of course, according to the density of the growth of trees and underbrush, and the rate of wages to be paid. Though in some cases higher cost is reached, probably as a rule the expense of clearing will be from \$5.00 to \$30 per acre, less whatever the firewood might be worth. In exceptional cases, where there is a large growth and a good wood market near by, the wood may pay the expense or more; even the roots of chaparral sell in our cities at \$3.00 or \$4.00 per cord. It sometimes happens that charcoal can be produced to

advantage; in fact, there are now orchards upon land which was secured in the first instance for the charcoal to be made upon it. Usually, however, the clearing is an item of expense and must be reduced as much as possible by working in the most economical and effective way.

Though in most cases of clearing by the actual settler himself the problem is merely one of muscle and persistence, some few hints may be given from the experience of others which may be useful. Spare time during the summer and fall can often be used to advantage with a sharp ax in trimming up the smaller trees, which are large enough to yield fencing material, and getting out posts from the redwoods and oaks, and rails and pickets from the pines. By thus using the waste material the settler can often get out enough fencing material to inclose his land and thus save considerable expense. Brush, too, which cannot be made use of can be lopped off—in short, all the sharp ax work can be done in a dry time. The actual clearing, however, should be done in the winter, when the ground is wet and soft, and digging is easy or “snaking out” is possible.

Partial and Thorough Clearings.—Orchards are planted on both partially and thoroughly cleared land. By the former practise clearing enough is done to give space for the tree holes, the *debris* is burned up, and the trees planted. In this kind of work the stumps are left to be taken out at a convenient season, the object being to get fruit trees to growing as soon as possible. Where one is working with little more than his own muscle, and has no capital, this sort of planting is better, perhaps, than not planting at all, but it must be borne in mind that all subsequent work will be done at a great disadvantage, and as cultivation is likely to be very imperfect, it would be a question whether in the end anything would be gained by such a plan. The encumbered character of the ground will, of course, prevent the use of the horse in cultivation until most of the stumps are removed. Aside from this, decaying stumps and roots in the soil often kill the young trees; especially is this the case with old oak stumps.

Clearing of land for orchard or vineyard is a very different thing from clearing for pasture, as is done in the redwood region of the northwest Coast Ranges of the State, where the stumps are untouched; the trees not taken by the lumberman are girdled and left a prey to decay and storms, and the brush slashed and burned every few years to prevent it from completely taking possession of the land. Clearing for fruit should be thorough, everything which will interfere with good cultivation removed; roots grubbed so that as little shooting up as possible is secured; the ground evened up to obviate standing water, and, where needed, arrangements made for irrigation and drainage, as will be considered later.

Removal of Trees.—The first operation in clearing will be the removal of the trees. This can be partly done in the dry season if one has unemployed time. In such case the tree is felled and worked up into fire-wood and the stump left for subsequent treatment when the ground is moist. Unless there is idle time to employ, the whole work can, however, be better done in the winter, for then the top of the tree may be made to help pull out its own roots. This is done sometimes by digging out the soil and cutting off the main lateral roots below the depth to which the plow will reach. By thus reducing its anchorage the tree will topple over, or may be pulled over with a team and tackle, and it will usually lift out its stump quite effectively.

A Steam Puller.—An arrangement for tearing out trees without digging has been used to some extent in Santa Cruz County, which is said to handle redwood trees up to four feet in diameter successfully. It consists of a portable engine and a "puller," which is a windlass operated by steam, from which a wire cable is carried to the tree which is to be pulled down. A strong chain is put around the tree at a distance above the ground proportioned to its diameter in such a way as to give necessary leverage. The immensely strong hook at the end of the cable is attached to this chain and the cable is slowly wound upon the reel. The coil begins to grow taut, a dull creak and strain are heard as the roots begin to be torn from the earth. Two chains are used, a second tree being prepared while the first is falling, that no time may be lost. The cable is detached from the falling tree, and a horse draws it from amid the *debris* of fallen foliage to the next victim. The extraction of roots by this method of pulling is said to be very complete, and the earth is loosened to a considerable depth.

Powerful traction engines, manufactured for hauling combined harvesters and steam plows, have also been very successfully used for the removal of large trees in land clearing.

Horse-Power Stump Pullers.—The use of horse-power devices for tree felling and stump extraction has increased considerably of late. The one which has achieved the best results is a local invention called the "California Stump Puller." It is simply a specially-designed capstan worked by one horse, with a wire cable five-eighths of an inch in diameter, an improved snatch block, chains, and a draft-hook to unite the cable with the chains. Power is applied to the capstan with a sweep. It is calculated that with this device, properly adjusted, one horse is enabled to produce an effect equal to the capacity of 60 horses without it, and that a 1200-pound horse which can move a dead weight of one and a half tons for a short distance can move a dead weight of 90 tons with the devices employed in the ma-

chine. It is so rapidly adjustable that recently in Napa County eighteen stumps were pulled in eighteen minutes, every root, however long, coming clear out of the ground with each stump.



The California Stump Puller.

The Use of Powder.—Another means for the removal both of stumps and of growing trees which has come into quite wide use during the last few years, is high explosives, which have vastly cheapened the clearing of lands where either large trees or stumps have to be removed. Full instructions for the use of powder are furnished by the agents in San Francisco, and they often send an expert to start the work and give instruction if there is much to be done. It has been estimated that the cost of handling trees and stumps with explosives is less than one-fifth that by hand grubbing, and the ratio of saving increases as the trees are larger, as powder is cheaper than muscle.

Removing Shrubs and Brush.—In the case of removing shrubs of a somewhat tall growth, the top is made to help out the roots. This is done either with a good strong rope or a chain. To do this requires two men and a pair of horses, and two chains, each ten or twelve feet long. A chain should be placed

around the bush some distance above the ground, to give leverage. If the bush is not removed at the first pull, start the horses in the opposite direction. While the driver is unfastening the chain from the chaparral, the second man can place the other chain around another bush, and the one who gets through his work first should at once assist the other. In this way the horses are kept in constant employment, and neither of the men need lose a moment's time. This work should be done when the ground is thoroughly wet.

Where manzanita grows somewhat upright, as it does on the hills north of the bay, the same methods of extraction can be employed with it, first slashing off enough to allow adjusting the rope or chain a few feet above the ground. Where it grows lower, as, for example, on the hills of Santa Clara, the manzanita brush is gone over with a roller so as to break it down, and then the land is burned over. The roller should be of the ordinary farm pattern, but rigged with a tiller (header fashion) so that the horses can push the roller and walk over the flattened brush. The only object of the rolling is to smash the brush down so that it will burn readily. When the brush is got rid of in this way, the plow is trusted to get rid of the roots. The plow should be of the pattern known as "prairie breaker," without coulter. Horses should be shod with a plate of sheet iron between the shoe and hoof to prevent snagging, and not less than four of them used. Much of the Santa Clara County vine belt was cleared in that way. Of course this method only answers for the lighter-rooted growths; tough-rooted chaparral, oak, holly, etc., must be grubbed out, unless the roots are snaked out by the tops, as has been described.

Marketable Products of Clearing.—Whether any money can be made from the results of clearing depends altogether upon local markets for wood and charcoal and the cost of transportation to them. From clearings near large towns enough can be sometimes had to pay for the work and hauling, and along railways wood can be often shipped with profit. This can only be learned by local inquiries.

Charcoal Burning.—Charcoal can usually be sold to advantage, and wood can sometimes be profitably disposed of in this way when it can not be marketed for fuel. A considerable acreage of unprofitable fruit trees has been disposed of in this way recently. Charcoal is made from most kinds of wood, and sometimes stumps and large roots are charred. A simple process of charcoal burning is given by an experienced burner as follows:—

To burn a pit of charcoal, the prime necessity is to perform the process of combustion with the least possible contact with air. Select a suitable place not too far from the dwelling, because the operation must be watched

from time to time by night as well as by day. It is not necessary to dig much of a "pit" in the ground. Choose hard limbs of pine, spruce or whatever wood is most available of that kind. Dry, dead limbs, if not decayed, take for choice. Set them up wigwam fashion, close together, fitting them as well as they will allow, the apex forming the chimney. Be careful to keep that chimney free, because the fire should be there applied to brisk "kindling" as far down as possible. Build round and round, taking the precaution to lay three or four straight pieces, three or four inches in diameter, along the ground from the outside to the center. These may have to be withdrawn to promote the draught.

The wood all being in place, it is now required to cover it thoroughly. In the absence of turf or sods, it must be thatched with leavy green boughs, or anything that will prevent the earth or dirt that is now heaped on from running through. Pack this soil covering carefully, exclude air as far as possible, excepting when the port-holes referred to near the ground are needed. The direction of the wind will determine which ones are to be opened. When the fire—after a few hours, more or less, according to the materials—has got a good hold, close also the chimney. Visit the pit regularly, night and day; lessen or increase the draught as may seem needed; and in a week or ten days the two or three cords of wood should be turned into good hard coal. When uncovered, water or dirt should be thrown upon coal that is too lively when spread out on the ground.

Cutting to Kill Brush.—Just when to cut to kill depends upon the character of the growth and of the season. Dr. J. W. Gally says: "It all depends, with the leaf shedders, somewhat on soil and altitude or nature of climate. Now, in Pajaro Valley, which is cool and moist, I have seen willow, sycamore, cottonwood, box-elder, maple, and 'grub' oak die out from being cut down flat with the ground, or to two or three inches below the surface, in late July or early August. But even that will depend somewhat on the kind of season; if in a late, cold, wet season, you cut a little later."

Mr. P. C. Scranton, of Lake County, gives a slightly different time. He says: "For the evergreen oaks and other evergreen brush, the time is late in the fall, just before the coldest weather sets in in November or December. The 'grubs,' or oaks that shed their leaves, have to be treated entirely different. Their time is in spring or early summer, at their most vigorous growth. Suddenly deprived of their leaves, the stump and roots are overcharged with sap, some kind of fermentation sets in, and I have seen the timber mold and commence to decay in a few days when it was very warm weather." In the eastern hills of Fresno County best success is had with cutting brush in August. More experience and observation are needed to enable one to generalize safely, but one conclusion seems to be that with deciduous growths the best time to cut is when they have just made their most vigorous growth, and this is in the summer—but the month to be chosen for the work will depend upon the location, though August is generally selected as the best time.

In the case of evergreens, as stated by Mr. Scranton, the cutting should be just before the coldest weather, in which they are the nearest dormant, the length of time before they can put leaves out again kills them. Evergreens, however, differ much in tenacity of life, for while most kinds are easily killed, the California redwood will endure almost any abuse with ax or fire and still spring up repeatedly and persistently for years.

The Use of Sheep on Sprouts.—On sprouting brush, there is, perhaps, no cheaper or more effective means of repression than sheep and goats. They are used after the top growth is cleared away instead of grubbing, if one can wait, for by their persistent cutting down of growth, the small stumps and roots will decay enough in a year or two to be plowed out with a strong team and plow.

Burning of the Debris.—However the trees and underbrush may be wrenched from the soil, fire is the final clearer. Where trees are to be worked up into fire-wood, it should be done as soon as they are felled, for the work is much less than after they become dry and hard. If it is not designed to break the land the first winter, the wood is left to season and it becomes lighter and easier to handle. The brush and roots, if no use is to be made of them, can be left to lie on the clearing to dry out during the following summer, and after the first rains of the following fall the whole area can be burned over. Such stumps as do not burn with the brush must be gathered in piles and re-fired. Burning before the first rain should not be attempted, unless it be in exceptional situations, because of the danger of communicating fire to the surrounding country, which is a standing danger in our dry climate. After the rain, then, clean up the ground perfectly.

First Crop on a Clearing.—It is the opinion of some clearers in the redwood region that the soil is not fit for fruit trees the first year after the original growth is removed, and they grow a field crop the first year. They claim that peas are the best corrective of "redwood poisoning," and fortunately in the upper redwood district they have a climate well suited to the pea. Whether their theory is right or not, their practise is of advantage, because they get a better cultivation and aeration of the soil, and kill out much of the sprouting from the old roots, which is usually quite persistent in the moister parts of the State. Usually the tree and vine planter is in such haste to realize from his labor that he does not allow the first year to go for any side issue.

Surface Leveling and Draining.—There is often occasion to clear the land of stone and rocks. The latter should be blasted out of the way so that the land may be clear for the plow and

cultivator. Once in a while one will come upon a stone wall inclosing an orchard in this State, as trim and true a wall as the most thrifty New England farmer can boast, but walls are not common. Our valley orchard lands are, as a rule, naturally as free from stone as they are from underbrush, but on the hills it is different. Probably the best way to dispose of much of the stone is to dig trenches in the natural water runs, put in stone, cover with small brush, and then with soil deep enough so the plow will not reach the brush. This disposes of the stone for all time, and at the same time helps to drain the soil. Concerning other treatment of the land after the rubbish is removed, F. W. Butler writes as follows:—

When water runs are wide, lateral ditches should be cut extending entirely through the moist areas. If during the rainy season a run is likely to have more water than can be conveyed properly through a covered trench, it should be left open and graded so that a team can cross it, and for fifteen feet on each side sow to red-top. In this way the land can be utilized that would be worthless for trees, and the red-top, that can be grown at a profit, will take the place of unsightly weeds, that would otherwise grow at the point that can not be cultivated.

To distribute work more evenly through the first year buildings can be erected, a well dug, and the trenching done in the dry season, while all the grubbing, leveling, plowing and planting must be done the following season, as soon as the ground is sufficiently moistened. All depressions where water would stand should be filled, and all flat places should be graded until water will readily flow off, and not be retained so near the surface of the ground as to cause it to become soured. This leveling can be best done by one man and a pair of horses. Plow the adjacent elevated land and scrape into the places to be filled. The land is now ready for plowing and should be done thoroughly, subsoiling to as great a depth as the removal of the stumps will allow. It is now well to go over the ground again with the scraper and level all the most elevated points so they can be readily reached by water in irrigating. Then cross-plow as deeply as possible without again subsoiling, harrow and drag, and the ground will be ready to plant.

Mr. Butler writes with reference to the foot-hills of the Sierra Nevada, where irrigation must be practised. Where irrigation is not used, leveling, or rather grading, is unnecessary, but it is often quite as necessary to arrange for drainage so that there may be no depressions which do not have an outlet for the surplus water. The life of the trees and the convenience of the planter demand this.

CHAPTER VIII.

THE NURSERY.

California nursery stock is unrivaled in growth, health, and vigor. This is the verdict of all visiting horticulturists, and has been formally declared by the victories of California tree growers at the New Orleans World's Fair, in 1885, where the highest premiums were awarded to Californians in nearly all classes in which they exhibited; and at the Columbian Exposition of 1893.

The quality of the trees which can be purchased at our nurseries, and the very low rates at which they have been sold during the last few years, make it little worth while for the orchard planter to try to grow his own trees. In fact, the investment called for to secure a good assortment of well-grown trees will be one of the best which the orchard planter can make. The professional grower, if he is honest and enterprising, can give the purchaser the advantage of his experience and skill in the choice of stocks suited to his soil, varieties of fruit adapted to his situation, and be of assistance to him in other ways connected with his enterprise; and such helps to an inexperienced planter or to a newcomer are very valuable. There may be, however, some reader who is distant from established nurseries, or possessed of limited means, who may like to use his spare time in growing his own trees, and to such suggestions are offered. There will, however, be very much which can only be learned by actual experience.

In the selection of location for a commercial nursery there are matters involved which it is not proposed to discuss. Attention will be paid rather to matters connected with what may be called a farm nursery. The first point will be the selection of a small piece of ground which offers proper soil, exposure, and, in some parts of the State, facilities for irrigation.

Proper Soil for Nursery.—The soil should be a mellow loam, easy of cultivation and not disposed to crust and crack. In all respects what one would choose as a rich, kind garden soil will answer well for the nursery. The soil should be moist, but thoroughly drained, either naturally or artificially, for time and labor will be largely wasted on a water-logged soil. In this respect a soil which might yield fair crops of some shallow-rooting vege-

tables would not always be suitable for the young trees, which, to do well, must have favorable conditions to send the roots to considerable depth. Good spots are often found in the rich loam along the banks of creeks, as in such situations one finds generally a deep alluvium, well drained by the creek. But such situations, if liable to overflow, should be rejected because standing water is not good for trees, and because the soil will be apt to be soaked with water and inaccessible just at the time when the trees should be lifted for transplanting to orchard.

It is not always possible to find an ideal nursery spot on every ranch, but still trees may be well grown on less favorable places if attention is given to correcting natural defects. For example, if the soil be naturally heavy, it may be improved somewhat by repeated plowing and cultivation during the year before starting the trees. If it be an adobe, its mechanical condition may be greatly improved by the application of a top dressing of lime at the rate of six hundred to one thousand pounds of lime to the acre. For this purpose "lime waste," which contains both lime and wood ashes, can be had cheaply at the kilns. Old plaster which may have been left from house repairs is excellent. Even builders' lime would not be very expensive, for but little would be required for so small a plot of land as a farm nursery would need to cover. The lime will increase the amount of plant food in a heavy soil as well as render it more friable. Another way in which a small area of heavy soil may be improved is by the addition of sand. A few loads of sand, if it can be had near by, will remove the tendency to crack, and will act as mulch to prevent evaporation of moisture. If the soil be very loose and subject to too rapid drying out, the remedy will be moderate irrigation during the summer, but it should cease early enough to allow the young trees to ripen their wood before the frosts of autumn. Mulches of various light, fine materials, rotted straw and the like, may be used to advantage among the young seedlings in preventing drying out of the soil, if the plot is to be hand-worked, but such materials are apt to be in the way of neat, thorough work with the horse. A mulch of sand, if available, is not open to this objection.

In choosing soil for a nursery, a piece of land which has been in cultivation for garden or field crops is to be preferred over a newly-cleared piece. It is often the case that soil from which old stumps or shoots have recently been removed has become soured from the processes of decay in the dead wood. Although the deposits of humus from decay of woody fiber tends to enrich the soil, afterwards certain acids are formed if the land lies without cultivation. These are not favorable to the growth of young roots, and a crop to which as much time is given as

a crop of young trees, should not be placed upon it. This evil quality in the soil is removed by cultivation and aeration, or may be corrected by the application of lime. This state of soil is most complained of in connection with old stumps and roots of oaks in the valleys.

Situation and Exposure.—As to situation of the piece chosen for nursery, in addition to what has already been suggested, it may be remarked that warmth in the soil is necessary to a good growth, and a good year's growth is essential to the production of a satisfactory tree. Drainage contributes notably to the warmth of the soil. Exposure is also of importance. Plenty of sunshine and protection from cold winds are to be secured. Sometimes a little elevation is desirable. It would be a serious mistake to seek moist, low land if the piece lies at the bottom of a little valley or depression where the cold air settles during the night and frosts are frequent. In such cases choose higher ground. Of course, in broad, open valleys there is not this objection, for such seasonable frosts as may be expected there are not injurious to deciduous nursery stock. The greatest nurseries in the State are in the open valleys, not on the lowest ground, however, in all cases, but on what would be called good, rich valley land. There are, however, situations in the thermal belts in which the temperature does not fall low enough to check growth of deciduous trees and cause the leaves to drop. In such cases it has been found desirable to select lower and colder ground for the nursery of deciduous trees.

Preparation of Nursery Ground.—The best preparation for nursery ground is the growth, the previous season, of a hoed crop. This will secure frequent working of the soil, thorough pulverization of the clods, etc. The produce of the hoed crop should thus pay the cost of putting the land in good condition, at least. Where the retention of moisture is an object, as it really is in some parts of the State where the annual rainfall is sometimes small and no facilities for irrigation provided, it will perhaps pay better in the end to keep the land in bare fallow during the previous summer; but there must be frequent and thorough cultivation, keeping the surface always mellow, or more moisture will be lost by evaporation than a hoed crop would require for its growth. Properly cultivated fallow soil will have moisture within a few inches of the surface, while unworked soil adjoining will be baked hard and dry to a depth of several feet. During the winter immediately preceding planting, the green stuff should be allowed to grow for a time, but should be plowed under before it gets high enough to interfere with perfect turning of smooth furrows. The decay of this green crop is of advantage to the soil. Another plowing in the

spring, and a thorough harrowing, will leave the ground in good condition to receive the pits or root grafts as the case may be. In this plowing for nursery there should be deep work done and subsoiling, as will be more fully set forth under the head of preparing land for orchard, to which the reader is referred.

Growth of Seedlings for the Nursery.—The two chief ways of producing fruit trees are, first, from seedlings grown on the spot; second, from buds and root grafts upon stock imported from the East or from abroad. First, as to the growth of seedlings:—

It is usual to take seeds from sources where they can be collected with the least trouble. Apple seeds are washed out from the pomace of the cider press; apples and pears from the coring and peelings of canneries and drying establishments; pits of the stone fruits are derived from the same source. Supplies can usually be purchased from such establishments at a moderate cost. The trouble is that from such supplies one is apt to get seeds and pits from all varieties, possessing different degrees of health and vigor. There is just as much to be gained from selecting the seed from which to grow good strong stocks for fruit trees as there is in selecting good garden or field seed. One can generally get good peach pits, for it is easy to have the order filled when the cannery is running on strong-growing yellow varieties, for these are believed to be most vigorous, and yet some claim much preference for pits from vigorous seedling trees, and make extra efforts to secure them. Wherever it is possible, and if one is only to produce a small lot of trees it is practicable, to select from the fruit the seeds for planting. Not only is there great difference in the strength of different varieties, but individual trees vary greatly. If one is taking seed from an old orchard to start his nursery with, he can take pains to get his seed from his strongest trees, and thus secure also that which is probably best adapted to his locality.

Apple and Pear Seedlings.—For a small lot of apple and pear trees the seed can be best sown in boxes. Select plump pips and keep in moist sand. Keep from the time they are taken from the fruit until sowing. Fill the boxes, which should be three or four inches deep, with good garden mold, cover the seed about half an inch, and then cover the soil lightly with chaff or fine straw to prevent the surface from drying out. Be sure that the boxes have cracks or holes in the bottom for drainage, and the whole is kept moist but not wet. When the seedlings have grown to the height of three inches, they can be set out in the nursery rows as one would set out cabbage plants.

Cherry Seedlings.—There are different ways of handling pits of stone fruits to prepare them for setting out in open ground,

which will be described. The cherry is grown from pits of two wild varieties; one is commonly called the "Black Mazzard." It is the common wild cherry of the East, and is the original type of what are known as the Heart and Bigarreau types of cherries. The other is the "Mahaleb," which is used at the East for dwarfing, and also in situations where it thrives better than the Mazzard, as it is hardier stock. In this State the Mahaleb does not seem to have such a dwarfing effect as there; trees on that stock in this State over twenty-five years old are twenty-five inches in diameter of trunk. The Mahaleb, however, ripens its wood earlier, and for this reason may be valuable in the colder parts of the State. The Mazzard is, however, almost universally used in California. Cherry stones are sometimes taken from the fully-ripened fruit, dried for two or three days, the stones cracked carefully and planted at once in good soil and kept properly moist. They will germinate soon and make a growth of a foot or so the first season. Such stocks are taken up for grafting in the winter and set out in nursery row the next spring. A better way of treating cherry is that given by W. W. Smith, of Vacaville:—

The fruit of the Mazzard should be allowed to get perfectly ripe on the tree, then gathered and let lie in a heap for three or four days, so that they may be partially or wholly freed from the pulp by washing them in water. They should then be spread out in the shade and stirred frequently for about twenty-four hours. This will give the outside of the pit time to dry sufficiently to prevent molding, while the kernel itself will remain fresh and green. They should then be placed in moist (not wet) sand and kept so until the rains set in in the fall, when they can be planted in drills, in good, rich, mellow soil prepared the previous spring and kept clean of weeds through the summer, ready for the purpose. They should never be allowed to get perfectly dry; and the reason for it is that we have but little or no freezing and thawing weather in this country to cause the pits to open; but if they are kept constantly moist it answers the same purpose as freezing. The seeds of the Mahaleb cherry will sprout with less difficulty, but the same rules for keeping the Mazzards will apply to them.

The Larger Stone Fruits.—In handling pits of the larger stone fruits, apricot, peach, plum, etc., the chief requisite is to prevent drying and great hardening of the pit. Some plant in the fall and trust to natural conditions to start the seedling in the spring, but this interferes with the cultivation of the ground, and leaves the seedling to grow in soil which has perhaps been puddled by heavy winter rains. There must also be much hand work done to clear the rows from weeds. It is much better to keep the pits from drying by covering with sand moderately moist, hasten the sprouting by appropriate treatment towards spring, and then plant out in thoroughly prepared soil, and they will make a satisfactory growth. The following method, by D. J. Parmele, of Vacaville, has given good results:—

Keep the pits out of the sun until the rains commence in the fall, then put them into a box about a foot deep, with openings at the bottom for drainage, and scatter sand or fine earth through them, putting about two inches on top, and place them under the eaves of a building on the south side, where they will get well soaked every time it rains. If there should be a long dry spell during the winter; water them a little. About March they will open and sprout. Then take a plow and open a deep furrow in loose, mellow ground, and, with a hoe, pull about two-thirds of the dirt back into the furrow, breaking the clods, and making it fine, the same as you would if you expected to plant onion seed there. Drop the sprouted pits in straight line, and cover two inches. On account of the extra work in preparing the ground, the trees will be large enough to bud in July.

Another way is to spread out the pits on a smooth piece of ground and cover with sacks, and over these a layer of straw three or four inches thick to retain moisture. The pits may be planted out as soon as they crack open, although no harm will be done if they are allowed to lie until the sprouts are well out.

Another method which has been especially recommended for treatment for almonds is the following: Lay boards upon the ground and cover them with an inch of sand; spread on this a layer of almonds and then another inch of sand, and so on. Keep the pile wet, and in three weeks of warm weather they will burst open. Plant in drills one inch deep and put over them a light coat of rotten straw.

If from any cause the pits have become quite dry, they should be soaked in water two or three days before planting. In this way imported Myrobalan pits may be made to sprout, though even with such treatment many will refuse to germinate. For this reason imported seedlings are preferred to pits.

Nut-Tree Seedlings.—In growing nut-tree seedlings much the same methods are followed as with pits of stone fruits. There are methods described in detail by California growers which should be given. As has been said, the nuts may be planted at any time after ripening, in the milder parts of the State, if the grower will undertake the greater care and cultivation. On some light soils where the rainfall is not excessive, this is not much trouble. Felix Gillet, of Nevada City, the well-known propagator of improved varieties of nut trees, gives this as his method:—

The nuts may be planted as soon as gathered, though here in Nevada City it is too cold to plant them in the fall, for the frost in winter would surely lift the nuts right out of the ground. This is the way I employ in keeping and sprouting walnuts: I throw into the bottom of a box one inch deep of sand, then a layer of nuts; put in another inch of sand, and another layer of nuts, and so on to one or two inches from the top. Then water well with a sprinkler and water again during the winter whenever the sand gets too dry. The sand has to be pretty well saturated with water, especially from the first of January down to planting time, which is in February, March, or April, according to localities. The latter part of March or first week in April is best for Nevada City. The nuts are planted in drills and to a depth of two to three inches.

In propagating chestnuts it is always better to select for seed the largest, finest, and healthiest nuts; in the fall or beginning of winter the nuts have to be planted in a box of damp sand, by layers, the box being kept in a cellar. The nuts may be planted, too, in a hole in the open ground, a layer of chestnut leaves being first thrown in the bottom of the hole, on top of that a layer of nuts, then another layer of leaves, and so on to the top, which has to be properly covered with two or three inches of earth so as to prevent the frost injuring the nuts. In February or March, according to location, the nuts are taken out and planted in drills to a depth of three to four inches; less for smaller seed like American chestnuts.

In planting out pits or nuts, if they have sprouted when taken out of the sand or hole where they have been kept during the winter, as is most generally the case, they must be planted with the sprout up or sideways, but never the small end down. So it is with walnuts, almonds, and filberts, and also the pits of peaches, apricots, and plums. This point is quite important with chestnuts and walnuts, so as to obtain straight stocks and shapely roots; then when the nuts are planted wrong, upside down, the sprout is liable to remain buried in the ground, where it will finally rot.

Imported Seedlings.—A very large proportion of some kinds of fruit trees produced in this State are worked upon imported seedling stocks. Almost all the cherries, and it is estimated that nine-tenths of the pears and one-third of the apples, are thus grown. These stocks are cheap, convenient to handle, and are therefore popular. It is easy enough to grow peach, almond, apricot, and Myrobalan seedlings, but small seeds, like apple and pear, often do not show up well in the spring, especially if the soil is of a kind that crusts over with rain and sunshine. Therefore our nurserymen import these seedlings in the winter, plant them out, as has already been described, and bud in the following summer, grafting the next spring where the buds fall. If the seedlings are large when received, they are often root-grafted at once, and then one summer in the nursery gives a tree suitable for planting out. These stocks are of better budding size during their first summer than California seedlings, which are apt to overgrow.

To succeed with cherry seeds requires special treatment, as has already been described, and the nurseryman usually finds it cheaper to buy his stocks.

Myrobalan plum seedlings were formerly imported to a large extent, but are now chiefly home-grown, and seedlings are used instead of cuttings, which formerly were employed largely. This stock has secured great favor for plums and prunes, and, in some situations, for the apricot; but some growers report a very marked dwarfing effect on the apricot, and do not approve its use.

Prof. Newton B. Pierce, of Santa Ana, has discovered in

California upon imported seedlings a serious root-fungus which kills all kinds of orchard trees in Europe, and he advises the use of home-grown seedlings to escape this danger.

Fruit Trees from Cuttings.—It is feasible to grow a number of kinds of fruit trees from cuttings, but it is not desirable in many cases to do it. Trees grown from a graft or bud in a seedling root are much better. The root system of a seedling is naturally stronger and more symmetrical. The roots from a cutting start out at the bottom and spread out horizontally and irregularly. This style of a root system is expressively named "duck-foot roots," and they do not give the tree a deep, strong hold on the soil. Trees can, however, be multiplied very fast from cuttings. Notable instances of this are the Myrobalan plum and the Leconte pear. Cuttings of deciduous trees should be taken from well-matured wood of the previous season's growth, and planted in rows and in well-prepared soil, as has already been described for the sowing of fruit-tree seeds. The cuttings should be taken before the sap begins running in the winter. A cutting about ten inches long, four-fifths of its length buried in the ground, will answer. Be sure that the ground is firmed well at the base of the cutting, but keep the surface loose. Small wood is better than large, though, of course, the extreme ends of twigs should be rejected usually. Cultivation of cuttings is the same as that of seedlings, and budding, when the cuttings are to be used as stocks, is also governed by the same rules.

The orange and lemon can be grown from cuttings, but the work is done at a different season, and requires different treatment. Cut from wood one or two years old; set in open ground of partial shade and give plenty of water (dry ground is death to their tender roots). Plant out in the summer months. Cuttings started in the warm weather and given partial shade and plenty of irrigation are very apt to succeed. A piece of well-drained soil is essential. This method of growing these fruits is not, however, in wide use or favor.

The propagation of the olive and the fig from cuttings will be considered in the chapters on those fruits.

Planting Out in Nursery.—For planting out in nursery, the term "spring" is given at the proper time, but in California it must be remembered that spring is not any definite division of the year. "Spring weather" comes from the first of February to the first of May, according to the latitude or elevation or exposure resulting from local topography. Cherries may be ripe in Vaca Valley before fruit trees put out leaves in Modoc County; and between these extremes there are advents of spring in other places according to the situation. These facts are more

fully set forth in the chapter on climate. Spring must be detected in the behavior of vegetation and not by the calendar. When the tree buds swell and the leaves appear, spring has come for that locality. But whether one can plant his nursery then or not will depend upon the character of the soil and the condition of the rainfall for that season. This varies much from year to year. As a rule, however, in most parts where fruit is grown at present in large quantities, the heavy cold rains will be over by the first of February, and then nursery operations can commence if the soil is in good condition. If not, the planter must wait until the soil is dry enough to work nicely. There will, of course, be heavy rains after the first of February; but they will not do more injury than to require cultivation to loosen the soil, if the nursery ground is well situated for drainage, and if it is not it should not be used for this purpose.

Supposing the ground has been deeply plowed and thoroughly harrowed, as has been already described, the laying out of the ground is the next operation. Everything should be done with a view to the use of the horse in cultivation. The rows should be laid out as straight as possible. Some use a plow furrow; some an arrangement like a corn-marker, with two cultivator teeth set four feet apart; some stretch a line, to get the pits or root grafts as true to it as possible, and some trust to the furrow for straightness. No rule can be laid down for means to be employed; the result must depend upon the eye and skill of the individual. Some people can hardly shoot a straight line with a gun. Each must do the best he can in this respect.

There is difference in practise as to distance between the rows in nursery. The usual distance is four feet, but others claim that it is better to make the rows six feet apart, especially where no irrigation is practised, as this gives the young trees more room, and if the ground is kept thoroughly cultivated, as it should be, it gives the roots a greater supply of moisture to draw upon. In growing a small lot of trees, where there is plenty of land, it is, of course, desirable to give them every advantage in the way of facilities for growth.

At the ends of the rows spaces of about twelve feet should be left as turning-ground for the horse when cultivating, and as a roadway. The length of nursery rows depends upon the taste of the grower. It is convenient to have alleys wide enough for a horse and cart at intervals of one hundred to three hundred feet, but in small nurseries the headlands would probably give all the access required.

The depth for planting seeds and pits must be regulated by the size of the seed and the character of the soil, as is always

laid down by the authorities, and in this State another condition must be made, and that is the climate or weather conditions prevailing in the locality. Where the rainfall is generally light and the soil loose, seed must be planted deeper than where good spring showers are to be expected. In fine soils seeds must be planted shallower than in coarse, even with the same rainfall. Judgment and experience must dictate in this matter, and if a man has no experience, he is pretty apt to get it.

During the spring months the cultivator must be used as often as may be required to keep the weeds from getting too high, or the soil from becoming too densely packed by heavy rains, but the ground should never be worked when too wet. It requires some watchfulness and promptitude to use the cultivator just at the right time.

Nursery Irrigation.—In parts of the State where the rainfall is adequate, cultivation thorough, the soil sufficiently retentive, and atmospheric conditions favorable, the seedling will make its growth without irrigation, and many nurseries are on ground not provided at all with irrigation facilities. In other parts of the State irrigation is necessary. Water should be applied sparingly, and yet enough to keep the seedling in healthy, growing condition. This is shown by the leaves, which should not droop or curl. Excessive irrigation should be guarded against, because a soft, excessive growth is very undesirable. Water is a good thing, and in some cases a very necessary thing, but the use of it should be wisely regulated. At budding it is necessary that the sap should be free and the bark slip easily. To foster this condition it is sometimes desirable to give a watering a few days before budding commences. Water should be applied by running it through shallow furrows between the rows, and the cultivator should follow as soon as the ground is dry enough to work freely.

CHAPTER IX.

BUDDING AND GRAFTING.

If the nursery ground has been well worked and the seed properly handled, the growth of the seedling will be strong and rapid. If an early start was had and other conditions favorable, some kinds will be ready for budding in June, and the production of what are called "June buds," as will be described presently. In ordinary practise, however, budding will come later, and the budding season extends from July to October. The weight of the budding of deciduous trees is generally done in August and September.

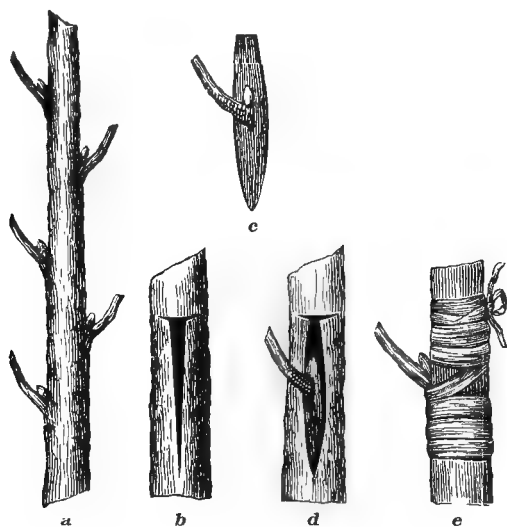

Budding Illustrated.

The process of budding, as employed on all the common fruit trees, is very simple. It consists in lifting the bark and inserting a bud from another tree in such a way that the inner bark of the bud shall come in contact with the layer of growing wood in the stock, and then it will be quickly knit to it by the

sap, if the bark is closed around the inserted bud closely enough to prevent the air from drying the two surfaces at the point of contact.

In the engraving *a* is the cutting or "bud stick" from the tree of the kind into which it is desired to transform the seedling. This cutting is to be made from the growth of the present season, which has well-formed buds at the axils of the leaves. If buds are desired to mature early, pinch off the ends of the shoots from which they are to be taken. Suckers and so-called "water sprouts" should not be used, but rather well-formed wood from the branches of the tree. It is requisite that the buds be taken from a vigorous, healthy tree of the variety desired. Bud sticks can be carried or sent considerable distances if packed in damp moss or other material to prevent drying. Sealing the ends with grafting wax is also a good precaution against drying out.

Budding knives can be bought at all seed stores and cutlery establishments. They have a thin, round-ended blade at one end of the handle, and at the other end the bone is thinned down, or a bone blade inserted. The former is for cutting and the latter for lifting the bark of the stock into which the bud is to be placed. Armed with a bud stick and such a knife, the "budder" starts in upon a row of seedlings. Bending the seedling over a little and holding it between his left arm and his left leg, he reaches down for a smooth place on the bark as near the ground as convenient to work, and makes a horizontal cut, and from that a perpendicular cut downwards towards the roots, as shown at *b*, in the engraving, with the bark slightly lifted and ready for the insertion of the bud. Next he cuts from his bud stick a bud, as shown at *c*. This carries with it, on the back, a small portion of the wood of the bud stick as well as the bud and bark. It was once claimed that this wood should be carefully dug out, but in budding most kinds of trees it is not necessary; in fact, it may be better to leave it in; such at any rate is the general practise. The point of the bud is now inserted at the opening at the top of the slit in the bark of the stock and pushed down into place, as shown in figure *d*. To handle the bud the part of the leaf stem which is left on is of material assistance. Nothing remains now but to apply the ligature which is to hold down the bark around the bud.

There are various ways of tying in the bud. Any way will do which holds down the bark closely, but not too tightly. Different materials are also used, soft cotton twine, stocking yarn, strips of cotton cloth, candle wicking, etc. The last-named is perhaps the best material, on all accounts, although strips of cheap calico bear evenly upon the bark and do very

good work. The use of twine is speedy, but the strands bearing upon a narrow surface, and not being elastic, they are apt to do injury by cutting into the bark unless carefully watched and loosened. The fiber from basswood bark was formerly largely used, but has given place to the other materials named, which are more handily obtained. The buds must be examined about a week or ten days after insertion, and the ligature loosened, for otherwise it will cut into the rapidly-growing stock. Sometimes trees are badly injured by neglect in this particular.

In making June buds, where immediate growth of the bud is desired, some growers make a hard knot with the cord around the stock, above the bud, and then use the loose ends to tie the bud. When the binding around the bud is loosened, the hard knot remains on the stock, girdles it, and forces the sap into the bud. Thin wire, known to nurserymen as "label wire," is also used for this purpose.

In going through the nursery row, all seedlings which are large enough are budded at once. In going through the row again to look to the bands, if the bud is seen to be fresh looking, it is considered to have "taken." In stocks where the first bud has dried up, another is inserted lower down. Sometimes seedlings which were too small to hold a bud at the first working over are given a bud later in the season, or left for taking up for root grafting in the winter.

In nursery practise the budder does not stop to tie his buds, but is followed in the row by another man, who carries the tying material, and does this part of the work.

The common method of budding thus described is used on all common orchard fruits. Special styles of budding for special fruits will be described in the chapters treating of those fruits.

Usually the budded trees are allowed to stand in the nursery row with no other treatment that year than the insertion and care of the bud, the latter remaining dormant until the next spring. Then, as soon as the sap begins to swell the buds on the stock, the top is cut off down to about two inches above the bud, and all growth is kept off except that of the inserted bud. When that has grown out about twelve inches, the stub is cut off to about three-quarters of an inch or less from the bud, and the wood is quickly grown over by the bark. As there are apt to be dormant buds on the stock below the inserted bud, the trees have to be examined from time to time, and all such suckers removed. This is the common practise with budded trees. Exceptions will be noticed presently in connection with definitions of different kinds of trees known to the trade.

Spring Budding.—What has been said in reference to budding applies to the use of dormant buds. It is also possible to

work with what is called a "pushing bud." This process, as described by a distinguished French authority, consists of retarding the growth of the buds on the scions by burying them in the ground until the sap is starting well in the stock in the spring, and then putting them in, trimming off the top of the stock so as to force the bud into growth. In this way the grower of a rare variety may secure trees for planting out the following winter, or he may secure a stock of buds for fall budding, and thus multiply his stock of a desirable variety very rapidly. A modification of this method consists in taking buds in the spring when they have grown out even half an inch, and inserting them by the usual method of lifting the bark, when the sap is flowing well in the stock. Then cut off about half the stock, so as not to give the bud too much sap at first, and afterward, when it is seen to have taken well, the balance of the stock is cut off near the bud. This method gives a tree the first season and saves a year over dormant budding. Shade and protection from dry wind are desirable.

GRAFTING.

The next process of propagation to be considered is that by grafting. Its success, as with budding, consists in bringing the growing wood (inner bark or alburnum) of the scion into contact with the same layer of the stock. It can be applied to any part of the tree, from the topmost branch to the lowest root, as is the case when new trees are made from scions and root fragments. Thus grafting pertains both to the production of young trees for planting out and to the transformation of old trees bearing worthless fruit into producers of choice varieties.

Grafting for the production of young trees is first in order. Instead of budding the seedling during the first summer of its growth, it may be allowed to complete its season's growth, and drop its leaves. When thus dormant the young trees are taken from the ground, the roots rinsed off with water if the ground is wet and sticky, or merely shaken free from clinging earth if in a dry time. Enough trees are dug at once to graft at a sitting. The grafting can be done at the work-bench in the tool-house or barn, and if one is pressed with other daylight work, it may be done by lamplight at the kitchen table, if the housewife can be conciliated for the muss it will make.

Care of Scions.—The scions should be previously selected, and whether taken from trees on the place or brought from near or distant sources away from the farm, should have been placed as soon as procured in moist earth on the north side of the house or other building, where they will keep cool and damp until one is ready to use them. At the East and in parts of

this State where the ground is apt to freeze it is necessary to keep scions in the cellar with their butts covered with moist sand, but over most of the area of the State nothing more is needed than to put down in the earth at the base of a tree or on the north side of a building, with, perhaps, a box or barrel inverted over them to keep out mice and other intruders. Care must be taken not to let them dry up. If it is desirable for any reason to keep scions dormant long into the spring or summer, of course storage in a cool cellar is better, for in the open ground the scions will burst into leaf after a warm spell of spring weather.

In selecting wood for scions, as for bud sticks, never take water shoots or suckers that start from the body of the tree and push up through the older branches, but always give the preference to sound, fully-matured wood, at the ends of the lower or nearly horizontal branches. Careful experiments have shown that trees grown from such scions are more likely to take on a low, spreading habit than those from the central or upper branches. The scions should be tied in bundles with a stout cord; and a piece of a shingle, with the name of the variety written plainly and deeply thereon, should be tied in with each bundle.

Grafting Wax.—In grafting, a good grafting wax is requisite. The ingredients are mixed in different proportions by different growers. A few recipes which are known to give good results are as follows:—

Two lbs. mutton tallow; 2 lbs. beeswax; 4 lbs. resin.

Two and one-fourth lbs. resin; 2 lbs. beeswax; $\frac{3}{4}$ of a lb. tallow.

One lb. mutton tallow; 2 lbs. beeswax; 4 lbs. resin.

Two lbs. resin; 2 lbs. beeswax; $\frac{1}{4}$ lb. tallow, and a little linseed oil.

Two lbs. resin; 1 lb. beeswax, $2\frac{1}{2}$ lbs. linseed oil; 4 tablespoonfuls turpentine.

All these mixtures are made with the aid of gentle heat, and during grafting the wax must be kept warm enough to apply easily with a small brush. To do this the wax dish may be kept on a hot brick, to be changed for a fresh one as it cools, or, better still, is to heat the wax in an old fruit-can or something of that kind, inside another, which is partly full of warm water. The wax should not be so hot as to run too easily, but just right to spread well.

Grafting is greatly facilitated by the use of strips of waxed cloth or waxed paper, the latter being quite good enough for root grafts, which we are at present especially considering. This waxed paper is made by spreading a thin coat of wax, with a brush, upon tough, thin wrapping paper, cutting up the paper, when cold, with a sharp knife, on a board, into strips about an inch wide. Waxed cloth is made by dipping cheap cotton cloth into hot wax, pulling the pieces between the edges of two boards

to take out as much wax as possible, and when the cloth is cold, tearing it up into half-inch strips for small grafts or wider strips for large grafts. While grafting is going on in-doors, these strips hanging near the stove are kept in good, soft condition for use.

There are grafting preparations which do not require heating, but remain in a semi-fluid state, and then become very hard by contact with the air. The following is a popular French preparation:—

Melt one pound of resin over a gentle fire. Add to it one ounce of beef tallow, and stir it well. Take it from the fire, let it cool down a little, and then mix with it a tablespoonful of spirits of turpentine, and after that add about seven ounces of very strong alcohol. The alcohol cools it down so rapidly that it will be necessary to put it once more on the fire, stirring it constantly. Great care is necessary to avoid igniting the alcohol.

This wax is easily prepared, and when well corked will keep for six months. It is put on the wounded part of the tree, very thin, and soon becomes as hard as stone. Thus it is valuable not only for grafting, but for covering the scars caused by removing limbs in pruning. When bench grafting is done by nurserymen, of course all appliances are arranged for the speediest work, and wonderful results are attained by one man and a helper, even as many as three thousand root grafts of apple in ten hours. We are, however, merely discussing home practises.

Cleft Grafting.—Where various-sized stocks are to be used, as will be the case with a bunch of home-grown seedlings, different styles of grafting must be used. Where the stock is much larger than the scion, as is apt to be the case with California seedlings, the cleft graft will be simplest.

Cut off the top smoothly above the root crown and then split the top of the stock, as shown in the engraving. Then prepare the scion by whittling it to wedge-shape at the lower end. Open the slit in the stock with a little wedge and insert the scion so that its inner bark matches with the inner bark of the stock, something as shown in the second figure. It does not matter whether the outside of the scion is flush with the outside of the stock or not; the vital point is to get the growing layers just inside the barks in contact with each other, and, to be sure of this, it may be well to give the scion a slight diagonal pitch, for if the barks cross each other, this desirable contact is sure to be made. It is well to make the side of the wedge of the scion which goes nearer to the center of the stock a little thinner than the outside.

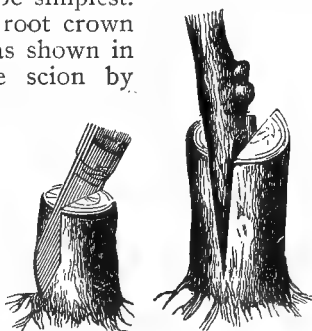

Cleft Graft at Root Crown.

A scion for a root graft is cut longer than for use in the top of the tree, for in planting the point of grafting is placed a little way under-ground. Such scions are usually cut with four or five buds. After the scion is in place, it only remains to wrap it closely with a piece of the waxed cloth or paper, in such a way that all the cut surfaces are covered, extending the wrapper a little below the split in the root. Paint over the wrapper with warm wax put on with the brush, put a little on the top of the scion, and the graft is complete.



Side Graft.

Side Grafting.—Another method which prevents splitting the stock is the side graft, shown in the accompanying figure. It consists in bending the stock to one side and cutting in diagonally with a thin-bladed, sharp knife, a little more than half way through the stock. Into this open cut insert the scion so that the inner barks touch; then allowing the stock to straighten up, holds the scion firmly. Covering with a wax band drawn tight makes a good job, and such grafts make as good growth as the buds set the previous summer. This method can be used with stems or branches up to an inch in diameter, and is essentially the same as will be mentioned later as a side graft for working over old trees. In this style of grafting, a stub of three inches or more may be left above the graft, and to this the graft can be tied to prevent blowing out if it makes a strong growth. Afterward the stub is cut back with a sloping cut and waxed or painted to prevent checking.

Whip Grafting in the Stem.—Grafting above the root or in the stem of the stock when stock and scion are about the same size, is done by tongue or whip grafting. The accompanying sketch shows a whip graft in the stem of the stock. Grafts up to an inch in diameter can be made in this way, but it is generally used for smaller wood. Care must be taken to secure proper contacts of the inner barks at least on one side of the stock. After pushing the parts together, a wax band holds them firmly in place, or the joint may be simply tied and painted over with wax.



Whip Graft.



Tongue Graft.

A Root Graft.—When the root stock and the scion are about the same size, the tongue graft is also used, as shown in the figure. In making this both the stock and scion are given a sloping cut of about the same length, and a secondary cut made in each. When the two are put together, the wood "tongues in," or

interlocks, as shown in the engraving. The object of this is to make more points of contact for the inner barks of root and scion, and at the same time to interlock the two more firmly. In putting the two together, if the stock is slightly larger than the scion, be sure to put the scion so that the inner bark contact is made, and this will bring the scion a little to one side of the center. Bind with the wax band, and paint with wax as in the case of the former graft.

In large nursery practise expert grafters have come of late years to make this root graft without wax, merely tying in the graft. For amateur work at home it is much safer to use the wax.

Grafting in the root, where the root is much larger than the scion, may be done without splitting the root by cutting or sawing out a triangular piece on the side of the root, cutting the scion to fit and trusting to a strong band to hold it in place. This graft is illustrated in the chapter on propagating the grape. It also works well with root grafting the walnut, and is used by some in ordinary top grafting on other trees.

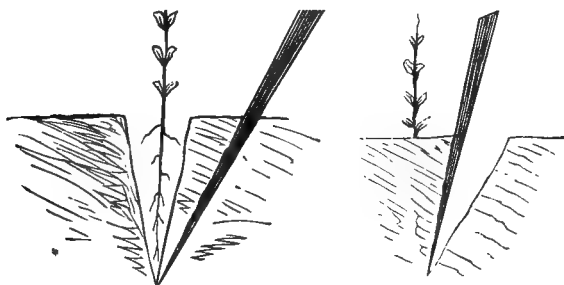

Planting Seedlings or Root Grafts in Nursery Row.

Planting out Root Grafts.—This root grafting can be done in the winter before it is time to plant out, and the grafts can be made a few at a time, as convenient. The grafts, then, as fast as prepared, should be bedded in moist sand in the cellar, and will make their contact firm, and even start to growing a little. In planting out in the nursery rows be sure the earth is firmed well around the root, otherwise many will be lost. The plant can be put in and the earth closed with a dibble, as seen in the sketch. Plant ten or twelve inches apart in the rows. Keep the weeds down and the soil well cultivated and loose on the surface, and the first season's growth will give a tree fit for planting out in orchard in the coming winter. For irrigation the same rules will apply as given for the growth of seedlings for budding.

PRUNING TREES IN NURSERY.

As for other treatment of the trees (either from bud or root graft) in nursery during the first year, there is some difference of opinion and practise. If the young tree will be content to make a straight switch with good buds in the axils of the leaves, but no laterals thrown out, it will be in the best possible shape for planting in the orchard, and gives the planter a chance to make the head at whatever height suits him, and to secure uniformity through the orchard. All trees will not, however, be content with this growth, but will push out laterals all along the stem. Even in this case some let the whole growth go for the planter to treat as he thinks best. Another plan is to go over the nursery when the young stock is about two feet high and pinch back the laterals part way, but retaining the leaves nearest the stem to shade the stem. This pinching back is done from the ground up to a height of one to one and a half feet, and above that the growth is left to take its natural course, to be cut as desired when the head of the tree is formed. Pinching back develops buds near the stem and gives the planter a better chance to head the tree lower if he likes. Another practise which prevails to some extent, is to pinch off the terminal bud when the young tree has reached a height of about two and a half or three feet in the nursery. This soon forces a growth of lateral branches, which are in turn pinched after they have grown out a couple of feet. The result is the formation of a head on a nursery tree the first year, and when such trees are planted in orchard they are merely cut back on the laterals, leaving the head as formed in the nursery. Such trees are difficult to handle in packing, and take much room in shipment. * There may, however, be an advantage in such practise for the home grower if he is situated in parts of the State where the greatest season's growth is attained. Orchard planters generally, however, prefer a dormant bud or a yearling of moderate growth, without laterals.

CLASSES OF NURSERY STOCKS.

The several classes of stock which are to be had from nurseries are as follows:—

Root Grafts.—These are seedling roots, or pieces of them on which scions of the desired variety have been grafted on the bench and the junction healed over in the cellar. No growth has yet started in the scion. If the tree planter wishes this kind of stock, he should plant it out in nursery row in the spring and remove the trees to orchard the following winter.

June Buds.—For the multiplying some desirable varieties very fast, buds are kept dormant in a cool place; or, by pinching

off the top shoots of the current year are forced to mature buds very early. These buds are put into seedling stocks as early in the season as possible. After budding, the top of the stock is girdled with knife or cord, or partly cut away, and growth is forced on the bud so as to give a small tree at the end of the first summer. This method of propagation is growing in popularity in this State, especially in the foot-hill districts where small trees are preferred for transplanting.

Dormant Buds.—Trees are sold in dormant bud when they are lifted from the nursery and sent out before any growth has started on the inserted bud. The bud should be seen to be the color of healthy bark.

Yearling Trees.—These are trees which have made one season's growth from the bud or graft. Two-year-olds have made two seasons' growth, and so on. The proper way to count the life of a tree is from the starting of growth in the bud or graft, for this point is really the birth of the tree.

WORKING OVER OLD TREES.

Another operation which may be properly considered as a branch of propagation is the working over of old trees. There is much of this being done every year in this State. The old seedling fruits in the older settled parts of the State are being made to bear improved varieties; trees of varieties illy adapted to the prevailing conditions are changed into strong growing and productive sorts; trees are changed from one fruit to another, as with the tens of thousands of unproductive almonds which have been worked over into plums, prunes, and peaches. Still another reason for working over is to secure more valuable and marketable varieties. Sometimes a mixed orchard is made to bear a straight line of one sort which is in demand, or when the grower finds he has too many trees of a single kind, which give him more fruit than he can conveniently handle when it all ripens at one time, he works in other varieties so as to get a succession of varieties adapted to his purpose, and thus secures a longer working season in which to dispose of them. This is especially the case in large orchards of apricots, peaches, and plums, when the grower depends upon drying his crop. Information concerning the successive ripening of varieties can be gained from the special chapters on the different fruits. For all of these reasons, and others which need not be enumerated, the work of the propagator is continually going on even in our large bearing orchards. As with young trees, so with old, transforming the character of the tree is done both by budding and grafting.

Budding Old Trees.—One way to prepare an old tree for budding is to cut back the branches severely during the latter part of

the winter, which has the effect of forcing out new shoots around the head of the tree, and in these the buds of the desired variety are set in the summer, just as is done in budding nursery stock, except that the budding should be done rather earlier because the sap does not run as late. When the shoots are budded, those being selected which are situated so as to give the best symmetry to the new head, the shoots not budded are broken a foot or so from where they emerge from the old wood, and are allowed to hang until pruning-time. At the winter pruning the budded branches are topped off a little above the bud and when the new shoot starts it is often loosely tied to the stub of the old branch to prevent breaking out in the wind. When it gets strength, the stub is cut away smoothly to allow the wound to heal over.

Another way is to insert the buds in the old bark at points where it is desirable to have the new branches start. This is sometimes done by lifting the bark, as in ordinary budding, and slipping the bud under, sometimes by what is called shield or plate budding, which consists in removing a piece of the old bark entirely and putting in its place a piece of bark of the desired variety, having upon it a dormant bud. With plate budding it is necessary to be careful to have the inserted bark just the size of the bared spot, and to wrap it more closely than when the bud is slipped under the bark of the stock. In all cases in budding old trees, care must be taken to get fully-matured buds, and it is well to take them from large shoots, which have a thicker and firmer bark than may be used in budding nursery stock. It is also desirable to be very sure that the buds are taken not only from a tree of the desired variety, but from a healthy, vigorous tree of that variety.

In selecting buds, also, one must be sure that he gets leaf buds, and not fruit buds only. In taking buds from some kinds of bearing trees, of course, he may sometimes, to get well-ripened buds, be obliged to take both fruit and leaf buds together. This will work well if care is taken not to rub off the leaf bud. It is rather easier, however, to work with buds from young trees not yet in bearing if one can be sure that these trees are of the desired variety.



Cleft Graft in
Old Wood.

Grafting Old Trees.—Old trees are also renewed by grafting. This is most generally done by the old process of “top grafting,” as practised at the East. The main stem or the larger branches are cut square off, and the scions, usually two, but four or more if in the trunk, are shaped and set into clefts in the stock as shown in the engraving. It is

better to use limbs than to graft in the trunk, if the old trees are of good size. The following description, which the writer borrows in part from some unknown source, will serve to guide novices in the matter:—

The outfit necessary for doing the work consists of a small, fine saw, a regular grafting knife, or a pocket-knife with a long, straight, sharp blade, wax, light mallet, and a hard-wood narrow wedge. After selecting the limb to be grafted, saw it off—your own judgment will guide you as to best point, but before the saw gets quite through the limb, cut the bark on the under side of the limb to prevent the liability of peeling down.

Next split the stub with knife and mallet and insert the wedge in the center of the cleft to hold it open. It is usual to cut the scion with two buds, but sometimes better results are had by using scions with but a single bud. Whittle the scion wedge-shape, so that it fits nicely down into the cleft. To do this, hold it in the left hand with the bud at the ball of the thumb, then cut the side toward you; as will be natural, turn it over, and cut opposite side in the same way, making the wedge a very little thinner on the edge opposite the bud than the other. This will insure a firm pressure at the points where the bark of scion and stock meet.

When set, the bud of the scion will be on line with the outer long portion of the graft. The point to be closely observed in adjustment is to have the inner or sap bark of the scion connected with the same of the stock. If a trifle too far in, or too far out, the work will be a failure. Some people set the graft a little out at the top and a little in at the bottom, so as to be sure of a connection at the crossing-point, but there will be firmer hold if there is a union the whole length. Our rule has been to have the wood of the scion come exactly even with the surface of the stock wood, and we seldom fail in getting firm adhesions and solid limbs, after years of growth.

After the scions are set, and two should be put into one limb if large, carefully withdraw the wedge and apply the wax, so that every part of the wood and bark cut and split is well coated. In doing this use extreme care not to move the scions at all from their sittings.

Most grafting over of old trees is done by this method, using one or another of the wax preparations described upon a preceding page. If the cut surface of the stock and the split is thoroughly waxed over as low as the bark is split, there is usually little trouble with the growth of the scion and the healing over of the stock. In the warmer valleys in the interior, the sun is often hot enough to melt the wax and cause it to run and bare the wood surfaces. This is prevented by dusting the wax thoroughly with brick-dust well powdered; but, by a little experimenting with the recipes already given, one can secure a wax which will stand any heat likely to be encountered.

For grafting over trees by working upon the limbs, the neatest and surest work can be done by methods of grafting which do not require the splitting of the stock. There are various ways of doing this. One method is shown in the engraving on the next page, and consists in cutting the scion as shown, and inserting it beneath the raised bark and then binding well with waxed bands, the preparation of which has already been described.

Another method is an application of what the French call oblique side grafting. It consists in making an oblique cut downward through the bark of the stock and for a distance into the wood, using a chisel and mallet or even a strong knife. A saw and knife are also used for making this cut, as will be described in the chapter on the peach. A small form of side graft has already been shown earlier in this chapter. In it the scion is held in with a wax band. Some growers remove the top of the stock with a sloping cut about half an inch above the scion, as shown in the engraving, and wrap the waxed band well around and over all the exposed surfaces. Others do not remove the whole of the limb until the scion has started well into growth, and then they cut down and

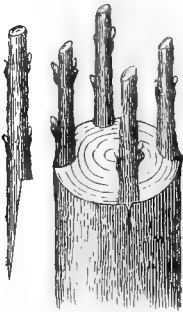

Grafting in the Bark.

pare the stock and cover with a band or with a wax that will not run in the sun.

Several ingenious devices have been patented by Californians for securing uniformity in the incision in the stock and in shaping the scion, but it is so easy to succeed with ordinary tools that such inventions have never come into wide use.

TIMES FOR GRAFTING IN CALIFORNIA.

There is nothing particularly new about the methods or means employed for grafting deciduous fruit trees in California, but the time at which the operation can be successfully done, and the condition of the scion, are different from those held to be necessary in other climates. It is not at all requisite that the scions should be carefully stored away to keep them in a dormant condition, nor that the grafter should haste to do his work in just such a state of sap-flow in the spring-time. It was early discovered that grafting could be successfully done with growing scions, and that scions could be cut from one tree and set in another nearly at any time the grafter desired. Grafting is therefore possible much later in the season than is prescribed elsewhere, and it is also possible to begin earlier. In one of the largest apple and pear orchards in the State it is common to graft in December. The absence of freezing weather saves the graft from injury. As our trees start their flow of sap early, and often when the ground is too wet for comfortable orchard work, it is the practise of many to get their grafting and pruning done before the heavy mid-winter rains begin. The practise of most growers is, however, to conform somewhat nearly to traditional methods, to do most of the grafting in the spring months, and

to use dormant scions, the growth of which is retarded by heeling them in on the north side of a building, or keeping them in sand in the cellar, as the grower chooses. Of course it should be understood that there are parts of the State where the winter conditions are more nearly like those at the East, and practise has to conform to them.

As to whether it is better to remove the whole top of the tree and graft all the limbs in one year, there is some difference of opinion. The prevailing practise is to graft over part of the limbs one year and the balance the following year; or else to leave part of the top to shade the bark and take part of the sap flow until the grafts start out well, and then cut it away.

Whenever old bark is exposed by cutting back for grafting, thorough protection against sunburn must be provided. The simplest way to do this is to cover the exposed bark with good whitewash. By using thirty pounds of lime, four pounds tallow, and five pounds of salt with enough water to make it flow well, a tenacious whitewash can be secured.

What has been said thus far relates especially to the working over of old trees of common deciduous fruits. Though much the same method will succeed with some of the semi-tropical fruits and with nut trees, the discussion of their propagation and grafting over will be deferred to the chapters devoted to them, and this will also give opportunity to describe methods especially adapted to these fruits.

CHAPTER X.

PREPARATION FOR PLANTING.

The two essentials in preparing land for trees or vines are deep and thorough cultivation, and provision for drainage, unless the situation is naturally well drained. Drainage will be considered in connection with irrigation in another chapter. In this place, however, by way of emphasis, it may be remarked that high land is not necessarily well drained, although the general feature of the surface may be an incline, nor is low land necessarily wet, although the surface may be apparently level. For horticultural purposes the drainage of the land must be considered on the hillside as well as in the valley, for reasons which will be more fully set forth in the chapter on drainage.

The preparation of land for fruit planting should begin with grading. In irrigated orchards this is essential for the equal distribution of water. Even where irrigation is not anticipated, it is of decided advantage to smooth down hummocks and fill sags which are likely to collect water in the rainy season. As has been shown in Chapter III, this can be done on most California soils without danger of uncovering a sterile subsoil. Some intimation of the method of grading is given at the close of Chapter VII. In preparation for the irrigated orchard, and the probability of irrigation is now great even in regions where formerly rainfall was the sole reliance, it is important that accurate grading should be done and the use of the surveyor's level and grade stakes will be found a very desirable investment. All moving of soil should precede the general plowing.

For the planting of orchard or vineyard the land must be put in as good tilth as possible, and extra expenditure to secure this will be amply repaid in the after-growth of the trees and vines. If practicable, it will be all the better to have the process of preparation begin a year before the plants are to be set. This is true either with newly-cleared land, as has been described, or with old grain or pasture land which is to be used for fruit. Thorough and deep breaking up as soon as practicable to plow in the fall, and leaving the surface rough during the winter, facilitates the access of air to the lower layers of the soil, and in a certain sense may be said to sweeten and enliven it. Following in the furrow with a subsoil plow is very desirable, either

at the first plowing or later. Such treatment of old grain land breaks up the old hard-pan, which has probably been tormented by years of shallow culture. The preparation should continue during the following summer, and can often be made both thorough and profitable by the growth of a summer "hoed crop," the culture of which will kill out many weeds and secure good pulverization of the soil. If no summer crop is grown, the land should be kept in cultivation by plowing the weeds under as long as the surface soil retains moisture enough to start them. A special advantage of such summer-fallow in regions where the rainfall is apt to be short is that, by prevention of evaporation, the trees or vines set the following winter will have a good part of the rainfall of two seasons to grow with, and the result will often be very noticeable. If there are supplies of manure available, as is often found in old corrals on our grain or stock farms, it is better to gather and apply this the winter before the planting of the trees. If this work is not done, then it should be left until after the trees are planted, and then be spread upon the surface during the winter, and plowed in in the spring after it has been in part leached into the soil by the rains. Application should be made evenly all over the surface and not massed around the roots of the trees, unless it is to be applied as a mulch to the surface after the spring cultivation is over, as will be considered later.

If it is thought desirable to plant the land immediately after breaking up, put in the plows as early in the fall as it is possible to do deep work, that is, to plow to a depth of ten or twelve inches, or more. Harrow thoroughly. If it is still early, cross-plow also deeply when the land pulverizes well, and follow in the furrow with the subsoil plow, working to a depth of fourteen inches or more. For this kind of work good teams are needed, and the plow should be sharp and bright. If the work is hard for the team, set the plow so as to take less land, but do not sacrifice the depth. Harrow again thoroughly, and the land is ready for the trees or vines.

Avoiding Dead Furrows.—Unless dead furrows can be used to advantage for surface drainage in case of heavy rain-storms, it will be of decided convenience in laying off to have the field free from them. This can, of course, be secured by beginning the final plowing at a line in the center of the field, turning all furrows inwards. In this case, too, if a right-hand plow is used, the team will always turn on unplowed land, and thus avoid trampling upon and packing the loose soil. The slight ridge in the center of the field formed by the first two furrows can be easily leveled by a couple of back furrows, and when properly harrowed the field will be found smooth as a floor for staking out for planting.

LAYING OUT FOR PLANTING IN SQUARES.

It is very desirable, both for convenience in cultivation and for the beauty of the orchard, that the trees should stand in straight lines, and care should be taken to attain that end. Most orchards and vineyards in this State are laid out in squares; that is, the rows of trees or vines are all at right angles to each other, as shown in the accompanying sketch. This is the sim-

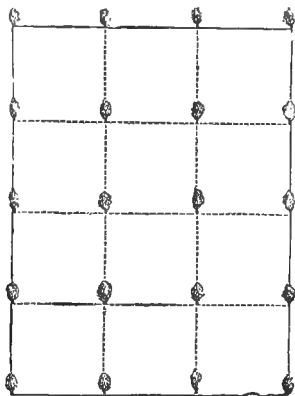

Planting in Squares.

plest arrangement; and by some of our largest planters is held to be the best. It is true that the trees are not equidistant from each other in all directions, and that, theoretically at least, there is a portion of the ground unused—supposing that the roots occupy a circle, as do the branches. Practically, however, it may be doubted whether the hungry roots of well-grown trees or vines leave any portion of the soil unvisited.

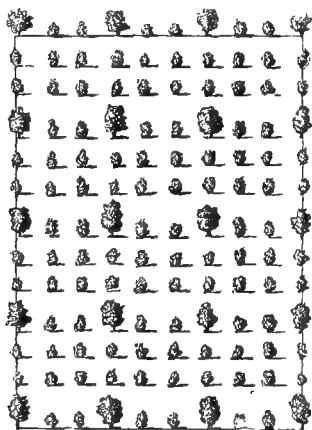

Double Squares.

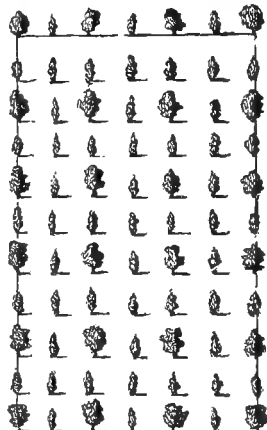

Alternating Squares.

There are also forms of double squares and alternating squares available for planting at long distances, with growths between, which are ultimately to be cut out, or for vines between fruit trees.

VARIOUS WAYS OF MARKING FOR SQUARES.

Marking with a Plow.—This method was used in laying off some large orchards in the Sacramento Valley. A common two-horse turning plow is rigged with a "marker,"—a light wooden bar extending at right angles from the beam, the bar being as long as the desired distance between the rows of trees. On the end of this bar a crosspiece is fastened perpendicularly, so that it scratches along on the surface of the ground. The line of the first furrow has to be designated by a flag stake, to which the plowman proceeds. When this is done, the team is turned and sent back along the next row, the location of which has been fixed by the marker, and so on for the length of the field, the marker being turned each time to indicate the next furrow. Following the same course the other way of the field leaves the trees to be planted at the intersection of the furrows.

Measure and Sight.—Another method which is quite commonly used and answers a good purpose in small plantings is the combination of measure and sight. The sighting stakes are usually plasterers' laths pointed at one end and whitewashed to make them more visible to the eye. In the use of these it is necessary to measure the distances and locate the laths to mark the ends of the rows all around the field. Then locate a line of laths across the field each way through the center, these laths occupying places which the trees of these two central rows will fill. After these are in place, measurement can be dispensed with, and the job can be finished by sighting through. The man on the ends of the rows has three laths to sight by in each row, and the stake driver places the stakes as directed by the sighter. Good location can be done this way if a man has a good eye and patience enough.

Marking off with a Wire.—A measuring wire or chain is, perhaps, the best means for getting accurate location of trees or vines. It is used either for setting in squares or in other arrangement, as will be described presently. Measuring wires are made of annealed steel wire about one-eighth of an inch in diameter. The length varies according to the wishes of the user. If it is desired to lay off the plantation in blocks of one acre, the wire should be two hundred and eight feet nine inches long, for that is approximately the length of one side of a square inclosing an acre of ground. But some use a wire as long as three hundred feet, when the acre measure is of no consequence; and others, in smaller plantings, make the wire just the length

of the piece they have in hand. At each end of the wire is fixed a strong iron ring about one and one-half inches in diameter, to be slipped over stakes; some use a larger ring, say three inches in diameter, because it is easier to handle in pulling taut. Along this wire, patches of solder are placed exactly at the distances desired between the rows of trees or vines, and to these places pieces of red cloth are sometimes fastened so that the points may be easily seen. Another style of measuring wires is made of small wire cable about a quarter of an inch in diameter, made of several strands of small wire. It is more flexible and less likely to become kinked than the large wire, and can be easily measured and marked off to represent the distances at which rows of different kinds of trees should be placed. This is done by separating the strands a little at the desired points and inserting a little piece of red cloth, pressing the wires together again and tying firmly with a waxed thread to prevent slipping. In this way the same wire can be easily arranged for planting vines or for the trees requiring the greatest distance between the rows. Another advantage of the cable is that any stretching can be taken up by retwisting, which can not be done with the stretching of a single wire.

Finding a True Corner.—To use the measuring wire for laying out trees on the square, it is necessary first to get one corner true, and then a field of any size can be marked out accurately. Select the side of the field which is to serve as the base of the square and stretch the wire along that, say fifteen feet from the fence, which will give room enough to turn with the team in cultivation or to drive along in picking-time. When the wire is thus stretched parallel with the boundary of the field, place a stake at each of the distance tags on the wire, and these stakes will represent the first row of trees or vines. To find a square corner, begin at the starting-point and measure off sixty feet along this row with a tape line, and put a temporary stake, then from the starting-point measure off eighty feet as nearly at a right angle with the first line as can be judged with the eye, and run diagonally from this point the temporary sixty-foot stake. If the distance between these stakes is one hundred feet, then the corner is a right angle. Now, having the outside lines started at right angles to each other, one can proceed with the measuring wire and lay off as large an area as he desires, if care is taken to have each line drawn parallel with the last, and all stakes accurately placed with the tags on the wire—providing the land is nearly level or on a uniform grade. In locating trees over uneven ground, the measurements will have to be made from tree to tree, with the tape line held as nearly to a level as possible.

Rows on Hillsides.—Laying off orchard or vineyard on hillside too steep to plow both ways, there is advantage sometimes in placing the rows up and down the hill nearly twice as far apart as the rows along the face of the hill. In planting trees thus the advantage to be gained is by enabling you to keep the team well up the hill; thereby you are able to plow or cultivate the trees close on the lower side of the rows. There is no difficulty in cultivating the upper side of the rows, for the plow or harrow is always below the team. If trees are planted as recommended, the team can be guided up the hill a little between the rows, then allowed to drop down hill one step, and thus one can cultivate the trees close on the lower side. The same rule will apply to vines.

QUINCUNX PLANTING.

There is much confusion in the use of this term in this State. It is, in fact, made to cover almost every kind of arrangement which is not on the square. Webster defines the term to mean

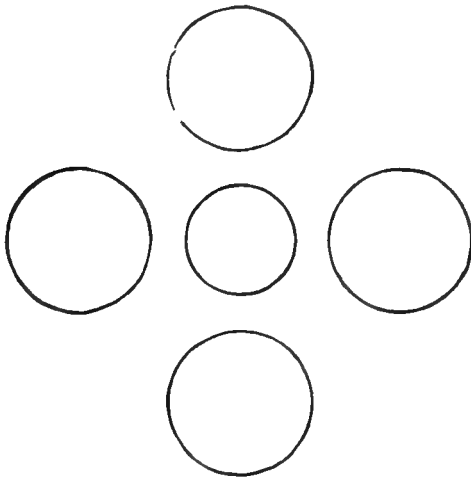

Quincunx.

“the arrangement of things, especially of trees, by fives in a square, one being placed in the middle of a square.” Trees set in quincunx would stand as shown in the accompanying diagram. To locate them in this form it is only necessary to proceed as already described for planting in squares, by fixing upon the base line and locating two side lines to it at right angles. Place the stakes on these two lines just half the distance desired between the trees, and have the measuring wire long enough to reach across from one line to the other. Near one end of the

wire place another mark just half way between the end and the first tree mark; that is, if the trees are to be twenty-four feet apart in the squares, this additional mark should be twelve feet from the end of the wire. Now set the first row with the end of the wire at the corner stake, and set stakes at each twenty-four-foot mark.

Proceed now to the first half-way stake, and instead of putting the end of the wire at this stake, put the twelve-foot mark there. Put stakes now at each twenty-four-foot mark again to locate the trees in that row. In the next row put the *end* of the wire at the first stake and proceed as in the first row. Thereafter using the end of the wire and the twelve-foot marks alternately, the stakes will be set in quincunx all over the field. If the midway stakes are now pulled out along the two side lines, the remaining stakes show where the trees are to be placed. This way of planting locates about seventy-eight per cent more trees upon any given area, but it brings the trees at irregular distances from each other, and except in furnishing a way to arrange an orchard with permanent and temporary trees, there does not seem to be any advantage in it.

PLANTING IN EQUILATERAL TRIANGLES.

This is the arrangement generally implied when the term "quincunx" is wrongly employed. By it the trees are all equally distant from each other, and thus the ground as equally divided as possible. The arrangement admits fifteen per cent more trees to the acre than the setting in squares, and the ground can be worked in three different directions. This arrangement also gives better facilities for irrigation. Objections are urged to it, however, in that it does not admit of thinning trees by removal of alternate rows, as is sometimes desirable, and that one has to take a zigzag course in driving through the orchard.

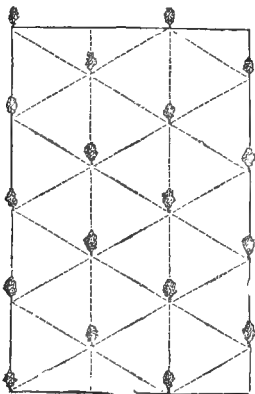

Trees Planted in Hexagons.

Hexagonal planting places the trees as shown in the accompanying sketch.

It is termed hexagonal because, as the figure consists of six trees enclosing a seventh, a line drawn through the encompassing trees makes a hexagon. It is also called septuple planting, because seven trees enter into its figure.

An orchard can be laid out in hexagonals by using the

measuring wire as described for quincunx planting with the distance and half-distance marks, except that the guide stakes in the side rows must be placed at different distances apart. Mr. H. A. Brainard, of San Jose, gives the following useful table, showing the distance for side stakes to reach desired distance between the trees, and the method of calculating the numbers of trees to the acre by the square and hexagonal or sextuple arrangement:—

Trees set Sextuple.	Check-stakes should be
10 feet apart.....	8 ft. 8 in.
12 " "	10 " 4 2-5 "
14 " "	12 " 7/8 "
16 " "	13 " 10 1/2 "
18 " "	15 " 7 "
20 " "	17 " 4 "
21 " "	18 " 2 1/4 "
22 " "	19 " 7/8 "
24 " "	20 " 9 1/2 "

After the field is staked, each alternate stake in the check rows should be removed. The following table will show the number of trees to the acre by the square and septuple system:—

	Square.	Septuple.
10 feet apart.....	435.....	500.....
12 " "	302.....	347.....
14 " "	222.....	255.....
16 " "	170.....	195.....
18 " "	134.....	154.....
20 " "	109.....	125.....
21 " "	99.....	114.....
22 " "	90.....	103.....
24 " "	75.....	86.....

For any distance not given in the above table, calculate the number of trees to the acre by the square system, and add fifteen per cent. This will give the number if planted septuple.

Laying out Hexagonals with a Triangle.—It is possible to lay out an orchard in hexagonal form by working from stake to stake with an equilateral triangle of dimensions equaling the distance required between the trees.

Take three strips of one-by-two-inch dry pine or redwood, and as long as you wish the distance between the trees. Cut the strips the same length, and fasten the corners of the triangle firmly together by nailing to pieces of pine board six by six inches.

If the long strips are set up edgewise, the triangle will be much stiffer and better to carry. Through the corner boards bore an inch hole, making sure that the three sides of the triangle measure exactly the same. If they do, the triangle must necessarily be perfect. Then brace it a little by nailing a lath across each corner, and it is ready for use.

Now split out some three-quarter-inch pins, one foot long, from a good, straight-grained redwood post. Make one hundred pins for each acre you have to lay off. Do not use lath for pins, as they will cost double and will not be half as good.

Three persons must now carry the triangle, beginning on one side of the field, say eight feet from the fence, and guided the first time through by a line of stakes. Carry the triangle with its side to the line of guide stakes and its point in. The head man and the inside man will stick pins, while the rear man will slip his corner each time upon the pin set by the head man.

After the first time across, the man at the inside point of the triangle alone will set pins, while the other two fit their corners upon the pins in the last row set. Thus one row of pins only is set each time you go across the field.

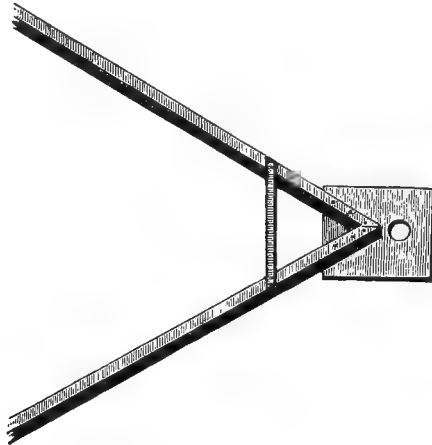

One Corner of Triangle—All Being Made Alike.

■ If the triangle is exact, and the first row of pins is set perfectly straight, and the pins are always set perpendicularly, everything will now work like a charm and the job will be perfect; and it is so simple and easy that a man and two small boys can lay off from five to ten acres in one day. Remember that no guide stakes are used anywhere after the first time through.

The Triangle on Hillside.—The use of the triangle requires a little nicety in “leveling up” where the piece is hilly. By using a plumb-line at two corners of the triangle, the third corner resting on one of the stakes, leveling the triangle and bringing one of the plumb-lines over another stake already set, the position of the other line would determine the position of the next stake. This method has worked fairly well, even in places where the slope was sufficient to give a fall of six feet between the trees, which were set twenty feet apart.

Locating in Triangles with a Chain.—Instead of a wooden triangle, a chain has been used in this way:—

First stretch a chain along one side of the ground, setting by it the first row of stakes. This forms the base line. Have a piece of chain just twice the length of the established distance between trees, with ample rings on the ends and a joint in the middle. Put one of the rings over the first stake and the other over the second stake. Then take the joint in the

middle of the chain and stretch it out reasonably tight. The wire forms a letter V, at the focus of which stick a stake. The point is indicated with precision by the joint in the middle of the chain. Then take the ring off the first stake and put it over the third stake, leaving the one on the second stake where it is. Tighten the chain again, and another point is fixed. Thus continue all the base line, shifting the rings alternately, turning over the chain as one turns a pair of draughtman's compasses in his hand when spacing off a line. The second row of stakes being set, set the third row, and so on through the ground.

The suggestions given in this chapter should indicate ways enough to lay off orchard and vineyard ground to answer all needs, though there are other good ways not mentioned. It is hoped that the instructions will not be regarded as too explicit. They are intended for the guidance of the inexperienced planter, and will naturally seem laden with detail to those who have become familiar with the operations by repeated practise.

CHAPTER XI.

PLANTING THE TREES.

After the field has been graded, thoroughly tilled and carefully laid off as has been described, the next step is digging the holes for the trees. "How large shall the holes be?" He was a wise fruit grower who, when asked this question, replied, "As large as the field." That is to say, it is much better to work the whole ground over deeply than to trust to deep holes and shallow working elsewhere. Where this is done, the tree holes need only be large enough and deep enough to receive the roots without folding them in or cramping them up. In a loose, deep soil, however, one can dig extra deep and broad holes if he desires, and will be repaid by extra growth of the tree; but in a close, tenacious soil a deep hole is not only undesirable, but often positively a danger to the tree, unless drainage of the holes is provided artificially. Such holes hold water like a tub, and the loosening of the soil deeply facilitates its gathering in the hole. Many have found their trees in such places dwindling and dying because their roots were soaking in water.

Planting on Some Shallow Soils.—As a rule, trees should have a deep soil, and for these deep, free loams, California is famous, but there are situations where very satisfactory growth and production can be had, even when the hard-pan is near the surface and the soil would be called shallow. In such places it is the character of the subsoil which warrants the tree and vine planter in making use of them. The best illustration of such situations is the large area of what is called "bed-rock land," adjacent to the city of Sacramento. It is about thirty years since Mr. James Rutter, of Florin, first noticed that there were vines here and there which grew exceptionally well and bore large crops of fine fruit. He found by investigation that under these vines there were crevices in the bed-rock, and from this he took the hint to bore through this hard-pan in the bottom of the hole where he placed the tree, and in this way he gained access for the roots to the subsoil and egress for the water through the permeable substratum. He bores a hole two inches in diameter into or through the bed-rock and rams well into it one and a half pounds of black blasting powder. After explod-

ing this, he sometimes bores a three-inch hole about four feet below the blast. Instead of blasting in the hole where the tree is to be planted, some bore and blast the hard-pan midway between the rows, placing the holes at "quincunx" with the trees. The shattering of the hard-pan between the trees is said to be practicable after the trees are growing, and may in certain soils relieve trees which are suffering for lack of drainage. A half-pound cartridge of dynamite has been successfully used for sub-soil blasting.

There are situations here and there over the State where such practise would be beneficial, and in some cases mere digging or boring through the impervious stratum avails much. On the bench back from the Mokelumne there are spots where "lava crusts" overlie gravel, and trees have been well grown by cutting holes through the lava to the gravel, filling with good soil and planting the trees in these holes. Their roots penetrate to the gravel stratum and obtain abundant moisture and nutriment. This "lava" is quite soft when not exposed to the air, but being quarried hardens so as to serve as building stone. In certain situations where a shallow layer of soil overlies a heavy clay, trees have been blown over, but when a cut has been made through the clay, the trees have rooted deeply and have withstood the winds.

It is becoming more and more apparent, however, that for commercial plantings of trees and vines all such defective soils should be avoided. There is plenty of good, deep land to be had, and the burden of ameliorating poor land is a serious handicap in the competition which has brought production to very narrow margins of profit.

Digging the Holes.—Holes for tree planting may be dug at a leisure time after the laying off of the field, even though it is not designed to plant the trees immediately, but our largest planters do not approve the practise. In such cases the sides of the holes should always be freshly pared off before the trees are put in, because the rain and sunshine are apt to cement the sides. In digging holes the surface earth should always be thrown on one side and the lower soil on another. The object of this is to have the top soil to place in direct contact with the roots when the tree is planted, the lower soil being used to fill up the hole with.

TREE SETTERS.

No matter how carefully the stakes are placed in laying off the orchard, the trees will not easily come in line unless some handy device is used for bringing the stem just in the place occupied by the stake which was thrown out in digging. These

devices are called "tree-setters," and there are a number of designs. Two are given, either of which will give good results. Take a piece of board one inch thick, four inches wide, and five feet long; bore an inch hole in the center, and one at each end at equal distance from the center; then cut a piece from one side



Bar for Tree Setting.

of the board, marked by a square, the corner resting in the middle of the center hole. Make two stakes, each one foot long, that will easily pass through the end holes. Place the center of this board against the stake, where the tree is to be planted; push the stakes into the ground through the holes in the ends, then lift the board from position and proceed to dig the hole. When dug, replace the board over the end stakes in its former position, then plant the tree with its trunk resting against the center notch in the board, and you have it in just the right place.

Another setter is in the form of a triangle: Take three pieces of plain one-inch stuff three to four inches wide and four feet long, and nail them together, forming a three-cornered frame, letting the ends project sufficiently to form a corner, as shown in the drawing. Next make a couple of smooth, hard stakes, well sharpened, and about a foot or sixteen inches in length. When

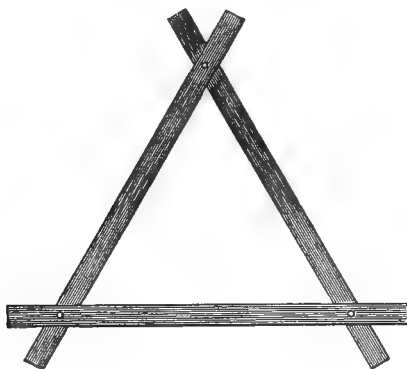

Triangular Tree Setter.

you are ready to set your trees, place the frame flat upon the ground with one corner firmly and fairly against the stake which marks the place where the tree is to stand. Now in the other two corners stick the stakes already prepared for the purpose. This done pull up the stake against which the frame was first

placed—the one indicating a place for a tree—remove the frame, being careful in doing so not to move the other two stakes, which must be left to be used while setting the tree. After the hole is dug and everything ready for setting the tree, again place the frame against the two standing stakes, let the tree drop into the other corner, which will help support it while the dirt is being placed about the roots; and this will bring the tree exactly where the stake was originally. If the stakes are properly put in line, so will be the trees.

These setters are described as they are used when the hole is dug and the tree set at the same time. Such is the ordinary practise in planting. If one wishes to dig the holes beforehand, it is necessary to furnish more stakes, as two have to be left beside each hole to mark the position of the setter when the planting is done. Besides its use in bringing a tree into line, the tree-setter enables one to judge of the depth of setting as compared with the surface of the surrounding ground. It is not easy to determine this with the eye if the hole be a large one. Where the measuring wire is used to set the stakes, it is sometimes stretched across again after the holes are dug, the tags on the wire thus indicating the places for the trees of the whole row. The trouble with this practise is the bother of having the wire in the way while filling and tramping the earth around the roots.

SELECTING TREES.

In the purchase of trees it is well to patronize nurserymen in your own district, providing they are honest and intelligent men, who keep themselves informed as they should about their business. The advice of such a local nurseryman is often of great value to the newcomer, for he will know by his experience and observation much about the adaptations of fruits and varieties thereof to the region. If, for any reason, local nurseries do not meet your needs, seek some well-established nursery at a distance. It is much safer to deal directly with the grower of the trees than to patronize traveling agents. Where, however, these agents are the accredited representatives of well-known establishments, they may save the planter time and trouble by taking his order for him. So-called "tree peddlers," who are jobbers in trees and in too many cases send you refuse trees which they pick up cheap wherever they can, and label them to suit, without respect to truth or honesty, should be resolutely avoided, no matter what inducements or blandishments they may offer.

It is desirable, if possible, to visit the nursery yourself, and see the stock which is to be furnished you. The trees should have a good healthy look, with clean, bright bark and of size

enough to indicate a good, free growth. The matter of size is not the only point to consider, for size of the top is not so desirable as well-matured wood and plenty of roots. On the other hand, stunted trees are not, as a rule, worth planting; for a stunted tree, like a stunted calf, does not make a good after-growth. There are cases, however, in which, by extra cultivation in good soil, fine trees have been grown even from "culls" from the nursery. The best rule is to select trees of good medium size, straight and healthy. In judging size, however, one must take California and not Eastern standards, because our nursery stock, if well grown, invariably is of much greater size than Eastern. Ask to see samples of the roots as well as the tops and do not purchase trees unless the roots are healthy looking and free from knots or excrescences. Gnarly and knotty roots in the young tree are a sure sign of insect pests or of unhealthy growth, and planting such trees has occasioned our orchardists immense loss. Many have been led into purchasing poor trees because they may be had cheap. A tree selected merely because it is cheap may prove the most expensive thing a man can put in the ground.

Guarding against Insects.—The top of the tree should be carefully examined to discover scale insects if there be any. For this purpose a hand-magnifier should be used. Such a glass should always be in the fruit grower's pocket. One can be bought at any optician's for a dollar or two, which will fold into its case so as to be carried without scratching. Our nurserymen, by forsaking old infested locations and obtaining new ground, now sell much cleaner trees than they did a few years ago. But still it is well to be always on the watch for pests. Disinfection of nursery stock is now officially provided. Details of treatment will be given in the chapter on injurious insects.

TAKING TREES FROM THE NURSERY.

Trees should be carefully taken from the nursery rows so as to obtain a good amount of small branching roots. In lifting from the home nursery, digging with well-sharpened spades, which will sever the long roots cleanly, is perhaps the best method. In the large nurseries the newly-invented tree-diggers are generally used. They have two revolving coulters, which cut through the surface soil each side of the trees, and a sharp, curved blade, which is drawn through the ground under the trees, loosening the soil and severing the long roots cleanly. The tree is then easily lifted, and has generally a much better root system than by the old style of "ploughing out," which broke off so many of the fibrous roots and lacerated the larger ones. Whether the taproot should be retained or not is not

worth discussing on theoretical grounds. As a matter of fact and practise, the taproot cuts no figure at all in California orchard planting to-day, although the discussion of the question was very warm in this State thirty years ago. It is important, however, that the planter should have as many small lateral roots as he can get. The small fibrous roots are usually of little account, as they seldom survive transplanting, and it is better to clip them away, if the time can be afforded, as they often prevent the proper close contact of the soil with the larger roots. Cutting back all roots to short stubs at the base of the stem has succeeded in some instances in California on moist low lands, but longer roots are far safer in the deep drying of the surface layer which is to be expected in this State.

The roots, after lifting, should not be permitted to dry. Hence, in hauling from the nursery to the farm, the trees should be well covered with wet straw and old sacks, or, if shipped from the nursery to distant points, should be well packed. The best way to pack trees is, undoubtedly, to box them in with wet straw, but it costs less and they usually carry well considerable distances if carefully bundled with tules, the roots packed in wet straw, and, especially about the roots, the packing and covering bound down tight with ropes to prevent drying out.

Attention should be paid to hauling away trees from the railway stations as soon as possible after arrival. It is not uncommon for shipments to lie on the station platforms for days, often when a desiccating north wind is blowing. Such treatment soon takes the life out of the rootlets, and often, no doubt, the nurseryman is blamed for failure of trees which have suffered some such neglect as this, either from transportation companies or from the purchasers.

Heeling In.—On arrival at the farms, trees should be “heeled in” as soon as possible; even if it is the intention to plant at once, heel them in just the same, for delays arise often in the most unexpected manner. To heel in, dig a trench or plow a deep furrow, or a double furrow, in light, moist, but well-drained soil; put in the trees singly side by side, removing all the packing material carefully from the roots, laying the tops all one way, and then shovel the earth over the roots until they are well covered with loose soil, and be sure that the soil sifts down well between the roots. Ordinarily this treatment will hold the trees in good condition for a considerable time if need be. If, however, they have become dry before arrival, the bundles should be thoroughly drenched with water before heeling in. In extreme cases, where the top shows drying by shrinking and shriveling of the bark, the trees should be drenched, and then they should be covered root and top with earth for two or three days, when,

if the trouble has not gone too far, the bark will recover its smoothness and plumpness. It should be very seldom, however, that a lot of trees is allowed to get into such condition by neglect. In heeling in it will be found a great convenience and a safeguard against possible confusion by loss of labels, if each variety as taken from the packing is placed by itself in the trench. Nurserymen generally attach a label to each small bundle, if the trees are of several varieties, and the novice is apt to lose all track of his sorts when heeling in the trench, unless he heels in each kind by itself, leaving the nurseryman's label to mark the whole lot of each kind.

If the planter has his own ideas of after-treatment of his trees, or if he is a beginner and desires to adopt the suggestions which will be laid down in this book, he should insist that the nurseryman shall not trim up nor cut back the trees before packing. Have the trees packed just as they are lifted from the ground. The work toward the shaping of the tree should be done after it is planted in the orchard.

PLANTING THE ORCHARD.

The best time for planting out deciduous fruit trees in most parts of California is immediately after the first winter rain which is sufficiently heavy to moisten the soil to a considerable depth. The young tree should be dormant before being moved, and if its leaves have fallen it is good evidence of its dormancy. Such, however, is the effect of the climate of California, more apparent in some years than others, and with some kinds of fruit than others, that the young tree retains a small part of its activity very late, and in such cases it is not practicable to wait for the complete falling of the leaves. Sometimes for convenience of work, the trees have to be lifted before this takes place, and in such case it is desirable to remove the leaves to lessen evaporation. It is probably better to transplant in this condition for the sake of early setting in its new position than to wait for all the leaves to drop. This statement is not intended to include nursery stock which is kept growing late in the season by late irrigation. Such trees are not desirable.

Time to Plant.—Early planting of common orchard fruits is of advantage for several reasons. First, an early-planted tree gets the full benefit of the season's rainfall, whatever it may be, and a late-planted tree, in a year with short rainfall, is apt to suffer during its first season's growth, unless it can be irrigated. The two main things to observe are the dormancy of the tree and the proper condition of the soil, and both of these are most apt to coincide in most parts of California about the first of

January. There will, however, be some variation from year to year, and different parts of the State disagree as to date. Hence, the general rule must be based on conditions, that of the tree and that of the soil. If the novice can not judge these for himself, he must get the advice of some one of experience in the locality.

The dormant period of a tree in California, as has been stated in another connection, is very short. As many cold-climate annual plants become perennial here, so our deciduous trees, in comparatively frostless portions of the State, evince a tendency to become evergreen. The period of dormancy in the root is also shorter than the inactivity of the top. Trees transplanted early are found to have their root wounds calloused over and new rootlets considerably advanced before the buds swell. Therefore, by early planting the tree begins soon to take hold upon the soil, the latter being well settled around them by rains, which often follow early planting, and the high winds, which are apt to come in the spring in some parts of the State, find the tree well anchored and ready to maintain itself.

Again, the proper condition of soil, if not seized at its first coming, may not recur until after the great storms of the winter are over, say in February or March (in most parts of the State), and then often the buds are bursting into bloom and leaf. Planting when the soil is water-soaked and cold is very undesirable, for in such condition it can not be properly disposed about the roots, and trees moved at this period are apt to show their dislike of the treatment. If the work has been delayed unavoidably, so that early planting can not be done, it is better to keep the trees heeled in until the proper soil condition returns, even if it be rather late, for a little extra attention to cultivation for retention of moisture will pull through a late-planted tree.

These remarks are of very wide application in this State, but there are exceptions. In our high altitudes, where the climate approaches Eastern conditions in cold and snowfall, practise in planting will also approximate Eastern methods. In regions of very heavy rainfall and on the upper coast where the rainy season and moisture from fogs are prolonged late in the spring, late planting is safer and surer than in the warmer, drier parts of the State.

Another consideration, too, is the slope of the land to be planted. Our hillside fruit growers in regions of heavy winter storms sometimes plant slopes, which, if plowed deep in the fall, are apt to wash badly during the heavy winter rains. On such slopes it is better to plow late in the winter, after the heavy storms are over, and plant when the soil has become warm and mellow.

THE OPERATION OF PLANTING.

Tree planting should be carefully and well done, but it need not necessarily be slowly done. With a kind soil deeply worked and just in the right condition for planting, trees may be put in well and rapidly. Two men work together at a decided advantage. Using the straight "tree-setter," which has already been described, one takes each end, and as soon as the center notch incloses the tree stake, the setter stakes are pushed into the soil, the "setter" is laid aside, and the two men, taking up their shovels or spades, begin first around the outside of the hole, throwing all the surface dirt on the same side of the hole and leaving the tree stake to be thrown out last, because its remaining serves to center the hole. The lower soil is now thrown to the other side of the hole, and when depth enough is reached, the soil at the bottom of the hole is loosened up to the depth of a shovel-thrust, without removing it from the hole. A shovelful or two of the surface soil is thrown into the center of the hole, being allowed to remain higher in the center, because this generally furnishes a cushion about the natural shape of the under surface of the root system of the tree. Now replace the tree-setter upon its end pegs, let one man hold the tree with its stem in the central notch in the setter, and while the other man shovels in the surface earth rather slowly at first, the man who holds the tree with one hand will spread out the roots, pulverize and pack the earth around them, being sure that no cavities are left under any of the roots, but that their surfaces everywhere come in contact with the soil, and that they spread out as widely as possible. The earth is being continuously put in by the shoveler, and when the roots are covered the planter steps in the hole and carefully firms the soil down upon the roots by tramping (especially at the cut ends of the roots around the outer side of the hole), at the same time judging of the perpendicularity of the tree with his eye. When this is done, both men use their shovels and fill up the hole with the earth taken from below, being sure to leave the last few inches at the surface pulverized, but untramped, unless the soil be very light so that tramping will not overpack it. Some one said long ago that one should not plant a tree as he does a post, ramming down the earth to the very top of the hole. Many trees are doubtless ruined by overzeal in this respect.

The shovel has been mentioned frequently as the tool to be used in planting. Where the soil is deeply plowed, well worked, and free from stone, the shovel is the most rapid tool. Under other conditions the long-handled spade, and in some cases the long-handled spading-fork, serves admirably in loosening the soil at the bottom of the holes and in breaking up lumps while filling in. One man with a shovel or spade, and the other with the fork, makes a good combination in this respect.

Planting in a Furrow.—A practise which has been largely followed in the Sacramento Valley and which attains greatest speed and cheapness consists in laying off as described on page 93, and then proceeding with a heavy listing plow, followed by a subsoil plow in the same furrow. The trees are then rapidly set with the least digging. This is all done before the field is plowed. Plowing immediately follows planting. The advantages of this method are ease of work on firm ground instead of a plowed surface, and escape of injury to this surface by men and teams in planting after plowing.

RANDOM SUGGESTIONS.

The roots of every tree should be examined before planting. All large root ends should have a fresh, clean cut with a sharp knife or shears. Make a slanting cut with the cut surface on the underside of the root. Where a root is mangled or bruised, it should in most cases be cut back to a sound place.

The tree should be placed if possible with the same side toward the sun as was exposed to the sun in the nursery; at all events, the wound made by the cutting away of the seedling stock above the bud should be at the north or northeast, in order that this weak point may be shaded as much as possible from the afternoon sun.

If the roots of the young tree grow more to one side than the other, place the strongest roots toward the prevailing wind.

The use of water to settle the earth around the roots is sometimes desirable in sections where the rainfall is light or uncertain. Pour in the water after the hand-work in spreading the roots and in pressing the soil under and around them has been done and the hole partly filled. When the water has soaked away, fill the hole with fine earth *without* tramping. In early planting in parts of the State where the rainfall is abundant, there is no need of the troublesome process of water-settling; in late planting, however, it will sometimes be found of advantage. Puddling the roots, or dipping them in thin mud and planting with this mud adhering, is governed by much the same conditions as water-settling; it may insure the growth of the tree when otherwise it might be seriously injured by drouth. With puddled roots especial care should also be taken to leave the surface loose to prevent evaporation. In making puddle, use loamy soil and never adobe, for in dry time the latter will bake around the roots and often kill the tree.

The Use of Manure.—Never put manure in the hole with the tree. Sometimes the injunction is, Never put anything but well-rotted manure in the hole. It is better to put none of any kind. Manure should be spread upon the ground after plant-

ing. The rains then leach it out and it may be turned under in the spring plowing. There are, however, light soils in the drier parts of the State where turning under manure in the spring is a disadvantage, as it makes the soil too porous and facilitates evaporation. On such soils, extra care should be taken to have the manure thoroughly decomposed by composting, as will be described in the chapter on fertilizers, and all applications should be made either late in the spring to act as a mulch during the summer, or if a mulch is not thought desirable, apply the manure in the fall before the first rains, so that it may be turned under at the first plowing and have the whole winter for disintegration. In this dry climate there is often misapprehension, especially among newcomers, as to what is well-rotted manure. They take the scrapings of the corral, which have been trampled and pulverized, but which, having been kept dry, have never rotted. When this is put in the holes with the tree and then moistened by rainfall or irrigation, it will burn the tree, the first sign of the injury being the drying up of the leaves. It is, on the whole, safest and best to put nothing but well-pulverized surface soil around the roots of the young tree.

Depth of Planting.—The depth to which trees should be set has always been a matter of discord among planters. The safest rule under ordinary circumstances is to get the tree as nearly as possible the same depth it stood in the nursery row; that is, so as to have it stand that way when the ground has settled, or the surface returned by cultivation to its normal level. In planting in loose soil in the drier parts of the State, it is often desirable to plant rather low, because several inches depth of the surface soil become dry, and it is desirable that the roots should be well in the moist layer. But if irrigation is to be practised, it must be remembered that the water level will rise when the soil is saturated, and deep-planted trees are apt to suffer. The experience of recent years is decidedly against deep planting, which used to be advised because of our dry climate. Thousands of trees have been ruined by planting too deep.

Speed in Planting.—On good soil, well prepared, trees can be put in rapidly and the job still be well done. It is reported that on one occasion, in planting almonds, twenty men finished sixty-four acres from Friday noon to Wednesday night, placing the stakes, digging the holes, and planting the trees. This would be almost three-quarters of an acre per day per man. In planting peaches and apricots an average of one hundred trees per day to the man has been attained. On the mellow loam, in another case, the average was one hundred and twenty-five trees to the man, digging holes two feet square in land which had been plowed twelve inches deep. Such work is only

possible on good soil, well prepared, and by men who work well together.

Mapping and Labeling.—Where mixed varieties of fruit are planted, the orchard should be mapped as soon as the trees are set. A good durable map is made of the glazed muslin, such as carpenters and architects use for their drawings. The map can easily be drawn to a scale by using a fraction of an inch to represent a foot. After the map is made, it can be rolled on a broom stick and is easily preserved. With such a record, the grower need not care what becomes of the labels, as he can locate a variety any time by its row and tree number. If, however, one desires labels, let them be made in this way: Take a piece of common sheet zinc five inches wide. Across this cut pieces three-quarters of an inch wide at one end and tapering to a point at the other. Near the wider end write plainly with a common lead-pencil the name of the variety. This will get brighter by exposure to the weather. The small end may be coiled around the branch of the tree; it will yield as the tree grows and will do no injury. Such labels will last for a long time. Labels attached by a cord or wire should be removed as soon as the trees are set, for they are apt to be forgotten and the tree seriously injured by the cutting in of the ligature. Even when labels are used the map is the only surety, because any kind of a label is apt to be lost by accident or by malice or mischief of intruders.

Mulching.—Although early-planted trees on deep soils in regions of sufficient rainfall need only good cultivation after planting, there are cases in which mulching is desirable. Various light materials may be used for a mulch, but nothing is better than well-rotted straw, in which fermentation has killed all weed seed. Apply it to a distance of two feet around the tree, and to a depth of not less than six inches. It is best done as soon as the tree is planted, and is to be especially recommended when late planting is practised. Even in localities of light rainfall, if the trees are well mulched early in the winter, irrigation may be unnecessary for the young deciduous tree. Trees planted very late in the spring may, by using great care and mulching well, make as great a growth as those set out early in winter. This should not be an excuse for late planting, but we mention it to show that where late planting is necessary, mulching will help the trees to pull through. It is a far easier way of keeping the ground moist than by irrigating. Of course this does not mean that a mulch will obviate irrigation where systematic irrigation is found necessary, though there are indications that irrigation may often be lessened, and in some cases obviated, by extra cultivation or mulching, at least until the trees come into bearing.

Guarding against Sunburn.—Newly-set trees should be protected against sunburn. There is nothing easier and neater than to push a “shake”* into the ground so that its shadow will shade the stem of the tree from the afternoon sun. If set on the southwest side, it will do this. Where shakes are not at hand or are too expensive, the stem of the tree may be bundled with straw or wrapped with paper. Manufactured “tree protectors” of paper which are readily adjusted around the trees are now largely sold. Such protectors, when made of blackened paper, have been found to invite sunburn instead of preventing it. This objection does not hold to the use of light-colored material. Whitewash made according to the formula given at the close of Chapter IX is a good protection from sunburn. For young trees, however, it should be made with air-slacked lime, which has lost some of its causticity. Another whitewash, which has been largely used for young trees, consists of four ounces of whale-oil soap dissolved in each gallon of water, whitening being stirred in to give the solution a paint-like consistency. Millions of trees have perished in this State, and as many more been condemned to sickly lives, because of sunburn, and borers which seek the injured bark for entrance. Pruning has much to do with saving trees from this evil, as will be shown in the proper connection, but in the hotter parts of the State, the first precaution should be to shade the bark of the young tree with some artificial protection.

Cutting Back at Planting.—Whatever idea the grower may have as to shaping his tree, it must be cut back when planted. Lifting from the nursery has removed a considerable part of the root system of the young tree and the top must be reduced accordingly. The planter who dislikes to sacrifice the fine top will sacrifice future growth and vigor by retaining it. The tree may struggle through and regain strength, but it will for years be smaller than if it had been properly cut back at planting. If the moisture supply should be short, a tree may die the first summer which would have survived if differently treated at planting. The manner of cutting back depends somewhat upon the style of pruning to be followed afterward, as will be considered in the next chapter.

*Shakes are pieces of wood three feet long, six inches wide, and one-quarter of an inch thick, split or sawed from California redwood.

CHAPTER XII.

PRUNING ORCHARD TREES AND THINNING FRUIT.

It is not intended to enter into a discussion of the general theories of pruning. The reader desiring to pursue them is referred to the abundant literature on the subject in Eastern and European treatises. The effort to approve or condemn these theories by considering them in the light of California experience and observation might lead to interesting conclusions, but it has no place in a work aiming merely at an exposition of what appears to be the most satisfactory practise in California fruit growing. It will be found that this practise varies somewhat in the different regions of California, sometimes in degree, sometimes in kind, because of different local conditions, and it might be found that nearly all reasonable theories of pruning could be verified in California experience.

Pruning in California is at present almost exclusively a *shaping* process. Our fruit trees are naturally so prone to bear fruit that pruning to produce fruitfulness is seldom thought of, and still more rarely practised, while pruning to reduce bearing wood, and thus decrease the burden of the tree, is quite widely done, to take the place, in part, of thinning out the fruit. Pruning to restore vigor to the tree, as in cutting back to make a new head, is also rather a rare proceeding, probably because our trees are generally too young to require it. We prune, then, for shape and for the many practical advantages which inhere in the form now prevailing in California orchards. Some of these advantages are peculiar to our climate; others we share with those who advocate a similar form elsewhere.

Our best orchards of the same fruits in adjacent localities are almost identical in form and general appearance of the trees, and those more distant differ chiefly in the extent to which the same principles are applied. And this is not because the trees are allowed to follow their natural inclination, which should secure resemblance, but because their natural bent is resolutely conquered by agreement of growers that they know what is good for the tree; and this substantial unanimity is the result of the experience of the last forty-five years. People possessed of the art temperament sometimes complain of the depressing uniformity and artificiality of orchard-tree shapes in California.

They are apt to lament the fact that systematic orcharding destroys the picturesqueness of tree-growth. They should understand that such conception of a fruit tree has no place in commercial fruit growing. The producing tree is the result of the conception of an agency to serve certain purposes. The orchardist does not pursue uniformity merely for its own sake, but rather for the purpose it serves, and the fact that many thinking men have practically agreed upon a certain form as an ideal of producing ability is demonstration that such form is, at least, approximately correct. There is an industrial conception of an agency which is necessarily and essentially different from an art-conception of picturesqueness based upon the feral type. The wild tree is rude and crude from a cultural point of view.

PRACTICAL PURPOSES OF PRUNING.

One of the first things for the beginner to undertake as he approaches the practise of pruning trees and vines is to form some conception of the purposes to be served. Imitation is not the foundation of intelligent pruning, though it yields many valuable suggestions. Satisfactory work rests upon a correct understanding of the reasons for each act and to the attainment of this, all study, observation and experience should tend. Possessing this, one can proceed capably, modifying method to meet condition, and producing desirable results. Receive all suggestions and then go quietly to the tree and study your problem in its shade. The tree is the best revelator of its needs. Some of the best pruners in California are men who were untrained to horticulture before they entered upon their orchard work. Reading, discussion, systematic instruction are all valuable. They save much time and many errors, but recourse to the tree affords the sovereign test of attainment.

These may be counted among the practical purposes to be attained by pruning in California: (*a*) Convenience of the grower; (*b*) health and strength of the tree; (*c*) regulation of heat and light; (*d*) attainment of strong bearing wood; (*e*) attainment of size in fruit; (*f*) promotion of regular bearing. Examine trees with reference to their embodiment of these characters and one can hardly fail to secure rays of light upon the subject of pruning which seems dark to so many.

Convenience.—Trees which branch near the ground are most quickly and cheaply handled in all the operations of pruning, spraying, fruit-thinning and picking. Low trees with obliquely-rising branches are more easily cultivated than any form with horizontal branches, unless the head is carried so high that the animals pass easily under the tree. To do this sacrifices all the other conveniences and economies which actually determine

profit, and is really out of the question from a commercial point of view. Sometimes it does not pay to pick some fruits at a certain distance above the ground, when picking at half that distance yields a profit.

Health and Strength.—It is imperative in most parts of this State that the sunshine be not allowed to touch the bark during the heat of the day. This protection is secured even for young trees by low branching and the encouragement of small, low laterals. The low tree with properly spaced branches attains superior strength by virtue of thick, strongly knit, short growth between branches, and by its strong, stiff, obliquely-rising growth sustains weight which brings horizontal branches to the ground, and thus even high-headed trees are liable to continually increasing interference with cultivation, and the desperate grower has to raise the head of his tree higher into the air and farther above the profit line, while at the same time he renders it more liable to sunburn, to bark-binding, and to unthrift by forcing the sap to flow an unnecessary distance and through wood and bark which impede its movement. Besides, a low tree escapes stress by strong winds which a high tree invites and at the same time is less able to withstand. Pruning for health and strength of tree also includes the removal of unthrifty or diseased parts, which are not only an encumbrance to the tree but may communicate to other parts the causes of their ill condition.

Heat and Light.—The maintenance of strong bearing wood in the lower part of the tree is conditioned upon the proper pruning of the top of the tree. How far the upper levels or the shade-layer of the tree can be safely opened, depends upon the local climate in each fruit region. The rule must be the higher the summer heat the denser the tree; the lower the heat the thinner the tree; but everywhere the proper condition of openness must be constantly in view in pruning. Not alone must this be done to maintain thrifty growth below, but it is also essential to the best growth and ripening of the fruit in the lower and interior parts of the tree. Fruit inferior in size, color and quality results, in part, from lack of pruning to regulate the admission of light and heat, sometimes one sometimes both, to the shaded portion of the tree.

Bearing Wood.—Good fruit develops on good bearing wood and good bearing wood is the product of proper degrees of light and heat, as has just been urged. But bearing wood in the case of some fruits is new wood, and reduction of old wood for the purpose of forcing the growth of new wood must be constantly in mind. Renewal is more or less a consideration with all trees, and especially the securing of strong new wood. This is a point upon which close study of the bearing tree will yield most satisfactory suggestions.

Size of Fruit.—The size of fruit, providing the tree is healthy and vigorous, depends upon the character and amount of bearing wood which the tree is allowed to carry. Removal of part of the fruit burden is done by thinning after it is well set, but this labor should always be minimized by antecedent pruning, which adjusts the retention of bearing wood according to the vigor, size and bearing habit of the tree. Thinning out of bearing shoots and spurs, when either are clearly seen to be in excess, should be the constant study of the pruner.

Regular Bearing.—This point is largely involved in the preceding and affords an additional incentive. Regulating the amount of fruit borne in one year involves the profit of two years, because a tree can not produce an excessive amount of fruit and perfect good fruit buds for the following year. It may generally make buds which will bloom, but not always that. If it does make the bloom, it is no guaranty that the bloom will be strong and effective for bearing. Consequently, pruning for reasonable amount of bearing should always be borne in view and should be practised at the close of the year of non-bearing with particular diligence, if the alternate year bearing habit is to be broken up.

The foregoing are among the practical purposes to be served in pruning. There are others, but these will suffice to emphasize a single point, and that is, that pruning can not be compressed into a single formula, nor can one learn it by a recipe. There are various ends to attain; they may be attained in different ways, although it is not strange that substantial agreement in methods does largely prevail. It is better to try to understand the purposes than to memorize formulæ. Get the tree and its interest clearly in the mind; have an ideal toward which to work; be more interested in why a neighbor prunes in a certain way than how he does it. Learn constantly by all available means, and at the same time study the visible forms and aim to understand their fullest significance.

FORM OF TREE BEST SUITED TO CALIFORNIA CONDITIONS.

The form of deciduous fruit tree which prevails with singular uniformity all over the State is the "vase," or "goblet," or wine-glass" form, all these terms signifying a similar general shape. There are different ways in which this form is secured and maintained in different parts of the State, and with different fruits, which will be especially noted in the chapters devoted to these fruits.

The mainspring of success in California is to grow low trees. Low is a term admitting of degrees, it is true, and may imply a trunk six inches up to one of two feet, in the clear. In addition to the general advantages of low-trained trees, which have been

described, there are special reasons for this form in California. Hundreds of thousands of trees have been destroyed by the exposure of a long, bare trunk to the rays of the afternoon sun. The sunburned sides have given the conditions desired by borers, and destruction has quickly followed. Sometimes young trees have not survived their first season in the orchard, because of burned bark; or this, with the added injury by the borers. It is also found by California experience that growth is more vigorous in the branches when they emerge near the ground. Even where actual burning may not occur the travel of the sap through the longer distance of trunk is undesirable. It is believed, also, that benefit results from shading of the ground at the base of the trees, by reducing evaporation, and by maintaining a temperature of soil better suited to vigorous root-growth.

But whatever may be the reasons, the fact is indisputable, the higher the prevailing summer temperature, and the greater the aridity, the lower should the trees be headed. Trees which will do well in the central and upper coast region and adjacent to the bay of San Francisco, with twenty-four to thirty-six inches of clear trunk would dwindle and probably perish in the heated valleys in all parts of the State. In such situations, both north and south, the best practise is to head the tree fifteen, twelve, and some even hold as low as six inches from the ground. There will always be some difference in opinion as to detail, but the necessity of making the trunk short enough to be effectually shaded by the foliage is admitted by all growers.

Characteristics of the California Vase Form.—This vase form is a product of French ingenuity in the training of dwarf trees, but it has undergone very marked modification in California, losing much of the accuracy of its outline and gaining vastly in speed of work and in bearing capacity of tree without sacrificing any practical value which inheres in the design.

The California vase form dispenses with the central stem or trunk at a certain short distance above the ground, but this is not done for the purpose of securing a hollow or open-center tree, which is a leading characteristic of the old European vase-form. The few branches which are taken out from the short stem are pruned when the tree is young to induce successive branches with short interspaces. At each cutting the aim is to get two branches from one, and as nearly as possible of equal vigor, so the California tree does not, except, of course, in occasional instances, show the outline of a leader from the bottom to the top, but there is a succession of branchings, turned this way or that by the skillful pruner, occupying available air space, distributing the weight so it comes more nearly over the center of gravity and at the same time knitting the fibers of the branch so

that the weight of the fruit is well sustained. This idea, however, is not allowed to go so far as to wholly close the interior of the tree, but to retain such degree of open interior as is found desirable. When the tree is laden with fruit, the weight naturally expands the top quite enough to admit the sunlight without exposing either the fruit or the branches to danger of burning. Thus it appears that instead of the true vase or wine-glass, with hollow interior and thin walls, we have the general exterior outline of this model, but give a good part of the central area of the figure to bearing shoots, and thus secure a large bearing surface with well-strengthened supports.

It has been found that this many-branching form, developed upon a few main branches well placed upon the trunk, gives a stronger tree than can be had by growing a considerable number of leaders, all starting from near the point where the tree was headed at planting. Such leaders crowd each other at the point of emergence from the stem, and when laden with fruit, sway outward and break out at this point. A vastly stronger tree is secured by starting but four or five branches from the low trunk and letting them emerge from different sides of the stem, and at different levels. Thus each main attachment to the stem has abundant room, and the wood enlarges symmetrically and solidly. The expansion of the top is attained by the branching which follows the cutting back of succeeding years. Starting branches from nearly the same level on the stem has been the occasion of great losses of overladen trees, and quite a considerable recourse to strengthening up weak trees by running bolts through from side to side at the points where experience shows breakage is likely to occur. In this respect it is now clearly seen that the practise which was widely adopted a few years ago of beginning with a very short stem and using the three or four adjacent buds nearest the point to which the tree was cut back at planting is defective. It is much better not to cut back so far at planting, but to leave a longer trunk, keep a greater distance between the main branches and still have the lowest branch as near the ground as before, thus securing a tree which is practically as low as that secured by the old method of starting. This point will be enforced by illustrations.

HOW TO SECURE THE DESIRABLE FORM.

For the benefit of the inexperienced reader, it will be well to illustrate the steps by which the form of tree found so generally desirable is to be attained.

Cutting Back at Planting.—This has been shown on page 112 to be essential to strong growth of the transplanted tree. It is also the prime act in securing a tree with a low head and

strong branches. Formerly trees were cut back farther than desirable and the branches allowed to crowd each other, as has just been stated. It is better to retain twenty-four inches of stem than twelve inches—providing care is taken during the first summer to prevent, by pinching, the growth of too many branches near together. Allow those to grow which are more distant from each other on the stem and pinch the intervening shoots. In this way one can have the lowest branch at six inches from the ground in the hot valleys if desired, or twelve inches in the coast valleys, and the highest branch at eighteen or

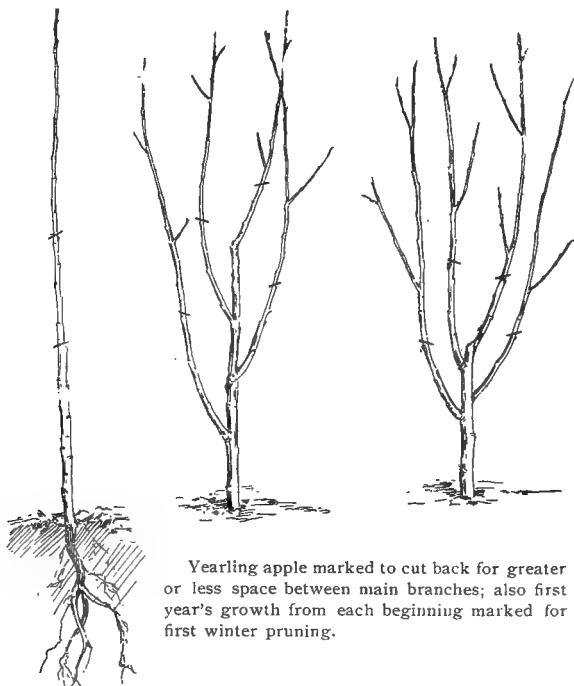

Yearling apple marked to cut back for greater or less space between main branches; also first year's growth from each beginning marked for first winter pruning.

twenty-four inches. This gives about twice the distance between the main branches which was formerly allowed, and it is of vast advantage to the strength of the tree. The illustrations of this fact are from trees planted by the writer in 1887 to test this matter. At this date they are large trees and show the forms of heads resulting from different spacing of branches on the young trees during the first summer's growth.

First, then, cut back the tree just after planting, as shown in the engraving, deciding first at what height you wish your trees to form heads, and cut them all back as uniformly as pos-

sible and still secure a good bud just below the point of cutting. To preserve these buds the trees should be handled carefully while removing from the nursery and during planting.

If the tree has already grown laterals where the head is desired, three or four of these properly placed on the stem may be selected to form the main branches, shortened in to the sound bud nearest the stem, and other laterals, not desired to form the head, removed. This treatment is shown in the engraving of a young peach tree well branched in the nursery. If all the laterals on the young tree have started out above where the head is desired, as is sometimes the case, it may be necessary to remove the whole top, and usually others will start below afterwards.

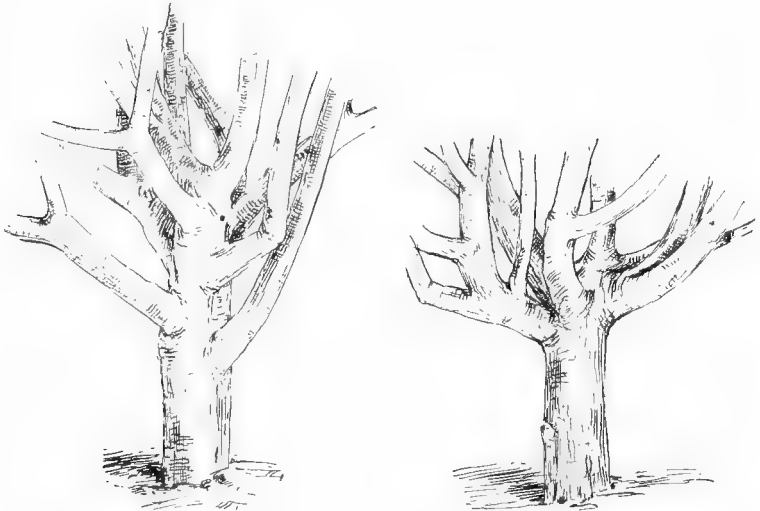

Twelve-year-old apple trees in the writer's garden at Berkeley, showing forms of head resulting from cutting back for greater and less spacing of main branches at planting in 1887.

If there are no buds visible on the stem at the place where the head is desired, the choice must be made between heading the tree higher up, where the buds are, or cutting back without regard to buds, trusting to the development of latent buds at the right place, or to the growth of a shoot from below which can be cut back to form a head the following year. It is for this reason, among others, that planters prefer a yearling tree which has not branched, but has good buds all along the stem; but peaches and apricots usually branch in the nursery.

After cutting back at planting, the shoots desired to form the head are allowed to make their full growth without interference. All shoots not desired for branches are pinched off

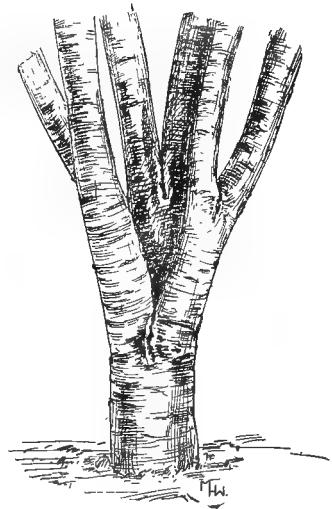
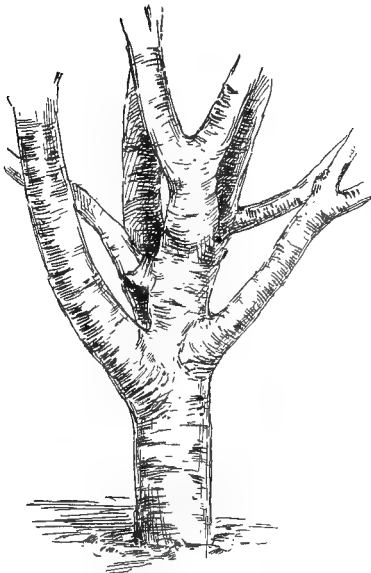

Apricot and cherry trees twelve years old, showing results of cutting back to longer and shorter stem at planting, in 1887, as an experiment in head forms.

after growing out two or three inches, leaving a bunch of leaves to shade the trunk and contribute to its stouter growth. Constant watchfulness is necessary to pinch off undesirable branches all the first summer.

First Pruning.—In the winter following planting, the previous season's growth is cut back to about ten or twelve inches from their junction with the stem. Some prefer to cut shorter, but this is apt to huddle the branches too close together when they get old and stout. Growers, however, do not agree on the exact length which these future main branches should be left at the first pruning.

If, during the first summer's growth, all shoots except the number desired to form the head have been pinched back, the

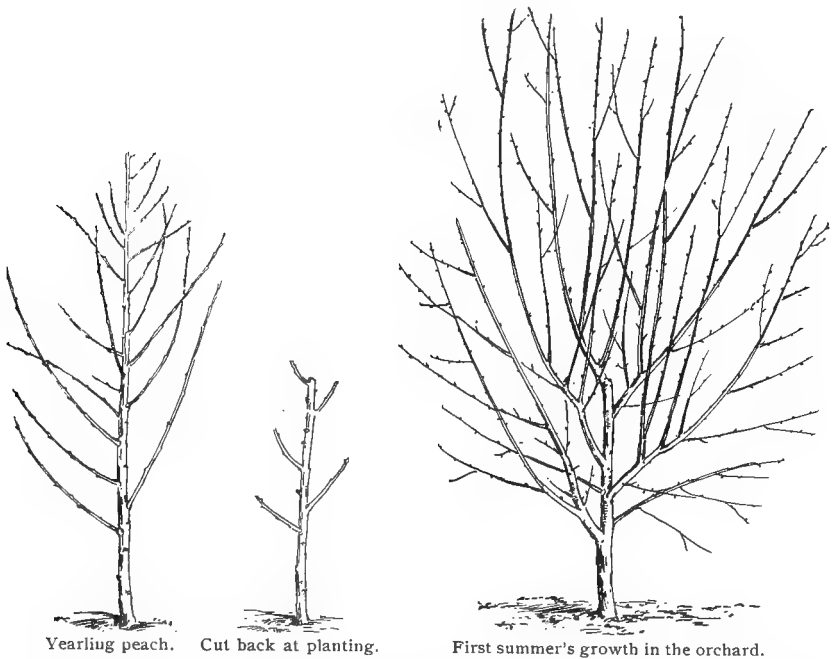

Yearling peach.

Cut back at planting.

First summer's growth in the orchard.

first winter pruning consists only in cutting back the main branches. If laterals have grown on the parts of these branches which are to be left on the tree, they should be cut back to a bud or two. This is better than removing them entirely, for the next summer they will be pinched after throwing out a few leaves to shade and thicken the branches, just as the short growths left the previous summer serve the main stem.

Second Pruning.—During the second summer it is usual to allow two branches to grow from each of the main branches left at the previous winter pruning, and to pinch off all others, as described. These branches are allowed to run out their full growth, except where excessive growth is made, and then it is repressed by summer pruning. This is done with the apricot

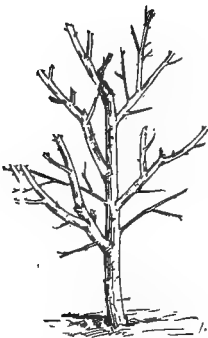

First winter pruning.

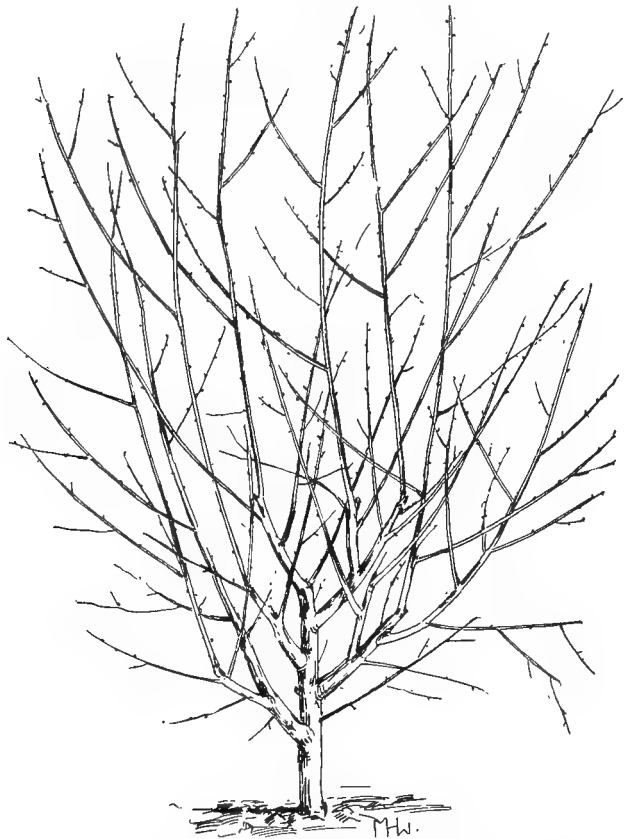

Second summer's growth in orchard.

in the warmer parts of the State, as will be considered at length in the chapter on that fruit. Usually, however, the main branches are untouched during the second summer's growth. During the following winter the main branches are cut back from one-half to two-thirds of the growth they have made, and if too many strong laterals have grown below this point, some are shortened, others are removed entirely where they are apt

to cross or crowd each other. It is not desirable, however, that all small growth should be cleanly removed. Some of these small shoots will bear a little fruit and the leaf action is in any case desirable as a contributor to the strength of the larger branches to which they are attached. Besides, they serve to shade the bark from sunburn.

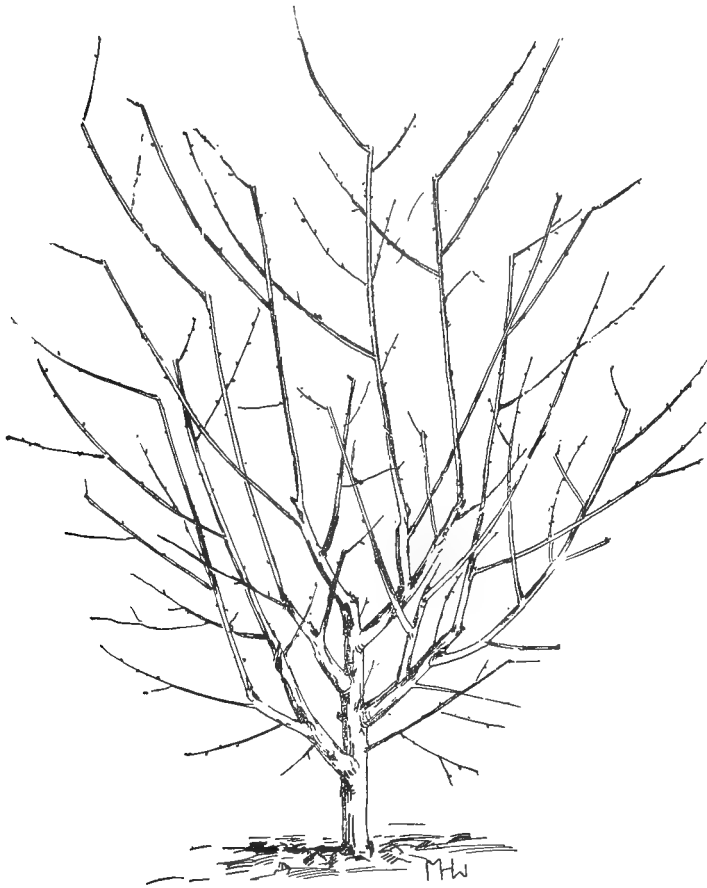

Second winter pruning in orchard.

Third Pruning.—When the tree reaches its third winter pruning, its form is well outlined, and early-bearing trees like the peach, apricot, almond, Japanese plums, etc., will give the grower a respectable crop the next season. To bear this crop greater care should be taken at the third winter pruning to leave the small laterals low down on the main branches, for on

them, clustered close in the head of the tree, most of the first crop will be found. Though some trees, as stated, do bear earlier than the third summer, the fruit is not usually considered of commercial account until the third summer. An en-



Young peach and apple trees, showing branches well spaced on the stems.

graving is given of a peach tree just after its second winter pruning. It is a very good representative of the vase-form of a tree as grown in California. It has four main branches, each issuing from a different point on the stem, each permitted to



Weak tree from ill-spaced branches.

carry two main branches, which are not arranged around the circumference, but some of them tending toward the center. At the third pruning more shoots have been left than are required by the rule, for, starting with four main branches, there are usually sixteen left at the third pruning.

PRUNING BEARING TREES.

Three winter prunings of deciduous trees usually establish their permanent form, and subsequent pruning is chiefly directed toward the retention of that form; for strength of branch and stem; for renewal of bearing wood; for regulation of amount of bearing wood; for relative light and shade, and for convenience in cultivation and other orchard work. Naturally, these ends are sought according to the needs and habits of different fruits, and the methods of attaining them will be discussed in the chapters treating of these fruits. There are, however, certain general considerations which are proper in this connection:

Pruning during the dormancy of the tree induces greater growth of wood during the following summer; pruning during the active period reduces wood growth and promotes fruit-bearing. The greater the amount of wood removed during the dormant period will make the summer growth of wood proportionately stronger. Whether the total weight of wood growth would be greater may be questioned, but the effective wood growth is certainly greater. Whether the *total* of new wood grown on a peach tree cut back to stumps in the winter would be greater in weight than all the *inches* of growth which would be scattered all over the surface of the tree if not cut back, may be doubted, but the new growth secured by cutting back will be of immense vigor and the following year will bear large fruit, while the new growth on the tree not cut back will be thin and short and the fruit indifferent. The weaker the tree or the branch or twig of the tree, the greater the part of it to be removed when dormant to get the stronger new growth.

Pruning during the active period of the tree, or allowing it to go uncut during the dormant period, have the same effect, viz., the promotion of fruiting. Some trees, like apricots and peaches, which bear upon new laterals, will bear fruit even though heavily winter-cut, if these small laterals are retained on the lower parts of the main branches. Some other trees, like the prune, which bears on spurs, will delay the formation of spurs if heavily winter-cut. These two facts suggest two diverse policies in pruning bearing trees: A peach tree unpruned will reduce its crop for lack or weakness of new laterals; a prune tree too severely winter-pruned will reduce its crop for lack of old spurs. Again, some fruits, or varieties of fruits, bear chiefly upon the tips, others chiefly upon the lateral spurs; shortening one reduces the crop largely; shortening the other may increase the marketable crop by decreasing the aggregate number. These and other similar facts suggest that pruning bearing trees, to be intelligently pursued, must be accompanied with the fullest pos-

sible knowledge of the bearing habit of the fruit or variety thereof.

Cutting back or "shortening in" should be done in a way which will reduce the burst of new shoots near the cut. This is measurably secured by always cutting the branch at a strong lateral, because the sap flow into this lateral prevents undue pressure and forcing of latent buds in the vicinity of the cut. For this reason the cutting back of all branches to a certain definite height is wrong. Trees shorn across at a certain line become thick as a brush with top shoots which require extensive thinning, or the bearing wood will soon be all at that level through failure of the densely-shaded bearing wood below. Cut to the nearest lateral below the line you wish to approximate, and shorten that lateral if desirable, and the result will be fewer and stronger shoots than from a stub-cut.

In the treatment of bearing trees the main effort should generally be toward thinning or reducing the number of bearing shoots. This is related to the important work of thinning the fruit to reduce the burden of the tree, and will be mentioned again in that connection. The work has, however, a bearing beyond the size of individual fruit specimens. It involves the whole future of the tree as a profitable affair. An unthinned tree becomes a thicket of small, weak and dying laterals and spurs. An attempt to cure this afterwards by sawing out many large branches is only partially successful, though perhaps the best thing that can be done after such condition has been allowed to exist. The only way to keep the interior of the tree full enough of strong, bearing wood is to resolutely and regularly thin out surplus shoots as the tree advances in age and size. This work is as important with trees which are not regularly cut back, as with those which are thus treated. It is one of the most vital as well as the most generally neglected item in orchard practise.

In thinning out lateral bearing shoots seldom leave more than one at any point; select the strongest; remove the rest close to the branch. When a new shoot springs out at the base of an older one remove the older one; when a new shoot breaks out on the side of an older one cut the older one back to that point. In thinning always reject the older, weaker laterals or spurs. This does not apply to the outbreak of strong suckers or water sprouts below the main branches; they should usually be cleanly cut away unless a new main branch is desirable.

Pruning of bearing trees should always have regard to the removal of branches which have become decrepit through sunburn, blight or disease of any kind, frost injury, or any form of die-back from whatever cause. Such wood is not only of lessened value, but there is also danger of extension of the trouble.

Removing such wood and training new wood to take its place should always be in mind.

Where cutting of large branches is demanded for any reason it should be remembered that the wounds are most quickly healed and least injury to the tree is to be apprehended if the cutting is done near the beginning of the growing season.

TIMES FOR PRUNING.

Some changes of view have lately prevailed as to the times, within the dormant period, during which winter-pruning can be done to the best advantage. Formerly it was thought to be a vital matter that no cutting should be done until the leaves had fallen, and this is still the prevailing practise, and may prove to be on all accounts the best. Recently, however, pruning in autumn has been quite widely practised.

Fall Pruning.—There is a time near the end of the active season in California when the foliage changes its aspect. There is no marked change in color, perhaps, but there is a certain limpness and drooping which betokens decided decline in activity. It comes first to the early fruits, the cherries and apricots, for instance, and upon old trees earlier than young ones. The buds are well formed; the season's growth apparently complete. There are no frosts to hasten the fall of the leaf and it remains in place. Does it render any important service? On the conclusion that it does not, many growers begin the winter pruning while the days are longer and ground dry and firm rather than delay pruning until the short, dark days and rain-soaked soil of December and January render pruning expensive and disagreeable. Those trees are first pruned which first assume the appearance described, and the work proceeds with other varieties afterwards until the winter pruning is finished by December 1—about the time when it commonly began under the old practise. Not only is more thus accomplished in the same number of days' work, but the orchard is earlier in shape for the winter spraying and cultivation, and the grower is ahead of his work and not behind it all the season if the season is unusually rainy. Several years' practise of this method discloses no bad results except in the one item of increasing danger from frost. Vines and trees pruned early in the dormant period have a tendency to start growth earlier than those pruned late in the dormant period. In places, then, where early bloom and fruit-setting are particularly threatened by frost, this practise may be undesirable. The method is rather new and not widely tried and awaits fuller demonstration of its standing.

Spring Pruning.—Resting largely upon this matter of retarding growth, the practise of pruning very late in the dormant

period, or, in fact, at the beginning of the growing season, is also gaining wider adoption where frost injury is especially feared. It is not actual freezing, but a drop of two or three degrees below the freezing point which is feared, and during recent years such a temperature has wrought havoc with some fruits, in early valley regions particularly. Later pruning, even after the bloom and foliage have appeared, has worked no injury to the trees, but it is less conveniently done than when the trees are free of foliage.

Summer Pruning.—Summer pruning, to induce bearing, is, as has been previously intimated, but little employed in this State, for the constant tendency of our trees is to bear early and to overbear. Enough has, however, been done in individual cases to show that fruit-bearing is promoted by pruning after the chief growth of the season has been attained. If the pruning results in forcing out laterals late in the season it has been done too early. What is desirable is the strengthening or development of fruit buds, and this will be accomplished after the energy has been too far dissipated to make new wood growth.

Summer pruning to check the too exuberant wood growth of some kinds of trees is employed to some extent, chiefly in the warmer parts of the State, where the vegetative process in some trees seems fairly to run riot, and unless checked is apt to ruin the tree by breaking to pieces when the wind and weight of fruit test its strength. The methods of summer pruning employed in different parts of the State for different fruits will be considered in connection with the special chapters on these fruits.

Summer pruning to preserve form is another matter, and relates in the main to pinching in, to check undesirable extension and to direct the sap toward shoots in which growth is desired. This practise is approved by most of our orchardists, and is employed by them to a greater or less extent. More people believe in than practise it, however, because the summer months, with their long succession of fruits to be gathered and shipped or dried, and the additional consideration that there is always a scarcity of labor at this time, give the orchardist so much work to do that he is more apt to confine his "pinching" to a little that he may do now and then when he has a few moments' leisure than to do the work thoroughly and systematically. The result is that the regular winter pruning is the main operation for tree shaping in this State.

There is such a great difference in opinion about summer pruning that it will be very difficult to make any assertions about it which will not be disputed. Much of this difference comes, of course, from different conditions prevailing in different trees and in different parts of the State, and some of these will be met,

as already promised, in following chapters. Leaving these wholly out of consideration at this time, it is safe to advise those who wish to secure symmetry or any particular form in any kind of a tree, that they can resort to summer pinching with advantage, and can sometimes to advantage remove wood too large for the thumb and finger to sever.

Constant watchfulness should be maintained for adventitious shoots starting out on stem or limb at points where branches are not desired. Wherever they start out strongly, they should be pinched, or entirely removed, according to the best judgment to be formed in each case. Suckers, which, properly, according to Downing, are "shoots sent up from the root or from parts of the stem below the surface of the soil," should be removed whenever discovered.

RENEWING OLD TREES.

Improving and renewing trees by cutting back and grafting has already been considered under the head of propagation. It is often desirable to renew trees of a satisfactory variety, and this is done simply by cutting back when the tree is dormant. Cutting back was formerly done early in the winter, before the rise of the sap begins, but more recently it has been seen that the exposure of large cut surfaces for weeks or months before growth begins, results in drying and shrinkage of the bark and checking of the wood, both of which are avoided by amputation later in the dormant period or during the early part of the growing season. In cutting back, of course, those stumps should be left to support new branches which will secure the best balance and symmetry in the new head. When the new growth starts, there generally appear many more shoots than are desirable, and selection of the best-placed and most vigorous should be chosen, the others either being rubbed off in the bud or pinched back when a few leaves are put out. In cutting back trees, the exposed trunk and branch stumps should be wrapped in old sacking, or carefully whitewashed as protection from sunburn.

In removing large limbs it is desirable that the cut should be made in the right place so as to secure quick covering of the scar with new growth. Cutting so as to leave a long stub results in an unsightly piece of dead wood on the tree, and this, in decaying, carries the decay deep into the center of the trunk or branch. Cutting too close prevents covering with the new bark, and also results in a hole in the branch. Cutting just to the right mark, which is the outer edge of the little collar or swelling which will be found at the base of all branches, enables the wound to grow over quickly, and if the wound is properly

treated when cut, there will be no decay, and the wound will soon be wholly obliterated.

In amputating large branches, an undercut with the saw should be made first so that the bark shall not be torn as the branch falls. Another good way is to saw off first at a distance from the final cut and then saw off smoothly at the right place when the weight is removed.

Trees often become "hide-bound," as it is called. Especially in this dry climate the bark gets dry and tough, therefore can not expand in proportion to the growth of the tree, or supply the amount of sap necessary for the demand. Slitting such trees here and there up and down the trunk and main limbs with a sharp knife seems to have good effect, for often in three months the cut opens half an inch, and a fine, clear bark, with an increase of growth, results. On old trees, too, there is often a growth of moss and lichens which should be removed. This can be done by scraping off the rough, loose bark and spraying with an alkaline wash, such as will be described in the chapter on injurious insects. This will remove the objectionable growth, give the trees a clean, bright bark, and, probably, contribute to their vigor as well as to their appearance.

PRUNING TOOLS.

There is some difference of opinion as to the comparative value of the pruning knife and the pruning shears. The knife, if sharp, and well used, makes a smooth cut, with no bruising of the bark, and such a wound heals over perfectly. The shears, if of good pattern and sharp, also make a very good cut, but there is always some little injury to the bark on the side opposite to the entry of the blade. On small cuts, say three-quarters of an inch or less, if the blade is kept very sharp, the resistance does not make sufficient injury to the bark to seriously consider, and the speed with which the shears can be used renders them the main reliance for all the smaller pruning. Nearly all styles of hand shears are used in this State.

There are, also, two-hand shears, which are very powerful, and enable one to work very quickly. When kept well sharpened they are very effective tools. There are a number of styles in use, both home-made and imported.

Still another arrangement of shears is mounted on a pole, the cutting blade being operated by a cord, and having a spring to throw the blade back. The pole is jointed, so that one or more lengths can be used. With this device one can stand on the ground and shorten in the top shoots of a tree very handily.

For larger cuts than can be made with the pruning knife or one-hand shears, there are pruning saws of different styles, of

which the two shown in the engravings are of California design and construction, being made by the Pacific Saw Company, of San Francisco. The frame is made of the best spring steel, constructed somewhat on the principle of a butcher's saw, with the exception of the saw blade being much narrower; and instead of being stationary, it revolves so that the pruner is enabled to

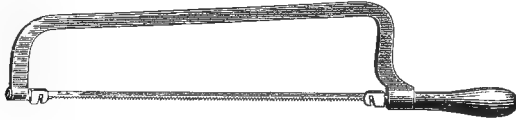

California Pruning Saw—Steel Back.

adjust the blade to cut at any angle, as is often necessary to do when cutting where limbs grow close together, and where it would be impossible to use an ordinary saw of a wider blade. The blade is only one-fourth to one-half inch wide, and therefore not liable to get pinched in the cut. Strength is imparted by a tension screw under the handle, which tightens the blade. The blade is easily detached by slackening the tension screw, and lifting the blade out of the slot in the clutches at each end. The blade can be thus reversed and made to cut with a push or a pull, as may be desired.



California Curved Pattern Pruning Saw.

The foregoing saw is commonly called the Hatch pattern. Another similar to it, except that it is heavier and has a handle like that of a butcher's saw, is known as the Jessup pattern. Another popular saw is the curved pruning saw, with twelve and fourteen-inch blades. As the engraving shows, the saw cuts with a pull.

CUTTING TO A BUD.

Whatever may be used to make the cut, it is important to sever the twig or shoot at that distance from a wood bud which gives that bud the best chance to grow well, and at the same time facilitates the healing and complete obliteration of the scar. Cutting too far from the bud leaves a stub which dies back, and is likely to carry decay into the pith and thence down into the limb. Cutting too close to the bud or carrying the slope down

too far behind it, does not give it enough live wood to carry it, and it makes a weak growth. The accompanying engraving shows the right way and the wrong way to cut a bud. In the first figure, the cut is too far from the bud; in the second, too close to it, and in the third the cut is made at the right point.

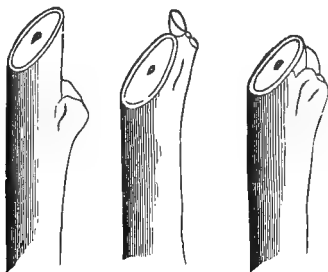

Cutting to a Bud (Barry).

Cutting to inside buds with trees of spreading habit, and to outside buds with upright growers, or to a side bud when lateral extension is desired, should always be remembered as a means of throwing new growth in the direction demanded by symmetry and equal occupation of the space allotted to the tree. This is one respect in which study of the habit of the tree suggests proper practise.

COVERING WOUNDS.

Whenever wood is cut with so great diameter that it will not grow over in one season, the wound should be coated with something to keep the wood from checking and decaying. It has been amply demonstrated by California experience that smooth-paring of the cut by shears or saw is a waste of time. Large wounds should, however, be covered to prevent checking of the wood and drying back of bark edges. Nothing is better or cheaper for this covering than lead and oil paint, a little thicker than for ordinary use, and applied sparingly, so that it will not run down the bark.

GATHERING UP PRUNINGS.

Gathering up prunings for burning is tedious and expensive, and several efforts have been made to substitute machinery for hand labor. A device which has been shown to work well is Anderson's Brush Rake, invented by W. C. Anderson, of San Jose. It readily gathers all kinds of tree and vine brush, compresses it considerably and is easily discharged of its load by a slight lift while still going forward. It is said to save about one-half the cost of hand raking.

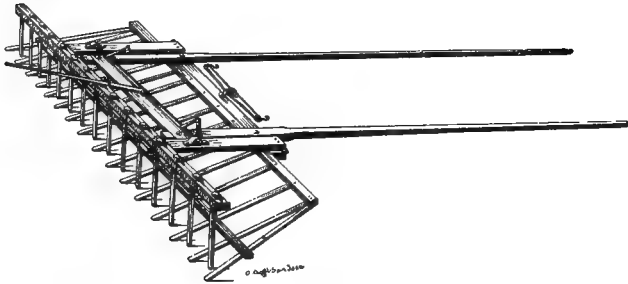

Anderson's Brush Rake.

Baling Prunings.—There is a fuel value in prunings which has become more clear since pumping for irrigation is so widely practised, but loose prunings are too expensive in handling. T. G. Rogers, of Winters, has contrived a “brush baler.” It is a large strong saw horse inverted, to which is bolted a long, heavy lever. Attached to a cross piece on the lever are four heavy tines bent in a semicircle. The saw horse is filled with brush, the lever is then pulled down and fastened by a ratchet brake, the brush is forced into a small, compact bundle, and when bound with wire makes a bundle easily handled by the fireman.

THINNING FRUIT.

Intimately connected with the pruning of bearing trees, is the thinning of the fruit or proper spacing of the individual fruits so that each shall have space and sap to allow its attainment of satisfactory marketable size. It has been fully demonstrated that no demand is profitable which will be content with the undersized fruit from an overladen tree. The superior price for good-sized fruit for all uses, not excluding drying, is unquestionable; the total weight secured may be variable as between thinned and unthinned trees, but it can be accepted as an indisputable fact that any increase of weight there may be upon the unthinned tree will not be nearly an equivalent for the loss in value. It is the conclusion of our largest and most successful growers that, large as is the expenditure required for careful and systematic thinning of fruit, it is the most directly profitable outlay which they have to make for orchard maintenance.

Objects in View in Fruit Thinning.—But thinning fruit has objects beyond the value of the visible crop which it makes profitable. No overburdened tree can discharge the twofold summer duty of every cultivated fruit-bearing tree which is to perfect this season's fruit and lay a good strong foundation for next year's bearing. If the tree, after fruit gathering, has not the

strong, vigorous foliage to complete the formation of fruit buds for the following year, there will either be a lack of bloom or a show of bloom unfit to set, and the tree will work for itself next year, and not for you, because this year you would not work for it. In this particular, thinning fruit coincides in purpose with pruning to limit the amount of bearing wood, which has already been considered.

Other objects there also are which are related directly to the profit of orcharding and should command respect from the most careless. The following is an emphatic statement of the case:*

There are at least six ways in which growers are repaid for thinning peaches, nectarines or apricots designed for drying:—

First: You can thin off half the fruit when small quicker than you could pick it when large, and when mature the time required to fill a basket depends mainly upon the number of peaches it holds.

Second: It takes just as long to cut and spread on a drying tray a small peach as a large one. It takes longer to cut eight peaches that will weigh a pound than to cut three and pick off five when they are little.

Third: If peaches run six to the pound the weight of pits will not vary much from that of the cured fruit. If they run three to the pound, they will weigh not much over half. A ton of large peaches is as likely to yield 400 pounds of dried as a ton of small fruit of the same variety to yield 300 pounds. It means a difference of about \$8.00 per ton in the value of the fresh fruit to the dryer. It will cost over \$1.00 per ton to thin a heavily laden peach orchard in a way to make that difference.

Fourth: Granted that you leave fruit to reach the same weight at maturity, still you leave it along the body and in places on the limbs where the weight has no breaking leverage and take it off the ends where it may get sun-burned and is almost sure to break the tree.

Fifth: Vitality drawn from the plant and certain elements of fertility from the soil, are in proportion to the number of seeds matured. The pulp cuts little figure except in aerial substances and water.

Sixth: Suppose that fruit dried from peaches that weigh three to the pound only brings one cent a pound more than that from peaches half that size. Two cents would more accurately measure the difference in value. Still, the smaller figure is enough to meet the whole cost of picking and hauling or of cutting and drying in any well-managed establishment.

When to Thin Fruit.—Thinning of fruit should begin with the winter pruning of bearing trees, as has been already urged in connection with regulating the amount of bearing wood allotted to each tree. After this is carefully done, there is the thinning of bloom, which is urged on the ground of least possible loss of energy by the tree in the partial development of fruit to be subsequently removed. Hand-thinning of individual blooms is impracticable on a commercial scale, but removal of spurs or twigs, or shortening of them with shears, is feasible enough. The objection must lie in the fact that profusion of bloom does not necessarily indicate an excessive set of fruit, and any severe reduction of bloom is, therefore, venturesome unless

*Condensed from F. S. Chapin.

one is fully assured by local experience of the habit of the variety under treatment. Reduction of the amount of fruit itself is, therefore, the only safe proceeding, and this should not, as a rule, be undertaken until the first drop, through lack of pollination, has taken place. Even at greater theoretical loss of energy to the tree, it is better to err on the side of thinning a little too late than too early in order to secure the fullest assurance possible of the permanent burden which the tree assumes. Where spring frosts are likely to occur they afford additional reason for delay. If surety of the local conditions comes before the pits harden in the young fruit it is fortunate for the tree, but even after that it is still a greater saving to the tree and assurance of profit to the grower to reduce the fruit to a proper amount than to permit overbearing.

The Practise of Thinning.—If the tree has not been sufficiently relieved of an excess of bearing wood during the winter pruning and has made a very heavy set of fruit, thinning with the shears by cutting out whole spurs or short bearing shoots, or even shortening in longer limbs, cutting always to a lateral when possible, is of no appreciable injury to the tree. After all the shear-work possible is done, the spacing of the fruits on the twigs and branches must be provided for. This was done in early days by beating the tree with a pole, and some still maintain that they can use the pole to advantage. The almost universal practise, however, is to use the hand in plucking or pushing off the small fruit. This is done very quickly by experienced workmen. If the trees are low, as they should be, most of the work can be done from the ground. It is best to work in vertical spaces and take all that can be reached from top to bottom without changing position; then move a step or two and take another vertical strip, and so on.

The distance which should be left between specimens depends upon conditions. It is as unsatisfactory to thin by rule of inches as it is to prune by such a rule. The space to each fruit depends upon the kind, the age, vigor and strength of the tree, the size and thrift of the lateral or spur which carries the fruit, the moisture supply, the richness of the soil, etc. It also depends upon what use is to be made of the fruit, because it is possible to have some fruit which is too large for certain demands, though this objection does not often arise. The strength of the shoot is perhaps the most easily appreciable factor. With peaches, for instance, a shortened lateral one-eighth of an inch in diameter should only carry one peach, while one one-quarter of an inch in diameter might mature four good large fruits. It would evidently be wrong to work for an arbitrary inch-distance on all sorts of shoots, and it will be seen to be just

as irrational if it be applied without regard to the other conditions of the tree. If, however, a rule must be had, let it be this, that the distance between the fruit shall be two and one-half times the diameter desired in the fruit. This would fix an arbitrary distance, then, of four to six inches for apricots and six to eight inches for peaches—with other fruits according to their respective sizes, and the late varieties with greater distance than early.

Any such standard, however, considers only the size of the fruit, not the strength of the tree, and therefore stops short of one of the important ends of thinning, to conserve the strength of the tree for next season's fruiting. Fruits might be thus spaced and still the tree be overladen, because it may be carrying too many bearing shoots. Calculate the burden of the tree in this way, for instance: Peaches which weigh three to the pound are of fair marketable size; sixty such peaches will fill an ordinary peach-box of twenty pounds; ten to twelve such boxes is fruit enough for a good bearing tree six to ten years of age. Now count the little peaches you have left on one main branch and its laterals, which ought to be about one-tenth of the tree, and thin down to about sixty. By doing a few trees in this way and thinking of the relation of the bearing wood to the fruit, one will soon get a conception of the proper degree of thinning, and proceed to realize it as rapidly as the fingers can fly along the branch.

It is seldom desirable to divide doubles in peaches; pull both off or leave both on, as they may be needed or not to make the load of the tree. Clusters of apples or pears should often be reduced to singles, except where size is apt to be too great.

All kinds of fruits are clearly subject to increase of size by thinning, but it is with only the larger fruits that the practise prevails at present. The dividing line seems to lie upon the prune. With this fruit thinning is only done by pruning the tree for the reduction of the number of bearing branches, while with some shipping plums hand thinning is practised. Growers are still striving for a prune naturally of larger size rather than to have recourse to thinning.

The practise of thinning partially at first, trusting to further removal of fruit later if too much of it survives the natural drop and various accidents, is followed by some growers, but the rule is to finish at one operation.

CHAPTER XIII.

CULTIVATION.

It was demonstrated very early in California experience in fruit growing, that "clean culture" is the proper treatment for trees and vines. Though the frequent stirring of the soil and the complete eradication of grass and weeds have been advocated by certain horticulturists for generations as the true practise, it has nowhere secured such wide adherence as in California. It may even be held to be an essential to successful growth of tree and vine in most soils and situations in California, and the advantages of clean culture, which have been urged elsewhere, are intensified under our conditions.

Chief of these advantages is the maintenance of the soil in a condition favoring root growth, and the main feature of this condition is the retention of the moisture, though regulation of summer temperature in the soil is also involved. Where moisture-retention is not the chief concern, because of ample irrigation facilities, and the moderation of soil temperature is of greater moment, a summer-growing cover crop may be of benefit to the trees. In irrigated districts of excessive heat and dry air this policy may prevail, but it will be only the exception to the rule of clean culture.

Retaining Moisture by Cultivation.—It is a familiar fact that water will rise in a tube of exceeding small diameter very much higher than the surface of the body of water in which the tube is held upright. The water rises by *capillary* attraction. A compact soil has extending through it minute spaces, formed by the partial contact of its particles, which facilitate the rise of water from moist layers below, in accordance with the same principle which causes the water to rise in the capillary tube. This movement is constantly going on in a firm soil, and as fast as the top layer is robbed of its moisture by evaporation, the water rises from below and it too is evaporated. During a long, dry summer, the water rises and is evaporated from a depth of several feet in some soils, and the earth, beneath the baking sun heat, becomes "dry as a brick."

When a soil is broken up by cultivation, its capillarity is temporarily destroyed through the disturbed layer, because the

particles are so separated that the mutual connection of the minute interspaces no longer exists. But if it be roughly broken up, so that the disturbed layer takes the form of coarse clods, the air has free access to the upper surface of the firm soil beneath them, in which the capillary condition still exists, and evaporation proceeds in the same way, though in a somewhat less degree, than if there had been no cultivation. It becomes evident, then, that the pulverization of the disturbed layer must be so complete that the particles are separated and capillarity destroyed, and, farther, that the free access of air to the lower point, where capillarity exists, must be prevented. This is accomplished by the fine loose earth which acts as a mulch. When this is attained, only that moisture in the upper surface which comes in immediate contact with the air is evaporated, and the balance is retained for the use of the plant. Plants growing, then, in a well-cultivated soil, have the water in the lower soil held for their use, and as fast as they use it the supply is replaced from the firm soil below; or else, evaporation being stopped, their roots extend freely through the moist soil, seeking the nourishment they need.

Such is a brief outline of the theory which explains the results gained by thorough cultivation of the soil, so far, at least, as retention of moisture is concerned. The practical demonstration of this retention is easy. Go into a well-cultivated orchard or vineyard, push aside the soil with the foot, and moisture will be found two or three inches from the surface, or even less in some soils, while on uncultivated land adjacent, digging to the depth of several feet will show nothing but hard earth, baked and arid. In such hard-baked earth, moreover, the sun heat is conveyed or conducted downward very rapidly during a hot day, so that in some cases the roots are seriously injured. When the surface is well tilled, it will act like a blanket, preventing a too rapid conveyance of heat downward, and thus also diminishing the intensity of evaporation.

Accurate demonstration of these facts has recently been secured as the result of many moisture determinations in cultivated and uncultivated soil by the University of California Agricultural Experiment Station.* Very striking exhibition of the condition of trees with and without cultivation is found in the engravings which are reproduced herewith. Upon the demonstration, the practise in the uncultivated orchard was radically changed. The exact determination of moisture present at various depths of the soil beneath these contrasted orchards in the month of July is as follows:—

* Bulletin 121.



APRICOT ON UNCULTIVATED LAND ADJOINING.



APRICOT ON CULTIVATED LAND NEAR NILES.

DEPTH IN SOIL.	CULTIVATED.		UNCULTIVATED.	
	Per cent.	Tons per acre.	Per cent.	Tons per acre.
First foot.....	6.4	128	4.3	86
Second foot.....	5.8	116	4.4	88
Third foot.....	6.4	128	3.9	78
Fourth foot.....	6.5	130	5.1	102
Fifth foot.....	6.7	134	3.4	68
Sixth foot.....	6.0	120	4.5	90
Total for six feet.....	6.3	756	4.2	512

This shows a gain of nearly fifty per cent of soil moisture by cultivation.

Necessity of Adequate Cultivation.—It has been very fully demonstrated by California experience that adequate depth of tilth must be attained. The depth of cultivation, or the thickness of the dust-mulch, as some like to call it, must be sufficient to prevent the access of the dry air to the firm soil below. At the East, where they have a moister air, a thin mulch may answer; but in California, with a thirsty air for such a protracted period, there must be deeper tilth. Two or three inches of dust spread over a hard-pan layer, formed in some soils by cultivation, will not retain moisture well in California. The cultivator should go twice that depth, ordinarily, and then the result will be accomplished if it is done frequently enough to prevent the re-firming of the surface by atmospheric moisture or by the rise of moisture from below. The exact significance of depth in the loose, surface layer has also been demonstrated by moisture determination in the subsoil at different points by the California Experiment Station, as follows:—

PERCENTAGE OF MOISTURE IN CULTIVATED LOAM SOIL.

Depth.	Niles.	Santa Maria.	Ventura.
Three inches.	5.4	5.3	6.5
Six inches.	6.3	8.3	9.3

These may be accepted, probably, as average results: variation may occur in soils of different characters. The capillarity in a heavy soil is vastly greater than in a light soil. The difficulty of securing a pulverized surface layer is also greater in the heavy soil. The poorer the pulverization, the deeper the layer must be. Naturally, then, growers' practise will vary. The rule will remain that there must be depth enough to secure effective protection of the firm soil beneath from agencies promoting evaporation.

Loss of Moisture by Weed Growth.—One of the most active

agencies for the exhaustion of moisture from the subsoil is the growth of weeds. To cultivate the soil in winter and spring, and then to allow a growth of weeds to "shade the soil" is a great error. Although under the cover of rank weeds moisture may appear even at the surface and convey the impression of moisture-saving, the fact is, as fully demonstrated by experience and accurate experiment, the moisture in the lower layers of the soil is reduced and trees are thus robbed of their supply. Weed growth must be resolutely suppressed during the dry season.

Moisture Storage in the Soil.—Conservation of moisture in the soil is not only the surety of the current season's growth and fruitfulness, but is the safeguard against injury from the years of deficient rainfall which occur now and then in California. The moisture supply is equalized by this storage in the soil, and a surplus from the liberal rainfall of one year is held over to supply the lack of the next. Of course, the well-cultivated surface is also well calculated to catch the water. While from a hard surface much of a heavy rainfall flows off quickly to a lower level before it can penetrate, a loose soil retains all that falls upon it, except the excess, which disappears by seepage or drainage.

It has sometimes been held by California orchardists that planting some tall-growing crop, like corn, so as to shade the young tree and the ground around it, is an advantage. This is a great mistake. Though some rich, moist soils may afford moisture enough to grow both the tree and the corn, it is a fact that in most cases the growth of the corn is made at the expense of the tree, and sometimes almost costs its life and thrift. It has been clearly shown by the researches of Professor Wollny,* that though shading ground by a leafy growth may make the surface layer of the soil moister, the lower layers are invariably made drier, and it is in these lower layers that the tree seeks its sustenance. The young tree should be shaded as has been described in the chapter on planting, and not by a growing plant.

GROWING CROPS BETWEEN TREES AND VINES.

The possible advantage of a cover growth of clover in regions of high heat and ample moisture has been noted at the opening of this chapter. The rule, however, must be: Grow nothing whatever between the trees if you desire the full success of the latter. As with all rules, this one may admit of exceptions.

Inter-cultures in orchard or vineyard may be allowed under certain conditions of the soil and the purse of the grower. If the soil is deep and moist and rich, the cost of planting and culti-

* Cited in *Pacific Rural Press*, May 3, 1879.

vation, and sometimes more may be made by growing a crop among your young trees. Of course, if irrigation is available, much more can be done in this direction than if dependent upon natural supplies of water.

There is much difference as to crops in amount of injury they may do the trees. Growing alfalfa, without irrigation, has been known to kill out an orchard. Grain is less dangerous, but still is objectionable, both because of exhaustion of soil and moisture, and because of danger to trees from heat deflected from straw and stubble. The crops least injurious, because of their **requirements, and because the constant cultivation of them checks the loss of moisture by evaporation,** are corn, beans, potatoes, beets, carrots, etc., squashes, and other members of the melon family, onions, and other shallow-rooting vegetables. In the growth of these, however, there should be a width of four feet of well-cultured soil on all sides of the tree, unoccupied.

In soils exceptionally rich and deep, and where rainfall is abundant, inter-cultures of small fruits or vegetables may be carried on for a long series of years with profit both from the trees and the inter-culture. In similar deep, rich soils, with irrigation, immense crops of small fruits and vegetables, even as high as twelve to twenty-four tons of tomatoes per acre, have been taken from between orchard rows, and one hundred and fifty sacks of onions per acre from between the rows in a strawberry plantation. In Ventura County some fields of lima beans, in favorable years, have paid over \$70 per acre—grown between young trees. In other parts of the State considerable amounts of peas for sale to canners are grown between the rows in young orchards. This crop is especially desirable when good sale is assured, because the plant is hardy and can make a good part of its growth during the rainy season and the ground be cleaned up and well cultivated early in the summer. As beans and peas are legumes, their roots enrich the soil, as will be noted in the chapter on fertilization.

How Exhaustion by Inter-Culture May Be Avoided.—But all inter-cultures are a loan made by the trees to the orchardist. The term may be very long and the rate of interest very small in some cases, but sooner or later the trees will need restitution to the soil of the plant food removed by inter-cropping. This may be accomplished by the use of fertilizers. Still the rule that the trees or vines should have all the ground is generally true. It is also true that on merely ordinary soils, trusting to rainfall, or on shallow soils, trusting in part to irrigation, the trees or vines should have the full strength of the land and all the help which can be given them in the shape of thorough cultivation.



GROWING PEAS FOR CANNING IN A YOUNG PEACH ORCHARD IN SUTTER COUNTY.

METHODS OF CULTIVATION.

In general terms the main objects of cultivation of orchard and vineyard are two: Winter cultivation for moisture reception, and summer cultivation for moisture retention.

Wherever early winter plowing can be done without too great danger of soil washing, it affords the best available means of admitting water to the great reservoir in the lower levels of a deep soil. Too frequently large volumes of rain water, enriched by air-washing as it falls and by fine soil-particles as it flows, are allowed to run off into the country drainage, with the double loss of fertility and moisture to the fruit grower. Deep penetration of winter rains should be, in all safe ways, promoted. Cultivation for retention has already been strongly urged and is quite generally recognized.

To serve these main purposes there are two main divisions of practise in this State, each of which has variations of greater or less importance.

First: Winter plowing followed by frequent use of cultivator and pulverizer in summer.

Second: Use of cultivator at intervals both winter and summer, following, if needed, with pulverizer in the summer.

It will not be attempted to render judicial decision as to the comparative merits of these two systems of cultivation. It is quite probable that each has claim to superiority under different local conditions. It will be enough at present to describe the main features of each division of practise, and perhaps to mention incidentally some of the claims by which each method is supported by its advocates.

Plowing Orchard and Vineyard.—There is considerable variation in the practise of plowing orchard and vineyard, in the kinds of plows employed, and in the times chosen for the work. Some plow but once, toward spring, whenever the ground is in suitable condition; and, if there is much growth of weeds and clovers, a looped chain is run from the plow to the end of the evener to aid in drawing under the tall growth. Sometimes, however, the growth gets so rank before the soil is in condition to plow that the weeds are mown before plowing. Where but one plowing is done, the soil is usually thrown away from the trees and afterwards is leveled back by harrowing or cultivating. If this practise is adopted, care should be taken that the soil is properly returned about the tree roots, for injury is sometimes done by bringing the roots too near the surface, which is soon afterward intensely heated by the sunshine.

It is undoubtedly better practise to plow earlier, when the green stuff gets a good start, but is still not too high to turn

under handily. In this practise the weed stems are not so woody, but they easily decay and act as a fertilizer. Where early plowing is practised, it is usual to plow again when the second growth of weeds reaches the proper state in the spring. When two plowings are given, the earth is usually thrown away from the trees in the first plowing, and returned toward the trees in the second plowing. But this order is sometimes reversed in situations where rainfall is heavy and the soil retentive, for the dead furrow between the rows often acts as a surface drain to carry off surplus water, which is thus prevented from standing around the tree roots. In all modes of plowing it is desirable that before the summer heat comes, the surface be leveled as completely as possible.

Too much stress can not be laid upon the importance of plowing when the soil is in good condition and not otherwise. To disregard this is bad enough in all soils, but it is a grievous mistake to work any of the clayey soils when they are out of condition. If too wet, they are puddled by the plow and dry down in hard clods, impenetrable by air, and even resist water itself for a long time. When clods are thus formed, it may require long effort to bring the soil back to a good friable condition. The cultivation of adobe is one of the problems of California agriculture. The more refractory it is, the more particular care is needed to take it when it is in proper condition to work. To work it when perfectly dry is simply impossible; and if it is plowed when too wet and sticky, it becomes hard, lumpy, and altogether unmanageable. The condition which favors best results by tillage must be learned by experience.

Another mistake, apt to be made where the orchard or vineyard is but one of the branches of a mixed farm, is to put aside the plowing until all the field work is done, and in some seasons the soil in the orchard has become so dry that it turns up in large clods, which are afterwards partially reduced by the harrow, but never put in the fine tilth which should be secured for the retention of moisture and otherwise to encourage the growth and productiveness of the trees.

Breaking up Hard-pan.—Those who advocate the use of the plow, claim several advantages for it. The chief is that more thorough tilth can be secured. In most, but not all soils, there is formed by cultivation an artificial hard-pan at whatever depth the implement attains, if this depth be kept the same for many successive cultivations. This hard-pan, in some soils at least, becomes impervious to water and is otherwise an injury to the growth of the trees. It occurs in irrigated and unirrigated land alike, but probably is more quickly formed by irrigation. When continuous summer cultivation is practised, the hard-pan will be

found at whatever depth the teeth uniformly reach. The remedy is to plow in winter just below this hard-pan layer and thus break it up, and then by the action of the air and rains it is reduced, and cultivation may proceed as before. Where the hard-pan is formed by the plow, the ground should be plowed shallow one year and deeply the next, thus alternating from year to year.

Green Manuring.—Another advantage in the use of the plow is, as has already been mentioned, the turning under of the growth of weeds, grass, and clover as a green manure. Many growers attach considerable importance to this, and some, who have orchards in which winter growth has been killed out by long cultivation, are seeking for a quickly-growing crop which they can sow with the first rains and secure growth enough to turn under with the winter plowing. This consideration may be farther presented in the chapter on fertilization.

Plowing Hillside to Prevent Washing.—Where the slope of the land is sharp, there is much danger from washing during the rainy season, if the hillside is not terraced or furnished with ditches carefully laid out on contour lines to carry the water down on a gentle grade. The old plan of plowing furrows one above another around the hill to check the flow and let the water down easily, is often found treacherous unless one is able to strike good grades, because of the liability to collection of water at certain points and the subsequent breaking away and washing. Recently some of the foot-hill growers have adopted the plan of plowing furrows seven or eight feet apart straight down the hill in the direction of its deepest descent. The rainfall is thus distributed over the ground so that not much water is collected in any one place and the harm done by washing will not amount to much. Hillside work differs according to character of soil and of local rainfall and conference with experienced men in the region will usually afford the beginner the best suggestions of method. In some localities, the plowing of a few furrows at intervals to assist in penetration and the growth of a cover crop during the winter to assist in binding the soil, will be found better than any attempt at the early plowing, which may work admirably on level lands.

The Best Plow.—For plowing orchards and vineyards many kinds of plows are used, including the ordinary one and two-horse walking plows, single and double sulky or riding plows, and gang plows of different kinds. In several of the leading fruit districts there are plows made in the local shops which are patterned to meet the different soils prevailing. Which is the best plow is a question which can not be answered, it must be determined by local conditions, and the best way to get information is to consult the experienced cultivators of the locality.

Steam Plowing of Orchard.—A local phase of orchard plowing in the Feather River district of the Sacramento Valley is worthy of note. A large traction engine has been used to haul a gang of plows, covering twenty-four feet of land, the full width between the rows of trees, and doing the work of four eight-mule teams, turning over the ground in excellent shape and doing the work much more cheaply than it can be done by animals.

Avoiding Injury to Trees and Vines.—The great problem is to use the plow so as not to injure the trees and vines. Injury to the roots is one ground on which those who advocate the banishment of the plow from orchard and vineyard base their opposition, as will appear more fully presently. It is the usual practise to run the plow shallower when approaching the stem of the tree or vine, and this is easily done when using a riding plow or a two-horse walking plow between the rows and finishing up near the trees with a single-horse walking plow, which is a common practise. The injury by the plow to which especial reference is now made, is that to the bark of the tree or to the vine stump.

Makers of the special orchard and vineyard plows have recently made them adjustable so that the plow will work either side of the central line of draft, and these improved tools have rendered obsolete the early contrivances for accomplishing the result with common field plows.

Flat Hames and a Spreader.—Among the worst things for use among trees are the pointed iron hames which are found on most harnesses. They often seriously bark the branches under which the horse passes, and should be dispensed with. An arrangement used in San Bernardino County consists in having broad leather tugs and hames with only one long iron loop on the swell of the hame. The tug is passed around the hame and the end is brought through the iron loop from the under side, so that the draft will hold the tug tight between the collar and the hame and the end between the iron staple and the pulling part of the trace. A spreader is put between the tugs; it is made of a hard-wood stick sixteen to eighteen inches long; a hole is bored in each end large enough for a two-inch screw, a hole punched in each trace about twelve inches from the rear end, and the tugs are screwed to the ends of the spreader, and the ends of the tugs attached to the plow clevis. This gives no iron or wooden surfaces at all, either on harness or whiffletree, to strike the bark.

Improved Singletrees.—Later than these came the orchard and vineyard singletrees, invented and patented by Californians. The first was that of G. G. Wickson & Co., of San Francisco, and it is now very widely used. As shown in the engraving, it is made in two parallel parts, the trace is slipped

between the upper and lower halves, and there held by a simple clasp, leaving fully one-half extending beyond the ends of the wood, and preventing the singletree coming into contact with anything in passing, as shown in left-hand end of the illustration. With very young trees the edge of the traces might injure the tender bark, so a little supplementary trace is attached to the main trace at right angles, as shown in right-

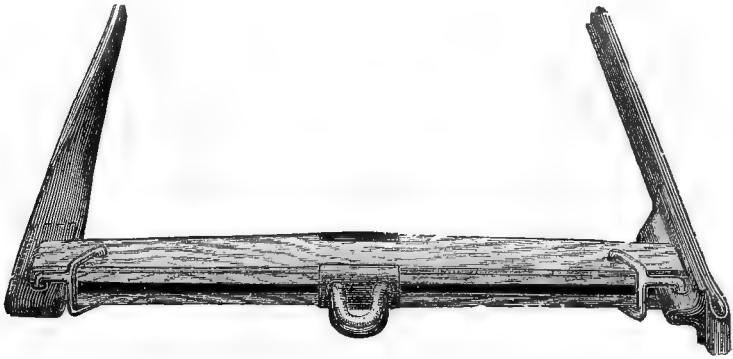

California Improved Orchard and Vineyard Singletree.

hand end of illustration, and passes between the ends of the singletree, presenting the flat side of the trace to obstructions, in which shape it can not injure in the slightest degree the tenderest bark. The engraving is made with ends unlike to show both styles of hitching. There are other patented devices for preventing injuries to trees and vines which can be seen at the stores of dealers in agricultural implements.

Dispensing with Doubletrees.—Still other inventions which admit the use of two horses even close up to the trees, because they dispense entirely with whiffletrees and tugs, are known as the steel harness, Eastern inventions, which have secured the approval of some of our leading growers for use in orchard and vineyard. The plow is attached to the steel yoke by a chain running between the horses. With them it is possible to work quite close to the trees and vines, and is especially desirable in the vineyard in working close to the vines when they have grown out about two feet, which is a difficult job with the old-style harness.

SUMMER TREATMENT OF PLOWED ORCHARD AND VINEYARD.

Where the orchard or vineyard is plowed twice during the winter, the land should remain after the first plowing as the plow leaves it. The moistening and aeration during the winter have a good effect upon the soil both chemically and mechanically.

If but one plowing is done, when the chief rains are supposed to be over, there must be full effort put forth to reduce the soil to good tilth, and to level the surface as much as possible. This is done by harrowing with one of the several improved harrows which are now generally introduced and found very effective. They act in cultivating, clod crushing, and leveling, in a most satisfactory manner. They are too well known to need description. Each has its advocates and its adaptations to certain soils. As with plows, so with harrows and cultivators, the best for one soil may not be the best for another, and local inquiry among experienced fruit growers will be the best guide for the newcomer. In addition to the excellent implements brought from the eastern States, there are others of California invention and manufacture which have very marked local adaptations, and almost every fruit region in California has some embodiment of local inventive genius in the form of implements of tillage.

The secret of success in handling the heavier soils in spring working is to secure as perfect surface pulverization as possible without compacting the soil. Light soils need a certain amount of firming after plowing, or else there is too free access of air and too great drying out. For these and other reasons, the grower has to study his soil and learn from observation the methods which succeed best with it. The practise which gave success under certain conditions might not be well adapted under other conditions. The use of the roller is a striking example of this fact. In some orchards the roller is a benefit, in others a decided injury. Its chief effect is compacting the surface layer, which is only desirable on very coarse open soils. The long-tooth harrow accomplishes a very marked compacting of the soil to the depth it reaches and often settles the lower layer too closely and causes it to run together too solidly if rain follows. The modern cultivators, clod-crushers, disk-harrows, etc., are superior in effect, each in the soil to which its action is most desirable.

After the work incident to working down the soil after plowing, the cultivator is relied upon to kill the weeds, break up the crust which may form after spring rains or after irrigation, and to prevent the compacting of the surface layer of the soil from any causes.

CULTIVATION WITHOUT PLOWING.

There are orchards in California which have not been plowed for years—in some cases the plow has not been used since the trees were planted. Instances of this kind are to be found both in irrigated and unirrigated land. It depends largely upon the

mechanical condition and disposition of the soil whether the practise will give satisfactory results. It can not be trusted on land prone to develop hard-pan, as has already been considered, and yet the term "cultivation" has taken such a wide range in this State, and the tools have reached such efficiency, that there is not as much difference as formerly between the plow and the cultivator, except that the former turns the soil and the latter stirs without turning. For some who oppose the use of the plow, use a chisel-tooth cultivator, cutting to a depth of eight inches in the spring, but at other times of the year they do not cut more than half as deep. This treatment would tend to dispose of hard-pan. However this may be, and what the special nature of their soils, there are fruit growers, both in northern and southern California, who have for years trusted almost wholly to the cultivator, cutting to a depth of three or four inches, and keep their orchards throughout the year almost in the same state of tilth, never allowing a weed to grow. This practise is, however, becoming less prevalent, and for certain soils the question is practically settled in the minds of nearly all orchardists, while for other soils there is still doubt. For the heavier soils, which continuous shallow cultivation is apt to render too compact, it is necessary to have recourse to the plow to open the land for proper aeration and penetration of moisture which otherwise would be largely lost by surface run-off. The lighter soils do not require this and they seem to do well with continuous use of the cultivator. It is beginning to be clearly seen, however, that this treatment tends toward the decrease of the humus and the consequent impoverishment of the soil. Its water-holding capacity is also lessened. These facts have induced some growers to change their practise and take up the plow during late winter or early spring to cover in the growth of green stuff which they allow to grow instead of frequently destroying it with the winter use of the cultivator. Either the fall and spring plowing, or both, followed by the summer use of the cultivator, is the most rational and satisfactory practise for most of our deciduous orchards, though there are local conditions and circumstances under which different procedure is preferable.

SUMMER CULTIVATION.

Whatever the winter policy may be, the essential point in summer cultivation is to preserve the surface layer of *pulverized earth*. It will not do to have a few inches of clods, from the size of a pea to that of a goose-egg, resting on a hard surface. The finer the pulverization the shallower can be the surface layer, and *vice versa*, and this is probably one reason why in practise

the work of the plow is, in so many situations, found the best foundation upon which to rest the year's cultivation.

In order to secure this finely-pulverized layer, it is sometimes necessary to use what is called a "rubber," where there are many clods which are merely displaced by the harrow or cultivator. There are different styles, and they are generally home-made. The most common form is made of two-inch plank in lengths of three or four feet, bolted or spiked to pieces of four-by-four-inch scantling running crosswise, the edges of the planks lapped like the clapboards which are used at the East for weather boarding. As these edges are drawn over the surface, the clods are rubbed into tilth if they are not too hard and dry.

But this rubbing may be very undesirable if it leaves the surface smooth and polished. It may reflect the sunheat even to tree-burning, and it is apt to form an evaporating surface, which is most to be avoided. The best finish for the land is that produced by a light, fine-tooth harrow, and an attachment of this kind is provided with various clod crushers and cultivators. The result is a surface of loose earth, flat and fine, which approaches very closely an ideal condition.

There is less difference than formerly in the use of the harrow or cultivator during the summer. Still some are content to use the cultivator only as a weed-killer, and after the weeds cease to grow and the spring showers are over, the cultivator is laid aside and the land is left unstirred until the following winter. This, of course, refers to unirrigated ground, for wherever irrigation is practised, a cultivator must follow. It is a fact, however, that even if no rain falls, the soil becomes compacted to a certain degree, and the best way to imprison the greatest possible amount of moisture below is to run the cultivator at intervals all through the dry season. It should run shallow and only stir the surface layer. The experience of the most successful growers is that frequent stirring without, however, bringing new soil to the air, is the best-paying practise.

WHAT IS THOROUGH CULTIVATION.

As clean, thorough cultivation has been approved, it may be desirable to attempt to define the term. It can, however, only be approximately done, because of the great difference in individual views and practises. Some indication of the operations which are contemplated may be had in the following specifications upon which contracts have been let for care of orchard: First, plowing away from the trees, followed by harrowing; second, plowing toward the trees, followed by harrowing; ten summer workings with cultivator; three workings with shallow cultivator or weed-cutter; five hand hoeings around the

trees. The contract intends the most complete and perfect working of the soil and specifies the above merely that there may be no difference of opinion between owner and contractor.

In cases where the land is infected with morning-glory, weekly cultivation is stipulated for in some cases, and this seems about the only way to cope with this formidable trespasser.

CULTIVATION FOR WEED KILLING.

Cultivation for weed killing is a minor consideration in California, because cultivation for moisture conservation effectually disposes of most of them, and weeds do not start readily in the earth-mulch during the dry season. There are, however, a few most persistent pests which require heroic measures. Johnson grass and morning-glory are the most prominent of these. The only successful treatment consists in cutting constantly with a weed-cutter (a sharp horizontal knife), operated so as to pass under the whole surface and run so often that the plant is never allowed to show a shoot on the surface. It is of no use merely to cultivate or "weed-cut" as for other weeds. This spreads the pest more and more; but if the rising shoots are continually cut *under the surface*, and never allowed to get the light, it will kill the plant surely, but it may take two seasons to do it. Weed-cutting knives of this description are usually contrived by local smiths and are attached to sleds or fitted with plow-handles, or used with a pair of thills and cultivator-handles, or other rigging as the operator may choose. The vital point is a blade of sheet steel, very sharp, and rigged to run just under the surface. It must be used as often as once each week.

MULCHING A SUBSTITUTE FOR CULTIVATION.

The use of a mulch or covering of the ground with a litter of light materials to prevent evaporation, is practised to a small extent in this State. Though mainly used for berries of different kinds, recourse has also been had to mulching by vineyardists. The materials used are various, such as partly-rotted straw, coarse manure, damaged hay, corn-husks, corn-stalks, vine prunings and leaves, and even fine brush from adjacent thickets. The practise has been found of greatest value on hillsides where cultivation is difficult, and danger of washing of loose soil is great. There are cases where vines have been grown several years in this way to the satisfaction of the owner. The danger of fire in our dry climate when the surface is covered to a depth of several inches with a dry mulch is considerable. As a rule, the mulch employed by the California grower is a perfect pulverization of the surface soil, as has been described.

CHAPTER XIV.

FERTILIZERS FOR FRUIT TREES AND VINES.

Californians are but just beginning to use fertilizers in their orchards and vineyards. Some people have even held that California soils would never need fertilization, and that there is something in our soil and climate which releases us forever from repaying anything to the ground for the wealth of produce which we take from it. Such a view is, of course, without foundation, and yet it is not difficult to see how it arose. Early attempts to enrich the soil by the turning under of coarse stable manure, as is done in other countries, was undertaken here on light soil in a region rather short of rainfall. The manure did not decompose, and its coarse materials made a soil, already too light to retain moisture well, so open and porous that its moisture was quickly carried away by evaporation, and crops did not grow so well as upon adjacent land which had not been manured. So the fiat went forth against manure. The corrals* became undisturbed guano deposits, and manure piles were fired in dry weather to get the soil poison out of the way. Innumerable tons of bones were gathered and ground in San Francisco and shipped away to countries which need fertilizers. Nature did much to foster the popular delusion, for field crops were gloriously large, and trees and vines grew rampantly and bore fruit the weight of which they were unable to sustain. How could there be more conclusive evidence that manure was a detriment to California soils?

It is foreign to our purpose to discuss the general subject of the use of fertilizers in California, and the changes in belief and practise which have recently gained ground. Of course, the marked falling off in the yield of shallow-rooting cereals gave the first unmistakable intimation that there was something wrong about the old theory of the perpetual youth of California soils. The lands used for fruit will be last to show exhaustion, because trees are deep feeders, and the soils, as they are often the very best and deepest of the State, selected for fruit because of that very character, possess, in an eminent degree, lasting

*Inclosures for live stock of any kind.

properties, as is shown in the chapter on the fruit soils of California. But certain of these soils are already showing the need of refreshment, and intelligent growers are quick to minister to the lands which are giving them such generous returns, as they can well afford to do. Present progress in the use of fertilizers rests upon the clearly demonstrated hunger of the orange tree. An active fertilizer trade has proceeded from a center in Los Angeles and asserted itself all through the southern citrus regions. More recently growers of other fruit and nut-bearing trees have seen that even the deepest and richest soils could not honor unlimited drafts upon their fertility, and money expended for fertilizers has continually increased. Recently, too, fruit growers in the upper regions of the State have learned the need and the profit in fertilizing, and in the future natural manurial supplies will be carefully husbanded and commercial fertilizers will be profitably used.

WHEN IS FERTILIZATION NECESSARY?

Though the use of fertilizers by our fruit growers is beginning, it should be plainly stated that at present, except perhaps with citrus fruit trees, or the oldest orchards of other fruits, it is not the rule that such applications are necessary. There is reason to believe that we have some soils which are really too rich for fruit. There is sometimes an overrank growth of wood, which delays or prevents the formation of fruit buds, and there is a marvelous development of fruit which is inconsistent with the highest quality. For this reason the grower should not conclude, from the foregoing general remarks concerning the need of fertilization in California, that he must manure his soil whether it needs it or not. Especially is this the case with young trees, in which the wood growth is easily overstimulated. As with irrigation, so in fertilization; the tree or vine itself will give the observing grower hints as to its needs, and if the growth of wood and color of foliage are such as obviously indicate health and vigor, it may be concluded that the plant needs nothing but good cultivation and intelligent pruning.

Usually cases of overrich ground will cure themselves as the trees attain size and full bearing, and it is then that fertilization may be necessary. When the tree or vine which has been properly pruned and cultivated is not able to mature a good weight of well-developed fruit, and make a satisfactory wood growth, usually at the same time showing some degree of distress by the color of its foliage, it needs help; and if the grower is sure that the trouble is not from lack of moisture in the soil, he should bestir himself in the manuring of his orchard or vineyard. In examining the soil for moisture, one should dig

deeply, for there have been cases of moisture near the surface, and drouth below.

WHAT FERTILIZERS TO APPLY TO FRUIT TREES AND VINES.

A discussion of this subject from a chemist's point of view is beyond the scope of this volume. The reports of the University Experiment Station at Berkeley are rich in details of the researches and deductions therefrom by Dr. E. W. Hilgard, who maintains the position that the most intelligent and economical choice of fertilizers is to be made after ascertaining by analysis in what constituents the soil is deficient and in what it is well supplied. Applications made in conformity with suggestions based upon analysis have proved very satisfactory. But as soils vary within narrow limits of area, there must be analysis for each soil in question.

Approaching the matter of choosing fertilizers without soil analysis, the method by local trial is open. In this recourse there is danger of error, as pointed out by Dr. Hilgard, arising from local differences in soil and subsoil, and must be *checked* by several check plots so interposed between the others as to not only check them by direct comparison, and to prevent the washing of fertilizers from one fertilized plot to another, but they must also be compared, first of all, among themselves, to determine what is the normal product of the unfertilized land. It will frequently be found that these unfertilized check plots differ more widely between themselves than do the fertilized ones from them or from each other. It usually takes several seasons to come to definite results.

From these statements it must appear that the prescription of fertilizers is not an easy matter. Disappointments will naturally be encountered, but unquestionably the advantage is on the side of patient trial and wise investment in fertilizers honestly made and honestly sold. One of the most manifest needs of the State is a fertilizer-control law which shall provide surety to the purchaser of the purity and identity of the materials which are offered for sale. Efforts to secure the enactment of such a law have been repeatedly made without success. Active and united effort to secure a wise law alone can succeed.

Though the deficiencies of the soil, as learned by analysis, or by practical test, must be the basis of prescription of fertilizers, the analyses of fruits, as showing the special needs of the plants, are of the highest importance. The following analyses of the different fruits, containing, in each case, skin, pulp, and seeds, are almost entirely from California-grown specimens, and are supposed to represent an average composition of the fruits named.

QUANTITIES OF SOIL INGREDIENTS WITHDRAWN BY VARIOUS FRUITS.

[Compiled from analyses by Mr. G. E. Colby, University of California.]

FRESH FRUIT. 1,000 pounds.	Total Ash. Pounds.	Potash. Pounds.	Lime. Pounds.	Phosforic Acid. Pounds.	Nitrogen. Pounds.
Almonds †.....	17.29	9.95	1.04	2.04	7.01
Apricots.....	5.08	3.01	.16	.66	1.94
Apples.....	2.64	1.40	.11	.33	1.05
Bananas.....	10.78	6.80	.10	.17	.97
Cherries.....	4.82	2.77	.20	.72	2.29
Chestnuts †.....	9.52	3.67	1.20	1.58	6.40
Figs.....	7.81	4.69	.85	.86	2.38
Grapes.....	5.00	2.55	.25	.11	1.26
Lemons.....	5.26	2.54	1.55	.58	1.51
Olives.....	13.50	9.11	2.43	1.25	5.60
Oranges.....	4.32	2.11	.97	.53	1.83
Peaches.....	5.30	3.94*	.14*	.85*	1.20*
Pears.....	2.50	1.34	.19	.34	.90
Prunes, French.....	4.86	3.10	.22	.68	1.82
Plums.....	5.35	3.41*	.25*	.75*	1.81
Walnuts †.....	12.98	8.18	1.55	1.47	5.41

† Including hulls.

* Estimated.

FIRST AID TO THE INJURED SOIL.

Based upon the clear characteristics of California soils as already indicated in the chapter on that subject, and supported by wide observation of results of fertilization, Dr. Hilgard gives these general suggestions:—

Any large-scale fertilization should begin with phosphates and nitrogen, and, should this not prove fully satisfactory, then with potash also, this being the order in which these substances are likely to become deficient in most of our soils under cultivation. In the course of time potash fertilization will become widely necessary in this State. Under continuous heavy cropping with small fruits, such as strawberries, potash fertilization has already, as a matter of fact, become necessary at some points, and will gradually become more so. On the gray soils of the foot-hills of Amador and Placer Counties it is necessary from the very outset, these soils being as poor in potash as Eastern lands. The same is true of some of the sandy lands of the interior.

AVAILABLE SUPPLIES OF PHOSPHATES.

Phosphatic manures are now being supplied to fruit growers by importers and manufacturers located in various California cities, and results attained by their use are such as to warrant continuance. They are bone and rock phosphates, which are

transformed into superphosphates, and, with nitrogenous matter added, serve as good applications both for growth and fruiting.

Home-made Bone Manures.—Much good bone manure can be made by collecting bones, heads, horns, feet, etc., from butchers' shops or elsewhere. How to make such material available, by simple proceedings, is described by Professor Hilgard as follows:—

1. Bones put into a well-kept (moistened) manure pile will themselves gradually decay and disappear, enriching the manure to that extent.

2. Raw bones may be bodily buried in the soil around the trees; if placed at a sufficient depth, beyond the reach of the summer's heat and drouth and cultivating tools, the rootlets will cluster around each piece, and, in course of a few years, consume it entirely.

3. Bones may be packed in moist wood ashes, best mixed with a little quick-lime, the mass kept moist but never dripping. In a few months the hardest bones will be reduced to a fine mush, which is as effectual as superphosphate. Concentrated lye and soil may be used instead of ashes. In this process the nitrogen of the bones is lost, going off in the form of ammonia, the odor of which is very perceptible in the tank used.

For neither of these processes should the bones be burned. The burning of bones is an unqualified detriment to their effectiveness, which can only be undone by the use of sulphuric acid.

4. Bones steamed for three or four hours in a boiler under a pressure of thirty-five to fifty pounds, can, after drying, be readily crushed in an ordinary barley-crushing mill, and thus be rendered more convenient for use. Practically, very little of the nitrogen (glue) of the bones need be thus lost.

POTASH.

Though, as already stated, potash is commonly in good supply in California soils, it is very desirable to guard supplies well, because, as the fruit analyses already given show, the use of this substance by fruit trees and vines is very large. Recent experiments also show that potash ministers directly to the quality of the fruit in some cases. Ashes from wood fires are the most available source of potash, but it is a mistake to regard wood ashes as valuable only for their potash contents. Professor Storer has found by analysis of a number of samples of house ashes, that selected samples contain $8\frac{1}{2}$ per cent of real potash, and 2 per cent of phosphoric acid, or say $4\frac{1}{2}$ pounds of potash and one pound of phosphoric per bushel. Hence there is enough potash and phosphoric acid to make a bushel of ashes worth twenty or twenty-five cents, and besides that, some ten or fifteen cents additional may be allowed for the "alkali power" of the ashes, *i. e.*, the force of alkalinity which enables ashes to rot weeds and to ferment peat.

These facts suggest to the fruit grower that he should carefully preserve all home-made wood ashes and apply them to the soil at once, or, if stored for future application, be sure that they are kept dry. Leached ashes from the lye barrel, or ashes from

open piles, leached by rains, are hardly worth handling. Coal ashes are almost devoid of fertilizing properties, though, if finely divided, as in the case of coals burning completely, their use is beneficial, mechanically, on clay soils, in the same way that fine sand would be.

The chief supplies of potash salts are now brought from Germany and are in the hands of local dealers, but there are extensive deposits in Utah, New Mexico, and elsewhere in the interior, which can be employed when railroads make them available.

NITROGEN.

Nitrogen ministers directly to the vegetable activity of the plant and is a wonderful stimulant of wood growth and foliage.

Supplies of this substance can be had from animal manures as far as available, but the most convenient, and at present certainly the cheapest and most available, source of nitrogen at command of the farmer is Chile saltpeter, which contains about sixteen per cent of nitrogen, in its most effective form. From one hundred and fifty to two hundred pounds per acre is the usual dose. Sulphate of ammonia is the other most available source of nitrogen obtainable in commerce; a good commercial article contains twenty per cent and over of nitrogen. It does not, however, act quite as rapidly as the Chile saltpeter. A suggestion of caution in the use of nitrogenous manures will be given presently.

LIME, GYPSUM, AND MARL.

Lime is another substance usually abundant in California soils, but still often desirable as an application. This is, notably, the case on our heavy clays or adobes, where, as has already been mentioned in another connection, the use of lime as a top dressing, at the rate of six hundred to one thousand pounds to the acre, not only makes the heavy soil more friable, but acts upon and makes available the large amount of organic matter which such soils usually contain. Lime also renders inorganic materials more available for plant food, corrects acidity, and may destroy insects and fungi. Application of lime is also desirable after applications of barn-yard manure have been made for several years; and it is especially valuable wherever, in alluvial soils rich in vegetable matter, there is an excessive growth of wood and leaf. Usually light soils are not materially benefited by the use of lime.

Ground limestone is sometimes proposed as a fertilizer, and has ever been offered on the market. It is insoluble and inert carbonate of lime, and is not worth the cost of hauling any distance. It cannot take the place of burned limestone.

Gypsum.—Gypsum, or land plaster (sulphate of lime), occurs in considerable quantities in this State and Nevada, and is now being mined and ground at a low price in the San Joaquin Valley. It acts directly in correcting soils made alkaline by presence of carbonate of soda. Applied to soils not alkaline, gypsum sets free potash, magnesia, and ammonia, which may be present in insoluble form; and it also causes potash to be transferred from the upper to the lower layers of the soil, so that roots can everywhere find a store of it. Hence its special value when applied to deep-rooting plants. The reason why gypsum is so capricious in its action, which was long a mystery, is now held to be clear, because upon soils that are tolerably rich in fixed potash it will do good service, while upon soils poor in potash it will not. In any event gypsum is to be regarded as an excitant rather than as a form of plant food.

Of the several uses of gypsum, probably its chief value lies in its power as an absorbent. If added to manure in excess it delays fermentation, and it is, therefore, not a desirable addition to the compost heap. But for covering fermenting manures or scattering around moist places in horse and cow stables to absorb odors and fix volatile manurial substances it is of value.

Marls.—Marl is a calcareous earth, and is called shell marl, rock marl, earthy marls, etc., according to its origin and mechanical condition. A number of samples from different parts of the State have been analyzed by Professor Hilgard, and some of them commended for local application to soils needing lime, but not valuable enough to warrant hauling far.

BARN-YARD MANURE AND COMPOST.

Where fruit growing is carried on with stock growing, there are abundant supplies of manure available, but this combination is not characteristic of California, though prevailing to some extent, and likely to be more prevalent as fruit planting extends farther from the centers which are wholly given to it. But even in the fruit centers there are certain amounts of material available from the animals that are kept for cultivation and hauling, or to be had, often, for the expense of hauling from adjacent towns.

As already stated, coarse, unrotted manure can seldom be used to advantage in this State unless it be in heavy soils in regions of ample rainfall, or on lighter soils, perhaps, if well irrigated; and even in such situations either finely-divided or well-rotted manure is infinitely superior. Corral scrapings, which are usually the first recourse when the idea of manuring springs up in a neighborhood, are not always well decomposed, but they are finely divided, and therefore decompose readily as compared

with coarse straw, which, it is said, has been found practically unchanged even after lying two years in a dry, loose soil. It is, therefore, of the greatest advantage to prepare barnyard manure with care for use in this State by some such method as will be described below, which includes composting, thereby turning to account nearly all organic material likely to be available:—

Clean up all the manure on hand just before the fall rains, putting the same on the land, and either cultivate it in or plow it under. What manure accumulates during the winter pile in a snug heap some five or six feet in depth, and throw it over some three or four times during the winter to keep it from burning, as well as to thoroughly mix it and thereby hasten decomposition. Put horse, cow, hog, chicken, and every other kind of manure that can be had, all together. Never burn anything that will rot, but haul to the pile corn-stalks, roots, and all squash, melon, tomato, and potato vines, etc., as well as weeds of every description, in fact, anything and everything that will decay and make vegetable matter. Use fresh horse manure mostly to hasten the decomposition of said vines, weeds, etc., alternating as the heap is made. By so doing there will not be a weed seed left with vitality enough to germinate. It is well to have manure piles under a roof to avoid leaching during the longest and most excessive rains, but so situated that some of the rain falling on the barn can be easily conducted to the piles, giving them just the amount of water necessary to wet thoroughly without leaching, and no more.*

Treatment of Manure without Composting.—Even when composting all refuse vegetable matter with the manure is not thought worth the time and trouble, it is just as important to properly treat the manure when stored alone. This can be easily done by some such plan as is described below:—

Collect the stable manure in a large bin and keep it wet enough to prevent burning or "fire-fanging." With a bin, say ten or twelve feet square and five or six feet high, built convenient to the barn, the manure can be placed therein and watered daily with much less trouble than it can be composted with other material. This, of course, presupposes the ability to run the water in through a hose or by natural flow. Care must, of course, be taken that too much water be not supplied, causing the substance to be leached from the pile. But in my own experience I find the danger is at the other extreme, and when I open my pile I sometimes wish I had used more water. In filling the bin leave one end or side open as long as possible, for convenience of filling.†

Barn-yard manure and compost carefully prepared in some such way as described, and applied before the rains or early in the rainy season, to be turned under at the first plowing, will be in condition to be readily assimilated, and will not injure any soil.

Sheep Manure.—The proximity of the orange orchards of southern California to extensive sheep ranges led to large use of the manure from the sheep corrals until supplies were practically exhausted. Recently large deposits in the San Joaquin

* Ira W. Adams, Calistoga.

† B. C. Brown.

Valley have been opened, and the material, which has shown value by analysis in one case of above \$14 per ton, is finely ground and placed upon the market in a business way. The deposit mined by George C. Roeding & Co., of Fresno, is several acres in extent and at some points the material is ten feet deep.

Sheep manure is usually counted richer and quicker, though not so lasting in its effects, as stable manure. Being highly nitrogenous, too free use of sheep manure tends to excessive growth of wood, especially on young trees. Old bearing trees may be benefited by such a stimulant.

VARIOUS WASTE PRODUCTS.

The care advised in saving and treating barn-yard manure, hen manure, bones, ashes, etc., should be extended to other waste products of the farm. Soapsuds should be allowed to run to adjacent trees unless used in the flower garden. Peelings and corings of fruit, cut for drying, should be fed to pigs and the resulting manure secured. It is not wise to corral the swine in a dry run in the summer and allow the manure to be sluiced out by the winter rise of the stream.

Prunings.—Prunings of the orchard and vineyard should be burned between the rows, in small piles, so as to distribute the ashes well. Danger to adjacent trees may be avoided by using portable, home-made tin shields on the sides of the fires. It is not wise to carry all the prunings to the side of the highway and burn them there and allow the ashes to be lost. Vineyard prunings are sometimes cut up with an arrangement like a straw-cutter, which reduces them to bits about an inch in length. They are then scattered over the surface of the ground, turned under at the next plowing, and soon decay. Where, through lightness of soil and short rainfall, the woody fiber does not readily decay, burning upon an iron sled about ten feet long is practised. At its front is a V-shaped iron rod, to which a horse can be hitched. On the sled are flaring sheet-iron sides and perforated bottom. This is filled with brush, a fire kindled, and as the horse moves forward fresh brush is added, while the ashes by its motion are sifted out very evenly all over the vineyard.

Refuse from Wineries.—The fermented husks, stems, and seeds, all containing valuable fertilizing properties, are often spread on the road and in holes, where it is of no account whatever. If scattered over the vineyard, much valuable substance would be returned to the soil. In some soils application of raw refuse would be undesirable because of the acidity developed. It is usually safe on calcareous soils, and for other soils should be

composted with lime or wood ashes to facilitate decay and neutralization of the acid. Of winery refuse the lees are especially valuable because of the supplies of potash they contain, but they are now being largely used in the manufacture of tartaric acid.

Other Waste Products.—There are available from various manufactories different waste products which can not be specified. When any such material comes to the notice of the fruit grower, he should seek advice from the Agricultural Experiment Station, at Berkeley, as to the probable value of the material, and its special uses.

CAUTION IN USE OF FERTILIZERS.

Besides the injunction already given against application of fertilizers when the soil is already quite rich enough to produce good fruit and plenty of it, it should be noted that manures unduly rich in animal matter should be used with caution, as they may overstimulate the plant, delay or reduce fruiting, injure the quality of the fruit, and possibly engender disease in the tree or vine. Excessive size and puffiness of oranges is clearly due to excessive use of nitrogenous manures.

The effect of excessive use of stable manures, or other manures very rich in nitrogen, upon the products of the vine has been frequently noted.

METHODS OF APPLYING FERTILIZERS.

Suggestions concerning proper application of barn-yard manures, both to young trees at planting and to bearing trees and vines, have already been given. The same conditions which cause slow decomposition of stable manures apply to any fertilizing material which is not readily soluble in water. All such material should be in a finely-divided state. Surface applications of ground bone, will, in the dry climate of California, lie practically unchanged for a long period. Ground bone should be plowed in as deeply as can be done without injury to the roots of trees and vines, and then, if the surface is kept cultivated, it will lie in moist strata and decompose, or be seized by the searching rootlets. On the other hand, superphosphate, or other really soluble chemical fertilizers, will produce immediate results, and can be most economically used on light and easily permeable soils, on which falling water sinks and does not flow over the surface. In leachy soils a part of such fertilizers might be carried down beyond the reach of shallow-rooting plants, but there is little danger of this in the case of trees and vines.

When superphosphate is used on irrigated ground, it is sometimes drilled in to prevent its being carried along with the running water. One way is to run a chisel-tooth cultivator

ahead of the grain-seed drill and to distribute and drill in the fertilizer as deep as feasible to do without injuring the roots.

Manures with Irrigation Water.—Distribution of fertilizers by using the flow of irrigation water is described by A. S. Chapman, as follows:—

We shovel sheep manure into the irrigating ditches, allowing each tree to receive about twenty-five pounds at each separate irrigation. Our basins cover the entire surface of the ground. We make no effort to choke such weeds as clover, alfilerilla, and the like; but the irrigator with his hoe destroys the obnoxious nightshade, hoarhound, and nettle.

In the fall of the year we follow with copious liming—about three barrels of unslacked lime to the acre—applied in the following manner at the head of our irrigating ditch: We plant a box about three feet wide, six feet long, two feet deep, and six inches under the surface of the running water. In it we place a barrel of the lime. It slacks and swells to twice its original bulk. A man stands on this with his hoe and sees that the water carries it off evenly. With an irrigating head such as we use, a man will run into the ditch four barrels a day, or about three barrels to the acre. We have a considerable fall, and the water runs very rapidly; but it takes up all the lime, and the water runs white, like milk.

We now leave the orange orchard till spring, when we plow under weeds, manure and lime. We thus aim to supply our soil with nitrate of lime, potash, and magnesia. Carbonic acid gas is absorbed by the water and attacks the inert plant food in the soil; hard-pan is prevented both by the mechanical effects of the vegetable matter and the lime.

The basin method of irrigation, to which allusion is made, will be more fully described in the following chapter.

FERTILIZING MATTERS IN IRRIGATION WATER.

Water used for irrigation may carry in solution injurious substances, as, for example, alkali, as will be noted in the following chapter; or it may carry very valuable fertilizing properties. These facts can only be determined by analysis. Professor Hilgard has found that the water of one creek in Alameda County carries to the land it irrigates about half a grain of potash in each gallon, which means that if twelve inches of such water were used on the ground during the season, each acre would receive therefrom about twenty pounds of fully available potash. At Riverside a crop of oranges requires about forty-two pounds of potash per acre, of which the amount of irrigation water generally used contains thirty-five pounds besides other matters required by plants. These things have a definite cash value in the market; and this value the irrigator gets as a free gift in addition to the water. Even in the case of the Nile, the sediment is only part of the sum of fertility conveyed by the river.

GREEN MANURING.

Green manuring consists in plowing under a growth of weeds or a sown crop to secure by its decay a contribution of

humus to the soil. All plants by their decay in the soil add organic matter to it, and this matter is of nitrogenous character, but leguminous plants do this and a great deal more, for by their exclusive ability to use atmospheric nitrogen, There is also special value in deep-rooting legume in soil amelioration. There is now reason to believe, as has already been stated, that where moisture is ample for both alfalfa and trees we shall come to using this plant for a permanent cover of orchard ground as a substitute for a part of the clean culture which is now observed. This is, in fact, already being done to some extent. It is also probable that alfalfa can be used for a certain time even where its permanent stand is not desirable, for it is not difficult to destroy alfalfa with a well-sharpened plow although the roots may have attained considerable thickness. Of course this, as already stated, depends upon moisture supply; where that is not abundant clean culture for moisture conservation is unavoidable. But where moisture in excess of the needs of the trees is available it will be used in future indirectly for their benefit in ways we are only just beginning to discern, and one of these is likely to be the summer growth of legumes in the orchard.

This is, however, largely a matter for future determination, and under ordinary conditions may never be practicable. The wider problem is to secure a leguminous plant which will make a heavy growth during the winter months, so that it can be plowed in early in the spring, and the ground put in shape for the thorough surface pulverization to prevent evaporation of moisture during our long, dry summer. For this reason we cannot use many plants which are used for green-manuring in humid climates. Crimson clover, cow peas, etc., do not make good winter growth. They make exuberant growth for a time in the spring when heat is adequate and moisture abundant, but at that time it is too late to grow crops for plowing under because the soil is too dry for their decay and their presence tends otherwise to the loss of moisture and makes it very difficult to secure a good surface tilth. The greatest care must be had not to allow a growth of weeds to stand too long or its covering will do more harm than good. These tender legumes may have some local value on moist lands in the summer time, but hardy legumes are the desideratum both for winter forage and green-manuring. The common "bur clover" (*Medicago denticulata*) is proving very satisfactory in some parts of the State, and the "Canadian field pea" is coming into quite wide use in some of the southern citrus orchards. Experiments are also in progress with the lupines which may yield valuable results.



WINTER GROWTH OF ALFILARIA FOR GREEN MANURING - By W. M. Bristol, East Highlands.

CHAPTER XV.

IRRIGATION OF FRUIT TREES AND VINES.

Whether fruit shall be grown with irrigation or not is a local and specific question, and it must be answered with due regard for several conditions, among which are: First, the minimum local rainfall; second, the character of the soil and subsoil; third, the situation and environment of the ground on which the fruit is to be grown; fourth, the kind of fruit which it is desired to produce.

These conditions are all correlated, and a knowledge of them all is necessary to an intelligent decision as to correct practise in any given locality. For example, the amount of rainfall which is adequate in one locality, or in one situation, even, may be quite insufficient in another, because, first, one soil may be deep and fairly retentive, into which roots can penetrate and find abundant moisture; second, another soil may have sufficient depth, but be so porous as to lose its moisture by evaporation, or so leachy as to lose it by drainage; third, still another may be shallow, and quickly dried out under a fervid sun, or quickly drained by reason of a sloping substratum of rock or hard-pan, while another similar soil, differently situated, may receive abundant moisture from the drainage of the slope above it; fourth, possibly in all the soils cited there might be adequate moisture for deciduous fruits, but citrus fruits would require irrigation; or enough for young, but not for bearing trees.

Thus it appears that even to decide whether a location has sufficient rainfall for the growth of fruit without irrigation, one must pass judgment upon all the conditions first mentioned. It is hardly worth while, then, to discuss such a topic upon theoretical grounds, or to attempt to answer the general question, Shall irrigation be employed in the growth of fruit? The true guide is enlightened local experience, and the true test is the growth of the tree and the excellence of its fruit. So long as the grower is able to secure every year a generous amount of good-sized and excellent fruit by natural rainfall, he need concern himself very little about irrigation; if his tree shows distress, and his fruit, even when properly thinned out, is not up to market standards every year, he may do well to provide himself with irrigation facilities, either for constant use or to supplement rainfall when it is occasionally deficient.

Of course it is not commended as a rule of practise that the grower wait until the tree shows signs of distress before applying water. This is a very bad plan of proceeding, but the visible language of the tree is mentioned as indicating once that the tree needs help, either at regular intervals or occasionally, and after such a warning the grower should be able to tell by examination of the soil and by study of the local rainfall record when this need will occur, and apply his water in advance of the need.

Recent experience has enabled fruit growers in all parts of California to arrive at a truer conception of the relation of irrigation to the growth of fruits. Many who have long scouted the suggestion that irrigation was necessary for deciduous fruit trees in their districts, have during the last few years found that water, in addition to the rainfall, was very profitable, either to enable large, bearing trees to produce larger fruit, or to maintain in full vigor their later summer growth and to make strong fruit buds, which ensure the following year's production. It has also been widely demonstrated that a tree which is adequately supplied with water, no matter whether it be directly from the clouds or through the irrigating stream, yields fruit of better size, aroma, flavor and carrying quality than a tree which, from any cause, falls even a little short of an adequate supply. It is clear then that neither irrigation nor non-irrigation are in themselves principles, but are merely methods to be employed when conditions demand the one or the other.

The fact that water is sometimes used to excess, and the fruit thus grown is found to be lacking in using and carrying qualities, militates not against irrigation, but against the ignorance or carelessness of the grower. It has been clearly shown by the experience of our fruit-shippers and canners that wisely-irrigated trees bear fruit admirably suited to their purposes, and that if proper size is not attained with the natural rainfall, by proper cultivation, pruning, and thinning, irrigation should be resorted to. Of course the water should be applied at proper times, in proper amount, and in a proper way.

HOW MUCH WATER SHOULD BE USED?

This is by its very nature a very elusive question and any attempt to answer it by definite prescription is more apt to produce folly than wisdom. For as it appears that whether irrigation is at all needed or not depends upon several conditions which must be ascertained in each place, so the amount of water, which is really an expression of the degree of that need, depends also upon local conditions of rainfall, of soil depth and retentiveness, of rate of waste by evaporation, of the particular thirst of each irrigated crop, etc. The result secured by the use of water

is really the ultimate measure of the duty of water in each instance. In the case of fruit trees and vines, then, whatever amount of water secures thrifty and adequate wood growth and strong, good-colored foliage, but not excessive or rank growth; and abundance of good-sized and rich, but not monstrous and watery, fruit, is the proper amount for that place and that product,—and to the ascertainment of that amount, by local experience of himself and others, the grower should employ his most earnest thought and his keenest insight.

It is, however, a fact that this rapid generation seeketh persistently after a sign, and has more respect for one who declares a recipe than for one who suggests a reason. Evidently some outlines, at least, of a prescription must be attempted, and possibly it may serve as some sort of a measure to those who may be beginning without any knowledge whatever on the subject.

During the year 1899 the writer renewed his data of the irrigation practise of California fruit growers by systematic inquiry, and presents in adjacent tables a partial transcript of the results, which may be suggestive to inquiring minds.

INSTANCES OF IRRIGATION FREQUENCY, SEASON AND VOLUME.

CITRUS FRUITS.

COUNTY.	Rainfall, inches.	No. of irriga- tions.	Time of irrigations.	Acre-inches* each irrigation.	Season Totals.
Tulare	10	5 to 8	April to Oct..	4	20 to 32
"	8 to 10	Mar. to Oct..	6	48 to 60
Fresno	8	2 to 7	April to Oct..	2	4 to 14
Ventura... ..	20	5 to 6	Mar. to Oct..	2½	12½ to 15
Los Angeles.....	12	3	June to Oct..	6 to 9	18 to 27
"	10	6	May to Oct..	3½	21
"	18	3	June to Oct..	4	12
"	20	3 to 4	July to Sept..	1½	4½ to 6
"	20	3 to 7	" " ..	1	3 to 7
"	20	6	" " ..	¾ to 2	4½ to 12
"	20	7	Mar. to Nov..	1½	10½
"	18	3	" " ..	2	6
"	15	6	May to Oct..	1½	9
"	20¼	7	April to Oct..	1½	10½
"	18	4	July to Oct..	1½	6
Orange	15	4	May to Oct..	2½	10
"	10	4 to 8	" " ..	2	8 to 16
"	12	6 to 8	" " ..	4	24 to 32
Riverside	12	7	May to Nov..	3	21
"	7	6	Apr. to Sept..	1⅓	10
"	10	7	Apr. to Nov..	3	21
"	8	8	Apr. to Dec..		
"	11	3 to 7	May to Nov..		
"	10	4 to 6	May to Sept..	6	24 to 36
San Bernardino.	12	6 to 7	June to Oct..	4½ to 10	24 to 31½
"	4 to 6	May to Sept..	6	24 to 36
San Diego... ..	8	4	May to Oct..	2½	10
"	12	5	" " ..	3	15
"	10	4 to 8	" " ..	2	8 to 16
"	8	6 to 8	" " ..	4	24 to 32
"	18	3	June to Oct..	3	9

INSTANCES OF IRRIGATION FREQUENCY, SEASON AND VOLUME.

DECIDUOUS FRUITS.					
COUNTY.	Rainfall, inches.	No. of irriga- tions.	Time of irrigations.	Acre-inches* each irrigation.	Season Totals.
Shasta	40	3 to 4	Summer	2	6 to 8
Butte	28	1	February.....	12	12
Colusa	12	1 or 2	Winter	12	12 to 24
Nevada.....	40	1	Summer	2½	2½
Placer	25	10	May to Oct... 1¼		12½
Sacramento	18	5	June to Oct... 1		5
"	3 to 4	July to Sept. 1¼		3¾ to 5
"	8 to 10	June to Aug. 1¼		10 to 12½
Santa Clara	16	1 to 3	Mar. to June. 3		3 to 9
"	20	1	March	12	12
"	15	3	July to Aug. 4		12
"	12	1	Winter	8 to 10	8 to 10
"	20	3	Jan. to July. 4		12
Monterey	13	1 to 4	Feb. to June. 4		4 to 16
Merced.....	12	3 to 4	Summer	2 to 3	6 to 12
"	10	2 to 4	"	3 to 6	6 to 24
Fresno	8	3 to 4	"	2½	7½ to 10
"	8	1	February.....	12	12
"	8	2	Mar. to July. 6		12
Kings	7	2 to 4	Summer	4	8 to 16
Kern	4	2	Mar. to June. 4		8
Inyo.....	3½	5	Apr. to Aug. 1½		7½
Los Angeles.....	18	1	Mar. or Apr. 6 to 9		6 to 9
"	20	1	July.....	6	6
"	12	2 to 3	June to Nov. 4		8 to 12
Orange	15	2 to 3	Summer	2	4 to 6
"	12	2	"	4	8
Riverside	15	3 to 6	May to Sept. 1½		4½ to 9
"	10	3 to 4	Apr. to Sept. 1½		5 to 6½
San Diego	8	3 to 5	Summer	2	6 to 10
"	18	3	"	3	9

* An acre-inch is an actual depth of one inch over the surface.

The foregoing outline of local practise shows that infinite variety exists and in the nature of the case must exist, and that any definite prescription of the duty of water is impossible. The compilation includes, however, the extremes, and in this way gives a sort of picture of prevalent practise. In some cases cited, in which the amount of water at each irrigation seems small, the fact is due to the use of small basins, while in this computation the contents are reduced to acre-inches which cover the whole surface; in other cases, as, for instance, the frequent irrigations in Sacramento and Placer Counties, the soils are shallow, overlying bed-rock, and a small amount saturates them. In other places an acre-foot of water is readily absorbed and retained in the deep soil. The annual rainfall is also seen to have little relation to the amount of irrigation, because neither fine shallow, nor deep coarse soils, can retain the volume of water which falls upon them during the rainy season. Then the vary-

ing rate of evaporation, the character of tilth, etc., enter as factors, and it becomes clear that he is fortunate enough who knows how much water to use on his own place.

WHEN TO IRRIGATE.

The outline of experience which has been given includes times for irrigation as well as amounts of water used, but when to irrigate is governed by local conditions and the needs of different fruits and can not be stated in general rules. There are, however, some principles involved which may be hinted at.

Winter Irrigation.—On lands with sufficient depth of fairly retentive soil, the grower may artificially supplement a scanty rainfall by thoroughly soaking the land by winter irrigation, and then by careful summer cultivation he will be able to conserve enough water in the soil to carry deciduous fruit trees or vines through bearing and autumn bud formation without further water supply. But there are other situations in which no amount of winter irrigation nor rainfall will suffice for these ends. There are foot-hill orchard areas in which the winter rainfall is two or three times as great as in the valley situations where fruit is successfully grown without irrigation, and yet water must be applied in summer on those foot-hills or the fruit would be unmarketable and the trees in distress. The forty or more inches of rainfall falling on a shallow soil underlaid by a sloping bed-rock in some cases nearly sluices the cultivated soil from its foothold, and yet the oversaturation in winter avails nothing for summer growth, because most diligent cultivation can not retain moisture enough in shallow soil thus situated to sustain bearing trees in good crops of full-sized fruit. The same is true of valley soils underlaid by hard-pan. In such cases winter irrigation could add nothing but distress to the soil oversoaked by rainfall; and summer irrigation, well-timed and adequate, is the secret of success in the orchard. The same conclusion must hold for soils underlaid by gravel or sand and thus too rapidly dried by leaching.

But even this generalization must be accepted only for situations endowed with conditions which justify it. There may be sloping hills with shallow soil where winter rainfall does not amount to saturation. Then winter irrigation to supply such saturation is desirable, and then, too, summer irrigation in proper amount and at proper intervals, will also be demanded. Among the foot-hills, also, there may be localities with depth of retentive soil in which water enough can be applied in winter to carry trees through the year. Thus we come again to the only safe generalization which can be made, and that is, that everywhere water must be adequate to the demands of the tree at the time it is needed, and whether it can best be applied in

summer or winter, or both, or whether it is not necessary to make any artificial application at all, depends upon existing conditions which the grower must ascertain and to which his policy and practise must conform. It is a fact, however, that in all soils, which under good cultivation are fairly retentive, winter irrigation, when water is most abundant, and usually carries most sediment, can be made to go far toward making summer irrigation unnecessary for all deciduous fruits.

As to winter irrigation, practise varies, some relying upon a single heavy flooding by using checks on contour lines, by which, perhaps, a foot in depth or more of water is allowed to soak into the soil; others use the same method of application in winter as in summer, and, therefore, give a number of irrigations in winter. There is, of course, much less danger of injury by water to deciduous growths in winter, because they are dormant, though an eye should be kept on drainage for excessive irrigation as for excessive rainfall. The grape and the pear are known to endure long submergence, but some other fruits are sensitive about it.

Summer Irrigation.—When this shall begin and when end are to be locally determined. In some places even the earliest fruits can not reach satisfactory size and quality without irrigation. In others rainfall with winter irrigation will suffice for proper development of early fruits, but not for late. In both cases the fruit may be satisfactory, but the tree unable to hold its leaf vigor until the work of the growing season is properly completed. It is then apparent that local practise must vary in order to reach the universal fact, and that is that all through its active season the tree must have constant and adequate moisture supply. Many evils in lack of bearing, in dying-back, in unseasonable activity and the like are due to inadequate, intermittent and, in some cases, to excessive moisture in the soil.

Cultivation and Irrigation.—With such an extension of irrigation practise as is now being realized, there is danger that those who have previously trusted so fully upon good cultivation may swing to the other extreme and trust too much to the stream of water and too little to the plow and cultivator. There is a temptation this way when one finds that he can run water in large amounts very cheaply. Not only is there danger of over-irrigation in the growth of tree and fruit, but the ill effects of water upon the soil, when unattended by good cultivation, are constantly threatened. The tree needs air as well as water; it needs a certain free condition of the soil for its best root action. These needs can be amply secured when adequate application of water is quickly followed by soil-stirring. Irrigated soil rightly treated is delightfully mellow and free and of condition to invite

the fullest activity on the part of the tree. Irrigated ground not properly treated becomes compacted, fissured, cloddy and generally hateful, losing moisture rapidly, setting around the roots like cement and tearing them by its subsequent shrinkage. These conditions do not occur on the lighter soils, and yet even these are best when cultivated in a rational manner.

METHODS OF IRRIGATION.

There are various methods employed in California for the conveyance and application of water to trees and vines. Some of the principal ones may be enumerated and described as follows:—

Permanent Ditches.—Permanent runways for water are becoming far less popular than they were in earlier days, because it is seen that the trees thrive far better if cultivated. There is, however, on hill lands difficult to plow and cultivate, and prone to wash, a naturally strong temptation to lay out the ditches once for all on grades suitable for slow running of the water, and trust to seepage and percolation from these ditches to supply moisture to the trees adjacent to them. By this method irrigation must be more frequent than by other methods which will be described, because the soil is not so well saturated, and even the more frequent application takes less water than less frequent application through newly-turned furrows. There is, also, necessity for much work with the hoe if the grower pretends to keep down the weeds—which, however, is not always done, and the running water distributes the seeds.

Annual Ditches.—A modification of this method, which prevails to some extent in the foot-hills, consists in giving the orchard a thorough plowing when the heavy rains are over in the spring, plowing under the winter growth. The surface is kept stirred after later showers. In May shallow ditches are made with a double-moldboard plow nearly along contour lines, which are quickly located with a level. Slight fall is given so the water will flow slowly, and these ditches are used all during that season, and allowed to remain to carry down winter water until the next thorough working in the following spring. This plan makes summer cultivation somewhat difficult, but it may be the best method on the sharp foot-hill slopes.

Large ditches are also used between the rows of bearing trees on level land in soils which readily absorb water and the roots are widely extended. It is chiefly used on lands adjacent to rivers, from which water is pumped in large volume. For example, along the Sacramento River, on land that is apt to bake by flooding, or by the large check system, soon to be described, large ditches are plowed out in the centers between the tree rows

and they are kept full of water, often for ten days at a time. This is done twice for fruits that ripen before August 1, and once afterwards for late fruits. The ground between the ditches and the trees is cultivated frequently.

Fresh Furrows.—Irrigation by freshly-turned furrows is the most prevalent method in this State, and is popular in all our irrigated regions where the soil is such that water freely distributes itself laterally, and does not flow directly downward, as in some soils. The furrow system, as practised at Riverside, will serve to illustrate the method:—

Along the head of the tree rows is placed a flume of wood or cement into which the water comes from the measuring box of the water company. This is made large enough to carry water sufficient for all the furrows, and opposite each proposed stream is a little gate or outlet. A marker or irrigating plow has prepared the land to receive the water by making from 4 to 6 shallow furrows in each space between the tree rows. Into this the water is allowed to slowly run—that is, if the irrigator be an expert. If he be not a good irrigator he will turn into each furrow a head sufficient to push the water through in a hurry, and in so doing wash down to his neighbor or back into the river the best of his soil. Some boast that they can run water a week without running off their land 2 per cent of the amount received; but these are few in number. The hasty application of water has a tendency to form a "slickens" that seems to prevent the water from penetrating into the soil as it does when it moves slowly. Given time, it will soak so deeply that one may sink a hoe-handle its length in the deep and fertile soil. It is only occasionally that the conditions are so favorable that it is well to allow the furrows to be over 60 rods in length, although eighty is the more common distance. The ideal distance is about 40 rods, where the grade is perfect.*

Building Flumes for the Furrow System.—These are made in different ways, but well-made lumber flumes are best on all accounts. The following are explicit suggestions for construction:—

Sixteen-foot lumber is better than longer. The sides of the flume should be of 8-inch lumber throughout, nailed to the side of the bottom, making 7 inches high inside. This size will carry about 75 inches of water. Reducing the flume in size, and keeping it nearly on a level, will give you the same pressure throughout. This is very important in regulating the streams. Place the first length about half its depth in the ground, and as it goes along and comes up too high, put in a drop of 2 or 3 inches or more, if necessary, and so on through the length. The first section, however, should be about 2 feet wide, narrowed to the size of the flume so as to control the stream. Collars should be put around the flume every 8 feet of distance; that is, one in the center and one to cover the joints at each end. These collars should be 2x3-inch stuff on the bottom and sides and 1x3 on top. This makes a strong, durable flume. The width of the flume should be reduced so the stream will decrease as it goes along; say from 16 inches to 14, 12, 10, 8-inch—the sides being the same throughout or reduced so as to have 10-inch sides on the 16-inch bottom and 8-inch sides on the rest—nailed to the side of the bottom. Two-inch holes are none too large, in order to keep them clear of trash, such as leaves, etc. By lifting up the

* E. W. Holmes, Riverside.

slide of the gate it will wash out. I generally shut the gate down the thickness of my finger. In this way each gate can be regulated very nicely. All flume material should be of the best soft redwood, as the hard warps and cracks."

At the Lower End.—As all conditions have to be very favorable if there is no overflow at the lower end of the furrow-face and as the water has less chance to penetrate there it is common to run cross-furrows or to make cross-checks which will retain water at this point until it soaks in. Others locate an alfalfa patch below the orchard into which the overflow passes and is utilized.

The Number of Furrows.—There is a wide variation in practice in the number of furrows employed for different soils and different ages of trees. This must be determined by local observation.

Flooding, Checks, and Basins.—These are different methods of bringing the water to bear upon a broad expanse of surface, and are best fitted for deep, leachy soils, in which, from the direct downward course of the water, the distribution by furrows would be very imperfect.

Flooding, as the term implies, consists in allowing the water to flow over the whole surface of the ground, dirt being, however, drawn up around the tree to prevent access of water to the bark, which is a cause of serious disease. Flooding is done by running a considerable head of water broadcast down each several row, shifting it from one to another as soon as the stream has run through. To use this method the ground must be quite level, or serious washing is likely to ensue, and the soil must be of rather a porous character, for the water is not held in contact with the soil, as in other methods. It is obviously a bad method for soils disposed to run together, and is so uneven in distribution that it has been widely replaced by the check system, which is more rational.

The Check System.—The check system aims to hold a certain depth of water, until it is absorbed, upon all parts of the surface except the fraction occupied by the banks or small levees which inclose the checks. It requires considerable displacement of soil, which necessitates hard work and constant attention while the water runs, which is not the case with the furrow system. The compensation must be found in the fact that, when well done, there is certainty that each tree has received a certain adequate amount of water in all parts of the soil-mass which belongs to it.

There are various ways of practising the check system, advancing in character from the simple plowing of furrows each

* A. S. Bradford, Placencia.

way between the rows to the construction of well-defined and strong banks with suitable implements which reduce the cost to a minimum. The following method, as practised in Orange County, is of the latter class:—

The ground is deeply cultivated, say about five inches deep, so as to be able to throw up a high ridge; then with a four or six-horse "ridger" run once each way between every row, if it is a citrus or deciduous orchard, and twice should the trees be walnuts, as the larger checks require better banks or ridges. After this is done run entirely around the outside of the piece to be irrigated, so as to have as perfect a ridge as possible on the outside. Then, with one horse attached to what is locally known as a "go-devil," proceed to close up one side of the checks. The practise generally followed is to close up the high side of the checks, if the land does not cut by running water, but if it cuts, close up to the lower side. After closing up the checks the ditches are plowed out, and then what is known as a "V" is run twice through them to perfect the ditch. On lands inclined to cut, it is advisable that the length of the rows to be irrigated should not be over 250 feet, but in heavy land this distance can be considerably increased, if necessary, without danger of cutting the ridges by too long a run of water.

If the checks have been closed on the low side of the ridge, it is better to run the water to the ends of the ditch and water the last row first; but if closed on the high side, water the row nearest the gate or main ditch, as the case may be, first, as in each instance there will be dry earth to work with, if necessary, when closing up the checks. The water is run down the row to the end tree, and as soon as the last check is filled it is closed up, and so on till all are filled and closed, when the water is turned down the next row.*

The "ridger" described is a sled with the solid plank "runners" set farther apart at the front than at the rear. With the weight of the driver this takes in much loose earth in front, which is crowded up as it proceeds to the narrow space behind, and is left as a well-defined ridge. The passing of this "ridger" in crossing the first-made ridges breaks them down, and as many as it is desirable to close are quickly fixed by the "go-devil," which is a large horse-hoe, or sort of square scoop, fitted with thills for the horse and handles for the man. Coming to the gap in the ridge the man lifts on the handles and the earth is placed to restore the ridge, all but a little touch with a shovel afterwards.

Sometimes the checks are filled one from another, beginning on the high side; sometimes a central ditch is formed by running the "ridger" twice, finished with the V, and the water is admitted to each check from this central ditch. In this way the men can work down one side and up the other, and finish at the point where the water is to be diverted to the next set of checks, of which several sets should be fixed in advance of the water if possible. Weak places in checks or ditches, in soils disposed to cut, can be strengthened by old grain sacks opened out and weighted down with soil.

*Sydmer Ross, of Fullerton.

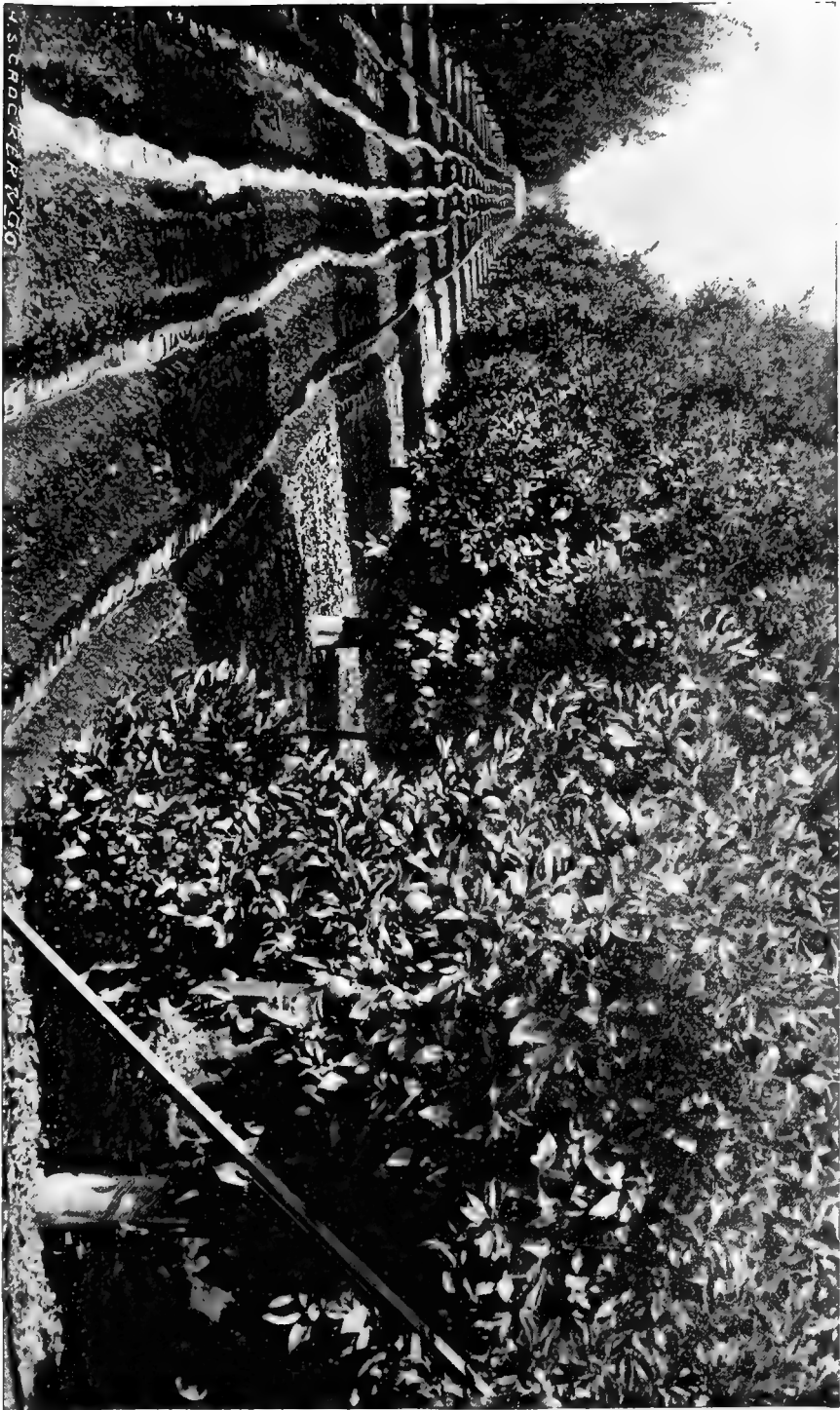

IRRIGATION BY THE FURROW SYSTEM IN A RIVERSIDE ORANGE ORCHARD.—See page 174.

Basins.—This word is often used to indicate the check system, but should now have a narrower signification to distinguish between enclosures which cover nearly the whole space, or only a fraction of it. The latter are properly basins. On some slopes they are useful because they can be scooped out so as to give a very high barrier on the low side. They are also useful in using a very small continuous stream without a reservoir. They are defective in not widely distributing moisture and thus inducing root extension. They are usually made by hand labor and often filled with a mulch of straw or manure to prevent cracking of the soil and to reduce evaporation. Whenever they are used they should be broken up and the soil thoroughly tilled at least once a year.

DEVELOPMENT AND STORAGE OF WATER.

It is, obviously, beyond the limitations of this work to attempt an extended review of irrigation enterprises and practises. The enterprises undertaken by capitalists, or by co-operation among settlers, require the services of competent engineers. All these matters are too great in extent and variety to be discussed in this work. As, however, it has been the aim of the writer to aid the inexperienced planter to help himself in small efforts, a little space will be given to suggestions as to how a planter may develop and use such small water supply as may be derived from spring, small creek or well, on his own land without employing an engineer.

Running Lines for Irrigating Ditches.—How far to go up a creek in order to bring water out upon a given piece of land is a question which frequently arises in individual practise. There is also doubt as to how much fall should be given to the ditch. The fall required by a ditch or canal depends upon the amount of water which it is desired that it should discharge, and upon the width and depth with which it is intended that the water should flow. It may also be dependent upon the character of the soil in which the ditch is to be constructed, and upon the peculiarities of the water itself. A strong current in soft soil may cause mischievous erosions. Water carrying much sediment must never be allowed to move sluggishly, as clear water sometimes may. It is best to state the requirements to a competent engineer and act on his suggestion, or secure the counsel of a neighbor who has had experience with similar soil and water.

Having decided what fall to give the ditch, the nearest point at which water can be taken out of a creek to be brought to a certain piece of land is found by commencing with the point at which the water is to be delivered (generally the highest point

of the land to be irrigated), and running up stream a line which has the inclination intended for the ditch.

To stake out this line when no special hindrances are in the way, use a home-made leveling instrument constructed as follows:—

With sound, straight-edged lumber a triangle is made, as indicated in the sketch. The three pieces, AB , 6 feet long, BC , 12 feet long, and CA , 4 feet long, are made fast to each other at A , B , and C . The board, AD , is fastened to the triangle at right angles to BC . Near A , on the board, AD , a plumb-line is made fast. The plumb, like a mason's plumb, hangs in a hole at F , so that when AD is vertical, the string hangs very near the surface of the board, AD .

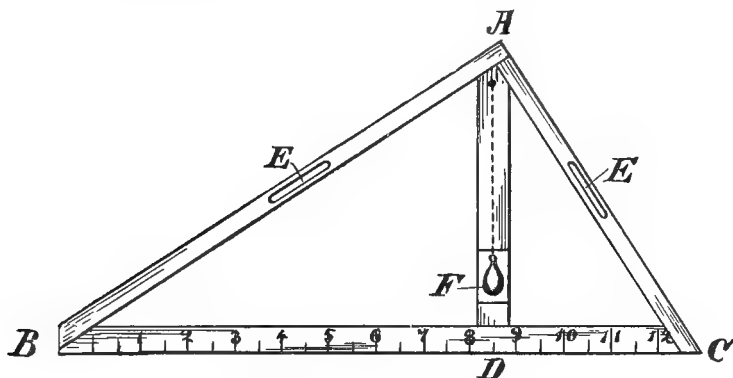

A Home-made Leveling Instrument.

It will be seen that when AD is exactly vertical, BC is exactly horizontal, if the angles at D are true right angles. An ordinary carpenter's square used in the construction of the apparatus will insure sufficient accuracy in the position of AD .

In marking on the board, AD , however, the line in which the string of the plumb will hang when BC is exactly horizontal, more care is required. Two pegs are driven, as far apart as B and C , for these points to rest on. The highest one is driven into the ground until the plumb-line follows about the center line of the board, AD . Having marked this position of the plumb-line, the triangle is reversed so that the end B rests on the peg where before we had the end C , and *vice versa*. Should the plumb-line be in a position at variance with the first one marked on the board, then the correct position for the BC horizontal will be exactly in the middle between the two found by the aid of the two pegs.

It will frequently be found convenient to have a scale of feet marked off on BC . Holes in the pieces AB and CA at $E E$, or handles, will make the triangle convenient to carry. Only two men are necessary in using it.

To use this instrument for locating the line of the ditch, calculate the amount which your line should rise between each two pegs. Drive a peg at the starting-point with its top say six inches from the general surface of the ground. Hold one end

of the levelling apparatus above this peg by exactly that amount which the line rises per each instrument-length (BC), and swing the other end around into the direction from which the ditch is to come, until, when level, it is just six inches above the ground. Drive a peg here, which will, like the first, be six inches high, and proceed as before. Care should be taken to give the top of each peg exactly the correct elevation. The level must be horizontal when resting on any peg, and raised exactly that amount which the line rises per level-length, above the preceding peg. It will be found convenient to use a carefully-prepared block to hold on the top of each stake at the rear end of the level instead of trusting to measurement each time.*

Locating Contour Lines for Checks or for Distributing Ditches.—This work can be done with the aid of the level above described. For instance, to locate a contour (a line of equal elevation), as required in the construction of a check levee, drive a peg until its top has a convenient elevation from the ground, say one foot. Rest one end of the triangle on this peg and swing the other around until when BC is horizontal this other end has exactly the same elevation from the ground as the top of the peg. At this point drive a second peg and proceed as before. If the tops of the pegs be chosen as the height of the levee, they may be retained as grade stakes as well as line stakes for the embankment.

Storing Water from Small Sources.—For individual uses quite a respectable water supply can sometimes be developed from apparently mean sources. This can be done by clearing out and opening up hillside springs, and often by tunneling into the hillside to intercept subterranean water-flows, or by pumping from a well. Even a small spring, yielding but two quarts per second, is equivalent to a three-inch stream, and would be sufficient for several acres in fruit trees. To derive the greatest benefit from small springs, however, a reservoir is necessary, in which the flow of twelve to twenty-four hours, or even a longer period, can be accumulated, and then discharged as required. It is by using water in driblets that many springs are wasted. A spring supplying even one and a half inches of water would be wholly swallowed up by a thirsty soil within two hundred feet of its source, when, by arresting the flow and accumulating it in a reservoir and discharging at intervals in a volume four times as large, it would more than cover eight times the surface. A spring flowing two quarts per second will discharge forty-three thousand two hundred gallons in twenty-four hours. This would require a reservoir forty by twenty

* C. E. Grunsky, C. E., in *acific Rural Press*.

feet, and seven feet deep, or double that width if the depth is decreased one-half. The shallower it can be made the better, for many reasons, but especially on account of the temperature of the water. That of springs is generally too low in summer for immediate use, and its value is greatly enhanced by being raised to an equal or greater temperature than that of the air. This is quickly done by exposure in a shallow pond. A reservoir can be constructed entirely in the ground where the slope will admit of it, and by lining the bottom and sides with clay well puddled, will answer for most purposes. Some are built of adobe, backed with earth and plastered on the inner side with hydraulic cement. Concrete of lime, sand, and broken stone, is, however, the best material, where lime can be readily obtained, and any person with ordinary mechanical skill can construct them. The following hints on a dirt reservoir may be suggestive:—

A reservoir should be built on the highest part of the tract sought to be irrigated by scraping the earth from the outside and from such a large area as not to affect the utility of the land from which it is taken. With a levee all around 5 feet high, 4 feet of water could be carried safely. The slopes ought to be two to one on the inside. A reservoir 20 feet square and 4 feet deep would hold 12,000 gallons. With the slopes as above the reservoir should be measured 2 feet from the bottom, or half way up the 4 feet of water; consequently to lay out a reservoir to hold 12,000 gallons, put the stakes 12 feet square and build. For any other sized one take 8 feet off the same as in this. A reservoir 25 feet square will hold 18,750 gallons and would be 17 feet square at the bottom; one 30 feet square would hold 27,000 gallons and would be 22 feet at the bottom; one 35 feet square—27 at the bottom—will hold 36,000 gallons; one 40 feet square—32 on the bottom—will hold 48,000 gallons. This spread upon the surface of an acre would be a little more than $1\frac{3}{4}$ inches of rainfall.

Almost any loam soil will hold water with a little puddling. The cheapest way to puddle is to build a pen the size of the intended reservoir, including at least a portion of that to be under the embankment, wet it very wet, put some hogs in the pen and keep feeding them barley, a little at a time, so as to make them not only walk around but root for the barley. A half sack of barley fed to eight or ten hungry hogs in half a day will make a good puddle. If it did not work satisfactorily the water could be taken off and the bottom covered about an inch deep with coarse sand mixed one part to five with Portland cement, put in dry, and let it be covered slowly. A barrel of cement may be counted at about 4 cubic feet and with the mixture above would cover the first-named reservoir about $1\frac{3}{4}$ inches. This would make it tight. The supply pipe should come up from the bottom, so that the lift would never be more than the height of the surface.*

Loss of Water by Seepage.—The great loss of water by seepage during a long run has led to the cementing of ditches, and to the use of miles of large wooden, concrete and iron pipe by the irrigation companies of southern California; also, where the slope is rapid, paving ditches with rock has been resorted

* Will S. Green, of Colusa.

to. Similar efforts naturally suggest themselves to the user of a small water supply to save his flow from loss. Where lumber is cheap, the use of a board flume is the most available means of saving water.

Irrigation from Wells.—A considerable area of orchard is irrigated from flowing wells in different parts of the State. Nearly everywhere in the artesian districts there are local well-borers who have kept records of the strata traversed in their work and can estimate closely the cost of securing water by this method.

Wells to supply pumps will be incidentally mentioned in connection with a later paragraph on pumping. They constitute a great and a growing feature in our present irrigation development. Naturally the availability of wells for irrigation must

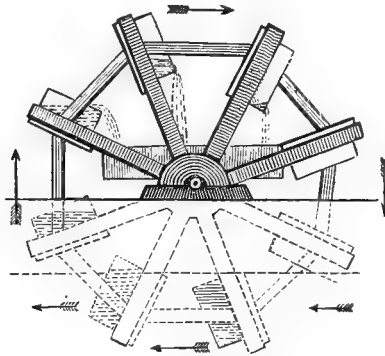

End View of Irrigating Wheel.

be locally determined. Recent experience shows that even deep wells can be profitably used with proper pumping appliances.

Lifting Water from Flowing Ditch or Stream.—Where a stream has a rapidity of two miles or more per hour, and a lift to a height of six to sixteen feet will give head enough to distribute the water over a considerable area, there is nothing cheaper than the current wheel which is largely used in this State. The engraving gives an end view of such a wheel. Eight pairs of arms, carrying flat buckets like those of a steamboat paddle-wheel, extend from a hub rotating on metal bearings. At either end or both ends of each bucket are fixed wooden or tin water boxes which fill themselves on entering the water, and on being brought to the highest point of rotation empty themselves into a receiving trough. This trough supplies the distributing ditches, etc., and its inner end is so placed that it comes under the projecting buckets of the wheel without

interference with the motion of the arms. The current of water in the channel underneath forces the buckets down stream, the latter delivering in the opposite direction at the top. By using a double set of boxes, one at each end of each bucket, the water may be delivered on both sides simultaneously. A little experimenting will indicate the proper size of the boxes, which depends upon the velocity and volume of water in the channel as well as the amount to be delivered.

At the Fancher Creek Nursery, in Fresno County, a wheel is used eighteen feet in diameter, and carries sixteen buckets, which empty into a trough sixteen feet above the ditch. The wheel lifts about one cubic foot in two seconds.

PUMPING FOR IRRIGATION.

The year 1898 will be ever memorable for the general awakening of Californians not only to the desirability of an irrigation supply even in regions which had hitherto depended upon rainfall, but to the fact that pumping is feasible and profitable. Thousands of growers began to realize that their orchard soil is merely the cover of an apparently inexhaustible reservoir. Others satisfied themselves that supplies from adjacent streams can be very cheaply thrown to elevations from which the water would flow over their lands. The use of the pump is only just beginning in California, though we have had for years as good and capacious pumping machinery in use as the world can show. The capacity of pumps, their ease and cheapness of operation in this land of oil wells, and of ponderous waterfalls whose power can be transformed into electric energy, warrant the conclusion that in many places water can be lifted from below more cheaply than it can be brought long distances by ditch; and that the supply is more constant and subject to the users' command and convenience. In all parts of the State well-boring and digging and pump construction is proceeding at a rate beyond any parallel in the history of California. Pumping plants of all capacities, from the greatest of the gasoline class, lifting five thousand gallons per minute from a depth of twenty-five feet, down to the plant with a throw of three hundred gallons per minute, all styles of motors and pumps are being constantly multiplied. These plants are being placed upon wells in the orchard or in the vicinity, or upon adjacent streams, or are being mounted upon barges so as to do custom pumping for many orchards. Many new designs by California inventors are coming into use. It would require a volume to contain any adequate account of California's recent progress in these lines. Economic pumping is governed by so many considerations that no general statement would be conclusive in any

specific case. Each orchardist must ascertain his own conditions and then confer with trustworthy manufacturers or their agents as to what will meet his requirements.

As a surety of the general proposition that pumping is feasible and profitable even from deep wells, reference can be made to the Santa Clara Valley, where the most numerous recent investments in pumping outfits have been made:—

There are about 1,500 irrigating plants of all kinds in this valley proper. About 900 of them have been put in during the past three years. Many of them are centrifugal pumps run by steam. These are the larger plants, where from 15 to 40 H. P., and in some few instances a larger H. P., are used, and the size of the pumps range from 4 inches to 12 inches. Most of the smaller plants are run by gasoline, though several use crude oil, and many of these are also centrifugal. Some of these are deep-well pumps, and they are very satisfactory in raising water from a greater depth than 100 feet. From 100 to 400 or 500 feet they work admirably.

The cost of pumping differs materially in the different kinds of power, sizes of pumps and depth of wells. Figuring from what may be a safe average of the actual cost of fuel, a No. 4 pump, centrifugal, with gasoline as power, at 70 feet depth, would cost \$3.00 per day. This would result in 600 gallons per minute, 36,000 gallons per hour, or 360,000 gallons per day of ten hours. Such a stream of water is calculated to irrigate about 5 acres per day—equivalent to a little more than $2\frac{1}{2}$ inches of rain. But these figures being of the best experiments, a better and safer estimate would probably be 4 acres per day or an equivalent of about 2 inches of rain.

But, generally speaking, it is safe to say that at a cost of about \$3.00 per acre for the water the orchards of Santa Clara County can, under the present process, be irrigated, two or three times, at \$6.00 to \$9.00 per acre per year. The average cost of plant is about \$1,200.*

These calculations are chosen because they represent average conditions and include a large number of small plants. There are many cases citable in which pumping plants of great capacity with small lifts are supplying the amount of water indicated at even one-third of the cost mentioned. But plants of such capacity require considerable investments and should be submitted to competent experts for estimates of cost and efficiency.

THE MINERS' INCH.

There is a slight difference in the miners' inch in some of the different mining districts, but for irrigation purposes usually the measurement is as described by section 1415 of the Civil Code, which specifies a miners' inch in this State as that quantity of water which will flow through an opening of one square inch in the bottom or side of a vessel, under a pressure of four inches above the opening. Fifty of these miners' inches are equal to a discharge of one cubic foot of water per second, which is called a "second-foot," of which one miners' inch is the fiftieth part.

* C. M. Wooster, of San Jose.

To get the number of gallons in miners' inches, multiply the given number of inches by 14.961, pointing off five decimals. The result will be the number of gallons discharged per second.

To get the miners' inch in gallons, divide the number of gallons flow, or discharge per minute, by 8.9766. The result will be the number of inches sought.

One miners' inch in gallons per second is.....	0.1496
Per minute.....	8.976
Per hour.....	538.56
Per day.....	12925.44
Per month.....	293,418
Per year.....	4,721,017

This will cover an acre over fourteen feet deep in a year, and cover ten acres about eighteen inches deep ; or would give to ten acres six irrigations of three inches each.

It may be stated, however, that the extreme service claimed for water is from eight to ten acres of trees and vines or five to six acres of small fruits per miners' inch—meaning the amount of one inch running constantly, but to be handled in multiplied inches applied at intervals.

RANDOM SUGGESTIONS.

Without attempting an impossible thing, to wit, to furnish explicit directions for the practise of irrigation, for much of it every man must learn for himself by experience, a few suggestions may be noted, even though more important ones do not come to mind:—

Usually water should be prevented from actual contact with the trunk of the tree. Citrus trees are especially sensitive to such contact, and resent it by "gum disease," which was formerly far more prevalent in the State than now. Care must, therefore, be taken not to set trees which are to be irrigated, too low. It is better to raise them up a little and draw the earth up around them to prevent approach of the water.

If possible, the ditch should run on the shady side of the tree, because reflected sunshine from the water surface may burn the bark.

In examining soil to ascertain dryness, one must dig deeply, for often an upper layer will be fairly moist, if well cultivated, while lower layers, where the feeding rootlets are, will be arid. Therefore, when trees or vines are suffering, dig far down in examining the soil.

In irrigating, thorough, deep soaking is necessary, and examination must be made to see if an artificial hard-pan which prevents the descent of the water has been formed.

Be careful not to continue irrigation too late in the season. It will prevent the proper dormancy of deciduous trees, and if more fall irrigation is given citrus trees than they need for perfecting the fruit, the trees will continue growing tender shoots

until they are injured by severe frosts. On the other hand, it is often desirable to give deciduous trees a draft of water after the fruit has been gathered, if the soil is so dry that the tree is likely to drop its leaves too soon, and wake from its dormancy with the first rains. Many times the fall blooming of deciduous trees, which is very undesirable, may be prevented by keeping them growing later in the summer by moderate irrigation.

If trees or vines, in regions usually irrigated, are to be grown without irrigation, it is important that the grower be more than usually thorough and constant with his summer cultivation. In trying the non-irrigation experiment, one should, of course, begin with young trees which have not been irrigated, and not usually expect success by withdrawing the water from trees which have been accustomed to it, and have developed a root system accordingly.

SUB-IRRIGATION IN CALIFORNIA.

The word "sub-irrigated" is freely used in California to describe land which is moistened below by underflow or seepage from streams or springs, or from open irrigation ditches, traversing higher levels. This land is sub-irrigated, it is true, but there is no system about it, except the natural distribution of water, which is disposed to run down hill. Some of our most productive lands are of this character, and where the soil and subsoil are fitted to the movement of this living water, and not apt to retain it up to the point of saturation, most satisfactory growth of deep-rooting field crops and of trees and vines are secured. But this is not sub-irrigation in the ordinary signification of the term.

Several systems of sub-irrigation have been devised by California inventors, but none have passed beyond the experimental stage, and no considerable acreage is yet in place.

DRAINAGE IN CALIFORNIA.

There was for a long time a very erroneous popular generalization that California soils do not need drainage; that in a dry State the aim should be to retain the moisture, not to part with it. It is, of course, true that we have vast areas of naturally well-drained soil, upon which any money spent for drainage would be in great part thrown away, but we have, also, both in the valley and on the hillsides, localities where, by peculiar character and conformation of the subsoil, water is held in the soil until evaporated from the surface, and the result is a boggy, miry condition, which prevents proper winter cultivation, and at the same time injures the roots of the trees or vines. This defective cultivation, added to the puddling effect of standing

water, makes the soil dry out completely under the fervid sun of summer, and the result is that the wettest soil of the winter is the driest in the summer, and plants which are injured by soaking in winter suffer again from lack of moisture and sustenance in summer. Thus it is a fact, clearly proven by observation and experience, that thorough under-drainage removes surplus water in winter, and ministers to the retention of moisture in summer. More than this, a soil puddled by standing water can not present its contents in available form for plant nutrition, and besides, it loses the fertilizing effects of atmospheric currents, which freely pass through an open, well-drained soil. Wet land is cold and late in spring, and hot as a baked brick under the summer sun; it is no fiction of the imagination to say that well-drained land is warm in winter and cool in summer—that is, cool to a degree which favors quick and free root growth, and cool enough to escape the parching effect of deeply-baked soil.

These, and a host of similar considerations, which have made under-drainage popular in older countries, are of weight in California. Possibly, as a rule, because of our vast area of deep, kind loams, the proportion of land needing drainage in this State is less than elsewhere, and yet there is a vast extent of country to be improved by tiling. During the last few years there have been large losses of trees from planting upon soils defective in this respect. The evil has resulted from excessive rainfall and excessive irrigation, either direct or by underflow from adjacent irrigations. In some places this latter movement of water has brought alkali to assist in the ruin of the trees and vines. The cure is drainage to sufficient depth and with good outlet for the drainage water.

Information on the construction of under-drains is too available through other sources to call for its presentation in this connection.

Drainage and Irrigation.—A special importance attaches to complete and systematic drainage in connection with irrigation. There is pressing need of such provision where the soil has become overloaded by seepage water from irrigation ditches, and it is well that people in such situations are waking up to the need of coupling drainage outlets with their irrigation inlets. Another matter closely allied to this is the action of alkali on soils thus artificially water soaked. This has been made the subject of a special publication by Professor Hilgard, to which allusion has already been made. Drainage is plainly essential, both in individual farms and in districts where the water level is rising too high, and the striking statements given in Professor Hilgard's report will incite all to insist that immediate attention be given to the needs of the State in this regard.

PART THIRD: ORCHARD FRUITS.

CHAPTER XVI.

THE APPLE.

During the last decade notable progress has been made in apple growing in California. The old idea that our conditions did not favor excellence in an apple has given way to full assurance that in wisely selected elevations and exposures the very highest points of size, beauty, flavor, keeping and shipping qualities are secured. Even before the wonderfully satisfactory test of both northern and southern California apples at the New Orleans World's Fair, it was clear that the right variety grown in the right place yields an apple in California than which a better can not be grown anywhere, and during the last five years California early apples have been in sharp request for shipment to all regions of the northwest and British Columbia, and California winter apples have been sold at the highest prices east of the Rocky Mountains and in Europe. Shipments beyond State lines of above seven hundred car-loads in 1898 testify to these facts.

Localities for the Apple.—Speaking generally, it may be laid down that the great valleys of the interior are not well suited to the apple. In the early regions of the Sacramento Valley and foot-hills, however, excellent early apples are profitably produced. In the great valley and lower foot-hill region of the State, the late apple usually lacks character and keeping quality. On the great plains the tree is liable to sunburn, or sun blight, as it is called. Some varieties, because of the character of their foliage, are less liable to this injury than others, and it is possible that this evil may be finally overcome by the selection of varieties with blight-proof foliage, as will be mentioned later. In the great valley, however, on the rich river-bottom land of the Sacramento and the San Joaquin and its tributaries, the apple roots deeply, attains good size, bears good fruit, with fair keeping quality, while but a few miles away on the plains it would be inferior.

In the interior the region of adaptation to the apple lies at an elevation on the foot-hills on both the east and west rims of the great valley. Its limits are not well defined, but there are flourishing orchards at an elevation of about four thousand five hundred feet on the slopes of the Sierra Nevada Mountains, and from two thousand to three thousand five hundred feet is commonly regarded the best apple region of the mountains. The trees attain large size and bear heavily, and the fruit, of well-adapted varieties, is large, crisp, and juicy, and has exceptional keeping qualities.

Along the coast the apple succeeds well from end to end of the State, and very close to the ocean excellent fruit is produced on good soil. There is a certain advantage in elevation in the coast region as well as in the interior, but the advantage is not so marked nor is the required elevation so great. Coast valleys in the central and upper portion of the State, where the soil is suitable, produce most excellent apples, but even here the lower hillsides, with deep, well-drained soils, are, perhaps, preferable to the floors of the valley. Departing from immediate coast influences and approaching the interior, with its greater heat and aridity, the greater elevation becomes desirable. The apple, excepting the very early varieties, does not relish the forcing heat which brings such perfection to the peach, but to insure late ripening and long keeping, with accompanying crispness, juiciness, and flavor, it must have atmospheric surroundings which favor slower development.

Localities for apple growing in southern California are to be chosen with much the same rules as in the upper parts of the State. As has already been said, valleys in which coast conditions largely predominate produce good apples on suitable soils, but away from the coast proper, elevations must be sought, and they should be above the so-called thermal or frostless belts. Good apples are grown on low lands near the coast in Los Angeles and Orange Counties. Sixty miles inland, in San Bernardino County, winter apples fail in the valleys, but are most excellent at a sufficient elevation upon the slopes of the surrounding mountains or in elevated valleys like the Yucaipe Valley above Redlands. In the elevated interior of San Diego County, as in the Julian and Smith Mountain districts, excellent apples are produced in large quantities and profitably carried long distances.

Second and Third-Crop Apples.—There is a peculiar behavior of the apple tree, most noticeable where winter temperature is mildest, and that is blooming and fruiting out of season. In the case of early apples the second bloom may appear about the time the first fruit ripens and the third bloom when the sec-

ond crop is half grown. Even such behavior may be followed by regular blooming the following spring. Second crops of apples are not of amount nor regularity enough to be of much economic importance, as the second crops of pears and grapes sometimes are. The third crop occasionally ripens.

Exposures for the Apple.—The choice of exposure for an apple orchard may almost be inferred from what has been said about localities. In regions with high summer temperature the apple will do best on cool, northerly slopes, and this exposure becomes doubly desirable when the location has high temperature with only moderate annual rainfall, or where the soil is not well adapted to the retention of moisture. With such prevailing conditions, the apple will be grateful for the cooler air and the greater moisture of the northerly slope. Where the temperature is moderately cool, and the rainfall adequate, the matter of exposure is of less account, and the grower can make the existence of the best soil the test of location of his orchard. At elevations on the sides of high ranges where late cold storms are liable to rush down from higher snow fields, protection from the usual course of such storms, or from the course of cold winds generally, must be sought; and directly upon the coast, especially in the northern part of the State, in certain places where the peach does not usually succeed, even the apple may need protection, and the benefit of all heat available, and then a southerly or southeasterly exposure becomes desirable. The choice of exposure is thus seen to be largely a local question and to be determined by a knowledge of local conditions. A newcomer in a region can best learn these conditions by conference with older residents, or by personal observation of older orchards.

Soils for the Apple.—Experience with the apple in California confirms what has long been set forth as its choice of soils in older regions. If one avoid an extremely light, sandy soil on the one hand, and a very stiff clay or adobe on the other, he may plant apples on almost any soil which allows extension of the roots to a considerable depth without reaching standing water. The apple thrives in a moist soil, but it must be well drained, naturally or otherwise. A soil which may be called best for the apple is a deep, rich, moist, calcareous loam, but the tree will thrive on coarser materials. The subsoil, whatever its nature, must be sound and open to the passage of moisture. The most unfavorable condition for the tree is a subsoil of clay which holds water. There is some difference in varieties as to choice of soil. The Yellow Bellflower, for instance, will do well, on a lighter soil than the Yellow Newtown Pippin.

PLANTING AND CARE OF THE APPLE ORCHARD.

The chapters on propagation, planting, and pruning contain suggestions to which the reader is referred. Care should be taken to obtain trees with clean, healthy roots, not knotted and scarred by woolly aphid.

Distance in Planting.—The distance between the trees is of the highest importance. All the old apple orchards are overcrowded. More recently trees have been set at greater distances, and such planting is now generally advised. There is some difference of opinion as to proper distance, but certainly twenty-five to thirty feet is near enough, and some of the best new orchards have been planted at forty feet, the ground being used for a time with other crops or planted with early bearing trees, for which the soil is suited, between them.

Pruning the Apple.—The manner of shaping fruit trees described in the chapter on pruning succeeds admirably with the apple. Yearling trees are usually planted, and they are regularly pruned until proper form is secured. After coming into bearing there must be intelligent pruning according to the growth-habit of the variety. Some varieties, like the Yellow Bellflower, resent heavy pruning after coming into bearing, and slow growers, like the Yellow Newtown Pippin, do not need it. On the other hand varieties, like the Winesap and Smith's Cider, are apt to make long slim branches and bear at the ends. This can be corrected by cutting back to secure more short shoots which will bear better fruit. The grower must study his varieties not only with reference to this but in forming the tree, cutting to an *inside* bud all varieties which naturally take a horizontal direction, and cutting to an *outside* bud varieties which have a tendency to send up tall, straight shoots. By thus throwing the new growth upward in the first case, and outward in the second, one can shape each kind to greater symmetry and strength for fruit carrying, and bring up all spreading varieties to a form which admits near approach of the plow and cultivator. This manner of shaping the tree must continue as long as seems necessary to secure a tree which will come to bearing age shapely and strong, and within reach.

Bearing trees should not be allowed to carry too many branches, and pruning will largely consist of thinning out surplus shoots and removing interference between branches. It is not desirable to shorten in the apple as is done with the apricot and peach.

In regions of the most intense summer heat, less pruning is admissible than in the coast and elevated regions. It is necessary that the foliage be dense to protect the tree and the fruit from sunburn. Nor does the tree seem to relish cutting back.

Slight thinning out, if the tree becomes too brushy, seems to be the best treatment in some of the hot valleys.

Thinning the Fruit.—One of the most important items in the handling of an apple orchard is the faithful thinning out of the fruit of all varieties which are prone to overbear. Although this work is tedious and expensive, it is profitable, because of the improved price which can be had for the larger fruit which will be secured, and it is desirable in the effects of thinning on the tree. It will be relieved from the exhaustion of overbearing, induced to yield annual crops, and often saved from breaking down with a too heavy burden.

GATHERING AND STORING APPLES.

The disposition in this State, as elsewhere, is to allow the fruit to hang too long upon the tree before gathering. It was long ago demonstrated that an apple for long-keeping must be picked early. As late fall weather in California is so delightful, there is more temptation to delay the picking than where the approach of winter admonishes the grower to get his fruit under cover. Picking apples for shipment should be done just when the seeds begin to blacken and when the fruit yields to pressure. If left on until fully ripe, and the seeds all black, the fruit will not keep. This rule applies to fall apples for shipment to distant markets, or for apples to be stored at home.

Nearly all the ways of keeping winter apples have been tried in California. It has been found by experience that apples keep perfectly until late in the spring by piling under the trees and covering with leaves, etc., allowing the rains to fall upon them. When dry north winds blow, the fruit should be sprinkled occasionally. They come out from the cover fresh, smooth, and plump, and for family use such rough storage will often answer a good purpose. For commercial storage, however, good fruit-houses are used. The requisites of such houses are an evenly cool temperature, moist air, and good ventilation, the fruit being open to free access of the air.

Mr. Edward Berwick, of Monterey, a leading apple grower of the coast region, handles his fruit in this way:—

The apples are carefully hand-picked into baskets and at once transferred to ordinary apple boxes—just put in loose, not packed tight as for shipping. These boxes are hauled to the fruit house with as little jar as possible.

This fruit house is built of rough boards (fastened on a heavy frame) with inch-thick battens covering the cracks, and rustic-nailed outside the battens, thus leaving an inch air-space between the boards and the rustic. It is of two stories—the upper devoted to tools and stores, the lower used for fruit, and arranged with shelves accordingly. This lower story has only an earthen floor. One object of this is to give no lodgment for rats or mice, the other is to serve as a means of maintaining a cool, damp atmosphere.

To this end it is kept well watered in apple-keeping season; and, to avoid mildew or mold, it is also liberally sprinkled with ground sulphur. By day doors and windows are mostly kept shut, by night open; this, of course, is to exclude the heat and allow free circulation of the cool night air.

A rather more open house is used in the coast region of southern California, by Mr. T. W. Ward, of Carpinteria:—

It is a slat house made of strips $1 \times 2\frac{1}{2}$ inches, put on one inch apart. The roof is similarly constructed. There are two passages, on either side of which are two shelves, one above the other, *i. e.*, eight in all. The shelves are made of slats placed one-half inch apart, with sides a foot high. The apples are spread on these shelves a foot or more deep. The floor is made of slats, and there are bins on this also. The fruit must receive a thorough sprinkling weekly, unless sufficient rain falls. The slats are close enough to prevent birds doing damage, and the whole building is raised six inches from the ground.

In the mountain regions arrangements must be made for frost-exclusion,—a consideration which does not apply to the valley and coast.

Of course, in selecting apples for storage, all windfalls should be rejected. The fruit should be carefully picked and handled, without bruising. The advantage of spreading on shelves, aside from the free admission of air, is the ease with which the fruit can be examined and all decaying specimens removed.

Marketing Apples.—With well-grown fruit, from an orchard free from insects, or one in which they are absolutely repressed, and the apples properly stored for winter and spring sale, there is a rich reward for the apple grower. The market is free from everything but late pears and citrus fruits, and they cannot replace the apple in popular esteem. Let the fruit be carefully selected and graded into firsts and seconds as to size, and let the brand get the reputation of covering nothing but sound fruit of honest uniformity throughout the package, and in the long run the apple grower will not be ashamed to compare his returns with those of the grower of other fruits—providing, as already intimated, he is growing the right varieties in the right place.

SELECTING VARIETIES.

For the family orchard there should be a selection of quite a number of varieties, ripening in succession, from the earliest to the latest. Which are best in the different parts of the State can be approximately determined from the tabular statement which will follow, and which has been compiled from special reports of hundreds of apple growers during 1898.

The selection of varieties for a commercial orchard is a very different proposition. Only a few kinds should be chosen, with special reference to their growth and bearing, and the markets for which they are intended.

Summer and Fall Apples.—In some regions noted for early maturing of fruit, it is profitable to grow early apples, providing there are facilities for reaching profitable avenues of trade. Except to minister to some special local or distant trade which can be thus foreseen, it must be said that early summer and fall apples are hardly worth the attention of the commercial planter. These sorts are apt to come into direct contest with the magnificent peaches, grapes, and other summer and autumn fruits, and suffer thereby.

Winter Apples.—For large ventures in apple growing, in localities carefully chosen for especial adaptations, a few of the finest varieties of winter apples should be selected. These, as reported from the different counties, can be learned from the table. It is the judgment of the most experienced apple growers, many of whom have old orchards including many varieties, that new plantations of winter apples should contain only about six sorts. Of these, in all parts of the State, three would be the Yellow Newtown Pippin, White Winter Pearmain, and Yellow Bellflower; the other half of the half dozen would be differently made up in different parts of the State, as can be learned from the table which will follow.

Apples for Long Shipment.—There has been for years quite an important trade in shipment of California apples to various ports in the South Pacific Ocean, and recently there has been a sharp demand for California apples for shipment to the eastern States and England. The characteristic size, quality, and keeping of the fruit, together with the size and style of package, have strongly commended the fruit. The center of this trade (1899) is Watsonville, in a coast valley, in the central part of the State. The two apples which are most popular are the Yellow Bellflower and the Yellow Newtown Pippin. It is an interesting fact that these varieties by virtue of quality have overcome the popular fervor for a red apple.

For the Interior Valleys.—In choosing varieties for the hot valleys of the State those making a heavy leaf growth are to be preferred. The Spitzenburg, for example, is a failure in the valleys of the interior. From experience already had it seems likely that some of the Russian varieties, with thick, large leaves, will prove best for such situations. The behavior of the Astracans, the Duchess of Oldenburg, and others of Russian origin, are illustrations of this fact. Other varieties have been on trial for several years, but no great distribution of them has yet been attained.

VARIETIES CHIEFLY GROWN IN CALIFORNIA.

Of the hundreds of varieties of apples tested in California, comparatively few are now grown, as has already been suggested.

Those named below have been reported by growers as succeeding in the localities named with the description, or indicated in the table which will follow. The descriptions of the standard sorts are, in the main, condensed from Downing,* with local notes interpolated when thought necessary. The arrangement is, approximately, in the order of ripening.

Carolina Red June (Southern).—Medium size, oval, irregular, inclined to conic; deep red covered with light bloom; stalk in small cavity; calyx closed; flesh white, tender, juicy, subacid; core rather large.

Early Harvest (American).—Medium size, roundish; straw color, with few faint white dots; stalk half to three-fourths inch, slender, set in moderate cavity; calyx in shallow basin; flesh very white, tender, crisp, pleasant.

Early Strawberry (New York).—Medium size, roundish, narrowing towards the eye; skin smooth, deep red on yellow ground; stalk one and a half inches, rather slender and uneven, in deep cavity; calyx small, in shallow basin; flesh white, tinged with red next the skin, tender, subacid, sprightly.

Red Astracan (Russian).—Large, roundish; skin deep red, save greenish yellow in the shade; pale white bloom; stalk short, and deeply inserted; calyx partially closed and set in slight basin; flesh white, juicy and crisp, pleasant acid; tree hardy and vigorous, and an early bearer. The main reliance in California for an early apple.

White Astracan (Russian).—Large, roundish; skin smooth and nearly white, with faint streaks of red, and covered with white bloom; flesh white. Considerably grown in the Sacramento Valley for early shipment.

Duchess of Oldenburg (Russian).—Large, roundish, oblate; yellow, streaked with red; calyx large, nearly closed, set in wide, even hollow; flesh juicy, subacid.

Gravenstein (German).—Large, rather flattened; a little one-sided or angular; broadest at base; stalk short, strong, deeply set; calyx large, closed, in a large basin; skin yellow, freely marked with light and deep red and orange; flesh tender, crisp, high-flavored, aromatic; a strong-growing and heavily-bearing tree; a standard fall apple in this State.

Red Bietigheimer (German).—Large to very large, oblate, slightly conical, regular; smooth, whitish, or yellowish white, shaded with light and dark red, and purplish crimson in the sun; stalk short, rather stout; calyx closed in large, deep, slightly corrugated basin; flesh white, firm, juicy, brisk subacid.

Maiden's Blush (New Jersey).—Rather large, smooth, regular; yellow, with evenly shaded red cheek; stalk short, in rather wide, deep hollow; calyx closed in moderate depression; flesh white, tender, sprightly.

Fall Pippin.—Very large, roundish, a little flattened; stalk three-fourths inch, projecting considerably beyond the fruit (which distinguishes it from the Holland Pippin); calyx open, not very large, rather deeply sunk in round, narrow basin; skin smooth, yellowish green, becoming pure yellow; brownish blush and few scattered dots; flesh white, tender, mellow, rich, aromatic.

Alexander (Russian).—Very large, showy, conical, greenish yellow, streaked with red in shade, bright red in the sun; calyx large, in deep basin; stalk slender, long, in deep cavity; flesh yellowish white, crisp, tender, and juicy. Tree vigorous, but not always a good bearer.

Twenty-Ounce; syn. *Cayuga Red Striack* (New York).—Very large, roundish, slightly uneven; greenish yellow, boldly splashed and marbled

* "Downing's Fruit and Fruit Trees of America," John Wiley & Sons, New York.

with purplish red; stalk short, in wide, deep cavity; calyx small; flesh rather coarse, but brisk, sprightly, subacid flavor.

Gloria Mundi.—Very large, roundish, oblate; ribbed; greenish yellow. A popular show apple on account of great size attained in this State. (See table.)

Fameuse; syn. *Snow Apple* (Canada).—Medium size, roundish, somewhat flattened; deep crimson, nearly concealing pale yellowish ground; flesh snowy white, tender, juicy, slight perfume; stalk slender, one-half inch, in narrow, funnel-shaped cavity; calyx small, in shallow, rather narrow basin; "tree vigorous, with dark wood; one of the finest dessert fruits; succeeds particularly well in the foot-hills."—*John Bidwell*.

King of Tompkins County.—Large, globular, angular, inclining to conic; yellowish, mostly shaded with red, striped and splashed with crimson; stalk short and stout, in large, somewhat irregular cavity; calyx small, closed; flesh yellowish, rich, juicy, vinous, aromatic, chiefly grown in mountain regions.

Rambo (Pennsylvania).—Medium to large, flat; yellowish white with pale yellow and red in the sun, with large, rough dots; stalk long, rather slender, curved, deeply set; calyx closed, in broad basin; flesh greenish white. Reported a failure in some counties.

Ben Davis.—Large, roundish, sides often unequal; light red and deep red on yellowish ground; stalk medium, rather slender, in deep, narrow cavity; calyx partially open. Commended as a market apple by the Southern California Nurserymen's Association.

Baldwin (Massachusetts).—Large, roundish, narrowing a little towards the eye; deep bright red over a yellow ground; few russet dots; calyx closed and set in narrow basin; stalk one-half to three-fourths inch, rather slender, set in deep, even cavity; flesh yellowish white, crisp, juicy, subacid. Best in northern and elevated regions; coloring varies greatly according to locality.

Hoover (South Carolina).—Large, roundish, slightly oblique; yellowish, mostly overspread with red, with conspicuous light dots; stalk rather long, in large cavity; calyx open in furrowed basin; flesh yellowish, juicy, crisp, acid.

Rhode Island Greening.—Large, roundish, a little flattened, pretty regular; dark green, becoming yellowish green; calyx small, woolly, closed, in shallow basin; stalk three-fourths inch, curved, thickest at the bottom; flesh yellow, fine grained, tender, crisp, juicy, aromatic, slightly acid; tree healthy and the variety widely popular.

Vandevere; syn. *Newton Spitzenburg*.—Medium size, oblate, slightly conic; fine yellow, washed with light red, striped and splashed with dark red, and shaded with carmine in the sun; light bloom and peculiar gray specks; stalk short, in wide cavity; calyx small, closed; flesh yellow, rich, sprightly, vinous.

Jonathan (New York).—Medium to large, roundish, conical or tapering to the eye; light yellow nearly covered with red stripes and deep red in the sun; stalk three-fourths of an inch, rather slender, in deep, regular cavity; calyx in deep, broad basin; tender, juicy, rich, vinous; a great favorite in California; specially commended as a market apple by Southern California Nurserymen's Association; keeps till midwinter.

Winesap.—Medium size, roundish oblong; dark red with traces of yellow in the shade; stalk nearly an inch, slender, set in an irregular cavity; calyx small, in regular basin; flesh yellow, crisp, high, rich flavor; largely grown; tree a good bearer.

Ortley; syn. *White Bellflower*, etc. (New Jersey).—Large, oblong, greenish yellow, becoming fine yellow with slight blush; stalk medium, slender, set in deep, acute cavity; calyx closed, set it abrupt, corrugated basin; flesh white, fine-grained, juicy, subacid.

Swaar (New York).—Large, roundish; golden yellow with numerous brown specks; stalk slender, three-fourths inch, in very round cavity; calyx small, greenish, set in shallow basin; flesh yellowish, fine-grained; very rich, aromatic flavor and spicy smell.

Lawver.—Large, roundish, oblate, dark red, covered with small dots; stalk medium, cavity deep, regular; calyx small, closed, in medium furrowed basin; flesh white, sprightly, aromatic; a promising, late keeping variety.

Yellow Bellflower (New Jersey).—Very large, oblong, irregular, tapering toward the eye; smooth; lemon color, with blush; stalk long and slender, in deep cavity; calyx closed, in rather narrow basin; flesh tender, juicy, crisp, with sprightly, subacid flavor; keeps well into the winter; tree a strong grower and healthy; one of the universal favorites in California.

Romanite.—Small to medium, roundish conical, truncated; yellow, mostly covered with clear, handsome red; indistinct light dots; stalk slender; calyx in an abrupt basin; flesh yellowish, fine-grained, juicy, pleasant, subacid.

Esopus Spitzenburg (New York).—Large, oblong, tapering roundly to the eye; smooth, nearly covered with rich, lively red, dotted with distinct yellowish russet dots; on shaded side, yellowish ground with streaks and broken stripes of red; stalk rather long, three-fourths inch, slender, projecting beyond the base and inserted in wide cavity; calyx small and closed, in shallow basin; flesh yellow, rather firm, crisp, juicy, with a delicious rich, brisk flavor. A largely grown variety; tree a good, upright grower and healthy; fruit keeps fairly.

Smith's Cider (Pennsylvania).—Large, roundish, oblate conic; yellow, shaded and striped with red, sparsely covered with gray dots; stalk slender, in deep, rather narrow cavity; calyx closed, in broad, shallow basin; flesh whitish, juicy, crisp, acid; tree a strong grower, and fruit keeps till mid-winter.

Rome Beauty (Ohio).—Large, roundish, approaching conic; yellow, shaded and striped with bright red, sprinkled with light dots; stalk one inch, in large, deep cavity; calyx partially closed, in deep, narrow basin; flesh yellowish, juicy, sprightly; fruit keeps late.

Missouri Pippin (Missouri).—Large, roundish oblate, slightly oblique, somewhat flattened at the ends; shaded, striped and splashed with light and dark red, often quite dark in the sun; many large and small gray dots; stalk short, small; cavity large, deep; calyx closed or half open, basin rather abrupt deep, slightly corrugated; flesh whitish, rather coarse, moderately juicy, subacid. Quite largely planted, but losing favor for lack of keeping quality in coast valleys.

Nickajack (North Carolina).—Large, roundish to roundish oblate, slightly conic, sometimes oblique; yellowish, freely striped and splashed with red, many large dots; stalk short, in large cavity; calyx partly open; flesh yellowish, fair quality; reported a shy bearer in high altitudes.

Northern Spy (New York).—Large, roundish, oblate conical; pale yellow, purplish red stripes in the sun; stalk three-fourths inch, slender, in wide, deep cavity; calyx small, closed; flesh white, mild, pleasant; highly esteemed in a few localities, but abandoned in others for shy bearing.

White Winter Pearmain.—Large, roundish oblong conic, somewhat oblique; pale yellow with slight blush, many minute brown dots; stalk short, in deep cavity; calyx nearly closed; flesh yellowish, tender, crisp, juicy, very pleasant subacid, extra high flavor; grown everywhere, and fruit keeps late; tree a strong grower and healthy.

Lady (French).—Small, regularly formed, flat; smooth and glossy, with brilliant red cheek contrasting with lemon yellow ground; flesh white, crisp, juicy and pleasant; chiefly used for ornamental purposes.

Rawles Janet (Virginia).—Medium to large, oblate conic; yellowish, shaded with red and striped with crimson; stalk short and thick, in broad, open cavity; calyx partially open, in shallow basin; flesh yellow, tender, juicy, pleasant vinous flavor; tree healthy and prolific.

Stark.—Large, roundish, inclined to conic; sometimes elongated, sometimes oblique; greenish yellow, nearly covered with dark red and sprinkled with light and brown dots; stalk short, rather stout; calyx closed; flesh yellowish.

Yellow Newtown Pippin.—Large, roundish, oblate and oblique, more or less flattened; yellow with brownish red cheek; stalk very short; flesh firm, crisp, juicy, and with very rich, high flavor. Generally considered the best winter apple in California.

CRAB APPLES.

Hyslop.—Fruit large, growing in clusters; roundish ovate; dark rich red, covered with thick blue bloom; stalk long, slender; calyx closed; flesh yellowish.

Large Red Siberian.—Roundish ovate with large and prominent calyx; pale red and yellow skin.

Large Siberian.—Fruit similar in size to foregoing, roundish oval, flattened at base and crown; light clear yellow, inclining to amber, with warm cheek.

Transcendant.—Medium to large, roundish oval, flattened at the ends, slightly but regularly ribbed; golden yellow, with rich, crimson cheek, or nearly covered with red; delicate white bloom; stalk long and slender, in open, deep cavity; calyx closed; flesh creamy yellow.

Montreal Beauty.—Large, roundish oblate; bright yellow, mostly covered and shaded with red; one of the most beautiful of crabs.

Whitney's Crab.—Large, handsome, greenish yellow, striped with crimson.

CALIFORNIA SEEDLING APPLES.

Skinner's Seedling (Name approved by California State Horticultural Society, November, 1887). Syn. *Skinner's Pippin*, *Santa Clara King*.—Originated with Judge H. C. Skinner, on bank of Coyote, east of San Jose, and tree reported still standing in 1879. Recommended by B. S. Fox at convention of fruit growers held in San Francisco, September 8, 1859, and adopted for trial. Described by Committee of New Fruits, American Pomological Society, 1877 (p. 46), as follows:—

“*Santa Clara King*: Fruit large to very large; form, oblate, conic, slightly mixed; color rich lemon yellow, faintly striped with bright red; flesh, yellowish white, very tender, juicy, sprightly, mild subacid; quality best. Season, September and October. This is the best very large apple we have seen. Said to be a good grower and productive.”

Recommended by Southern California Nurserymen's Association for family use.

Marshall's Red (Name approved by California State Horticultural Society, November, 1887). Syn. *Red Bellflower*, *Marshall's Seedling*.—Originated with J. L. Marshall, Brown's Valley, near Napa, from seeds of Yellow Bellflower, the branches of which interlaced with those of a Red June tree, and the seedling is presumably a chance hybrid between these two varieties. Fruited first about 1877, and generally introduced by Leonard Coates in 1884. The tree resembles Red June in habit of growth; fruit large, same shape as Yellow Bellflower, but of same color as Red June; quality very good; flesh firm and fine-grained; aromatic, and slightly more acid than the Yellow Bellflower; tree, a very heavy bearer, and the fruit ripens in October in the bay region.

Cook's Seating (Name approved by California State Horticultural Society, November, 1887). Syn. *Sonoma Seedling*.—Brought to notice by O. B. Shaw, of Sonoma, who sent specimens to the *Rural Press* in January, 1872. Described in that paper, January 27, as a seedling raised by David Cook from the seed of the Juneating. Above medium size, pale yellow striped with red, sharp acid flavor. Not decidedly rich, but flavor full and acceptable. Excellent keeping qualities. Especially popular in Sonoma and Napa Counties; reported unfavorably from Placer County.

Tabular Showing of Adaptations.—In preparation for this edition the writer undertook special inquiry to secure information from growers as to what their choice would be if they were to plant apples in 1899. Several hundred growers were consulted, and the results of this inquiry are herewith substituted for the tabulation used in earlier editions of this work. Old data were abandoned entirely. The result is a large shrinkage in the list of varieties which are now thought to be worth planting in the different parts of the State:—

An attempt has been made to district the State in accordance with the scheme of climatic divisions described in Chapter I. This groups regions of nearest resemblance, and is more rational than any prescription according to county lines can be, for though some counties lie wholly in one climatic division, many more counties extend through two, and some even through three, such divisions. It is, therefore, a more promising proposition to encourage planters in any locality to study their climatic adaptations, not with regard to county lines but rather as they are related to the conditions of elevation, exposure to ocean influences and other factors which characterize natural belts, or areas, of similar horticultural fitness. The only instances in which these agencies are grouped geographically, is in constituting southern California a division by itself. This is a recognition of the fact that though in southern California coast and interior differences clearly exist, they are not so marked as they are in the upper portions of the State, and there is consequently less marked contrast in suitability to various fruits. This concession to the south as *sui generis* also escapes, or answers instead of a third division of coast valleys, for the southern counties as a whole have a mollified or subdued coast climate, their region of strictly interior valley and foot-hill climate being restricted by the fact that practically almost all their cultivated area lies south and west of their high mountains. It is an interesting fact that the California coast climates north and south show much greater contrasting conditions than do the interior valley regions, north and south, and southern California being so largely in the coast class could on this basis of wide coast variations claim a distinctive designation, though it could hardly be granted on the comparison of interior valley characters throughout the State.

APPLE VARIETIES APPROVED BY CALIFORNIA GROWERS.

VARIETIES.	Northern Coast region.	Central Coast region.	Interior valleys and foot-hills.	Mountain valleys and plateaux.	Southern California.
Alexander.....		X	X		
Arkansas Black.....		X			X
Baldwin.....	X		X	X	
Ben Davis.....	X		X	XX	XX
Bietigheimer.....	X	X	XX		X
Cook's Seedling.....		XX			
Early Harvest.....	X	X	X	X	X
Early Strawberry.....			X		X
Esopus Spitzenburg.....	XX	X	X	XX	X
Fall Pippin.....			X		X
Fameuse.....		X	X		
Gravenstein.....	XX	XX	X	X	X
Hoover.....		X	X		
Jonathan.....	X	X	X	XX	XX
Kaighn's Spitzenburg.....	X	X		X	
Lawver.....	X	X	X	X	X
Maiden's Blush.....		X	X		X
Marshall's Red.....		X			X
Missouri Pippin.....					X
Nickajack.....					X
Northern Spy.....	X	X		X	
Oldenburg Duchess.....	X			X	X
Ortley.....		X	X	X	X
Rambo.....					X
Rawles' Janet.....				X	X
Red Astracan.....	XX	XX	XX	XX	XX
Red June.....	X	X	X	X	X
Rhode Island Greening.....	XX	XX	X	XX	XX
Romanite.....				X	X
Rome Beauty.....	X	X	X		X
Smith's Cider.....	X			X	X
Skinner's Seedling.....		X			X
Stark.....	X		X		X
Swaar.....	X	X	X		
Tompkin's King.....	XX			XX	X
Twenty Ounce.....		X			
Vandevere.....			X		X
Wagener.....	X	X			X
Wealthy.....	X		X	X	
White Astracan.....			X		X
White W. Pearmain.....	X	XX	XX	X	XX
Williams' Favorite.....		X	X		
Winesap.....	X		XX		XX
Yellow Bellflower.....	XX	XX	XX	XX	XX
Yellow N. Pippin.....	XX	XX	XX	XX	XX
Yellow Transparent.....	X			X	
York Imperial.....	X			X	

These remarks are applicable not alone to the apple but to other fruits for which tabulations will be given in subsequent chapters:—

CHAPTER XVII.

THE APRICOT.

California has peculiar adaptations for the growth of the apricot. It has often been pointed out that such adaptations are exceptional, and that nowhere else does the fruit attain such perfection nor possess such commercial importance. Although the apricot has been grown here from the earliest days of the American occupation, and though since the opening of the export trade in canned and dried fruits, the planting of apricot orchards has proceeded with great rapidity, present indications are that our distant patrons are only just beginning to recognize the desirability of the fruit, and that their demands will make it well-nigh impossible for us to extend our production beyond profitable limits.

Though the apricot has some pests and diseases to contend with, they have thus far proved slight evils, and the tree is generally regarded as one of our healthiest and most vigorous, as it certainly is one of our most beautiful orchard trees. It is long-lived and attains great size. On the old Routier place, on the banks of the American River, near Sacramento, are some apricot trees that were set out in the early fifties. They have a height all of fifty feet; the main trunks like forest oaks, and the first branches or limbs twelve and fifteen inches through. The smaller limbs and foliage were at least fifty feet across; a half dozen of them shaded an acre of ground and their average annual crop per tree has reached a ton of choice fruit. On the ranch of F. Hubert, near Burson, in Calaveras County, a seedling apricot tree planted March 10, 1857, has a trunk seven and one-half feet in circumference, and has yielded one thousand five hundred pounds of fruit of good quality in a season. At Haywards, Alameda County, on the orchard of the late Judge Blackwood, are apricots worked on peach stock in 1857, which are still in good bearing. His observation was that the apricot gives longevity to the peach root, for the peach trees of the same age not worked with apricot have disappeared. But forty years of life and vigor is only a part of the career of the apricot in California, if it is fair to judge by the vigor of trees in New Mexico, which were found growing there by the early trappers and frontiersmen, and were, apparently, old trees fifty years ago; and in Europe trees said to be two hundred years old are still bearing,



SKINNER'S PIPPIN, A CALIFORNIA SEEDLING -- See page 197

and trees are said to be at best age for fruit bearing between ten and fifty years. Intelligent treatment of the trees to secure growth of new wood, which will be mentioned presently, seems to give it almost indefinite productiveness.

The apricot is a rapid grower and an early and heavy bearer in California. In the interior and in the southern coast valleys it yields a paying crop during its third summer in the orchard, and from eight to fourteen tons to the acre has been reached for several years in succession, in Judge Blackwood's old orchard of Royal apricots, in Alameda County. The trees, even of some varieties which are uncertain bearers, are large and vigorous growers, and have warranted the suggestion that there is a use for the apricot tree for a windbreak for the protection of other trees. The trees may be planted near together in strong land and make a windbreak that will pay its way without regard to such fruit as it may incidentally produce.

LOCALITIES FOR THE APRICOT.

In speaking of localities for the apricot, reference is, of course, only made to its growth as a standard orchard tree without protection of any kind. It shows even in California that it does not forget the conditions which destroy its thrift elsewhere, for late frosts in our upper coast counties render it, as a rule, unprofitable; and Lake County, just back from the coast, can not be commended for the apricot, except in protected situations. It is also sensitive to too great elevation on the foot-hills of the Sierra Nevada, though it thrives in the lower foot-hills. In the depressions of the great interior valleys the crop is often lost by frost. In the small valleys, apricots usually do better on the hillsides than on the floors of the valleys, because there is less frost at the slight elevations.

It is often claimed that situations directly subject to ocean influences are best for the apricot. It is noted by many observers that the apricot "points its best branches to the ocean, in the very teeth of the constant breeze, and the landward limbs and twigs bend up and endeavor to reach in the same direction. This is patent in every tree, and in the long orchard rows is very striking."* This is taken to signify the special liking of the tree for the vicinity of the coast. It is well enough to interpret it that way, providing one does not lose sight of the perfect success of the apricot in the interior as well. It is true that the fruit near the coast attains higher color, and the less rapid growth of the tree makes it somewhat easier to handle, but the earlier ripening in the interior, coupled with freedom from fog and constant sunshine for drying, are points of the highest industrial import-

* S. R. Thorpe, of San Buena Ventura.

ance. The fact is that the apricot has a very wide range in California, and though the trees have been cut out at some points it has been chiefly because too frosty locations have been chosen or because some other fruit has seemed to be locally more desirable, for one reason or another.

In some valleys in the upper part of the State opening directly to the ocean, there is sometimes complaint of the cracking of the fruit on the sunny side. The alternation of sunshine and fog seems to have something to do with this, for in favorable years, when fogs are few, the fruit is sound.

Locations for early ripening of the apricot are to be chosen with reference to the influence of topography, as laid down in the chapter on that subject. In a general way, it may be said, in regions directly subject to coast influences, both in northern and southern California, the apricot is late. On the west side of the Sacramento Valley, in small, hill-locked valleys, the earliest apricots have been grown for years. Protected situations in the foot-hills of the Sierra Nevada, on the eastern rim of both the Sacramento and San Joaquin Valleys, share in the production of the earliest ripening fruit. There is, probably, about a month's difference in the ripening of the same variety in the earliest interior situations and in the coast valleys of both northern and southern California.

In the interior of southern California, in irrigated situations, on the west side of the so-called Colorado Desert, and in Arizona, apricots rival in earliness the product of the famous valleys of interior northern California.

STOCKS AND SOILS FOR THE APRICOT.

Because of the success with which the apricot can be budded on various stocks, it has a wide range in adaptation to different soils. Budded on the peach root it may be grown successfully on the light, warm, well-drained loams in which the peach delights. The peach root is, in fact, largely used for the apricot. It gives the tree quick growth and early fruiting, and the fact that the gopher does not like the peach root is a consideration with some planters. In growing stock, pits of a strong-growing yellow peach should be secured.

For deep, rich, well-drained, loamy soils, the apricot on its own root makes a magnificent tree. Apricot roots for budding are easily secured. The pits sprout as readily as corn. Sometimes, where cutting and drying are done in the orchard, the ground the next spring will be almost covered with a volunteer crop of seedling apricots. These little plants, taken up and set out in nursery rows in March, are ready for budding in June or July. Large numbers of trees are sometimes secured in this way. In the upper San Joaquin Valley there are situations in

which the apricot seems more productive on its own roots than on the peach, and in the moister parts of the San Fernando and tributary valleys in southern California the apricot root has recently advanced in popularity.

When it is desired to grow the apricot in moister and heavier soils than have been described, or where a light soil is underlaid by a heavy, retentive subsoil, recourse should be had to the plum root. Only a non-suckering plum stock should be used. For this purpose the Myrobalan has been considerably used. Some growers complain that the root has a dwarfing effect on the tree, and object to its use. The manner of securing Myrobalan stocks has been described in the chapter on propagation.

Apricot on Almond.—The almond should as a rule be rejected as a stock for the apricot. Hundreds have tried it, and found that the scion never made a good union with the wood of the stock, but was knit to it only by the bark, and is, therefore, easily broken off by the wind. It may grow well and sometimes gets to be two or three inches in diameter before it breaks off, thus wasting much time for the orchardist. Whole orchards worked in this way have been a loss and disappointment.

A few growers, however, approve the almond and use it with the idea that it gives larger fruit. J. J. Shaner, of Los Gatos, advocates the almond stock for the Royal apricot in dry soils. He proceeds, however, by root grafting, instead of budding, using the side graft. He cuts off the top of the stock about four to six inches above ground, scrapes away the dirt, bends the stock, and, with a sharp, thin knife, cuts into the root to the center, making the cut perpendicular, so that the graft will be that way when inserted. The scion should be made wedge-shaped. After insertion, draw the loose earth around it, and the work is done until the graft has made a growth of eighteen to twenty-four inches. This is given as a record of experience, but still caution is urged against the use of the almond as stock for the apricot.

In addition to the specifications of certain stocks for different soils, it may be remarked, in a general way, that the apricot seems to thrive better on a tolerably heavy soil, with enough sand to make it work easily, than on a very light soil. It does well on soil rather too heavy for the peach. It also enjoys moisture better and gives signs of distress unless its roots are fairly supplied all during the season, but it dislikes standing water and should not be planted on undrained situations.

EXPOSURES FOR THE APRICOT.

The apricot blooms early; it follows the lead of the almond. Thus it runs greater risk than other fruits of frost injuries dur-

ing blooming. And in the parts of the State most subject to frost, exposures should be selected in accordance with the principles laid down in Chapter I, which treats of topography as related to fruit growing.

In securing the advantage of the earliest ripening even in the earliest districts, elevation is of great importance. The first apricots of the season for a number of years have come from an elevated ridge, rising in the center of Pleasant's Valley, in Solano County. This ridge has higher hills but a short distance away on both east and west, which protect it from cold winds, and on all sides there is low ground, to which cold air can freely descend. In this spot apricots and other fruits ripen several days earlier than on other lands but little removed.

PLANTING THE APRICOT.

The apricot becomes a large tree in California, as has already been remarked, and it should be given plenty of room. Twenty-four feet each way is certainly a minimum distance for so large and long-lived a tree, and some orchards have been planted at thirty feet. If nearer planting is done it should be with reference to subsequent removal of part of the trees. Twenty feet apart, with later removal of half the trees to double the distance, or such an arrangement as proposed by H. D. Briggs, of Azusa, should be adopted:—

In setting out an orchard it seems advisable to double set the ground, as an apricot twelve to fifteen years old should have not less than 800 to 900 square feet of ground. This can easily be obtained by setting 20x20 feet; then when nine or ten years old remove every other tree, making them forty feet in the row, with rows twenty feet apart, of course taking them out diagonally. The trees will very quickly tell the orchardist when they are too thick. When the outside rows have twice the fruit of those inside, it is quite evident that the time spent in pruning, etc., on half the trees is worse than wasted. I have cut roots 40 feet from a nine-year-old tree.

The apricot makes such rapid growth and so much depends upon giving it proper form, as will be seen presently, that one year's growth is all that should be allowed in the nursery. Some growers would rather have a dormant bud than a two-year-old tree, and cases have been reported of trees from dormant buds outgrowing yearling trees planted at the same time in the same orchard. But in growing from a dormant bud in the orchard care should be taken to develop a short trunk, with properly-spaced branches, by pinching the side shoots near the ground. Trees started from dormant bud and allowed to branch from the ground, have developed very unsatisfactory form, and have, in some situations, lost their lower branches by the wind. The tree should have a low head, but a short trunk seems to give a better tree, and more elasticity to the branches.

PRUNING THE APRICOT.

Of all California orchard trees, the apricot seems most in need of the constant attention of the orchardist to give it proper shape and strength. It is a rampant grower, and in its zealous haste for size and fruitage it overreaches itself and becomes the prey of specific gravity and wind force. Thousands of trees have been ruined by literally breaking to pieces with the weight of their fruit, and being torn by winds of only ordinary velocity. Thousands more have been rescued from such a fate by bolting the branches to each other. This excessive growth and consequent weakness of the apricot is greater in some parts of the State than in others, because of the difference in degree of forcing conditions, but everywhere the apricot needs watchfulness and timely aid in building up its strength. The general principles to be observed in securing branches strongly attached to a short trunk have already been discussed at length in the chapter on pruning.

There has been a very marked change during the last few years of the pruning of the apricot. Summer pruning, immediately after the fruit is picked, has become much more general, and winter pruning has proportionally decreased. The new practise is certainly more rational than the old. Young trees are winter pruned to promote low branching and short, stout limbs; bearing trees are summer pruned to promote fruit bearing and check wood growth—the excess of bearing shoots being removed by thinning during the winter.

The apricot tree bears upon old spurs, like the plum; also upon the new wood, like the peach. This fact has to be borne in mind when winter thinning of the new growth is undertaken.

A very clear record of procedure by which J. B. Neff, of Anaheim, Orange County, has built up one of the best apricot orchards in the State is as follows:—

Pruning the apricot requires some skill and considerable judgment, which can only be formed by experience and observation of the habits of the tree. Trees of four to five feet in height are preferable for planting, and when planted should be trimmed to a single stem and cut off at eighteen inches from the ground. These will throw out shoots vigorously and frequently two or three shoots from one bud. These shoots should be thinned out, leaving not more than four or five, no two of which should come from one bud, nor be directly opposite. The first shoot should start twelve inches from the ground, the others in such a manner as to divide the space and make the branches balance, leaving the top shoot to form the central part of the tree.

It will be necessary to go over the trees several times the first year to remove shoots that may start where not wanted, but no general heading back should be done, as it tends to dwarf the tree; though if some of the limbs are making an overgrowth they should be pinched back to keep the head balanced.

The pruning of the second year should be done in January, as the tree will not be dormant until then, if it has been kept in a thrifty condition. The first year's growth should be cut back to within five to ten inches of the body of the tree, and all forks should be cut out, even if it necessitates forming a new head, as it is much better to lose some growth on a young tree than to take the risk of splitting down when the tree begins to bear fruit.

When the shoots start for the second year's growth, take off all that come on the under side of the limbs and thin to one, two, or three, as may be needed to balance the tree, bearing in mind that an apricot tree always inclines toward the coast breezes in this locality.

The second year will require much more attention than the first year, in order to keep off suckers and all lateral growth that may start on the under side of the new limbs, the object being to make the limbs grow as nearly upright as possible. The remark on heading back holds good for the second year also.

The trees will become dormant earlier the second year than they did the first, but should not be trimmed earlier than December, and a month later is preferable, as the ends of the limbs are not exposed to the drying winds so long before the sap begins to flow, and consequently will heal over better. The second year's growth should now be cut back to within fifteen to twenty inches of the old wood, except the central stem, which may be left twenty-four to thirty inches long, depending on the number of laterals it may have thrown out. When the new shoots start they should again be thinned down to two or three on each limb, and all taken off that tend to turn down or out at right angles, but do not take off the fruit spurs.

The trees will need to be gone over about three times before July to remove suckers and lateral growth that may start on the lower side of the limbs, as the tendency in the third year is to make an immense growth of downward laterals, and these must be taken off so as to develop wood that is to be left for fruit. If the orchard is on good land and has been properly irrigated and cultivated, the trees should now be large enough to begin to yield fruit. The object in trimming during the first two years and the first half of the third year has been to grow a vigorous upright tree, with strong limbs, capable of carrying a heavy load of large fruit, and to get the fruit as close to the body of the tree as possible.

There will be a few specimens of the fruit the third year, and as soon as these are gathered the trees should be summer pruned for the first time, care being taken that the land shall have been allowed to become moderately dry so that the trees may be partially dormant. If the downward growth of the laterals has been kept cut off, all that remains to be done is to cut off about one-half of all this season's growth all over the tree, using the same judgment as before with reference to prevailing winds and symmetry of tree. If this is properly done and water at once turned on the orchard, a new growth will be made and the fruit buds for next year fully developed.

The only pruning necessary in the following winter will be to take out any cross limbs and sprouts that may have been overlooked in the summer.

After the trees begin to produce regular crops they will not grow so vigorously, and the numerous prunings of the first three years will not be necessary, as almost all can be done by summer pruning until the trees get so old that they need the old wood taken out. This can be more readily done without damage to the trees where from 24 to 30 limbs are grown, than in the old method of leaving only eight or ten large limbs.

When it becomes necessary to take out old wood—as the best fruit grows on new wood—a few limbs can be taken out each year until a full top of new wood is again made.

Winter Pruning.—The evident defect of many old apricot orchards is the failure of the low-bearing wood and the thicket

of brush near the ends of long bare limbs. Such trees need renewal of the top by vigorous winter pruning, which should



Old Apricot Trees at Pomona Renewed by Pruning.

preferably be done toward the close of the dormant season rather than early in the winter as formerly. Old and unprofitable trees have been reclaimed in this way.

Winter pruning is still the regular method in some parts of the State where the conditions do not favor excessive growth of the tree and where summer pruning does not seem to be called for. The practise is to remove half or two-thirds of the new growth and thin out, by removing entirely enough new and old wood to prevent the tree from becoming thick and brushy.

THINNING THE APRICOT.

All free-fruiting varieties of the apricot must be thinned to secure size acceptable to purchasers. It is the experience of the oldest growers that though thinning is an expensive operation, it is very profitable. When half the fruit is taken off in thinning, the remainder reaches as large aggregate weight as though the whole were allowed to mature, and the thinned fruit is worth about twice as much per pound. Even if less weight is secured, and in most cases the purpose should be to get less weight, the tree is spared the exhaustion of overbearing and the owner

escapes a year of little or no fruit. A discussion of this subject is given in a previous chapter.

IRRIGATION OF THE APRICOT.

Whether the apricot shall be irrigated or not is answered in the chapter on irrigation. In many locations, with proper pruning, thinning and cultivation, perfectly satisfactory fruit can be grown with the usual rainfall. In others a single winter irrigation will satisfy all the needs of the tree: in others a single irrigation just after fruit picking and summer pruning will carry the tree through. It is a fact, however, that as the trees advance in age some supplement to the average rainfall is often desirable and in dry years irrigation is the saving of two crops. Some idea of the amount of water used can be had from the chapter on irrigation. The following account by Mr. Neff applies to his practise in Orange County, which is an average situation as to rainfall and atmospheric humidity, and is as good a general statement as could be made:—

If rains are copious, winter irrigation may be dispensed with during the first two or three years after planting the orchard, but when the trees reach the age for bearing fruit the rain water should be supplanted by irrigation water until the soil is thoroughly wet 5 feet deep, and in order to have this, at least 20 inches of water, including rainfall, must be put on the land. Three irrigations should be given the trees during the first summer, but it is not necessary to wet more than a strip 5 or 6 feet wide along the tree rows. The orchard should have three irrigations during the second summer and a strip 12 feet wide should be watered, as the roots are reaching farther and the trees require a greater amount of water. The irrigation for the first two years should always be done before the trees show any want of water, so as to keep them growing vigorously.

All the space between the trees should be watered the third year and afterward; but two irrigations will be sufficient for the summer. The best time for the summer irrigation of bearing apricot trees is when the fruit is about half grown, which is usually about the second or third week in May.

If well watered at this time the fruit grows to its largest, and has time to ripen slowly as the ground gradually dries, until it has all the sugar which will go into the fruit. An orchard in full bearing that has been well watered in the winter should now have as much as full 100 inches of water for two hours on each acre (equal to four acre-inches).

The second irrigation should be given as soon as possible after the summer pruning is done, in order to give the trees growing and develop the fruit buds for the next year. This will not require quite so much water as the irrigation in May, but ought to be as much as 100 inches of water for one hour on each acre.

DISEASES OF THE APRICOT.

Though the apricot tree, as has been said, is regarded as one of the healthiest fruit trees, it is subject to some maladies. Trees perish from being set in unsuitable situations, and in these cases, if the evil be stagnant water in the soil, or penetration to

alkaline subsoil, the root shows it. Sometimes, however, a branch or a whole tree withers and dies without apparent cause early in the summer, and while the root is still sound. The disease is evidently acute, but its cause is not known, nor a remedy proposed. It is an old trouble of the apricot, and not peculiar to California.

The so-called "gum disease" sometimes causes injury to trees. The best treatment is to cut away the diseased part down to healthy wood and cover the wound with common lead and oil paint, put on sparingly so as not to flow over healthy bark.

Some years certain varieties in particular are blackened at the pit and rendered unsalable, but the trouble has not thus far proved serious generally, except with certain varieties which have generally gone out of use for that reason.

The worst injury to tree and fruit is done by what is called the "shot-hole fungus" (*Phyllosticta circumscissa*), from its perforations of the leaves as though by a charge from a shot-gun. It makes ugly scars on the fruit, which render it unsalable. The same disease also affects the leaves of cherries and plums. Thorough use of the Bordeaux mixture described in a later chapter will prevent this trouble.

A disease which is prevalent in some districts of southern California is called "black heart;" a pit disease which sometimes does great injury. No treatment except that of pruning back to healthy wood has thus far been proposed. Root knot is also a serious trouble of the apricot, as of several other trees. It will be considered in the chapter devoted to diseases of fruit trees.

Until recently the apricot has been generally free from scale insects, and it is not affected by those species which are worst on some other fruit trees, but recently it has been seriously infested in some places with black and brown scales, which will be considered in a later chapter.

The ripe apricot is sometimes seriously assailed by the *diabrotica*, a small green beetle, with twelve black spots upon its wing covers. Driving the insects away with smoke smudges has been used to some extent. Fortunately, the insect only occasionally occurs in large numbers.

VARIETIES OF THE APRICOT.

Though nearly all standard varieties of the apricot have been introduced and planted in this State, comparatively few are found on the lists of the orchard planters. Many local seedlings have been brought to notice and propagated to some extent but are less used now than ten years ago, and the disposition is to restrict planting to a few old varieties. There is, however, still a need of new varieties combining size, quality and

regular bearing. As with most other fruits, some varieties are found to succeed wherever conditions favor the fruit at all; other varieties succeed in some regions and not in others. Our table of varieties for the different counties shows this fact, and an attempt will be made to make the showing more explicit by notes in connection with the mention of each variety.

APRICOT VARIETIES APPROVED BY CALIFORNIA GROWERS.

VARIETY.	Central Coast valleys.	Interior valley and foot-hills.	Southern California.
Blenheim	XX	XX	XX
Early Golden		X	XX
Early Moorpark.....			XX
Hemskirke.....	XX	XX	XX
Large Early.....			XX
Large Early Montgamet.....	X	X	
Luizet.....		X	
Moorpark.....	XX	X	X
Newcastle.....	XX	XX	XX
Oullin's Early	X		
Peach.....		XX	X
Royal.....	XX	XX	XX
Routier's Peach.....		XX	
Sparks' Mammoth.....			X
St. Ambroise.....		X	

In the following statement the arrangement is approximately in the order of ripening, and the descriptions are from Downing, with additions and changes to meet local observation:—

VARIETIES OF FOREIGN ORIGIN.

Large Early.—A French variety; fruit of medium size, rather oblong and compressed; suture deep, skin slightly downy; pale orange in the shade, fine bright orange with a few ruddy spots in the sun; flesh separating readily from the stone, orange colored, rich and juicy; kernel bitter. This variety is especially popular in the southern coast counties, but in most situations has proved an uncertain bearer. Ripens before Royal.

Early Golden.—Origin unknown; small, roundish oval, with suture well marked and extending half way around; skin smooth, pale orange; flesh yellow, moderately juicy and sweet, with very good flavor; separates from the stone. This variety is reported favorably from some counties, but generally otherwise, and is not largely grown. Ripens before Royal.

Royal.—A French variety, and at the present time the leading California apricot. Of large size (when well thinned out), free stone, fine color and flavor, good bearer, and fruit ripens evenly, when well grown; a favorite with the canners and an excellent variety for drying. Fruit roundish, large, oval, slightly compressed; skin dull yellow with orange cheek, very faintly tinged with red, and a shallow suture; flesh pale orange, firm and juicy, with a rich vinous flavor.

There is a variety somewhat grown in Sacramento and Solano Counties, sometimes called "White Royal," which is not liked by canners, because of its lack of color and flavor.

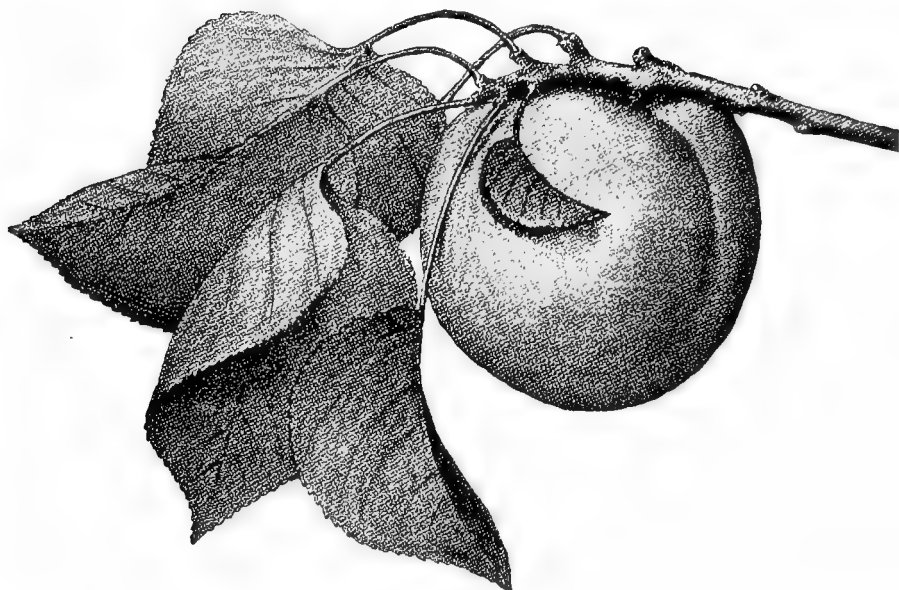

Blenheim Apricot, Grown in University Orchard.

Large Early Montgamet.—Large, orange yellow, reddish on sunny side, firm.

Oullin's Early.—Early form of Peach apricot, large size, delicious flavor. Ripens in Amador County four weeks earlier than Peach.

Luizet.—Large, oval, distinct suture, one side higher than the other; orange with crimson cheek; flesh deep yellow, firm, rich. Especially approved in the upper San Joaquin.

Blenheim or Shipley.—This is a valuable variety in this State and seems to surpass Downing's description both in vigor of tree and size of fruit. John Rock modifies Downing's description to suit California experience with this variety, as follows: "A very good variety, above medium, oval; orange, with a deep yellow, juicy, and tolerably rich flesh; vigorous grower and regular, prolific bearer." This agrees perfectly with the behavior of the variety in the University orchard at Berkeley, where it is the best of twenty varieties. It is not reported so constant a bearer in some other parts of the State. Fruit runs a little larger than the Royal, and is usually better distributed on the tree, but it must be well thinned. This variety has been approved by canners. Ripens a little later than the Royal.

Early Moorpark.—Very popular in southern California, where its identity has been long in dispute, and is not yet fully determined. The Early Moorpark of Thomas Hogg is as follows: Roundish, inclining to oval, with very deep suture on one side, extending from base to apex. Skin yellow, mottled, and dotted with crimson on the exposed side. Flesh in all respects resembling Moorpark. Stone oblong, with a covered channel along the back, which is pervious. Kernel bitter. Ripens three weeks earlier than Moorpark.

St. Ambrose.—Large, early, compressed, deep yellow, reddish on sunny side. Juicy, rich, and sugary, with firm flesh when grown in the interior; apt to be coarse and to lack flavor near the coast. Condemned by

canners for not processing well, and by dryers for loss of weight and for white color around the pit. It has served well as a shipping variety.

Bergetti.—An undetermined variety introduced by Mr. Bergetti and widely distributed under his name in the San Joaquin. Closer comparison may prove it to be St. Ambrose.

Hemskirke.—A fine English variety quite widely grown in California; ripens later than Royal, described by Downing as follows: "Fruit large, roundish, but considerably compressed or flattened on its sides; skin orange, with red cheek; flesh bright orange, tender, rather more juicy and sprightly than the Moorpark, with rich, luscious, plum-like flavor; stone not perforate, rather small, and kernel bitter." Esteemed in California because the tree is more hardy and a more regular bearer than the Moorpark, and the fruit ripens evenly on both sides.

Peach.—A variety from Piedmont of the largest size, about two inches in diameter, roundish, rather flattened, and somewhat compressed on its sides, with a well-marked suture; skin yellow in the shade, but deep orange mottled with brown on the sunny side; flesh of a fine yellow, saffron color, juicy, rich, and high flavored; stone can be penetrated like Moorpark and has bitter kernel. This is a very successful sort in the warmer parts of the State especially, and is a favorite in the Sacramento Valley. It ripens just ahead of the Moorpark.

Moorpark.—A standard of excellence and an old variety which originated in England. Fruit large, roundish, about two inches and a quarter in diameter each way; rather larger on one side of the suture than on the other; skin orange in the shade, but deep orange or brownish red in the sun, marked with numerous dark specks and dots; flesh quite firm, bright orange, parting free from the stone, quite juicy, with a rich and luscious flavor; stone peculiarly perforated along the back, where a pin may be pushed through; kernel bitter. In California the Moorpark reaches grand size, but has the fault of ripening unevenly in most localities. The tree is tender and bears irregularly, which leads to its rejection by most planters, though some growers cling to it because of its size and quality and occasional grand crops. The San Jose districts lead in the production of this variety, and in some parts of the Santa Clara Valley the Moorpark seems to ripen uniformly. The same behavior is reported from localities in the upper San Joaquin Valley, where it also seems to be a more regular bearer. The variety is almost wholly rejected in southern California.

VARIETIES OF CALIFORNIA ORIGIN.

Newcastle.—Originated with C. M. Silva & Son, of Newcastle, Placer County, in 1881; size full medium, round; rich golden yellow, with brilliant red cheek in the sun; freestone; flavor sweet and rich; not quite as large as the Royal, nor quite as rich in flavor, but prettier, being more highly colored—the coloring being nearly equal on all sides, except that it is rather darker on the side to the sun. The tree is an early, regular and good bearer, a medium grower, being rather more upright in its habit than the Royal. Its time of ripening is seventeen days earlier than the Early Golden and twenty-five days earlier than the Royal—the three varieties being in the same orchard within a few yards of each other, and treated in the same way as to culture.

Routier's Peach.—Originated with Hon. Joseph Routier, near Sacramento. Large, yellow in shade; deep orange, mottled or splashed with red in the sun; flesh juicy and rich, high flavor and a good market variety. Blooms a week later than peach. Very popular in Sacramento and San Joaquin Valleys.

Sparks' Mammoth.—Popular in Ventura County. Largest size, even larger than Moorpark, pale yellow, very tender, juicy and sweet. Recently quite widely distributed in southern California, but its bearing habit is in question.

THE NEWCASTLE APRICOT - A CALIFORNIA SEEDLING.

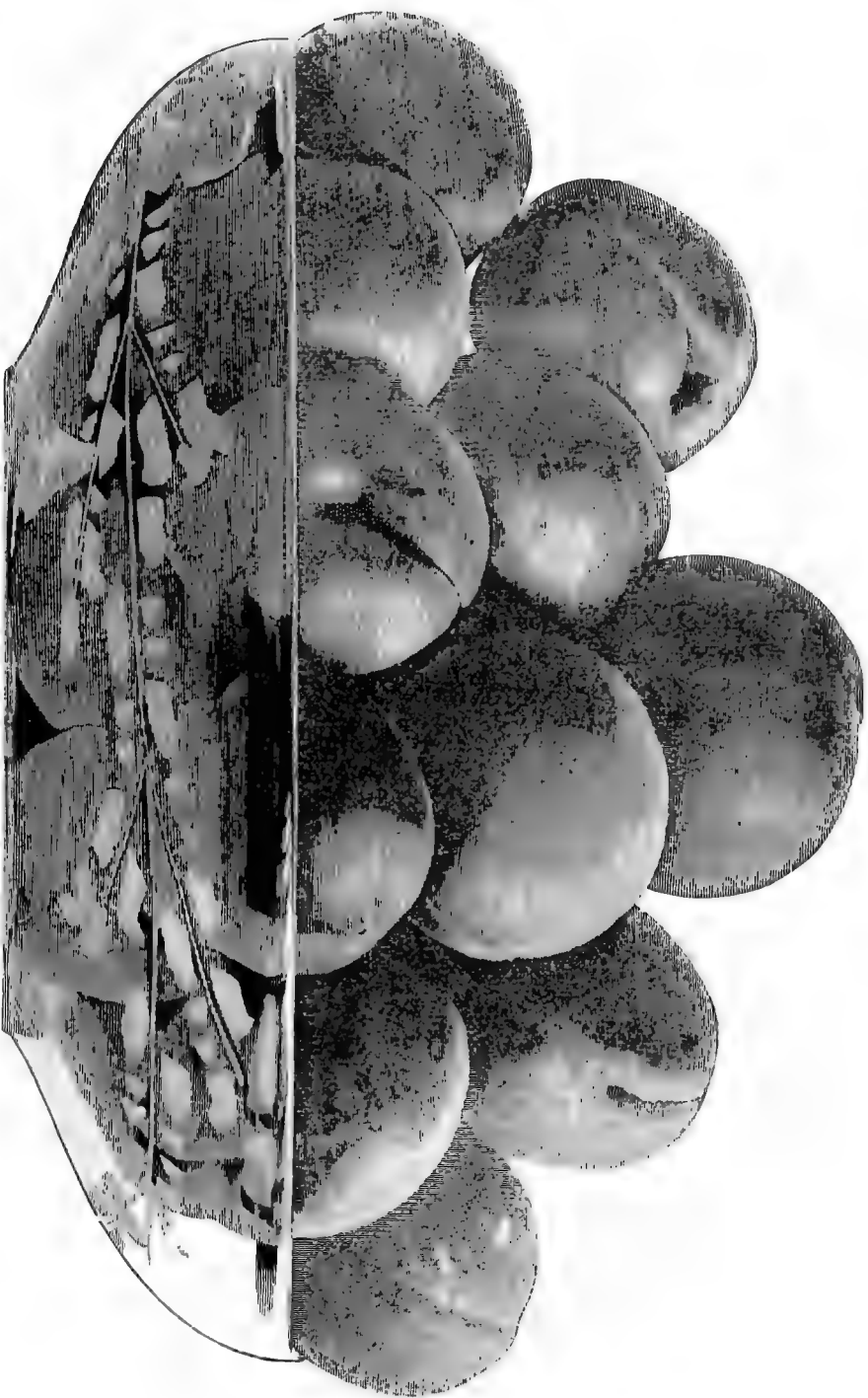

CHAPTER XVIII.

THE CHERRY.

Although the amount of cherries grown in this State is small as compared with the aggregate weights of some other fruits, the cherry, from the growth of the tree and the size and quality of the product, is entitled to rank as one of the grand fruits of California. The size of the California-grown cherry is a matter of pride with residents, and a marvel to visitors. It is related that one of the most distinguished Eastern pomologists, who was taken to an Alameda County cherry orchard during picking-time, could not recognize the varieties, though he had himself propagated and shipped to California the very trees which were bearing the fruit, the size of which so far surpassed all his mental standards. And quality is commensurate with size. Whatever disagreement there may be concerning the flavors of our other fruits as compared with Eastern, the richness and excellence of the California cherry have never been impeached. Recently the shipment of cherries to eastern markets and the extension of the canning interest have considerably enlarged the opportunity for profitable growth of the fruit.

Famous Old Trees.—The longevity and productiveness of the cherry tree in this State is naturally of interest. Cherries were planted in some of the earliest settled parts of the State and are still in full vigor. One of the most famous trees is a Black Tartarian, which was brought from France by Dr. L. E. Miller, and planted by him in 1854, on land now owned by Robert Hector, in Placer County, just below Rattlesnake Bar, on the American River, about eight hundred feet above sea level. It is described as seventy feet in height, the branches covering a space between seventy and seventy-five feet in diameter. The trunk branches about six feet above the ground, and at that point has a girth of over ten feet. A close record of its crop has been kept, as follows: 1886, two hundred boxes, of ten pounds each; 1887, one hundred and eighty; 1888, three hundred; 1889, two hundred and twenty; and 1890, three hundred boxes. Since that date this yield has not been exceeded. The trees are too large to be profitable, for the fruit has to be picked with the aid of extension ladders securely guyed, by men slung

in swings from such ladders or the forks of the trees. Mr. Hector has about fifty of these large trees. Other large trees are to be seen near Woodside, San Mateo County, and near Oroville and Chico in Butte County, some of which have borne a ton of fruit in favorable seasons.

LOCALITIES FOR THE CHERRY.

There has been an idea that the area adapted to the growth of the cherry is quite limited. The great valley was generally condemned, though at some points the trees were very productive, and at other points grew well but did not bear. Southern California, both on the coast and in the interior, was announced as unsuited for the cherry. Later experience is recording successful growth and fruitage of the tree in many places where it has long been regarded a failure, and it now seems likely that early disappointment resulted chiefly from lack of attention to the soil and moisture conditions which best suit the tree.

How far atmospheric conditions which are beyond control influence the growth and fruitage of the cherry, can not yet be fully determined, but ample trial seems to demonstrate the unsatisfactory character of the tree, manifested in small fruit and sun-burned foliage, on the plains of the interior valleys, although the soil is kept moist enough. There is, however, still the hope of securing varieties of the fruit which have been developed under conditions similar to those prevailing in the interior of California. Professor J. L. Budd believes that the Russian cherries, which are largely grown in a region subject to high summer heat and dry air, will succeed in parts of California where the varieties originating in west Europe fail.

SOILS FOR THE CHERRY.

The cherry thrives in free, deep soil, in which water does not stand within about fifteen feet from the surface. It delights in deep deposits from old water courses, and does not dislike a moderate amount of sand. A loam underlaid by a sandy subsoil is acceptable, but a loam underlaid by clay has shown its unfitness by the early failure of the trees, while those on deep loam near by have remained vigorous and profitable. On the foot-hills it thrives in the light, mellow soil and fails in the tight clay either in soil or subsoil, as it does in the adobe of lower lands; and yet a clay loam of no great depth upon a clay subsoil may grow good trees if the clay be so disposed that surplus water from winter rains can escape and water is at hand to guard against summer drouth. But this is merely a suggestion for garden growth of the cherry. Commercial orchards should have a good depth of sufficiently retentive soil. The great

cherry trees of Mr. Hector, in Placer County, which we have mentioned, are growing right on the bank of the American River, where the soil is a pure, sandy loam, in some places over sixty feet deep, as proved by an old shaft once dug near the center of the orchard.

But though the cherry dislikes a wet soil, it is particular about its water supply and insists upon enough, its requirements being greater than some other trees. During the dry years 1898 and 1899, trees came into distress where they had never suffered before, and many large, valuable trees died. The only new condition they encountered was lack of soil moisture. It thus appears that while the cherry is undoubtedly injured by excess of water in the soil, it is still very exacting in its requirement of an adequate supply. If this can not be retained in the soil by cultivation, irrigation must be resorted to. Thus the cherry growers in the famous Willows district, of San Jose, usually find it an advantage to give their trees an irrigation between the spring rains and the ripening of the fruit, and another irrigation after the fruit is gathered.

These facts show that the cherry must have enough water or it will not succeed. On the other hand, there must not be excessive moisture in the soil either from irrigation or by moisture. Cherry trees in southern California, planted with orange trees and given similar irrigation, have failed utterly. Planting on naturally moist land in low places has also failed, and observed facts some time ago led to the conclusion that at the south the cherry should be planted on well-drained land, which could be irrigated (as the behavior of the tree indicated its need of water), rather than on naturally moist land, because of the likelihood of excessive moisture in such situations. More recent experience has declared mellow, well-drained soils of the higher lands well adapted to the cherry, and on such soils, when well cultivated, cherries have done well without irrigation at Pasadena, Pomona and elsewhere. The commercial cherry product of southern California comes, however, from mountain valleys and high plateaux—the chief regions being the Yucaipe Valley above Redlands and the Mesa Grande region in the interior of San Diego County.

In California, as elsewhere, the Dukes and Morellos may succeed where the Hearts and Bigarreux fail. The May Duke seems especially hardy, and bears well in Nevada, where other sorts fail utterly.

Late Fruiting of Cherry Trees.—Though the cherry in favorable situations bears early, the grower, especially on strong, rich lands, will often have many years of disappointment from falling blossoms and fruit. During this time the trees will be making marvelous wood growth, and this apparently sup-

presses the fruiting function. Usually these trees will ultimately bear when their exuberant growth declines. They can be thrown into fruit sooner by root pruning, digging a trench around about eight feet from the tree, and severing the roots thus encountered, or by summer pruning of twig ends. Because of this overgrowth, growers give such soil to the apple or the pear rather than the cherry. Sometimes the non-bearing of the cherry is inexplicable. Though everything seems to be right, and the blooms are profuse, the fruit will not stick. Some think it is due to lack of association of different varieties and cross fertilization. It is held at Vacaville that keeping bees in the vicinity of cherry orchards has increased the bearing.

EXPOSURES FOR THE CHERRY.

Exposures for the cherry are chosen both with reference to protection from frost injury and to early ripening of the fruit. The cherry blooms early; it is almost as venturesome as the almond. In protected situations, guarded from cold northerly winds, and open to sunshine on the south and southeast, the fruit advances to maturity very rapidly. In Vaca Valley about a month of good weather after the blossoming will ripen an early cherry. The pioneer cherry growers of Vaca Valley went there from their old homes in Napa Valley, because they could gather and market cherries in their new locations before the same varieties were ripe in Napa. They chose places protected on the north and west by steep hills. The two things to secure are, apparently, protection from the sweep of cold winds and elevation above the deposit of cold air, which occurs in depressed places.

In localities where fruit ripens late, as near the coast, there is no need to seek forcing conditions, for the extra early varieties should not be planted except for family use. Early varieties are comparatively poor in quality, and will not sell profitably, as they will reach the market alongside of better later sorts from earlier districts. The place for the cherry in the later districts is on the most proper soil, according to the requirements which have been laid down, avoiding, however, so far as possible, wind-swept spots, and seeking amelioration of direct ocean influences by elevation or intervention of hills and windbreaks.

PROPAGATION AND PLANTING THE CHERRY.

In the chapter on propagation is given a successful method of growing cherry seedlings. California cherry trees are almost exclusively propagated by budding on seedlings of the Black Mazzard.

The planting of the cherry is covered by the general considerations already given for the planting of orchards. The

distance which cherries should be set apart is a disputed point among planters. Mr. Hector, drawing the suggestion from his mammoth trees, would plant them eighty feet apart on such soil as his, and thinks forty feet near enough on any good soil. This is the extreme of all distances which have been named, and looks to the needs of the trees a generation ahead. This is farther in the future than most growers care to calculate, and would prefer to let the coming generation cut out some of the trees if necessary. Still trees should not be set too close. When planted twenty feet apart the trees have interlaced their branches when sixteen years old, and the spaces between the rows have been covered in like colonnades. In the Haywards region the branches of twelve-year-old trees set twenty-eight feet apart have nearly reached each other, though continually cut back. Much depends in the matter of distance upon the manner of handling the trees. The trees can be grown much nearer together by continuous pruning than where the usual way of cutting back for the first few years and letting the tree take its natural growth after that, is followed. James E. Gedney, of Mesa Grande, San Diego County, practises close planting and cutting back. He says:—

I plant my trees twenty feet apart each way. My method is to plant thus closely and then keep my trees low, by cutting back every year; this facilitates gathering the fruit very much. I prefer this way to setting the trees farther apart and allowing them to attain too great a height. By the former method I secure fully as good, if not better, results per acre, to say nothing of the difference in gathering the fruit. Another advantage in keeping the trees headed low is that the wind does not affect them nearly as much as it does tall trees.

Thus it appears that one may fix his distance in planting according to the method of pruning he proposes to follow, remembering, however, that the cherry is naturally a large tree, and most old orchards are now overcrowded.

As with other trees, orchard planters prefer trees with one year's growth on the bud in the nursery, because they usually get, then, a straight switch with well-developed buds all the way down, and the head can be formed as desired. For garden planting, older trees, properly pruned in the nursery, can be used to advantage.

PRUNING THE CHERRY.

All our best growers agree in the advantage of a low head for the cherry, and all aim to have the trunks from the ground up to the limbs literally covered all around with leaves, which completely shelter the bark from the rays of the sun. In planting, therefore, the side buds are carefully preserved—not to be grown into branches, but to be cut or pinched back when they have come out a few inches, leaving just growth enough to clothe

the tree with a covering of its own foliage. This was early insisted on by the late Mr. Geiger, of San Jose, and as we have mentioned it, we will proceed first to describe his method of growing the cherry tree, as shown by the following illustration.

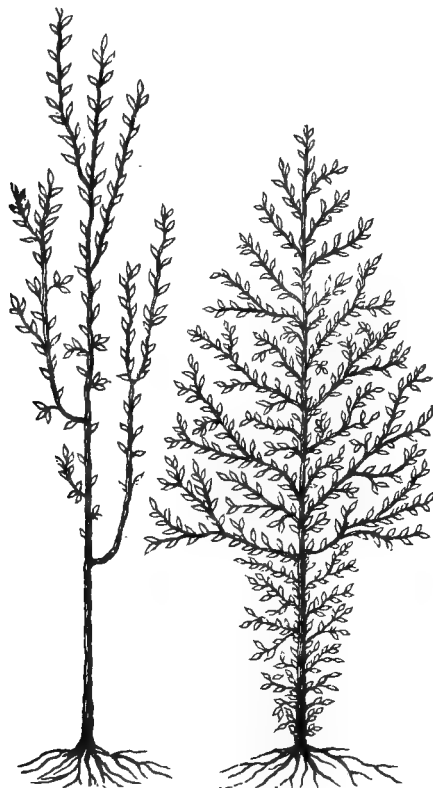

Natural and Trained Growth of Young Cherry Tree.

The first figure shows the way unpruned young trees usually grow in this State, shooting upward quickly and exposing their stems to sunburn and borers. The second figure shows Mr. Geiger's method of developing spurs from the ground up to the head. These spurs not only furnish leaves to shade the trunk, but soon become fruit spurs and bear well. But this figure also shows Mr. Geiger's way of shaping the upper part of his tree by carrying up a leader with a regular system of side branches. He heads back at planting to two feet, pinching off the shoots below the head as stated, and allowing the shoots which form the head to grow larger, but they too are all pinched

except the leader, which is allowed to grow as long as it pleases during the summer. About February or March, for Mr. Geiger does not believe in pruning the cherry until the buds begin to burst in the spring, he cuts back the leader to about twelve or sixteen inches from its starting-point and cuts back the side branches to about six or eight inches. This is done year after year, cutting back and thinning out the side shoots, pinching the laterals, and allowing the leader to grow, never interfering with it until the spring pruning, and always letting it predominate over the side shoots. By cutting short, wood is increased, but at the end of six years the tree goes into fruit very rapidly. As the tree increases in fruit, it decreases in wood, and by the time it is ten or twelve years old there will be but little cutting to do, except to shorten in and thin out, and this requires some judgment and experience, to know where to cut, how to cut, and when to cut. To shorten in, never cut down to an old fruit spur. It is very difficult to get healthy wood out of such; but whenever you can find last year's wood, there you can cut with safety anything that is less than one inch in diameter.

This system of pruning must be accompanied by constant pinching during the summer-time. It should commence when the lower shoots are about six inches long, and be followed up closely all through the growing season. Those on the trunk should never get longer than eight or ten inches, under any circumstances. After these are pinched, let the trees rest ten or fifteen days, or until the branches in the top get a good start. Then pinch everything clean but the leader, in every main branch in the tree. The leader takes its own way all through the growing season, to prevent the effects of over-pinching or checking growth. If only the side shoots are kept back, the leader or head of the branches receives the current or flow of sap and maintains and carries on life and vitality in the tree. One object in pinching or spur pruning is to keep back surplus wood and create fruit spurs, throwing all the little twigs and branches into fruit, thereby utilizing all the wood the tree can produce, not allowing it to grow at the tree's expense, and then have to cut it off. And another object in side-shoot pruning is to make the tree produce fine large cherries, all closely nestled around the big wood, and no long, slim branches hanging down like weeping willow. All such branches are always more or less sunburnt on the top and full of worms, one of the evils tending to the destruction of the tree.

Mr. Geiger's method is commended to those who like a tree with a central leader, and are willing to give their orchards such constant attention as he does. His orchard near San Jose shows that his system is practicable; in fact, he followed it for a lifetime, and his orchard is still famous.

THE USUAL METHOD OF PRUNING THE CHERRY.

As we have said, all cherry growers agree on low heading and on the advantage of pinching the lowest shoots as soon as they make a bunch of leaves. In forming the head, and in after treatment, the usual method is quite different from that we have described. It follows the vase or goblet form, which has been discussed at length in the chapter on pruning. Of the application of this method to the cherry, W. W. Smith, in an address before the State Horticultural Society, said:—

The cherry may be pruned the same as any other deciduous fruit trees until it is about five years old; after that the less pruning the better, except when necessary to cut out a dead or crossing branch. Pruning the cherry is more or less likely to produce gum (and this, decay), and should be avoided as much as possible. Cherry trees, however, should be trained with low heads not to exceed eighteen inches from the ground to the first branches; fifteen inches is better. From three to five branches are enough to form the head of the tree; all others should be removed early. Three are better than five; two makes a forked tree, which is likely to split down in after years.

At the end of the first season we have a neat little tree with three to five branches. During the following winter these branches should be cut back from six to eight inches. The next season these should be allowed to produce two branches each (no more); then, at the end of the second season from planting out, we have a tree with from six to ten branches. The following winter the new growth should be cut back again to from twelve to eighteen inches—according to the amount of growth the tree makes—the less the growth the more you cut. The same process should be repeated the following winter, treating each branch as an individual tree, until the tree is about five years old; it takes at least five years to get the head of a cherry well established. After this, as some varieties will persist in throwing out branches near the ground, they should be removed during the summer. At this age the tree, if well grown, will have top enough to shade its body from the sun, and there is no further need of branches on the main trunk.

If necessary to remove large branches it should then be done in *mid-summer*, as that is the only season when the gum is not more or less exuded. We make it a rule to go over and dress up and prune our cherry orchard immediately after the crop is gathered—which in our part of the State is the last of May. All wounds made then by the removal of branches or otherwise will heal over the same season. All large wounds made at any time, however, should be coated over with paint.

The method thus described by Mr. Smith is that by which probably nine-tenths of the cherry trees of this State are shaped.

In the cherry there should be the same observation as to cutting inside and outside buds as with other trees; in fact, the outside bud is the rule, because so many varieties make a directly upright growth. In removing limbs, cutting to the collar or swelling at the base of the limb is especially important, also the covering of the wound to prevent checking of the wood.

GRAFTING OVER THE CHERRY.

Since canning of cherries began on a large scale, there has

been a vastly increased demand for white cherries. The Royal Ann (a local name for Napoleon Bigarreau) has been the favorite. Other white sorts are also used for canning. This rise in favor of the white cherries has vastly increased their proportionate production as compared with the choice black and red varieties, which are still popular as table fruit.

It is the experience of growers that the cherry is grafted over as easily as the pear or apple, if the tree is healthy. In large trees as many as fifty or one hundred grafts may be set, choosing the smaller limbs, even if you have to go pretty high in the tree. J. W. Cassidy, of Petaluma, advises grafting before the sap begins to flow in the winter, or if not done then, wait until the buds are well advanced or the tree in bloom. He has trees which were over thirty years old before they were re-headed, and they now have fine tops of new and healthy wood, and produce abundantly.

PESTS AND DISEASES OF THE CHERRY.

The disease of the cherry which is most heard of is the "gum," or overflow and condensation of sap, which, if left to itself, often induces decay of adjacent bark and wood. Without attempting to explain the cause or causes of the unhealthy exudation, it may be said that prompt treatment of certain manifestations is desirable, and in others the tree should be cleansed from the flow. Where the gum exudes on the side of trunk or limb, the thin outer bark should be pared away with a sharp knife, the accumulation of gum and sap removed, and the wound painted with lead and oil paint. Mr. Geiger used for this purpose a mixture of two parts of resin and one of shellac melted together, adding a small piece of tallow to the melted mass. Gum in the crotch should be cleanly brushed out when softened by the winter rains. If allowed to remain, it becomes sour and offensive and may injure the tree. In places where two or three limbs come out close together a kind of cup is formed, which will hold the gum from one year's end to another, and, in its soft state, leaves, sticks, cherry pits, dust, and dirt will stick and hang, and sometimes the mass becomes so foul that the stench can hardly be endured. By this collection, also, a nest is made for all manner of insects, bugs, and worms. Another evil in letting the gum stay on is, if rain does not wash it off clean, it runs down the trunk of the tree and makes the bark look bad, and if it is very thick on the bark when it dries, it will contract and crack the bark crosswise, and is very injurious to the tree.

Gumming in the crotch can be largely avoided by starting the young cherry as advocated in the chapter on pruning. Branches which emerge from the trunk at separate points and

at wide angles seldom gum: those which are crowded together or emerge at acute angles gum badly. In shaping young trees a gumming joint sometimes may be clearly cut out and those branches selected to remain which start out more nearly at a right angle; in older trees there is nothing to do but keep the fork clean, as already described.

There are cases reported in which gumming of old trees has been stopped by allowing the ground to lie uncultivated, weeds being cut down with the hoe. Some trees which persisted in making rank wood growth, and bearing no fruit, have been made fruitful by the same treatment. As a rule, however, the cherry thrives with good cultivation.

Die-back of the Cherry.—The dying back of cherry branches is more or less common in all regions, and the immediate cause thereof is not known. It is apparently sometimes a root trouble, as is the dying back of other fruit trees. This might have resulted from standing water in the winter in the soil, although the same condition may result from lack of sufficient moisture. Anything which causes destruction of the root hairs is apt to cause die-back and other forms of unthrift in the top. Early vegetative activity in the branch, followed by frost, seems also to occasion die-back in some cases. Fortunately, this can occur without injury to the rest of the tree, though it is sometimes and in some places destructive to the tree in the end. The only treatment is removal of the affected wood, and if this can be done during the growing season, as soon as signs of injury appear, it is all the better.

The Gopher.—One of the most dangerous foes of the cherry is the gopher, for he seldom takes less than the whole tree, young or old. Traces of his presence should be constantly watched for, and killing methods described in a later chapter adopted. If a tree is seen to wilt suddenly, the probability is that a gopher has girdled it. Covering the wound sometimes saves the tree, but not usually.

Insects injuring the cherry will be mentioned in a subsequent chapter.

VARIETIES OF THE CHERRY.

Many varieties of the cherry have been tested in this State, and many have been abandoned from one cause or another. Those most frequently starred in our table are the survivors in public esteem. As our reports have come from those who grow for market, possibly some sorts too tender for shipment, but excellent for family use, are omitted, but will be included in the descriptions which follow the table. The claims to value upon which a variety is judged are several: Extra earliness, an important consideration in early districts for shipment, and else-

where for local sale or family use; firmness to withstand mechanical injury by jarring in transit and durability to escape decay during the long journey to distant markets; firmness and fixed color to stand processing in the cannery and to prevent coloring the juice; lateness to extend the cherry season.

In classification of cherries it was originally considered that there were four classes of cherries. The Hearts were the tender and half-tender sweet cherries, while the Bigarreaux were the firm-fleshed ones; but these have been so intermingled and blended together by hybridization that no distinct line can now be drawn separating them. There is really but one class of these, whose main characteristic is the large, vigorous growth of the tree. The Duke and Morello cherries, also wanting a natural division, really constitute but one class.

CHERRY VARIETIES APPROVED BY CALIFORNIA GROWERS.

VARIETY.	Upper Coast region.	Central Coast region.	Interior valley and foot-hills.	Mountain valleys and plateaux.	Southern California.
Advance	x	x	x	x
Bing	x	x	x	x
Black Heart	x
Burr's Seedling.....	x
Centennial.....	x	x	x	x
Chapman	x
Early Purple Guigne.....	xx	xx	xx	xx	x
Elton	x	x
Knight (Early).....	x
Lewelling	xx	x	xx	x
Mezel	xx	xx	x
Napoleon (Royal Ann)...	xx	xx	xx	xx	xx
Pontiac	x
Rockport.....	x	x
Schmidt.....
Spanish (Yellow).....	x
Tartarian (Black).....	xx	xx	xx	xx	xx
Wood (Governor).....	x	x	x	x	x
May Duke	x	x	x	xx
Morello	x	x	x	x
Olivet	x	x
Richmond.....	x	x	x	x	x

It has been attempted to arrange the varieties *approximately* in the order of their ripening. The brief descriptions of standard varieties are in the main condensed from Downing, modified, however, in some respects, by reference to experience and observation of California growers and nurserymen.

In addition to the old standard varieties, a number of

Pacific Coast seedlings have become popular, and others are very promising. Special description of these seedlings will follow the standard sorts.

BIGARREAUX AND HEARTS.

Early Lamaurie.—Fruit large, dark purple; flesh rich, juicy, excellent. Downing says a week earlier than Early Purple Guigne. Has proved the earliest cherry in the University collection at Berkeley, and in Vacaville district. Not fully tested as to regular bearing.

Guigne Marbree.—"Fruit medium large, round, skin dark red; flesh purplish red, tender, juicy, delicate flavor."—*Gillet*. "A better bearer than Early Purple Guigne."—*W. W. Smith*.

Baumann's May (Early Black Guigne).—Rather small, deep rich red, becoming rather dark when fully ripe; tender, juicy, tolerably sweet and good.

Early Purple Guigne.—Small to medium size; purple; tender, juicy, and sweet. This variety is considered the earliest good cherry. It is reported a shy bearer in some localities.

Belle d'Orleans.—Above medium size, roundish, heart-shaped; whitish yellow, half-covered with pale red; very juicy, sweet and excellent.

Early White Heart.—Below medium size, rather heart-shaped, skin dull whitish yellow, tinged and speckled with pale red in the sun; flesh melting, sweet, and pleasant when fully ripe.

White Tartarian.—Fruit of medium size, obtuse heart-shaped; skin pale yellow; stalk slender; flesh whitish yellow; half tender and very sweet.

American Heart.—Fruit pretty large, heart-shaped, often nearly four-sided and irregular in outline; borne in clusters; flesh half tender; skin strong and adhering to flesh.

Werder's Early Black.—An early variety, moderately productive; tree vigorous, spreading; fruit large, black, tender, sweet and excellent.

Knight's Early Black.—"Large, black, tender, juicy, rich, and excellent; high flavor; a shy bearer until the trees attain age."

Rockport Bigarreau.—Large; pale amber in the shade, light red in the sun; half tender, sweet and good; a very excellent and handsome cherry; good bearer; highly esteemed for canning and shipping.

Coe's Transparent.—Medium size; pale amber, red and mottled next the sun; tender, sweet and fine.

Cleveland Bigarreau.—A thrifty, strong, spreading grower, and productive; large; clear red and yellow; juicy, sweet, and rich.

Black Tartarian.—Fruit of the largest size, bright purplish black. Flesh purplish, thick, juicy, very rich and delicious. Tree a remarkably vigorous, erect, and beautiful grower, and an immense bearer; the best of the black cherries.

Governor Wood.—Large; light yellow shaded with bright red; flesh nearly tender, juicy, sweet, rich and delicious; a vigorous grower and very productive.

Elton.—Large, pointed; pale yellow, nearly covered with light red; juicy, with a very rich and luscious flavor; one of the best.

Black Eagle.—A very excellent English variety, ripening in June; large size, deep purple, or nearly black; flesh deep purple, tender, with a rich, high-flavored juice.

American Amber.—Fruit medium sized, roundish, heart-shaped; skin thin, smooth, light amber, delicately mottled and overspread with bright red; flesh tender and juicy, but not high flavored.

Yellow Spanish (Bigarreau Graffon).—Large; pale yellow, with red cheek in the sun; flesh firm, juicy, and delicious; one of the best, most beautiful, and popular of all light-colored cherries.

Mezel, Monstrueuse de (Great Bigarreau).—A foreign variety of the largest size; dark red or quite black; firm and juicy; late.

Pontiac.—Large; dark purplish red; half tender, juicy, and agreeable.

Burr's Seedling.—Large; yellow, shaded with red; sweet and rich; vigorous and great bearer; apparently does better near the coast than in the interior.

Oxheart.—Fruit large, obtuse, heart-shaped; skin dark red; flesh red, half tender, with a pleasant juice of second quality.

Napoleon Bigarreau (Royal Ann).—A magnificent cherry of the largest size; pale yellow, becoming amber in the shade, richly dotted and spotted with deep red, and with a bright red cheek; flesh very firm, juicy and sweet. Tree a free grower and an enormous bearer.

Tradescant's Blackheart (Elkhorn).—Large, heart-shaped; deep, glossy black; very solid and firm; dark purple, moderately juicy.

Schmid's Bigarreau.—"A new German variety lately introduced. The largest of all the Black Bigarreau cherries. Skin of a deep black color; flesh dark and very juicy, with a fine flavor."—*John Bidwell*.

DUKES AND MORELLOS.

Early Richmond (Kentish).—An early, red, acid cherry; valuable for cooking early in the season.

May Duke.—An old, well-known, excellent variety; large, dark red, juicy, subacid, rich.

Arch Duke.—Fruit large, obtuse, heart-shaped; bright red becoming dark; flesh light red, melting, juicy, rich, subacid flavor, very good; tree more upright and vigorous than May Duke.

Late Duke.—Fruit large, flattened or obtuse, heart-shaped; white, mottled with red, becoming rich dark red when ripe; flesh yellowish, tender, juicy; hangs long on the tree.

Reine Hortense.—"It is one of the very largest of cherries; a beautiful, glossy red, or deep pink, when fully ripe; heart-shaped; a universal bearer, and when hanging on the tree no fruit is more beautiful; excellent for canning, but too soft and juicy for shipment."—*W. W. Smith*.

English Morello.—Large, dark red, nearly black; tender, juicy, rich, acid, productive and late.

Guigne Noir Luisante (Black Spanish).—Fruit medium size, round, heart-shaped, glossy, blackish red; flesh reddish purple, tender, juicy, rich, acid.

Belle Magnifique.—Fruit large, roundish, inclined to heart-shape; skin a fine bright red; flesh juicy, tender, with sprightly subacid flavor; one of the best of its class; a fine table fruit when fully ripe.

PACIFIC COAST SEEDLINGS.

Lewelling—Black Republican (Black Oregon).—"Seedling by Seth Lewelling, Milwaukee, Oregon, from seed planted in 1860; first fruited in orchard in 1864. Widely distributed in California. Large, black, sweet, with purple flesh; ripens ten days after Black Tartarian."—*James Shinn*. "Large, late black cherry, good flavor, long keeper; dries and ships well. Seems to succeed better on foot-hills than in the valley."—*Robert Williamson*. "Supposed to be a cross between Napoleon Bigarreau and Black Tartarian, having the solid flesh of the former and the color of the latter; very late."—*John Rock*. "I am of the opinion that the Black Republican and Lincoln came from the seed of the Black Eagle, but I have little idea of what variety they were crossed with."—*Seth Lewelling*.

Bing.—Originated by Seth Lewelling, from seed of Black Republican. "Fruit large, dark brown or black, very fine; late; a good shipping variety."—*Seth Lewelling*. Tree vigorous, and foliage heavy.

Centennial.—A seedling of Napoleon Bigarreau, raised by Mr. Henry Chapman, in Napa Valley, and fruited by him for the first time in 1876. Propagated and introduced by Leonard Coates, of Napa, in 1885. It is larger than its parent, more oblate in form, and beautifully marbled and splashed with crimson on a pale yellow ground; exceptionally sweet and of remarkable keeping quality. Described by Committee of American Pomological Society (1885) as follows: "Size large, slightly oblate; amber, with dark crimson marbling; flesh firm, sweet, and rich; quality best; condition excellent (after crossing continent by mail), showing its good shipping qualities." The Centennial has been little planted recently, because of superiority of Royal Ann.

California Advance.—Originated by W. H. Chapman, of Napa, propagated by Leonard Coates, of Napa. Seedling of Early Purple Guigne, ripens one week earlier than its parent; is larger and more obtuse, rounded form, and said to be a heavier bearer; dark purple turning black; rich and sweet, and of good degree of firmness.

The Oregon.—Seedling of Napoleon Bigarreau, by H. W. Prettyman, of East Portland, and named by Oregon State Horticultural Society in 1888; described as larger than Napoleon; firm; dark red; "fit to eat earlier than Napoleon, but coming to full maturity somewhat later." Introduced in 1888, by W. S. Failing, Portland.

Oregon has been prolific in originating new varieties of the cherry which are locally popular, but only a few have established themselves in California.

CHAPTER XIX.

THE PEACH.

The peach was for many years the leading orchard fruit of California, but the recent large planting of prunes has relegated the peach to second place. The peach was the first fruit to ripen on the improved trees brought here by the early American settlers, and the magnificence of the peach was consequently the key-note of the refrain which greeted the ears of the world in which the California gold cry was ringing early in the fifties. In fact, the gold from the mine and the gold from the tree were very nearly related. In old Coloma, where gold was discovered, there was a peach tree which bore four hundred and fifty peaches in 1854, which sold for \$3.00 each, or \$1,350 for the crop of one tree, and in 1855, six trees bore one thousand one hundred peaches, which sold for \$1.00 each. Some of these pioneer trees are said to be still living and bearing fruit.

LONGEVITY OF THE PEACH IN CALIFORNIA.

There are many other facts to establish the claim that the peach tree, if planted in a suitable soil and situation and cared for with any devotion and skill, is not a short-lived tree in California. California is too young to mark the limits of its duration, but there are numerous instances in the earliest-settled places in the State, where peach trees above forty years old are still vigorous and productive.

In favorable soils the peach is stronger and longer lived in the root than in the top, and sometimes triumphs over neglect by discarding its old, wind-broken, sun-burned and bark-bound branches, and forms a new head of its own. This is the reason why the intelligent system of pruning which is now prevalent, ministers to the longevity as well as the profitability of the tree, aiding it to constantly renew its youth by restraining its exuberance, and at the same time furnishing it sound new wood on which to grow its fruits and foliage. But while these are facts, there is some difference of opinion as to the point at which an old tree becomes less valuable than a young one. Along the Sacramento River some count about a dozen good crops as the

limit, and thus replace the trees when about fifteen years of age. This is a point which may vary greatly, according to local conditions.

Early Productiveness.—Quite as important as the longevity of the peach tree are the facts of its rapid growth and early productiveness. It is the first of our fruit trees to attain size and yield a profitable crop. In localities best suited to its growth it will mature some fruit the second summer in the orchard if the small shoots are not pruned away from the main branches, and during the third summer averages of forty to fifty pounds per tree have been secured from considerable acreages. These facts are stated to show what the peach of good variety may do in a good situation and soil and with the best of care. Of course they are not to be taken as average results, although greater than those given are sometimes attained.

LOCALITIES FOR THE PEACH.

Nearly every county in California reports the possession of peach trees. Above an elevation of four thousand feet on the sides of the Sierra Nevada, they may be subject to winter killing, and lower still careful choice of situation has to be made to avoid frosts at blooming-time—the peach in such places being subjected to some dangers which beset it in the eastern States. Below these points, however, lies the great fruit belt of the foot-hills of the Sierra, where the peach is the chief fruit grown and its excellence is proverbial. Size, beauty, richness, and delicacy of flavor, firmness, which endures carriage to the most distant markets, are all characteristics of the foot-hill peaches of California.

In the great interior valleys of the State wherever proper condition of soil and water supply can be found, the peach also thrives, the tree making a wonderfully quick and large growth, and the fruit attaining great size.

In the small valleys on the west of the great valley and on the eastern slopes of the Coast Range, there are also extensive areas suited to the peach, and sheltered places on the eastern and western edges of the Sacramento Valley have produced the earliest fruit for a long series of years. Recently the contest for the earliest fruit of these districts, with the foot-hill district on the east side of the Sacramento Valley and special locations in the upper San Joaquin Valley, has been quite close.

In the coast valleys, opening upon San Francisco Bay and the Pacific Ocean, the peach is also a leading fruit. Its success is greatest, however, where good shelter is had from direct coast influences. Even where open to these influences, good peaches can be grown by choosing the smaller range of varieties, which

do well by protecting the trees from harsh winds, and by seeking elevation above depressed valleys, whose frosts are frequent. The occurrence of curl-leaf is a factor of much importance, which will be considered presently. In the coast counties north of San Francisco Bay the danger to the peach from unfavorable atmospheric conditions increases as one goes northward, and situations must be chosen with greater care. And yet by such exercise of care, peaches for home use and local markets can be successfully grown.

South of San Francisco Bay the coast influences soften as you proceed southward, and the peach draws nearer to the ocean, choosing, however, elevations, and avoiding broad, wind-swept areas and narrow defiles where drafts and fogs are frequent. At considerable elevations, as on the Santa Cruz Mountains, some varieties of peaches are notably excellent. The general rule holds with the peach, as with other fruits, that coast influences retard ripening and the season of the fruit is late.

In the valleys and at elevations in southern California the peach is largely grown and high excellence attained.

SOILS AND EXPOSURES FOR THE PEACH.

Though the range of soils for the peach can be somewhat extended by the choice of stock for budding upon, as will be considered presently, its range is narrower than that of the apricot. The best peach soils are light, deep, sandy loams, rather dry than moist, but under all circumstances well drained. It will thrive on land with a considerable mixture of coarse sand or gravel, providing it contain also needed elements of fertility; for the rapid growth and heavy fruitage of the peach requires abundant nutrition. Though it accepts coarse materials both in soil and subsoil, it relishes fine sediment and perhaps finds no more congenial location than in the deep, sandy loam, or sedimentary deposit bordering the creek beds of our warm valleys, and will send its roots deep to secure long life and abundant fruitage. Such soils, whether along existing streams or deposited by prehistoric water courses, which have left their mark by the elevated ridges of rich sediment above the prevailing valley soils, are warm, deep, and thoroughly drained, and delight the peach.

At elevations on the hillsides there are free loams which result from decomposition of the underlying rocks, and on them the peach thrives, both where the soils themselves are deep and where the underlying rock is loose and open, permeable by roots and affording escape for water. Success has been reported even when holes are partly excavated in these rotten rocks, as in the soft sand rock on the hills east of Vaca Valley, or in the broken chalk rock in what is called Blackburn Gulch, near Santa Cruz.

The superior warmth of such soils is supposed to minister to earlier ripening of the fruit, though the escape from cold air by elevation is no doubt a greater factor to the end.

The influence of comparatively slight difference in elevation is very marked. E. R. Thurber, of Pleasant's Valley, Solano County, has a plat of peach trees on a natural terrace about seventy-five feet higher than the general level of his orchard. On the terrace his peaches ripen and are disposed of before the same varieties ripen in the orchard below.

As in the valley a short distance to water is to be avoided, so on the hills too great percolation from higher levels is undesirable. Of course natural defects of this kind can be corrected by adequate under-drainage.

Still, though such be the general soil conditions best suited to the peach, the tree can be well grown for home use or local markets on somewhat heavier soil, providing there is good drainage, but drainage must be insisted upon, for thousands of trees have perished during the last few years because planted in retentive soils without drainage. Alkaline soils should, however, be avoided, as the peach, when grown on its own roots, seems to be of all fruits most sensitive to alkali.

As to exposures for the peach the same rules hold as for other fruits which are liable to injury when in bloom or young foliage. Thus low places where cold air settles should be avoided, also low gulches through which cold drafts prevail. In frosty situations an incline away from the morning sun will often allow the trees to escape serious injury.

PROPAGATION AND PLANTING.

The chapter on propagation gives the general method of growing and budding peach seedlings. In selecting pits, preference is usually given to those from strong-growing, yellow peaches, at least for working on the same colored fruit, while others use pits of the Morris White, others the Strawberry, and others still will use only pits from vigorous seedling trees. In this State the peach is usually so healthy and vigorous, and the "yellows" not known, and less care may be needed in selecting pits; still, there is certainly nothing lost by making every effort for a good stock.

The hard-shell sweet almond has long been used as a stock for the peach. It is held that it gives a hardier, stronger root, in dry soils especially.

When it is desired to grow the peach on moister soil than suits its own roots, the St. Julian plum is used. The Myrobalan has been used to some extent, but experience generally does not favor this stock.

The so-called "peach-almond" has been used to some extent. It is a fruit having the pit of a peach but the pericarp of an almond, that is tough and tasteless and disposed to split like an almond hull. Early in the fifties a chance hybrid of this sort appeared in the nursery of W. B. West, of Stockton, and its pits were used for nursery seedlings which, when budded to the peach, produced good trees. Trees bearing the peach-almond are found here and there over the State. Mr. Burbank has produced a hybrid of the Wager peach and the Languedoc almond.

Distance in Orchard.—Distance observed in planting peach orchards differs greatly, according to the views of different growers. Regarding the peach as a catch crop to plant between apricot, pear, cherry, walnut, fig or other slower-growing, larger trees, the trees may be set comparatively close; that is, with the latter trees at thirty to forty feet, and alternate rows of peach planted quincunx, and to be removed at the end of ten to fifteen years. If the peach is to have the ground to itself, some planters plant at eighteen feet in equilateral triangles, or twenty to twenty-four feet on the squares, the present tendency with the peach, as with other trees, being to give more room than was the custom a few years ago.

Age of Trees.—In planting peach orchards yearling trees are generally used, although far more are planted in dormant bud than of any other kind of fruit trees. The reason for this is easily found in the disposition of the peach to make a tree the first year from the bud. It springs almost at once into a full outfit of laterals. Some growers employ this disposition to form a head the first year in the nursery. When the bud has grown out eighteen inches, pinch it off at the top and force out laterals, which make long growth the same season. When planted out in orchard the following winter, cut back to ten or twelve inches. In this any one can get a yearling with the equivalent of a two-year-old head on it. The common practise is, however, to let the growth from the bud proceed as it chooses, and when the yearling is set in orchard, cut back to a single bud, laterals which are desired to form the head and removing others. The development of form from a yearling branched in the nursery is illustrated in chapter on pruning.

Recently preference has arisen for smaller trees for transplanting and, especially in the foot-hills, June buds, described in the chapter on propagation, are largely employed.

Planting Dormant Buds.—The chapter on planting describes the planting of yearling trees. The lifting of dormant buds from the home nursery and planting in orchard is described by P. W. Butler, of Placer County, as follows:—

Have the ground prepared and stakes placed in position in the orchard in early February, if possible, and begin the planting at once, while the trees

THE MUIR PEACH: A CALIFORNIA SEEDLING.—See page 241.



are in dormant bud. Take no more trees from the nursery than can be planted in half a day. Plow a furrow on each side of the row, six inches from the trees, turning the soil from them, then two men with heavy spades or shovels, one on each side of the tree, can readily take it up without breaking many of the roots; and what are so broken should be smoothly trimmed with a sharp knife. Place the trees in a tub of water, near where they are to be planted, and take from it only a few at a time. Put them in a basket or box and cover with wet sack, that they may be kept moist until placed in the ground.

On planting, place the bud one inch below the level of the ground, but do not cover it until after it has grown to the height of a few inches. The stock should be cut off at the bud with a thin, sharp knife, and not with shears, as is often done, as the latter method will sometimes split the tree, when it will take in moisture and not heal readily.

Some growers do not cut back the young seedling tree until growth has started out well on the dormant bud.

Rather more care is needed in handling dormant buds both in planting and in their young life in the orchard. Lookout must be kept for suckers and against injury in cultivation. Success with dormant buds is notable. In good hands they commonly outgrow yearlings planted at the same time, and the percentage of loss from failure of the bud to start is very small. Of course every bud should be examined before planting, to see that it has a healthy color.

In the selection of peach trees for planting, a clean, healthy root only should be taken. During recent years there have been a good many young roots affected with knots or swellings from some obscure cause. Such trees should be burned. If planted, the knot sometimes grows to an enormous size and little or no top growth is made.

PRUNING THE PEACH.

As has been advised for other trees, the peach should be given a low head, developed as described in the chapter on pruning. In its after-treatment, it has been the universal experience that constant "heading in" is essential to the strength and health of the tree. This also has been considered in an earlier chapter. The peach is a pressing instance of the necessity of regular pruning, to renew and regulate the amount of bearing wood and to promote profitable longevity in the tree. Illustrations of the pertinence of these remarks are found in the practise of the most successful peach growers in all parts of the State. A few instances will be given:—

The peach, fruiting only on wood of the previous year's growth, bears fruit farther away from the body of the tree each year, and the small shoots of from one-eighth to three-sixteenths in diameter begin to decline when the fruit is removed. To have healthy growth, all of these small branches must be removed the first winter following their fruiting, when there is a greater tendency to form small new growths, which may fruit the following

season. In the peach, it will seldom be found necessary to remove any interior branches, except suckers, until they have produced a crop, when they will begin to decline and should be removed.

"I would certainly not cut peach trees back less than one-half of the new growth in the winter pruning, and our trees are getting too large for their age even with that amount of pruning. This has suggested, in other localities, summer pruning or shortening in, with success in some places. So far my own experience is favorable. It will be noticed on trees kept growing rapidly that the fruit buds are near the ends of the shoots, and it seems to take away too many of these buds to cut back one-half in the winter pruning, but by cutting back about one-half the new growth in August, fruit buds are developed lower down, and where they would not be developed without the summer pruning."—*H. Culbertson, El Cajon, San Diego County.*

"Prune the peach every year, cutting back and thinning out the center, using great care not to cut out too many of the little fruit shoots of new wood growing on the main branches, but removing the slender branches of the old wood, leaving as many branches of the new growth as the tree will support. In this case judgment must be used as to what the tree will support. The soil may be wet or dry, rich or poor, the grower must be the judge. To grow small fruit, prune lightly; to grow large fruit, prune with care and judgment. To get this judgment you must have some practical experience. I prefer doing the work when the sap begins moving in the spring of the year. All cuts heal over better then and the pruner can see how the buds are setting and use his own judgment as to how much wood he wants to cut out."—*R. C. Kells, Yuba City, Sutter County.*

"Cutting back the peach must be more severe, as the growth of the new wood diminishes. Not more than five or six fruit buds should be left on a shoot, and if the fruit all sets, it must be also thinned. The trees should be trained low and their vigor encouraged by permitting a reasonable amount of young shoots to grow around the lower part of the main limbs. When this method is continued systematically every season, the trees will bear large crops of fruit, of good quality, for many years. When they are allowed to overbear for one or two seasons, the fruit will decrease in size, and soon become almost worthless; the trees will be enfeebled, and in consequence very liable to be attacked by disease. The only thing to be done in this case is to cut off the whole top of the tree, allowing it to form a new head. I have seen old peach orchards thus renovated, and the results are often very flattering, but it is far better not to allow them to get into a condition where this desperate remedy is necessary."—*Leonard Coates, Napa.*

Cutting Back the Peach Is not Shearing.—Some undertake the annual pruning of the peach by a shearing process, treating a fruit tree as one would a hedge—cutting everything to a line. There has been a good deal of this done in California, but it is wrong nevertheless. Shortening in the new growth of the peach each year is proper practise. It is the first step toward preventing overbearing of small, unmarketable fruit and saving the tree from profitless and injurious effort. Thinning the shoots by removing all but one when two or three start from the same point is also working toward large fruit and regular bearing in the tree. This shortening and thinning of the new wood must also be followed by thinning of the young fruit just after the natural drop and it is seen that the tree carries too many. Proper pruning can not be done by shearing because it is apt to shorten the strong shoots too much and the weak shoots too

little. Each shoot must be cut by itself according to its growth and its ability to carry more or less fruit. Shearing, too, does not thin out the shoots but continually multiplies them until the tree is as full of brush as a hedge.

THINNING PEACHES.

Thinning out fruit on the peach tree is not only the secret of obtaining good, marketable fruit, but joins hands with pruning in preserving the health and future production of the tree. The importance of thinning has been urged in a previous chapter, but the following is a very strong statement, by Mr. Culbertson:—

In my experience there is no single operation in connection with fruit growing of more importance than thinning. The past season, in order to test the difference in expense of preparing large and small peaches for drying, I timed the cutting, and found it took double the time; hence, double the expense, which meant a difference of about \$15 per ton of dried fruit. Add to this a difference of two cents per pound in price makes \$55 per ton. Suppose an orchard under good treatment produces a ton of peaches to the acre, then \$55 would represent the difference in profits. Unthinned or small fruit is certainly undesirable.

As to how much thinning should be done there are diverse opinions. Some take off one-half, others three-fourths. Some growers thin to meet a certain ideal, but find it difficult to explain in words. The common rule of leaving a specimen of fruit every four or six inches is a safe rule; that means many must come off. Different conditions of soils, climates and irrigation vary the amount to thin out more or less. More may be left where the tree is on land giving a strong, vigorous growth.

In thinning peaches I have been practising a method that gives good results and is easily learned. The peach bears on three sizes of branches, that are one-eighth, three-sixteenths, and one-fourth of an inch in diameter. The first has two peaches, the second three, and the third four; this, of course, after there has been a judicious course of pruning and the trees under irrigation; trees on dry land should have only one-half as many left. To reach this result often a dozen may have to come off, allowing only two to remain. The more there are the greater necessity for thinning.

The time for thinning peaches is as soon as one can be sure which are likely to remain on the tree and which will drop of their own accord.

WORKING OVER PEACH TREES.

The fashion in peaches changes from time to time according to the demands of the canners or the market for dried fruit. The grower often finds varieties which he first selected, less healthy, less productive, or, for other reason, less desirable than others. There is, therefore, often occasion for working over trees. Budding is often resorted to, buds being successfully set in quite old wood, providing buds from well-matured wood are taken. Wood buds from young trees unaccompanied by fruit are best, but because of greater certainty of securing the variety desired, it is common to take wood and fruit buds together from bearing trees. A larger cut of bud and adjacent

bark is taken when working in old bark than for use on seedlings. When a branch is budded, it is sometimes broken at a distance beyond the bud and allowed to hang, the idea being to furnish the bud some but not too much sap. Some growers thus bud and break part of the branches, allowing others to remain unworked, to maintain the growing processes of the tree. These branches and those in which buds have not taken, are cut off and grafted the following spring. The almond is successfully grafted over with the peach, and this course has been followed with thousands of unproductive almonds.

Grafting the Peach.—Grafting the peach by the ordinary top-grafting with a cleft graft seldom succeeds. A side graft with saw and knife is better. It is described by J. W. Mills, of the University Experiment Station, near Pomona, as follows:—

Saw grafting is rapidly taking the place of cleft grafting, for it does away with all difficulties arising from splitting and there is no cavity left in the heart of the limb or tree. The process is to saw off the limb at the desired place as in cleft grafting, then saw across the corner and down the side at an angle of about 45 degrees and trim out with a sharp knife. Place the knife blade a little to one side of the saw cut, a little farther from the edge at the top than at the bottom, and by pressing on the knife the whole sides of the crevice will be trimmed smoothly at one stroke; this operation repeated on the other side of the saw cut will make a neat notch in the end of a solid limb. By cutting a little deeper from the saw cut at the top than at the bottom, and if the amateur does not trim his scion at the right angle, he can insert it gently in the crevice or notch and see just where to trim. If he is so slow that the fresh cut shows signs of discoloration, he can make a fresh surface by placing his knife parallel to the edges and shaving off a thin slice. He still retains the same angle, but the scion will set a little deeper, which is no objection. By cutting a thin layer off the top of the stump next to the notch will show exactly where the inside layer of bark is. The inside bark of the scion must be even with the inside layer of the bark of the stump or limb that is being grafted. If the scion is inclined slightly out or in at the top, it will make a correct union at some point and be sure to grow. If the inclination is very slight the union will extend over considerable length and will make a much better start than if the union is at only one point, owing to the enlarged surface through which the sap is transmitted. One of the most important points in grafting is to have good wax and go over the grafts a few days after they are put in and rewax them.

DISEASES OF THE PEACH.

Curl-Leaf.—The most prevalent trouble with the peach tree in California is the curl-leaf. It was noticed from the first planting of peach trees by Americans, nearly forty years ago. Only recently has it been conceded to be due to parasitic fungi, and its prevention by washes of fungicidal character demonstrated. The treatment will be described in the chapter on tree diseases. The facts of its occurrence may be stated as follows:—

Curl-leaf is much more prevalent in some sections than others, and in one place than another in the same section, and some sections are practically free from it. Some varieties are

much more subject to curl-leaf than others; generally speaking, some curl nearly everywhere, others curl in one place and not in another, others are practically free from curl in all situations.

Curl-leaf occurs in various degrees. Mild cases do not seem to injure either tree or fruit; severe cases destroy the fruit and sometimes the tree itself. The disease is almost always at its height when the young fruit is about the size of small peas. If the curl is "bad," the fruit will fall to the ground, there not being healthy leaves enough to afford the required support. If, however, the curl is moderate and partial, only a part and sometimes none of the fruit will be lost. The disease, as is well known, is of brief duration, say twelve to twenty days, after which the trees resume a healthy appearance in every respect, and if the fruit has been able to survive the ordeal, it also appears to grow and become as perfect as if no check had been given to its growth.

Mildew.—This disease, which occurs in the form of whitish felted patches on leaf and twig early in the spring, and finally affects the fruit, has long been troublesome in this State, and

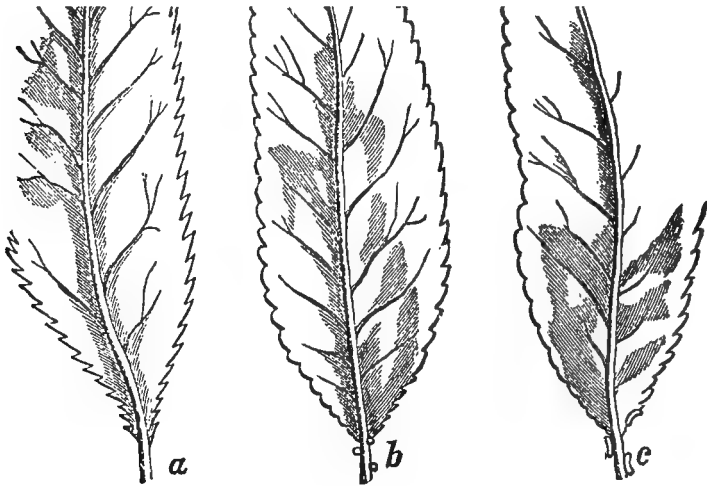

Characters in the Leaves of Peaches.

occurs on certain susceptible varieties in many localities from the coast to the Sierra foot-hills. Observation in this State has fully affirmed the statement of Downing, that the serrate, glandless-leaved varieties are liable, and those with good glands on the leaf stems are free.

The conclusion would be that where mildew prevails, varieties with serrate, glandless leaves should be avoided. But it has

been found that some glandless-leaved varieties, although subject to mildew, resist curl-leaf. Therefore it may be worth while to combat the mildew. This has been done effectually by treatment which will be described in a later chapter.

As with curl-leaf, mildew is prevalent some years and slight in others.

VARIETIES OF THE PEACH.

Nearly all varieties of the peach have been tried in California, and, as with other fruits, it has been found that varieties must be chosen with reference to their success in special locations. Choice has also to be made according to the purpose of the grower, whether for early marketing, for sale to canners, for drying, or distant shipment or for late marketing. As with apples, there is little use of planting early varieties (unless it be for home or local use) except in very early regions. An early peach from a late region is killed by competition with better middle season sorts from the earlier regions.

In an early region one can plant early, middle, and late varieties to advantage, and thus secure a **very long-fruited** season. The peach season in interior districts begins at the first of June with the Alexander, and continues to the end of November with local seedlings—giving six months of peaches. Of course the very early and very late sorts are only of use for marketing as table fruit. The most important series is a fine succession of mid-season peaches, suitable either for canning, drying, or distant shipment. Such a selection can be made from the tables and descriptions which will be given later.

Color is a most important item in the peach. While canners and Eastern shippers use the beautiful white peaches to advantage, the fashion for canning and drying is now strong in support of the yellow-fleshed varieties and clingstone. The yellow peaches are in greatest demand. The color about the pit is also an important point. Canners demand a peach, whether white or yellow, which is almost free from color at the pit, because the extraction of the red color dyes the juice; in drying, the demand just now is for a yellow peach with a red center, because the colors give the dried fruit a more attractive appearance. Of course there is a market for dried white peaches, but the preference is for the yellow.

In the enumeration following the table only those seedlings which are now commercially propagated are included. Many which were prominent ten years ago have been dropped by this test. The writer has record of many others, some of them likely to rise to important place, which are reserved until after further trial.

PEACH VARIETIES APPROVED BY CALIFORNIA GROWERS.

VARIETIES.	Upper Coast valleys.	Central Coast valleys.	Interior valley and foot-hills.	Mountain valley region.	Southern California.
Alexander.....	XX	XX	XX	XX	XX
Amsden.....	X	X	X	X	X
Albright.....			X		
Bilyeu.....			X		
Briggs' May.....	X	X	X	X	X
California Cling.....			X		X
Decker.....			X		
Early Charlotte.....	X			X	X
Early Crawford.....	XX	XX	XX	XX	XX
Early York.....		X	X		X
Elberta.....	X	X	XX	X	XX
Foster.....	XX	XX	XX	X	XX
George Fourth.....					X
George's Late Cling.....		X	X		X
Gen. Bidwell.....			X		X
Globe.....	X			X	XX
Golden Cling (Sellers).....		XX			XX
Hale's Early.....	XX	XX	XX	XX	X
Heath Cling.....		X	XX		XX
Henrietta.....		X	XX		
Honest Abe.....		X			
Indian Blood.....			X		X
La Grange.....					X
Late Crawford.....	XX	XX	XX	XX	XX
Lemon Cling.....		X	XX		XX
Lovell.....		X	XX		XX
McDevitt Cling.....		X	XX		XX
McKevitt Early.....			X		
McKevitt Cling.....			X		
Mary's Choice.....		X	X		X
Morris' White.....		X	X		X
Muir.....	XX	XX	XX	XX	XX
Newhall.....		X	X		X
Nicholl's Cling.....		X	X		X
Oldmixon Free.....		X			
Orange Cling.....	X	X	XX	X	XX
Persian Cling.....			XX		
Phillips' Cling.....		X	XX		X
Piquet's Late.....			X		X
Runyon's Or. Cling.....		X	XX		X
Salway.....		XX	XX		XX
Smock.....					XX
Snow.....		X			X
St. John.....		X	X		X
Strawberry.....		X	X		X
Stump.....		X			X
Susquehanna.....		XX	XX		XX
Tuskana.....		X	X		
Wheatland.....			XX		X
Wylie Cling.....		X			
Yellow Tuscany.....		X			XX

The following are the peaches chiefly grown in California, arranged approximately in the order of ripening:—

Briggs' Red May (California).—Originated as a chance seedling in nursery row, on the farm of John G. Briggs, on the Feather River, about one mile from Yuby City, about 1870. It was found to be about ten days earlier than the Early Tillotson, which was then the stand-by for an early peach. Fruit medium to large, round; white skin with rich, red cheek; flesh greenish white, melting, juicy, rich, firm enough for shipment; stone partially free, a standard early variety; subject to mildew.

Alexander (Illinois).—Most widely grown as best early variety. Fruit medium to large; greenish white, nearly covered with deep red; flesh firm, juicy, and sweet; bears transportation well; pit partly free.

Amsden (Missouri).—Resembles preceding, but averages smaller; claimed by some to be slightly earlier; rather less liable to curl-leaf.

Early Imperial (California).—Originated by W. W. Smith, Vacaville, and planted to secure a yellow freestone earlier or larger than St. John. Most growers find it no improvement on St. John.

Yellow St. John (New Orleans).—Earliest yellow peach; averages smaller than Yellow Crawford, but classed as large; roundish, orange yellow with deep red cheek; juicy, sweet, and high flavored; freestone.

Hale's Early (Ohio).—Medium to large, nearly round; skin greenish, mostly covered and mottled with red when ripe; flesh white, melting, juicy, rich and sweet; fair for local market and shipping; widely grown; freestone.

Strawberry (New Jersey).—Medium size, oval; stem cavity deeply sunk; suture extending half way round; skin almost wholly marbled with deep red; flesh whitish, juicy, rich and delicate; tree healthy.

Foster (Massachusetts).—Uniformly large, slightly flattened; slight suture; stem moderately depressed; flesh yellow, very rich and juicy; color deep orange, dark red in the sun; freestone; tree hardy and productive; very widely grown in California and popular. Ripens before Early Crawford, which it sometimes resembles, but is of better quality.

Crawford's Early (New Jersey).—Very large, oblong, swollen, point at the top prominent, suture shallow; skin yellow, with red cheek; flesh yellow, rich, and excellent; freestone; tree very healthy and productive; probably the most largely planted variety in California.

George the Fourth (New York).—Large, round, deeply divided by broad suture; sides unequal; skin pale yellowish white, dotted with red and red cheek; flesh pale, red at pit, from which it parts freely; quality good. Somewhat troubled with curl-leaf.

Snow (American).—Large, globular; skin clear, beautiful, almost wholly white; flesh white to the free stone, juicy, rich and sprightly.

Mary's Choice (New Jersey).—Large, yellow, resembling Early Crawford, but ripening later.

Red Cheek Melocoton (American).—Large, roundish oval, swollen point at top; yellow, with deep red cheek; flesh yellow, red at stone, which is free; juicy, good flavor. Approved in Humboldt and San Benito Counties.

Tuskana (Alabama or Mississippi).—Wrongly called "Tuscan" and "Tustin" Cling in this State; largely planted in interior valleys and foothills; very large yellow cling; the earliest fine cling variety; very valuable for early shipping. Ripens with Crawford's Early.

Oldmixon Free (American).—Large, roundish or slightly oval; greenish or yellowish white, marbled with red; flesh white, tender, and excellent, juicy and rich; high flavor.

Honest Abe (California).—"Originated at Healdsburg, Sonoma County. Large, yellow, with red cheek; best quality; ripens between Crawford's Early and Late. Does not curl."—*James Shinn*.

THE McDEVIT CLING. A CALIFORNIA SEEDLING.—See page 243.



Morris White.—Large, oval; skin white with creamy tint when fully ripe; flesh white to the stone, which is free; melting, juicy, sweet, and rich; especially good for home use and canning; somewhat subject to curl-leaf.

Wager (New York).—Lemon yellow tinged with red; flesh yellow, rich, juicy, sweet, and excellent, having much the appearance and flavor of apricots; stone small and free from the flesh; quality best.

Muir (California).—Originated as chance seedling on place of John Muir, near Silveyville, named and first propagated by G. W. Thissell, of Winters. Fruit large to very large; perfect freestone; flesh clear yellow, very dense, rich and sweet; pit small; tree a good bearer and strong grower, if on rich soil, to which it is best adapted; free from curl in Vacaville district; fruit a good shipper and canner and peculiarly adapted to drying because of exceptional sweetness and density of flesh; yield, one pound dry from less than five pounds fresh. One of the best California seedlings. Claimed by some to be identical with Wager.

Wheatland (New York).—Large, roundish; skin golden yellow, shaded with crimson; flesh yellow, rather firm, juicy, sweet, and of fine quality.

Elberta (Georgia).—Very large; round-oval with deep suture; golden-yellow, faint red stripes; flesh yellow, fine, juicy, rich and sweet; tree prolific; perfect freestone.

Newhall (California).—"Originated with Sylvester Newhall, of San Jose. Very large; skin yellow, with a dark red cheek; flesh deep yellow, juicy, and a rich, vinous flavor; ripens about one week before Crawford's Late; tree very hardy, healthy, vigorous, and not affected by curl; freestone."—*John Rock*.

Stump the World (New Jersey).—Large, strong; skin creamy white, with bright red cheek; flesh white, juicy and high flavored. Commended for family use by Southern California Nurserymen's Association. Curls somewhat in some localities; freestone.

Crawford's Late (New Jersey).—Very large, roundish, yellow with dark red cheek; flesh deep yellow, juicy, and melting; flavor rich and excellent; a popular and widely-grown variety, but very subject to curl-leaf in some localities; freestone.

Lemon Clingstone (South Carolina).—Large, lemon-shaped or oblong, having large, projecting, swollen point like a lemon; skin fine yellow; flesh firm, yellow with rich, sprightly, vinous subacid; slightly red at the pit, which adheres firmly.

Orange Clingstone.—Large, round; suture distinctly marked and extending nearly around the fruit; no swelling at apex, like Lemon Clingstone; deep orange color, with red cheek; flesh yellow, firm, juicy, with rich flavor; somewhat subject to mildew. Though largely grown, this variety has been largely supplanted by the following sub-varieties, which are seedlings from it.

Sellers' Golden Cling (California).—Originated on the farm of S. A. Sellers, Contra Costa County, and introduced by James Shinn. Very large, rich golden color; tree healthy; one of the very best of clings; ripens with Late Crawford.

Runyon's Orange Cling (California).—"Originated with Mr. Sol Runyon, on the Sacramento River. Superior to the common Orange Cling. Runyon's Orange Cling has globose glands, and is not subject to mildew like the common sort. Fruit very large, yellow, with a dark crimson cheek; rich, sugary, and vinous flavor. Highly esteemed and extensively planted in the Sacramento region and elsewhere."—*John Rock*.

Nichols' Orange Cling (California).—Originated by Joseph Nichols, of Niles, introduced by James Shinn. Large, yellow, with purple cheek; flesh yellow and good. Tree healthy and a heavy bearer.

Peck's Orange Cling (California).—"Originated at Healdsburg, Sonoma County. Improved seedling of Orange Cling, of Downing. Large,

handsome, yellow-fleshed, free from curl, hardy, vigorous, productive, superior for market or drying; planted more extensively in Santa Rosa Valley than in any other."—*Luther Burbank*.

Stilson (California).—"Originated at Marysville(?). Perfect in shape; very large; red cheek with crimson stripes; yellow-fleshed, more highly colored than *Susquehanna*; table and market quality excellent; ripens after Crawford's Late; freestone."—*P. W. Butler*.

Susquehanna (Pennsylvania).—Large, nearly globular; suture half round; skin rich yellow, nearly covered with red; flesh yellow, sweet, juicy, with rich, vinous flavor; freestone; tree healthy. Very widely distributed and popular.

McCowan's Cling (California).—Originated with Dr. McCowan, of Ukiah. Yellow cling; round, smooth outline; no suture; no red at pit, which is small; flesh firm, fine-grained, and sweet; not much subject to curl; fruit apt to run small unless carefully thinned; reported an irregular bearer in Alameda County; liked by canners; approved in Placer County.

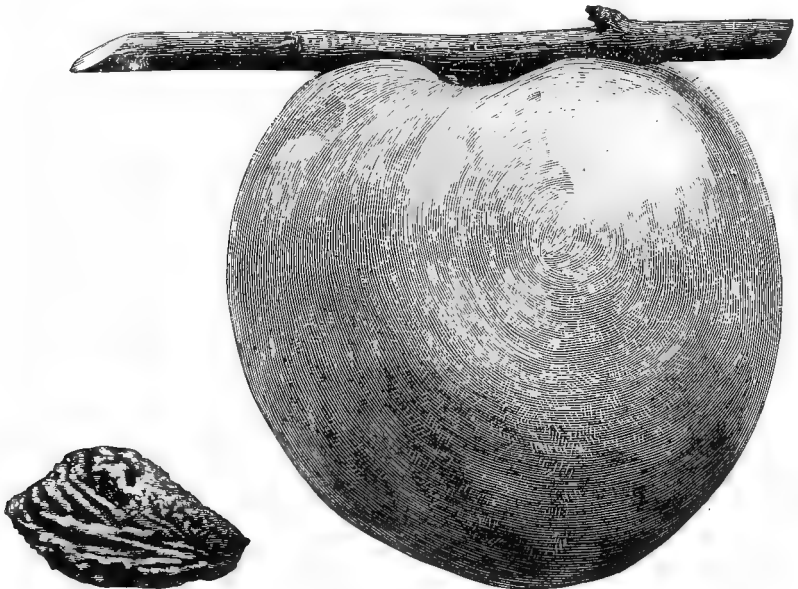

Phillips' Cling—A California Seedling.

Lovell (California).—Originated as chance seedling with G. W. Thissell, and named by him in 1882; propagated by Leonard Coates, of Napa. Yellow freestone; size uniformly large, almost perfectly round; flesh fine, texture firm, solid, clear yellow to the pit; tree a good grower and bearer; superior for canning and shipping, and dries well. Said to curl in some places. "The richest peach I ever saw on a tray."—*E. A. Bonine, Los Angeles County*.

McKevitt's Cling (California).—Originated as chance seedling in apricot orchard planted by M. R. Miller, on place owned later by A. McKevitt, Vaca Valley; named in 1882 by nurserymen who propagated it. A white clingstone; flesh very firm, fine-grained, sugary, and rich, high flavor, white to the pit; skin strong and fruit excellent for shipping or canning; tree remarkably strong in growth and free from disease. Widely distributed.

Wylie Cling.—An old seedling, increasing in popularity in northern Sonora County as superior to Orange Cling in not splitting at the pit, and not dropping from the tree. A fine peach for canning and drying.

General Bidwell (California).—Originated from a shoot from a peach root upon which an apricot had grown and died, on Rancho Chico. Named by State Horticultural Society, September 4, 1886, and commended for cultivation. Ripens one week later than Late Crawford and ahead of Salway and Piquet's Late. About the shape of the Orange Cling, but larger; very yellow with reddish cheek; flesh very solid, juicy, and rich; freestone and a small pit.

California; syn. *Edward's Cling* (California).—"Originated in Sacramento. Very large, round, regular; orange, nearly covered with dark, rich red; flesh deep yellow; flavor delicate, rich, vinous."—*C. W. Reed*.

Piquet's Late (Georgia).—Large to very large; round, sometimes a little flattened; yellow, with red cheek; flesh yellow, melting, sweet, rich and fragrant; freestone; not subject to curl-leaf.

Smock Freestone (New Jersey).—"Large, yellow, mottled with red; moderately rich and juicy. A better drying peach than Salway."—*E. A. Bonine*.

La Grange (New Jersey).—Large, oblong; greenish white, some red on sunny side; not desirable in coast regions; freestone.

Salway (English).—Large, roundish oblate; suture broad, deep, extending beyond the apex; skin downy, creamy yellow, rich, clear, crimson cheek; flesh deep yellow, red at the pit; juicy, rich, sweet, vinous; freestone; a standard late peach in California; tree very healthy.

Phillips' Cling (California).—Originated with Joseph Phillips, of Sutter County; propagated by J. T. Bogue, of Marysville. Fine large yellow cling, no color at pit, which is very small; exceedingly rich and high-colored; described by Mr. Skinner, superintendent Marysville Cannery, as the best peach he ever used.

Persian's Cling (California).—"Originated in Visalia, probably from seed of Heath Cling, and a few days earlier than its parent. Large; clear white skin and flesh, the latter very sweet; commended for canning."—*I. H. Thomas, Tulare County*.

Heath (Maryland).—Described by Downing as the most delicious of all clingstones. Very large; skin downy, creamy white, with faint blush of red; flesh greenish white, very tender and juicy, with most luscious flavor; best adapted to interior regions, or places free from curl.

Steady (Missouri).—"Large to very large; white skin; flesh white at the pit, firm, rich, and good flavor; freestone. Produces very heavy yield of dried fruit."—*I. H. Thomas, Tulare County*.

George's Late Cling (California).—"Originated in Sacramento. Large; white flesh, colored around the pit; beautiful yellow color, striped and splashed with bright red; a very heavy and uniform bearer; a good shipper, and at its season of ripening there is no peach grown in Placer County that yields the grower so much profit."—*P. W. Butler*. Subject to mildew in some localities.

Yellow Tuscany (*Dura cini*, Tuscany).—A very large yellow cling; propagated by G. Tosetti, formerly of San Leandro; tree a strong grower and free from curl-leaf, very productive. On the basis of its behavior at the University Experiment Station at Pomona, this variety has recently been largely planted in southern California. It is counted the best yellow cling for canning in that section. Ripens with Lemon Cling.

Albright's Cling (California).—"Originated with Mr. Albright, near Placerville. Very large; yellow, with bright cheek; rarely equaled in quality and flavor. Described as larger, more highly colored, of better flavor, better shape, and the tree a more prolific bearer than the Orange Cling."—*P. W. Butler*. Endures long shipment well even after being well colored.

McDevitt Cling.—"Originated with Neal McDevitt, of Placer County. Uniformly large; rich, golden yellow, becoming red when ripe; flesh very

firm and solid, superior in flavor; excellent shipper; tree good and regular bearer."

Staley (California). Very large; eleven and one-half inches in circumference; somewhat elongated and flattened laterally; rich, creamy white with very faint touches of light red; suture shallow, but almost continuous around the peach; stone small and perfectly free, cavity considerably longer than stone; flesh white to the pit, very juicy, fine, tender; flavor delicious. Originated as sucker from peach root from which prune had been broken off in Selma, Fresno County. Ripens twenty days after Salway or four weeks after Susquehanna. A high-class white freestone. Introduced by F. M. Nevins, Selma.

Levy's Late; syn. *Henrietta* (District of Columbia).—Above average size, yellow flesh, red cheek; late; clingstone.

Bilyew's Late October.—"Large; greenish white with red cheek; flesh whitish, freestone; tree a rapid grower and attains great size; prolific bearer; fruit ships well, and where it will mature no peach can take its place; does particularly well in the foot-hills."—*P. W. Butler*.

Decker (California).—Grown for eastern shipment, in Vaca Valley, and in Sutter and Butte Counties.

DATES OF RIPENING OF LEADING VARIETIES.

The relative ripening of a large number of peach varieties, as noted at the University Experiment Station, near Pomona, will be useful to planters in determining proper succession of varieties.

VARIETY.	First flower.	Full flower.	Ripe.
Briggs' Red May	March 4	March 24	June 16
Amsden's June.....	March 8	March 25	June 17
Alexander.....	March 17	March 31	June 17
Large Early York	March 4	March 18	July 15
Yellow St. John	March 4	March 12	July 17
Crawford's Early	March 2	March 15	July 21
Foster	March 4	March 15	July 21
Oldmixon Free.....	March 7	March 18	July 25
Morris White.....	March 4	March 15	Aug. 3
Muir	March 8	March 23	Aug. 5
Susquehanna	March 4	March 14	Aug. 5
Crawford's Late.....	March 2	March 14	Aug. 8
Newhall.....	March 4	March 14	Aug. 8
Runyon's Orange Cling.....	March 2	March 14	Aug. 8
California Cling.....	March 2	March 16	Aug. 12
Stump the World.....	March 2	March 16	Aug. 12
Lovell	Feb. 28	March 9	Aug. 13
Nichols' Orange Cling	March 4	March 14	Aug. 14
Seller's Cling.....	March 2	March 14	Aug. 14
McDevitt's Cling.....	March 2	March 18	Aug. 16
McKevitt's Cling	March 2	March 19	Aug. 19
Wilkins' Cling.....	March 3	March 14	Aug. 20
Indian Blood.....	March 5	March 25	Aug. 20
Yellow Tuscany Cling	March 5	March 19	Aug. 21
Lemon Cling	March 14	April 1	Aug. 21
Smock's Late Free	March 4	March 18	Aug. 28
Picquet's Late	March 5	March 18	Sept. 1
Staley's California.....	March 2	March 15	Sept. 6
Henrietta.....	March 6	March 15	Sept. 15
Heath's Cling	March 7	March 14	Sept. 15
Salway.....	March 7	March 9	Sept. 18

CHAPTER XX.

THE NECTARINE.

The nectarine reaches perfection under California conditions, as does its close relative, the peach. The fruit is, in fact, as Downing says, only a variety of the peach with a smooth skin; only a distinct, accidental variety of the peach; and this is rendered quite certain, since there are several well-known examples on record of both peaches and nectarines having been produced on the same branch. Nectarine pits usually produce nectarines again, but they occasionally produce peaches. Peach seeds occasionally produce nectarines; the Boston variety originated from a peach stone.* All these facts which are recorded of the relation between the peach and nectarine have been verified by California observation.

The practise of growing nectarines is also exactly like that employed with the peach. It is propagated and pruned in the same ways, except that, as pointed out by Mr. Culbertson, the nectarine has more of a tendency to form short interior growths, and fruit buds are formed on the larger new growths, thus enabling the pruner to cut them back more closely, and yet have an abundance of fruit buds remain. The peach and nectarines are the same in natural adaptations and requirements, and in diseases, so that what has been given concerning the growth of the peach in this State has an apt application in the case of the nectarine.

The success of the nectarine worked on almond stock, as has been demonstrated by the experience of many, has led to the grafting over a good many unprofitable almond trees to nectarine, though this has not been done to the extent to which the French prune and some other plums have been worked on old almond stocks.

Comparative Production of Nectarine and Peach.—It may be wondered, considering the similarity of the peach and the nectarine, why the former is our leading fruit and the latter is the least grown, but one, of all the temperate zone fruits, only the lowly quince being less in importance. The explanation is that

* "Downing's Fruit and Fruit Trees," p. 565.

the fruit buyer, both in California and at the East, prefers the peach, whether it be fresh, or canned, or dried, and some of those who have tried even a few acres of nectarines have found many occasions to wish the ground had been given to peaches. How much of this preference is due to lack of knowledge of the nectarine, and how much to its somewhat different flavor, it would be difficult to accurately determine.

It is altogether probable that the nectarine will advance in popular favor. This has been prophesied for some years, it is true, the expectation being based upon the wonderful excellence of the nectarine as grown in our interior valleys, and the passing beauty of the amber translucency of the dried nectarine, both when sun-dried in the interior, and when produced by machine evaporators. The excellence of the canned nectarine has also figured in the anticipation. It must, however, be acknowledged that anticipation has not yet been largely realized, for it is estimated that the amount of dried nectarines is but five per cent, and of canned nectarines considerably less than two per cent, of the respective forms of peaches. Nor does the demand call for change in this proportion, for there is a slight advantage in the market value of the peach even in its great preponderance of supply. Still there are many who are very confident that it will in the future rank much higher in the California fruit product. It would please growers and fruit driers and canners to popularize the nectarine, for its smooth skin makes it as easy to handle as an apricot, and the beauty of the product, which certainly exceeds that of the peach, and is rather more easily attained, is very gratifying to the producer.

VARIETIES OF THE NECTARINE.

Varieties of the nectarine, as of the peach, show different local adaptations, and are valued by growers accordingly. The varieties grown are, however, comparatively few. The following have been found most satisfactory in California; the descriptions are somewhat condensed from Downing's treatise, modified to suit local growth, and arranged approximately in the order of the ripening of the varieties:—

Advance.—Large, round, green, marked with red and brown; flesh greenish white; rich and well flavored. The earliest to ripen.

Lord Napier (English).—Large, pale cream color with dark red cheek; flesh white, melting, tender and juicy, separating freely from stone; leaf glands reniform and flowers large. Especially commended as a heavy and regular bearer; pronounced best in flavor at Pomona Experiment Station.

Downton (English).—Leaves with reniform glands; flowers small; fruit large, roundish oval; skin pale green, with deep violet red cheek; flesh pale green, slightly red at the stone, which is free, melting, rich, and very good.

Early Newington (English).—Leaves serrated without glands, flowers large; fruit large, roundish ovate, a little enlarged on one side, and termi-

nating with an acute, swollen point; skin pale green, but nearly covered with bright red and coated with thin bloom; flesh greenish white, but deep red at stone, which adheres closely, juicy, sugary, rich, and excellent.

Hardwicke (English).—Leaves with globose glands; fruit very large, roundish, inclining to oval; skin pale green, with deep violet red cheek; flesh pale green, slightly marked with red at the stone, melting, rich, and high-flavored; freestone. This variety is a favorite in southern California; described by the Southern California Nurserymen's Association as being the only satisfactory bearer.

Boston.—Raised from a peach stone by T. Lewis, of Boston; tree hardy and productive; leaves with globose glands; flowers small; fruit large and handsome, roundish oval, bright yellow, with deep red cheek; flesh yellow to the stone (which is small and pointed), sweet, though not rich, with pleasant and peculiar flavor; freestone; a general favorite in California.

New White; syn. *Large White*.—Leaves with reniform glands; flowers large; fruit rather large, nearly round; skin white with occasionally slight tinge of red; flesh white, tender, very juicy, with rich, vinous flavor; stone small and free; commended wherever nectarines are grown in California, and more freely planted than all other nectarines combined.

Stanwick.—Originated in England from seed brought from Syria. Large, roundish oval, slightly heart-shaped at base; skin pale, greenish white, shaded into deep, rich violet in the sun; flesh white, tender, juicy, rich, sugary, and delicious.

Humboldt.—Very large, bright orange yellow vigorously marked with crimson, flesh orange, tender; juicy, and high flavored. Described as one of the best of the newer varieties. Ripens late.

As the future for the nectarine seems to rest upon drying and canning of the fruit, the light-skinned, white or yellow-fleshed varieties without color at the stone, are most desirable. For drying there has been thus far a decided preference for free-stone varieties, though possibly the present popularity of cling peaches for drying may extend to the clingstone nectarines. Much color, however, either in skin or flesh, will prevent the production of the beautiful translucent, amber hue of the dried nectarine, which is attractive to consumers. Color in the flesh is, of course, undesirable in canning, because of discoloration of the syrup. These facts have had much to do in fixing the popularity of the varieties named in the foregoing list.

At present the largest orchards of nectarines are in interior valley locations, which are also fine peach counties and are perfectly adapted both to the growing of the fruit and to the open-air, sun-drying of it.

CHAPTER XXI.

THE PEAR.

The oldest deciduous fruit trees in California are pear trees, as has already been stated in the account of fruits at the old missions, and some of the trees are still bearing, though it is a century and a quarter since their planting. The pear withstands neglect and thrives in soils and situations which other fruit trees would rebel against. It defies drouth and excessive moisture, and patiently proceeds with its fruitage, even when the soil is trampled almost to rocky hardness by cattle, carrying its fruit and foliage aloft above their reach. And yet the pear repays care and good treatment, and receives them from California growers, for the pear is one of our most profitable fruits. It is in demand for canning, for drying, and for distant shipment, and its long season and the slow ripening after picking allow deliberation in marketing, and admit of enjoying low rates for shipment by slow trains. The pear has not the beauty of the peach, nor is its handling characterized by so much dash and spirit, but the production of favorite market varieties at a time when the market welcomes them, is about as well repaid as any effort of the California fruit grower.

The most obvious marks of the California pear are size and beauty. The most conspicuous example is the Bartlett, which is *the* pear of California, judged by its popularity, fresh, canned and dried. When well grown, its size is grand, and its delicate color, aroma, and richness unsurpassed. What extreme in point of size has been reached is not known to the writer, but he saw at the San Jose Horticultural Fair, of 1886, thirteen Bartlett pears grown by A. Block, of Santa Clara, which weighed fourteen pounds, the heaviest of the group weighing twenty-two and one-half ounces. Other pears have made standard sizes in California far in advance of their records elsewhere. There was in 1870 a Pound pear sent from Sacramento to the late Marshall P. Wilder, president of the American Pomological Society, which weighed four pounds nine ounces, and was reported by



Two-thirds of natural size.

THE WINTER BARTLETT PEAR: GROWN BY G. C. ROEDING, OF FRESNO.

See page 250.

Originated at Eugene, Oregon, about 1870; resembles Bartlett in appearance; smooth, with brown dots; tender, juicy and melting; flavor like Winter Nelis; very late; believed to be of much value for late shipping.

Colonel Wilder to be larger than anything previously recorded in pear annals.* Notes kept by the writer include five Vicar of Winkfields weighing four pounds eight ounces; nine Easter Beurre weighing twenty-four and one-half pounds, the heaviest single specimen weighing two and three-fourths pounds; thirty-five Beurre Clairgeau weighing thirty-seven pounds, the heaviest one, nineteen ounces; Seckel pears, nine and three-fourths inches in circumference—Downing's figures make the Seckel five and seven-eighths inches around.

LOCALITIES FOR THE PEAR.

The pear has a wider range than the apple in local adaptations. It does as well as the apple in the coast regions, if suitable varieties are grown; it thrives far better than the apple in the interior valleys; it rivals the apple in the ascent of the slope of the Sierra Nevada, and gains from the altitude, color and late keeping, as does the apple. By rejecting a few naturally tender varieties, or by proper protection against the scab fungus (*fusicladium dendriticum*), in regions where its attacks are severe, one can grow pears almost everywhere in California.

The choice of location is governed more by commercial considerations than by natural phenomena. The same facts which make the Bartlett the favorite variety with planters, also should regulate the choice of locality for growing it. These facts were expressed by the late C. W. Reed, of Sacramento, one of the leading pear growers and shippers of the State, as follows:—

In the Sacramento Valley proper there is but one variety of pear that will justify extensive cultivation, viz., the Bartlett. While nearly all varieties may be grown successfully, and many varieties may be desirable for home purposes, yet for profitable orchards we have to confine ourselves to this one variety, except in high altitudes, or localities where the fruit only matures very late. The reason for this will be better understood by the inexperienced if exp'ained. The Bartlett pear having qualities that make it a universal favorite for shipping, canning, and for domestic market, no other variety is wanted while it is obtainable. With the difference in the time of its ripening in different localities that are adjacent, our markets are supplied with this variety about four months each season, viz., July, August, September, and October. While this pear is in the markets, any other variety to compete with it must sell at very low prices. It is not only the great demand the Bartlett pear has over the other varieties in the markets, but as a healthy grower and regular bearer it has no equal. In the higher altitudes, where pears will keep till the Bartlett has disappeared, other varieties may be quite profitable, although they can never be grown to any similar extent.

Of course experienced pear growers, whose taste would soon cloy with a continuous diet of Bartletts, and who know fully the superior quality of other varieties which ripen soon

* Tillon's *Journal of Horticulture*, March, 1871, p. 87. An engraving of this fruit, natural size, was given in *Pacific Rural Press*, Nov. 8, 1873.

after it, would dispute the position taken by Mr. Reed, but for present California taste and trade he is undoubtedly correct. As the canners and shippers and local consumers all call for Bartletts, and as they usually sell at the East for nearly twice the price of other varieties, the choice of location to secure a Bartlett, either very early or very late, is the part of wisdom, for either end of the season usually yields better prices than the middle. Some growers are even opening the Bartlett season by growing Clapp's Favorite, which sells well because it is taken for a Bartlett, and closing the season with the Winter Bartlett, a local variety recently introduced. The earliest Bartletts come from the interior valley; the next, from the valleys adjacent to the bay of San Francisco; the next, from the higher foot-hills of the Sierra Nevada; and the last, so far as present experience goes, although some coast and mountain situations are quite late, reach the market from the Vacaville district. It is an interesting fact that this district, which has long been famous for marketing the first early fruits, should also market very late ones. It is true, however, that early fruits hasten to maturity and late fruits are retarded. Late fruits push along until about midsummer, then stop growing for a month or two during the hottest weather, and afterwards proceed on their course and finish up well. W. W. Smith, of Vaca Valley, has picked Bartletts as late as November 19, but that is unusually late. In years with heavy late spring rains the Bartlett ripens earlier in the Vaca Valley than in ordinary seasons, and when the fruit sells well in the East, the Bartletts are gathered green and shipped all through the season, as their first growth usually makes them large enough for this purpose.

Though the Bartlett is in wide favor, as stated, there is some progress being made in introducing other varieties, as will be stated in connection with the discussion of the adaptations of varieties. This substitution of other sorts is in part because the merit of others is being recognized, and in part because in some regions some of them are healthier and more trustworthy bearers than the Bartlett.

There is produced in some situations a "second crop" of Bartletts which is of account, the bloom appearing upon the tips of the shoots of the current season's growth.

SOILS FOR THE PEAR.

The pear will generally do well on shallow soil and over a tight, clay hard-pan, where most other fruits would be unsatisfactory or fail utterly. The trees will thrive in clay loams, and even in adobe, if properly cultivated. In laying out fruit farms, which often include a variety of soils, even in comparatively small area, the pears and plums (if on the right stock, as will be

seen) should be set on the lower, moister, stiffer soil, and other fruits on the lighter, warmer, and better-drained portions. The pear, however, enjoys the better situation, though it will thrive on the poorer. The tree seems to attain its greater growth and heaviest bearing on the alluvial soils of the valleys and near the



THE BARTLETT PEAR AS GROWN IN CALIFORNIA.

This is a medium-sized specimen, and was grown by James O'Neil, of Haywards, from a bud brought from original Bartlett stock in Massachusetts.

banks of rivers and streams. All pears will be later in maturing and have better keeping qualities if grown on a clay subsoil. Thus it appears that the pear will flourish whether the water is near or far from the surface. As compared with the apple, it may be said that on wet land the apple tree dies in a few years, or becomes worthless. On dry land it lives longer, but the fruit is small and tasteless, and comparatively worthless. But the pear tree will bear good fruit, under the same conditions, and its market price will average higher than that of the apple.

It has been learned by experience that the pear will flourish on soil somewhat alkaline. At the University Agricultural Experiment Station at Tulare, this subject has been demonstrated in detail. It is shown that though the pear endures a certain amount of alkali its limit of endurance may be often exceeded and there is little warrant to select alkali soil for pears, unless it be to fill a space that would otherwise be vacant in the orchard. If it is not too alkaline the pears will thrive. If gypsum be used in planting, somewhat stronger alkali will be endured than otherwise.

PROPAGATION AND PLANTING.

The use of dwarfing stock for the pear has been nearly abandoned in this State, though in early years the quince was largely used. The most prominent orchard on quince stock is that of A. Block, of Santa Clara, where may be seen dwarf trees set eight feet apart in squares, which are doing exceedingly well under his liberal system of manuring and irrigation. It is quite possible that, at least for gardens, we shall see in the future more use made of dwarf trees, but for commercial orchards there appears no need of dwarfing. It is better to have fewer trees and larger ones.

The following varieties are commended for cultivation on quince stock as dwarfs, experience proving them vigorous growers and abundant bearers in suitable localities: Bartlett, Beurre Hardy, Doyenne du Comice, Duchess d'Angouleme, Beurre Diel, White Doyenne, Easter Buerre, Winter Nelis, Emile d'Heyst, P. Barry.*

But, the pear is usually grown in California on its own roots. It comes into bearing early enough, and is a long-lived tree. Trees are grown by either budding or grafting, as described in the chapter on that subject. Only good seedling roots should be used, and not suckers from old trees. The Japanese stock, so called, being seedlings of the Sand pear, of Asia, has been used to some extent by our tree growers.

* Catalogue California Nursery Co.

Distance in Planting.—If the pears are to have the whole ground, it is usual to plant from twenty to twenty-four feet apart on the square. As the tree is slower to attain size and full bearing than the stone fruits, and as it is a long-lived tree, the pears are sometimes set twenty-four feet with plums in quincunx. Peaches and apricots are also set between pears sometimes, when the soil chosen for pears suits them also.

PRUNING.

Usually the pear is grown in the vase form, as described in the general chapter on pruning. With regular, upright growers, heading low and cutting to outside buds results in a handsome, gently-spreading top, and effectually curbs the disposition which some varieties, notably the Bartlett, have to run straight up with main branches crowded together. The accompanying engravings show how a vase-form tree is developed from an up-

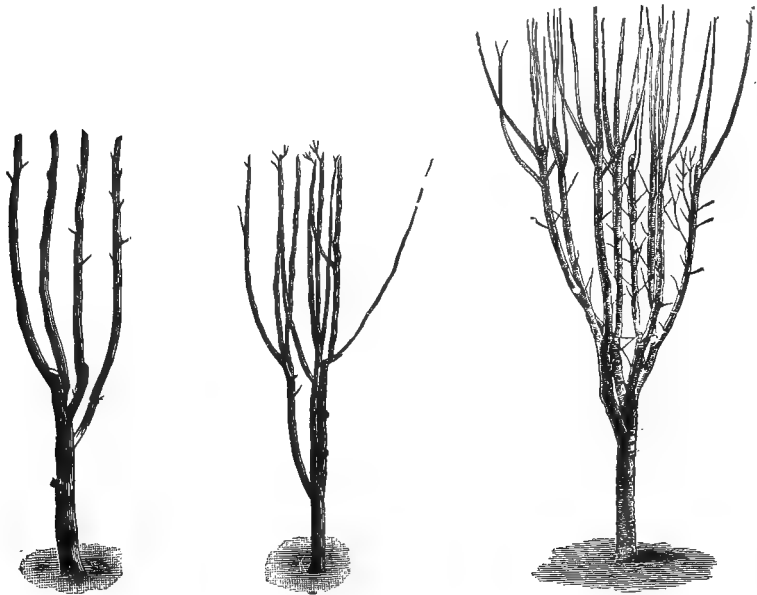

Bartlett Pear after First, Second and Third Winter Pruning.

right grower like the Bartlett, from an unbranched yearling cut back to about eighteen inches. A longer stem and more widely-spaced branches would be better, but the pear stands crowded branches better than other trees because of the strength of the wood. The engravings do not show relative sizes of the trees but merely the method of branching.

As with other fruit trees, the pear must be studied and pruning must be done with an understanding of the habit of the variety under treatment. Irregular and wayward growers, which, in windy places, also have their rambling disposition promoted by prevailing winds, often give the grower much perplexity. The general rules of cutting to an outside bud to spread the tree, to an inside bud to raise and concentrate it, and to an outside bud one year and an inside bud the next, if a limb is desired to continue in a certain course, are all helpful to the pruner. But with some pears, of which the Winter Nelis is a conspicuous example, it is exceedingly hard to shape the tree by these general rules, and some growers abandon all rules, merely shortening in where too great extension is seen, or to facilitate cultivation, and trust to shaping the tree when it shall have finished its rampant growing period. It will be interesting to cite a few methods of California pear growers:—

“The Winter Nelis pear is an uncouth grower. Let the trees alone until they have borne a good, heavy crop, and the limbs come down and spread out nicely; this will occur in five or six years after setting. This will give you an idea what you want to do with the balance of the top that is not borne down with fruit. My plan is to cut straggling branches, thin out so that the branches will not wind around each other, but don't cut the top, for you will find that the more you cut the more wood you get, and after the tree comes into full bearing is plenty time to head back.”—*A. Cadwell, Petaluma.*

“Our orchard is not in a very windy place, but still it is windy enough to throw our Nelis trees out of form. To get any regularity of shape, we cut off every year all the shoots growing low down on the leeward side, shortening in what are left as occasion may require, to an inside bud. On the windward side we rarely cut any branch out, but shorten in a little to an outside bud, frequently being obliged to cut back a strong shoot to a lateral which is growing outward.”—*Leonard Coates, Napa.*

“It is hard to get a misshapen Winter Nelis tree into shape. Let the grower take his shears and go around the tree and examine the difficulty until he is conversant with it, and then commence to prune, not too heavily though. Cut the limbs that lean too far ‘leewards’ back a little with an inside bud, and train all future limbs toward the weather side of the tree; cut the limbs this year so the coming buds will form limbs growing in the direction of the weather side of the tree. But use moderation and take your time for it, and don't cut too many big limbs off three-year-old trees—none, in fact, if it can be helped. In bringing limbs to proper place, I have found a piece of corn-stalk the required length for the intended place, inserted endwise between the limb and the body of the tree to be spread, to be a very good brace, easily made, and not likely to injure the tree.”—*T. E. Owen, Santa Cruz.*

These methods will suggest others by which one can bring the most irregular grower into shape. If the tree is cut at planting so as to form the head low, it may be safely left until bearing age for shaping. The tree naturally makes a viny growth of young wood, and the object of leaving it alone is that one limb holds the other more upright until the main limbs

become large, or stiff enough to keep the shape; so they may be left, after being thinned out to form three to five limbs, as judgment may direct. Some trees will be best with three or four, others five.

The experience of pear pruning just cited has been secured in regions more or less subject to coast influences. In the hot interior valleys, with the pear as with the apple, care must be taken to prune so as not to open the tree too much to the sun, but to shorten in and thin out only so far as is consistent with maintaining a good covering of foliage.

The pruning of bearing pear trees is much like that of the apple, to be determined largely by the habit of the tree, and to secure a fair amount of fruit on branches with strength and stiffness enough to sustain it.

Summer pruning will promote fruiting either in a young or an old tree and some practise it to secure early bearing of young trees, but the common practise is winter pruning to secure strong wood and prevent overbearing.

THINNING PEARS.

It is quite important to attend to thinning the fruit on overloaded trees. Even the popular Bartlett will often give fruit too small for profitable sale, unless thinned. With pears, as other fruits, thinning should not be done until it is seen that the fruit is well set. Dropping off from natural causes sometimes thins the crop quite enough.

IRRIGATION OF THE PEAR.

In some situations the pear needs irrigation, though it will endure drouth which would destroy most other fruit trees. There is no profit in small, tough fruit. As stated in the chapter of irrigation the wood growth and fruit show whether proper moisture needs are met or not. Early pears are advanced in development by irrigation in some parts of the State, and this is an important factor in their value.

BLIGHT OF THE PEAR.

There are blights of the pear occasionally occurring in this State which are not yet fully understood, nor has their identity with the well-known Eastern blights been fully determined, though some growers claim to have recognized characteristic Eastern forms. They exhibit their presence by spots and streaks of dead bark. They are apparently of different origin; probably both bacterial and fungoid. The organisms have not, however, been definitely determined as yet. These diseases make their

spread in the winter and enlarge very rapidly to a certain limit and there stop for the season, proceeding or advancing from new centers the next year. They occur in some parts of the interior valley in ruinous amount and grow much more slowly near the coast. Cutting back where the disease occurs on the smaller limbs has measurably checked the trouble, but not by any means put an end to it. No satisfactory treatment has been demonstrated, but the use of strong Bordeaux Mixture in the autumn on the trunk and larger branches has been used to some extent and some have pronounced such application beneficial at least in reducing the speed of the disease.

The scab fungus which seriously affects some varieties, and notably the Winter Nelis, in the coast region, is identical with the scab of the apple and will be mentioned in the chapter on tree diseases. Because of the liability of the Winter Nelis to this disease, and because of its irregular bearing in the coast region, there have been many trees grafted over into varieties better suited to coast conditions. The Beurre Clairgeau, because of its health, prolific bearing, and acceptability to shippers, was largely introduced in this way, but it has not sold as well as expected. Ordinary top grafting succeeds admirably with the pear. Clapp's Favorite and other varieties have also been worked upon Winter Nelis.

GATHERING AND RIPENING OF PEARS.

Many pear growers make the common mistake of allowing the fruit to hang too long on the tree, instead of gathering and ripening in a cool, dark place. Pears should be picked at the first indication of ripeness, the first sign being a tendency of the stem to part from the spur when the pear is gently raised up. This test applies especially to the Bartlett. Picking at this stage and laying away in the dark ripens up the Bartlett well. When picked at this stage and sent overland by slow freight, they ripen *en route* and the boxes open well on the Eastern markets. There are a few varieties which shrivel if ripened under cover, but the rule is a good one, and the grower will soon note the exceptions. Many desirable varieties have, no doubt, been pronounced poor and insipid because allowed to ripen on the tree.

To ripen well, pears should be packed in tight boxes or inclosed in drawers. They do not do as well as apples on shelves open to circulation of air. As already stated, the oily-skinned apple endures exposure and maintains a smooth, ruddy cheek and sound heart in spite of wind, rain, and rough weather. The pear, under similar conditions, decays rapidly.

PEAR VARIETIES APPROVED BY CALIFORNIA GROWERS.

VARIETIES.	Upper Coast valleys.	Central Coast valleys.	Interior valley and foot-hill.	Mountain valley and plateaux.	Southern California.
Angouleme, Duchess 'd.	x	x	x	x	x
Anjou.....	xx	x			
Bartlett.....	xx	xx	xx	xx	xx
Bloodgood.....			x		
Bosc.....	x	x	x		
B. S. Fox.....	x	x			
Brandywine.....	x				
Clairgeau.....	xx	xx	xx	x	x
Clapp's Favorite.....	xx		x		xx
Comice.....	xx	xx			
Dana's Hovey.....	xx	xx	xx		
Dearborn.....		x			
Diel.....	x	x			
Easter Beurre.....	xx	xx	x		x
Emile d'Heyst.....	x	x			
Flemish Beauty.....	x	x	x	xx	xx
Glout Morceau.....	xx	x	x		x
Hardy, Beurre.....		xx	xx		
Howell.....	x	x			x
Kieffer.....			x	x	x
Lawson.....			x	x	x
Louise, Bonne de Jersey.	x	x			
Madeleine.....		x	x	x	
Onondaga.....	x	x			
P. Barry.....	xx	x	xx	x	x
Seckel.....	xx	xx	xx	xx	xx
Souv. du Congress.....	x	x	x		
Vicar of Winkfield.....	x	x			
Wilder, Early.....					x
White Doyenne.....	x	x	x		
Winter Bartlett.....	x	x	x		x
Winter Nelis.....	xx	xx	xx	xx	xx

VARIETIES OF THE PEAR.

Though large collections of famous Eastern and European pears have been brought to California, the peculiarity of the local market, and demand for canning and shipping, has led to concentration upon very few sorts. The pears chiefly grown in California are the following, arranged approximately in the order of their ripening:—

Harvest; syn. *Sugar Pear* (American).—Small, roundish, pale yellow, brownish in sun, brown and green dots; flesh whitish, rather dry but sweet; tree upright, young wood olive brown.

Madeleine (French).—Medium, obovate pyriform, stalk long and slender, set on the side of a small swelling; pale yellowish green, rarely brownish blush; calyx small, in shallow, furrowed basin; flesh white, juicy, delicate.

Wilder Early (American).—Small to medium, yellow with red cheek; sweet, and good. Recently introduced and profitable for local sale in San

Diego County. Should not be confused with Col. Wilder, a California seedling which has gone out of use.

Bloodgood (New York).—Tree short, jointed, deep reddish brown wood; fruit medium turbinate, inclining to obovate, thickening abruptly into stalk; yellow, sprinkled with russet dots; calyx strong, open, almost without depression; stalk obliquely inserted, without depression, short, fleshy at its base; flesh yellowish white, melting, sugary, aromatic; core small.

Clapp's Favorite (Massachusetts).—Tree a strong grower; young shoots dark reddish brown; fruit large, slightly obtuse pyriform; pale lemon yellow with brown dots; flesh fine, melting, juicy, with rich, sweet, delicate, vinous flavor; resembles Bartlett, but lacks musky flavor.

Dearborn's Seedling (Massachusetts).—Young shoots long, reddish brown; under medium size; roundish pyriform; smooth, clear, light yellow, with few minute dots; stalk slender, set with very little depression; calyx spreading in shallow basin; flesh white, very juicy, melting, sprightly.

Lawson; syn. *Comet* (New York).—Medium to large, bright crimson on yellow ground; flesh fine, rich and sweet.

Souvenir du Congress (French).—Large to very large (exceeding Bartlett and Clapp's Favorite, to both of which it bears strong resemblance); skin smooth, bright yellow when fully ripe, brilliant carmine in the sun; flesh resembling Bartlett, but has not the musky flavor; firm to the core; tree a good grower, but somewhat subject to smut.

Bartlett (English).—Tree a strong grower, early bearer, and healthy; fruit large, smooth, clear yellow, sometimes with delicate blush; stalk moderately long, stout and inserted in shallow cavity; calyx open; flesh white, fine grained, juicy, buttery, highly perfumed (musky), vinous flavor.

Beurre Hardy.—Large, long obovate, sometimes obscurely pyriform; skin greenish with thin, brown russet; stalk an inch long; cavity small, uneven, oblique, basin shallow; buttery, somewhat melting, rich, slightly subacid; tree a strong grower.

Flemish Beauty (Belgian).—Large, obovate, often obscurely tapering to the crown, very obtuse, surface slightly rough, with some reddish brown russet on pale yellow ground; flesh juicy, melting, and good if picked early and ripened in the house.

Seckel (Pennsylvania).—Rather small, regularly formed, obovate; brownish green, becoming dull yellowish brown, with russet red cheek; stalk slightly curved, and set in a trifling depression; calyx small and set in a very slight depression; flesh whitish, buttery, very juicy and melting, with peculiarly rich, spicy flavor and aroma.

Howell (Connecticut).—Rather large, roundish pyriform, light waxen yellow, often with finely-shaded cheek thickly sprinkled with minute russet dots and some russet patches; stalk medium, without cavity and sometimes lipped; sometimes in small cavity; calyx open in large, uneven basin; flesh whitish, juicy, brisk, vinous.

Duchess d' Angouleme (France).—Very large, oblong obovate; somewhat uneven, knobby surface; dull greenish yellow, streaked and spotted with russet; stalk long, stout, bent, deeply set in irregular cavity; calyx set in somewhat knobby basin; flesh white, buttery, and juicy, with rich flavor.

Louise Bonne of Jersey (France).—Large oblong pyriform, a little one-sided; glassy, pale green in shade, brownish red in the sun, numerous gray dots; stalk curved, rather obliquely inserted, without depression, or with a fleshy, enlarged base; calyx open in a shallow uneven basin; flesh very juicy, and melting, rich, and excellent; very prolific.

Beurre Diel (Belgium).—Large, varying from obovate to obtuse pyriform; skin rather thick, lemon yellow, becoming orange yellow, marked with large brown dots and marblings of russet; stalk stout, curved in rather uneven cavity; calyx nearly closed, in slightly furrowed basin; flesh yellow-

ish white, a little coarse-grained near the core; rich, sugary, buttery, delicious.

White Doyenné; syn. *Virgalieu* (France).—Medium to large, regular, obovate; smooth, clear, pale yellow, sprinkled with small dots, sometimes red cheeked; stalk brown, little curved, in small round cavity; calyx small, closed in shallow basin; flesh white, fine-grained, buttery, rich, and high flavored.

Beurre Bosc (Belgium).—Large pyriform, a little uneven, often tapering long and gradually into the stalk; skin pretty smooth, dark yellow, dots and streaks of cinnamon russet, slightly red on one side; stalk long, rather slender, curved; calyx short, in shallow basin; flesh white, melting, buttery, rich, with slightly perfumed flavor.

Onondaga; syn. *Swan's Orange* (Connecticut).—Large, obtuse, oval pyriform, neck very short and obtuse, body large and tapering to obtuse apex; flesh melting, sprightly, vinous. A vigorous, upright grower, healthy; yellow shoots; sells well in distant markets.

Beurre Clairgeau (France).—Large, pyriform, but with unequal sides; yellow, shaded with orange and crimson, thickly covered with russet dots, sometimes sprinkled with russet; stalk short, stout and fleshy, inserted by a lip at an inclination almost without depression; when lip is absent, the cavity is uneven; calyx open; flesh yellowish, buttery, juicy, granular, sugary, perfumed, vinous. A popular variety for local and distant markets.

Beurre d'Anjou (France).—Large, obtuse pyriform; stem short, thick, and fleshy, in a cavity, surrounded by russet; calyx small, open in small cavity, russeted; skin greenish, sprinkled with russet, sometimes shaded with dull crimson, brown and crimson dots; flesh whitish, not very fine, melting, juicy, brisk, vinous flavor, perfumed; tree a fair grower, but somewhat affected by fungus.

Dana's Hovey; syn. *Winter Seckel* (Massachusetts).—Small, obovate, obtuse pyriform; greenish yellow or pale yellow, with much russet and brown dots; stalk rather short; a little curved, set in slight cavity, sometimes lipped; calyx open and basin small; flesh yellowish, juicy, melting, sweet, aromatic.

Vicar of Winkfield (France).—Large and long pyriform; pale yellow, fair and smooth, sometimes with brownish cheek and marked with small brown dots; stalk slender, obliquely inserted without depression; calyx large, open, set in a basin very slightly sunk; flesh greenish yellow, juicy, with good sprightly flavor.

Doyenné du Comice (France).—Large, varying, roundish pyriform, or broad, obtuse pyriform; greenish yellow becoming fine yellow, shaded with crimson, slightly marked with russet spots, and thickly sprinkled with russet dots; stalk short, stout, inclined and set in shallow cavity, often russeted; calyx small, open; basin large, deep, and uneven; flesh white, fine, melting, aromatic.

Glout Morceau (Flemish). "Rather large, varying in form, but usually short pyriform, approaching obtuse oval; neck very short and obtuse; body large and tapering towards the crown; often considerably ribbed; green, becoming pale greenish yellow; stalk stout, moderately sunk; calyx large; basin distinct, rather irregular; flesh white, fine-grained, buttery, melting, rich, sweet, and of fine flavor."—*J. J. Thomas*.

Block's Acme (California seedling, by A. Block, of Santa Clara).—Large and very handsome, surpassing *Beurre Clairgeau* in size and color; regularly formed, pyriform, skin pale yellow, covered with russet all over, which becomes a fine glowing red on the side exposed to the sun; flesh white, crisp, and melting, juicy, sweet, and slightly musky; a pear that will rank foremost with our best shipping pears.

Winter Nelis (Belgium).—Medium, roundish, obovate, narrowed in near the stalk; yellowish green, dotted with gray russet and a good deal

the seed of the Myrobalan vary as do other fruit seedlings, both in fruit and in foliage and habit of trees, and perhaps this fact has given rise to the distinction between "true" and "false" Myrobalan, so called. Practise has proceeded without much reference to the discussion, and whether grown here, from seed of trees imported long ago, or from cuttings of the same, or whether seedling stocks are imported directly from France, as large quantities are, the Myrobalan of French origin is now the accepted plum stock for California, except in light, alluvial, well-drained soils, where, for the French prune, peach or almond may be preferred. The Myrobalan has largely displaced the St. Julian and the Mirabelle, as well as the peach. Though described by some authorities as a dwarfing stock, it is found to be sufficiently free growing in California to suit all purposes, and to form a good foundation for full standard trees, though the peach and almond roots in proper soils give a quicker and greater growth.

Experience has shown that the Myrobalan stock thrives in this State both in low, moist, valley lands, in comparatively dry lands, and in stiff upland soils. Thus it has come to be accepted as an all-around stock for the plum.

In some soils especially adapted to the peach, peach roots are preferred as stocks for the French prune, but, as already said, all plums can not be worked directly on the peach root, the Robe de Sergeant, Columbia, Yellow Egg, and Washington, for example. Sometimes the bud or scion may make a large growth, but the two woods do not unite, and the trees break off sooner or later.

Some work the plum on the apricot root, and report success when the soil suits the apricot root, and the gophers do not get at it. But it sometimes happens that the French prune parts from the apricot root even after growing some time upon it. There are, however, instances of the French prune thriving, and, apparently making good union with the apricot root.

Some plums do well on the almond root and some do not. The French prune succeeds admirably both when worked on young almond stocks and top grafted in old almond trees. Success is also reported with the Fellenberg on the almond. But the almond root is suited especially for warm, dry soils. Excellent results from the use of almond stock are reported from the interior valley and the Sierra foot-hills.

Propagating by Sprouts.—The French practise of growing certain varieties of the plum by means of sprouts from the base of old trees has been successfully followed in this State by Felix Gillet, of Nevada City, and is strongly commended by him as securing a tree which will not gum, which is one of the reasons

why the same practise prevails in France. This practise is as follows:—

Sprouts growing at the foot of old and large trees, and but few are found to each tree, are taken off and planted close together in a bed to make them root well, and the ensuing spring planted in nursery rows, where they are trained like any other trees, and transplanted where to remain, when branched.

For this method it is necessary that the parent tree should be upon its own roots, else one is apt to get suckers from a wild stock.

PLANTING AND PRUNING.

As with other trees, there is difference of opinion as to the best distance apart for plum trees. The present tendency is toward wider planting; not nearer than twenty feet is the usual advice, and on rich land, twenty-two or twenty-four feet is better.

The plum, in California, is a most rapid grower; six to ten feet from the bud or graft in a season, and about as much after the first winter's cutting back, is not at all unusual. At this rate of progress, then, the tree soon runs up and away, in a spindling, sprawling fashion, unless severely cut back for the first few years. Neglected trees of some varieties show long, streaming branches, arching outward, and exposing the bark to sunburn (to which it is very sensitive), breaking the tree to pieces as the fruit gets weight, and, even if supported by props, breaking off at the bearing of the prop. This condition of the tree can only be obviated by low heading and moderate cutting back each year, with due regard to limiting the amount of bearing wood to get large fruit. For such plum varieties the suggestions on forming the tree and subsequent treatment in the chapter on pruning will be found helpful.

Pruning the French Prune.—During the last few years, growers of the French prune, and other varieties of similar growth, have reached substantial agreement as to the best practise. The old method of cutting back bearing trees has been abandoned by nearly all growers. Cutting back the young tree to secure sufficient low branching is followed by thinning of shoots from this low head so that the tree shall not become too dense or carry too much bearing wood. The strength in the head depends upon proper spacing and arrangement of the branches as insisted upon in the chapter on pruning; and large, well-ripened fruit, which is essential to successful and profitable drying, is conditioned upon avoiding excess of branches and admission of sufficient light to the tree.

A rather longer central stem is retained than in the old style, and a central stem throughout is admissible if one prefers it and does not desire to dispense with it as the first step toward secur-

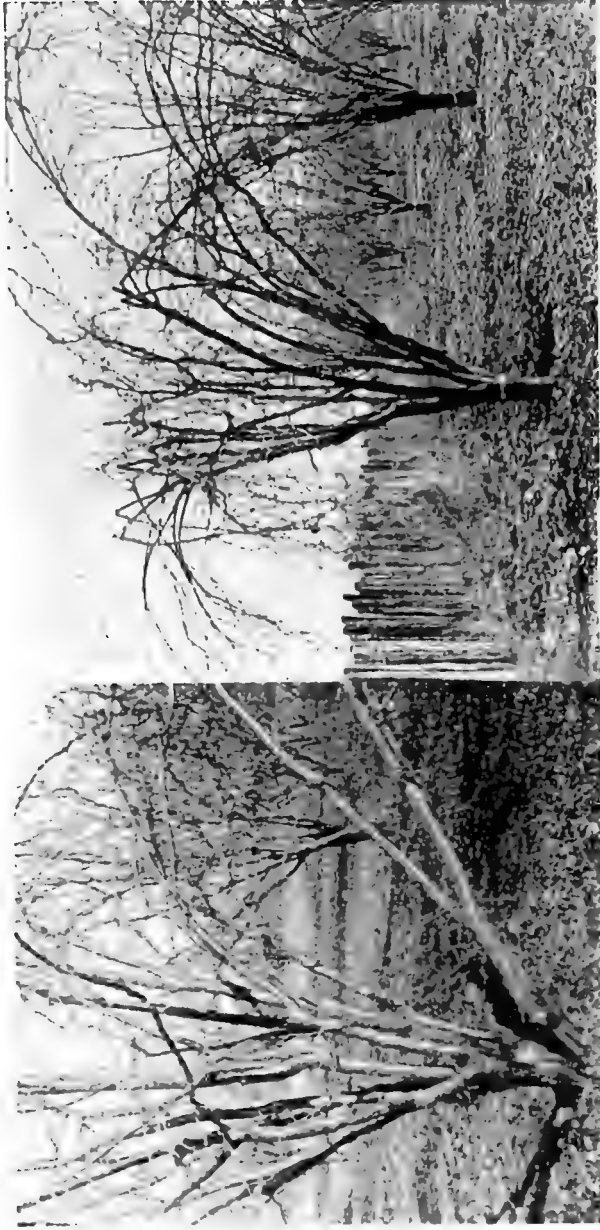

DISASTROUS EFFECTS OF WRONG STARTING AND CUTTING BACK BEARING PRUNE TREES—Photo by Sanders, San Jose.

The first picture shows strikingly the weakness resulting from allowing many branches to grow from adjacent buds at the top of a abort stem, instead of properly spacing them with more room for enlargement and strong attachment. The second picture shows the weakness of young wood, which pushes out rapidly when bearing trees are topped.

ing a more open tree. Some retain the longer stem at planting; others cut back to eighteen inches, develop three side branches upon that and train the branch from the top bud for a lengthening of the stem, and bring out more branches upon that the second year, and then dispense with its farther extension. The accompanying engravings show this method of developing the head of a young French prune. The tree was cut back at planting in orchard to a straight switch about eighteen inches high.

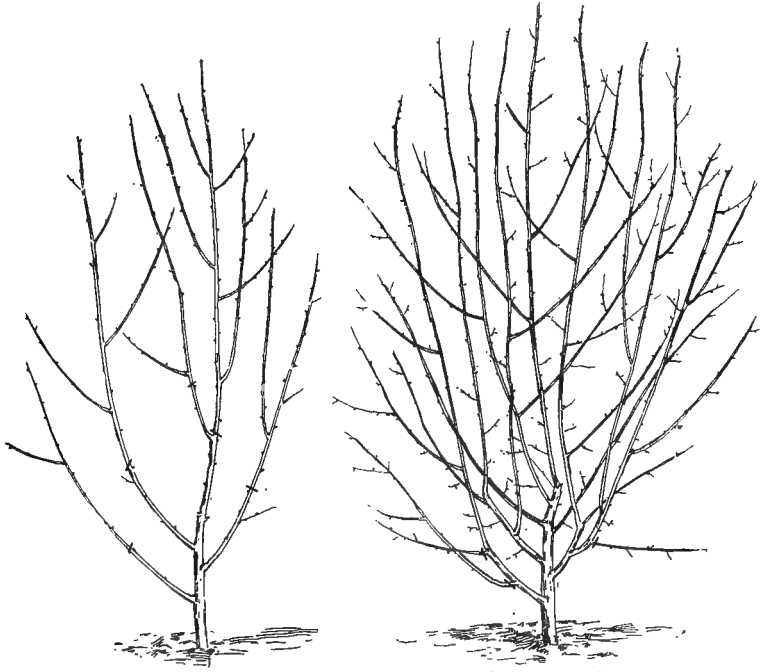

Pruning after first summer's growth in orchard.

Growth during second summer in orchard.

At the end of the first summer this showed the form in the first picture, which is marked for the first winter pruning. The second engraving shows the branching developed from this during the second summer's growth, also marked to prune away some undesirable branches. Upon a tree of this form farther cutting back is not desirable as it has enough well-placed branches to form the tree.

The tree shown in leaf represents the same tree during its third summer's growth and presents a fair idea of a well-shaped young tree, with a good outfit of well-placed branches.

How long cutting back shall continue depends partly upon the locality and partly upon the notion of the owner. In inte-

rior localities the tree grows with great rapidity and branches more freely. During the third summer it will bear some fruit if not cut back the previous winter and, where growth is so rapid, there is little danger of injuring the tree by early bearing. In the coast valleys cutting back may continue another year, and fruiting be thus postponed a year to get another summer's freer wood growth.



French Prune—Second Summer's Form.

Though cutting back may properly cease early with the French prune, it is a great mistake to allow the trees to go unpruned. Removal of defective wood, prevention of branch crowding and overbearing are of the highest importance, as insisted upon in the chapter on pruning.

Special Study of Varieties in Pruning.—The points just advanced apply especially to the management of the French prune. How far other varieties may be benefited by it must be determined by the grower by study of the habit of the variety he has to deal with. The general rules for handling trees with different habits of growth are applicable to a certain extent to the plum. When to apply a rule or make an exception must be learned by observation and experience. Some plums, like the

Silver prune, have something of the growth habit of the peach, and this is also very true of some of the Japanese varieties. Cutting back in winter and pinching in summer are both useful facts in securing lower branching and low-growing fruit spurs.



GOOD FORMS OF YOUNG BEARING PRUNE TREES—By S. P. Sanders, San Jose.

VARIETIES OF PLUMS AND PRUNES.

As with other fruits, comparatively few varieties of the plum are largely grown in California, and the list is continually being reduced. The following tabulation is the result of a very wide inquiry made during the year 1899.

PLUMS AND PRUNES APPROVED BY CALIFORNIA GROWERS.

VARIETIES.	Upper Coast valleys.	Central Coast valleys.	Interior valley and foot-hills.	Mountain valleys and plateaux.	Southern California.
Abundance.....			X		XX
Agen, Prune d'.....	XX	XX	XX	XX	XX
Bradshaw.....	X	X	X	X	
Burbank.....	X	X	XX	X	XX
Clyman.....			XX		
Columbia.....	XX	X	X	XX	X
Damson.....	X	X	X	X	XX
Duane Purple.....		X	X	X	
German Prune.....	X	X	X	X	X
Giant.....		X	X		X
Golden Drop, Coe's.....	XX	XX	X	XX	X
Golden Prune.....	X	X		X	
Green Gage.....		X	X		XX
Imperial Epineuse.....	X	XX	XX		
Italian Prune.....	XX	XX	XX	XX	
Jefferson.....	X	XX	X		X
Kelsey.....	X	X	XX	X	XX
Normand.....		XX			XX
Peach.....	XX	X	XX	XX	
Pond (Hungarian).....	X	XX	XX	XX	X
Red June.....		XX	XX		X
Robe de Sergeant.....		XX	XX		X
Royale Hative.....			XX		X
Satsuma.....	X	X	X		XX
Silver.....		XX	X		X
Simon.....			XX		XX
Tragedy.....		XX	XX		XX
Washington.....	XX	XX	XX	XX	X
Wickson.....	X	XX	XX	X	XX
Yellow Egg.....	XX	XX	XX	XX	X

Simon (*Prunus Simoni*).—Medium to large, roundish, flattened, with cavities at base and apex; brick red, small yellow spots; stalk stout and short; flesh yellow, adhering to flattened pit; largely grown for shipment in early interior regions where it has good quality; lacks flavor near the coast.

Clyman (California seedling introduced by Leonard Coates).—Large, roundish oblong, flattened; suture indistinct; mottled reddish purple, beautiful blue bloom; freestone; flesh firm dry and sweet; prolific; the leading early plum for shipment.

Red June (Japanese).—Medium to large, deep red, flesh light yellow, firm, good quality. The best of the early Japanese plums.

Tragedy (California seedling).—Medium to large, suture shallow, wide and extending beyond apex; dark purple; flesh yellowish green, sweet and

well flavored; freestone. Very valuable for shipping from early regions in all parts of the State.

Abundance (Japanese); syns. *Yellow-fleshed Botan*, *Mikado of Hinclay*.—Large, globular with point at apex; cherry color covered with white bloom; flesh yellow, juicy and rich. Popular for shipment from early regions.

California Red (California seedling).—Introduced by J. T. Bogue, of Marysville. Large, light red, firm flesh and small pit. A good shipping plum.

Peach (French, *prune pêche*).—Very large, roundish oblate, regular, flattened at ends; suture distinct, shallow; color varying from salmon to light brownish red; stalk very short, cavity narrow, shallow, flesh rather coarse, juicy, sprightly, free from the nearly round, very flat, much furrowed stone; shoots smooth. A prominent variety for early eastern shipment.

Royale Hative (French).—Medium roundish, slightly wider at base; light purple, stalk half an inch long, stout, scarcely sunk; flesh amber yellow, with rich, high flavor, nearly free from the small, flattened, ovate stone; shoots very downy. Largely grown as an early market plum and for eastern shipment.



Prunus Simoni.

Bradshaw.—Large, obovate, with obtuse suture on one side, sometimes with very slight neck; dark purple, with light blue bloom; stalk three-fourths inch long; cavity narrow; flesh a little coarse, becoming light brownish purple, at first adhering, but becoming nearly free when fully ripe; juicy, good, slightly acid; tree vigorous; shoots purple, smooth. Reported from Sacramento County as blooming late and seldom injured by frost.

Green Gage (French).—Rather small, round; suture faint green, becoming yellowish green, usually with reddish brown dots and network at base; stalk half to three-fourths inch, scarcely sunk; flesh pale green, melting, juicy, exceedingly rich, and flavor excellent; shoots smooth.

Normand (Japanese).—Medium to large, roundish, golden yellow; fine sprightly flavor even near the coast; tree excellent grower and very prolific and regular bearer; one of the best of the Japanese plums.

Burbank.—Tree imported from Japan by Luther Burbank. Named "Burbank" by Professor Van Deman. Tree usually vigorous, with strong, upright shoots, and large, rather broad leaves; comes into bearing very early. Almost globular, being five and a half inches around horizontally, and five and five-eighths inches around vertically; rich cherry red, slightly mottled with yellow and freely dotted with same tint; flesh deep yellow, juicy, very sweet, and of fine, somewhat peculiar, but very agreeable flavor; pit is very small, three-fourths by a trifle over half an inch in diameter.

Duane's Purple (New York).—Very large, oblong oval, longer on one side; slightly narrowed towards the stalk; reddish purple, bloom lilac; stalk three-fourths inch; slender; cavity narrow; flesh juicy, moderately sweet, and moderate flavor, mostly adhering to stone; shoots very downy and leaves large and downy beneath.

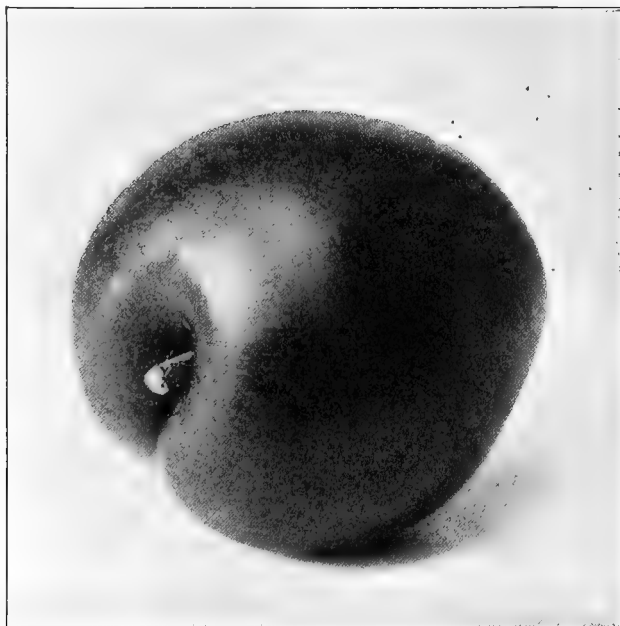

Wickson Plum—Crossbred Japanese.

Washington (New York).—Very large, roundish oval, suture obscure, distinct at base; yellowish green, faintly marbled, often with pale red blush; stalk half to three-fourths inch; slightly downy; cavity wide, shallow; flesh rather firm, sweet, mild, very rich and luscious, free from the pointed stone; shoots downy; very vigorous.

Wickson.—A crossbred by Luther Burbank; form suggests the Kelsey, but more symmetrical; in ripening, the color develops from a deep cherry red down to a rich claret as full ripeness is attained. The color is solid and uniform. The flesh is of amber tint, very juicy and translucent; the pit is small and shapely, the flavor is striking and agreeable, but likely to be deficient near the coast.

Yellow Egg; syns. *White Egg*, *White Magnum Bonum* (English).—Very large, oval, narrow at ends, necked at base, suture distinct; stalk one inch, not sunk, surrounded by fleshy ring at insertion; light yellow, bloom thin, white, flesh firm, rather acid until fully ripe, and then sweet, adheres to the pointed stone.

Prince Engelbert (Belgium).—Large, oblong oval, deep bluish purple, with dense bloom; stalk rather slender, with a fleshy ring at base; cavity rather deep and narrow; flesh juicy, melting, sweet; freestone; shoots downy. Approved in Alameda, Placer and El Dorado Counties.

Jefferson (New York).—Large, oval, base slightly narrowed, suture slight; greenish yellow, becoming golden, with reddish cheek; bloom thin, white; stalk one inch, but little sunk or not at all; flesh rich yellow, very rich, juicy, high flavored and luscious, adheres partly to its long, pointed stone; shoots smooth; tree a slow grower, but productive.

Columbia (New York).—Very large, nearly globular, one side slightly larger; brownish purple, reddish brown where much shaded, with many fawn-colored dots; bloom blue, copious; stalk one inch, rather stout; cavity small; flesh orange, very rich and sweet, free from the stone, which is very small and compressed. Shoots downy, stout, blunt, spreading; leaves nearly round.

Satsuma; syn. *Blood Plum of Satsuma*.—Introduced and first fruited in this country by Luther Burbank, of Santa Rosa. Described by Prof. H. E. Van Deman, U. S. Pomologist, as follows: "Leaves more lanceolate than those of Kelsey; fruit averages about two and a quarter inches in diameter, nearly round, and but slightly sutured on one side; surface dark red, under a thick bloom; dots rather conspicuous and numerous; flesh dark purplish red, which has caused the name of 'Blood Plum of Satsuma' to be given by some; stone very small and pointed."

Red Magnum Bonum; syn. *Red Egg*.—Large, oval, tapering to the stalk; suture strong, one side swollen; deep red in the sun; slight bloom; stalk one inch, slender, cavity narrow; flesh greenish, coarse, subacid; shoots smooth.

Imperial Gage (New York).—Medium size, oval, suture distinct; stalk three-fourths inch, slightly hairy, evenly sunk; green, slightly tinged with yellow, with marbled green stripes; bloom copious and white; flesh greenish, juicy, melting, rich, and delicious, usually free from the oval, pointed stone; tree very vigorous and productive; shoots long, upright, slightly downy; leaves with slight shade of blue. A popular canning variety.

Damson (English).—Small, roundish oval; purple, with thick blue bloom; melting, juicy, subacid.

German Prune (*Common Quetsche*, Germany).—"This name has been applied in this State to numerous plums and prunes which are sold under it. The fruit of the true German prune is long oval, and swollen on one side; skin purple, with thick blue bloom; flesh firm, green, sweet, with a peculiar pleasant flavor; separates readily from the stone."—*John Rock*. Complaint is made in many localities of the tendency of the variety to drop before ripening, almost the whole crop sometimes dropping.

Kelsey Japan.—Trees brought from Japan by the late Mr. Hough, of Vacaville, in 1870, and purchased by the late John Kelsey, of Berkeley, who propagated and fruited them for several years. First wide distribution was made by W. P. Hammon & Co., in 1844, who named the fruit after Mr. Kelsey. The following description is by H. E. Van Deman, U. S. Pomologist, from California and Florida specimens: "Tree upright in growth, leaves narrow, twigs brownish gray. Fruit from one and a half to two and a half inches diameter, heart-shaped, with a distinct suture on one side from stem to apex; stem is short, and set in a depression at the larger end; colors mixed yellow and purple, which vary in depth, but rarely make a brilliant appearance, covered with a bloom; flesh yellow, very firm, and

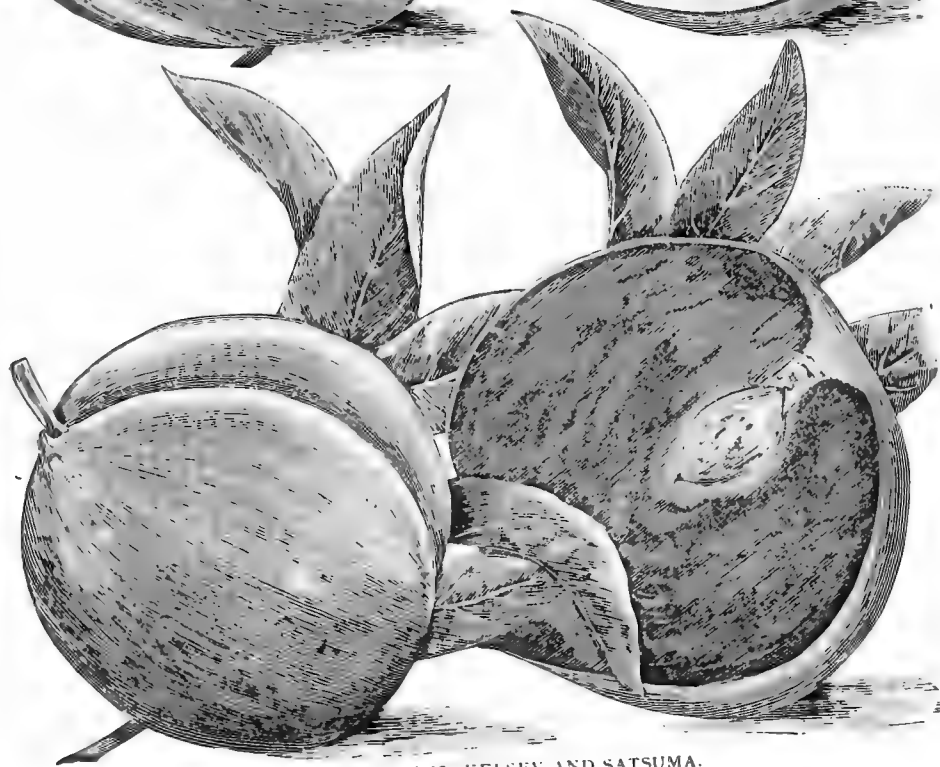

JAPANESE PLUMS—KEISEY AND SATSUMA.

clings to the stone, which is rather small, and nearly always partly surrounded by a cavity; when fully ripe the quality is very good." Very widely grown; is in less favor than formerly in interior valleys where color is not well developed. Where the fruit is of good color it is profitable for shipping and is highly regarded everywhere for domestic use.

Quackenbos (New York).—Large, oblong oval; deep purple; suture faint; stalk short, slightly sunk; slightly coarse, sprightly, sweet and sub-acid; partly freestone.

Victoria (English).—Large, obovate, suture distinct; color a fine light reddish purple; stem half inch, cavity rather deep and narrow; flesh yellow, pleasant; clingstone; next to Pond's Seedling in size, beauty, and productiveness.

Hungarian Prune; *English Pond's Seedling*; *Grosse Prune d'Agen* (English).—This variety was brought to San Jose probably about 1856, and in some unaccountable way was first contrasted with the French prune and called the "great prune of Agen;" afterwards, also in a mysterious way, it took the name "Hungarian prune." It is still marketed by these names both here and at the East. The true name is English Pond's Seedling. Fruit very large, ovate, slightly tapering to stalk; skin thick, reddish violet, with numerous brown dots, and covered with handsome bloom; rather coarse, juicy, sweet; a very showy fruit; tree a strong grower and prolific bearer; fruit has a tendency to double; sells well in local and distant markets on its style.

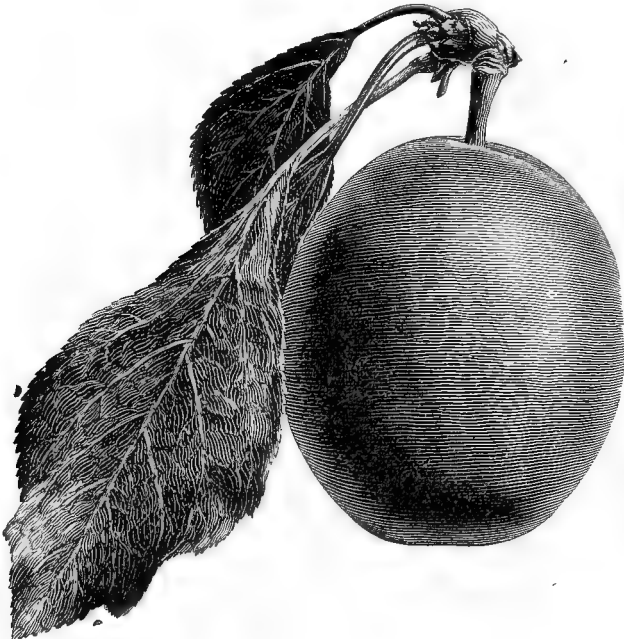

Imperial Epineuse as Grown by John Rock.

Giant.—Burbank seedling; very large, dark crimson upon yellow ground; flesh yellow, flavor good; freestone. A shipping plum, rather disappointing as a drying plum.

Splendor.—Burbank seedling; medium size but larger than French prune; clear red, drying dark, does not shake from the tree; earlier than French prune.

Sugar.—Burbank seedling, introduced in 1898; very large and very early for a prune; sugar in fresh fruit 23.92 per cent; very promising.

Imperial Epineuse; syn. *Clairac Mammoth*.—Introduced in 1884 by Felix Gillet and in 1886 by John Rock. Described by Mr. Rock as follows: "Uniformly large size, reddish or light purple, thin skin, sweet and high flavor." Described by Mr. Gillet: "Uniformly large, more oval than the French prune; nearly of the same color but somewhat lighter or reddish purple; earlier than the French and with thinner skin." Fruit grown by Mr. Rock analyzed at the State University in 1898, showed 20.4 per cent of sugar against 18.53 per cent average of three analyses of French prune. Very profitable as far as tried, as a large dried prune, and very largely planted and grafted in, in the Santa Clara Valley.

There has been quite widely planted another prune called *Imperial* which is very inferior in sugar content and likely to prove much less satisfactory.

Prune d'Agen; syn. *Petite Prune d'Agen*; *French Prune*, etc.—This is the drying prune at present most widely grown in this State. It is described by John Rock as follows: "Medium-sized, egg-shaped, violet purple, very sweet, rich and sugary; very prolific bearer." The first trees of the kind were grown by Louis Pellier, at San Jose, about the year 1857, the graft having been brought from France by his brother in December, 1856. The identity of this variety (which was first largely grown in the neighborhood of San Jose) with the variety chiefly grown in the French district tributary to Agen, was first announced by W. B. West, of Stockton, in the year 1878, during his visit to France. Since that time there has been much discussion of the matter, and Mr. Felix Gillet, of Nevada City, has been to great pains to send samples of our fruit for examination by our experts. The conclusion at which Mr. Gillet arrives, is as follows: "Our Petite prune is a true type of the d'Ente, its botanical characters being identical, and the fruit as richly flavored and sweet as that of its French ancestor."

Robe de Sergeant.—Though this term is given in Downing as a synonym of Prune d'Agen, and seems also to be in French a synonym for the d'Ente prunes; another prune grown in this State from an importation by John Rock, is quite distinct from the foregoing. Mr. Rock describes the variety as follows: "Fruit medium size, oval; skin deep purple, approaching black, and covered with a thick blue bloom; flesh greenish yellow, sweet, and well-flavored, sugary, rich and delicious, slightly adhering to the stone." This variety makes a larger, darker-colored dried prune than the Prune d'Agen, and has sold in some cases at a higher price. It has recently been in disfavor in coast valleys for defective bearing, but is more satisfactory at some interior points.

Bulgarian.—"An undetermined variety grown under this name, chiefly in the vicinity of Haywards, Alameda County; above medium size; almost round; dark purple; sweet and rich, with pleasant acid flavor; tree a vigorous grower, and an early, regular, and profuse bearer."—*John Rock*.

Coe's Golden Drop (English).—Very large, oval, suture distinct, one side more enlarged, necked; light yellow, often dotted red to the sun; stalk three-fourths inch, rather stiff; flesh yellowish, firm, juicy, and rich, closely adhering to the pointed stone; shoots smooth, rather glossy. A standard late variety for canning.

Silver Prune (Oregon).—Originated with W. H. Prettyman, who says: "It is a seedling from Coe's Golden Drop, which it much resembles, but it is much more productive." Profitable as a bleached prune, but defective in bearing in some California districts.

Golden Prune.—Originated from seed of Italian prune by Seth Lowell-

ing, of Milwaukee, Oregon, and described by him as larger than Italian; light golden color; exquisite flavor; dries beautifully.

Bavay's Green Gage; syn. *Reine Claude de Bavay* (French).—Large, round oval, greenish yellow, spotted with red, with small violet-colored longitudinal veins; flesh rather firm, juicy, sugary, rich, of fine quality, adhering slightly to the stone; shoots smooth, leaves roundish, shining; a free grower and very productive.

Ickworth Imperatrice (English).—Large to medium, obovate, purple, with irregular streaks of fawn color; stalk medium; flesh greenish yellow, sweet, juicy, rich, mostly adhering to the rather small stone; shoots smooth; very late, hangs long on the tree, and keeps well; endures long shipment well.

Fellenberg; syns. *Large German Prune*, *Swiss Prune*, *Italian Prune*.—Medium size, oval, pointed and tapering at both ends; suture small, distinct; dark purple, with dark blue bloom; stalk one inch, scarcely sunk; flesh greenish yellow, juicy, sweet, delicious, parts from the stone; tree a free grower and very productive; late, excellent for drying. But little grown in California, but largely in Oregon.

Coe's Late Red; syn. *Red St. Martin*.—Size medium, roundish, suture distinct on one side; skin light purplish red, or dark red; bloom thin, blue; stalk three-fourths inch, scarcely sunk; flesh rather firm, crisp, rich, vinous; very late; shoots downy.



The Giant Plum of Burbank.

LUTHER BURBANK'S NEWER VARIETIES.

Luther Burbank, of Santa Rosa, during the last few years introduced many new varieties not included in the foregoing list, which possess striking characters and some of which will become famous. They must, however, endure the test of trial and await later credit. Seedlings by other growers are also undergoing a similar ordeal.

CHAPTER XXIII.

THE QUINCE.

The quince enjoys California conditions to the utmost, and rewards the grower with large crops of very large and beautiful fruit. A quince weighing a pound is no curiosity, and it is unlikely that any city of the world can show such fine quinces at such low prices as San Francisco. The lesson from this fact is that the fineness of the fruit, and the evident adaptation of the State to its growth, should not alone be considered by the planter. The local consumption of quinces is naturally small, and it is chiefly for home preserving and jelly making. The commercial jelly makers use apple juice as the basis of nearly all their jellies, only using a little quince for flavoring, and some housewives follow the same course. The hope for profitable sale of the fruit in large quantities must therefore rest on distant markets, and though those well acquainted with the growth and sale of the fruit in the cities of the Mississippi Valley, have predicted a great demand for the California quince in that territory, experiences of shippers thus far have been varied, and not such as to induce the extension of our quince production, at present at least.

But though the quince in California has at present narrow commercial limitations, a few trees should find a place in every orchard, for family use or for local sale.

CULTURE OF THE QUINCE.

The quince is readily grown from cuttings. Take good-sized shoots of well-matured wood of the current year's growth, after the leaves drop in the fall, and set out at once in nursery row in moist, alluvial soil, or in any loose soil which is well drained and can be kept moist enough by cultivation or irrigation.

Quinces are planted at all distances apart, and are grown either as bushes or trees. Undoubtedly the best way is to plant about fourteen or sixteen feet apart, and prune into low standard tree form. This can be done much as already advised for other fruit trees. An annual cutting back of about half of the new

growth, while forming the tree, will strengthen the trunk and limbs and prevent the running out of long leaders, which droop to the ground on all sides when laden with fruit, and are often broken by the weight and the wind. Owing to the disposition of the quince to throw out several small shoots at a single point, it is advisable, when forming the tree, to remove all buds but one, just as the growth is starting. This will give one good, strong branch where it may be needed, instead of several weak ones. Pinching off shoots which start out too vigorously, or at undesirable points is, of course, advisable.

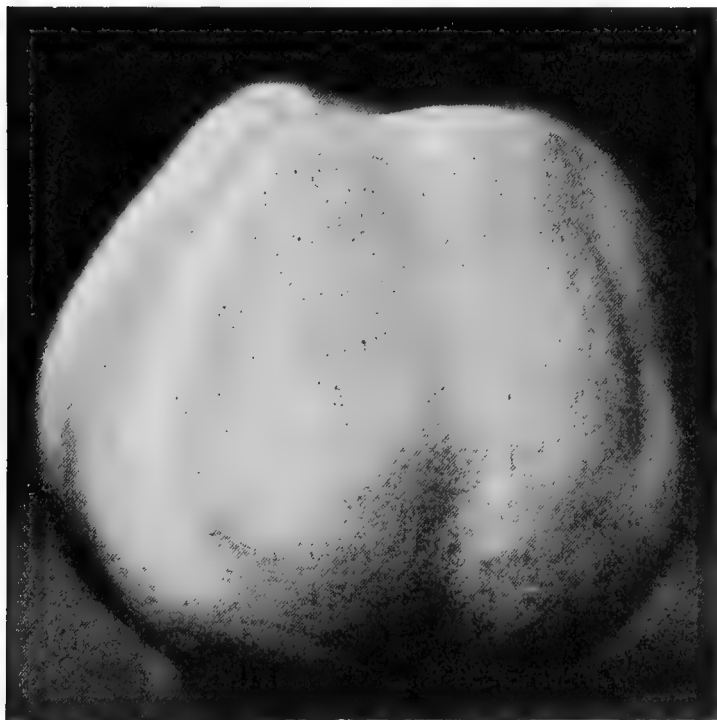

The Pineapple Quince of Burbank.

Soils for the Quince.—As the quince grows naturally in moist, though not wet, lands, many persons think it always does best in springy ground or along the banks of rivulets; but though moist soils are preferable to dry, such positions are not essential to obtaining large crops of fine fruit. In fact, the quince, like most fruit trees, prefers a well-drained location, and does best on a soil which can be freely worked. It thrives when

fanned by the ocean breeze and does fairly well in the interior, providing it has moisture enough in the soil, and in some situations will doubtless require summer irrigation.

VARIETIES OF THE QUINCE.

Though notably all varieties of the quince are introduced by our nurserymen and carried by them in small stock, most plantations are of the "apple" or "orange" variety. The following may be enumerated, however, as growing in this State:—

Apple or Orange.—Large; bright yellow; the best. August and September.

Portugal.—Very large, and fine flavor, turns a fine purple or deep crimson when cooked.

Rea's Mammoth.—A very large and fine variety of the Orange quince; a strong grower and very productive.

Champion.—Fruit very large, fair and handsome; tree very productive, surpassing any other variety in this respect; bears abundantly when young; flesh cooks as tender as an apple, and without hard spots or cores; flavor delicate, imparting an exquisite quince taste and odor to any fruit with which it is cooked.

The Chinese Quince.—A most extraordinary fruit, oblong, of immense size, often weighing from two to two and one-half pounds; growth rapid and distinct.

West's Mammoth.—Originated by W. B. West, of Stockton, from seed received from Boston in 1853; of the Orange quince family; round; clear yellow; very large; fine flavor and for the class a very good keeper.

Pineapple.—Originated by Luther Burbank and distributed by him in 1899; the result of a long effort to secure a quince which would cook tender like an apple. The name comes from its flavor, which is suggestive of the pineapple.

PART FOURTH: THE GRAPE.

CHAPTER XXIV.

VINE PROPAGATION AND PLANTING.

The culture of the grape is one of the great branches of California horticulture. Its three chief divisions are: Grapes for the table, grapes for wine, and grapes for raisins. In all these branches the product has far exceeded local requirements and has become an important item in the export trade of the State, and yet, though grape products have reached large amounts, the producers are still confronted with problems in the growth of the vine and in the manufacture and marketing of its products which will require the fullest devotion, the keenest intelligence, and the brightest spirit of enterprise, to bring to satisfactory solution. The attainments of the industry can be measured by the statistics of the shipments of grapes, raisins, wine, and brandy, which are given at the close of Chapter VI. During recent years, owing to the spread of phylloxera in certain regions, the fact that the raisin product had apparently reached the limit of the consuming capacity of available markets and the depression in the wine interest, the grape acreage of California has decreased from the figures of a decade ago. The outlook at the close of the century has, however, some very encouraging features.

THE GRAPE AREA OF CALIFORNIA.

The grape has a very wide range in California. If the immediate seacoast and the higher altitudes on the mountains be excepted, the grape may be planted with a good chance of success anywhere if soil and local topography be suitable. As has been shown in Chapter I, the vine can approach quite close to the ocean if some shelter from prevailing cool winds be afforded, and quite high on the mountains if one keeps out of depressions where late frosts are frequent. In planting the grape in doubtful situations much depends upon choice of proper varieties. For example, in the cool air of the coast region and the short

summer of the higher altitudes, early maturing varieties must be the main reliance, for late sorts will not receive heat enough to bring them to full maturity.

Away from immediate coast influences, and up to perhaps three thousand feet or more on the sides of the Sierra, the grape is successfully grown both upon the floors of the valleys and upon the hillsides. But there is still need of choice both of special locations and of varieties according to the purposes which the grower has in view. The coast valleys of the upper part of the State produce good table grapes, but they are unfavorable for the raisin industry because of the deficient sunshine and excessive atmospheric humidity of the autumn months. The best raisins are made in the dry, heated valleys of the interior, and the conditions which there develop the fullest quality in the raisin grape also develop the sugar in some kinds of wine grapes beyond a desirable percentage. Here again the choice of suitable varieties intrudes itself, for the varieties which yield light table wines in the coast valleys may yield heavy "heavy" wines in the interior. Valleys, too, as a rule, although they yield larger crops of grapes and greater measure of wine than similar area on the hillsides, must yield the palm for quality to the warm soils of the slopes. And here enters the business proposition whether large amount and less quality is better than less amount and higher quality. To this there can be no general answer. It depends upon the disposition which is to be made of the crop, and the demand for it.

These few facts out of many which could be stated will serve to enforce the fact that wide as is the range of the grape, both localities and varieties for certain purposes must be intelligently chosen. Much has been learned during the last few years, but it will require the experience of another generation, perhaps, to make the matter clear.

Soils for the Grape.—The grape will thrive on a great variety of soils, in fact, on any of those enumerated as fruit soils in Chapter III. There are thrifty vineyards on the light, deep valley loams, on the heavy clayey loams, on adobe, and on the red soils of the foot-hills. Even on shallow soils the grape will do well if given sufficient moisture, and on rocky subsoils it thrives if there be crevices for the roots to penetrate, or if the rock be shattered to admit the roots to permeable substrata. Standing water during the active period of the vine is, however, unfavorable to growth, and alkali is adverse to satisfactory results in wine making. Almost any soil which does not hold excess of water or is not tainted with alkali will do for the vine, although the plant appreciates good, deep soil, and will grow and bear fruit in proportion to its supply of it. Of course the

economic question of ease of cultivation enters into the choice of soil for the grape, as for other fruits, but its claims are obvious and need not be enlarged upon.

Length of the Grape Season.—By choice of early and late varieties the grape season extends over a half year in California, without recourse to artificial means of preservation. Where the fall rains are not very protracted, the late varieties keep in good condition on the vines until the winter pruning. Good grapes have been picked from the vines as late as the middle of January.

PROPAGATING AND PLANTING VINES.

The grape is propagated from seed or by layers, or by cuttings of various lengths. Growing from seed was somewhat resorted to in California to get stocks for resisting the phylloxera, but such wide variation in resistance occurred in seedlings that propagation by cuttings, of varieties demonstrated to be best in this regard, has become universal. There is at present little disposition to grow grape seedlings in the hope of securing better and hardier varieties, as is so largely done in other parts of the country. The vast numbers of varieties of the European species, *vitifera*, which we have to draw from, makes the effort for new seedlings of little object.

Growing Vines from Seed.—Seed is easily removed from grapes by crushing the berries and stirring the pulp rapidly in water. Professor Husmann says that one pound of good, fresh seed will give from two to three thousand seedlings. Some advocate sowing grape seed in the fall, just as it is taken from the fruit, but best results are usually obtained by spring sowing, after danger from frost is over. It is advisable to keep grape seed moist for some time before sowing. Seed soaked one week in water, and afterward allowed to lie in a heap for three weeks germinates quickly, starting in ten days or two weeks after being put in the ground. Professor Husmann advises pouring hot water on the seed and allowing it to cool, the seed remaining in the water for twelve hours, and after that it is kept for a week in a sack, exposed to the sun, and covered at night, the sack being moistened from time to time.



Growth from Single Eye Cutting.

The seed should be sown in the open ground, the soil having been worked deeply and finely, as for a garden. Sow the seed about an inch apart, in drills far enough from each other to

admit of the use of the cultivator in the summer; cover not to exceed an inch in depth, and after moderate pressing of the ground, cover the whole bed with rotten straw, which should be gradually removed as the sprouts appear above the ground. This mulch will not only retain moisture, but will prevent the surface from being crusted by heavy showers. Summer cultivation with cultivator and hoe should be given.

Growing Vines by Layering.—This is another method of multiplying vines which is but little employed in California,

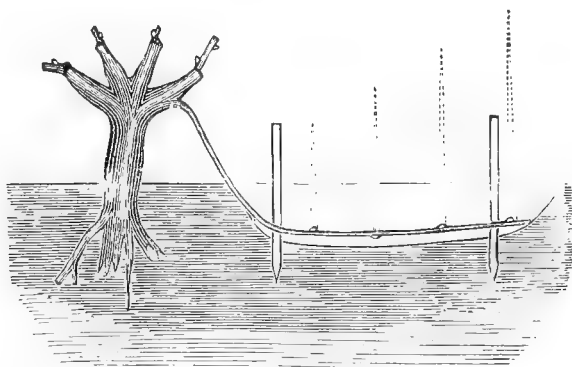

Layering to Multiply Vines.

because it is so much easier to secure plants by cuttings, as the *vinifera* species roots so readily. Layering consists in bending down and burying a cane so as to facilitate top and root growth from each of the buds. The engraving shows an old vine stump, one of the lower canes of which has been layered, and from which shoots are expected, as shown by the dotted lines. To hold the cane in place, stakes are used. The engraving shows the cane as just ready to start into growth, the filling of the trench being deferred until the lateral shoots grow out considerably, and then, by covering, the roots are developed. The cane must rest in moist earth, and usually has to be watered artificially, as well as treated to prevent evaporation. The following winter the cane is raised and a plant made at each node.

Another use for layering is to fill a vacancy in the row, a cane being taken from the nearest living vine, as shown in the engraving. In this case the layer must be set in a deep trench so as not to be torn out by the plow, and the layered cane is at once covered in with earth, all but one or two buds at the extremity, where the new vine is desired. In the engraving the cane is given a twist around the old stump so that it may enter the ground where it will not be caught by the cultivator. Such

a layer usually bears the second year and is then detached from the parent vine.

Both the layers described are laid down early in the spring, before growth starts in the vine. Summer layers of the current season's growth are sometimes made, but are not usually satisfactory.

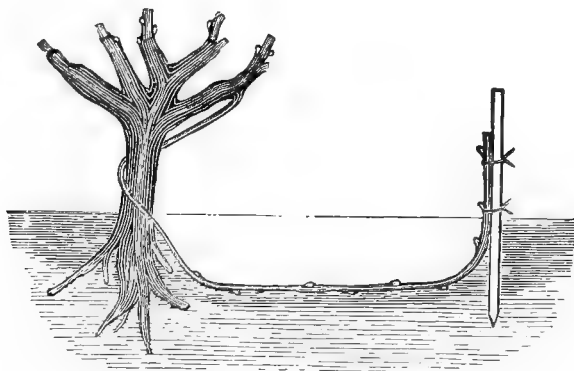

Layering to Fill a Vacancy.

Growing Vines from Cuttings.—This is the prevailing method in this State both to secure grafting stocks and to grow vines on their own roots. In growing from cuttings, different policies are adopted, *i. e.*, placing the cuttings in permanent place in the vineyard, or rooting them in nursery to be afterward transferred to the vineyard as "rooted vines." First, the various kinds of cuttings will be considered, and their placing mentioned later.

Growth from Single Eyes.—The use of single eyes or single buds, the shortest possible form of cutting, is not large in California, but some growers have reported good results. The



Single Eye Cutting

method is to prepare the cuttings as shown in the engraving, and plant them carefully, with the bud upwards, in well-prepared soil, covering the cutting completely, but very little under the surface. Success depends upon retention of moisture in the surface soil to induce rooting, and mulching is advisable. The method of propagation, too, seems best adapted to the moister parts of the State, whence, in fact, most success with it has been

reported. Besides economy of wood in getting a plant from each bud of the cane, which is sometimes an object, growing from single eyes is advocated because of the satisfactory root system secured, which, as the engraving shows, much resembles that of a seedling. The use of single eyes is obviously better adapted to nursery than to field growth.

The Use of Longer Cuttings.—There are several kinds of cuttings generally recognized by vine growers, of which two may be specified, as follows: The ordinary cutting consisting wholly of the wood of the previous season's growth and a cutting which retains more or less of the older growth. Where the cutting retains a small cross-section of an older cane, it is termed a "mallet cutting," from its obvious resemblance thereto, as shown at *B* in the engraving. Some hold that this round piece of old wood is undesirable because it is apt to decay, and they

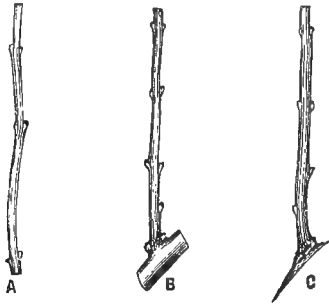

Different Forms of Vine Cuttings.

restrict the old wood to the top fragment, which carries the dormant buds at the base of the cane. Such a cutting is shown at *C* in engraving.

Though the use of the old wood is correct enough in theory and satisfactory in practise, it is the ordinary cutting, shown at *A* in the engraving, which is relied upon in vine propagation. There is, however, wide difference in opinion and practise as to how long this cutting should be to secure the best results. Ordinary cuttings, as used in California, vary in length from ten inches to three feet. Clearly enough this disagreement is due in part, at least, to different local conditions under which the vine is to make its growth, but two things are generally accepted as the result of California practise, and this is, perhaps, only confirmatory of experience abroad: *First*, that the tendency is toward the use of shorter cuttings than formerly; *second*, that where the longer are used, they should be set obliquely, so as not to bury the lower extremities too deeply in the ground. What distance is too deep depends, to a great degree, upon the soil and locality, for a cutting will grow good roots at a much

lower level in the light, warm loams of the interior valleys than in any other soil or situation, and longer cuttings are used in the interior than in the coast regions. The usual length of cuttings is from eighteen to twenty inches.

Making and Caring for Cuttings.—Cuttings can be taken from the vines at any time after the fall of the leaf and before the spring flow of sap begins. The earlier cuttings—those taken before January—are more likely to make a successful start and after-growth than those cut later in the season.

It is common, however, to defer preparation of cuttings till the pruning is done, be it early or late, and this will generally answer the purpose, if care be taken to secure the cuttings immediately at the pruning; but if the branches be allowed to lie upon the ground for days, exposed to sun, wind, or frost, before the cuttings are secured, their chances of growth are seriously lessened, and a good part of the failures in planting are due to such cuttings.

Cuttings should be taken from short-jointed, well-ripened wood of the previous year's growth, cut squarely and smoothly just below a bud. Cuttings from the middle or top end of branches are not so likely to root, nor to grow so vigorously, as those from the butts or ends nearest the old wood.

Keep them dormant until the time comes to set them in the vineyard, else the tender shoots may get broken. To keep them back, place them, at the pruning, in shallow trenches, top down, on the north side of a close board fence or a building, cover the butts with loose earth, and over that throw some straw and boards. Take care that the trenches are in moist but not wet ground, as too much moisture rots the cuttings. If the ground should not be moist enough, or if the cuttings seem dry or withered, plunge them in water to within three or four inches of their top, for a few days before setting, and do not let them dry again before planting.

Rooting Cuttings in Nursery.—What has been written is in reference to cuttings designed for placing in permanent position in the vineyard, but, for the most part, applies as well to the preparation of cuttings for the nursery. For nursery treatment, however, shorter cuttings can be used than for field planting, because of the better cultivation and more generous moisture conditions which are usually provided.

In preparation of ground for the rooting of vines and the planting of cuttings therein, the suggestions in Chapter VIII are directly applicable, as, to secure rooting of the cuttings, there is just as great need for deep and fine working of the soil, pressing of it around the cutting, and for careful culture during the growing season, as there is for such treatment of fruit-tree seedling or root graft. It is just as necessary, too, that the rooted cuttings should be carefully lifted and guarded from drying out

while on the way from the nursery to permanent place. The reader is, therefore, referred to Chapter VIII for suggestions on preparation, laying out, and care of nursery ground intended for the rooting of grape cuttings.

To secure vines upon resistant roots recourse has recently been made by some growers to the cutting-graft which will be mentioned presently.

There is a growing tendency to use rooted vines instead of cuttings in planting out vineyard, for, although the former cost several times as much as the latter, either in the time of the grower or in cash outlay, the balance is believed to be usually on the other side, when the uniform stand and more satisfactory growth secured by rooted vines are considered.

BUDDING AND GRAFTING THE GRAPE VINE.

Working over the grape-vine is largely practised in this State and is easily accomplished. The occasion is twofold: Replacing undesirable varieties with those of better quality, or in better market demand, and in bringing the *vinifera* varieties

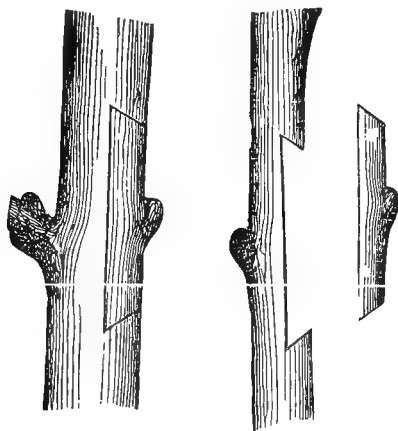

Inlaying a Bud in a Vine Cane.

upon roots which resist the attacks of the phylloxera. The employment of resistant stocks has proved eminently satisfactory in this State, the resistant stock having been successfully installed even in the hole from which the dead *vinifera* root has been taken. For this reason resistant roots are largely relied upon in the planting of new vineyards in infested districts, and are also used in regions where the insect is not now found, by those who fear and desire to provide against its coming.

Budding the Grape.—Buds can be readily made to grow in grape canes, though budding is not largely used. Success can be had with the same method of budding that is common with fruit trees as described in a previous chapter. Insert the bud in the spring as soon as the bark will slip well on the stock, and before the run of the sap is too strong. Keep the cuttings in a cool place so their growth will be retarded, and then seize upon just the right condition of the stock, insert the bud under the bark of a cane of the previous season's growth, tie it around with a string, and the bud starts readily without further treatment. When its growth shows its ability to take the sap, the top of the stock is removed.

Another method of budding the vine is by inlaying a piece of wood with the bud, as shown in the engraving. The use of a narrow waxed band would probably be desirable with this style of budding. It takes considerable ingenuity to make a good fit of bud and stock for inlaying, and it is but little done. It offers a way, however, to rapidly multiply wood of some desirable variety, by securing a cane from each bud.

Grafting the Vine.—Grafting in old vine roots is a simple operation, and is performed in various ways. The principles involved in vine grafting are similar to those affecting tree grafting, as described in Chapter IX. The processes employed

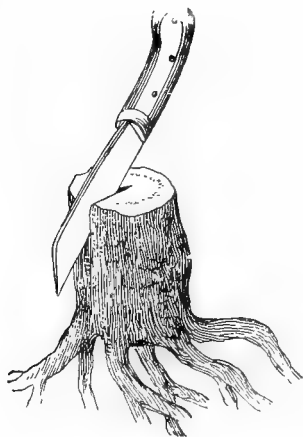

Making the Side Cut into the Vine Root.

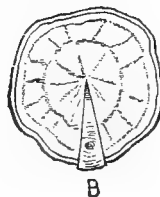
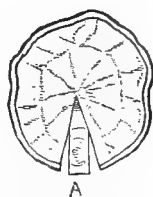

Adjustment of Scion to Stock.

are also similar, but the graft requires less binding and covering, because it is usually made beneath the surface of the ground, and is, therefore, less subject to accident, exposure, and drying out.

Grafting in the Old Stump.—This is resorted to when the character of the vineyard is to be changed. Out of the many

ways for working into old stumps, two are given below, as those most commonly employed in this State. The first is called "lateral cleft grafting" and introduces the scion by a side cut into the stock without splitting across. The earth is removed from the old vine down to its first lateral roots, and the top is sawed off cleanly a few inches above the first laterals. A cut is then made into the side of the stump with a knife and mallet, as is shown in the figure. The scion is then cut long enough so that one bud will remain above-ground when the surface is leveled again, the bottom of the scion being given an oblique wedge-shape, so as to fit the crevice in the stock. Some care is needed in shaping the wedge of the scion. A fit like that shown in *A* in the sketch will not succeed, while one in which the surfaces are in contact, as in *B*, will give good results.

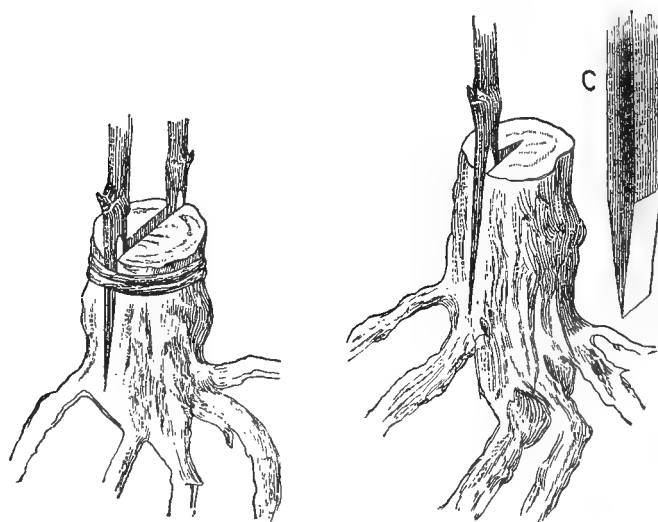

Common Cleft and Lateral Grafts. Scion in Position.

The manner of inserting the scion is shown by another engraving, which also pictures a wedge which is used to force the cleft open a little. If the cut is well made and the end of the scion so adjusted that the stock will pinch it when it is pushed into place, nothing more will be needed except to smear over the cut surface of the stump and the joint of the scion and stock with clay or with a mixture of two parts clay and one part fresh cow manure. If the scion is held firmly and sealed in with this mixture, it usually needs no tying, and the hole can be carefully filled with loose earth, with a strong stake to mark the place of the graft, and to which the new growth can be securely tied

afterwards. Another common method is to split the stump across its center and insert one or two grafts, as shown in the figure. If two are used and both grow, the weakly one is afterward suppressed. In this cross cleft graft some grafters rely upon the stock to hold the scion without tying, and daub it over with the clay mixture, care being taken to fill and cover the split in the stock to exclude water. Others put a ligature around the split stump, as shown in the engraving. Strips of cotton cloth answer well for this purpose. Tying offers better security from knocking out the graft with the cultivator.

In grafting into very tough old stumps, some growers leave a slim wedge of wood in the cleft with the scion to prevent the stock from closing too forcibly upon the scion.

Side Grafting.—Side grafting the vine is commended by some growers. It consists in inserting a graft by a cut into the side of the stock, the method being essentially the same as that employed with fruit trees, as described in Chapter IX, except that in side grafting the vine the top is not amputated, but is allowed to bear its crop and is then removed the following winter. The next summer the scion will bear a crop, and the vine is worked over without cessation in its bearing.

Herbaceous Grafting.—This term is applied to a graft in which the scion of the current season's growth is set by a cleft graft into canes also of the current season's growth, while both scion and cane are elastic, but not too soft. The method has not been usually successful in this State, apparently because of the dryness of the summer air.

Care of Scions.—Scions should be kept cool and moist enough to prevent drying but not wet enough to cause decay, as has already been described in the keeping of cuttings.

Time of Grafting.—Grafting is done in February, March, and April in different parts of the State, March being the month usually chosen for the work. If a spring graft fails, the stump may be regrafted in August or in the following spring. In regrafting, the stump is cut off again below the previous cleft. The time for the work is when the sap has ceased flowing, usually from the first to the tenth of August.

The recourse to resistant roots to escape the phylloxera has been attended with some disappointment because the wild roots at first widely used proved only partially resistant. Recently, in the main through employment of French selected varieties of the American wild species, stocks with satisfactory resistance, larger growth and vigor and adaptation to different California soils have been secured. Notable success has been attained in the habilitation of vineyards on the basis of resistant roots. The University Experiment Station, at Berkeley, has maintained leadership in this direction by publication of information and by

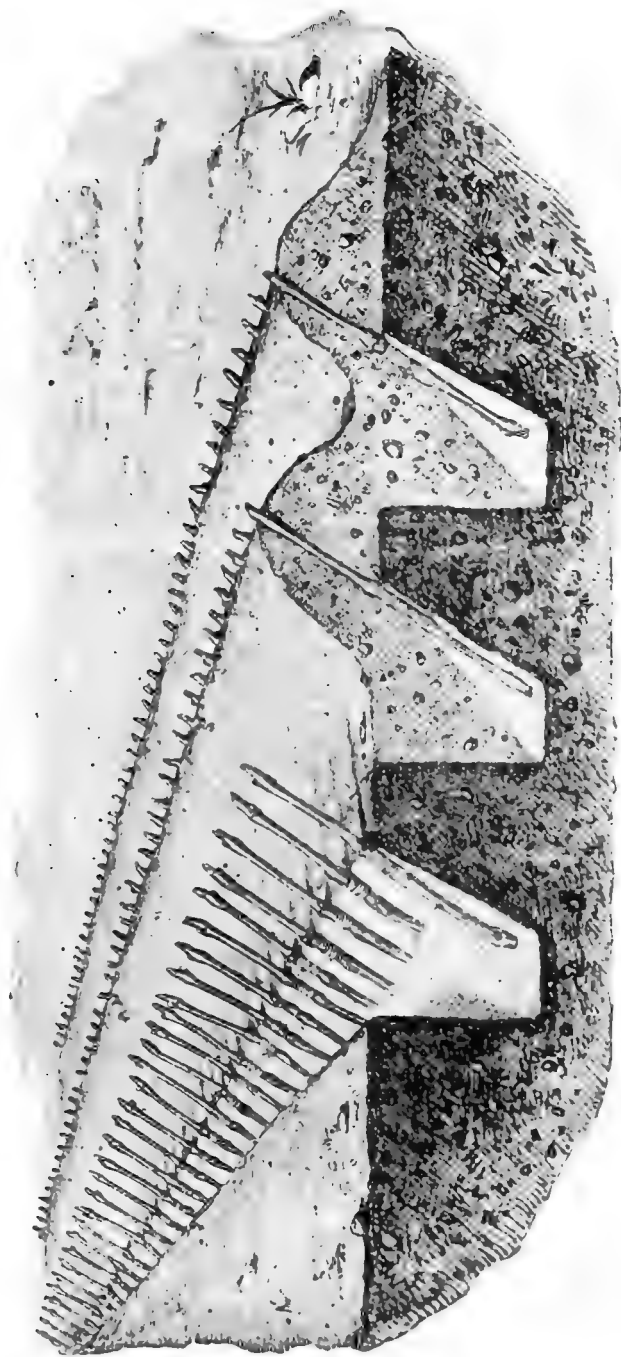

FRENCH METHOD OF ROOTING GRAFTED VINE-CUTTINGS IN NURSERY—SUCCESSFULLY USED IN CALIFORNIA.

The engraving shows resistant cuttings which are grafted with vinifera scions, before planting in nursery row. The grafted cuttings are seen on the left as regularly placed in the trench with the lower ends covered with friable top soil improved in this respect by the addition of sand if necessary. The next two rows appear fully covered with ordinary coarser soil so as to protect the scion from drying out and allow growth from the top buds. The use of this system may be of much advantage in some situations, but in many of the light, well-drained soils of California it may be found better to set the cutting a little deeper and use a flatter culture because of the greater ease of cultivation.

distribution of resistant roots for trial. Explicit information can be had free by application to the University.

Resistant Varieties.—American wild vines are characterized by every marked differences in degrees of resistance to phylloxera, and especially in adaptability to soils. Not only do species differ in this respect, but varieties of the same species show widely different characteristics. As a result of the process of selection varieties have been secured which are far above the average of the species in vigor of growth and development, degree of resistance and general suitability for resistant root purposes. Of the few varieties which have thus demonstrated particular excellence in France and have given notable indications of success in California, are the following:—

For soils likely to become somewhat dry in summer—the *Rupestris* “St. George.”

For deep, moist and tolerably rich soils, *Riparia* “Gloire de Montpellier,” and “Grande Glabre.”

For heavy, low lands, even if slightly alkaline, hybrid “Solonis.”

The *Lenoir*, *Herbemont* and a few others are praised by local growers.

The Cutting Graft.—Grafting the desired variety upon a resistant cutting and then planting the grafted cutting in nursery for rooting is an accepted French method which is being

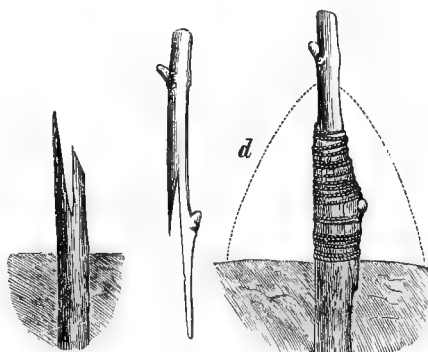

Whip Graft with Earth Mound.

successfully employed in California. This has advantage in time gained and in securing a full stand of vines as compared with grafting upon cuttings already rooted in place in the vineyard—though the latter is successfully practised. An adjacent engraving shows the rooting of cutting-grafts in the nursery.

Grafting on Resistant Stocks after Rooting.—Grafting on resistant roots differs from working in old stumps in the size of

the wood to be operated on, and in the fact that the graft must be set higher up because it is not desirable to have the scion strike roots of its own, for the obvious reason that depending on such roots would make the vine no longer resistant. The advantage of covering the graft with earth is, however, still to be enjoyed, for the earth can be raised in a little mound around the graft, to be removed when the graft has taken well. For this reason grafting on resistant roots is usually done at or near the surface of the ground.

The common cleft graft is used when the stock is large enough to give a split strong enough to hold in the scion. In grafting smaller stocks the whip graft is used, as shown in the accompanying engraving, which represents the stock, the scion, and the two after insertion and tying, with the dotted line to show the mound of earth made to keep the graft from drying out. This graft is variously treated. It is covered with clay by some, by others with grafting wax; but the common experience is that grafting wax makes too tight a joint, and holds in surplus sap, which begets disease. The use of a wax band specially adapted to ruling conditions has proved very successful, but the easiest and usually most satisfactory way is to wind with soft twine or raffia which will decay and loosen as the graft enlarges.

LAYING OUT THE VINEYARD.

Vines are planted in rectangles, generally in squares, but sometimes at a less distance in the rows than the rows are from each other. The stakes which are to represent the future vines are in either case placed by the same methods of measuring or marking off. All the methods described for clearing and preparing lands, in Chapter VII, and for laying off ground in squares, described in Chapter X, are applicable to vineyard ground. The measuring wire therein described is the means usually employed for laying off. A special contrivance which has been used to some extent on level ground is thus described:

The marker most in use is made in the form of a sled, sixteen, fourteen, or twelve feet long, with three runners so placed as to mark rows eight, seven, or six feet wide. These runners should be made about three feet long, of some hard wood (Oregon pine will do), two inches thick and firmly nailed to two planks placed upon them of the lengths first above named. Upon these should be bolted two strong pieces of joist in the form of wagon hounds projecting in front far enough to receive a stout pole like a wagon-tongue, well braced and fastened with an iron rod. Care must be taken that the motion of the machine is steady and true in all its parts. With a well-made marker, a gentle team, and a careful driver, excellent work may be done.

Distance of Planting.—There is as much difference of opinion and practise in fixing the distance between vines as between orchard trees, but usually more room is given than formerly.

Planted in squares, the distance varies from seven to ten feet, with eight feet as most prevalent, taking the State as a whole. Planting in rows is also adopted to some extent. Such plantations are made with the vines seven by ten or eight by ten feet, four and one-half by eleven feet, etc. There is great variation in the distances. Some advantages of the row system are as follows: Greater space to spread trays for raisin curing; plowing can be done with double team and larger plows; the brush can be gathered and burned between the rows instead of carrying it to the avenues; sulphur and materials for spraying can be brought in by team to any part of the vineyard; empty boxes can be distributed and filled ones gathered up without carrying, etc. Planting in rows recommends itself not only for planting new vineyards, but also for changing old vineyards from seven by seven feet to three and one-half by fourteen feet, or from eight by eight feet to four by sixteen feet, giving opportunity to change from a *vinifera*-root vineyard to a resistant-root vineyard. This can be accomplished by planting resistant roots in the alternate rows to be preserved, right between the two old vines.

Number of Vines to the Acre.—However the vines be set, it is very easy to calculate the number of vines which an acre will accommodate. Multiply the distance in feet between the rows by the distance the plants are apart in the rows, and the product will be the number of square feet for each plant; which, divided into the number of feet in an acre (forty-three thousand five hundred and sixty), will give the number of plants to the acre.

Avenues in the Vineyard.—For convenience of access with team and wagon there should always be avenues through the vineyard. They are usually arranged so as to cut up the vineyard into blocks about twice as long as broad, if the vineyard be on level land. Of course, on hilly lands the avenues should be located for ease of hauling. The avenue is made by leaving out a row of vines, and, therefore, the exact size of the block will depend upon the distance between the rows. Some advise having not more than forty vines between the avenues. Planting in rows, with wide spaces between the rows, renders fewer avenues necessary.

PLANTING CUTTINGS AND ROOTED VINES.

Various means are used for planting cuttings. An essential condition to successful growth is to have the lower part of the cutting well embedded in the soil, as it will not root unless in close contact with the earth. To lack of care in this regard most failures are due, and for lack of surety that such contact is made the various contrivances for speedy planting, such as the planting bar, are widely condemned; an excavation of the

hole and refilling with fine surface earth, just as advised in Chapter XI, for planting orchard trees, is commended as the safest practise. Much, however, depends upon the soil. In loose, free soil such a use of bar or "sheep's-foot" as will be presently described may be satisfactory, while it would be impracticable on firmer soils, both because of the difficulty of insertion and because the packed condition caused by the forcing in would not favor root extension, and not desirable on shallow soils because the contact of the better surface soil with the bottom of the cutting will stimulate the growth of the cutting, and is, therefore, very desirable. The planting by direct thrust is obviously impracticable when horizontal planting of a long cutting is desired, as will be described later.

The post-hole auger and a device for taking out soil as a "trier" takes out a sample of cheese or butter, have also been used to some extent, but not widely, in making holes for cuttings.

Planting Bar and Sheep's-foot.—The following methods, described by Dr. Gustav Eisen as prevailing in the raisin districts of the San Joaquin Valley, on sandy, loamy soils, will well illustrate similar methods wherever followed:—

The planting bar consists of a bar of hard iron, sharpened at the lower end and furnished with a cross-handle at the other. The length of the bar is about three and a half feet, width about two and a half inches, and thickness a third to half an inch. If less than this the bar will bend. The planting is done by pushing the bar perpendicularly in the ground. After withdrawing it, insert the cutting and push it down to the bottom. Fill up the hole by again inserting the bar in the ground close by and pressing the flat side against the hole.

The sheep's-foot consists of a round rod with cross-handle at the upper end. The lower end of the rod is slightly flattened, bent, and forked. The planting is done by fitting the forked end over the butt-end bud of the cutting, and immediately pushing cutting and rod together to the desired depth in the soil. A slight twist is now given to the sheep's-foot. This loosens it from the cutting and allows it to be withdrawn. A tamp with the foot fills the hole. Great care must be taken in withdrawing the sheep's-foot, lest in doing so the cutting should be drawn out also, and this will leave a fatal air chamber at the lower end. The slight twist given the rod before withdrawing loosens it and leaves the cutting undisturbed.

For planting in dry situations some careful planters run water and fine earth into the hole made by the bar after inserting the cutting; others run in fine sand dry and then pour on water. In using water in this way one must take care that he does not use adobe earth, for a succeeding dry spell may bake it, and the cutting will be worse off than if not puddled.

Planting Long Cuttings.—Where the long cutting, planted more or less horizontally, is adopted, the method of the late G. G. Briggs, one of the largest grape planters of the interior valleys, may be followed. This is his description of his practise:—

I make my cuttings of wood of the previous season's growth, about three feet long. I lay out vineyard with a plow, crossing furrows at right angles at the distance desired for the vines. At the intersection of the furrows, dig holes twenty inches deep and twenty inches long, and the width of a shovel. The holes should be dug all on the same side of the furrows, or in a corresponding angle of the intersecting furrows. The butt of the cutting is placed from the intersection; bringing the top at the exact intersection, with two buds above the surface. The end of the hole at the intersecting part must be perpendicular, so as to give the top of the vine a perpendicular position from the elbow of the vine at the bottom of the hole. To make this elbow when the vine is placed, slip the foot on the cutting and cover with soil and tramp down. I have found this mode of planting the most successful. It gives a larger amount of roots than perpendicular planting, and the roots are low enough below the surface to be out of the reach of ordinary drouth, and the same time none are so deep as to be cold and slow of action in circulation. In covering, be careful to place the soil close about the perpendicular part of the cane, and up full with the general surface, but back from this part the hole may be left in the form of a sink, to catch and hold moisture during the first rainy season.

Planting Rooted Vines.—Planting rooted vines is governed by the same rules commended for planting trees in Chapter XI, so far as preparation of holes, care in placing and firming the soil around the roots, etc., is concerned. In handling rooted vines there must be greater care in packing and transportation to prevent the roots from drying, and in carrying to the field it is generally advised that the plants be kept in a pail or other receptacle with water. The vine roots are very small and tender, and success will largely depend upon good care of them. At planting all dead roots should be trimmed away and the top reduced to a single cane cut back to two eyes.

When to Plant.—The exact time to plant can not be stated, for the condition of the soil and the local season-points are the best guides. Planting can be done much later as a rule in the coast regions than in the interior, because the soil is usually later in getting into good condition of mellowness and warmth, and the late rains are usually heavier. It is certainly not advisable to place cuttings in cold, wet soil, and dry soil will quickly destroy their vitality. The suggestions given in Chapter XI should be carefully considered. The planter must use good judgment in choosing his time for planting, aided in forming it by the best local experience he can get.

Cultivation of Vineyard.—General suggestions concerning the cultivation of the vineyard have already been given in Chapter XIII, preceding.

CHAPTER XXV.

PRUNING AND CARE OF THE VINE.*

Most of the varieties of *viniifera* grown in California at present thrive under the short pruning system. There are exceptions, however, which will be noted later. The prevalence of the short pruning system frees our growers from the expense and inconvenience of trellises. Though in the early years of the vines stakes are used, our older vines stand by themselves and are as independent of supports as are our fruit trees. The vines are, in fact, shaped upon something the same model as our fruit trees, the so-called "goblet form" of the French being our prototype.

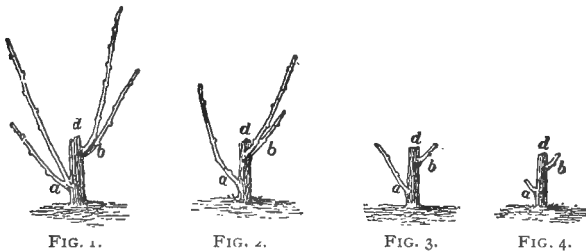

Various Growths of Vines before First Pruning.

An effort will be made to describe briefly how this form is attained.

First Year.—During its first year in the vineyard the cutting is allowed to make all the growth possible without interference. After the fall of the leaves the following winter, the vines will be found to have made varying amounts of growth, according to individual vigor, as shown by the accompanying engraving, ranging from Fig. 1, which is a good growth, down to Fig. 4, which is a feeble growth. In these figures *d* represents the wood of the cutting which was planted with two buds above-

* A general discussion of the pruning of the vine, with due consideration of all the ends to be attained by different pruning policies, is beyond the unavoidable limitations of this treatise. The literature of the subject is large, and any one who aims to make a speciality of the grape will of course seek other sources of information. Bulletin 119, of the University Experiment Station, Berkeley, is a suggestive exposition of the subject. It is the aim of the writer merely to give a few suggestions which will aid the beginner or one who designs to grow a small area of vines in connection with other fruits.

ground; *a* is the lowest shoot of each, which, in the first three instances, Figs. 1, 2 and 3, should be cut back to two buds, and all the other shoots removed entirely, leaving, however, the old stem *d* in each case, as it is useful to tie the new shoots to during the following summer. In the case of the feeble growth, Fig. 4, the shoot *b* is to be removed and *a* allowed to stand as it is, in the prospect of its picking up strength and making growth enough to be cut back to two buds at the end of the next season.

Thus it appears that usually all the vines can not be brought to uniform condition at once, but some will require a year or two more than others in the shaping process, because of the inherent weakness of the individual, or because some of the vines may be set in a spot of the vineyard less favorable to growth.

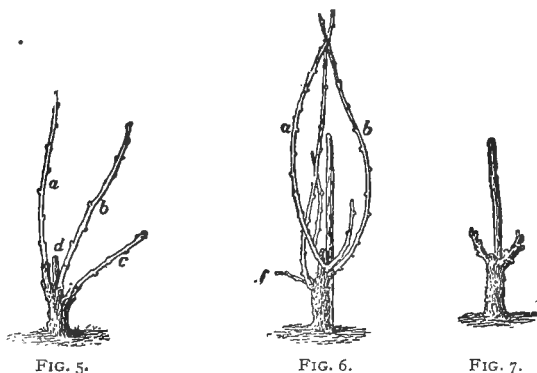

FIG. 5. Vine at Second and Third Pruning.

Second Year.—During the second summer, vigorous vines will send out shoots five feet or more in length, according to the inherent strength of the variety or the favoring situation, and of these the most upright and vigorous should be selected to serve as the foundation of the future trunk. It should be cut back so that the second bud from the top of the part that is left shall mark the height desired for the first fork of the coming goblet-shaped head. This cane should be tied to a stake and all other buds save the three at the top rubbed off. All other canes should be closely cut away. The engraving, Fig. 5, shows at *a* the cane to be chosen to form the future vine, while *b* and *c* are to be cut away cleanly.

At this point practise varies in this State. Instead of rubbing off the lower buds, as advised, some growers allow laterals to grow below the future head and the laterals bear fruit and are afterwards cut away. The result is that a trunk is afterwards formed with scars from the removed laterals instead of smooth trunks, which are secured when the lower buds are rubbed away.

The grower has to decide whether this fruit is worth more to him than the healthier and more vigorous vine, which will probably be secured by dispensing with this early fruit.

Another point of difference enters here, and that is the choice of height at which the head of the vine shall be formed. By the head is meant the point at which the lowest branches emerge from the main stem, and not the tops of the highest spurs, which some call the head of the vine. The question is, then. At what point shall the oldest or lowest forks be formed? Experience favors low-heading on hillsides and on broad valley vineyards. The grapes are brought near to the warm, dry soil, which, with raisin and table grapes, at least, is desirable because the radiation of heat from the sun-heated soil during the night gives a more uniform heat during the twenty-four hours, and, by bearing its fruit low and supporting part of it upon the ground, the vine is less affected by wind. But this very low heading is not desirable on moist soils because of mildew, nor is it safe on low ground where frosts are likely to form. For this reason in broken country where vineyards run from the hillsides down into small valleys, it is usual to head the vines on the low ground higher than on the hillsides.

Third Year.—During the third summer canes will grow from the vines something as shown in Fig. 6, and considerable fruit will be borne. Sometimes all these canes are allowed to grow through the season, but it is better practise to rub off other



FIG. 8.



FIG. 9.



FIG. 10.

The Vine at Fourth and Subsequent Prunings.

shoots when two or three vigorous ones can be selected to form the main branchings of the trunk. It is also customary to pinch off the main shoots after they have grown out a foot or so. This pinching results in the growth of leafy laterals which shade the fruit and add to the stockiness of the main canes. At the winter pruning which follows, these two or three main canes are cut back to two or three buds, the greater number of buds being left on the more vigorous vines. All other shoots are cut away cleanly. This operation fixes the first fork of the vine head, as shown in Fig. 7.

Fourth Year.—The fourth summer most vines will put forth a number of canes and bear a good crop of fruit, though some varieties are later in bearing. The same treatment is given the vine as during the preceding summer, and at the following winter pruning each branch is allowed to retain two spurs of two or three buds each, according to the strength of the vines, as aforesaid. Thus the vine which was left as in Fig. 7 at the third pruning becomes the form shown in Fig. 8 at the fourth winter pruning.

Subsequent Pruning.—After the fourth year the pruning proceeds upon the same plan, the number of branches or spurs being increased as the vigor of the vine seems to warrant, until



A Stump-pruned Vine.

the trunk shows the goblet form, as shown in Figs. 9 and 10. From year to year the number of buds left on the spurs depends upon the ability of the vine to produce the fruit and make a healthy growth.

Stump Pruning.—Short or spur pruning is also followed without systematic effort to build up a symmetrical trunk, branching in goblet shape, as has been described. In such practise the vine is usually headed as soon as a strong cane is thrown out about as high as the top of the trunk is intended to be, and year after year shoots are selected from those emerging near the top of the stump. Irregularly-branching heads are thus formed, continually crowding upward, and are kept within bounds much less easily than low-heading branches. The en-

graving shows a stump-pruned vine with some canes cut short and some long, according to a system which will be mentioned presently.



Thompson's Seedless Long Pruned.—W. R. Nutting, Fresno.

In stump pruning there is a difference of practise as to low heading according to locality. In the interior regions the vine is now headed almost at the surface of the ground; in the coast regions there is usually a stump of one to two feet or more. As with trees so with vines, the practise is to prune to make lower heads than during the early years of California fruit growing.

Long Pruning.—Some varieties grown for market and for raisin making do not thrive if pruned by the short-spur system. Notable among these are the Sultana, Thompson's Seedless,

Emperor, and Sabalskanski. There are also a number of wine varieties which must be pruned long. Long pruning admits of degrees, but it usually signifies using a five or six instead of a four-foot stake and leaving the selected canes from eighteen inches to three feet or longer instead of cutting back to two or three buds, as in short pruning. These long canes are securely tied to the long stakes.

With varieties needing long pruning the first two or three buds next the old wood do not bear fruit, hence the need of leaving buds farther removed from the old wood to secure it. This habit of the vine invites the practise of growing a long cane for fruit and at the same time providing for wood growth for the following year's fruiting by cutting another cane from the same

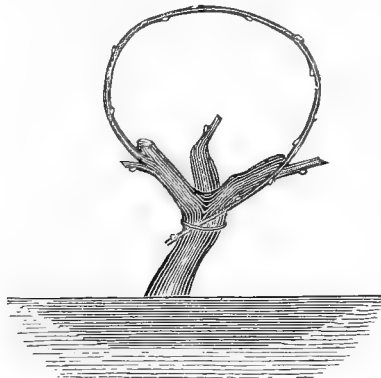

An Instance of Long Pruning.

spur down to two or three buds. By this practise the wood which has borne the fruit is cut back to a bud each winter and the cane which has grown only wood is pruned long for the fruit of the following summer. A modification of the practise is to prune the canes from some of the spurs long, and from other spurs short, thus making the spurs alternate from wood bearing to fruit bearing from year to year. Sometimes instead of using a long stake the long cane is brought over the top of the vine and lashed to the trunk on the other side; or two or more canes are thus brought over from side to side and tied securely at their crossing. The engraving shows one style of long pruning, which illustrates the cutting to long and short canes, and will sufficiently indicate the system. The number of long canes to be left to the vine depends on its vigor, and this can only be learned by experience.

Grape varieties which do not succeed with short-spur pruning are generally grown on long stakes, as stated, but use of the

trellis is increasing, especially among growers of Thompson's Seedless, in the interior valley and is also employed in the coast valleys for varieties which seem to thrive better when lifted from the ground. The engraving shows long pruning with renewal

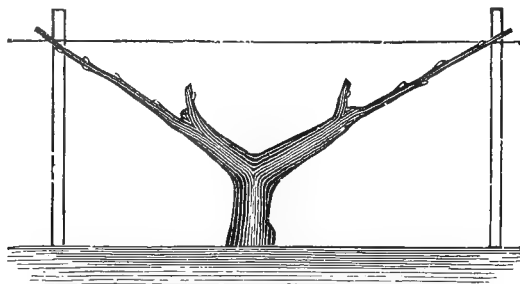

Long Pruning with Renewal Spurs and a Trellis.

short canes trained upon trellis, and an accompanying plate shows the trellising of Thompson's Seedless in a large vineyard near Fresno.

The Chaintre System.—This is another method of long pruning, which was introduced in California about fifteen years ago, but has never been widely adopted. It is of French origin, the term *en chaintre* meaning "trailing chains." It consists in growing long canes, which, when fruiting, are supported upon short, forked stakes, so that the clusters hang within a few inches of the ground, as shown in the engraving, which represents a branch of a chaintre-trained vine in fruit.

Materials Used in Training Vines.—The chief item of cost in vine training is the stakes. The best stakes are of California redwood, which is exceedingly durable. The cost of four-foot



The Chaintre System of Long Pruning.

stakes for short pruning is about \$12 per thousand and for five and six-foot stakes for long pruning about \$15 to \$18 per thou-

TWO-WIRE TRELLISING OF THOMPSON'S SEEDLESS GRAPE AT FRESNO.—See page 304.



sand, free on board cars in the redwood regions in Sonoma and Santa Cruz Counties.

Vines are tied with "grape twine," old cable (bought at the junk shops in San Francisco), with wire, with the tough leaves of the New Zealand flax, and with withes of ozier willow. Both of the last-named materials are now grown for home use by many vineyardists. Professor Husmann strongly commends No. 16 annealed galvanized wire for making the upper ties of young vine stumps to stakes, and uses the other materials for the lower ties and for fastening up growing canes.

Grape-vines should be tied tightly to the stake. By "tightly" is meant tight enough to prevent a chafing motion, without compressing the cane. The object of tying up vines is to prevent their being blown about by the wind and the breaking of the canes. Some, however, tie loosely, and are careful to have the vine on the leeward side of the stake. Split stakes should have the corners rounded to prevent chafing of canes.

SUMMER PRUNING AND SUCKERING.

Summer pruning or topping of vines is usually practised. Some follow the pinching process, by which the terminal of the growing cane is nipped off with the thumb and finger when it has grown out about two feet. Others wait longer and then slash off the ends of the canes with a sickle. The tendency is to leave summer pruning until too late and to slash off wood indiscriminately, to the injury of the vine. Summer pruning, if done early enough, and this would be while the growth is still soft at the point of removal, will induce the growth of laterals and will shade and improve the fruit, and at the same time thicken the growth of the main cane and strengthen its connection with the spur. Slashing of canes too late in the season deprives the fruit of the service of enough leaf surface for the elaboration of the sap, often seriously checks the growth of the vine, and in hot regions induces sunburn. The first summer pruning should be done soon after the bloom. The second could take place whenever the canes or laterals extend beyond the length necessary to shade the grapes.

Suckering is an important process and usually has to be attended to at least twice in the season. It consists in removing all shoots from old wood which are not provided for at the previous winter pruning. The growth of these suckers takes sap which should go to the other canes. All such shoots should be rubbed or pulled off while they are still soft; if a sucker puts out at a point where it would be desirable to have a spur to balance the head of the vine, it should of course be allowed to grow, to be cut back to two buds the following winter. By such selection of suckers new spurs are secured to replace old and failing ones.

GENERAL NOTES ON PRUNING.

Longer or shorter pruning produces effects not only upon the amount and early ripening of the fruit of certain varieties, but upon quality, as shown in the wine. Such effects have to be discerned by local observation.

It is a very difficult matter to lay down any rule for pruning a vineyard, so much depends on the age of the vines, the different varieties, and the quality of the soil. A basis on which to build a theory on the subject might be found in and through an understanding of the quantity of grapes that may be expected from a vine, as the secret of pruning is to keep a just medium between the production of grapes to the injury of the vine and its wood and an overproduction of wood to the detriment of the crop. In older vines a proportion should be maintained between the vigor of the vines and the crop desired; each bud may be considered good for two bunches of grapes the ordinary size, and upon this estimate may be obtained. It must be borne in mind that the result of overloading the vine is detrimental to its vigor and health, while the reverse will not injure it, but will lessen the profits for that season, often giving greatly increased returns in after years.

Close attention should be given to the growth of the wood and fruit of the preceding year. If the canes are very large and the bunches of grapes poor and there are many suckers, it indicates that more eyes are necessary. On the contrary, if the canes are small, and the bunches of grapes numerous and straggling, and the ripening not even, it indicates that the number of eyes left should be less.

Pruning should also be regulated to produce a good second crop of grapes or to prevent the formation of a second crop. The second crop is often desirable in raisin and table varieties, but undesirable in wine varieties.

Attention should be paid to the tools used in pruning. Let the blades be kept sharp and thin; large shears are very apt to bruise the wood more than small ones.

Pruning is done after the fall of the leaves and before the swelling of the buds, usually in January and February. Early pruning has a tendency to make the vines start growth early, consequently in frosty situations pruning is often deferred till late in the winter—as late as the middle of March in some cases. In such situations it is advised to leave more buds at pruning, so that if the frost kills the first shoots there are buds below to make later growth. This practise has been followed with marked advantage in some regions liable to late spring frosts.

The treatment of vines injured by spring frosts is clearly the immediate removal, by a sharp downward jerk, of the frosted

shoots. P. C. Rossi, a large vineyardist, recites this experience, both in the San Joaquin and Santa Rosa Valleys.

We had all the vines affected by frost entirely stripped of the damaged shoots, and we had the pleasure of seeing that, in a short time after, all the dormant buds came out finely, with their regular two bunches of grapes; therefore we have lost only one-third of the crop. In order to make careful experiment we left a row of vines untouched, and the result proved that the vines that were not stripped did not do as well as the others, as the dormant buds in many cases did not come out, and those that came out were not healthy and strong, and hardly had any grapes. The damaged shoots that were not removed died gradually, and at the junction with the cane new shoots came out without any grapes at all. The result clearly proves that we will have fully two-thirds of the crop out of the frost-bitten vines which were stripped of the damaged canes, while we had hardly any first crop and only a second crop on the vines which were not attended to.

DISEASES OF THE VINE.

One of the most prevalent diseases of the vine in California is caused by a fungus which affects leaves, canes, and berries, and is locally known as "mildew." This disease is recognized by grayish white coloring of the affected leaves, which, as the disease progresses, shrivel and dry up; the young cane also blackens and dries, and the berries show whitish patches, which become darker colored and the berries crack open. The usual remedy for the trouble is finely-ground or sublimed sulphur applied several times during the season. The application is

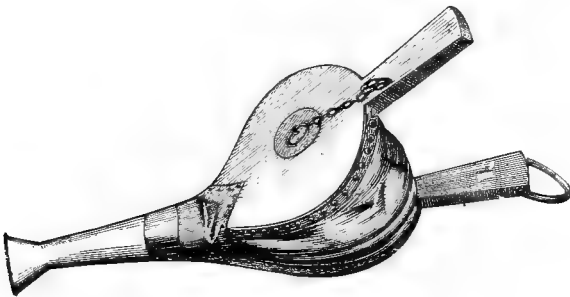

The Sulphur Bellows.

made with a "dredge" or a bellows. The dredge is a tin cylinder with a handle at one end like that of a "sugar scoop" and the opposite end perforated finely. Another form resembles the spout of a watering-pot, the sulphur entering through the handle, and fine gauze covering the face instead of perforated metal. By a proper movement of the arm the sulphur in the cylinder is thrown against the perforated end, and enough finds egress from the small holes to shower the vine. The dredge is best fitted for use on small vines or for use early in the season,

when the growth is just starting from the stump. When larger spread of sulphur is desired, the bellows may be used. The remedy should be a little in advance of the disease, and in regions where the mildew appears regularly, sulphur is applied about as soon as growth starts in the vine, a second application about blooming-time, and a third when the berries are the size of peas.

The Bordeaux Mixture and other copper preparations are sometimes useful upon grape-vines, as will be cited in the chapter on plant diseases.

Coilure.—A frequent misfortune of the vine, and for which no remedy is yet known, is coilure, a term signifying the failure of the fruit to set or to remain on the cluster. This occurs in varying degrees from the loss of a few berries to the almost complete clearing of fruit from the stem. It is worse with some varieties than others and in some localities than others. The trouble is believed to arise from various causes.

There is, also, occurring with more or less frequency, a reddening and death of the vine leaves, supposed to be identical with the trouble known to the French as "rougeole." The leaves show light-colored spots at first, which afterward turn red and finally involve the whole leaf or cane, and sometimes the whole vine. It usually occurs in midsummer, and is not necessarily fatal in its effects.

Root Knot.—An evil occurring on the main stem of the vine, generally near the surface of the ground, is an excrescence of woody character commonly called "black knot." There has been much discussion as to the cause of this abnormal growth, without full agreement among observers. Some attribute the knots to injuries to the stump in cultivation, others to outbursts of sap which the short pruning system does not give top growth enough to dispose of, and to various other causes. This is analogous to the "crown knot" of fruit trees which will be mentioned in the chapter on plant diseases.

Anahcim Disease.—There has prevailed for several years a mysterious disease of the vine in southern California, known as the "Anaheim disease," because its evil work first appeared in that vicinity. It destroyed many thousand acres of vines and led to the abandonment of grape growing in some regions. The disease has thus far baffled scientific inquiry as to its cause. The fullest statements concerning it can be found in Bulletin No. 2, U. S. Department of Agriculture, Division of Vegetable Pathology, by Newton B. Pierce, 1892, and Farmers' Bulletin No. 30, 1895. Fortunately during recent years the trouble has not been aggressive.

CHAPTER XXVI.

GRAPE VARIETIES IN CALIFORNIA.

Large collections of grape varieties have been brought into California during the last forty-five years. They were sought in all grape countries, and from such wide experimental planting a few have survived in popular esteem and are now chiefly grown. Being derived from different countries, they came bearing many names. Some of these have been preserved, some wholly lost, and replaced with local appellations. The result is that our grape nomenclature is full of confusion. Some varieties have been identified by the means of the standard French grape literature; others are apparently unknown to the compilers of that literature. It is, therefore, impossible to-day to determine a number of our most popular table and shipping grapes, as well as some of the wine varieties. In order to characterize our leading table grapes, descriptions will be quoted from the best available local authorities, as follows:—

Early Black July; syns. *Madeleine*, *Madeleine Noir*, etc.—“Leaves rather small, light green above and beneath; bunches small and compact; berries small, quite round; skin thick, black, covered with a blue bloom; flavor moderately sweet, but not rich nor perfumed. The earliest grape, and chiefly valued for the dessert on that account.”—*Hyatt*.

Early Madeleine; syn. *Madeleine Angevine*.—“Moderate grower, with long-jointed, brown wood; leaf medium, deeply lobed, dark green above, tomentose below; young points reddish, woolly, slender; bunch medium, compact, shouldered; berry medium, oblong, yellowish green, transparent, rather thick skin, sweet and juicy. Vine a shy bearer when frost is prevalent.”—*Husmann*.

White July; syn. *Luglienga*.—“Vine strong-growing and sensitive to frost; leaves of medium size, deeply five-lobed, dark green, glabrous on both sides, sharply toothed, the terminal tooth of each lobe very long and acuminate; bunches of medium size, well filled; berries of medium size, oval, at first green, becoming yellow with overripeness, with thin skin, crisp, firm flesh, and agreeable flavor.”—*Bioletti*. The *Luglienga*, which means July grape, is one of the earliest grapes known.

Chasselas Dove; syn. *Fontainebleau*, *Sweetwater*.—“A rather vigorous grower, with medium or somewhat slender canes of a reddish-brown color; young shoots of garnet color, nearly or quite glabrous; leaves rather be-

low average size, a little longer than wide, glabrous above and nearly so below, except for a few hairs on the main nerves, with well-marked sinuses, the petiolar one often closed, the petiole long, rather slender, and rose-colored; bunches of medium or over-medium size, conico-cylindrical, shouldered, more or less compact; berries medium to large, with firm but tender skin, small seeds, of delicate flavor and texture, at first crisp but becoming soft with full maturity. The grapes are of a clear green color, tinged with a beautiful golden bronze where exposed to the sun."—*Bioletti*.

Chasselas Rose.—Fruit resembling foregoing, except that both bunch and berries are usually smaller, and flavor is more pronounced.

Chasselas Victoria.—"Vine vigorous, very short-jointed and brittle, and bears well with short pruning; wood grayish yellow, thick and strong; leaf light green, deeply lobed and shining; young shoots with numerous laterals; bunch very large and heavy, often weighing five pounds, shouldered, very compact; stem brown, very thick; berry medium, round, pale lilac purple, with lilac bloom, juicy, vinous, refreshing."—*Husmann*.

Palomino; syn. *Golden Chasselas*.—"The vine quite largely grown as 'Golden Chasselas' is undoubtedly identical with the *Listan*, or *Palomino*."—*Hilgard*. "Vine a fair grower; wood close-jointed; leaf medium, oblong, deeply lobed, bright green above, grayish green and tomentose below; stem short, young points with reddish tint and woolly; bunch large, conical, rather loose and shouldered; berry round, full medium, sometimes flat, pale green with yellowish tinge; thin skin, juicy and sweet, resembling *Chasselas*."—*Husmann*.

Black Malvoise.—"Vine a strong grower; wood long-jointed, rather slender, light brown; leaf medium size, oval, rather evenly and deeply five-lobed; basal sinus moderately open, with parallel sides, upper surface smooth, almost glabrous, lower surface lightly tomentose on the veins and veinlets; bunches large, rather loose, branching; berries large, oblong, reddish black, with faint bloom; flesh juicy, flavor neutral."—*Hilgard*. Widely grown as an early table grape.

Mission.—"This variety, grown at the old missions, has never been determined, nor its exact source ascertained. It is by some regarded as a most delicious table grape. It can be found in small areas in every county of the State adapted to the grape. Vine a strong grower; wood short-jointed, dull dark brown to grayish; leaf above medium size, slightly oblong, with large, deeply-cut, compound teeth, basal sinus widely open, primary sinuses shallow and narrow, secondary sinuses ill-defined, smooth on both sides, light green below with light, scattered tomentum."—*Hilgard*. "Bunches slightly shouldered, loose, divided into many small, distinct lateral clusters; berries medium size, round, purple black, heavy bloom; exceedingly sweet, juicy, and delicious; seeds rather large; skin thin."—*Hyatt*.

Muscatel; syn. *White Frontignan*.—"Vine of medium size, with strong, spreading canes; canes reddish-brown, with short internodes; leaves of medium size, thin, five-lobed, glabrous, except for a few hairs on the lower side of the well-marked ribs; bunches long, cylindrical, regular, compact; berries round, golden-yellow, becoming amber-colored, very sweet and of marked aroma. Ripens a little later than the *Chasselas*."—*Bioletti*.

*White Muscat of Alexandria**.—"Vine a short, rather straggling and bushy grower, well adapted to short stool pruning, as it forms rather a bush than a vine; wood gray, with dark spots, short-jointed; leaf round, five-lobed, bright green above, lighter green below; young shoots a bright green. The laterals produce a second and even a third crop; bunch long

* There is much doubt about the White Muscats as grown in California. Some claim inability to distinguish between certain grapes of the Muscat type which are being grown in this State under distinctive names; others pronounce them clearly different varieties. The matter can not be adjudicated at present.

and loose, shouldered; berry oblong, light yellow when fully mature, transparent, covered with white bloom, fleshy, with thick skin, very sweet and decidedly musky."—*Husmann*. The leading table grape of California. Rejected for irregular bearing on some mesa lands in southern California.

Muscatel Gordo Blanco.—"Muscatel Gordo Blanco has a closer bunch and rounder berry than the Muscat. The skin is softer and the pulp is not quite so hard. The berry inclines to be a little darker in color and not nearly so green when it is ripe, and I think not quite as long as the Muscat of Alexandria. If the Muscat would set as well as the Muscatel, the difficulty would be obviated. One very important difference is that when you come to dry them, the Muscat of Alexandria loses the bloom very rapidly. The bloom comes off when you come to dry and pack them. But the Muscatel does not lose its bloom. The Muscat of Alexandria has to be dried a little more than the Muscatel to bring it into a keeping condition under the same condition of ripeness."—*R. B. Blowers*.

"The growth of the Muscatel or Gordo Blanco vine is low and spreading, with no upright branches in the center; clusters heavy, and, when perfect, close and shouldered; berries round and large (the greatest circumference being at the center), a crease often being found at the apex of the berry; color green, or, when fully ripe, amber green or yellow. Distinguished from Muscat of Alexandria by low, depressed growth of vine, closer cluster, rounder berries, and by thicker and finer bloom. The Muscatel is the choice raisin grape for the San Joaquin Valley, and for the interior generally."—*Dr. Eisen*.

Huasco Muscat.—A variety brought from Chile, but after wide trial in California, seems not superior to the other White Muscat varieties previously mentioned. Its dense cluster is not well adapted to raisin making. It is held however, to be less subject to coulure.

Fehér Szagos.—"Vine a strong grower and heavy bearer; branches erect but slender; leaves glossy, entire; bunches medium to small, pointed, and solid; berries greenish amber, medium oval, pointed, with thin skin and few small seeds; flesh not firm, but dries well and makes a good raisin."—*Dr. Eisen*.

Larga Bloom; syn. *Uva Larga*.—A variety of Muscat said to be named because of the length of its berries, but held by some growers to be indistinguishable from Muscatel Gordo Blanco. An excellent raisin grape, but now chiefly grown as a table fruit in the Santa Cruz Mountains.

White Malaga.—"Vine a strong grower; wood reddish brown, short-jointed; leaf medium, leathery, smooth, deeply lobed, light shining green above; bunch very large, loose, shouldered, long; stem long and flexible; berry very large, oval, yellowish green, covered with white bloom; thick skin, fleshy."—*Husmann*. Grown in southern California in situations where the Muscat does not do well; also elsewhere as a table grape, and to some extent in San Joaquin Valley for raisins.

Sultana; syn. *Seedless Sultana*.—"Vine vigorous, upright; leaves large, five-lobed, with rather large sinuses, light colored, and coarsely toothed; bunches large, long-cylindrical, with heavy shoulders or wings, well filled when not cultured, but not compacted; berries small, round, firm and crisp, golden-yellow, and without seeds."—*Bioletti*. In California the variety is apt to have some seeds. It has more acid, and therefore greater piquancy of flavor, than Thompson's Seedless, but the latter is exceeding it in popularity among growers.

Thompson's Seedless.—Named by Sutter County Horticultural Society, after W. Thompson, Sr., of Yuba City, who procured the cutting in 1878, from Ellwanger & Barry, of Rochester, New York. It was by them described as "a grape from Constantinople, named Lady Deceverly." When it fruited in Sutter County, it was seen to be superior to the Sultana, and has been propagated largely. It has been widely distributed by J. P.

Onstott, of Yuba City, and others, and is now to be found in all parts of the State. The variety is described by Dr. Eisen as follows: "Oval; greenish-yellow; as large as a Sultana; seedless, with thin skin; good, but not strong flavor, and without that acid which characterizes the Sultana grape and raisin; bunches large or very large; vine an enormous bearer." Mr. Bioletti, of the University of California, considers the variety identical with the Sultana of Asia Minor, and give this description: "Vine very vigorous and with large trunk and very long canes; leaves glabrous on both sides, dark yellowish-green above and light below, generally three-lobed, with shallow sinuses, teeth short and obtuse, bunch large, conico-cylindrical, well filled, on herbaceous peduncles; berries under medium, ellipsoidal, crisp, of neutral flavor, with moderately thick skin of a fine golden-yellow color."



The Sultana Grape.

Flame Tokay; syns. *Flame-colored Tokay*, *Flaming Tokay*.—"Vine a strong grower, large in all its proportions, wood, joints, leaves; wood dark brown, straight, with long joints; leaves dark green, with a brownish tinge; lightly lobed; bunch very large, sometimes weighing eight to nine pounds, moderately compact, shouldered; berry very large, oblong, red, covered with fine lilac bloom; fleshy and crackling, firm; ripens late."—*Husmann*. The leading show grape of the State and desirable for shipping; quality low. Defective in color in some localities.

Black Hamburg —"Bunches very large, from six to ten inches in length, very broad at the shoulders, tapering to a point gradually; berries very large, round, slightly inclining to oval; skin rather thick, deep purple, very black at maturity; very sugary, juicy, and rich."—*Hyatt*. A very popular market grape.

Rose of Peru; syn. *Black Prince* (?).—"Vine a strong grower, with dark brown, short-jointed wood; leaf deep green above, lighter green and

THOMPSON'S SEEDLESS ON VINE AND RAISIN TRAY: VINEYARD OF J. A. DORE, FRESNO.—See page 311.



tomentose below; bunch very large, shouldered, rather loose; berry round, large, black, with firm and crackling flesh, ripens rather late; a very handsome and productive variety, of good quality, but not adapted for long shipment."—*Husmann*.

Moscatoello Fino; syns. *Moscatoello Nero*, *Black Muscat*.—"Leaves of medium size, with deep upper and shallow lower sinuses, glabrous above, slightly downy below, and very hairy on the veins, teeth long and sharp; bunches large to very large, long, loose, conico-cylindrical, and winged; berries very large, on long, thin pedicels; skin well colored, thin but tough; flesh soft and juicy, with delicate Muscat aroma. An excellent table grape. It is a heavy bearer, and produces very fine-looking bunches of dark-colored grapes. Rather late."—*Bioletti*.

Purple Damascus; syn. *Black Damascus*.—"Vine a medium grower; wood light brown striped with darker brown, short-jointed; leaf round, five-lobed, smooth, light green above, tomentose beneath; stem reddish, large, long and woody; bunch large, loose, shouldered; berry very large, oblong, dark blue, covered with lighter bloom, meaty, skin thick, ripens late."—*Husmann*.

Purple Cornichon; syn. *Black Cornichon*.—"Vine a heavy grower, with thick, light brown, short-jointed wood; leaves large, longer than wide, deeply five-lobed, dark green above, and lighter and very hairy below, coarsely toothed, and with short, thick petiole; bunches very large, loose, on long peduncles; berries large, long, more or less curved, darkly colored and spotted, thick-skinned, and on long pedicels. Desirable on account of its attractive appearance, curious shape, excellent shipping qualities, and late ripening."—*Bioletti*.

White Cornichon.—Resembles Purple Cornichon in shape and flavor, but has very thin and tender skin, which makes it better for the table, but poorer for shipping. Leaves not deeply cut; smooth on both sides.

Emperor.—"Vine a strong, vigorous grower; leaves very large, with five shallow lobes, short, obtuse teeth, glabrous above, woolly beneath, light green in color; bunches very large, long, conical, loose, with large, dull purple, oval, firm berries."—*Bioletti*. An excellent shipping grape, largely grown by R. B. Blowers, of Woodland, Yolo County, by whom its merits were first announced. Pronounced unsatisfactory because of irregular setting and non-ripening in localities near the coast in northern California, and generally condemned in southern California. Seems best adapted to early interior situations.

Black Ferrara.—A large black grape; large bunches; berries cling well to the stem, thick-skinned, flavor superior. An excellent local market variety and long-distance shipper.

Gros Colman; syn. *Dodrelabi*.—"Vine strong-growing, with dark-brownish wood; leaves very large, round, thick, very slightly lobed, shortly and bluntly toothed, glabrous above, close-woolly below; bunches large, short, well filled, but not compact; berries very large, round, dark blue, with thick but tender skin. Remarkable as having the largest berries of any round-berry variety known, and is probably the handsomest black table grape grown. The grapes have good keeping qualities, except that they are liable to crack."—*Bioletti*.

Black Morocco.—"Vine a strong grower, with thin, spreading canes; leaves under medium size, very deeply five-lobed, even when very young, the younger leaves truncate at base, giving them a semicircular outline, with long, sharp teeth alternating with very small ones, glabrous on both sides; bunches very large, short, shouldered, and compact; berries very large, round, often angular from compression, fleshy, of neutral flavor, dull purple color or colorless in the center of the bunch. Remarkable for the number of second-crop bunches which it produces on the laterals. Late in ripening and of very fine appearance; a fairly good shipping grape, but

difficult to pack on account of the size and rigidity of the bunches. The grapes are of an agreeable crispness, but lacking in flavor."—*Bioletti*. Vine quite subject to root knot.

Verdal; Aspiran Blanc.—"Vine of medium vigor and rather hardy; canes somewhat slender and half erect; leaves of average size, glabrous on both surfaces, except below near the axils of the main nerves, sinuses well marked and generally closed, giving the leaf the appearance of having five holes; teeth long, unequal, and somewhat acuminate; bunches large to very large, irregular long-conical, without any or with small shoulders, well-filled to compact; berries yellowish-green, large to very large, crisp, with thick but tender skin, agreeable, but without marked flavor."—*Bioletti*. Largely grown as a late table grape; in good condition; in some regions as late as November.

Almeria.—"Vine vigorous; leaves of medium size, round, and slightly or not at all lobed, quite glabrous on both sides, teeth obtuse and alternately large and small; bunches large, loose or compact, irregular conical; berries from small to large, cylindrical, flattened on the ends, very hard and tasteless."—*Bioletti*. The grape cultivated at the University experiment stations under this name is one of the several varieties which are shipped in such large quantities from Malaga and Almeria packed in sand or cork-dust. The grapes ripen late and attain about 20.0 per cent of sugar. They have remarkable keeping qualities. Vine needs long pruning, and is only adapted to hot, interior situations.

There are many other *vinifera* varieties which are grown to a limited extent either for raisins or for table use. Among these are the Canon Hall Muscat, the White Tokay, White Champion, Cinsaut, Sabalskanski, etc., for table use; the White and Black Corinth, for drying. With grapes, as with other market fruits, the planter usually confines his attention to a very few popular kinds.

EASTERN GRAPES.

Though many of the improved varieties of the grape species indigenous east of the Rocky Mountains, and of the hybrids between these species and the *vinifera*, have been introduced in California, their growth for table fruit is almost of insignificant proportions, and does not constitute even a respectable fraction of one per cent of our grape area. The popular taste decidedly prefers the *vinifera* varieties. There is, however, a variety believed to be of local origin, which is worthy of mention, as follows:—

Isabella Regia.—"A remarkable, giant-leaved, and very prolific sport of the Isabella, originating by bud-variation with Mr. J. P. Pierce, of Santa Clara. The berries, like the leaves, are of extraordinary size, and when ripe the fruit is exceedingly sweet and strongly aromatic. It is, therefore, acceptable as a showy, perfumed table grape, much liked by some, but readily surfeiting those who are accustomed to the *vinifera* grapes. The berries are too soft for shipment to any distance, but, all things considered, keep fairly."—*Hilgard*.

WINE GRAPES GROWN IN CALIFORNIA.

Progress is being continually made in the propagation of varieties yielding the best qualities of wine, and in the manu-

facture thereof. The hosts of considerations involved in this effort are beyond the scope of this work, and in great part beyond the knowledge of the writer.

It will be interesting, however, to introduce lists of the grapes more or less widely grown in this State for the various kinds of wine.

DRY WINES.

Red (Claret and Burgundy)—Zinfandel, Carignan, Mataro, Mourastel, Petite Sirah, Petit Bouschet, Alicante Bouschet, Grenache, Valdepeñas, Cabernet Sauvignon, St. Macaire, Beclan, Mondeuse, Blue Elbling, Refosco, and Barbera.

White (Sauterne, Hock, etc.).—Semillon, Sauvignon Blanc and Vert, Johannisberg Riesling, Franken Riesling, Traminer, Chasselas Dore (Gutedel), Chauche Gris, Berger, Folle Blanche, Feher Szagos, Green Hungarian, Palomino, White Pinot, Thompson's Seedless.

SWEET WINES.

Ports.—Mission, Malvoisie, Grenache, Trousseau.

Sherry and Madeira.—Mission, Palomino, West's White Prolific, Verdelho, Feher Szagos, Sultana, Thompson's Seedless.

Angelica, Muscat, etc.—Muscat of Alexandria, Muscatella, Furmint (Tokay wine).

Other varieties are also grown, but this list includes those most largely used at present.

PART FIVE: SEMITROPICAL FRUITS.

CHAPTER XXVII.

THE DATE.

The date palm (*phoenix dactylifera*) was brought to California by the padres, and the oldest date trees in the State are the survivors of their early plantings. These trees are found at the San Diego Mission, as shown in the engraving. They are conjectured to be a century old, and they have survived drouth and neglect, making unsuccessful effort at fruiting, for, according to common report, the fruit does not ripen, but whether owing to the unfavorable conditions indicated, or to lack of fertilization of the bloom, is not known. There are trees at Ventura, on the site of the garden of the old mission of San Buena Ventura, about forty feet in height and ten feet in circumference at the base, with long, graceful, tern-like leaves, which put forth about thirty feet from the ground.

The ill success of these old trees in the direction of fruit bearing probably long prevented further attention to the date as a profitable growth. Still there were date palms grown from seed of the commercial date planted here and there for ornament or out of curiosity, and in due course of time the fruit appeared. The first public exhibition of California dates known to the writer was made at the Mechanics' Institute Fair, in San Francisco, in September, 1877. The fruit was grown on the south bank of Putah Creek, the northern boundary of Solano County, the situation being slightly above the level of the plain of the Sacramento Valley, which lies east of it. The plants were grown by the late J. R. Wolfskill, from seed of commercial dates purchased in San Francisco, and planted in 1858 or 1859. The seed germinated readily, and the young plants were set out in a row about one hundred feet south of Putah Creek, on a rich, fine, sandy loam, lying about twenty-five feet above the bed of the creek. The plants received good cultivation but no irrigation. This treatment was continued after the property passed into the hands of the late S. C. Wolfskill, the plants being

allowed to remain in the row as originally planted, and they have attained great size, considering their crowded condition. They are approximately six feet apart, have trunks about two feet in diameter, and are twenty-five feet or more in height.



Date Palm at the San Diego Mission.

Another bearing date palm stands about a mile eastward of the situation just described, near the residence of J. R. Wolfskill. It was grown from seed of the date of commerce, which was planted in 1863, and the tree bore its first fruit in 1880. In the plate which shows this tree there also appears upon the left a taller date palm, which bears staminate bloom, as will be mentioned presently. This latter tree was originally one of the row previously described, and was successfully moved to its present situation after attaining considerable size.

The fruit of these two bearing palms differs notably in appearance. That of the first-mentioned tree is of bright yellow color and angular outline; that of the second tree is wine red, with smooth surface.

During recent years the date has fruited at many places in California and Arizona. There is little doubt that it will succeed in any of the interior regions which have a sufficiently high summer temperature, and even the so-called Colorado Desert may be dotted with groves of date palms, as portions of it now are with groves of the majestic fan palm of California.

Soils and Waters for the Date.—In California thus far the date palm has only been planted on good orchard land, but, according to experience in date-growing countries, the tree does not require rich soil, but, on the contrary, will thrive in a soil poor in humus—too poor and too purely mineral for any other fruit tree; and it produces the finest and best-flavored dates, nourished by water too alkaline for man and beast to drink. These observations should lead to trials of the tree in situations not adapted to other fruits.

PROPAGATION OF THE DATE.

The date palm grows readily from the seeds of the dried date of commerce, and, as has been intimated, the trees now fruiting in this State have been obtained in this way. By the use of seed, one gets, however, only seedlings, and the chance of thus securing a really fine variety is probably not greater than with other fruit-tree seedlings. In date-growing countries the best varieties are propagated by rooting the off-sets, sprouts, or suckers which appear at the base of the old palms. To secure the best foreign varieties such plants must be imported. The first successful enterprise of this kind was accomplished in the summer of 1890 by the United States Department of Agriculture, under the direction of Professor H. E. Van Deman, then chief of the Division of Pomology. The plants were divided between New Mexico, Arizona, and California. The plants for California were sent to the Department of Agriculture of the University of California, and were planted at the experiment stations at Tulare and at Pomona. Upon fruiting a number of these plants, it appears likely that they are only seedlings and not the best foreign varieties, as represented. The United States Department of Agriculture undertook arrangements in 1899 for a new importation, hoping to reach better results. A full account of the earlier effort and its outcome is given in Bulletin 29, of the Arizona Experiment Station.

Growing Plants from Seed.—The seed germinates with great readiness: in fact the young plants spring up as volunteers where date seeds have been thrown during the rainy season.

The seeds may be sown in open seed-bed, if slightly protected by cloth or lath frame, and the plants reset in nursery row to be placed in permanent position after attaining more size. They transplant well if a ball of earth is taken up with the roots. If grown in boxes, which is, perhaps, preferable, because more easily watered and cared for, they may be afterwards potted for a time, but the plant should not remain long in the pot because of the circular growth soon assumed by the roots. Large date plants can be readily transplanted by removing the outer leaves and taking as large a ball of earth as can be handled.

Rooting Suckers.—Suckers taken off in warm weather and watered freely usually take root readily. Care should be taken not to let the plants dry. Professor Toumy, in the Arizona Bulletin already cited, says a sharp two-inch chisel and a mallet are good tools to use in removing suckers. The leaf stalks should be cut away, exposing the bulb of the sucker, care being taken not to injure the bulb in removing. One should cut in rather deeply at either side, not being afraid of injuring the old plant, cutting out a V-shaped portion extending from the base of the bulb downward for a foot or more, and being careful to secure in uninjured condition all the attached roots. Mr. J. W. Mills, foreman of the Pomona substation in California, has the best success in removing suckers by banking earth about the stem of the plant so as to cover the bulbs, a number of weeks prior to removing them. A good system of roots is established by this method. In growing plants from suckers one gets fruit much sooner than from seedlings.

Bearing Age of the Date.—There is, however, much difference in the ages at which the seedlings have come in fruit in the hands of different growers. Fruit has been reported on seedlings six years old and even on plants four years from the seed. Such early maturity must not, however, be generally expected.

Blooming of the Date.—The date palm is *dioecious*, and, its staminate (male) and pistillate (female) blooms appearing on different trees, it requires the association of the two for perfect fruiting. Growing plants from seed leaves the grower in doubt as to the sex of his plants until they bloom. Usually one obtains a large preponderance of male plants. In propagating from suckers the new tree is of the same sex as the parent. It is advised to have about one male to twenty female trees. The pollen can be transported long distances and maintains its vitality for a long time.

Artificial fertilization of the bloom of the bearing palm has been found of advantage in this State, and was probably first practised by J. R. Wolfskill. Though the staminate tree was but a few feet away from the pistillate, the male bloom was broken in pieces and hung to the leaves of the female tree near

to the pistillate flowers. It was found that the parts of the date cluster which are nearest to the suspended male blooms have more perfect fruit than the more distant parts. Other California date growers have had similar experience.

In Winters the bearing palms bloom in April and May, and the fruit ripens in November.

Beauty of the Date Palm.—The date palm in fruit is a beautiful sight. The glaucous green pinnate leaves arch outward. Between two of these emerge the bright orange-yellow polished fruit stalks, which divide into a spray of slender bright yellow stems a foot or so in length; and thickly set upon these in clusters are the coral red date berries, covered with a rich bloom. It is a sight not easily forgotten by a lover of nature, and especially by one reared in a northern zone, the characteristic vegetation of which is so different.



BEARING DATE PALMS, NEAR WINTERS.—See page 316.

CHAPTER XXVIII.

THE FIG.

The fig is, perhaps, the grandest fruit tree of California. Its majestic size and its symmetry make it a crowning feature of the landscape, and its dense foliage renders the wide space embowered by it a harbor of refuge from midsummer heat, both for idlers and for the industrious. On adjacent farms in Pleasant's Valley, Solano County, there are large fig groves; one serves as a shelter for the packers of fruit from the contiguous orchard, and the other incloses and shades a croquet ground. Measurements of large trees are abundant, for old trees are numerous in the interior of the State, both in the valley and on the slopes of the Sierra foot-hills. At Knight's Ferry, in Stanislaus County, there is a fig tree sixty feet in height, with branches of such length as to shade a circle seventy feet in diameter. The trunk at the base is eleven feet around, and nine feet at a distance of three feet from the ground. A little higher the trunk divides into seven or eight large branches, each of which is nearly five feet in circumference. At thirty feet from the ground the limbs are seven and eight inches through. The largest grove is in the neighborhood of Knight's Ferry, and consists of fifteen massive black fig trees, which, though set sixty feet apart, mingle their branches overhead and form a network through which, in the summer, hardly a beam of light can pass.

Such groves are frequently seen in the older settled parts of the State. Perhaps the most interesting single fig tree is that on Rancho Chico, quite near the residence of General Bidwell. It was planted in 1856, and has attained a marvelous growth. One foot above the ground the trunk measures eleven feet in circumference; the widespreading branches have been trained toward the ground, and, taking root there, banyan-like, they now form a wonderful inclosure over one hundred and fifty feet in diameter. The tree is loaded every year.

The crop on these large trees is proportionate to their size, and, entering their area in the morning during the ripening season, one can scarcely step without crushing figs, though the fruit is gathered up each day and placed in the sun for drying.

REGIONS SUITED FOR THE FIG.

Though there are still many fine points to be determined as to what situations and conditions favor the production of the very finest figs, and there are indications that there is possibly much difference, it may be truly said that a very small part of the State is really unsuited to its growth. If one shuns the immediate coast of the upper part of the State, where the summer temperature is too low for successful ripening, and keeps below the altitude of the mountains where winter killing of the tree is possible, he can grow figs almost anywhere.

Selection of varieties adapted to particular situations has much to do with the success of the fig, as with other fruits, and, therefore, a broad statement of adaptability must be received with such an understanding. The intrusion of the coast influences borne eastward by the winds of summer, as described in Chapter I, give a night temperature too low for ripening of some varieties, which turn sour upon the trees. Present indications are that the finest dried figs, having the thinnest skin and the nearest approach generally to the fig of Smyrna, the commercial standard for dried figs, will be produced in the drier portions of the valleys and foot-hills. Even in southern California fig-scuring is quite prevalent and selection of locations must be circumspectly made. More time is requisite for the final demonstration of these matters, although years have already been devoted to the problem.

SOILS FOR THE FIG.

As it must be left with the future to determine the mooted point as to the influence of special situations upon the bearing of the fig, and the more minute characteristics of the fruit, so more experience is needed to demonstrate the comparative effects of different soils. It might seem, from the fact of the age of our trees in different parts of the State, that time enough had elapsed to determine these points, but it must be remembered that all our oldest trees are of the very hardy variety found at the missions, and conclusions drawn from them as to all varieties are unsafe.

The fig will thrive in any soil that one would think of selecting for any of our common orchard trees, and, in fact, the fig succeeds on a wider range of soils than any one of them. One is safe in planting figs for family use, or for marketing, wherever the summer temperature is high enough to ripen the fruit well, and the winter temperature high enough to preserve the life of the tree. This applies merely to the successful growth of the fig; to secure ripening at a time when the fruit can be profitably sold for table use, is another question.

The selection of soils especially suitable to the production of the best figs for drying involves more considerations than rule in the growth of table fruit. For drying, the fig should attain a good size, but should not contain excess of moisture. In some parts of the State the first crop of figs in the season has been found unfit for drying. The second, and, in some localities, the third crop, appearing later in the season, when the moisture supply of the soil is reduced, dry well. This condition of the first crop is, however, affected by local conditions, for there are places in the Sierra foot-hills where the soil moisture has to be replenished early in the season by irrigation to prevent even the first crop from falling prematurely, and subsequent irrigation brings to perfection the second and third crops. The fig tree needs plenty of moisture in the soil, but not too much. As with other fruits, if the soil does not retain the needed amount naturally, it must be supplied by irrigation wisely administered.

PROPAGATION OF THE FIG.

The fig grows very readily from cuttings, and this is the chief method of propagation. Cuttings should*be made while

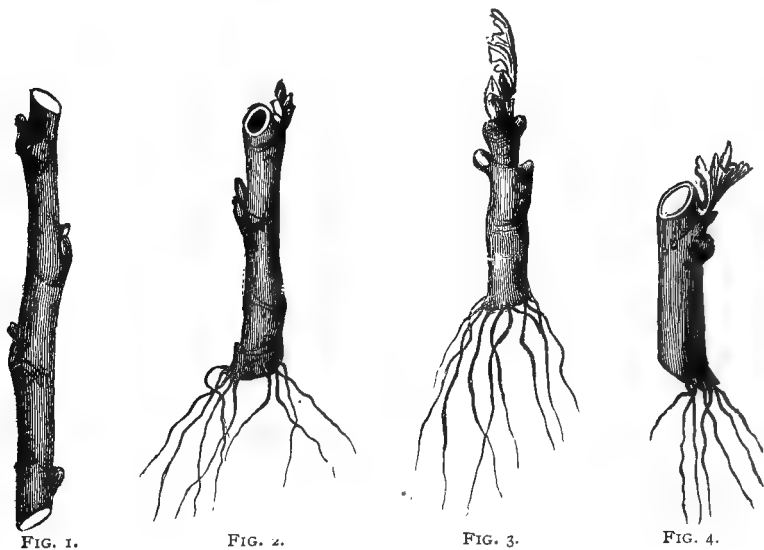

Growth of Fig from Cuttings—Lelong.

the tree is fully dormant, in the winter, of well-matured wood of the previous season's growth, giving preference to stocky, short-jointed shoots, and making the cuttings about six to eight

inches in length. The cut at the lower end should be made at the joint, or where solid wood is found. The planting and care of the cuttings is essentially the same as of vine cuttings, already described. If well made and cared for, a very satisfactory growth is made the first season, and the trees are ready for planting out in permanent place the following season.

Single-bud Cuttings.—If one desires to multiply a new variety very rapidly, single-eye cuttings will make plants. This is, also, analogous to single-eye grape cuttings, as already described.

The engravings show different styles of fig cuttings. Fig. 1 is the cutting usually employed, and its start in bud and roots is shown in Fig. 2. Fig. 3 is from the tip of a shoot, and Fig. 4 is a single-eye cutting.

Budding the Fig.—The foregoing means enable one to propagate a fig so rapidly that recourse is not had to budding, as in propagating other trees; still, budding is feasible, either on small plants or on young shoots of old trees which it is desired to over.

The fig may be budded by the common shield method, as used for ordinary fruit trees, and described in Chapter IX, but owing to the tendency of the fig bark to shrink in drying, the bud should be closely bound in with a narrow waxed band, to exclude the air. As the bark is thick, it is often desirable to cut out a little of the edges closest to the bud when in place.

A better method of budding the fig is by annular or "ring budding," a method also relied upon with the walnut and chestnut.* Annular budding, as shown in Figs. 1 and 2, is done in the fall. A circular ring of bark is taken off from the stock, as shown in the first figure on the left, which operation is done by the aid of a budding knife, by running two circular cuts around the stock, and a longitudinal one between the two circular cuts, the ring of bark taken off having the appearance shown in Fig. 2. This ring must be at least one inch wide, and from that up to two inches. A like ring of bark is taken off in the same manner from a scion of the variety to be budded in, and from a branch of the year, or preceding one, well in sap, and having about the same diameter as the stock. This ring should have on it one or two buds. It must fit exactly the space (*a*) seen on Fig. 1, and more particularly at the lower circular cut (*b*), so that both barks will exactly unite at that point. When the ring is too long, a little bit of it might be cut off with a very sharp knife till it fits well; if the ring is too large for the stock, a longitudinal strip would be cut out, and if too narrow, such a strip, if with a bud on so much the better, will have to be used to

*Felix Gillet, Nevada City, in *Rural Press*.

fill up the empty space. One must be very careful while drawing the knife around the stock not to go too deep into the wood to injure the cambium layer, or to weaken the stock. Tie a bandage pretty firmly over the whole. After two or three weeks the bandage has to be taken off, and, in the ensuing spring, the top of the stock or limb is cut down three inches above the budding.

Another way of working such trees is by "whistle budding," which is done *in the spring*, when the sap is well up. Figs. 3 and 4 show this method. The stock and scion must be both of the same size and well in sap. The top of the stock is cut down to several inches from the ground; a circular ring of bark is then taken off, and a corresponding ring from the scion, but without

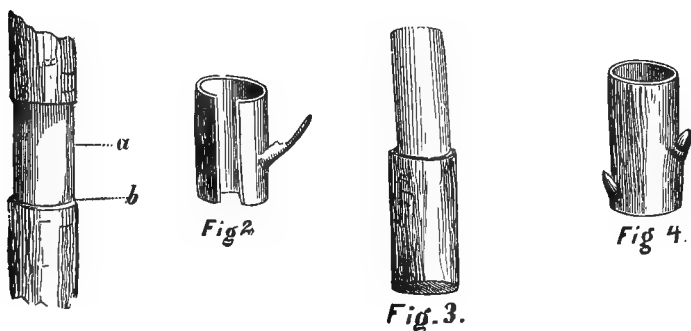

Annular and Whistle Budding Illustrated.

a longitudinal cut, is put in its place. In inserting it care should be taken that the top of the stock, which is to receive the ring from the scion, be very smooth, and the latter is then easily pushed down around it and bandaged. In the case of the fig, it is especially desirable to use the latter method when the sap is up, because if the top of the stock is not removed, the exudation from above sours around the bud and prevents the union of stock and bud.

To prepare an old fig tree for budding over, the limbs may be cut back in February within two to six feet of the trunk, covering the ends with paint or grafting wax. Allow two shoots to start near the end of each of these amputated limbs, and rub off all other shoots. Bud the shoots when they attain the thickness of one's finger, taking green buds from the growth it is desired to introduce, or let them grow and bud in the fall, whichever is most convenient; or bud in the growing shoot, and rebud in the fall where buds have failed.

Grafting the Fig.—The fig can be grafted by the cleft-graft method, as described in Chapter IX, but the cleft should be made to one side of the stub and not through the central pith. Especial care must be taken, in excluding the air. Fill the cleft between the scions with warm wax, which will run in and fill the cavity. Then bind the stock with wax bands, taking the greatest care to cover the exposed wood surface, the cut end of the bark (which in the fig is very prone to shrink and draw back), and as far down the stock as the bark has been split.

Another method is to make slightly outward and downward cuts into the stub with a sharp chisel, so as not to cause a split, but rather deep, clean cuts, into which the wedge-shaped scions are firmly pushed and a cord wound around the stub to hold all strongly in place before waxing thoroughly.

The form of side-graft as described in the chapter on the peach is also available. A form of bud-graft, that is, budding with a large shield into old bark, is also successful. Judge Rhodes, of San Jose, describes his method, both with the olive and the fig, in this way:—

Cut the shield from a limb of about $\frac{1}{2}$ inch in diameter, length of shield about $1\frac{1}{2}$ inches, its thickness from $\frac{1}{8}$ to $\frac{1}{4}$ inch, and its bud near the middle of the shield. Do not remove the wood from behind the bud. Make a cut in the stock, through the bark and into the wood, its length and width a little greater than those of the shield. Insert the shield into the cut, so that the inner bark of the top of the shield and cut will coincide, so that one side of shield and cut—and both sides, if practicable—will coincide. Place the flap of the cut over the shield (removing a part of the flap so the bud will not be covered), and fasten flap, shield and stock together very firmly with twine, and protect them with paper tied around them. They may be grafted in that mode, whenever dormant buds are found, for the shields. Twenty-four shields were inserted at several times, during one spring, and there was only one failure.

Seedling Figs.—Figs are readily grown from the imported fig of commerce. Dr. Gustav Eisen, of San Francisco, our leading writer on the fig, gives the following explicit directions for growing the fig from seed:—

Cut open imported Smyrna figs; wash out the seeds in warm water, those that float are empty and worthless; those that sink are generally fertile. Sow these in shallow boxes of sand and loam mixed, and place in a frame under glass. In three weeks they will be up and must be very sparingly watered. Set out next season in nursery row. In three years from the seed such plants will be found to bear. Do not throw away plants until six to eight years old, as some may develop, or show their qualities late.

The tendency of the plants grown from Smyrna figs is to revert to the wild type, and there is a small chance of securing good varieties.

PLANTING AND PRUNING THE FIG.

The chief point to observe in planting fig trees is to get them far enough apart, because of the great spread of branches which they attain. Of course they may be planted twenty feet apart if the owner intends to remove alternate rows, but to plant at forty feet, or even farther apart, with other fruit trees or vines between, on the plan of alternate or double squares, described in Chapter X, would be the best way to lay out a fig orchard—the intermediate growths to be removed as the figs require more room.

Very handsome effects are produced by planting the fig along avenues to inclose orchards of other fruits.

In transplanting fig trees extra care must be taken to keep the roots from drying. After planting, the stem must be diligently guarded from sunburn, to which it is liable in the warmer parts of the State.

Pruning the Fig.—The fig requires very little pruning after its shape is outlined. There is difference of opinion and practise as to the height at which the head should be formed; some head as low as already advised for common orchard trees; others, having in mind the immense thickness attained by the limbs, and their disposition to droop, head as high as four to six feet, which is the better way to proceed.

In shaping the tree, branches should be brought out at a distance apart on the stem, so that there may be room for their expansion without crowding each other, and care should be taken not to leave too many main limbs. Three limbs, well placed around the stem, are enough. The branches putting out on the under side of these limbs should be suppressed, and those growing upright, or obliquely upright, retained. After getting the general shape of the tree fixed, there is little need of pruning except to remove defective branches or those which will cross and interfere with each other and to prevent the interior of the tree from becoming too dense. It is better to remove branches entirely than to shorten them; or, in shortening, always cut to a strong lateral. Stubs left at pruning are very undesirable in the fig.

Cultivation.—Young fig orchards are cultivated as are other fruit areas. Old trees which completely shade the ground are usually left to themselves, without cultivation, except cutting out weeds. Irrigation is governed by local conditions, as already stated.

Bearing Age of the Fig.—The fig often, and, perhaps, usually, begins its bearing very early, in the most favorable situations in this State. Some fruit is often had the second year, and a crop worth handling the third year. Still, it is wiser not to

calculate definitely upon such returns, for four or five years sometimes pass without a satisfactory crop. We have, also, instances of "barren fig trees," which persist in "dropping their untimely figs," year after year, during their youth. How much of this is due to variety, and how much to locality, is not definitely known, but successful fruiting has been secured by grafting over barren trees, using scions from bearing trees growing adjacent to them.

CAPRIFICATION.

Caprification consists of suspending the fruit of the wild or *Capri* fig in the branches of the tree of improved variety, that the pollen may be carried by an insect from the former to the latter. California has never been able to produce dried figs equal to the fig of commerce or the Smyrna fig. This was, at first, thought to be due to lack of the Smyrna variety. After painstaking effort this variety was introduced. Trees grew readily from the cuttings; fruit appeared upon them and dropped before maturity. Doubt then arose as to whether importers had not been deceived, and other efforts were made which resulted in other importations. These also cast to the ground their immature figs. Discussion turned then upon the fact of caprification—the necessity of having the fruit of the *Capri* or wild fig adjacent to the fruit of the Smyrna fig so that insects from the *Capri* might visit the fruit of the improved variety and pollinate its inclosed flowers, which, appearing upon the inner wall of an almost closed cavity, could not be reached by ordinary visiting insects. The wild trees had already been introduced and were freely growing near the others, but this fact availed nothing—the figs fell just the same from the Smyrna trees. In 1890 Mr. George C. Roeding, of Fresno, essayed to demonstrate the fact that the lack of the pollination was the secret of failure, and he succeeded in introducing the *Capri* pollen into the eye of the Smyrna fig, and secured thereby the retention of such pollinated figs upon the trees, and when ripened and dried these had the Smyrna character. The demonstration was complete that California could not grow Smyrna figs without the pollinating agency found to be essential to success in Smyrna, which is a minute wasp called the *blastophaga*—an insect so minute that it can make its way through the mesh of ordinary cheese-cloth and can enter the almost closed eye of the young fig—so minute that a magnifying-glass is necessary to give one any clear idea of its outline. For years constant effort has been made by various parties to secure the introduction of this insect. Urgent appeals were made to the United States Department of Agriculture, after private undertakings failed, to secure the insect alive or otherwise in form for permanent resi-

dence. In 1899 the fact was accomplished. The living insect appeared in large numbers at Fresno—the offspring of those brought to California in April, 1899, by the United States Department of Agriculture.

Foes of the Fig.—The fig is freer from insect pests than other fruit trees, and yet it is a mistake to consider it wholly free. The writer has seen the leaves well covered with a *lecanium* scale, and has found a moth larva boring in the pith of the young shoots; still, practically, the fig tree in California has not yet suffered from insects.

The gopher has a pronounced appetite for fig roots, and their presence should be carefully watched for. Swine have a liking for fig bark. The trees of the grand grove planted at Hock Farm, on the Feather River, by General Sutter, were completely girdled from the ground as high as a pig could reach by standing on its hind legs. Figs make good food for hogs, and plantations have been made with this in view, but if the hogs are to be harvesters, it will be well to protect the stems of the trees from them.

VARIETIES OF THE FIG.

The fig presents what may be termed an aggravated example of the confused nomenclature which pervades California fruits. Dr. Eisen has made a commendable effort to bring order out of chaos by a study of foreign records and locally-grown fruit, and has published a catalogue of varieties chiefly grown in California, with descriptions of the characteristics of each in *Bulletin* 5 of the Division of Pomology of the U. S. Department of Agriculture, from which the following is chiefly drawn:—

Adriatic.—Size medium, roundish; neck medium; stalk short; ribs obscure; eye open, with red iris; skin very thin, greenish in the shade, yellowish in the sun; pulp bright strawberry red or white, with violet streaks in the meat; varies in quality according to location. This has been found very useful in California, but is not of fine flavor when dried. It requires rich soil, with considerable moisture and a very large percentage of lime. This variety is *not* identical with that known in Italy as Adriatic.

Agen.—Medium size, roundish; skin bright green, cracking longitudinally when ripe, showing white bands; flesh deep red, very rich; a good bearer, but very late, requiring a long hot season.

Angelique; syn. *Angelica.*—Medium, pyriform; ribs prominent; yellowish white; pulp white, with rose-colored center; leaves five-lobed. A very good variety in some of the coast valleys.

Athens; syn. *Marseillaise.*—Small, roundish or turbinate, with indistinct ribs, depressed at apex; skin rough; color whitish yellow, pulp red, opaline. Very sweet, and one of the best drying figs both in France and California.

Bourjassotte, Black; syn. *Barnissotte, Black.*—Medium, broader than long, flattened at apex, with no neck and an uneven cheek; ribs distinct, even; eye small, sunk, closed; skin waxy, black with violet blush; bloom

clear blue, wanting at apex; meat pink, pulp blood-red. A most excellent fig for the table. It requires rich, moist soil.

Bourjassotte, White; syn. *Barnissotte, White*.—A fig related to the former, but larger; eye larger, sunk; skin waxy, green; pulp bright red. A very fine fig. Tree very large.

Brown Turkey.—Large, turbinate, pyriform, with hardly distinct neck; stalk short; apex flattened; ribs few, slightly elevated; eye medium, slightly open, scales large; skin smooth, greenish to violet-brown in sun, with darker ribs; pulp dark rosy red, quality good, and tree a good bearer. Brunswick is frequently confounded with this fig.

Brunswick.—Very large, pyriform, with swollen cheeks, one of which is larger than the other; apex very obtuse; neck and stalk very short; ribs distinct, but not much elevated; eye medium, open; skin pale amber, with violet tint; pulp amber. An early, large fig, but with no flavor. Very common; requires rich, moist soil.

Celeste, Blue; syn. *Violette*.—Small, ovate, turbinate; ribs few, but distinct, especially near apex; eye raised, rough; color dark violet amber, without reddish blush; bloom confined to the neck; skin thin; pulp deep rose; meat amber, sweet, but lacking in flavor.

Col. de Signora Bianco.—Medium sized, pyriform; long, ribbed neck; skin green, changing to yellow; flesh deep red, very rich and luscious; a strong grower; late, suited for a warm region.

Dottato.—Medium ovate, pyriform; neck well set; stalk very short or none; ribs low; skin smooth; eye medium; skin thin, yellowish green, meat white; pulp yellowish amber, sometimes with violet flush. One of the best figs for drying; tree a strong grower, requiring moist, rich soil. Lately introduced into California.

Drap d'Or.—Large, pyriform, with very low neck and stalk; ribs elevated; apex obtuse and concave; color light violet-reddish amber, not dark; pulp rosy red. A fig of very fine quality; especially useful for confections and crystallizing; not identical with Brunswick.

Du Roi.—Above medium; round, pyriform; stalk very short; eye large or variable, with scales standing out; skin smooth, pale bluish green; pulp amber, with rosy streaks and exceedingly minute seeds. Related to Marseillaise and Athens, and one of the very best figs in California for drying.

Early Violet.—Small to very small, round, turbinate; neck distinct but short; stalk medium to long; ribs distinct, elevated; skin rough; violet-brown, with thin pearl-colored bloom; pulp red. This variety bears almost continuously and is preferable to the Ischias and Celeste.

Genoa, White.—Above medium, pyriform; neck small; stalk short; ribs indistinct; skin downy; eye very small; skin pale olive-green; pulp pale rose. One of the better figs, quite distinct from Marseillaise.

Gentile.—Very large; ovate pyriform; neck short but distinct; stalk very short; skin uneven, with ridges; eye very large, open, with projecting scales; color greenish yellow, spotted with white; pulp amber, streaked with rose; seeds few but very large. Only the first crop of this variety ripens. It is of the San Pedro tribe. One of the best early figs.

Grosse Grise Bifere.—Medium ovate pyriform; neck very short; stalk short; ribs distinct; eye small; skin downy, dark violet amber, pale olive in shade; the bloom is separated by a distinct line from the apex; pulp deep red. A tender, good fig.

Hirtu du Japon.—Medium size, roundish with long stalks; skin very dark; flesh opaline; quality best; very prolific.

Ischia, Black.—Small; neck short; stalk medium; skin smooth; color dark violet black, greenish around the apex; neck dark; eye medium, open; bloom thin, dark blue; pulp red. Of fair quality but small size.

Ischia, White.—Size below medium, round, with small neck; stalk very short; eye open; skin smooth, bluish green with brown flush; pulp rosy red. Common in California, but hardly worthy of cultivation in that State.

Mugdalen.—Below medium, round; ribs distinct, rough, disappearing around the eye; stalk longer than the fig; eye open, large; skin greenish yellow; pulp amber white. A very delicious fig, superior to the Ischias and Celeste. Not synonymous with Angelique.

Marseillaise, Long.—Large, longer than wide; skin thick, with brownish shade; pulp dull red. Requires moist soils. A fair fig, which dries well. Not related to either Black or White Marseillaise.

Marseillaise, White.—Medium ovate, pyriform; neck short; stalk medium; ribs numerous and distinct; apex flattened; eye large, open; skin downy, pale yellowish green, mottled with white; pulp amber, with a few large seeds. One of the best figs for drying. Requires sandy, rich soil.

Mission, Black.—Medium to large, turbinate; neck long; stalk short; ribs distinct; eye prominent, open; skin rough, deep mahogany violet, with red flush; pulp not fine, red, but not bright or brownish amber; sweet, but not high-flavored; common in the Southern States, California, and Mexico. The oldest fig in this country.

Monaco Bianco; syn. *White Monaco*.—Large, rounded, turbinate, flattened; neck small but very distinct; ribs numerous; eye very open; skin dark bluish green, with thin bloom; pulp dark-red rose. A most excellent fig for table, one of the best in California.

Pacific White.—An unknown variety found growing on a farm in Placer County. Medium size, fine-grained, very sweet, dries well, but the skin is thicker and more tough than the imported fig. That and its small size are the only objections to it. It is quite widely distributed in southern California.

Pastiliere.—Large, 3 inches by 1½; elongated, pyriform, with long neck; stalk short; eye closed, surrounded by an elevated iris; skin rough, hairy, with blue bloom; pulp red. Fine for preserves.

Ronde Noire.—Large, round, but irregular; neck distinct, short; eye small; skin smooth, waxy, dark violet brown; pulp amber. Greatly to be recommended as a table fig. Is not related to Black Ischia or Osborn Prolific.

San Pedro, White; syn. *Brebas*.—Very large, round, flattened at apex; stalk and neck short; eye open; skin thick, tender, of a bright yellow color or greenish in the shade, without bloom; pulp amber. A remarkable and handsome fig. Only the first crop matures without caprification. Suited only for table use. Requires moist, rich soil.

San Pedro, Black.—Very large, elongated ovate, with no stalk, but with well-set neck; skin smooth, violet black with green neck; pulp red, coppery, tinted violet. For table use. The largest fig known.

Smyrna (Fig of Commerce, Drying fig of Smyrna).—Of several attempts to secure the true Smyrna fig, or the variety which produces the well-known Smyrna fig of commerce, that made by the San Francisco *Bulletin*, and managed by G. P. Rixford, has achieved most prominence, and is now generally conceded to have proved successful. Fourteen thousand cuttings were obtained through United States Consul E. J. Smithers, in 1882, and a large part of these were distributed throughout the State. A later direct importation of fig cuttings from Smyrna was made by the Fancher Creek Nursery, of Fresno. These trees have already borne fruit, as has been described in a preceding paragraph on caprification. In the summer of 1890 cuttings imported from Smyrna by the United States Department of Agriculture were sent to several parties in this State. If the fig insect fully establishes itself, as anticipated on a previous page, this variety will establish itself as the leading drying fig here as a Smyrna, and a very important industry will be established upon it. Other figs called Smyrna in this State are misnamed.

Verdal, Round.—Below medium, round pyriform, without stalk or neck; skin smooth, waxy, bluish green; eye closed; pulp dark, blood red. A small fig, but valuable for canning and preserves; better than the Ischias or

Celeste. It does well in the Santa Clara Valley, but is inferior in the interior of the State.

There are many undetermined varieties of the fig grown here and there in the State. Some may be finally identified, others may be new. Some of them yield an excellent dried fruit and should be more carefully experimented with. During the last decade there has been a marked decline in interest in the fig because of the failure to secure the Smyrna type in the dried fruit and because so many varieties soured before drying. The outlook rests upon successful caprification, although recently there has been increased success in profitable drying of other varieties.

CHAPTER XXIX.

THE OLIVE.

The olive is another of the old mission fruits which has recently risen to a high place in the public mind. Though the tree and its products have been constantly under discussion since the American occupation, and though experimentation has been constant, it was not until 1885 that the tide of popular favor turned strongly toward the olive. For twelve years thereafter planting proceeded with enthusiasm amounting almost to infatuation, until the acreage now in olives has reached such a figure that the most enthusiastic question the wisdom of further planting. This is all the more serious because the future of the products of the olive is by no means clear. The competition of olive oil with cheaper salad oils works greatly to the disadvantage of the higher-priced article, apart from the fact that the cheap oils are sold in the guise of the olive, and can only be stopped by general pure-food legislation, which is now so greatly desired. The difficulty of producing pickled ripe olives with good keeping qualities is also vastly greater than anticipated. In addition to these troubles the sterility of the trees in some situations, through frost or other agencies, is discouraging many growers. It is probable that for the next few years, the uprooting of trees will exceed the planting and that the olive acreage will decrease until present difficulties are clearly shown to be surmountable.

The olive tree has survived a temperature of 14° Fahrenheit in California, but the fruit is injured by a slight fall below the freezing point. This may render unprofitable the late varieties which carry their fruit-ripening into the winter months.

The olive tree will thrive throughout the larger part of California, and it has been shown that it will grow in a soil too dry even for the grape-vine, and too rocky for any fruit tree, but the growth of the tree and the bearing of fruit will be proportional to the amounts of plant food and moisture. On foot-hill slopes the trees bear fruit earlier than in the rich valleys, although in the latter the trees attain larger growth. Trees in the interior bear sooner than on the coast, and ripen their fruit earlier in the season.

The olive tree is now thriving in California in a great variety of soils. It is productive, if frosts are not too severe, on moist valley lands, while on hillsides, even where excavations had to be made between boulders, or into disintegrating rock, the tree has exhibited thrift and content with the situation. But the conclusion should not be drawn that the olive relishes poor soil. It may thrive with loose rock or boulders, but it finds among them the elements it needs. It is not to be inferred that the olive will succeed on sterile soil.

The relations of soils to the qualities of oil has been investigated by the University of California Experiment Station and the publications can be had on application.

We have not had experience enough in this State to demonstrate the influence of soils on the quality of the oil, but oil thought to be good has been made from fruit grown on some of our best valley fruit soils, deep and naturally well drained, as, for example, on Putah Creek, where the tree is said to have attained a girth of six feet at twenty years from the cutting.

At present olive planting is proceeding on all kinds of land and in all situations. From these plantations our children may gain wisdom.

PROPAGATION OF THE OLIVE.

Olives are propagated from seed, and from cuttings of various kinds and sizes. The growth from seed is seldom practised in this State, because growth from cuttings is easy, and furnishes the variety desired without grafting.

Growing Olives from Seed.—The olives should not be planted with the pulp, but cleaned of this either by letting them rot in a pile or by putting them into an alkaline solution to cut the oil. A simple way to hasten germination is to break the pits, taking care not to hurt the germ. An instrument similar to the nut cracker has been invented in France which is said to work very well. When the kernels are deprived of their shell, they are kept moist in a compost, or mixture of cow-dung and sandy soil, and are sown thickly in the month of April. If it is thought to be too much work to take the kernels out of the pits, they must be soaked in a solution of one-fourth pound of concentrated lye to the gallon of water. Most of the seeds sprout the first year. Planting the naked kernels gives the quickest result. Without using this artificial means the seeds may remain dormant at least for two years.

Large Cuttings.—There are two chief methods of propagating the olive from cuttings now practised in California. One uses well-matured wood, and the other young wood which has just passed out of the herbaceous state. Practise with hard

wood proceeds by taking cuttings of sound wood about a foot long and one-half to one inch in diameter, and rooting them as already described for vine cuttings, in Chapter XXIV. These large cuttings sometimes remain dormant for a year or more, and recent propagation has been almost exclusively by the small-cutting method.



Propagating the Olive by Small Cuttings.

Small Cuttings.—Propagating by small cuttings has increased rapidly during the last few years. It serves an excellent purpose in rapid multiplication of the new varieties which are being secured from abroad; it enables the grower to handle a large number of plants in a small space, and the plants from small cuttings have a symmetrical root system quite resembling that from a seed. These cuttings are made from very small shoots and both the tips and the lower cuts are used. In the

engraving the figure on the left is a tip cutting; the next, a cutting lower down the shoot, and the figure on the right is a tip cutting as lifted from the sand to show its manner of rooting. These figures are about natural size, and show clearly how the cuttings are made. They are placed closely in boxes of sand about four inches deep, and after a few months are potted in small pots, or may be reset farther apart in boxes of soil or in the open ground. If the cuttings are made in January or February, when the wood seems to be in the best condition in Berkeley, the trees will be of good size for planting in permanent place the next winter. It is very important to take the small cuttings just when the wood is in the right condition, not too soft nor too hard. How to determine this point can not be described; it must be learned by experience.

Growing Trees from Truncheons.—New varieties secured from the south of Europe generally come in the shape of truncheons, which are long sticks of hard wood. They may be planted entire, or be sawn and split into large cuttings (for olive cuttings, even in firewood shape, will grow if properly treated), though better trees come from small cuttings. If the truncheons are bedded a few inches below the surface in moist, warm soil, shoots will appear which can be worked up into small cuttings when they reach the proper condition.

BUDDING THE OLIVE.

Since a large area of Redding Picholines has been planted, and the fruit found different from that anticipated, there has been a demand for working over the trees into better varieties. The method of budding commonly employed with fruit trees does not usually yield a high percentage of success with the olive, and other ways have been adopted with much better results.

Budding may be performed at any time of the year when the sap flows freely. If done late in the summer, the buds lie dormant through the winter. Best results are obtained when the buds are inserted early in the spring, as the operation can be performed to a much better advantage, and the buds will grow to some height before winter. When inserted in large orchard trees, or in limbs of large trees, the shoots from the inserted buds are allowed to grow until they have attained such a size as will justify in the removal of the entire top.

Twig Budding.—Twig budding, as first published in this State by B. M. Lelong, secretary of the State Board of Horticulture, is very successful. The bud is cut deep into the wood, in order to give the bud as much bark as possible. The leaves are partly cut off, then, with the sharp point of the budding

knife, the greatest part of the wood inside of the bud is removed, as shown in Fig. 1, which shows large and small twig buds. If part of the wood is not removed, then the bud can not take, as the wood in it prevents the two barks (the inner bark of the bud and the inner bark of the stock) from uniting. When the wood has been partly removed from the bud, the bud is inserted into the stock, as budding is done in the regular, ordinary way, and tied tight. At the end of three weeks the string is removed, and part of the top of the stock is cut back to force the bud to start. As the bud grows,

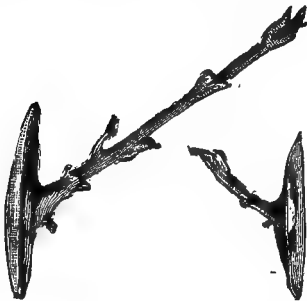

FIG. 1. Twig Buds.

the foliage of the stock is gradually removed, until the bud is able to take up the entire flow of sap; it is then left to grow, and trained as shown in Fig. 2, which also shows the manner of inserting the bud in the stock. When the bud has grown out strongly, what remains of the stock above the bud is cut smooth, close to the bud, to allow it to heal over.

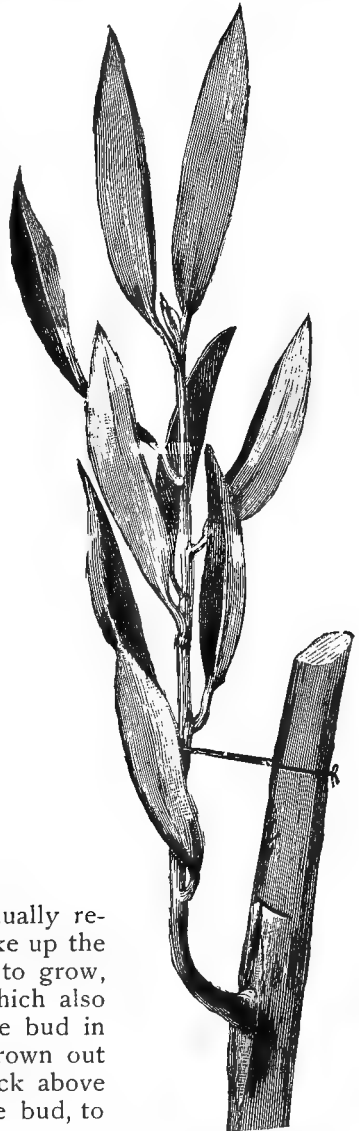

FIG. 2. Growth of a Twig Bud.

GRAFTING THE OLIVE.

Grafting is also used in working over both large and small olive trees. Good success can sometimes be had with

winds. Six or eight branches are left to form the head. The process of shaping the tree then proceeds, as shown in the engravings. Fig. 1 shows the young tree to be cut off at the point marked by the dotted line C. Six branches, three on each side, are left, and the lower twigs shortened. Each of the branches left develops, during the year, as the one shown in Fig. 2, which is then cut at C again, and the shoots B and D are short-

FIG. 1.



FIG. 4.

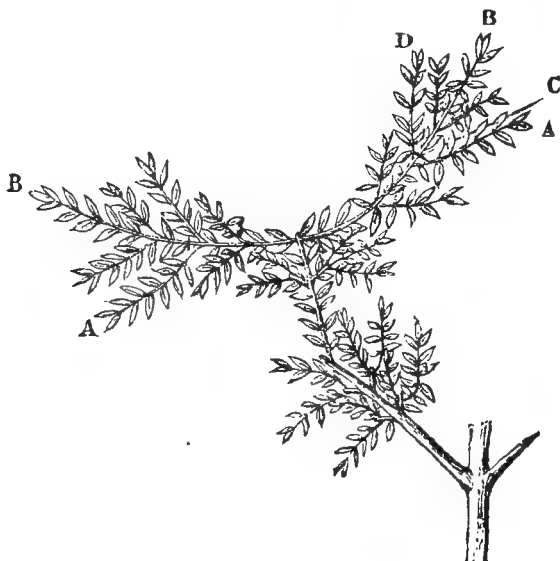
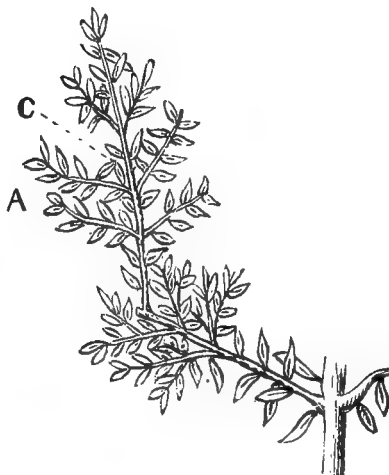

FIG. 2.



FIG. 3.



The Vase System of Pruning as Applied to the Olive.

ened. This process starts out the upper shoot, and it appears the following year as *A* in Fig. 3, and it is again cut at *C*. This causes the two upper shoots to develop, and at the end of the year they appear as shown at *BB* in Fig. 4. Thus they stand at the fourth year's pruning, and each of them is cut at *C*, and *A* is shortened and *D* allowed to develop. By this time the tree has a spherical or vase form, and exposes much surface to the sun, which is desirable.

The young branches that spring in the form of a cross on the more vigorous branches, bear only wood buds; the others, which are weaker, bear fruit buds on their whole length and burst into blossom at the spring of the second year. The latter never blossom again in the same place, but the shoot extends itself and forces two lateral ones. These new shoots bear the following spring, and so on. It must therefore be always borne in mind that the olive bears only on the two-year-old wood. If the new shoots are formed every year, the olive will bear annually; but in years of good crops, the sap employed to nourish the fruit only produces a number of very diminutive shoots, and the next crop is a short one. The pruning ought to favor the growth of young lateral shoots, either by shortening the terminal ones, suppressing the "gormand," or fruitless shoots, or by reducing in a certain proportion, each year, the fruit-bearing shoots, if we wish for a crop every year. The shortening of a branch is made immediately above an outside bud in an oblique direction, the interior one being suppressed. The suckers at the root of the tree should be continually cut off.

Concerning the time for pruning, the best season is said to be when the winter frosts are well over and just before the sap starts in the spring. By early pruning the sap is made to act upon the buds unfavorably situated on the tree, brings them out, and also develops latent buds on the old wood. Thus one is enabled to prevent the tree from becoming covered with naked limbs.

THE FRUIT AND ITS PRODUCTS.

The agricultural experiment stations of the University of California have been occupied for many years in the growth of olives and close examination of olive products both by laboratory and practical test. The publications of the stations constitute the fullest compendium of exact knowledge on this subject in the English language. All who wish to go into the matter deeply should secure this literature, so far as it is now available. For the purpose of this treatise outlines will be drawn from these sources.

Gathering the Fruit.—Olives should be picked carefully and at the right time. For green pickles they should be picked very soon after they obtain full size, but before they have begun to color or soften. For ripe pickles and for oil making the fruit should be gathered when it contains the maximum amount of oil. This is soon after the olives are well colored, but before they have attained the deep black which signifies overripeness. If the olives are gathered too green the oil will be bitter; if too ripe, it will be rancid. When they can be easily shaken from the tree they are ripe enough. If they commence to fall without vigorous shaking they are overripe. For whatever pur-

poses the olives are to be used they should be carefully gathered by hand, and imperfect, immature, or bruised fruit rejected. Sound fruit is required for high-grade oil or for handsome pickles with good keeping quality.

THE MANUFACTURE OF OLIVE OIL.

Olive oil is made in this State with apparatus of both Californian and European design, and, as a rule, there is made only one, and at most but two, pressings of the pomace, which is then used for fattening swine. In the frequent working over of the pomace, and the close extraction of the oil, as practised in Europe, we have done little as yet.

Olive oil is made on a small scale by a number of parties who use home-made contrivances, or small, portable cider machinery for the crushing and pressing. During the last few years quite a number of mills have been erected, some being "custom" or "co-operative" mills for using the olives produced by small growers.

Drying.—Extraction of oil from fresh olives gives the best oil, but is somewhat troublesome, and it is customary to partially dry them. This partial drying is also useful to keep the fruit for some time or for shipment before crushing. Place the olives in layers not more than three inches deep, on trays that are stacked in a dry, well-aired room, protected from the wind and the direct rays of the sun. Turn daily until the fruit becomes well wrinkled. This requires about eight or ten days, according to the degree of temperature. The partially-dried fruit may be stored in a dark room where the temperature does not rise above sixty degrees Fahrenheit, for three or four weeks without any serious deterioration of oil. To hasten the drying process, artificial driers, constructed on the same principle as the fruit or hop driers, are sometimes used. The olives are placed in a single layer upon trays, and the drier is kept at a temperature of about one hundred and twenty degrees Fahrenheit; at over one hundred and thirty degrees Fahrenheit the quality of the oil may be impaired. The drying takes about forty-eight hours—more or less—according to the nature of the fruit.

Crushing.—The olives are usually crushed by heavy stone rollers revolving in a circular depression in a bed of masonry into which the fruit is placed. Crushers with corrugated bronze or bronzed metal rollers are now made that perform their work in a very satisfactory manner, breaking up the flesh and pits very thoroughly. As they are all of metal, they absorb no oil and are easily cleaned. It is very essential that the flesh should be crushed thoroughly in order to break up the cells and permit

the oil to be pressed out. Mr. Cooper formerly used a stone, but has substituted two iron crushers, one following the other over the fruit. Mr. Kimball works his crusher and his presses by steam power. Mr. Cooper uses horse power, and has the apparatus so geared that the horse works outside the building, which is an advantage in point of cleanliness and otherwise.

Pressing.—When the revolving crusher has reduced the olives to a mass, the pomace is shoveled up from the bed of the mill and prepared for pressing. Instead of the fabric of woven esparto grass which is used abroad, coarse linen cloth is used. A certain amount of the pulp is put in each cloth, so that when the cloth is folded back it makes a cheese about three feet square and three inches thick. Ten or more of these cheeses are placed one above the other, with slats between, and the pressure applied gently at first. From the liquid which runs out first is made the very finest oil, known as “virgin oil.” The pressure is then increased very gradually until the full power of the machine is reached. This presses out the second quality of oil, which is generally mixed with the first. After obtaining all the oil possible by the first pressure the “cheese” is taken out, thoroughly broken up in hot water, and again pressed. This yields the third quality, which is very much inferior to the first and second. Sometimes the “cheese” from the first pressing is thoroughly broken up with cold water and pressed again before being treated with hot water. In this way a little oil is obtained that differs little from the second quality, and may be mixed with it. After this a certain amount of oil still remains in the “cheese,” but it can be extracted only by very powerful hydraulic presses, or by chemical means, and then is of very inferior quality, and suitable only for burning or for soap making.

Settling and Clarifying.—The liquid from the press is dark colored, and it is conducted into a receptacle for settling. Much of the foreign matter quickly separates, the oil appearing on the top. The oil is removed to other receptacles in which it can stand from two to five months for perfect separation of undesirable sediment. These settling tanks may be made of well-tinned metal, or of cement lined with glass or other impervious substance. The first settling is conveniently made by means of a funnel-shaped apparatus, which by its conical shape facilitates the rapid deposition of sediment. After standing for twenty-four hours in this apparatus the major part of the sediment is deposited and can be drawn off at the bottom. It is well, before running the oil into the settling tanks, to pass it through two or three inches of cotton wool. This is accomplished by means of a funnel with a perforated, horizontal cross partition, upon which the cotton is placed. It takes, generally, about one month for the oil to settle sufficiently in the first tank,

after which it should be drawn off carefully into the second, and so on until it is sufficiently bright. Three rackings are usually sufficient.

Olives are sometimes ground and pressed in portable cider mills or ground in barley crushers for oil manufacture on a small scale. As the above description shows, oil making is a simple process, and may be carried on at home with rude devices. It is, however, a process requiring care and cleanliness, and intelligent personal attention.

PICKLING THE OLIVE.

Olives are pickled in a green state, as is the case with the imported olives; or in a ripe state, as largely undertaken in California. No one had any conception ten years ago of the difficulties attending the production of pickled ripe olives which would have the keeping quality demanded in an article of commerce. It is now clearly seen that treating ripe olives to extract the bitterness and to secure firmness, good flavor and keeping quality is one of the most difficult propositions in our horticultural manufacturing, and we can but admire the wisdom of the Spaniard in teaching Anglo-Saxons to enjoy green olives. To succeed with the ripe olive requires the utmost patience, experience, and intelligence, and one who undertakes it must not get weary of the most exhaustive study of difficulties that may arise and how to meet them. When the most careful picklers with the best appliances sometimes lose hundreds of dollars worth in spite of all they know about it, the difficulty of the matter may be appreciated.

The following is an outline of the pickling of ripe olives as drawn from the University publications:—

The Lye Process.—The vats or other receptacles used for pickling should be perfectly clean, odorless, and tasteless. Earthenware is the best material, but it is cheaper to use wooden receptacles thoroughly treated with boiling water and soda until they are sterilized and all taste of the wood removed. Metal receptacles must not be used. The vats should have a plug below to draw off the liquids and should be covered to exclude air. They should be shallow, so that the layer of olives should not be much over a foot in thickness.

1. Place the olives in a solution, composed of two ounces of potash lye to each gallon of very pure water, for four hours. Repeat this once, or twice if necessary, to sufficiently remove the bitterness. If the olives are soft at first, or if they are of a kind that softens rapidly in the lye, use brine from the beginning, adding two ounces of lye and four ounces of salt to each gallon of water. As the lye acts much more slowly when used in combination with salt, it may be allowed to stay on the olives for a longer time without injury, eight to twelve hours or even more.

2. Rinse the olives thoroughly and replace the lye solution with fresh water. Change the water twice a day, until the lye has been removed from the olive, as judged by the taste. Use weak brine if the olives are too soft, changing once in two days.

3. Replace the water with brine composed of four ounces of salt to a gallon of water and allow to stand two days.

4. Put in brine of six ounces of salt to a gallon for seven days.

5. Put in brine of ten ounces per gallon for two weeks.

6. Put finally into a brine containing fourteen ounces of salt to the gallon of water.

Much depends upon having pure water. Ditch or stream water should be boiled before using.

Pure-Water Process.—The best pickled olives are made without the use of lye, but this process is only practicable with olives whose bitterness is easily extracted, and where the water is extremely pure and plentiful, and even then it is very slow and tedious. It differs from the last process only in omitting the preliminary lye treatment. The olives are placed from the beginning in pure water, which is changed twice a day until the bitterness is sufficiently extracted. This requires from forty to sixty days or more. The extraction is sometimes hastened by making two or three shallow, longitudinal slits in each olive, but this modification, besides requiring a large amount of expensive handling, renders the fruit peculiarly susceptible to bacterial decay and softening. Altogether, the pure-water process can not be recommended for California, as it is too expensive and uncertain.

Green Pickles.—Green pickled olives are made by essentially the same processes as are used for ripe olives. The extraction of the bitterness requires the same care. The olives are pickled soon after they have attained full size, and before they have shown any signs of coloring or softening. They contain at this time comparatively little oil, and are in every way much inferior to the ripe pickles in nutritive value. They are not a food but a relish. They are rather more easily made than the ripe pickles, as there is less danger of spoiling.

VARIETIES OF THE OLIVE GROWN IN CALIFORNIA.

Many varieties of the olive have been brought to California from southern Europe during the last twenty years. Fifty-seven varieties have been analyzed and elaborately reported upon by the University experts, and of these about fifteen varieties have risen to commercial account, as shown by the statements of their operations which leading propagators have kindly furnished for this work. It is an interesting fact, however, that in spite of all the efforts put forth to secure a better olive than the old Mission variety, this old sort comprises three-fifths of all the planting which has been done during the last few years—that is, the Mission has received fifty per cent more orders from planters than all other sorts combined. The following is the list of the varieties now growing in California on a commercial scale, arranged approximately in the order of their present popularity:—

Mission,
Manzanillo,
Nevadillo,
Rubra,
Uvaria,
Columella,
Sevillano,
Oblitza,

Oblonga,
Pendulier,
Polymorpha,
Pendulina,
Regalis,
Lucques,
Macrocarpa.

These may be taken, then, as the varieties to which attention should be given. Of course the next few years' experience may produce marked changes in this list.

The Mission Olive.—By this name is signified the variety found growing at the old missions in California. Samples of the fruit and leaves sent by F. Pohndorff to Don Jose de Hidalgo Toblada, a noted Spanish authority on the olive, led to the classing of our mission varieties with the Cornicabra-Cornizuelo varieties of Spain, and its value was confirmed. It has long been known that the so-called Mission olive embraced several varieties, or sub-varieties at least.

Common or Broad-Leaved Mission Olive.—The variety of olive most generally known as the Mission; ovate, oblique—sometimes very much

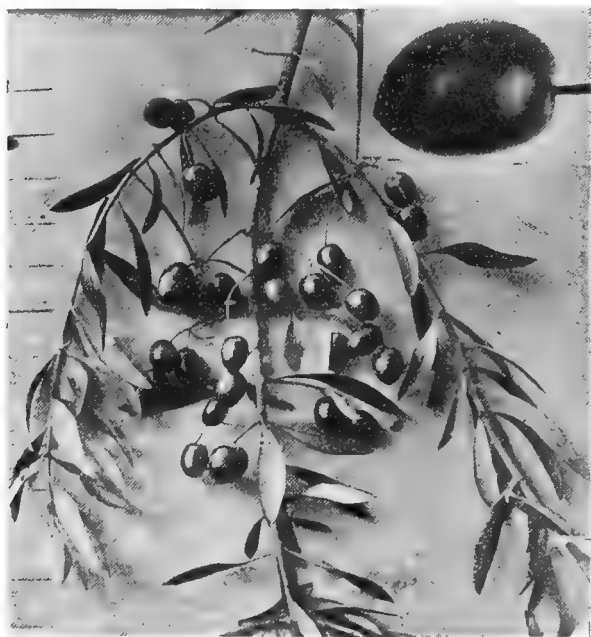

Mission Olive of California (Single Olive Natural Size).

so—the pit straight or slightly curved, fruit very variable in size, growing singly or in clusters of two or three, or even five; time of ripening, late, in the coast region sometimes not before February, but generally in December; in warmer localities, in November.

Redding Picholine.—Imported by the late B. B. Redding. A perfect oval in shape, ripens early, several weeks earlier than the common Mission; dark purple or black when ripe; in pickling the pulp loses the bitterness quickly, the fruit being very pleasant. This variety has been propagated extensively in the State, and, until fruiting, was supposed to

be a large pickling variety. It has produced oil of good quality. The smallness of the fruit is its irremediable defect.

Oblonga—Imported by John Rock from France. An olive of a peculiar, club-like shape, being narrow at the stem end, broad at the point, rounded and strongly oblique; generally pointed at both ends. The pulp



Manzanillo Grown by G. C. Roeding, Fresno. (Reduced.)

loses its bitterness comparatively quickly in pickling. This olive ripens quite early—at least two to three weeks earlier than the Broad-leaved Mission; color, dark purple.

Pendoulier.—Large, oval, slightly curved at apex end; very desirable

for pickling; early ripening in October in the interior valley and in November in coast valleys.

Manzanillo No. 1.—Imported by F. Pohndorff from Spain, large regular rounded oval; pit straight, strongly pointed at the apex, nine-sixteenths of an inch long, five-sixteenths of an inch thick. Ripens early, several weeks earlier than the Broad-leaved Mission. The fruit grows on long stems. The pulp parts readily with its bitterness, and is exceedingly rich when pickled. Excellent in the San Joaquin Valley both for oil and pickles.

Manzanillo No. 2.—Imported by F. Pohndorff from Spain. As the name ("small apple") indicates, this variety is nearly round, with a pit of rounded oval shape, rather squarely cut off at the base. This variety ripens early—several weeks earlier than the Broad-leaved Mission olive; the fruit grows generally singly on long stems.

Rubra.—Imported by John Rock from France; ovate, slightly oblique, looks a good deal like a small Mission olive; pit straight, pointed; ripens three to four weeks earlier than the common Mission variety; is of a jet black when ripe. This tree begins to fruit quite young, and is a prolific bearer. Very hardy and prolific even in dry situations.



Oblitza as Grown by Geo. C. Roeding, of Fresno.

Uvaria.—Imported by John Rock from France. Oval, regular, and rounded on both ends; pit straight, heavy, late; later than the common Mission olive; color dark purple or black when ripe. The name, "grape-like," is well chosen, the fruit growing in clusters, as many as seven to-

gether, and in shape themselves resembling the grape. Very prolific.

Pendulina.—Imported by John Rock from France. This variety is of an even, oval shape, rounded at both ends, quite variable in size, many fruits remaining small and undeveloped; pit has small, sharp points often at both ends. Fruit grows in clusters of from two to five; the pulp parts very readily with its bitterness. Larger and more ovate than *Pendoulier*. Tree a strong grower; fruit desirable both for oil and pickles.

Columbella.—Imported by John Rock from France. General form, broadly oval; very even in size, remarkable for the peculiar pale yellow color which all the fruit assumes before turning fully ripe and becoming dark purple; pit small; straight and sharp-pointed; the pulp contains little bitterness; flavor very rich; ripens late, later than the Broad-leaved Mission. Tree hardy in dry places and a prolific bearer.

Polymorpha.—Imported by John Rock from France. Very large, ovate, oblique, and pointed; light colored; pit square at the base, strongly pointed at the apex; flesh firm; ripens very early; fruit grows on strong stems in clusters of two or three. Tree not a strong grower, but productive.

Lucques.—A variety specially adapted for pickling, though producing oil of good quality; strong-growing tree and hardy; sometimes shy bearer when young; fruit shiny black, curved; product called "Crescent Olive."

Nevadillo Blanco.—Imported by F. Pohndorff from Spain. Oval, slightly oblique, pointed, resembling somewhat a Mission, but is generally more elongated in proportion to its diameter than the latter; pit small, curved, and generally pointed at both ends; the fruit is borne in clusters of three to five; ripening not much earlier than the Mission; a fine oil olive, largely planted, but disappointing in some regions as a shy bearer and subject to frost injury.

Oblitza.—Imported by the late N. Milco from Dalmatia; resembles the *Pendoulier*, and may be identical; fine in the San Joaquin Valley and pronounced by Geo. C. Roeding, of Fresno, the largest olive so far fruited by him; oval, but broad and rounded at both ends; grows in clusters; tree a good grower, hardy and productive; fruit excellent for pickles; ripens in November in the interior—about the same as the Mission.

Sevillano.—Recently largely planted as the variety exported from Spain as the "Queen olive." The largest of all olives; only useful for pickling; when ripe, bluish black; clingstone. Tree a strong grower, leaves deep green, greenish white underneath. Described by Mr. Roeding as a regular bearer, but requires deep, rich, well-drained soil and will not stand much cold.

The foregoing enumeration and description of varieties is only partial and mainly restricted to varieties which have been more or less largely planted. Many more have been experimentally fruited and data are available at the University, as already stated. The following are the leading facts as to size, pit, and oil contents of the varieties which have been most largely planted, and a few others:—

AVERAGES OF OLIVE VARIETIES, DETERMINED AT THE UNIVERSITY OF CALIFORNIA.

VARIETY.	Number of Olives per pound.	Pit, per cent.	Oil, per cent, in whole fruit.
Mission.....	111.6	17.2	17.56
Nevadillo Blanco.....	157.3	17.3	19.21
Manzanillo.....	106.6	14.7	16.94
Redding Picholine.....	398.2	23.0	16.18
Uvaria.....	205.1	25.5	13.71
Rubra.....	196.1	17.9	18.58
Oblonga.....	179.4	18.7	13.34
Columbella.....	114.6	16.6	15.59
Pendulina.....	157.1	13.7	18.63
Polymorpha.....	71.9	17.1	15.85
Macrocarpa.....	72.8	17.5	14.70
Regalis.....	112.5	16.3	16.37
Correoiolo.....	262.7	25.8	21.15
Razzo.....	216.5	24.3	21.10
Frantoio.....	298.9	25.9	24.10
Cucco.....	192.9	21.1	27.22
Leccino.....	245.5	21.7	22.45
Grossaio.....	242.3	25.7	23.96
Palazuolo.....	272.1	22.2	29.34
Infrantoio.....	375.0	30.0	19.31
Lucques.....	192.9	23.0	14.81
Picholine.....	77.0	17.5	17.83
Ascolano.....	60.6	12.0	16.26
Oblitza.....	105.2	14.6	11.23
Empeltre.....	111.4	15.7	19.86
Sevillano.....	36.2	14.5	17.23

CHAPTER XXX.

THE ORANGE.

The orange has held a leading place among California fruits ever since the American occupation, and during the last decade has rapidly advanced in investment and in product. The greatest year in output was that which closed November 1, 1898, with a total shipment of over 14,000 car-loads to various points beyond State lines, which was nearly four times as great as the product of 1890. The product of the year ending November 1, 1899, was about one-third less in bulk because of drouth, but in value it was greater. The frost injuries in Florida and the protective tariff on imported fruit added greatly to the market value of the California product.

Southern California still maintains distinctive claim to credit as the citrus quarter of the State, for her seven counties furnished more than ninety-five per cent of the product, and her position is not likely to be seriously questioned. There is only ten per cent of the orange acreage of the State in more northerly regions, nor is there serious reason to apprehend that the ratio of acreage will materially change in the future. Still, to conclude, from the commercial supremacy of the southern counties in orange production, that all the southern country is fitted for the growth of this fruit, and that more northerly counties are not, or to decide from recent considerable increase in the northern product that all the north is thus endowed, is both incorrect and misleading. Certain southern situations have been proved to be unsuited for profitable orange production, and certain northern situations are also unfit. The considerations urged in the first two chapters of this work show that, so far as temperatures go, citrus climate can not be attributed to different geographical divisions of the State. Within a north and south distance of above four hundred miles oranges are successfully grown on a commercial scale, in proper situations and soils, and temperature extremes are practically identical within this long stretch of latitude. The fact stated in Chapter I with reference to topography, which brings earlier maturity to fruits at the north than at the south, has direct relation to the produc-

tion of oranges, as of other fruits, and is of advantage to both districts in that it lengthens the marketing season of the fruit, and, to a certain extent, relieves both from competition.

SITUATIONS AND SOILS FOR THE ORANGE.

Though it is acknowledged to be impossible to speak geographically concerning the success of the orange, there are a few generalizations concerning suitable conditions which may assist the planter in choosing locations. The lowest temperature reached in our fruit districts since American occupation, has not seriously injured mature wood of the orange, except in notoriously unfit situations, but it should be pointed out that injury to mature wood is wrought much below the limit of safety to the product. The fruit is very liable to injury at a slight drop below the freezing point, and where such temperature is reached every winter, the orange tree would be little more than ornamental. Even in our best orange regions there is occasional injury to the fruit and to young trees, and apprehension is felt as the frost season approaches, but this, of course, is the case in many other orange regions of the world. As will be shown in a later chapter, Californians have achieved notable results in protection of citrus fruits against frost injury.

Situations not far distant from each other often differ greatly in suitability for the orange, the chief elements of the variation being elevation, exposure and soil. The orange tree, to be thrifty and profitable, should have deep, rich, and permeable soil. The soil should be fairly retentive of moisture and yet not heavy enough to prevent escape of excess of water. It should be light enough to work readily in cultivation and yet not so loose as to dry out readily by evaporation or leaching. A first-class loam of adequate depth answers these requirements. Substrata of hard-pan or of sand and gravel are undesirable and have caused planters much loss and disappointment. Due examination should be made for such defects before planting. A subsoil of clay loam is not objectionable providing the surface is of lighter character. In fact, a clay loam is being successfully used in several of our best orange districts—the chief objection to it being its disposition to be refractory in tillage. In some regions it is called "adobe" in contrast to the prevalent sandy soils of the region, but it is not adobe in the correct use of the term.

A certain elevation above the low ground of the region is very desirable because of escape from frost, as already explained in Chapter I, and shelter from currents of cold air is sometimes locally of much importance. The principles involved have already been discussed.

These are presented as ideals in the selection of situation and support for orange trees. Of course there are trees grow-

ing and bearing fruit in places and upon soils quite otherwise than as described; and in family orchards, where conditions do not absolutely preclude fruitage, the orange should find a place. Thrifty and profitable trees can be found even on adobe, where extra attention is given to timely and thorough cultivation. In selecting location for extended commercial planting, however, the very best situation should be diligently sought for. The provision of irrigating facilities is governed by the conditions noted in Chapter XV. In certain places where moisture is supplied by natural underflow in an open soil which does not become soggy, good fruit has been produced without irrigation, but in situations otherwise best suited to the fruit, bearing trees will require water. There have been losses and disappointment by planting in excess of available water supply. On the other hand serious mistakes have been made in planting in soils not capable of proper drainage. The orange tree is exacting of properly regulated water supply: if denied this it will yield poor fruit.

PROPAGATION OF THE ORANGE.

The orange is grown from cuttings, layers, and seeds. Growth from the seed is the method almost exclusively followed, and by far the best, but the others will be mentioned briefly.

Growth from Cuttings.—This method of propagation is described in the chapter on propagation.

Growth from Layers.—The orange roots readily by layering, the drooping branches being partly cut through, buried in the soil with the terminal shoot above ground. Layers must be kept moist. Layering may be employed to obtain a few plants easily, but, otherwise, it cuts no figure in propagation. Layers and cuttings, of course, reproduce the original variety without recourse to budding.

Growth from Seed.—Good plump seed should be selected in growing orange seedlings either for their own fruitage or to use as stocks for budding. When seedlings for fruiting are grown, select seed from a choice variety in a situation where other citrus species are not grown; but the orange can not be trusted to come true from seed, and, more than this, the seedling class for fruiting purposes has been practically abandoned as unprofitable to plant, though fruit from old seedling trees is occasionally sold at a profit.

The seed chiefly used in this State at present is obtained from cheap seedling fruit. When thoroughly decayed, the fruit is pulped by mashing in a barrel, and the mass is washed, a little at a time, on a coarse sieve, the pulp passing through, and the seed being caught on the wires, and pieces of skin thrown out. The plump seed will sink if thrown into water, and the

imperfect can be skimmed from the top. The seed should never be allowed to dry, and unless it is to be sown at once, should be stored by mixing with moist sand, from which it can be afterwards removed by sifting. The best time for sowing orange seed is after the ground has become warm in the spring.

Orange seedlings are grown either in boxes or in the open ground. In either case a rich sandy loam which will not bake should be secured or artificially made by mixing sand with rich garden loam. Boxes of about two square feet area and six inches deep are convenient to handle. The bottom should have holes, or sufficient crevices for good drainage. Fill the boxes about four inches with the prepared soil, place the seeds about an inch and a half apart each way, and sift over them about an inch of the soil, or a little less of the soil and a layer of clear sand if it is at hand. It is essential that the soil should be kept moist, and light sprinkling daily or each other day with water that has been warmed by standing in the sun, is desirable. Seed can be sown in boxes in the house at any time, if plenty of light and heat are given. If the boxes are to be out-of-doors, it is best to sow in the spring, and to rig up a cover of cheap cotton cloth, suspended about a foot above the surface, to prevent effect of frost at night, and of burning by sun heat by day. The seedlings usually appear in about six weeks, and with good care in weeding and keeping sufficiently, but not excessively, moist, they will make a growth of about a foot the first season. Some growers collect the boxes in a sheltered place, and build over them a lath house, tacking on old sacks or other cloth, to shield from sun and frost. The lath house keeps animals from running over the boxes, etc.

Growing seedlings in an open bed involves about the same operations. To guard against intrusion, it is advisable to make board sides to the bed about a foot high, and to make lath frames which will reach across, resting on the edge boards. A cloth sun-and-frost shade is also desirable, to be laid over the lath frames when it seems needed. Beds should be made narrow enough so that one can easily reach half way across from each of the long sides for weeding, etc. In open seed beds it is usual to sow the seed broadcast.

The Orange Nursery.—Planting out in nursery is usually done after the ground is thoroughly warmed in the spring, and the seedlings are then about a year old. The preparation of nursery ground and the planting out of the seedlings can be done as described in Chapter VIII. Orange seedlings should, however, be given greater distance apart than is usual for deciduous trees, because the orange remains longer in nursery, and because it is often desirable, when taking up, to sack the ball of

earth embracing the roots. If the roots are not to be sacked, about nine inches will do between the plants; if to be sacked, the distance should be twice as great. The rows should not be too close in the orange nursery. If horse cultivation is to be used, at least four feet between the rows should be allowed, and even greater distance is desirable. In taking the seedlings from the seed beds, a few should be lifted at a time, and their roots kept shaded and moist until the ground closes on them in the



Budded Navel Orange Tree, about Five Feet High.

nursery row. To get an even stand in the nursery, small and weak plants should be placed by themselves, or set in boxes to take another year before going into nursery.

Young trees in nursery are very liable to frost injury, and it is wise to protect them by some sort of a cover during the winter.

A framework covered with cypress brush is often used, the whole being cleared away in the spring, to allow of summer cultivation. Cultivation of trees in nursery is about the same as with deciduous fruit trees. The horse should be used, and the surface kept perfectly pulverized. The cultivator should follow irrigation as soon as the soil will admit of it. Frequency of irrigation of nursery depends, of course, upon local conditions. Some give two or three irrigations, by running the water in a little trench alongside the rows, at intervals of two weeks, for a time after planting, and then irrigate once a month during the summer. It is important that irrigation should not be continued too late into the fall, because the young tree should harden its wood before cold weather. Nor is it desirable that the growth be too rapid. A good growth of sound wood is better than extra size.

Length of Time in Nursery.—Seedlings are usually budded after being one or two years in the nursery, or at two to three years from the planting of the seed. At a convenient time in the winter the lower shoots and thorns are removed from the seedlings, so as to leave a clear stem of about six inches, for the convenience of the budder.

BUDDING THE ORANGE.

The orange root is the best foundation for an orange tree, and the seed of the seedling sweet orange is the main reliance. The seedling of the Florida sour orange has been used to some extent to escape gum disease. It has not been a perfect recourse, though it seems to be agreed that the sour stock is much less likely to gum. Oranges have also been worked upon pomelo seedlings, which force a strong growth, but time enough has not transpired to demonstrate results. Of course many lemon, and recently many pomelo trees, have been worked over to the orange, but in these cases the orange root was below the other wood. All lemon roots are not suitable for the orange. The Japanese practise of dwarfing with the *citrus trifoliata* has never prevailed in this State.

Budding is almost exclusively adopted in working in desirable varieties. The best time to bud is about the time the new growth starts on the seedling in the spring, though some practise budding in midsummer and fall. Good, well-matured buds only should be used; those from both base and tip of the shoots are frequently defective. The method of budding described in Chapter IX is that usually employed in budding citrus trees, and the rules for loosening the ligature, etc., are similar. Midsummer buds are apt to have soft growth at the coming of cold weather; fall buds remain dormant until spring; spring buds start to grow almost immediately, and have the ben-

efit of the whole summer season for growth and maturing of wood.

After the bud has started out well, the top of the stock should be removed at a short distance above the bud, and suckers on the old stock should be continually looked for and removed. The tender shoot of the bud is protected by tying to the stub, as shown in the engraving (from Lelong), and when the growth of the bud has become strong enough to support itself, the old stock is smoothly sawn away at the line O, and the wound covered with liquid grafting wax, or paint.



Supporting the Bud.

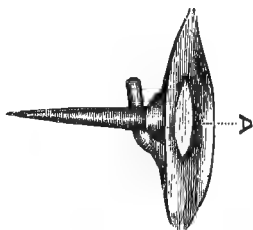

Cutting a Bud with a Thorn.

The care of budded trees in nursery is similar to that of the seedlings of the previous year. If too great a tendency to branch low down is observed, the tips of the lower shoots should be pinched, but it is not desirable to underprune much; the retention of the lower branches thickens the stem. Sometimes a very rank growth on the bud will need a stake to strengthen it or protect it from blowing out. The intrusion of gophers and other vermin should be resolutely and persistently guarded against.

Working over Old Trees.—Old orange trees can be transformed into improved varieties either by budding or by grafting, as described at the close of Chapter IX, though re-working by grafting has been almost entirely superseded by budding. The common way to bud over an old tree is to cut back part of the branches and force out new shoots, the best of which are selected for budding and the others removed. Sometimes only a part of the tree is removed at first, and when the new buds have grown out on that, the other part is similarly treated.

Recently the practise of budding into old bark has been widely adopted as the quickest way to secure a new tree. As with working into old bark in other trees it is necessary to take an older bud and a larger, thicker shield of bark behind it, than when budding into younger stock. Some remove the wood from the back of the shield, but generally it is not done. The following is an outline of practise approved by the Redlands Horticultural Club:—

Keep the buds carefully in a damp cloth. Slide the bud upward, above the cross-section. Bind around the bark, steering clear of the buds proper, a wrapping of waxed cloth, already prepared, three-fourths of an inch wide. When enough of this has been wrapped about the tree trunk or branch to keep the bark and the bud in place, rub the end of the muslin strip with the handle of the budding knife, down upon the muslin already wound about the bark. This will hold the waxed wrapping firmly in place. From ten days to two weeks after the buds have been inserted, cut off the entire top of the tree, above the buds, and cover the stump of trunk or large branch with grafting wax—applied hot—with a brush.

As soon as the wax is put on—and it must be put on as soon as the top is sawed off—whitewash the tree, over the waxed cloth, also over the bud, over every part of the tree that is left, except the stump ends, to which the hot wax has been applied. Immediately the buds will begin to grow. From ten days to two weeks after whitewashing take off the muslin wrap, and, if the work has been done carefully, in accordance with the above directions, 90 per cent of the buds will develop—perhaps more. A prime necessity for this work is a razor-sharp budding knife.

There is a variation in practise in cutting back the stock above the bud. Instead of cutting back at once, heroically, as just described, some cut back part of the top at a distance above the bud, cutting down to the bud after it shows good strong growth, tying the young growth to the stub at first to protect it. Others insert the bud in the fall, cutting back to start the bud after the fruit on the old top is gathered. It is very important to watch for suckers below the bud and remove, or pinch them back, to make a bunch of leaves. The growth from the bud itself often needs pinching to induce low branching. Twig-budding can also be used on the orange by the method already described for the olive.

Budding in old trees is best done in the spring, when the sap flow is strong, but, as stated, can be done in the fall and the bud allowed to lie dormant until spring.

PLANTING ORANGES IN ORCHARD.

As already stated, orange trees are planted out at greater age than deciduous fruit trees. Budded trees are given one or two years' growth in nursery and one or two years' growth on the bud, which, added to the year in seed bed, makes them three to four years of age from the sowing of the seed. Seedlings, to be planted out as such, are allowed two years' growth in the nursery, which makes them three years old from the seed. For this length of time and the unusual care involved in their growth, taking up from nursery and preparation for carriage, orange trees of planting age are of much greater cost than deciduous fruit trees.

Since the growing of seedlings for their fruit has practically ceased, the distance between the trees in orchard planting has ranged from twenty to twenty-four feet. All the varieties now

propagated are quick to bear fruit and if properly shaped will find ample space in these distances—the greater distance on the richer soil as a rule.

Preparation of land for orange planting by deep and thorough cultivation and laying off to secure straight rows by the square, quincunx, and hexagonal methods have been quite fully discussed in Chapter X, and Chapter XI has suggestions for planting, many of which are applicable to the setting of orange trees. There are, however, special methods employed in lifting the orange trees from the nursery rows and in placing them in permanent position, which will be outlined.

The orange, in common with other evergreen trees, is exceedingly sensitive to exposure of its roots, and for this reason the handling of the young trees is very different from that of ordinary orchard trees. Three ways are employed for securing this constant moisture of the roots, as follows:—

Packing in Wet Straw.—As fast as the trees are lifted from the nursery ground by digging carefully so as to loosen and secure all the roots possible, they are packed in damp and partially rotten straw, proper receptacles being at hand so that the roots are not exposed by carrying them any distance. In taking up, all roots bruised by the spade are cleanly cut with a sharp knife. The taproot is cut away at a depth of a foot or so from the surface. This use of wet straw, if faithfully carried out, will answer well in taking trees short distances for planting, but the use of a puddle on the roots before packing in damp straw gives additional assurance of success.

Puddling the Roots.—This method is also used for deciduous fruit trees, as mentioned in Chapter XI. It consists in having a thin pudding of loamy soil with preponderance of sand rather than of clay, into which the roots are dipped as soon as the tree is lifted from the nursery. This mixture, which should be about as thick as cream, may be made in a hole in the ground, or, better still, in a box or cask large enough to allow complete plunging of the roots. As soon as dipped, and with all the mud which will adhere, the roots are packed in wet straw. If the trees are to remain thus packed for any length of time, the greatest care must be observed to keep the straw damp, and water must be applied gently to avoid washing the puddle from the roots.

Sacking the Roots with a Ball of Earth.—This is a very satisfactory way to move orange trees, and if it is well done, the tree does not wilt, and may be moved long distances and handled more freely than the puddled roots. To ball and sack trees, dig a trench along one side of the row about six inches away from the trees, and about a foot and a half deep. By careful digging

under each tree from this trench the taproot is reached, and severed by a cut with a sharp spade. The side roots are also cut by thrusting the spade down on the three sides not opened by the trench. The top earth is carefully removed nearly down to the highest lateral roots, and after being sure that the roots are severed all around, the tree is lifted out with the ball of earth which incloses the remaining roots. This ball is rounded off carefully and then placed on a half of a grain sack or other piece of burlap, the corners of which are drawn up and tied around the stem of the tree with baling rope. It is also an additional surety of safety to allow the baling rope to run under and around the ball to aid in holding it together. The balled trees must be carefully handled so as not to break the ball, which would result in tearing to pieces, as well as exposing, the roots.

The manner of handling the trees depends somewhat upon the character of the nursery soil. Successful balling of course requires a certain amount of adhesiveness in the soil.

One can not be too careful in the handling of orange trees. Though they will stand harsh treatment when in permanent place, they must be most carefully transplanted. Lifting from the nursery when the soil is too dry, exposure of the roots, or careless planting, will consign the tree to a slow, sickly growth, and often kill it outright.

Cutting Back at Transplanting.—The rule of reducing the top to compensate for the loss of roots, is vital in moving orange trees, but sometimes cutting back is carried too far and subsequent growth is checked rather than promoted. Some growers cut back the young trees a little while before lifting from the nursery. Some take off all leaves after planting out; and claim that growth starts sooner and more strongly, but is doubtful whether defoliation is advisable, except in case of wilting, when it is necessary.

Digging Holes and Setting Trees.—The same considerations which require extra care in lifting trees for nursery, rule in placing them in permanent place. All authorities on the subject specify exceptional care in preparing the tree holes as a profitable investment on the part of the planter. Large and deep holes are commended, provided the planting is being done in a deep, free soil. Deep holes would be more injurious than beneficial in a tight subsoil, unless drainage were furnished, but there are good orange trees now bearing in such places—good enough at least to be an ornament and acceptable fruit producers for family use.

On large-scale planting in deeply prepared soil, holes large enough to allow good spreading of the roots are sufficient. Handling the soil at planting has been fully described in Chapter XI, and the importance of bringing the soil into firm contact

with the roots has been urged. The use of water in planting citrus fruit trees is especially desirable. Transplanting should be done just as the growth is starting in the late spring or early summer, and this is the opening of the dry season and rains can not be expected. Therefore when the roots are arranged and the top soil lightly tramped around them, water is run in the hole and the earth compacted around the roots by water settling. After the water has settled away, the hole is filled and the surface left loose to prevent evaporation.

These instructions apply to the planting out trees which are taken up with long roots and puddled. In planting out balled trees, the sack is not removed, but after the tree is embedded in the earth, the tying rope is cut. The sack soon decays in the soil.

Orange trees can be successfully transplanted at different times of the year, but the best time, as just stated, is after the ground gets well warmed by the spring sunshine. The date at which this condition arrives depends upon locality. Experience seems to indicate that the young orange tree is in best condition to transplant just as the new growth is starting out, and preferably when it has not grown out more than two inches.

Great care must be taken that transplanted orange trees do not become dry after planting. The methods of irrigation are described in Chapter XV. Good cultivation should also attend the orange from its first planting onward. This subject is fully discussed in Chapter XIII.

PRUNING THE ORANGE.

All the considerations urged in Chapter XII in favor of low-headed and strongly-branched trees apply to the orange, though the habit of the tree in growth and bearing requires different pruning policies. The orange tree is more disposed naturally to assume a good form than most other trees, and for this reason most experienced growers declare their belief in pruning as little as possible, which is unquestionably good policy, providing attention enough is given to securing a shapely and convenient tree and to overcome the tendency in the young tree to run out very long shoots which result in unsymmetrical shoulders with hollows beneath them, or to assume a weeping habit, which interferes with irrigation and cultivation and prevents the development of good bearing space above. It is so easy to bring the orange into good shape by a little hard thinking about what shape is desirable and a very little timely cutting and pinching to secure it.

The orange tree should assume a compact wall of foliage. The interior of the tree is merely the framework to support this

and pump sap into it. It has been held that it was necessary to prune the young tree to quite a high head at first to allow for the natural droop of the branches and the result is seen in many young trees with slim stems and umbrella-like tops. It is better to develop a stout stem by allowing for a time a low growth upon it and then raise it later by removal of the lower growth which has done good service and outlived its usefulness. By wise underpruning it is possible not only to secure a shapely and con-

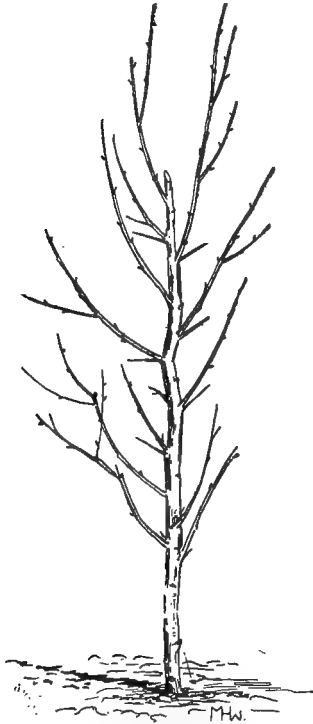
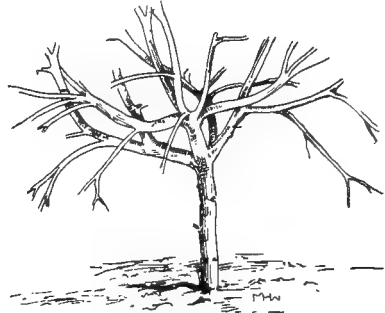

FIG. 1. Orange tree at planting in orchard—3 feet high.



Result of neglect in forming head.



Better form secured by training.

venient tree but also to so train the lower growth that it shall present good, low bearing wood without groveling in the dust.

Unquestionably the drooping habit of budded orange trees is largely due to their treatment. A grower who does not believe in pruning allows the branches to extend too far horizontally and the weight of the foliage and the early fruiting brings the branches to the ground. To relieve the lower branches of the young tree of a part of this weight will enable them to assume a better direction, and this slight relief at first will prevent much

branch-sawing in later years. The young tree as it comes from the nursery usually starts upon an upright course. If stopped at about three feet it can be brought along to develop strong and well-arranged branches, much as has been described for deciduous fruit trees in Chapter XII. The adjacent engraving, Fig. 1, shows a young tree in planting condition, stopped at three feet and needing only a slight cutting back of the laterals to be ready to begin its orchard life. If young trees are transplanted short distances and at the right time they do not need so much cutting back as is commonly given them. If allowed to grow from the start shown in Fig. 1, pruning only to prevent

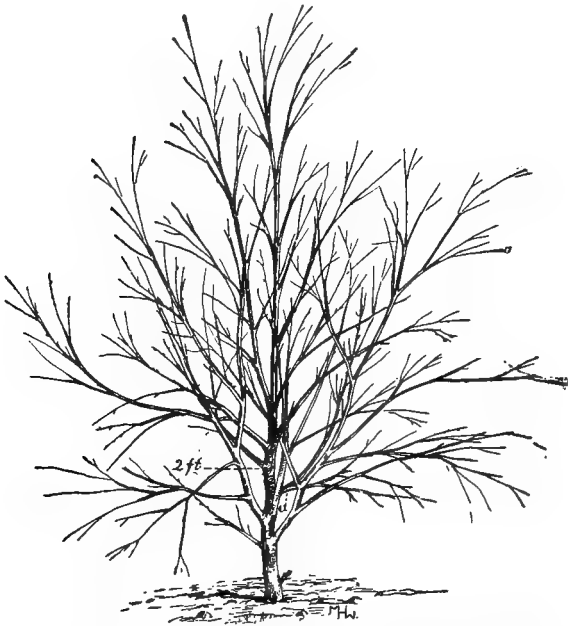

FIG. 2. Branch-form of Orange before Removal of Lower Branches.

long branches from running out at random, and removing branches which may start strongly from near the base, the tree will assume the branch-form shown in Fig. 2 and at from two to three years after planting in the orchard. At about this age the removal of lower branches begins, as they have served their purpose in shading the trunk and bearing the first fruit. These branches are removed one by one until, when the tree is five years in the orchard, it has lost all branches below the two-foot line except the one branch marked "a" of which the upright-growing part will be retained. The higher branches assume the

more horizontal habit, too great out-shooting is repressed and at about five years orchard-age the tree attains a height of about twelve feet and is of the general form shown in Fig. 3. The next few months will bring its foliage to the ground to remain there or to be under-trimmed, as the notion of the grower may be.

BUILDING DOWN AND NOT SAGGING DOWN.

It is perfectly feasible and rational to secure a good form of low tree without removal of large branches and without relying upon the sag of the branches from a high head. It requires rather more watchfulness and attention and study of the subject than some growers desire to give, but the results when attained



FIG. 3. Good Form of Five-year-old Orange Tree.

are very satisfactory. The method is that of J. H. Reed, of Riverside, and has been followed by him for a number of years with his own orchard and others of which he has had charge. It will be found readily intelligible with the help of the sketches. Mr. Reed would begin with a young nursery tree like that already shown in Fig. 1. He does not believe in much cutting back before planting providing a fair amount of roots are left in the ball at transplanting. If the tree has been properly planted and cared for, it will soon begin to put out new growth, usually first along the stem, the strongest growth being lowest down. As many of these young branches along the stem as are not desired for permanent branches, are rubbed off, the earlier the better, at least before woody fiber is deposited in them. Mr. Reed rubs off promptly all below a point about two feet from the ground, if there is a prospect of getting sufficient good branches above that point. If not he saves them down eight or even twelve inches lower if need be.

Mr. Reed's idea is to build the head along a considerable length of the trunk and not have the branches bunched at the top, and this is the same idea that is urged in the development of the trunk of the deciduous fruit tree in Chapter XII. He finds it impossible to do this in the nursery because if it is attempted to form a head 18 or 24 inches along the upper portion of the stem instead of one bunched near the top of it, the lower branches will appropriate most of the sap and the upper portion

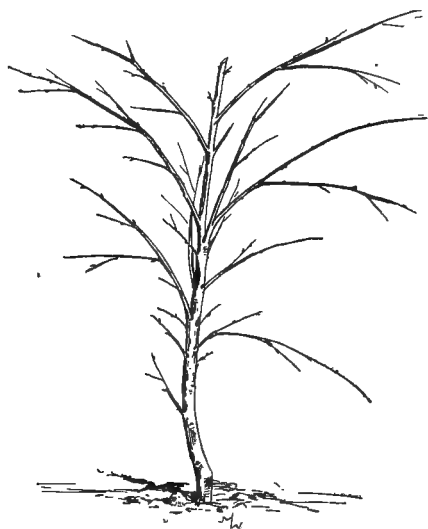

FIG. 4. Branch-form of Orange Six Months after Planting.

will not be well developed; while if this upper story is well established in the nursery the lower portion can be built on without detriment to the upper, if nutriment sufficient for both is furnished. Fig. 4 will show approximately the branch-form of the young tree at about six months from planting and the shoots with which the building-down is begun. The first step is to check the drooping habit. Upon this point Mr. Reed says:—

The common notion that the branch of the Navel orange naturally tends down is a mistake which grows out of the fact that in its rapid growth the new part of the stems and large leaves are so loaded with sap that they pull the stems from their natural upright position, and, unless relieved, hold them there till the deposit of woody fiber fixes the branches in the drooping or unnatural position. If the tips of these rapidly-growing branches, with their heavy leaves, be clipped at the right time, the branches will spring back to the erect position, where they will remain to send out new branchlets. It is wonderful how the orange tree can be molded like a thing of wax by pinching and clipping here and there, if done at the right time.

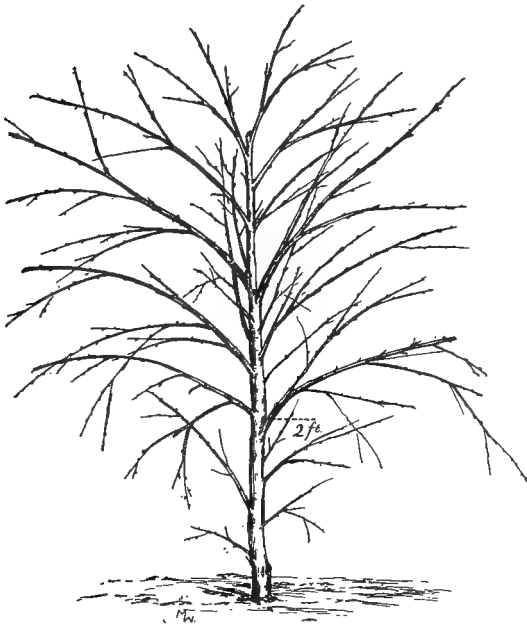

FIG. 5. Tendency of clipped branches to rise.

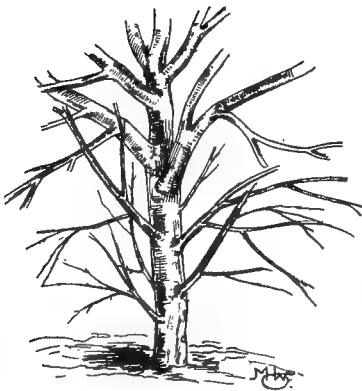

FIG. 6.
Branch-form of five-year-old tree built down.

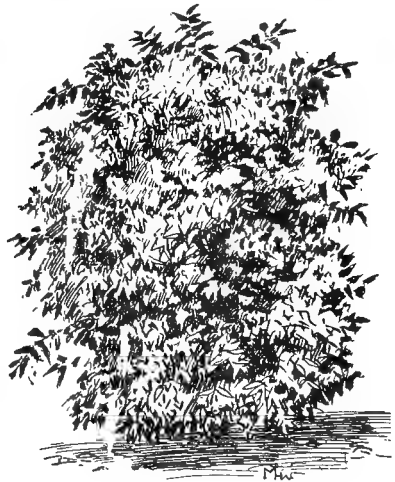

FIG. 7.
Foliage-form of five-year-old tree.

Fig. 5 shows the result of this clipping of heavy shoots to allow them to assume a more upright growth and the encouragement of new shoots below the two-foot mark. Fig. 6 gives the branch-form of a five-year-old tree, with its lower story of bearing wood well developed, and Fig. 7 is the foliage-form of the same tree, about fifteen feet high, with its leaves and fruit reaching to the ground. As to how low the branches should be allowed, Mr. Reed says that until recently he has thought it best to keep the lower branches clipped back so that the fruit would not touch the ground, but he is persuaded that it is better to let them come to the ground even if considerable fruit rests on it. He finds that many of the best orchardists do this, and claim that there are really less culls among the fruit on the ground than on the less-protected branches above.

Later Pruning of the Orange.—After the form of the orange is well established the aim should be to preserve a compact wall of foliage of symmetrical and convenient form. It is desirable that weak wood should be removed. As to the removal of dead interior branches, which have given up the struggle for the light, the theory is that they should be removed: the practise is that they very seldom are. It is an appalling undertaking to get into the inside of an old orange tree and saw off and drag out the dead wood. We can not settle the question: each reader must adjust it to the satisfaction of his own conscience. Some accomplish this by claiming that the interior dead branches help to sustain the weight of the live ones. There is, however, a reasonable amount of thinning to be done. The clipping back of ambitious shoots multiplies laterals. There should be a complete wall of leaves, but the crowding of leaves on leaves excludes light and air and weakens the tree by lessening the vigor of leaf-action. Dead twigs which appear among good bearing shoots should always be removed. The gourmand shoots or suckers should be repressed, unless, by clipping, one can be turned into a branch where a branch is needed.

DISEASES OF THE ORANGE.

The orange is thus far subject to few diseases in California. The most grievous is the so-called gum disease, which is analogous to the gumming of other trees and will be discussed in the chapter treating of tree diseases. Cracking of the fruit will also be mentioned in that chapter.

There are several serious insect enemies of the orange, which will be discussed in the chapter on that subject. The "black smut," which makes leaves and fruit unsightly in some parts of the State, is a fungoid growth upon the exudations of insects, and can be prevented by removing its cause.

VARIETIES OF THE ORANGE.

Though many varieties of the orange have been introduced in California, but few are generally grown. During the last few years there has been a pervading disposition to concentrate upon the Washington Navel, and, except to get other varieties either earlier or later to extend the season, there seems little reason to go beyond the Navel for commercial purposes. Not only have recent plantings been predominantly of this variety, but old trees of other kinds have been very largely budded over to it, and this work is still going on at a rapid rate.

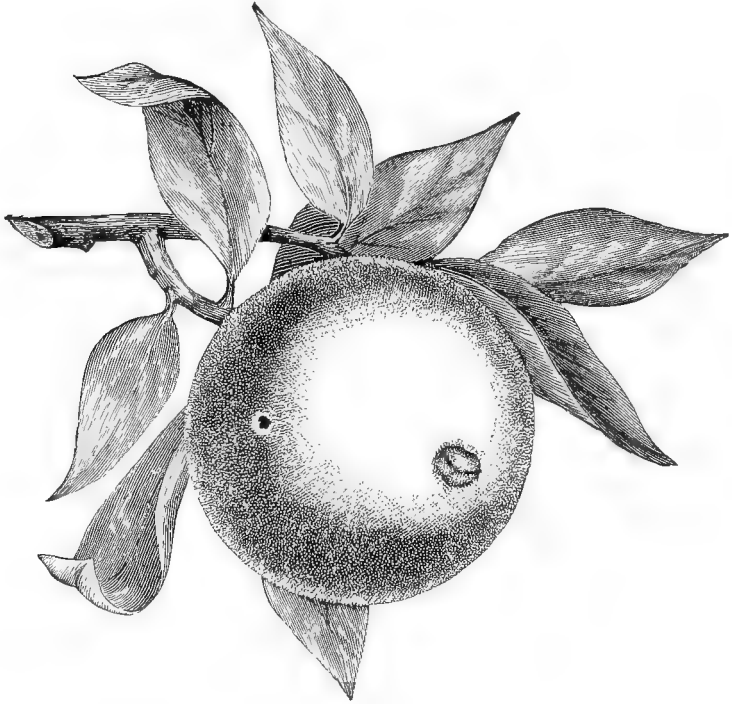

The Navel Orange, Showing Characteristic Mark.

Of the few varieties which are now largely grown the following is the ripening season:—

Navel and Seedlings, November to May; Malta Blood, March to June; Mediterranean Sweets, April to July; St. Michaels, May to July; Tardiff, June to September.

Washington Navel (*Bahia, Riverside Navel*).—This orange is the most popular of all foreign varieties grown in this State. Fruit large, solid,

and heavy; skin smooth and of a very fine texture; very juicy; high flavored, with melting pulp; is practically seedless, only in exceptional cases are seed found; tree is a good and prolific bearer, medium thorny, a rapid grower, although it does not attain a very large size; bears when very young, commencing to bear as early as one year old from the bud; ripens early. This variety was imported from Bahia, Brazil, in 1870, by Mr. W. Sanders, of the Department of Agriculture at Washington, and in 1874 two trees were received from Washington by Mrs. Tibbetts, of Riverside, Cal. Trees were also received about the same time by Alexander Crow, but the Riverside trees were first in fruit, and the excellence of the variety being at once recognized, it was propagated rapidly and took the name Riverside Navel from the place where its characteristics were first made known. As it came to be grown largely in other districts as well, a broader name, recognizing its receipt from the national capital, was adopted, and is likely to stand.

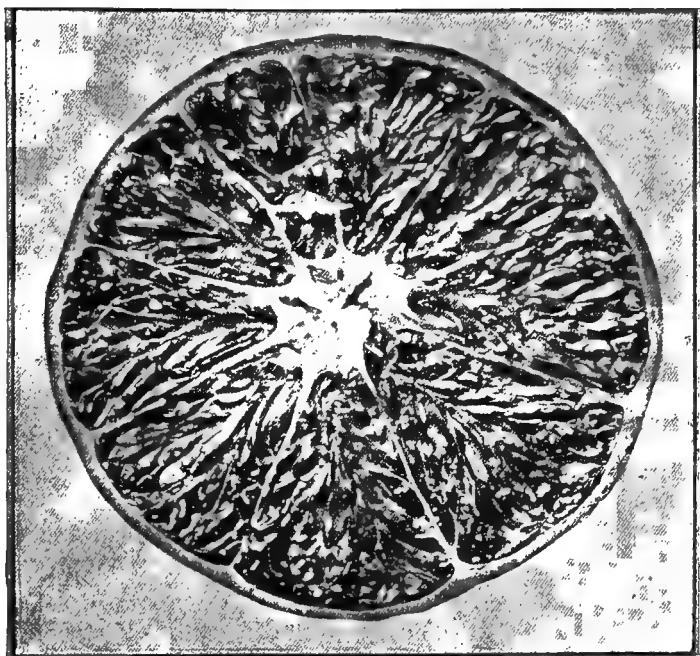

Cross-section of Improved Navel Orange.

There is some variation in the Washington Navel, and higher types are to be found involving departures in the direction of thinness and silkiness of rind, etc., as well as interior characters. The most prominent of these is an improved Navel which A. C. Thomson, of Duarte, Los Angeles County, claims is a sub-variety, produced by a process of propagation, which he does not disclose, but whether the excellency of the fruit is to be attributed to his method or to the exceptionally favorable soil and climate of his location, or whether he has merely a natural

variation of especially good points, is not fully established. It has recently advanced in favor among planters.

Australian Navel.—A coarser type of the Navel introduced from Australia in 1874 by Lewis Wolfskill, of Los Angeles, and largely propagated formerly. It has now been practically abandoned for the Washington Navel. It seems to be of more account at some points in the San Joaquin Valley than elsewhere.



Valencia Late.

Maltese Blood.—Fruit small to medium, oval; flesh fine texture and flavor, streaked and mottled with red; few seeds. The tree is thornless and regular and heavy bearer.

Ruby.—Medium size, roundish; when ripe often reddened by deep red pulp within; juicy and sprightly, often rather acid; tree vigorous, thornless and a good bearer.

Mediterranean Sweet.—Fruit medium to large, pulp and skin of fine texture, very solid and few seeds; ripens late, often not until May or June. The tree is thornless and of dwarf habit of growth and is inclined to overbear. It was at one time the most widely-distributed variety in the State, next to the Washington Navel, but has recently been largely budded over. It was introduced and named by T. A. Garey, of Los Angeles.

Paper Rind St. Michael.—Fruit small, round, very firm and very juicy; pale, thin skin; very elegant in appearance. It ripens late and keeps well on the trees as late as August; tree is of dwarf habit, medium thorny, a good bearer, and very desirable.

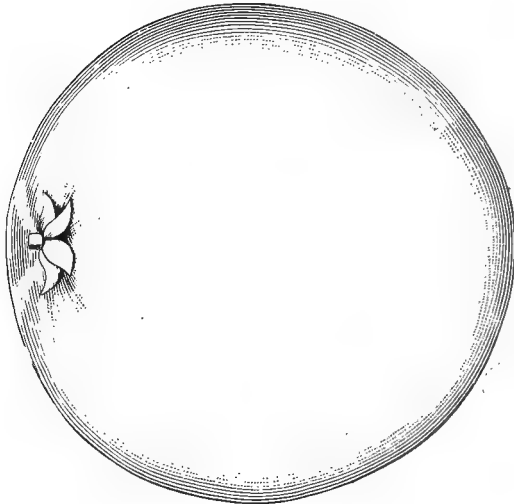

Paper Rind St. Michael.

Valencia Late (Hart's Tardiff).—Medium size, oblong, pale yellow; flesh rich, deep yellow, sprightly and crisp; tree a strong grower, slightly thorny. Ripens late, and valuable for late shipping.

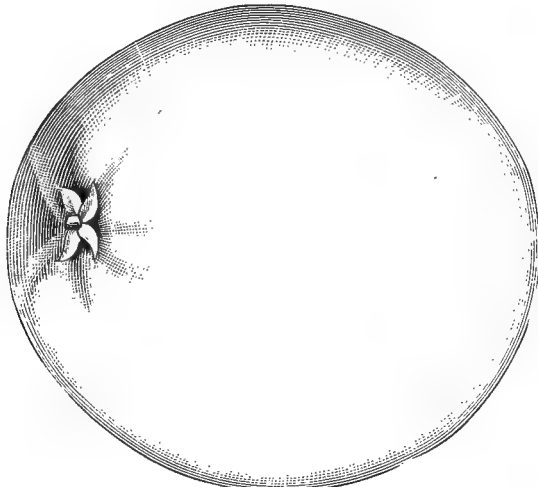

Mediterranean Sweet.

Tangerine, or Kid Glove.—Fruit flat, small to medium, reddish; skin separating readily from the pulp; flesh juicy and aromatic.

Satsuma (Unshiu Oonshiu).—A considerable acreage of this variety, planted ten years ago on dwarfing stock, has availed very little commercially. At present there is disposition to grow the variety on sweet

orange stock because of its earliness. Tree quite hardy, fruit irregular in size, but usually medium size, flattened; rind easily detached; fine texture, sweet and nearly seedless.

Kincquat (Citrus Japonica).—Fruit very small, oblong or olive shaped, rind thick, yellow, smooth; sweet-scented; very little pulp; containing many seeds; tree dwarf (a bush), a prolific bearer.

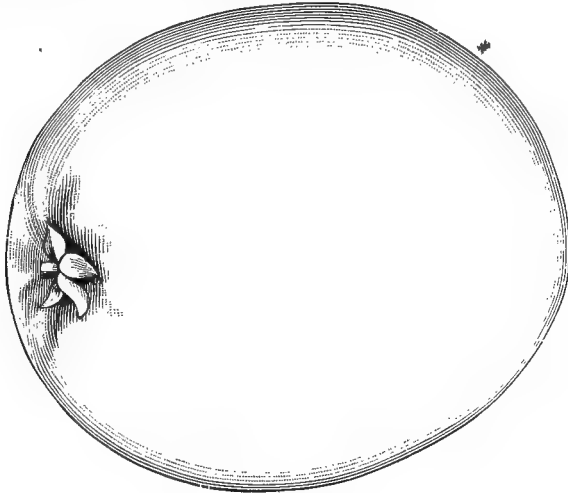

Maltese Blood.

THE POMELO.

This citrus fruit achieved a very sudden interest in California because of the prices commanded by Florida pomeloes about five years ago. When this supply of eastern cities was cut off by the serious frost injuries in Florida there arose a passion for planting the trees in California, and a considerable acreage was planted, and as the tree is a very rapid grower and precocious in fruit-bearing, large shipments were made in 1898, but the results were not satisfactory, and unless some new conditions should arise it is possible that the California pomelo passion may subside as rapidly as it arose.

The fruit is a Shaddock (*Citrus decumana*). Varieties have been secured of smaller size and of blander flavor than the coarse, sour and acrid fruit which is suggested by its name. An effort has been made to secure the favorite varieties, and a large list has been planted in this State, but the fruit does not command the place at the East which was awarded to the Florida product. As a tree the pomelo most nearly resembles the orange and its culture is the same. As for varieties, California experience has been too brief and fitful to demonstrate particular value or adaptation in them.

CHAPTER XXXI.

THE LEMON, LIME, ETC.

The lemon has undergone many vicissitudes in California. At first the product was confined to poor seedlings which did not merit favor and did not receive it. Constant effort was then put forth to secure varieties which would be comparable with the Sicilian fruit and the effort resulted in the production of lemons which were approved by every test of excellence. The next difficulty was to secure popular recognition of quality and desirability from those who were prejudiced in favor of imported fruit. With the aid of the protective tariff this favor was secured in less time than would have been otherwise required, and now the California lemon is highly esteemed upon its merits everywhere and the tariff neutralizes the advantage of cheap water transportation from the Mediterranean region so that our lemons can compete with the foreign product even in the cities of the Atlantic seaboard. All this has been accomplished within a decade, and it is a notable result. One measure of this fact may be found in the shipment of about twelve hundred car-loads during the season of 1898.

As the lemon outlook began to improve planting increased, and in 1894 a very large acreage was set, both on the coast of southern California and in the interior. More recently there has been a tendency to relegate the lemon rather to the coast region and increase the orange acreage in the interior. This seems warranted by recent experience.

SITUATIONS AND SOILS FOR THE LEMON.

The lemon does best in a practically frostless situation. Such places are found in the largest area in the southern half of the coast regions of California, but also exist at favoring elevations in the interior. The moderating influence of proximity to salt water, and the effect of local topography and environment, which give frost-free nooks and belts, are elements favoring the lemon grower. In such situations the lemon blooms and fruits continuously throughout the year.

While the lemon requires a less extreme of low temperature than the orange, it also thrives with a less extreme of high tem-

perature and less duration of it. It apparently does not require as much heat to develop acid, which is the charm of the lemon, as it does sugar, which is essential to an acceptable orange; therefore, a coast situation which may not yield a sweet orange may produce a good lemon. Another advantage of the lower summer temperature is that the continuous ripening is not interfered with, as it is by high summer heat, which hastens maturity and brings the mass of the fruit to marketable condition in the winter—a season when the demand for the lemon is very small. This objection is, however, being measurably overcome by the proper storage and treatment of the fruit for sale, at a considerable interval after picking, as will be mentioned presently.

The lemon delights in a sandy loam, and probably our best orchards are on such soil, but the trees thrive in other soils. There is a difference of opinion among growers as to what soil is to be especially sought for. There are profitable lemon orchards in southern California located upon deep clay loams, and even upon strong red clay soils. As with some other fruits, the choice of soil is, to a certain extent, governed by the stock on which the lemon is worked.

PROPAGATING AND PLANTING.

The prevailing stock for the lemon is the cange seedling. The orange root thrives on a greater variety of soils than the lemon, and produces a healthy lemon tree where the lemon on its own root would fail. The growth of orange seedlings for budding has been described in the last chapter. If lemon seedlings are desired they may be grown in the same way. Plants either for permanent growth or for stocks for budding can be grown from cuttings, as explained in Chapter III. The budding of the lemon is practically the same as of the orange, which has been described. An old tree can be changed from one variety to another by the methods described for the orange, and oranges can be worked into old lemon trees and good fruit secured if the lemon itself be growing upon an orange root, which is likely to be the case with trees planted during the last decade.

Planting of the lemon is the same as that of the orange. The distance in planting varies from twenty to twenty-five feet. Irrigation of lemon and orange trees is also similar.

PRUNING THE LEMON.

The pruning of the lemon is essentially different from that of the orange, because the habit of the tree is different. The lemon requires constant attention to bring into good bearing form and keep it there; the orange, after it is well shaped, simply needs attention to encourage it to retain its bearing form to

which it seems naturally disposed. The orange provides itself with satisfactory bearing wood, as a rule; the lemon devotes itself, even when it is old enough to know better, to a rangy rambling wood growth with bearing wood upon the ends of willowy rods where it is swept about in the wind and burned in the sun, instead of nestling it neatly among the leaves as the orange does.

The rational proceeding with the lemon is, then, to develop it at first into a low, stocky and strong form, such as is described in Chapter XII for deciduous trees. This may be secured by pinching so as not to allow running out of long branches at first, or it may be secured by severe cutting back of the long growths of the young tree. In either case low branching will be secured. Make good selection from these branches to form a symmetrical tree and cut back the growth which comes upon them to cause it to branch in its turn. In this way plenty of good, strong wood is secured low down, and with short distances between the laterals. Strong, upright shoots (wrongly called "suckers") which break out at points where branches are not desired, should be rubbed off or cleanly cut away. Having secured about the right branching in about the right places no strong sprouts should be allowed, and the tree should be encouraged to make smaller laterals, which will be the bearing wood.

When this purpose is borne in mind it appears that the pruning of the lemon involves many of the considerations urged in Chapter XII for deciduous fruits: the method of making a strong, short trunk, the arrangement of branches, the prevention of long growths, the encouragement of low, bearing twigs, the thinning of twigs to prevent the tree from becoming too dense, the points to be observed in cutting back, not by shearing but by treating each branch according to its position and vigor—all these must be borne in mind by the lemon pruner. It must also be remembered that the work must be resolutely continued and the tree always prevented from wild growth and kept down to bearing on the smaller twigs, which are promoted and retained for that purpose. The building-down process described for the young orange is easily applicable to the lemon.

Old lemon trees which have been allowed to grow away into a long, rangy form and to bear fruit too high for profit, can be brought down to good form by severe cutting back and after-treatment of the new shoots, keeping the smaller horizontal growths and cutting out cleanly the strong upright shoots, or cutting them back if more branches are needed. The time for pruning the lemon depends upon the end in view; if a young tree, to promote wood growth, prune at the opening of the growing season in the spring; in older trees, to repress growth and advance fruiting, prune in midsummer.

PREPARATION OF LEMONS FOR MARKETING.

The lemon as taken from the tree is not in condition for marketing except to packers who wish to undertake the curing. To secure best results in quality and in keeping properties, the lemon should be carefully cut from the tree as soon as proper size is reached. To allow the fruit to hang upon the tree until lemon color is assumed, gives a lemon which is deficient in juice, oversized, apt to develop bitterness, and prone to decay. If gathered before the color begins to turn, lemons may be kept for months, and they will improve in market qualities, by a thinning and toughening of the skin, and by increase of juice contents. This curing of the fruit, as it is called, is accomplished in many simple ways. If the fruit is gathered and placed in piles under the trees, where, with low-headed trees, it is completely shaded by the foliage, it processes well and comes out beautiful in color and excellent in quality, providing it is a good variety. Some have trusted wholly to this open-air curing under the trees, merely protecting the fruit by a thin covering of straw, or other light, dry materials. Others let the fruit lie a few days under the trees, carefully shaded from the sun, and place it in boxes or upon trays, and keep it months in a darkened fruit-house, providing ventilation but guarding the fruit against draughts of air. Gathering the fruit while still green, and packing with alternate layers of dry sand, has given excellent marketable fruit, but of course the handling of so much sand is too expensive.

Much attention has been given to lemon storage in southern California during the last few years and many curing and storage houses have been constructed. Naturally there is great variation in design and in methods of operation. The essential conditions to be secured are exclusion of light; regulation of temperature; ample ventilation, under control, however, so as to prevent entrance of air which is too dry or hot; convenience and cheapness of handling, for the lemon is expensive in handling at best during the months of storage which is often desirable. The way these and incidental requirements are met in one of the latest constructions and in the methods of the owner can be best shown by reference to the operations of Mr. A. S. Gaylord, of Cucamonga, San Bernardino County, who secures admirable results with a house of moderate cost, of which plans and a general view are presented herewith.

Lemon-Curing House.—This lemon house is almost a house within a house—the outer building enclosing an area 30x100 feet, the inner apartment being divided into five rooms of 18x20 feet each. Between the outer walls and the inner rooms is a hallway (marked G on the plans) five feet wide in front and four

feet on the other three sides. These rooms and hallway have a twelve-foot ceiling. The outer and inner walls, the ceiling, and the first or inner roof are all of six-inch tongue and groove redwood ceiling. Three feet above this inner roof of ceiling *B* is the outside roof of shakes *A*, connected with the inner roof only by its braces, and extending to within eight feet of the ground, where it is supported by four-inch posts and forms a ten-foot porch *H* on the north and south sides. It is simply a big sun umbrella shading the real building and allowing a free circulation of air about it. A double row of eucalyptus trees shades the eastern end, and a lean-to roof forming a ten-foot porch answers the same purpose on the west.



Lemon House of Mr. A. S. Gaylord, at Cucamonga, Cal.

The building extends from east to west in its greatest length, being so placed in order to receive the full sweep of the westerly winds between the sun and inner roofs. The loft *C*, between the ceiling and inner roof, is ventilated by eight openings 4x4 feet, *D*, one in each end and three on each side, directly opposite each other, those on the sides appearing on the outer roof as gables or dormer windows, with air chutes extending back into the loft. These openings are kept closed during the heat of the day by means of a pair of closely-fitting doors, and opened about sunset, permitting a free circulation of the cool night air through the loft. Each of the inner rooms *F* is connected with the outer air by flumes *J*, 6x8 inches, running from each floor corner of each room, under the hallway to the outside of the building; also by eight-inch pipes from the centers of the ceilings, extending through the roofs and terminating in

“Star” ventilators *E* five feet above the outer roof. The circulation of the air is regulated by slides. Each of the rooms is connected with the front and back halls by sliding doors *I*, seven feet wide by eight feet high, and the hall with the outside by folding doors of the same dimensions directly opposite those of the rooms. These doors are large enough to permit an orchard truck to drive into the rooms to unload the fruit. The rooms

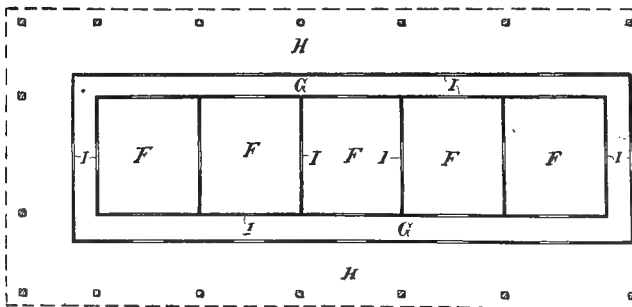
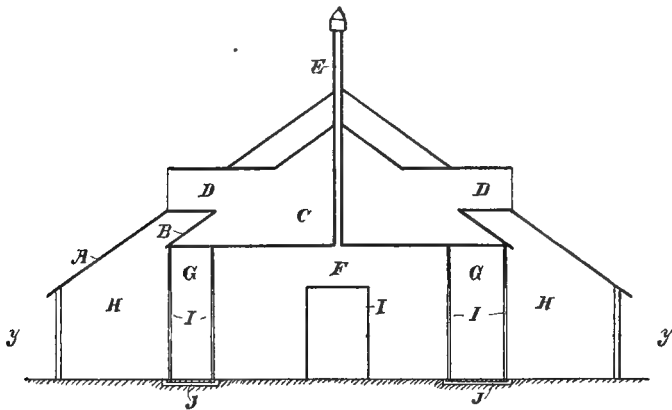

Sectional and Ground Plan of Lemon House.

are also connected with each other and the end rooms with the end halls by sliding doors. Thus by opening all the doors there will be a free circulation of air through the whole building. Trap-doors in the ceiling of the hallway allow the warm air to rise into the loft and escape. The house has no windows, as complete darkness seems to be necessary for the best results. The floor is of clay. The capacity of the house is about 6,000 picking boxes or twelve car-loads. Experience has shown that

the temperature in this house did not rise much, if at all, above eighty-five degrees during the hottest days, when the mercury outside, in the shade, went as high as one hundred and fourteen degrees. The temperature of the fruit was very much less, probably not more than seventy degrees, as the temperature of the house in the early morning was often as low as sixty-five degrees.

Suggestions for Lemon Storage.—The need of prevention of temperature extremes and of ample ventilation is pointedly suggested in the description of Mr. Gaylord's lemon house. Other essentials are to pick the fruit of uniform size—just to fit a two and one-quarter-inch ring—it will lose one-eighth of an inch in curing. Cut the stem close to the fruit; never pluck from the tree, and never allow the slightest bruising. Lemons picked in November and December, before touched by any frost, will keep till the following July if properly stored. Later fruit will not keep so well, and should be marketed first. Later pickings may be two and three-eighths inches in diameter, but no lemon should be above two and five-eighths inches. In the house the lemons may be kept on trays or in boxes with piling loose enough to admit air. There are many details which can only be learned by conference with experienced men or by individual experience.

VARIETIES OF LEMONS FOR CALIFORNIA.

During the last quarter of a century there have been efforts put forth to secure better lemon varieties. Recently three varieties have been accepted as satisfactory and nearly all others have been dropped. The three are Eureka, Lisbon, and Villa Franca, arranged according to present degree of popularity in southern California. Taking the whole State in view, the Villa Franca stands first.

Lisbon.—Imported from Portugal; first grown by D. M. Burnham, of Riverside. Fruit uniformly medium size, rather oblong, fine grain, thin sweet rind, strong acid; few seeds; a good keeper; tree is a strong grower, with compact foliage, prolific bearer, but starts bearing late; quite thorny, but thorns decrease in size as the tree grows older. Popular at interior points especially.

Villa Franca.—Imported from Europe. Medium size, oblong, slightly pointed at the blossom end, rind thin, without bitterness, acid, strong, juicy, nearly seedless. Tree thornless, branches spreading and somewhat drooping, foliage abundant; withstands lower temperature than other imported varieties. At present the most largely propagated variety.

Genoa.—Imported from Genoa by Don Jose Rubio, of Los Angeles. Medium size, oval, sweet rind, thornless, and nearly seedless. Tree is of a dwarf habit, a good keeper, one of the best.

Eureka.—A native of California, originated by C. R. Workman, at Los Angeles, from seed imported from Hamburg in 1872, only one seed

growing, from which buds were put by him on orange stock. Distributed by T. A. Garey, of Los Angeles. Tree very free from thorns. Fruit medium size, sweet rind, a good keeper, few seeds; very popular, especially in coast regions. Rejected in interior because of scant foliage.

Bonnie Brae.—Originated with H. M. Higgins, of San Diego County, and profitably grown by him for many years. Still grown, but chiefly in southern San Diego County. Rind very thin and smooth and like a lime.

THE LIME.

The lime (*Citrus medica acida*) has proved much less hardy than the lemon. It has been killed in situations where the orange and lemon have not been injured. Unless adequate protection is thought worth the effort, there is little use in planting the lime, except in a frostless situation. Such localities are found near the ocean in southern California, and here and there at proper elevation in the interior, but the growth of the lime must be counted very hazardous. There is less inducement to experiment with the fruit from the fact that the Pacific Coast markets are well supplied with Mexican limes, usually at prices which leave no opportunity for competitors.

Limes are grown from seed, the variety usually coming true from seed. The trees are small and are frequently grown in hedge form. The common variety is the Mexican. The Imperial, a large, rather hardy variety is favorably reported by several growers.

THE CITRON.

This fruit (*Citrus medica cedra*) is little grown in California, although it is quite hardy and could be produced over a large area. The only use for the fruit, which resembles a monstrous lemon, is in its candied rind, and no one has deemed it worth while to push competition with the imported candied citron, though very fine experimental lots have been produced, and the interest of the fruit-preserving establishments in the product recurs periodically. There have been collections of citron trees imported from the Mediterranean region by the United States Department of Agriculture planted at several points in southern California. As yet no considerable product has been reached. There is, however, no cessation of interest, and experimental planting continues, with a prospect of satisfactory attainment ere long. Samples of the candied article have been approved by experts as very satisfactory.

ORNAMENTAL CITRUS SPECIES.

There are grown in this State for curiosity or ornament various minor citrus species, including the dwarf ornament sorts from Asia, and the Bergamot. There are, of course, the ornamental species grown by florists for their fragrant bloom.

CHAPTER XXXII.

MINOR SEMITROPICAL FRUITS.

A number of interesting fruits are now grown in this State which, for one reason or another, have not yet attained any great commercial importance. Some of them are quite likely to advance in popular esteem and to gain a higher place in the markets. Others will probably never be grown except for home use and garden ornament.

THE BANANA.

The banana has been a favorite plant for experimental culture for many years, and though good fruit has been grown at various points in the State, the culture is too hazardous to warrant large investment, and if this danger was not present, the abundant supplies available from the islands of the Pacific would probably reduce the profits to a narrow margin. The banana can be trusted only in protected situations and in small numbers which can be given special attention. With these conditions the banana may yield very acceptable fruit for home use and be an ornament to the garden. Its beauty is, however, seriously impaired by winds, which whip its tender leaves into shreds and give the plant an unkempt appearance.

The largest number of bananas are seen in Los Angeles and Santa Barbara, and one grower at an elevation near the latter place reports his table supplied daily throughout the year with the fruit of the Cavendish species. The Yellow Martinique or Yellow Costa Rica, Golden Tahiti, Hart's Choice, and a large-fruited variety known in Los Angeles County as the Baldwin, are also approved by growers. How to grow bananas in the garden, according to the experience of the late S. H. Gerish, of Sacramento, is as follows:—

By experiment I have found that the banana will live—if in a proper soil—without injury to the roots, at a temperature as low as sixteen degrees Fahr.; the stalk will stand a temperature of twenty-five degrees without injury, and the leaves are not wilted until the air is chilled to thirty degrees. My method has been to supply the richest food for this gigantic plant and force it to its extreme growth. Every one has old chip dirt, ashes, boots, shoes, clothes, and manure, which are often a nuisance. Dig a big hole, bury this up, in the center of the mass place a

pailful of sand, and plant the fresh bulb. This is to preserve the dormant plant from the wire-worms and insects, which will not attack the growing plant. As the plant grows, give it an abundance of water and all the slops of the house. Any kind of manure, fresh or old, ashes, leaves, and vegetables will soon disappear and be absorbed by this gigantic king of plants. As the rainy season approaches, pile all the leaves and twigs of trees around the plants. It protects the bulbs and makes the soil rich for next season.

THE CHERIMOYER OR PERUVIAN CUSTARD APPLE.

The oldest cherimoyer (*Anona cherimolia*) is growing in Santa Barbara. The fruit was introduced about thirty-seven years ago, and the parent tree has for many years produced abundant fruit in such perfection that the seeds have readily germinated, and trees thus propagated have been in successful bearing in several Santa Barbara gardens. The leaves are oval and pointed at both ends; flowers solitary, very fragrant, and having a greenish color. Good specimens of the fruit are three or four inches in diameter, often heart-shaped, grayish brown or nearly black when fully ripe. The flesh, in which thirty or forty brown seeds are found, is soft, sweet, and pleasant to the taste, being most palatable when near decay. Mr. I. H. Cammack, of Whittier, describes the pulp as of the consistency of ice cream or a custard flavored with a blending of pineapples and bananas. If it has a fault it is too rich. Apparently it has no particular season for ripening, yet the best specimens seem to be found in Santa Barbara in April and May. The cherimoyer is also found in gardens in San Diego and Los Angeles Counties. It needs a well-protected situation. The fruit has been marketed on a limited scale in Los Angeles, and larger plantations have been made, especially in the Cahuenga Valley, near Los Angeles. The plant comes true from seed and the tree bears in its fourth year, and should have as much room as an orange tree.

THE CHOCHO OR CHAYOTA.

The chocho plant is fruiting in Santa Barbara County, for Mr. Kinton Stevens, of Montecito, who obtained the seed from Samoa. *Sechium edule* is the botanical name of this plant, but it is perhaps better known as "choco," "chocho," "chayota," and "Portuguese squash." It belongs to the order cucurbitaceae, and is a perennial vine, resembling in growth and fruit our summer squash or vegetable marrow. It is a very prolific bearer. Both the fruit and the great yam-like tuber are used as food by man and beast in the West Indies, where it is considered a wholesome article of diet. The roots often weigh as much as twenty pounds. They have a flavor similar to the yam, and are considered a greater delicacy than the fruit, which in a raw state

resembles the chestnut in flavor, and under favorable conditions weighs over three pounds. The proper way to grow them is to plant the whole fruit, as they have but one seed, and they produce fruit in three months, under favorable conditions.

THE GUAVA.

Two species of guava have been quite widely tried in this State—the strawberry guava (*Psidium cattleianum*) and the lemon guava (*Psidium guayava*). The former is the hardier, and, in fact, seems to be about as hardy as the orange, and it has fruited in widely-separated parts of the State; the latter is quite tender, and is at present only grown in favorable places along our southern coast, and even there it is found inferior in quality and usefulness to the strawberry guava. The guava grows readily from the seed, and grows from cuttings under glass. In regions of generous rainfall and on retentive soil it does not require irrigation, but it must have sufficient moisture at command. A light loam seems best adapted to the shrub.

THE GRANADILLA.

The granadilla is the term applied to the edible fruit of a species of passion vine (*Passiflora edulis*) which is quite hardy, and is growing in different parts of the State. The fruit is about the size of a small hen's egg, purple exterior when ripe, the thin, brittle shell inclosing a mass of small seeds covered with a bright yellow pulp, mildly acid, and of very agreeable flavor. Very good jelly has been made of the fruit. Another passion vine with large pink flowers is very widely distributed in California, and bears a large, yellowish-brown fruit with edible pulp.

THE JUJUBE.

The jujube (*Zyziphus jujube*), from the fruit of which the delicate paste of the confectioner is, or should be, made, was introduced by G. P. Rixford in 1876, and is fruiting regularly and freely in several parts of the State. The plant is easily grown from seed or cuttings. The orange-red berries are produced three years from planting, and ripen in November and December. They are edible fresh or dried. As yet the fruit has not been turned to commercial account.

THE LOQUAT.

The loquat (*Eriobotrya Japonica*) is widely grown in California as an ornamental plant, and a small amount of fruit is profitably marketed each year. Recently a very marked improvement in loquats has been achieved by painstaking effort by Mr. C. P. Taft, of Orange. Mr. Taft's work has demon-

strated that this fruit is susceptible of improvement in size, flavor, appearance, in bearing habit of the tree, and in direction of early and late varieties, and in all these directions not only in the line of better fruit, but fruit which commands in the market several times the value of the common types. The season for the loquat is from March to June, the bulk of the crop coming in April and the first half of May. The Advance Loquat is the best of the new varieties. It is very prolific. The fruit is often as much as three inches in length, and from one inch to one and one-half inches in diameter; it being of a peculiar pear shape. The clusters frequently contain twenty specimens. Its color is a bright orange yellow when fully ripe, and it should never be picked until it is so. The flavor is distinct and very sweet. Many compare it to the cherry. If not bruised when handled it will keep easily two weeks, growing sweeter by the process, and will eventually shrivel up without decay, thus proving itself capable of being shipped long distances. Mr. Taft has named the following varieties:—

The Advance.—Fruit yellow, pear-shaped, from two to three inches in length, clusters very large, very sweet when fully ripe.

The Premier.—Fruit salmon-colored, oval, large, but not as large as the *Advance*, sweet, but peculiar flavor.

The Victor.—Largest, color pink to red, probably the best for canning.

THE PERSIMMON.

The persimmon of the southern States (*Diospyros Virginiana*) was introduced into California in early days some time ago, as there are trees thirty to forty feet high growing on Rancho Chico. The widely-distributed species, however, is the Japanese (*Diospyros Kaki*), of which many varieties are now fruiting in different parts of the State. The tree is quite hardy, and fruits freely both along the coast region and in the interior. It easily takes the form of a low standard, and with its large, glossy leaves during the summer, and its immense, high-colored fruit clinging to the twigs after the leaves have fallen, it is a striking object in the orchard or in the house garden.

Persimmons grow readily from seed, but in most cases the improved varieties must be reproduced by grafting on seedlings either of the Japanese or American species. The tree seems to thrive in any fair fruit soil, taking very kindly to close soils if well cultivated. The amounts of fruit now reaching our markets are increasing and a demand is found for certain amounts at fair prices, but there is no object now apparent for large increase of production. This fruit, so highly esteemed in the Orient and so highly praised by travelers, has not become as popular as expected on this coast, nor have the great markets



PINEAPPLE PLANTATION OF J. B. RAPP, CAHUENGA VALLEY, NEAR LOS ANGELES.—See page 385.

at the East required more than a car-load or two a year so far. Those who wish persimmons at all seem to prefer the smaller but more piquant Virginia species.

THE PINEAPPLE.

Casual experiments with the pineapple in the open air in this State have been made for a number of years, the fruit being occasionally produced. Most has been accomplished by Mr. J. B. Rapp, of Colegrove, Los Angeles County. Mr. Rapp's place is in the Cahuenga Valley, and in that part of the valley which is famed as frostless, where even beans and tomatoes survive winter temperatures. Mr. Rapp set out his first twenty-five plants in 1891, and a number of his neighbors also set out groups of plants, but two years finished up all but his. In 1893 the first of his plants fruited, but they did not seem to take kindly to the situation at first. They grew very slowly and the first fruit only weighed half a pound. After setting out his own acclimated plants, they have done better each year, and the fruit which Mr. Rapp has sold recently has weighed from two to four pounds each. If the strongest offsets or suckers are planted they bear inside of a year, and Mr. Rapp is endeavoring to have his fruit set from May to November, as the fruit setting at other times in the year is usually undersized on account of the slow growth during the winter and early spring. It seems probable that the pineapple resents the dry air of our summer as well as the lack of winter heat, and a lath covering and summer spraying may be desirable. It is very doubtful whether the fruit can be profitably grown in this State on a commercial scale.

The pineapple thrives best on a fine sandy loam, but will grow well on many soils if well drained and cultivated. The plants can be set three by three or four by five feet, so as to allow cultivation both ways while the plants are young. Plants are secured from "suckers," which come from the root, from "slips," which grow on the stem just below the "apple," and from "crowns," or the tufts of leaves at the top of the fruit. Suckers are said to bear in one year, and slips and crowns in two years. Strong suckers are best for planting, and they should be set out early in the spring as soon as the danger of cold weather is over.

THE POMEGRANATE.

This fruit (*Funica granatum*), famed in literature and art, is grown in various parts of the State, and certain amounts are profitably sold. The shrub or low tree, in good soil, will reach the height of twenty feet. It is a hardy plant, easy of propagation from seed or cutting. The beauty of the tree, not

taking the fruit into account, has caused it to be planted in many gardens. Exposed to the raw sea winds it does not bloom well nor set with fruit, and is best adapted to the warmer regions of the interior, where it is an early and abundant bearer. The variety chiefly cultivated is a bright orange color, but there is found a large variety of them, varying from almost pure white with a faint blush, to dark red. A very striking variety, with deep red pulp, is grown by Mr. J. T. Bearss, of Porterville. The fruit ripens in the warmer parts of the State, north and south, in October.

THE STRAWBERRY TREE.

The Spanish madroño (*Arbutus unedo*) is now quite widely grown, chiefly as an ornamental shrub or tree. Plants have been distributed from the propagating grounds of the State University at Berkeley, where the tree has been in bearing for the last ten years. Two large trees in the garden of J. L. Mosher, at San Jose, are perhaps the oldest in the State. The growth is exceedingly beautiful if kept free from scale insects, the fruit ranging as it ripens through shades of yellow, orange, and deep red, and contrasting beautifully with the glossy ever-green foliage. The fruit is of pleasant flavor.

MELON SHRUB.

This plant (*Solanum Guatamalense*) is a small, half-herbaceous shrub from the table-land of Guatemala. The fruit is yellow, splashed with violet, somewhat of the shape of the egg-plant, but is usually seedless, and is readily propagated from cuttings. Plants grown at Berkeley have not succeeded well. There are thriving plants in many protected places in the State, and some fruit reaches the market, but few seem to like the flavor, which is something like a tomato and melon mixed.

THE MELON TREE.

The melon pawpaw (*Carica papaya*) has been widely introduced experimentally in this State, and many situations are found unfitted for its growth, but satisfactory fruiting has been secured at several places in southern California, especially if protected the first year it will stand light frosts afterwards. With Mr. Cammack, at Whittier, Los Angeles County, it ripens fruit the third year from the seed—the fruit being pleasant to eat as one would a muskmelon. The large fig-like leaves and the peculiar markings of the trunk make the tree a very striking object.

THE PRICKLY PEAR.

The tuña, or fruit of the cactus (*Opuntia vulgaris*), is produced in nearly all parts of the State except on the mountains.

It was one of the old mission fruits, and was enjoyed by the early mining population until better fruits were available. It is about as large as a medium-sized pear, and has a pleasant acid flavor if one succeeds in escaping the prickles in getting at the interior of the fruit. The *tuña* is still a commercial article in a small way. Plants are grown readily from cuttings of the fleshy leaves.

THE ALLIGATOR PEAR.

The avocado, or *Agua cote* of the Mexicans (*Persea gratissima*) has proved hardy in several districts in the State, north and south. It is hardy in Berkeley, but has not yet fruited. It is not likely that it will be satisfactory without high summer heat and freedom from heavy frosts. It is, however, one of the most promising of its class of fruits, as it is known to epicures, and its marketing at a high price reasonably assured. Mr. J. C. Harvey, of Los Angeles, gives this interesting account of it:—

It is a handsome evergreen tree, and, in the typical form, bears elliptical leaves from two and one-half to three inches in width, narrow toward the base, and about six inches long. In some varieties the new growth is of a reddish brown, ultimately becoming deep green. The fruits are pear-shaped, about the size of a Bartlett pear, and contain a single, rather large seed. When ripe, the skin, which is much thinner than that of an orange, parts easily from the pulp, which is of a moderately firm though buttery consistency, and forms, with lime juice or pepper and salt, one of the most delicious salads known to epicures. Indeed, the fruit is a perfect mayonnaise in itself. Few persons fail to like it, even at first, and in countries where it is common, it is esteemed above all other vegetable productions, both by natives and foreigners alike. The pulp is quite rich in a bland and most agreeable oil, said to be very nutritious. The tree attains a height of from twenty-five to thirty-five feet, and forms a handsome object when liberally cultivated. The tree is a gross feeder. Good-sized trees carry a large crop, which, after attaining a certain size, can be picked at intervals of a week or two extending over a period of two or three months, the fruits in each instance ripening in a week or ten days after gathering; and a very remarkable fact is that the quality or flavor of the last picking seems just the same as the first.

THE WHITE SAPOTA.

There are two old trees in Santa Barbara, one believed to have survived from the mission planting in the early part of the century, the other half as old, which have been held to be the white sapota (*Casimiroa edulis*). Dr. Franceschi has pointed out the probability that the Santa Barbara trees are something else or else a very inferior variety. Mr. Harvey, of Los Angeles, describes the true sapota as growing with him from seed from Vera Cruz.

This tree endures slight frosts unharmed. It is indigenous in north-west Mexico and is remarkable among the *Aurantiacea*, producing green colored flowers, and superficially bears little resemblance to an otherwise well-marked order of plants. The fruits are the size of apples, and are esteemed in that portion of Mexico where it is common; according to some botanical authorities it is not considered altogether wholesome, possessing narcotic properties. The pulp is described as possessing a delicious, melting, peach-like taste.

THE TREE TOMATO.

This plant (*Cyphomandra betacea*) was brought to general notice by Mr. Cammack, of Whittier. It is a native of Central America and is of shrubby habit, growing five or six feet high, with large, shining leaves, often a foot long. The flowers are fragrant, of a pale flesh color, with yellow stamens, and are followed by fruit the shape and size of a duck's egg, at first of a purple tint, but gradually assuming a warm, reddish color as it ripens. When ripe the fruit may be used raw as a tomato is. If the skin is removed and the fruit stewed with sugar, it has a slight sub-acid flavor which is very refreshing. It makes a fine jelly. The plants bear the second year from the seed and the fruit ripens continuously for several months. The seeds should be started just as are those of the common tomato, and the plants set out eight or ten feet apart.

THE KAI APPLE.

The name is applied to the fruit of *Aberia Caffra*, a native of Natal and Kaffraria, a tall shrub, yielding an edible fruit of a golden yellow color, about an inch in diameter. It is commended as a hedge plant, as it is densely clothed with strong dry spines. The leaves are small and of a rich green hue. The fruit, which is produced freely in the warmer parts of the State, is chiefly used for making preserves.

OTHER FRUITS.

The foregoing enumeration does not include all the exotic fruits which have found a place on Californian soil. There are many more, some of which will probably demonstrate their fitness to add to the graces or the gains of our horticultural life.

PART SIXTH: SMALL FRUITS.

CHAPTER XXXIII.

BERRIES AND CURRANTS.

In suitable soils and situations, and with proper care and cultivation, the small fruits sustain the general reputation of California by the size and quality of the product, and by the long-continued and abundant fruiting of the plants. Probably nowhere else in the world do small fruits better repay generous treatment than in this State, and probably nowhere do they suffer more from neglect. There are parts of the State, of course, where some small fruits, left to their own resources, thrive and bear abundantly, but, speaking of the State as a whole, the price of success is intelligent devotion on the part of the grower.

There are localities in California which favor almost continuous growth and fruiting of some of the small fruits, and it is no fiction to say that in such a place one may have raspberries and strawberries upon his table every month of the year. Such situations are the thermal belts, which are practically frostless, and, by securing favoring moisture conditions in the soil and proper varieties of the fruits, the existing temperature conditions will produce the results indicated. Though this be the case, the profitable growth of small fruits is not, of course, restricted to such situations, but the largest commercial enterprises are carried on in places where the summer-crop rule prevails, but the bearing season is much longer than in the eastern States.

Small fruits for family use may be grown on all fertile soils, and therefore they should be produced on every farm. Growing for market on a large scale involves considerations of suitability of soil and climate, ease of cultivation, water supply, and facilities for transportation, which will probably occur to any one who gives the matter the thought and personal observation of existing small fruit farms, which such an important commercial venture should command.

Preparation of soil for small fruits should be most thorough and careful. Even more generous work than that commended in Chapter X for trees and vines should be done. It is the more

necessary to work deeply because subsequent culture of small fruits must be shallow.

THE BLACKBERRY.

The blackberry is a great favorite in California markets. It thrives in all parts of the State, and the plant is best suited of all small fruits to yield generously without irrigation, though it relishes sufficient moisture and repays it with fruit. There is great difference in practise as to supplying water artificially. The growth of cane, and the size and appearance of the fruit, will show the observing grower what should be the practise in his situation, and the general suggestions as to irrigation in Chapter XV are applicable. There are regions in which blackberries are irrigated weekly throughout the summer, and others in which the berries are gathered from June to November without irrigation. Of course, with such wide local variations, there can be no general rule for practise. Let the grower simply bear in mind that if he does not get good, plump, and glistening fruit and good strong growth of new canes at the same time, he should give irrigation. The requirements of the plant during the fruiting season are great, and they must be met.

Propagation.—Blackberry plants are secured by digging up the shoots from old stools, securing therewith a bunch of fibrous roots with a portion of the main root. To propagate on a large scale dig up the roots entirely, and, cutting them up with pruning shears into pieces about two inches long, plant them in a well-prepared bed in the garden or nursery. Place the root cuttings about two inches apart and cover about three inches deep with well-pulverized soil, the depth being regulated of course, according to the nature of the soil, deeper in light than heavy soils. A light mulch will assist in retaining moisture. The time for this work is at the dormant period of the plant. One summer's growth gives good plants for setting out.

Planting out Blackberries.—Blackberries should be planted in rows far enough apart to admit of the use of the horse and cultivator. As the constant tendency of the plant is to extend itself in the growth of new canes, the rows should not be less than six to eight feet apart, and the plants about three feet apart in the row. The plants soon occupy the full space in the row, and cultivation is only possible between the rows. Some growers plant blackberries as they do grape-vines, seven or eight feet apart both ways, and then cultivate with the horse both ways. Planting in rows is better. The number of plants to fill an acre at different distances can be calculated as described in Chapter XXIV for grape-vines.

D. Edson Smith, of Orange County, who has much experience with small fruits, describes his method of laying out and planting on a large scale, with a view to irrigation, as follows:—

Plow deeply and harrow thoroughly several times before setting out. Lastly, open a trench with your plow where the row is to be, twenty inches deep; go along with a basket of plants, a four-foot lath and a shovel, and set a plant in this trench every four feet and fill the dirt around it with the shovel. If the trench is too deep in places for the length of the plant root, fill in a little dirt; if not quite deep enough in places, scoop out a shovelful. Aim, in preparing the ground with plow and smoother, to leave it dishing each way toward the row of young plants, so that irrigating water turned in at the upper end will run along the row of plants as in a trough. Aim to have the ground around the set plants a few inches below the general level of the land. After the plants are all set in a row, go along with a rake if there are but a few plants, or with a horse-hoe if there are many, and fill in the trench between the plants. It is a pleasure to set out plants in this way, and such deep, rich, well-stirred soil delights the plant roots, so that they grow rapidly in every direction, and the plants throw up their heads in a manner entirely satisfactory to all concerned. If the ground is dry, or there is no rain soon after setting out the plants, irrigating water should be turned down the row, or at least a quart or two of water poured around each plant; then, before the soil hardens, stir it well with cultivator and hoe. All future care resolves itself into frequent waterings and frequent stirrings of the soil. Allow no weeds to appear, and keep three inches of surface soil well loosened with the horse and hoes. These small fruits require frequent waterings, especially when forming fruit and during the fruiting season.

Cultivation.—Thorough cultivation of the surface soil is essential for retention of moisture. After the plants attain size, cultivation should be secured with as shallow-cutting tools as possible so as to prevent injury to the roots, which not only weakens the plant, but increases the growth of suckers between the rows. A horse-hoe with a long knife running horizontally, or with duck-foot teeth, well sharpened, answers well in keeping the ground clear of weeds and suckers, and the surface loose.

Frequency of cultivation depends upon irrigation, for the cultivator must always follow the application of water. The benefits of surface cultivation, as described in Chapter XIII, are of especial force in this connection.

The spaces in the row which can not be reached with the cultivator must be kept clean from weeds, and free from baking, by the use of the hoe. It is advisable that the cultivation be the cleanest possible, for moisture exhaustion by weeds can not be afforded.

Pruning and Training.—There is a little difference in the way of training blackberries practised in this State. Of course this does not include the "let alone" system, which is not followed by any good grower. The difference lies mainly in the

use or disuse of artificial supports for the canes—the prevailing practise being to dispense with them. In either case the pruning of the canes is similar in kind but different in degree, for if no supports are used, the canes are headed lower.

At planting out, cut back the cane to near the surface of the ground and mark the plant with a small stake. At first the top growth should not be checked, but when new canes grow out strongly they should be pinched at the tip to force out lateral branches for fruiting the next year. Those who intend to tie canes to a stake or trellis let them attain a height of five or six feet before pinching off the terminal bud; those who intend to teach the cane to stand alone pinch when it is from two to four feet high. All agree to pinch off the ends of the lateral branches at about twelve inches from the main stem. This pinching of blackberry canes may be done by the watchful grower of a few plants, with the thumb and finger, but thrifty blackberry plants are such rapid cane growers that in large plantations cutting back is often done with a sickle or corn hook or sharp butcher-knife, several times in the course of the summer. It is also advisable to thin out the suckers with the hoe while cutting out weeds, leaving only about as many as it is desired to have for fruit the next season. After the leaves fall, the canes which have borne fruit during the summer are all cut off even with the surface of the ground with long-handled pruning shears or with a short, hooked knife with a long handle, and all *debris* removed from the rows. This method gives stout canes, with plenty of short side branches, well supplied with buds, which will send out fruiting shoots the following spring.

If supports are used, the four to six canes which are left to each stool are gathered within a loosely-drawn bale rope and tied to the stake; or if a trellis is used, the branches are brought up to the wire or slat so that the distance is about evenly divided between the shoots.

Though these systematic methods of summer pruning are practised and advocated by the most careful growers, it should be stated that there are large plantations which are conducted upon a more simple system. The pruning consists in cutting out old canes in the winter, and the only summer pruning is slashing off those canes which interfere with cultivation. The canes are sometimes held up by tying bunches of them together with ropes. Of course this system costs less than the more careful one which has been described, and yields profit enough to induce adherence to it. No doubt quite as great weight of berries could be had from a smaller area by a better system of growing.

Application of Manure.—The blackberry loves very rich ground, and plenty of well-rotted stable manure or compost, as

described in Chapter XIV, should be applied. It is a good plan to apply in a thick covering all over the ground and between the canes as soon as the patch is cleaned up in the fall. The early rains carry down the soluble parts of the manure, and later in the season the whole is plowed in between the rows, leaving a foot or more next the plants to be carefully forked in, as the digging fork does not cut the roots like the spade.

Mulching.—The mulch, to keep the ground moist and to obviate summer cultivation, is very satisfactory where it is thoroughly done. Apply coarse manure or partially-rotted straw and the like, after the last spring cultivation, and use the hoe to keep down weeds and suckers which come up between the rows. Some growers use mulch close to the canes, cultivating the remainder of the ground between the rows.

Bearing Age and Longevity.—If blackberry plants are well treated the first year after planting out, there will be considerable fruit the following summer. How long the plants will bear satisfactorily depends, also, on situation and treatment. Sometimes the plants fail early; even with good, generous treatment in good soil, the old stool becomes weak, the shoots are thin, and the fruit small. Some count about eight years as the profitable age of the plant, and then cut out the plants and give the land a change. Of course berry growers prepare for this by frequently making new plantations.

Varieties of the Blackberry.—Comparatively few kinds are largely grown. The Wilson Junior, Lawton, and Kittatinny were formerly the prevailing kinds, ripening in the order named. The Erie is favored by some as a late variety. The Early Harvest has been favorably reported by a number of growers. These have, however, been largely superseded by a renamed variety, Crandall's Early, which is the earliest of the improved varieties, and has a very long fruiting season. The fruit was named after Dr. J. R. Crandall, of Auburn, who first fruited the variety from plants given him by a stranger hailing from Texas. It is a strong, vigorous, hardy plant, very productive, of firm, handsome berries; resembles Lawton in canes, leaves, and flavor of fruit; not given to sprouting from running roots.

Another variety which has advanced in favor is the Oregon Evergreen, introduced from Oregon. Mr. John Rock describes it as follows: "Origin unknown; beautiful; cut-leaved foliage, which it retains during the winter; berries large, black, sweet, rich, and delicious. It continues to ripen from July to November, which makes it one of the best berries for family use."

Some effort has been made to secure improved varieties of our native blackberry, and a most striking result has been secured by Judge J. H. Logan, of Santa Cruz, by crossing the

wild berry with Crandall's Early, producing a fruit so large that it has been named "Mammoth" by its originator. The canes of the Mammoth are very peculiar, being very large and thickly covered with small, short spines. The canes start early in March, grow thick and stout until about five feet high. They then take on a running habit and grow from twenty-five to thirty feet in a season. Late in the fall the tips or stolons seek the ground and take root. The Mammoth is not an evergreen like its Texas parent, although it does not entirely lose its leaves in winter. It begins to grow and flower very early in spring and ripens its fruit the last of May, some weeks earlier than the Lawton. The fruit is more acid than the Lawton, but, when perfectly ripe, is sweet and of superior flavor. When cooked or canned the flavor is identical with the wild berry of California.

The Dewberry.—The improved varieties of the dewberry, or trailing blackberry, are now quite widely grown and highly praised. Some growers use trellises; others train the vines along rows on the ground surface. The following is the method of Mr. A. M. Munger, of Fresno, and includes irrigation arrangements:—

For planting the Lucretia dewberry, prepare the ground by plowing deep and cultivating until the dirt is thoroughly pulverized. Set the plants about three inches deep and four feet apart, in rows, leaving a space of six feet between the rows. Plant between February 15 and March 15. Irrigate as often as once a month, always thoroughly cultivating after each irrigation. By so doing a sufficient growth is secured to produce a good crop the second year. Immediately after the first rainfall, generally in October, the vines should be pruned by cutting back within about sixteen inches of the base of the vine.

In February of the second year plow between the rows with a small one-horse plow, turning the furrows towards the vines, but using a shield so as not to cover them. Follow immediately with a hoe, drawing the dirt up under the vines and forming a ridge. This ridge should be high enough to keep the vines up out of the water when irrigating. After this ridge is formed, water should be run quite often, as the dewberry requires a great deal of water to mature properly. The vines should be irrigated as often as three times at least during the spring. The fruit begins to ripen in Fresno about May 25, and continues about one month. The dewberry roots readily from the tips without covering if the soil is loose and moist. If many plants are desired it is advisable to cover slightly, and the tips will root as soon as the soil is moistened by the fall rains.

THE CRANBERRY.

Though attention has been given to experiments with the growth of the cranberry in California for many years, it has not been demonstrated that the culture is successful or profitable. Cranberries have been produced, and the fruit shown at fairs, but beyond this nothing has yet been accomplished. It would

seem to be a fair conclusion that even in the most moist regions our summer air is too dry to suit the plant.

THE CURRANT.

The currant reaches perfection in size and quality in parts of California adapted to its growth, but its area is comparatively small. The plant does not thrive in the dry, heated air of the interior either at the north or south. It does well near the coast, especially in the upper half of the State, and is grown for market chiefly, on lands adjacent to and on the east side of the bay of San Francisco. The comparatively cool and moist air of the ocean favors it, but even here the sunburn, which is the bane of its existence in the interior valleys, occasionally injures the fruit. Away from the coast, currants are grown to a limited extent along the Sacramento and San Joaquin Rivers, near their confluence, but not in the hot valleys whence they flow. On the foot-hills, too, where the plant has a northerly slope, or other cooling influence, and sufficiently moist soil, it will do moderately well. It is quite possible that the currant may be satisfactorily grown for home use, or for local market in parts of the State where at present one does not find it, providing the moderating effect of elevation and northerly exposure, coupled with the shade of trees, be secured, but even then the hot north wind of the early summer may often injure the fruit. So far as the metropolitan market is concerned, it does not matter that the currant area is limited, for existing plantations produce all, and sometimes more, than can be profitably disposed of at present.

Propagation.—The currant is readily grown from cuttings. As soon as the bush drops its leaves, and the ground is in condition, as to moisture, secure the cuttings a foot in length from straight wood of the last growth, and place them in nursery or in permanent place, in good sandy or garden loam, spaded and broken up to a depth of eighteen inches. Set the cutting firmly in the earth, six or seven inches deep. If they are to be trained as small trees, every bud below where the lowest limb is to start should be cut out—even to the end of the cutting underground—otherwise they will be continually throwing up suckers. If they are to grow as bushes, the natural and more productive form of the currant, set them as they are taken from the parent bush.

Planting and Care.—Currants are usually grown in rows about five or six feet apart, the plants standing two and a half or three feet apart in the rows. Most of the currant plantations are between orchard rows, the partial shade of the trees being considered desirable. It is claimed that currants do best when

interplanted with cherry, apricot, apple, and pear, not so well when associated with plum and peach, and the almond is least desirable. The cultivation is such as is usually given to the orchard, except that in heavy soil the plow is not allowed to come near the cuttings the first season for fear of tearing them from their rooting. After the first year the plow is used in the winter and the cultivator in summer.

Currants well repay generous applications of well-rotted manure, and relish sufficient moisture in the soil. Where this can not be had from rainfall, and retained by cultivation and mulching, irrigation must be resorted to.

Pruning.—If the currant is to be grown in tree form, the branches from the upper buds of the cutting should be shortened in at the end of the first summer, and branches growing horizontally should be removed. The weaker shoots in the head are thinned out, but not so much as to leave the top too open. If the plant is to grow as a bush, the only winter pruning will consist in removing dead wood, and thinning the new shoots as may seem desirable. Summer pinching of the new growth is desirable, as it causes the fruit to set closely and tends to a thick growth of foliage also, and this is necessary, for the bark is liable to sunburn, and the best fruit is that which is well sheltered by the leaves. Another advantage of the bush form is the less likelihood of killing by borers, which is imminent when the growth depends upon a single stem.

Bearing.—The currant bears a quantity of excellent fruit the second year from the cutting, and reaches its fullest product about the fifth to the eighth year, when the yield in the Haywards region is said to range from one and a half to three tons to the acre.

Varieties.—The Cherry currant is the prevailing variety, although the old sorts, the Red and White Dutch, the Red and White Grape, etc., are grown in some localities, and Fay's Prolific is approved by some growers.

Black currants are but little grown, the market demand for them being very light.

THE GOOSEBERRY.

The gooseberry is another fruit with somewhat circumscribed area in this State. In localities which favor it, the fruit is often found very profitable, but the demand does not warrant any great increase of product. Though the gooseberry thrives in some situations which do not suit the currant, they may both be described as averse to the hot and dry parts of the State. Still, for home use or local sale one can grow certain varieties of gooseberries successfully, by protecting them from too great exposure to the sun, and by keeping the soil sufficiently rich

and moist. The choice of varieties is of the greatest importance, as will be mentioned presently. At present the chief supplies of the gooseberry, as of the currant, are produced in the country adjacent to San Francisco Bay, though thriving and profitable plantations are found elsewhere near the coast, here and there in the interior, and at considerable elevations on the slope of the Sierra Nevada.

Propagation, Pruning, etc.—The gooseberry is grown from cuttings, very much as already described for the currant. The common and the best method is to start the cuttings early in the winter, though some have succeeded with cuttings taken in the spring just as the new growth is starting out. Disbudding the lower part of the cutting if it is desired to train in tree form is also practised with the gooseberry, but a smaller percentage of cuttings is found to grow after disbudding.

Gooseberries are planted out and cultivated as already described for currants, and the requirements of the plant in soil, moisture, and manuring are much the same.

If the gooseberry is to be grown in tree form, constant attention to removal of suckers is necessary; if in bush form, it will only be necessary to remove too old wood and to thin out the new shoots. Suckers should be removed clean from the stem, so as to eradicate the latent buds, and pulling off with a gloved hand, when the suckers become woody enough to withstand breaking, is advised. As with the currant, the borer is a constant menace to the life of a gooseberry plant confined to a single stem.

Diseases and Pests.—The gooseberry is subject to insect depredation both in wood and fruit and leaf. The prevailing trouble, however, and that which causes the failure of so many foreign kinds, is the mildew. To escape this nothing is done except to select varieties not subject to the disease.

Varieties of the Gooseberry.—The American varieties, Downing and Houghton's Seedling, chiefly the latter, constituted for a long time the main varieties marketed in San Francisco. Early experiments with collections of English varieties showed that most of them were failures because of mildew; still a few of the green and white sorts, notably the Whitesmith, have succeeded. The proportion of large berries now being marketed is much greater than formerly, and the superior price warrants especial effort to produce them.

A large English variety, which was brought to California many years ago by the late John W. Dwinelle, is now the most widely distributed large kind. Its true name was lost and it has been propagated under various names, viz., Dwinelle, Kelsey, New French; but the name Berkeley, adopted by W. P.

Hammon, in his wide distribution of it in 1884, now prevails. It is large and handsome, very prolific, ripens early, and is usually free from mildew.

The Champion, an Oregon seedling grown by Seth Lewelling, is medium sized, very smooth, and thick fleshed, the seeds being few and small. They are entirely free from mildew, and are clean, bright, and beautiful.

THE MULBERRY.

Nearly all varieties of the mulberry have been introduced in California and grown rapidly and thriftily. Most attention has been paid to those varieties most suitable for feeding silkworms, but the fruiting varieties are also grown here, though the fruit has assumed no commercial importance. The mulberry is grown readily from cuttings. The fruiting varieties thus far chiefly distributed are the Downing Everbearing, the Persian, the New American, the Russian, and the Black Mulberry of Spain. All these bear large and desirable fruit. The last named, introduced by Felix Gillet, of Nevada City, is grown quite widely. The mulberry has a long season; the Persian ripens in Tulare the last of May and continuously thereafter until October.

THE RASPBERRY.

The raspberry is another of the great small fruits of California. It thrives over a great area of the State; in fact, there are few situations in which it can not be grown, if proper attention is given to retention of moisture in the surface soil, and to giving the plants partial shade in the heated valleys, and the cooler exposures in the foot-hills. The raspberry, skilfully pruned and generously fed and cared for, is almost a constant bearer, as has already been intimated. It is a continual delight in the home garden, and always brings a high average rate in local and metropolitan markets.

The culture of the raspberry is in the main like that of the blackberry, as already described. The red varieties, which are the kinds almost exclusively grown in this State, are propagated by suckers and root cuttings like the blackberry, but the "black caps" are propagated by layering the cane tips during the growing season. Bending down a cane with its branches and covering lightly with soil and with a light mulch to retain moisture, will result in free rooting of the buried parts, and one can sometimes secure a dozen plants by the layering of a single cane with its laterals.

The pruning of the raspberry is also by the renewal system, as advised for the blackberry. The topping off of new canes,

when they reach about three feet in height, the subsequent pinching of laterals which are thus forced out, the resolute thinning out of sprouts so that but three or four strong canes are allowed from one root, the faithful repression of all weeds, the maintenance of a loose surface layer of the soil by very shallow cultivation, the free application of manure and of water unless a continually moist condition near the surface can be secured by cultivation and mulching,—all these are among the essentials of cultivation which will secure abundant fruit and a long bearing season. However, as has already been stated with regard to blackberries, there are large plantations which pursue a less careful system of cultivation.

Continuous bearing of the raspberry may be secured in those varieties which endure the treatment, by cutting out a cane as soon as its fruit is gathered, the force of the plant being then devoted to the fruiting of a second cane, which has previously been pinched, and a third shoot is pinched and allowed to mature its wood to carry over and bear the first crop of the following year. A succession of sprouts is gained by pinching off the tips of some as soon as they have grown up a few inches, which results in the growth of later shoots lower on the stems. In this way a succession of fruit is obtained.

The Cuthbert and other strong-growing varieties, after the pinching at about three feet from the ground, will send out laterals which will bear late in the fall, and the same cane will bear a crop early in the following spring, when its career is ended and it should be removed.

Raspberries are planted about three feet apart in the rows, and the rows about six feet apart. They can be well grown nearer together than is required for blackberries.

Varieties of the Raspberry.—The old varieties have been largely replaced by the Cuthbert, which is the universally popular and most largely-planted sort, having been found trustworthy as a grower and as a free and constant bearer. The good points of the Cuthbert, as representing the experience of many California growers, include the following: A profuse grower, with healthy and rich foliage, which protects fruit from sunburn; an excellent bearer with the fruit well distributed through the bush; the fruit comes off easily, and does not crumble, is of fine flavor, and ships well. The Turner, Herstine, and New Rochelle varieties are grown to a limited extent; and the Barter, a re-named variety, the identity of which is unknown, has always retained a degree of popularity in the foothill region of Placer County, where it first appeared.

The Black Cap varieties thrive fairly in most parts of the State, but do not sell well in the markets, and are only grown

for home use. The golden or yellow raspberries are also out of favor because they are shy bearers and cut no figure in the California product.

Blackberry-Raspberry Hybrids.—Two crosses of California origin have been widely distributed and have demonstrated great value.

The Loganberry was originated by Judge J. H. Logan, of Santa Cruz, and is a cross between the California wild blackberry and a red raspberry, thought to be the Red Antwerp. It was a chance-hybrid developed by growing plants from the seed of the wild blackberry in 1881. The plant was multiplied by its originator and fruited for more than ten years, plants being meantime given to Mr. James Waters, of Watsonville, who grew it on a commercial scale and was gratified at the results of his marketing of the fruit. The variety was first given to the public through the University of California in 1893 and has since then been propagated by nurserymen and sold in large quantities. It has proved a most valuable fruit in all parts of California, and has commanded the attention of pomologists and growers all over the world. The Loganberry is an exceedingly robust grower, and has unique foliage and cane growth as well as fruit. The fruit is strikingly large and handsome: sometimes an inch and a quarter long, with the shape of a blackberry, and sometimes the hue of a dark red raspberry. Its flavor is unique and peculiar, and gives to many tastes suggestions of the combination of blackberry and raspberry flavors. The culture of the Loganberry is like that of a dewberry—both in growth and propagation.

The Primus is another blackberry-raspberry hybrid, originated by Luther Burbank, of Santa Rosa. It is described as like a raspberry in color and shape, though much larger, many specimens attaining a length of an inch and a half by three-quarters of an inch in diameter. It has a larger and softer pulp core or center than the blackberry, and does not come off the stem like a cap as a raspberry, but it is a little more tart and is best cooked. It ripens early and the plant yields well. It has been widely distributed and is popular. It has a trailing habit.

THE STRAWBERRY.

“Strawberries all the year round” is the trite expression by which the charms of the California climate are characterized. It is no fiction, for in the wonderfully-even climate of regions adjacent to the coast and in thermal belts in the interior, the strawberry plant blooms and bears almost continuously, providing proper moisture conditions are maintained in the soil. There are, however, more or less well-defined crops, and “straw-



MAMMOTH BLACKBERRY A HYBRID, BY J. H. LOGAN.—See page 394.

berries all the year" does not mean a uniform supply; nor does it mean that everywhere in California can one expect such constant fruiting. In the very hot interior situations the plant rebels against the atmospheric conditions of midsummer, even though the ground be moist; and in frosty places the plant becomes dormant during the wintry portion of the year. The conditions of constant growth and bearing are moderation of temperature and of atmospheric and soil moisture throughout the year.

SITUATIONS AND SOILS FOR THE STRAWBERRY.

Bearing in mind the conditions described, the strawberry can be grown anywhere in California. The native species, as mentioned in Chapter V, flourish from the sand of the ocean beach to the rich valleys of the Sierra, just below the line of perpetual snow, and the deduction is that wherever fertile soil and sweet water can be brought together in California, the strawberry will reward the grower.

Strawberries do well on a variety of soils, but as a rule a deep, moist, loamy soil will yield best results. Boggy or swampy spots should be avoided unless drainage is provided, and in this way most excellent strawberry ground may sometimes be secured. Land which will produce good potatoes or corn will generally yield good results with strawberries, provided irrigation is furnished. In many regions the plants will hardly survive the summer without irrigation, and everywhere a succession of crops during the season depends upon irrigation. It is the common experience that light, warm soils yield the earliest and highest-flavored berries, and heavy soils the later and larger ones; but the size of the berry depends more upon the supply of available moisture, and immense fruit can be produced on loose, open soils by free irrigation. And yet the heavier soil, both because of its usually superior fertility and retention of moisture, is preferred for the strawberry. The largest-producing regions for the San Francisco market in the Santa Clara and Pajaro Valleys are comprised mainly of low-lying, heavy valley soils, naturally moist and rich, and furnished with abundant water supply for irrigation. And yet in southern California the chief market crops are produced upon light sandy loams with water equal to the needs of the plants upon such a footing. It must be remembered that the strawberry is a shallow-rooting plant and must have moisture retained near the surface. Some loose soils, especially on uplands, are almost out of the question for strawberry growing. They are so leachy that they will not hold moisture near the surface though one should stand with a hose and almost continuously pour it on. The plants would also dry up though the water were running

near by in a ditch. To grow strawberries it is often an advantage to have a shallow loam soil over a clay or hard-pan, for then the tight layer below will prevent the escape of the water below the reach of the roots. If this can not be had, the best way to grow strawberries on leachy soils for home use is to mulch and sprinkle.

Propagation of the Strawberry.—Seedlings undertaken in the hope of originating valuable new varieties are easily grown by taking off the outside layer of the choicest berries, which carries with it the small, yellow seeds. Wash these from the skin and cover them slightly in a sandy soil partially shaded and kept moist by sprinkling, or a light mulch, and the plants are readily grown. As with seedlings of other fruits, few, if any, will be found superior to the parent variety.

Plants for setting out are secured by taking off the small growths rooted from runners. The strongest plants are those nearest to the parent plant. When these are allowed to root in small pots plunged into the soil, they are called "pot-grown," and are superior for planting out, but they are not largely used in this State. When plants of any variety are desired for new beds or fields, a row or more are allowed to send out runners during the summer, and these are fit for taking up and replanting the following winter or spring.

Laying off Ground for Strawberries.—The essentials are deep and thorough pulverization of the soil and grading of the surface so that water will flow slowly in the ditches. Suggestions as to location of grade lines may be found in Chapter XV. The inclination which answers for water distribution may be very slight; about two inches to the hundred feet answers on the level lands of the Pajaro Valley, while in the foot-hills much greater fall is made use of, and on hillsides rows are located on contour lines and not in straight lines. A grade of three and three-quarters inches to the hundred feet is sometimes used. The triangle described in Chapter XV can be used to fix the grades.

Of course, in grading the field it is often necessary to give adjacent blocks opposite inclinations to provide for the return of the water. On hillsides, where the water is carried down a ridge to a flume, it is usual to keep the water always running away from the flume, and only enough is taken out to reach to the ends of the small ditches. A grade of six inches to the rod is practicable for hillside irrigation, but of course only a small flow of water is employed.

There are various ways of laying out strawberry beds and plantations. Some give flat cultivation and lay out in single rows two and a half to three and a half feet apart, and in some

districts flat culture is unquestionably best. Others lay out in double rows about two feet apart, and between each pair of rows the soil from the center is drawn up to each side, making a low ridge or level a little higher than the surface on which the plants are set. This levee serves as a walk between the beds and holds back the water upon the bed when irrigated by flooding. Another, and the generally-adopted plan, is to have the plants in double rows on a slight ridge, while between the beds is a furrow which serves as a walk and for irrigation. This is accomplished by throwing up the soil with the plow into ridges about two feet wide, with a double furrow between. On the sides of these ridges the plants are set, and often on the top of the ridge between the rows of strawberries a single row of onions or lettuce, or some other vegetable, is grown the first year. In irrigation the water is drawn up from the trenches by the roots and by capillary attraction, and the upper surface does not bake as it would by flooding if the soil be heavy. In hoeing out weeds and in fruit gathering, the workman walks in the ditch and does not pack the soil around the plant by tramping. This is the best method of laying out for large plantations. The rows are a uniform distance apart across the field, whether the space between be a ridge or a ditch. The method of making the beds a little lower than the general surface of the ground, answers best on free, open soils with perfect drainage. Cultivation can be reduced by covering the depressed surface of the bed with a mulch of fine, clean litter, such as chaff, cut straw, etc. This retains moisture and gives the berry a clean surface to rest on. Such a bed is an excellent arrangement for the home garden.

In all arrangements the plants are set at less distances in the rows than the rows are from each other. Probably the prevailing distance is one foot between the plants; the range is from eight to eighteen inches in the practise of different growers, and determined, of course, largely by the habit of the variety. A vine like the Sharpless, with a spreading growth and long fruit stems, needs, perhaps, the sixteen inches which some growers give it, while the smaller, more compact, Longworth Prolific may do well with half that distance.

Planting Strawberries.—Strawberry plants are set out either in spring or fall, or at any time in the winter when the ground is warm and in good condition. In the drier parts of the State, early fall or winter planting is more essential than elsewhere. If the ground is dry, water should always be used in planting. This may be given by thorough irrigation of the ground before planting, or a little water may be used in setting each plant. At planting it is usually best to remove all leaves from the plant,

shorten the roots to three inches or less, and be sure the plants do not dry while planting progresses. As with handling rooted grape-vines, it is advisable to carry around the plants in a vessel which has water in it. If plants have been received by mail, they are invigorated by soaking in water a few hours before planting.

In setting the plants, scoop out a little excavation with the hand or a trowel, spread the roots well, cover with fine soil, being sure that the crown of the plant shall not be below the surface when the soil is leveled. Too many strawberry plants are *buried*, not planted. Some plant very rapidly by using a dibble to make a hole, into which the roots are dropped and soil pressed around them by using the dibble alongside; others set the plants on the side of the furrow, trusting to the next furrow to complete the covering. Nearly all ways succeed if the plant is not set too deeply and the ground is moist at planting and not allowed to dry out afterwards—providing good, strong plants are used. In buying plants it is often poor economy to buy the cheapest.

Staminate and Pistillate.—In associating varieties be sure that pistillate varieties are not set by themselves. Some sorts have perfect flowers and are self-fertilizing; others have only the pistillate element in the bloom and must have the staminate adjacent in another variety. All the varieties largely grown in California have perfect flowers, though some pistillate sorts have been locally approved.

Care of the Strawberry Plantation.—Herein lies the secret of success with the strawberry. Neglect has led to disappointment and condemnation of the strawberry, where intelligent care would have rendered it a constant delight. The chief elements of proper care may be thus enumerated:—

Retention of moisture very near the surface by careful, shallow cultivation or by mulching, persistent destruction of weeds, and compensation for summer evaporation by frequent irrigation. The plants during the bearing season should never be allowed to show any leaf-shriveling from drouth. Frequency of irrigation depends upon local conditions. Irrigation at intervals of four to ten days, according to the soil, are the outlines of prevailing practise.

Constant removal of runners from all plants except those it is desired to multiply to furnish new plants or to fill the rows. Pinching of runners should always accompany picking or hoeing of weeds, and on the garden bed there can be no excuse for neglect in this respect. The young plants should be faithfully freed from runners to strengthen them up for bearing.

Though, as already stated, strawberries may in some locations be had all winter, it is better practise, as a general rule, to

lay the plants away for a rest. The market season in the regions supplying the San Francisco market extends from April to December, and fruit is continuously shipped during that period. At the approach of winter in the last-named month, it is usual to go over the beds with a sickle, cutting off the old crop of leaves close to the root crown, carefully cleaning up the plantation for the heavy rains. In most cases it will be a great advantage then to cover over all with a light coat of good manure, which the winter rains will leach down into the soils. The result of the fall clipping and enriching will be an early and strong start of the plant in the spring, and a most abundant fruitage.

Duration of the Plantation.—Strawberry plants well cared for and not visited by insect pests, have a long, productive, and profitable life in California. Twelve-year-old plants at Santa Clara have been reported as still producing abundantly. It is customary to count from five to eight years as the profitable life of a plant, though some growers replant after two bearing years.

Varieties of the Strawberry.—Though all new varieties are tried by California growers, and quite a number may be considered successful either for market or for home use, only a very few may be said to be widely grown. The three kinds which are pre-eminent in public favor are the Longworth Prolific, the Sharpless, and the Monarch of the West. The Sharpless is the most widely grown; the Monarch shows better size and color in southern California and on the Sierra foot-hills than in the regions adjacent to San Francisco, although it is grown therein to some extent. The Longworth is an old favorite, early, productive, and hardy, and its style has become very popular in the markets. Wilson's Albany also holds favor in same. The Melinda is largely grown in the Pajaro Valley. The Gandy and Dollar are approved in several counties.

The best drought-resisting strawberry grown in California at the present time is the Arizona Everbearing. It is a leading variety in southern California, and is very hardy, enduring much drought and neglect, which the home strawberry bed is apt to get when the fruit grower is very busy in his orchard. It is a late berry and bears all summer if well treated. It is handsome in form and color. The Australian Crimson, Brandywine, Lady Thompson and Laxton's Noble are also popular at the south, and a variety called Shepherd's is preferred at Santa Barbara.

It has been demonstrated that varieties show marked difference in behavior in different soils and situations. In planting for market or home use in new regions the planter will be safe in making his largest plantations of the varieties named above, and at the same time he should put out experimental plots of other varieties. In planting in established strawberry regions, secure the best available local advice, consulting a number of growers and forming decision from such evidence.

PART SEVENTH: NUTS.

CHAPTER XXXIV.

NUT GROWING IN CALIFORNIA.

Two nuts have risen to large commercial importance in California: the English walnut and the almond. Other nuts than these, except peanuts, have never attained great acreage, although several have succeeded and promise to become popular.

The walnut has thus far only been produced in large quantities in Santa Barbara, Ventura, Los Angeles, and Orange Counties, and an aggregate annual product of eight and a quarter million pounds has been attained in this district. The almond product, which in some years amounts to five hundred thousand pounds, has been chiefly grown in central California.

THE ALMOND.

The almond has an interesting history in California, but it can be outlined in a few sentences. The importation of the best European varieties began very early, and a number of them had been planted in 1853. They proved irregular bearers, though the trees grew thriftily and in some cases showed fruit very soon after planting. The barren almond trees were largely grafted into prunes or made into firewood and the conclusion was reached that to secure regularity and abundance in fruiting, locations for almond orchards must be sought with the utmost care, and that the secret of success lay in the location. After that local seedlings seemed to demonstrate their value in regular crops, and in characteristics and qualities superior to foreign kinds. Large planting was then undertaken on the ground that the choice of soil and situation, and the selection of trustworthy varieties, are both factors of success, but that possibly more lay in the choice of variety than of location. This belief led to wide planting in locations now seen to be unfitted by reason of frosts and at the close of the century the almond acreage is being reduced by cutting out unprofitable trees, and it seems to be fully demonstrated that no matter what variety is chosen, locations

for the almond must be selected with great care. It has also been demonstrated that association of varieties promote pollination and satisfactory bearing.

Situations and Soils for the Almond.—Almonds are now doing best on the higher lands in coast valleys, free from fogs and protected from direct winds, but subject to tempered breezes; also at various points in the interior valleys and foot-hills. The general proposition that low lands in small valleys should be avoided, and bench or hillside situations preferred, seems to be a safe one. Lands directly upon the coast have not proved satisfactory.

The almond prefers a loose, light, warm soil, and heavy, poorly-drained soils should be avoided. Though they need moisture enough to make good, thrifty growth they will produce good crops on soils that are too light or dry to grow satisfactory peaches, apricots, nectarines, cherries, or similar pulpy fruit. The almond is, however, a very deep-rooting tree, and may succeed by reaching deeply for moisture rather than by denying itself, as some think. The tree certainly suffers and is barren from drouth in some cases.

Propagating, Planting, and Pruning.—The almond is propagated from seedlings grown as described in Chapter VIII, and budded as described in Chapter IX. The almond root is preferred, though the peach answers well. The apricot root should be avoided.

For planting out, trees in dormant bud are very successful if given proper care. Yearling trees are, on the whole, best, and usually those which have made a moderate instead of a very large growth are to be preferred. The almond makes a comparatively large tree and should have plenty of room—not less than twenty-four feet apart (though some plantations are made at twenty feet), and thirty feet is better.

The pruning of the almond is very simple. The tree should be headed low and pruned during the first three years, as described in Chapter XII, to secure a shapely, strong tree. After the third year little pruning is required except to thin out objectionable branches by winter pruning. There is danger of allowing the trees to become too dense. Shortening in, as practised with the peach, is not desirable with the almond.

The cultivation of the almond orchard is the same as commended for other fruit trees, and as the trees are often planted in naturally dry soils, the greater care in cultivation is needed to retain sufficient moisture to give good size to the nuts. In certain locations, of course, irrigation will be necessary, but usually a light rainfall will answer if good cultivation is given.

Gathering, Hulling, and Bleaching.—Almonds are gathered by spreading canvas under the tree and shaking the branches separately; the few nuts remaining can be displaced by striking with a light stick. The gathering should be done after the hulls have burst open, but should not be delayed until the nuts are badly discolored. Discoloration of the nut depends upon local atmospheric conditions and is worst in regions subject to moist winds or fogs from the ocean, and they often extend considerable distances into the interior valleys. On dry plateaux adjacent to the Mojave Desert perfectly bright almonds are produced naturally.

Hulling is done with machines devised for that purpose. There are several in use and recently great capacity and cheapness of operation have been attained.

For the greater part of the almond product bleaching is apparently demanded by market requirements. Sulphur should not be applied until the nut is thoroughly dry, or else the fumes will penetrate it, and not only spoil its flavor, but will destroy its germinating power. The nuts are dried by exposure to sun on platforms or trays, and in dewy places should be covered during the night. After being well dried, sprinkle the nuts sufficiently to moisten the shell surface and apply sulphur fumes. Various home-made contrivances are used for bleaching, such as piling up several of the slat-bottom trays one upon another, placing around them sides made of boards so as to hook together at the corners, cover the top with a damp canvas, and burn the sulphur in a hole in the ground below the bottom tray.

Webster Treat, of Davisville, a large grower of almonds, describes his sulphuring-house for almonds:—

My bleaching-house is about twenty-five feet by eight feet, and I generally put in about four thousand pounds of almonds, and expose them to sulphur fumes for three or four hours. The house is boarded with tongue and groove flooring, inside and out, and roofed with well-laid shingles, and has a flue about two feet high on the apex, to help draft the sulphur smoke up. The floor is of one-by-three-inch stuff, set up edgewise, three-eighths of an inch apart, or just wide enough to admit the fumes from the sulphur burning below, and narrow enough to prevent the nuts from falling through. The floor is about two and one-half feet above the ground, and the lower space is boarded up with tongue and groove also, and fitted with small doors every five feet, so that the sulphur pans can be placed underneath the floor.

Sulphur fumes are applied until the nuts are of a light yellowish color; the proper shade is to be learned by securing approved samples from some trustworthy dealer.

Varieties of the Almond.—Almonds should bear well every year, hull easily, have clean, thin, soft shells, and a smooth, bright, and plump kernel. Almonds with long, single kernels

are preferred in general to those which have double ones. These are the characters which ruled in the selection of new varieties by our leading propagator of new almonds, A. T. Hatch, formerly of Suisun. In 1878 Mr. Hatch planted out about two thousand five hundred seedling almond trees grown from bitter almond seed. He afterward budded all the seedlings but about three hundred, which were left to bearing age unbudded. The fruit of these seedlings was of all degrees of excellence. A few of the best of them were selected for propagation and naming, and they constitute the chief part of the large acreage which is now credited to the almond in Chapter VI.

Excellent seedling almonds have also been produced by other growers. The following list includes the sorts most widely grown:—

IXL.—"Tree a sturdy, rather upright grower, with large leaves; nuts large, with, as a rule, single kernels; hulls easily, no machine being needed, nor is any bleaching necessary; shell soft, but perfect. It bears heavily and regularly."—*A. T. Hatch*.

Ne Plus Ultra.—Large and very long in shape; heavy and regular bearer; soft shell; hull free.

Nonpareil.—First called *Extra*. Of a weeping style of growth; smaller foliage than the *IXL*, but still forms a beautiful tree. An extraordinarily heavy and regular bearer, with very thin shell, of the Paper Shell type.

Lewelling's Prolific.—Originated with the late Mr. John Lewelling; "tree a great bearer; of drooping habit; nut large and good; soft shell; hull free."—*Leonard Coates*.

Harriott's Seedling (or *Commercial*).—From Visalia, where it is a surer cropper than elsewhere; shell softer than the Languedoc; nut long, of peculiar shape, quite large; kernel sweet.

King's Soft Shell.—Originated in San Jose; shell very thin and soft; regular and abundant bearer.

Princess.—The finest of the Paper Shell class; long, oval, kernel large, white and sweet.

Languedoc.—Nut large; shell thin; kernel sweet; condemned for irregular bearing.

Paper Shell.—Medium size; shell very tender, easily broken between the finger and thumb; kernel large, white and sweet.

Drake's Seedling.—Originated with Mr. Drake, of Suisun, of the Languedoc class; very prolific, and a regular, abundant bearer. The latest blooming variety.

Golden State.—Originated by Webster Treat. A large soft-shell, somewhat longer than the Languedoc, with a full, smooth-skinned meat; parts from the hull readily. An early variety, but in less favor than formerly.

THE CHESTNUT.

The chestnut is not yet produced in large amount in California, and certain quantities of the nuts are annually imported, the American, Italian, or Spanish and Japanese all being found in the San Francisco markets. Of chestnuts grown in Califor-

nia, the Italian predominates, and the Japanese is more common than the American, which is slow of growth and late in fruiting, as compared with the other kinds. Judging by the success of the Italian, it may be said that a large area of California is well suited for the growth of the chestnut, as there are bearing trees in nearly all parts of the State. The chestnut succeeds on heavy, clayey soil, even if it be quite rocky.

Chestnut trees are readily grown from the seed, and thus grown come into bearing in from six to eight years, though the Japanese sometimes bears sooner. The growth of chestnuts from the seed is described in Chapter VIII. In growing from seed of the improved varieties, there is a tendency toward reversion, and budding and grafting may be resorted to; budding is done by the ring method, as described in Chapter XXVIII. The chestnut can also be grafted with the ordinary cleft graft. Buds or scions should be taken from trees which are fruiting satisfactorily, and in this way seedlings which have a tendency to bear empty burs can be turned to good account. Chestnuts can be grown in the nursery until several years old, providing they are lifted at the end of the first year, the taproot cut off, and the trees reset, giving them rather more room than during their first year's growth. In permanent plantings the trees should have plenty of room, as they ultimately attain great size. Mr. R. G. Sneath reports seeing trees at Grass Valley, Nevada County, about twenty years old, which are fifteen inches in diameter of trunk, and forty feet high, and reported to be bearing a barrel of nuts to the tree regularly. Felix Gillet, of Nevada City, has for many years made a specialty of propagating a large collection of the improved French varieties of the chestnut, known as *Marrons*, which are now quite largely distributed. The chestnut has not however, attained any considerable product as yet. The chestnut, aside from its desirability as an orchard tree, can be commended as a tree for hillsides or a shade tree for waysides or pastures, and should be more widely planted in California.

THE FILBERT.

The best English cob-nuts have been quite widely tried in California without successful results. Improved Spanish and French varieties of the filbert were early introduced by Felix Gillet, of Nevada City, and have been favorably reported by him as to growth and bearing. A few other growers in foot-hill situations have reported success, but as a rule disappointment has attended ventures with the filbert. The most favorable regions for farther experiment are apparently the north slopes of the Coast Range, and other cooler and moister situations, as well as at an elevation on the Sierra foot-hills, where Mr. Gillet pronounces them satisfactory.

THE PEANUT.

During the last few years the peanut product of California has notably increased and the crop is a popular one in some parts of the San Joaquin Valley and southern California. The nuts are considerably grown between the rows in young orchards and vineyards, as well as upon ground wholly given to them. The following explicit directions are given by R. M. Hargrave, a grower in Orange County. Some slight modifications in practise may be needed, according to locality, as, for example, in time of planting, which is usually a little earlier than the date given:—

Planting.—The best time to plant peanuts is about the middle of May, say 10th to 15th, in rows about three to four feet apart and sixteen to twenty inches the other way, and not cover too deep—three or four inches. Peanuts planted the middle of May ripen evenly and are of uniform size. Very early peanuts ripen unevenly, and the first nuts that set on get so ripe they turn to a pink color, and if the land is a little sandy the stems get soft, lose their strength, and will not lift the nuts from the ground.

It takes about thirty pounds of the California or White Virginia, and fifty pounds of the Tennessee Reds, to plant an acre. Tennessee peanuts can be planted much closer in the rows. The California peanut is the best to plant, as it yields three or four times as much as the Tennessee Reds do, and has more ready sale.

The Quality of Land.—Peanuts require a rich, sandy soil loam, that is known as upland. Damp land gives the nuts a straw color, and they are not as good a quality as those raised on higher land. They require no irrigation, except on very sandy land, where some have found it profitable; but, as a usual thing, when irrigated the ground is liable to get hard, making the nuts crooked, ill-shaped, and many times coloring them.

Cultivation.—Peanuts should be cultivated about the same as corn, not allowing any weeds to grow in them, keeping the ground loose and mellow, and when the spikes begin to form, they should not be disturbed. If they are, it causes the nuts to blight or not fill out. The blooms do not require to be covered.

Harvesting.—Peanuts should be harvested when ripe, and not allowed to stand too long, in hopes that the last ones set out will fill out and ripen, as you lose more than you gain. The little ones spoil the sale of the crop, and many are left in the ground that get overripe. Peanuts should be cut or plowed out and thrown into windrows, nuts down, and let lie a week or ten days, and then sacked, as the best nuts are cured in that way, and they do not mold so badly, and cure a better color. They must not be allowed to get wet. The tops are good feed if stored away in a shed for winter use. All kinds of stock like them, and small nuts can be left on the vines. They make the best chicken feed. An average yield is about twenty-five to thirty sacks to the acre, forty pounds to a sack, but many have raised fifty sacks, with extra care and good land well adapted to peanuts.

THE PECAN.

The pecan, by rapid growth, early fruiting, and general thrift, seems to be the member of the hickory family best fitted

for California conditions. A tree grown from a nut planted by J. R. Wolfskill, on Putah Creek, in 1878 was, in 1894, over fifty feet high, with a trunk twelve inches in diameter, growing luxuriantly and bearing freely. Still older trees, also very satisfactory in growth and bearing, are to be seen at Chico and Visalia. The pecan, though grown for thirty years by different parties around the bay of San Francisco, either does not bear or keeps the nuts hanging on until sometimes they sprout on the tree. The wider extremes in temperature or in humidity in the interior seem to teach the tree better habits of growth and rest. As yet, California has no large marketable product of pecans.

Pecan trees grow readily from the nuts if these are fresh. Planters should secure nuts of selected varieties (for there is a great difference in size and quality) direct from growers in the southern States, and plant as soon as received, in the early winter, or if conditions are not favorable for planting, the nuts should be stored as described in Chapter VIII. Nuts planted in good nursery ground in rows as there suggested, and covered about two inches or a little deeper in dry, loose soil, and then mulched to retain moisture, will germinate freely. The trees should be transplanted to permanent place at the end of the first year, and then usually the taproot can be retained, as some growers deem very desirable; if the trees are to be put in permanent place later they should be transplanted in the nursery and the taproot cut off. The nuts can, of course, be planted at once in permanent place if one will take the extra trouble necessary to properly care for them.

THE PISTACHIO.

The pistachio nut (*Pistachia vera*) was introduced a number of years ago but no results have been reported. The species upon its own root makes a low shrub and is very slow of growth. We have also imported the *Pistachia terebinthus*, from which is derived the "chio turpentine," and which is the stock upon which the true pistachio is grafted in Europe. It is a very hardy tree, the largest specimens probably being on the Rixford Ranch, in the Sonoma Valley.

THE ENGLISH OR PERSIAN WALNUT.

The nut which is signified in California when the term walnut is used, is the English walnut or Madeira nut (*Juglans regia*) and its many varieties. This tree makes a grand growth in California. Specimens can be found here and there, which, at about twenty years of age, are from fifty to sixty feet in height, with a spread of branches of forty to sixty feet, and in some cases bearing four to eight hundred pounds of nuts. Such trees can be found in the rich valleys of both northern and southern Califor-

nia, but, as has already been stated, the English walnut has thus far been produced in large quantities only in regions adjacent to the coast in southern California, though there are promising plantations farther removed from coast influences. The equable temperature of the southern coast seems, however, to specially favor the nut. A number of French varieties, which have been widely enough distributed to test their growth, have been found to thrive in many situations where the old Los Angeles variety is a failure, and there is at present quite a disposition to larger



Six-year-old English Walnut of A. E. Cole—Old San Bernardino.

plantings of the walnut, as a sole occupant of the land or as border trees around fruit orchards. At the South the walnut area has largely increased in those situations where the tree shows most satisfactory bearing qualities. In the South newer varieties of California origin, like the Improved Soft Shell, constitute most of the present area. In all untried places, or in all places where the old Los Angeles Walnut has failed, trial should

be made of the hardy French varieties, which will be described farther on. Recently considerable planting has been done in the coast and interior valleys and foot-hills of central California upon the quite fully demonstrated success of these varieties. It is, however, very desirable to secure satisfactory depth and retentiveness, without excess of water, in the soil. The walnut abhors drouth as well as standing water.

Soils for the Walnut.—The walnut makes most rapid growth upon a deep, rich, moist, loamy soil, and shows its appreciation of good things of the earth as do other fruit trees, and yet it attains satisfactory size and bearing in less favorable situations. Thriving trees can be found in the clays and decomposed granite soils of the foot-hills, as well as in the valley silts and loams. Adequate moisture must, however, be had, and the walnut can not be commended for dry, neglected places.

Propagation.—The walnut tree grows readily from nuts treated as described in Chapter VIII. In the main the use of seedlings prevails, and the nut is usually considered to come true from seed. Excellent results have, however, been obtained by using the California black walnut as a stock for the English walnut, and in that case budding or grafting must be resorted to. Many instances of the success of the English walnut on our native stock might be cited, but the most notable tree known to the writer is to be seen on the grounds of John R. Wolfskill, on Putah Creek, in Solano County. He put in a bud in 1875 and the tree has reached immense size and large product. Since then many large native black walnuts have been top-grafted with English walnut with notable success.

In working on the native California seedling stocks, Mr. Clowes, of Stockton, buds by the common method, removing the wood from the inside of the plate of bark, as advised for the orange. Twig buds as used with the olive (Chapter XXIX) are also successful, and ring budding (see page 325) works well on shoots of a year's growth, which have at least attained the thickness of the middle finger. Mr. Gillet advises that the buds should be set at the base of these shoots where the wood is perfectly round. The bandage should pass above and below the bud so that the bark under it may be pressed down close upon the stock, and this is more surely gained by shaving off the base of the leaf stem, below the bud, about to the point where it would separate when the leaf naturally falls off.

Grafting into the black walnut seedling root can also be well done by a triangular cut into the edge of the root stump, as described for grafting into grape-vine stumps. In the case of the walnut, close binding with a wax band is desirable.

Large walnut trees can be worked over either by budding or grafting. If by budding, the large limbs are cut back in the

winter, and in August following, ring buds are put on as many of the new shoots as may be desired. In grafting, the common cleft graft is used, but the split should not be made through the pith, but at one side; the scions should be whittled so as to show as little pith as possible. This is done by cutting down to a point at one side and not in the center of the scion. Care should be taken to cover all exposed surfaces. Grafting over in this way is desirable either for substituting a better variety of English walnut, or for working over a California black walnut into an English variety.

Planting Walnut Orchards.—There is much difference in practise in planting out walnut trees in permanent place. Some advocate the use of trees two or three years from the seed, getting as much of the taproot as possible; others allow the tree to remain in nursery until it throws out laterals, which is usually done the fourth or fifth year. Two-year-old trees are generally preferred, but walnut trees of many times that age can be successfully transplanted if the work is carefully done. Walnut trees are usually set forty feet in squares, though some give the larger-growing varieties fifty feet. Planting in hexagonals at forty-five feet distance gives very satisfactory results. Some growers plant in squares at thirty feet distance, intending to remove alternate trees as they crowd each other, first cutting back, for a time, the trees which are finally to be removed.

Intercultures with the Walnuts.—In the southern walnut regions it is common to grow beans, squashes, etc., between the rows of trees until the latter reach bearing age; root crops which attract gophers should be avoided. Inter-planting of smaller, early-fruited trees is also practised to a considerable extent.

Pruning the Walnut.—The walnut is usually headed higher than ordinary orchard trees, but preference is now given to starting the first branch at about four feet from the ground instead of six feet as formerly. All the pruning needed is in shaping the tree as described for the fig. Upward trend of the branches should be secured, sometimes by cutting out the shoots which grow downward, sometimes by tying them up for a time to the central stem until they are stiff enough to retain this position. Placing branches on the stem according to the principles advanced in Chapter XII, should be borne in mind. The stem should be protected from sunburn until the foliage accomplishes this. Whenever shoots are killed back by sunburn or by frost, they should be cut off cleanly below the black mark which shows how far the injury has extended. If this is done, the die-back down the branch is usually prevented.

Bloom and Bearing of the Walnut.—The walnut has its staminate and pistillate blooms separate, but both occur on the same

tree, as shown by the engraving of a twig with both associated. All the buds marked *a* are staminate, and will develop into cat-

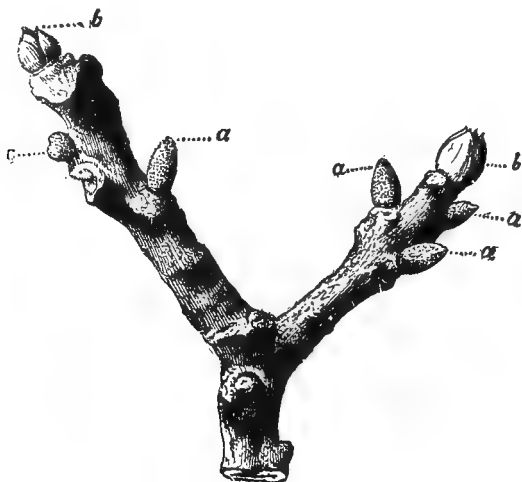

FIG. 1. Staminate and pistillate buds of the walnut.



FIG. 2. Catkin of the walnut.



FIG. 3. Pistils and embryo nuts.

kins, shown in Fig. 2. The terminal buds *b* are pistillate and will develop into embryo nuts, each bearing a little branched

plume-like pistil, as shown in Fig. 3. The bud marked *c* in Fig. 1 is a leaf bud.

Successful fruiting depends upon the appearance of these two forms of bloom, without too great interval of time, and the lack of bearing of some varieties has been found to be due to the fact that the catkins disappeared too long before the pistillate bloom was sufficiently developed to receive the pollen.

The bearing age of the walnut depends upon the variety. Some of the French varieties now grown here are very precocious and have borne fruit in nursery row at two and three years old, but the pistillate blooms were then fertilized from catkins growing on older trees. The practical bearing age of the English walnut in this State may be rated at six to eight years, according to the variety.

Gathering walnuts is done in different ways; some gather them from the ground at intervals during the months of September and October; others use poles and clean the trees at one operation; some go over the ground three times; first, picking up what have fallen; second, picking up what have fallen, and striking the limbs lightly to dislodge others which are ripest; third, picking up again and then knocking off all that remain on the trees. In this way gathering lasts a month or six weeks. Walnuts, after gathering, are usually treated as described by F. E. Kellogg, of Santa Barbara County:—

As fast as gathered the nuts are placed in slat-bottomed trays 6x3 feet, by six inches deep, about fifty pounds in a tray, where they are allowed to dry for three or four days, being thoroughly shaken up once or twice a day. If the weather is very hot, they should be dried in the shade. When the nuts are dry they are passed through an inclined, revolving grader, making about twelve revolutions per minute, having a one-inch-mesh wire screen, and all that fall through this are called "seconds." The lower end of the grader dips into a vat of water, thoroughly wetting the nuts and washing them to a certain extent—entirely sufficient for paper shells and soft shells, and usually enough for hard shells. A system of buckets attached to the drum of the grader then elevates the nuts to a chute, which discharges them into a large box 4x4x8 feet high, with an inclined slat bottom two and one-half feet above the ground. While in this box, they are subjected to the fumes of sulphur for twenty to thirty minutes for the purpose of improving the color. The second grade walnuts are also put through the washing and sulphuring process. The nuts are next drawn off from the bleachers into the drying trays, piled one on top of the other, to prevent the sun from shining directly on the nuts, and remain there for ten or twelve hours, until the nuts are thoroughly dried off. The trays are then emptied into a hopper, from which the nuts are drawn off into bags containing something over one hundred pounds each; the bags are securely sewed up and stamped with the producer's brand, and the nuts are ready for shipment.

Dipping instead of Sulphuring.—Sulphuring often injures the flavor of the kernel and dipping is coming into wide use.

The following formula has been furnished to growers by the University Experiment Station:—

Six pounds bleaching powder (also called chloride of lime), twelve pounds sal-soda, fifty gallons water. Dissolve the bleaching powder in about four gallons of water, stirring till dissolved. Dissolve the sal-soda in about four gallons of water. Add one solution to the other and stir well; let the carbonate of lime settle to the bottom and draw off the clear liquor and add water to make a total of fifty gallons. Put the nuts in large dipping box or lath crate, immerse in the fluid, and then add one and one-fourth pounds of fifty per cent sulphuric acid and agitate by raising and lowering the dipping box. The bleach should be reached in five to ten seconds, and the nuts are then washed in clear water and put out to dry. Of course to employ this process cheaply specially contrived dipping appliances are used. The same liquor can be used with new batches of nuts so long as the proper effect is produced, and small additions of acid will prolong the efficiency of the liquor.

Varieties of the Walnut.—Of walnuts of California origin there are two classes, which are called “hard” and “soft” shell, but the accepted commercial product is largely composed of the soft-shell class. Several varieties of French walnuts are now being widely distributed. An attempt will be made to give some of the distinctive points of each variety mentioned:—

Common English Walnut; Los Angeles Nut, etc.—This is the ordinary English walnut of commerce. It was planted at an early day in Los Angeles County, but is now largely replaced by the Improved Soft Shell.

Santa Barbara Soft Shell; Sexton's Soft Shell.—Originated by Joseph Sexton, who gives this account of its origin and characteristics: “The winter of 1867 I bought in San Francisco a large sack of English walnuts. I raised about one thousand trees that season, and planted two hundred of them the following spring, in orchard form, at Goleta. Sixty of them proved to be the soft-shell variety. The soft shell is a little later in starting in the spring than the common nut, and blooms about ten days later. It commences to fruit at six years old from the seed, and some have been known to fruit as young as the fourth year. The hard shell commences to fruit about the ninth year, and bears full crops alternate years. The soft shell is not as strong a grower as the other walnut; it being so prolific retards its growth. It is a superior nut; the kernel is white. The shell is thin, rendering them easily broken by the hand, at the same time strong enough to bear transportation to any part of the United States.”

Ford's Improved Soft Shell.—G. W. Ford, of Santa Ana, propagated an “Improved Soft Shell,” gained by selection from the variety of Joseph Sexton, which has been largely planted.

Proeparturiens—This famous French variety was introduced in California in 1871, by Felix Gillet, of Nevada City, and has since then been brought in by other parties, and is now widely distributed. Its chief characteristic, as its name indicates, is early bearing. The variety blooms from two to four weeks later than the common Los Angeles seedling; it shows both kinds of bloom simultaneously, and has the characteristics of ripening its wood well, and high quality of the nut.

Other French Varieties.—Quite large collections of French varieties other than Proeparturiens have been introduced by Mr. Gillet and others. The Cluster walnut fruits, as its name indicates, in long bunches, sometimes as many as fifteen in a bunch; otherwise the tree resembles the common English walnut. The Mayette is a large, full-fleshed, and sweet nut, very late in budding out in the spring, and suited for frosty places. The Franquette is a very large, elongate-oval, blooms late, and is commended for size and quality of the nut. The Parisienne is a beautiful variety, the nut large, broad, and shapely; the tree blooms very late. All the foregoing varieties and the Serotina, Barthere Mesange, Gant, and Chaberte, were introduced by Mr. Gillet, in 1871.

Kaghazi.—A variety called Kaghazi was grown and propagated for several years by the late James Shinn, of Niles, who described it as follows: "Very much larger than the ordinary kinds, and thinner shelled. The tree is late in putting out leaves and blossoms, and is, therefore, especially good for places that are in danger of last frosts."

Japanese Walnut; Juglans Sieboldiana.—This species, native of the north of Japan, was introduced to California about 1860, and a tree grown from seed planted about that time is growing at the Tower House, in Shasta County. Recently the good points of the tree have been more widely recognized. The following excellent description is by Luther Burbank, of Santa Rosa: "This species is found growing wild in the mountains of northern Japan, and is, without doubt, as hardy as an oak. The leaves are of immense size, and a charming shade of green. The nuts, which are produced in extreme abundance, grow in clusters of fifteen or twenty, have a shell thicker than the English walnut, but not as thick as the black walnut, very much resembling pecan nuts. The meat is sweet, of the very best quality, flavor like butternut, but less oily, and much superior. The trees grow with great vigor, assume a very handsome form, need no pruning, mature early, bear young, and are more regular and productive than the English walnut." The nut has an exceedingly hard shell and does not rate commercially with the popular varieties of the English walnut.

PART EIGHTH: FRUIT PRESERVATION.

CHAPTER XXXV.

FRUIT CANNING, CRYSTALLIZING, AND DRYING.

The preservation of fruit in various ways for home use and distant shipment, is one of the leading industries of California, employing a large amount of capital and labor, and distributing a vast amount of money among our people. These facts can be best emphasized by statements of the product of 1897, in the leading methods of preservation; by canning and drying. The crop of 1898 was seriously reduced by drouth and frost and that of 1899 is incomplete at this writing.

CANNED FRUIT PRODUCT OF 1897.*

		Cases.
Table fruits,	2½-lb. cans, two dozen per case	1,753.280
Pie fruits,	“ “ “ “ “ “	27,883
“	1-gal. “ one “ “	118,403
Jams and jellies, 2-lb.	“ two “ “	43,416
Total.....	46,631,568 2½-lb. cans, or	1,942.982

This product was the output of thirty-eight canning establishments, located in different parts of the State, and the product is weighed and valued upon page 56. So far as the comparative use of different fruits can be made out, it is as follows:—

	Cases.		Cases.
Apples.....	7,421	Pears, other.....	11,500
Apricots.....	317,408	Peaches	738,794
Cherries, black.....	32,331	Plums.....	122,630
Cherries, white.....	110,170	Quinces	5,199
Currants	5,697	Strawberries.....	8,166
Grapes	32,206	Raspberries.....	3,810
Nectarines.....	1,369	Blackberries.....	20,976
Pears, Bartlett.....	329,794	Gooseberries.....	4,809

* "California Fruit Grower," Nov. 5, 1898.

CURED FRUIT PRODUCT IN POUNDS.

KIND.	1894	1895	1896	1897
Raisins.....	103,000,000	91,360,000	68,250,600	93,704,000
Prunes.....	44,750,000	64,500,000	55,200,000	97,780,000
Peaches.....	30,540,000	24,500,000	16,460,000	27,150,000
Pears.....	6,530,000	5,400,000	9,650,000	6,350,000
Apricots.....	28,750,000	10,650,000	6,740,000	30,125,000
Dried Grapes.....	4,500,000	4,250,000	2,690,000	3,450,000
Apples.....	5,850,000	4,560,000	2,350,000	5,250,000
Figs.....	1,540,000	2,750,000	2,160,000	3,250,000
Plums.....	2,760,000	4,500,000	2,100,000	3,250,000
Nectarines.....	1,250,000	1,350,000	625,000	285,000
Totals.....	229,470,000	213,820,000	166,225,600	270,594,000

THE CANNING INDUSTRY.

Fruit canning began in California about forty years ago, but during the last two decades has attained its greatness, and is now promising much wider extension. The process is simple, and yet is attended at every point, from the purchase of the fruit to the sale of the product, with operations which require experience, wisdom, and good judgment. It will be obviously impossible to give in print a guide to the pursuit of such an industry. The principles involved in the process of commercial canning are, of course, the same as rule in the old kitchen processes, but to secure uniformity and cheapness of product a vast number of manipulations and appliances have been devised. These begin with the manufacture of the cans and attend the product to the end, and the realization of the commercial and uniform production which they assure involves the employment of large capital and the keenest business ability. The canning interest has, therefore, segregated itself more and more widely from the growing interest. Orchard canning on a small scale which was once thought feasible has passed out of sight except as it is seen to lie in the foundations of a few of the smaller canneries which have been built upon it. It seems clear now that as a rule the fruit grower's duty to the canning interest ceases with the production of acceptable fruit unless individuals or associations can command capital enough to enter the field on equal vantage with the large commercial canneries. Capital is flowing toward the business; the field for the product seems to be constantly expanding, and canning centers are multiplying throughout the State wherever ample supplies of good fruits and vegetables are available.

Varieties for Canning.—The table previously given showing the fruits which enter in various amounts into the canned product gives a general idea of what fruits should be planted to minister to the canner's demand. As to varieties, it is not easy

to make a general prescription, because the choice differs somewhat with different localities. It is a good idea for the new planter to consult with owners of adjacent bearing orchards and to secure from the nearest canneries lists which are acceptable to them.

CRYSTALLIZED FRUITS.

Progress is being continually made in the production of candied, crystallized, or *glace* fruits, but the product is not a large one. Special establishments are now doing this work in Los Angeles, San Jose, and San Francisco. They have processes which are the result of considerable experimentation, and they do not make them public. To others the way lies open to similar experimentation. The general theory and an outline of practise as given by J. J. Pratt, of the Yuba City Cannery, is as follows:—

The theory is to extract the juice from the fruit, and replace it with sugar syrup, which, upon hardening, preserves the fruit from decay, and at the same time retains the natural shape of the fruit. All kinds of fruit are capable of being preserved under this process. Though the method is very simple, there is a certain skill required that is acquired only by practise. The several successive steps in the process are about as follows:—

First, the same care in selecting and grading the fruit should be taken as for canning; that is, the fruit should be all of one size, and as near the same ripeness as possible. The exact degree of ripeness is of great importance, which is at that stage when fruit is best for canning. Peaches, pears, etc., are pared and cut in halves, as for canning; plums, cherries, etc., are pitted. The fruit, having thus been carefully prepared, is put in a basket, or a bucket with a perforated bottom, and immersed in boiling water. The object of this is to dilute and extract the juice of the fruit. The length of time the fruit is immersed is the most important part of the process. If left too long, it is overcooked and becomes soft; if not immersed long enough, the juice is not sufficiently extracted, which prevents a perfect absorption of the sugar.

After the fruit has been thus scalded and allowed to cool, it can again be assorted as to softness. The next step is the syrup, which is made of white sugar and water. The softer the fruit, the heavier the syrup required. Ordinarily about seventy degrees, Balling's saccharometer, is about the proper weight for the syrup.

The fruit is then placed in earthen pans, and covered with the syrup, where it is left to remain about a week. The sugar enters the fruit and displaces what juice remained after the scalding process.

The fruit now requires careful watching, as fermentation will soon take place, and when this has reached a certain stage, the fruit and syrup are heated to a boiling degree, which checks the fermentation. This heating process should be repeated as often as necessary for about six weeks.

The fruit is then taken out of the syrup, and washed in clean water, and it is then ready to be either glazed or crystallized, as the operator may wish. If glazed, the fruit is dipped in thick sugar syrup and left to harden quickly in the open air. If it is to be crystallized, dip in the same kind of syrup, but allow to cool and harden slowly, thus caus-

ing the sugar which covers the fruit to crystallize. The fruit is now ready for boxing and shipping. Fruit thus prepared will keep in any climate and stand transportation.

Thus far the crystallized fruit produced in California has sold well. There is a considerable importation of French fruit to the United States, which may be displaced by the California product, and the business commends itself to those who have ingenuity, patience, and capital enough to enable them to experiment and wait for future success. The California producer has the advantage of an abundance of very fine fruit at a low price. According to the consular reports, the fruits best for crystallizing are not cheap in France.

FRUIT DRYING.

To describe minutely the methods and appliances employed for the drying of fruit in California would require a volume, and is beyond the scope of this treatise. A very small fraction of the California dried fruit product is made by artificial heat. Since it was first ascertained that, by the use of sulphur before exposing the fruit to the sun, it can be cured without darkening its color, sun drying has largely taken the place of machine drying. The capacity of any machine is infinitesimal as compared with the acreage of sunshine. Owing to the beautiful light color of the fruit and the great care in boxing and adorning it, California sun-dried fruit sells as evaporated fruit—than which a higher commercial tribute can not be paid to its excellence. Though this is true, there is probably still a great field for machine driers, especially in the upper coast region, and they are also used on a large scale by firms and associations as a supplement to sun drying. Their capacity and economical use of heat are continually being improved, and their product, when well manipulated, approaches perfection as a preserved product.

Although the sun drying of fruit may be a simple process, so many little arts, methods, and appliances are continually being introduced to facilitate work or improve the product, that one can learn much by visiting the different fruit regions during the drying season. Such a course is commended to growers who contemplate large drying operations, for suggestions of great economic importance can be secured. The notes of practise which can be given in this connection must be brief and general.

Trays for Drying.—The greater part of the fruit, including raisins, is placed upon trays for exposure to the sun. There is great variation in the size of the trays. The common small tray is made of one-half-inch sugar-pine lumber two feet wide and

three feet long, the boards forming it being held together by nailing to a cleat on each end, one by one and a quarter inches, and a lath or narrow piece of half-inch stuff is nailed over the ends of the boards, thus stiffening the tray and aiding to prevent warping. A cross-section of such a tray is shown at *A*.

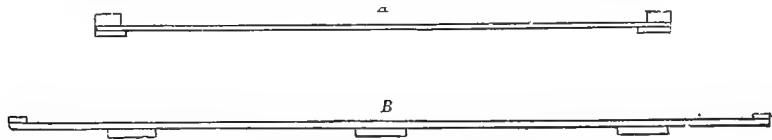

Cross-sections of Drying Trays.

A large tray which is used by some growers is four feet square, and is made of slats three-eighths of an inch thick, and one and a half inches wide, the slats being nailed to three cross slats three-eighths of an inch thick and three inches wide, and the ends nailed to a narrow strip one-half inch thick by three-quarters of an inch wide on the other side. A cross-section of this tray is shown at *B*.

Since large drying yards have been supplied with tramways and trucks for moving the fruit instead of hand carriage, larger trays, three feet by six or three feet by eight, have been largely employed. These tramways lead from the cutting sheds to the sulphur boxes and thence to various parts of the large drying grounds, making it possible to handle large amounts of fruit at a minimum cost.

Protecting Fruit from Dew.—In the interior there is seldom any deposit of dew in the drying season, but occasionally there are early rains before the drying season is over. The fruit is then protected by piling the trays one upon another, in which operation the thick cleats serve a good purpose. In dewy regions the trays are piled at night, or cloth or paper is sometimes stretched over the fruit, thus reducing the discoloration resulting from deposits of moisture upon it.

Drying Floors.—For the most part the trays are laid directly on the ground, but sometimes a staging of posts and rails is built to support them, about twenty inches from the ground. The drying trays are sometimes distributed through the orchard or vineyard, thus drying the fruit with as little carrying as possible. Others clear off a large space outside the plantation and spread the trays where full sunshine can be obtained. Drying spaces should be selected at a distance from traveled roads, to prevent the deposit of dust on the fruit.

Grading.—It is of great advantage in drying to have all the fruit on a tray of approximately the same size, and grading be-

fore cutting is advisable. Machines are now made which accomplish this very cheaply and quickly.

Cutting-Sheds.—Shelter of some kind is always provided for the fruit-cutters. Sometimes it is only a temporary bower made of poles and beams upon which tree branches are spread as a thatch; sometimes open-side sheds with boarded roof, and sometimes a finished fruit-house is built, two stories high, the lower story opening with large doors on the north side, and with a large loft above, where the dried fruit can be sweated, packed, and stored for sale. The climate is such that almost any shelter which suits the taste and purse of the producer will answer the purpose.

Sulphuring.—There is constant discussion concerning the desirability of sulphur fumes in connection with fruit drying. The discussion may result in educating buyers so that they will purchase unsulphured fruit at a good price, but they are of no such mind at present, and the producer can not afford to do otherwise than use sulphur on fruits on which the demand is for a light color. Sulphur-bleaching of old, discolored, sun-dried fruit in a sort of resurrecting process, is very different from the exposure of freshly-cut fruit to sulphur fumes before putting out in the sunshine. The latter is the practise which is at present usually signified by the term sulphuring, although sulphur is also used with the machine driers.

There are various contrivances for the application of sulphur fumes to the freshly-cut fruit. Some are small for hand carriage of trays; some are large and the trays are wheeled into them upon trucks. The most common is a bottomless cabinet about five or six feet high, of a width equal to the length of the tray and a depth a little more than the width of the tray. The cabinet has a door the whole width of one side, and on the sides within cleats are nailed so that the trays of fruit slip in like drawers into a bureau. Some push in the trays so that the bottom one leaves a little space at the back, the next a little space at the front, and so on, that the fumes may be forced by the draft to pass between the trays back and forward. The essentials seem to be to open holes or dampers in the bottom and top of the cabinet so that the fumes from the sulphur burning at the bottom may be thoroughly distributed through the interior, and then all openings are tightly closed. To secure a tight chamber the door has its edges felted and the cabinet is made of matched lumber. The sulphur is usually put on a shovel or iron pot, and it is ignited by a hot coal, or a hot iron, or it is thrown on paper of which the edges are set on fire, or a little alcohol is put on the sulphur and lighted, etc. The sulphur is usually burned in a pit in the ground under the cabinet. The

application of sulphur must be watchfully and carefully made, and the exposure of the fruit should only be long enough to accomplish the end desired. The exposure required differs with different fruits, and with the same fruits in different conditions, as must be learned by experience.

Grading and Cleaning.—After the fruit is sufficiently dried, (and it is impossible to describe how this point may be recognized except by the experienced touch) it is gathered from the trays into large boxes and taken to the fruit house. Some growers put it into a revolving drum of punctured sheet iron, which rubs the pieces together and separates it from dust, etc., which falls out through the apertures as the drum revolves. Others empty the fruit upon a large wire-cloth table and pick it over, grading it according to size and color, and at the same time the dust and small particles of foreign matter fall through the wire cloth. The fanning mill for cleaning grain may also be used for rapid separation of dirt, leaves, etc., with proper arrangement of metal screens.

Sweating.—All fruit, if stored in mass after drying, becomes moist. This action should take place before packing. To facilitate it, the fruit is put in piles on the floor of the fruit-house and turned occasionally with a scoop shovel; or, if allowed to sweat in boxes, the fruit is occasionally poured from one box to another. The sweating equalizes the moisture throughout the mass. Some large producers have sweat-rooms with tight walls, which preserve an even temperature. No fruit should be packed before "going through the sweat." If this is not done, discoloration and injury will result.

Dipping before Packing.—All fruits except prunes can be packed in good condition without dipping, provided the fruit is not overdried. Efforts should be made to take up the fruit when it is just sufficiently cured to prevent subsequent fermentation. If taken from the trays in the heat of the day and covered so that the fruit moth can not reach it there is little danger of worms. The highest grades of fruit are made in this way. If, however, the fruit has been overdried or neglected, it can be dipped in boiling water to kill eggs of vermin, and to make the fruit a little more pliable for the press. The dipping should be done quickly, and the fruit allowed to drain and then lie in a dark room, carefully covered, for twenty-four hours before packing.

Packing.—To open well, packages of dried fruit should be "faced." The many fine arts of paper lining, etc., must be learned by observation. Flatten some fair specimens of the fruit to be packed (and reference is especially made to such fruits as apricots, peaches, and nectarines) by running them

through a clothes' wringer or similar pair of rollers. Do not face with better fruit than the package is to contain. It is a fraud which will not in the end be profitable. Lay the flattened fruit (cup side down) neatly in the bottom of the box. Fill the box until it reaches the amount the box is to contain, and then apply the press until the bottom can be nailed on. Invert the box and put on the label or brand; the bottom then become the top.

Many different kinds of boxes are used. A very good size is made of seasoned pine, six inches deep by nine inches wide by fifteen inches long, inside measurements, and it will hold twenty-five pounds of fruit.

METHODS WITH DIFFERENT FRUITS.

As already intimated, it will be impossible to enter minutely into the operations of drying and packing on a commercial scale, or even to notice all the small and ingenious arts by which the work is facilitated. Any one who contemplates production on a large scale should personally visit leading regions and inform himself by inquiry and observation. Such an education will save mistakes, which may cost many times more than the expense of getting it. California producers are usually quite willing to show visitors the methods they employ. Though this is the better way of proceeding, a few general hints will be given of methods with different fruits.

Apples.—There seems little use of drying apples unless a very light-colored, handsome product can be turned out. This can be done by sulphuring as soon as cut, and sun drying in a dry region, or by the use of a machine evaporator in regions of greater atmospheric humidity. Recently the product has largely increased.

Apricots.—Apricots for drying should be fully ripe but not soft enough to be mushy. By the use of sulphur and sun heat, an amber-colored, semitranslucent fruit is obtained. The prevailing method of gathering is to shake down the fruit upon sheets, but the best product is hand picked. Pit the fruit by a clean cut completely around in the suture; do not cut part way round and then tear apart—a clean-cut edge is essential. Put on the trays with the skin down, or with the cup up, as it is sometimes described; sulphur, and then put in the sun. About three days of interior-valley sunshine will finish the apricots. Apricots will yield on the average one pound of dried fruit to five pounds of fresh.

Berries and Cherries.—These fruits are only dried in the sun in small quantities for local sale, and ordinary farm-house methods are employed.

Figs.—The fruit may be carefully picked from the tree so as to secure the whole of the stem, when the fruit is fully ripe, as is known by the seaming or slight shriveling of the skin. In drying the common black fig from large trees, however, the fruit is generally gathered from the ground, which is cleaned and smoothed before the crop ripens. In drying black figs the fruit is placed on trays and in most cases exposed to the sun, but some foot-hill growers maintain the advantage of drying in the shade. The figs should not be allowed to dry hard. When sufficiently cured, put in sweat-boxes for several days, and when ready to pack dip in boiling salt water, or, as is the practise of some producers, dip in a thin syrup, boiling hot. In either method a good, pliable condition and handsome color are obtained. In drying white figs many sulphur the fruit from fifteen minutes to an hour before putting out on the trays. Figs which dry slowly have to be turned several times during the drying, and those which are apt to run juice are placed so that the eye is raised a little until the juice is thickened. The white figs are also put in sweat-boxes and dipped in hot salt water before packing. In packing, the figs are often flattened and drawn out by the hand. Such manipulation gives the fig a lighter and more translucent appearance. The time required in drying figs is usually from five to eight or ten days, according to location and weather. The fruit does not cure evenly, and those which are finished (as determined by sight and touch—to be learned by experience) are picked from the trays, and others given more time.

Pears.—The dried pear product is increasing, and, as with apples, only a light-colored product is profitable. These are made by sulphuring and sun drying, or by the use of the machine drier. For sun drying the fruit of medium size is halved, the large fruit being quartered.

Peaches.—Peaches are sun dried in much the same way as apricots, already described. Take the fruit when it is fully ripe, but not mushy; cut cleanly all around to extract the pit and put on trays cup side up; get into the sulphur box as soon as possible after cutting. Peaches are dried both peeled and unpeeled, but drying without peeling is chiefly done. Peeling is done with the small paring machines or with a knife. Peeling with lye has been generally abandoned because of discoloration of the fruit after packing.

Clingstone peaches are cut with a knife invented by G. W. Tarlton, of San Jose. It consists of the blade of any common knife (like a shoe-knife), with a short U-shaped blade set in at the point of the main blade. In cutting the peach in halves,

the curved blade skims around the stone, completely severing it from the peach. This device has enabled the grower to pit clings as easily as freestones, but owing to the strength required in the wrist, the pitting of clings can best be done by men. The Tarlton knife works admirably, both with mellow and quite firm fruit, and is, therefore, vastly superior to the spoon-shaped knife, which can only be used on soft fruit. A strong, active man can pit five hundred to seven hundred pounds of clings in a day.

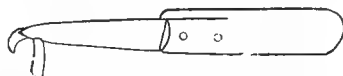

The Tarlton Knife for Pitting Clingstone Peaches.

The weight of dried peaches which can be obtained from a certain weight of fresh fruit, depends upon the variety; some varieties yield at least a third more than others, and clings yield more than freestones as a rule. Dry-fleshed peaches, like the Muir, yield one pound dry from four or five pounds fresh, while other more juicy fruit may require six or seven pounds.

Nectarines.—Nectarines are handled like peaches; the production of translucent amber fruit in the sun depends upon the skilful use of sulphur.

Plums and Prunes.—Our pitted plums, which are an acid fruit, are meeting with more favor than formerly, and the product is increasing. Pitting is done by hand or by the use of foot-power "pitters." More rapid and capacious machines are being brought out by inventors.

Prunes are one of our greatest and most promising products. Several varieties which dry sweet with the pit in are used in making prunes, as already stated in Chapter XXII, but the prevailing variety is the Prune d' Agen.

Prunes are gathered by shaking from the trees, usually upon sheets spread beneath. Several gatherings are made by light shakings which cause only the ripe specimens to fall.

Prunes are usually graded before drying, and various home-made contrivances are employed. Some use inclined planes of adjustable slats, the grader being thus available for other fruits than prunes; the large fruit rolls along into receptacles at the bottom, while the small fruit falls through into other receptacles. Other grading devices are made with wire screens or riddles of different sizes of mesh. Some of them work on the principle of a fanning mill, three to four riddles, placed above one another, each with a slight incline, and a spout on the side where each grade drops into a box. Some have a long riddle, say twelve feet long, with three different sizes of wire screen on it. This riddle

is hung upon four ropes with an incline; the prunes are thrown in the higher end, and by shaking it they roll down and fall through the holes into boxes underneath. The first piece of screen should be small, to let only stems and dirt through, and no prunes. This long hanging screen is also used to grade prunes after drying. There are now several excellent manufactured fruit graders on sale in this State. Their work is very satisfactory, and they have largely displaced home-made contrivances.

The next step in the process is dipping in lye to thin and crack the skin, which facilitates the escape of moisture in the drying process. In a large caldron lye is made with one pound of concentrated lye to each twenty gallons of water, and kept boiling hot. The fruit is put into wire baskets or galvanized pails with perforated sides and bottoms, and dipped in the boiling lye for about a minute, or until the skin has a wrinkled appearance, then the basket is plunged into clean cold water to rinse off the lye. This rinsing water must be frequently changed, for it soon becomes very alkaline. Some begin with a stronger lye solution, one pound to ten gallons of water, claiming that a very short dip in stronger lye is better than longer exposure in a weaker solution. After this dipping, the prunes are placed on trays. In the sun the prune dries sufficiently in from one to two weeks, according to the situation and weather.

A process of puncturing the skin of the prunes by causing them to roll over needle points has also been employed to some extent. There are now manufactured very capacious appliances for continuous dipping, rinsing, puncturing and spreading on the trays so that the fruit is handled in large quantities at a minimum cost. In no branch of our fruit industry perhaps has there been greater advance in labor-saving devices than in prune handling.

When sufficiently dried, the prunes are put through the "sweat," which takes from several days to two or three weeks, and then are ready for grading, finishing, and packing. In grading, the prunes are separated by the use of a grader, as already described, into a number of grades, the largest, forty prunes to the pound, and so on, fifty, sixty, etc., to the smallest, which may run one hundred or more to the pound. Finishing consists in exposing to steam, in dipping in clear hot water, or hot sugar syrup, or in dipping in boiled juice of ripe prunes, or peaches or apples, etc. Although there is a great variety of materials used for "glossing" prunes by different producers, the prevailing practise is to rely upon hot water, to which pure glycerine is added at the rate of one pound to twenty gallons. Some growers also add a little brine (having first dissolved the salt and skimmed

off the impurities). This final hot dip kills insect eggs, and the fruit, after drying off away from the access of insects, should be packed tightly in boxes.

Raisins.—The varieties of grapes used for raisins are described in Chapter XXVI. The production of raisins has reached such an extent, and employs so much skill and capital, that the processes employed to facilitate the curing and packing are so various that a description of them can not be attempted. Besides, there is now available an excellent special treatise on this subject.* However, in beginning the commercial production of raisins, one should visit the raisin farms and packing-houses during the harvest. The following description by T. C. White, of Fresno, gives an outline of practise in the vineyard:—

In Fresno picking commences about the first of September, although there have been seasons when it occurred as early as the 20th of August. The grapes under no circumstances should be picked for raisins until they are ripe. There are three ways by which to ascertain this fact: First, by the color, which should be a light amber; second, by the taste; and third, by the saccharometer, which is by far the most accurate. A grape may be ripe, and not have the proper color, when grown entirely in the shade. The juice of the grape should contain at least twenty-five per cent saccharine, to produce a good raisin.

The method of drying is with trays placed upon the ground. The almost entire absence of dew in our locality greatly facilitates this method. The trays are usually twenty-four by thirty-six inches, which hold about twenty pounds of fruit, and should produce from six to seven pounds of raisins. The product of a vineyard depends largely upon its age and favorable conditions, varying from two to nine tons of grapes per acre.

The trays are distributed along the sides of the roads, from which they are taken by the pickers as they are needed. As the grapes are picked from the vines, all imperfect berries, sticks, and dead leaves are removed from the bunches, which are then placed upon the trays, right side up. A cluster has what is called a right and a wrong side, the wrong side having more of the stems exposed than the right side. Great care should be used in picking, so as to handle the branches only by the stem. If the berries come in contact with the hands, some of the bloom will be removed, which will injure the appearance of the raisins. The trays are placed, after filling, between the vines, one end being elevated so that the grapes may receive the more direct rays of the sun.

Too rapid drying is not desirable. The grapes are left upon the trays until about two-thirds dry, which, with us, will be in from six to eight days. They are then turned. This is accomplished by placing an empty tray on top of the one filled with partially-dried raisins, and turning them both over. Then take off the upper or original tray, and you have the raisins turned without handling or damage. After turning, curing will proceed more rapidly, and frequently is completed in four or five days. During this time they should be carefully watched to prevent any from becoming too dry. When it is found they are dry enough, the trays are gathered and stacked one upon another as high as convenient for the sorting which follows. This protects them from the sun and prevents overdrying. Stacking should be attended to early

* "The Raisin Industry," by Dr. Gustav Eisen, large 8vo., 255 pp., fully illustrated.

in the morning, while the stems and berries are slightly moist and cool from the night air, as they will retain this moisture after being transferred to the sweat-boxes, and assist in quickening the sweating process.

As the raisins are taken off the trays, some of the berries on the bunches will be dry enough and a few will not be sufficiently cured. To remove the moist ones would destroy the appearance of the cluster, and to leave it out longer would shrivel the dry ones, hence the sweat-box. The moisture is diffused through the box, some being absorbed by the dry raisins, and the stems also taking their share are thus rendered tough and pliable and easily manipulated when ready for packing.

Sorting and grading require care and judgment, and although a tedious process, it greatly facilitates rapid packing. The sweat-box is a little larger than the tray and about eight inches deep, and contains about one hundred and twenty-five pounds of raisins. Heavy manila paper is used in the sweat-boxes, one sheet being placed in the bottom, and three or four more at equal distances as the filling progresses. The object of the paper is to prevent the tangling of the stems and consequent breaking of the bunches when removed for packing.

The sorters have three sweat-boxes, one for the first, second, and third qualities, as the grade will justify. The bunches should be handled by the stem and placed carefully in the sweat-boxes to avoid breaking the stems, thereby destroying the symmetry of the clusters. Any found to be too damp are returned to the trays and left a day or two longer in the sun. To ascertain if the fruit is perfectly cured, take a raisin between the thumb and forefinger and roll it gently until softened, when either jelly or water will exude from the stem end—if water, it requires further drying. When the boxes are filled, they are taken to the equalizer. This should be built of brick or adobe, and as near airtight as possible, but provided with windows to allow ventilation when necessary. The windows should have shutters to keep it dark. The filled boxes are placed one exactly upon another to a convenient height, and should remain from ten to twenty days or more, when they will have passed through the sweating process. When the raisins are sufficiently equalized, the sweat-boxes are removed to the packing-room, which is provided with tables, presses, scales, etc.

The foregoing relates to the preparation of the standard clusters. Loose raisins are now being produced in increasing quantities. Loose Muscatels are prepared by being put through the stemmer and grader. The stemmer removes the berries from the stems, and the grader, by separating according to size, determines the grade. During the last few years the seeding of raisins has increased rapidly, and large establishments for this work, with very ingenious machinery, have been erected. Seeded raisins promise to constitute a considerable portion of the product.

A considerable quantity of dipped raisins are also made of the Sultana grape and of loose or inferior Muscatels. A lye dip of about one pound of potash to twelve gallons of water is used, and the solution is kept boiling hot. The ripe fruit is dipped for an instant, then plunged in fresh water for a thorough rinsing, and then placed on the trays. During warm, dry weather in the interior, the raisins are dried in the shade by leaving the

trays in piles, but if cooler, moister weather prevails, the trays must be spread out. The product is a handsome amber color.

An oil-dip is also being profitably used with Thompson's Seedless:—

One quart olive oil; $\frac{3}{4}$ pound Greenbank soda and 3 quarts water are made into an emulsion, and then reduced with 10 gallons water in the dipping tank, adding more soda to get lye-strength enough to cut the skins, and more soda has to be added from time to time to keep up the strength. The grapes are dipped in this solution and sulphured to the proper color.

Drying of wine grapes for sale at the East or in Europe is practised. They can be profitably produced at quite a low price, in much the same way that raisins are made but with less care.

GRAPE SYRUP.

The manufacture of grape syrup, which was formerly of considerable prominence as a means of disposing of wine grapes, has recently received less attention because of low prices in competition with the vast amount of syrup available from the sugar refineries. As the source of sugar is now so largely the beet, grape syrup may again be profitable in the future. Open evaporating pans are chiefly used.

PART NINTH: FRUIT PROTECTION.

CHAPTER XXXVI.

INJURIOUS INSECTS.

The California climate, which so favors tree and plant by a long, mild growing season, also enables some insects to multiply much more rapidly than they do in wintry climes, some having several distinct broods, others carrying on the work of reproduction and destruction of plants nearly the year round. If, however, as now seems likely, a good part of the repression of injurious insects may be trusted to other insects, parasitic or predatory, the climate will favor the multiplication of friend as well as foe, and thus carry its own compensation. This result has been promoted by the introduction of beneficial insects from other parts of the world. It is also a fact that California fruit growers have invented methods and appliances for repression of injurious insects which have demonstrated notable efficiency and value.

In order to arrange injurious insects in classes in a popular way, the grouping will be based upon the character of the work they do, an arrangement which has been followed by other writers, and which is better than attempting to group the insects which prey upon any single tree or plant, because injurious insects seldom restrict themselves to a single food plant. Therefore the grouping will be as follows: (1) Insects destroying foliage; (2) insects upon the bark or upon the surface of leaf and fruit; (3) insects boring into the twig, stem, or root; (4) insects boring into the pulp of fruits.

The literature upon the subject of insect pests in California is quite extensive, but much of it is beyond the reach of the general reader. There are, however, a number of publications which should be on the shelves of every fruit grower, and these are the bulletins and reports of the experiment stations of the University of California, at Berkeley; of the State Board of Horticulture, at Sacramento; and of the Division of Entomology, of the U. S. Department of Agriculture, at Washington. The

study of the pests and the invention of means for their destruction are, however, continually progressing, and one can only keep himself informed of this progress, and profit by improvements, by diligent reading of California periodicals devoted to practical horticulture.

INSECTS DESTROYING FOLIAGE.

Army Worms.—Smooth caterpillars about an inch or more in length when fully grown; prevailing color black, with light-colored stripes on the sides; moving forward in large bodies, hence the name; six forward legs; eight central legs; two rear legs; usually most destructive to grass and grain, but invade vineyards and orchards. Most available remedy is spraying the leaves with Paris green, one pound to two hundred gallons of water on most growth but not stronger than one pound to two hundred and fifty gallons on peach trees. The progress of the worms can be temporarily arrested by plowing furrows in dry ground outside the planted area and treatment of them by burning or crushing outside this barricade.

Cut Worms.—Smooth, plump, dull-colored caterpillars destroying buds and leaves at night and hiding by day in loose dirt at the base of the plant. Remedy: Paris green as above, or used upon bunches of alfalfa or other vegetation placed at the base of the plant as a trap, or uncovering and collecting the worms, or using the bran and arsenic remedy which will be mentioned later for grasshoppers.

Canker Worms.—Slim caterpillars of different colors, moving by a looping gait, and often completely defoliating trees very early in the season. Remedy: Paris green spray, and



Canker-worm Moths; *a* Male, *b* Female.

banding of the trees with paper on which is spread a mixture of printers' ink and molasses, to prevent the wingless moth from ascending the trees to deposit eggs on the twigs. In this mild climate these bands must be put on in December and maintained through the winter. The use of a trap has largely superseded these bands as follows: Take No. 16 or 14 wire cloth in strips six inches wide, draw and tack the top edge close to the trunk of the tree over a bandage of cloth two inches or less wide which is put on first to make the joint tight. The lower edge

flares out half an inch or more from the tree all around. This will prevent the moths getting up, and will need cleaning about once a week for four weeks or more. Probably not one trap in ten will need touching.

Tent Caterpillars.—Several species of hairy caterpillars called “tent caterpillars,” or “web worms,” from their spinning covers of cobweb-like material, under which they take shelter in large colonies; but one, at least, of the group does not spin a web, though it lives in clusters on the tree. The worms can be killed by cutting off and burning the twig holding the cluster or by burning the colonies in place with a torch on the end of a pole,

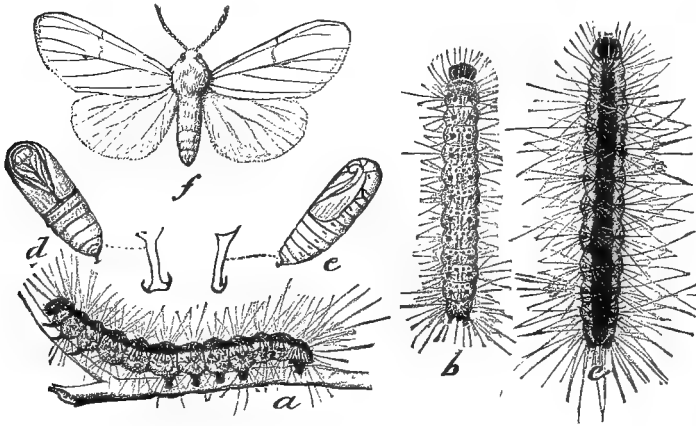

Larvæ, Pupæ and Moth of Web Worm.

or by spraying the foliage with Paris green. The pest can be reduced by carefully collecting and burning the egg clusters while pruning. The egg cluster encircles the twig, as shown in the adjacent engraving.



Red-humped Caterpillar and Moth.

Red-Humped Caterpillar.—Striped caterpillars, not hairy, but having two rows of black spines along the back, also living in clusters; of reddish color with yellow and white lines; a short distance back of the red head of the caterpillar is a red hump on which are four black spines; black spines are also scattered over the body, but smaller than those on the back. Spray with Paris green, or cut off and burn colonies.

Caterpillar of Tussock Moth.—A conspicuous caterpillar with four short, brush-like tufts on its back, and two long, black plumes at the front, and one at the rear of the body—see engraving. This leaf-eater is found on apple, pear, plum, and sometimes on other fruit trees, also on the walnut and oak. The caterpillars can be killed with a Paris green spray. The larva spins a cocoon sometimes in the fold of a leaf, more commonly in crotches or rough places on the bark, or even on adjacent buildings or fences, and the female, after emerging from the

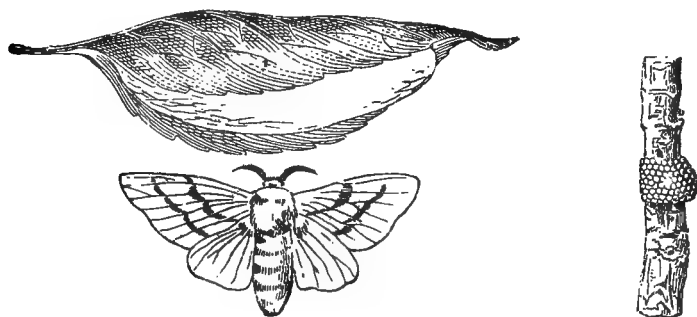

Cocoon, Moth and Eggs of Tent Caterpillar.

cocoon, deposits her eggs upon the outside of it. The engraving below shows the wingless moth and cocoon with the mass of eggs deposited upon it. The insect is fortunately very freely parasitized and prevented from wide injury. It can be reduced by destroying the egg-masses during pruning, as they are white and very conspicuous.

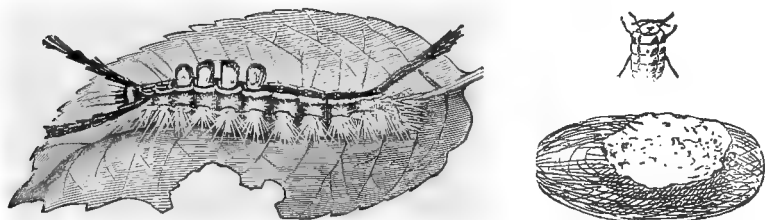

Tussock-moth Larva, Wingless Female and Cocoon with Eggs.

Pear and Cherry Slug.—A small, slimy, dark-colored worm, with the fore part of the body notably larger than the rear part, eating the upper surface of the leaves but usually not making holes through them. The insect can be checked by throwing fine road dust or air-slacked lime over the tree, which cakes upon the slime of the worm and destroys it. On a large scale a Paris green spray is best.

Saw-Fly Worms.—There are several larvae of saw-flies which do much injury to pear trees, currants, etc., by eating the whole leaf substance except the larger ribs. The worms are small, not slimy like the pear slug, the one infesting the pear



The Pear and Cherry Slug (a) and Saw-fly Worm.

being about half an inch when fully grown. Its general appearance and work are shown by the engraving. The most available remedy is a Paris green spray.

Large Caterpillars on Grape-vines.—The grape-vine is often seriously injured by the attacks of very large leaf-eating worms two inches and upwards in length, sometimes with a large horn,



Sphinx-moth Larva on Grapevines.

or spine, sometimes without. They are larvae of several species of Sphinx moths or humming-bird moths, and of swallow-tail butterflies (*papilio*). The worms can be killed by Paris green

spray or by hand-picking. The numbers of worms can be reduced by killing the large moths, which are abundant at night-



Caterpillar of Swallow-tail Butterfly.

fall on beds of verbenas, or other garden flowers. These worms are related to other large caterpillars which feed on tobacco, tomatoes, etc.

Leaf-Eating Beetles.—There are many beetles, large and small, which infest grape leaves. They can all be reduced by the use of Paris green, or those which drop to the ground when disturbed may be collected in large numbers on sheets spread below.

INSECTS UPON BARK OR SURFACE OF LEAVES OR FRUIT.

Leaf Lice.—Leaves of fruit trees, especially the apple and plum, are sometimes almost covered with lice or aphides of different colors, from light green to black, some individuals having wings and some wingless. Available remedies for all these leaf lice are the resin wash and the kerosene emulsions which will be given later as summer washes for scale insects, with a spray nozzle which sends spray upwards, so as to reach the under sides of the leaves. Very often these pests are effectually cleared out by lady-birds and other insects which devour them. The engraving shows the general form of the aphid tribe.

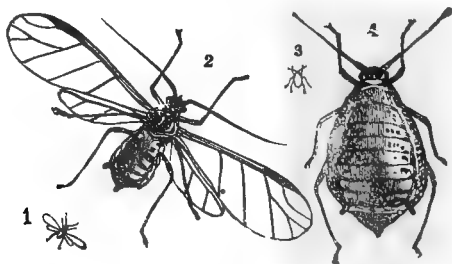

The Aphis or Leaf Louse.

Thrips.—Very minute insects infesting leaves of pear, causing them to wither and fall off—the leaves usually being covered with black dots. Remedies the same as for leaf lice.

Vine Hoppers.—Very minute, yellowish, jumping insects infesting grape-vines very early in the season, and multiplying

rapidly. They exhaust the sap from the leaves, causing them to turn yellow and fall, exposing the grapes to sunburn. There are two kinds of vine hoppers. One in the Fresno region rises in a cloud when the vine is disturbed; the one at Florin, and at some points near the coast, drops to the ground. There is yet no satisfactory way to catch the insects that rise into the air. The ones that drop to the ground are handled quite satisfactorily by using wide, shallow pans in which half an inch of water with a little kerosene oil is put. These pans are made half round on a circle about a yard in diameter. Two men take pans and both come up to the vine quickly from opposite sides and push the pans under it. Thus the two pans largely cover the ground under the vines and the bugs drop into the kerosene. Some growers have saved their crops in this way. Treatment should begin early in the season, before the vines run out so far that it becomes so difficult to drop the hoppers in the pans.

False Chinch-Bugs.—Small, grayish-brown insects (about one-eighth of an inch long when fully grown), which injure the vine leaves. They drop to the ground when the vine is disturbed, and may be caught as just described for vine hoppers.

Grasshoppers.—These pests often invade orchard and vineyard, and sometimes kill the plants outright by completely defoliating them. This plague has been successfully met by the use of the arsenic and bran remedy, prepared as follows: Forty pounds of bran, fifteen pounds middlings, two gallons of cheap syrup, twenty pounds arsenic, mixed soft with water; a tablespoonful thrown by the side of each vine or tree. Cost per acre for trees, twenty-five cents; for vines, fifty cents. If placed on shingles about the vineyard, much of the poison not eaten may be afterward gathered up and saved. Complete success has resulted from the use of this remedy, as the grasshoppers eat it readily and die in their tracks.*

Red Spider and Other Mites.—Very minute insects, usually discernible only with the aid of a magnifier, sometimes destroy the leaves, causing them to lose their color and health by their inroads upon the leaf surface. The red spider and yellow mite are conspicuous examples; they infest nearly all orchard trees, especially the almond, prune, and plum. The eggs of the red spider are ruby-red globules, as seen with the magnifier, and are deposited in vast numbers upon the bark of the tree, and leave a red color upon the finger if it is rubbed over them. The eggs are very hard to kill, and treatment is most effective when applied in the spring and summer after the mites are hatched out. The popular remedy is a thorough dust-

* For the protection of nurseries, orchards, and vineyards it is often necessary to resort to various devices for excluding the grasshopper, or for destroying them upon adjoining fields. Publications describing such devices may be had free by addressing the Secretary of Agriculture, Washington, D. C.

ing of the trees with sulphur, after spraying with cold water. On a large scale the sulphur is applied in a cloud by means of a modification of the broad-cast barley sower. On a small scale it may be applied with a bellows as for grape-vines, or shaken from a cheese-cloth bag at the end of a pole. Some growers prefer a spray to sulphuring, and the following, recommended by G. P. Hall, of San Diego, is very cheap and satisfactory: Take 20 pounds of sulphur, mix it to a paste—not sloppy—with cold water, in a barrel; then add to this wet sul-

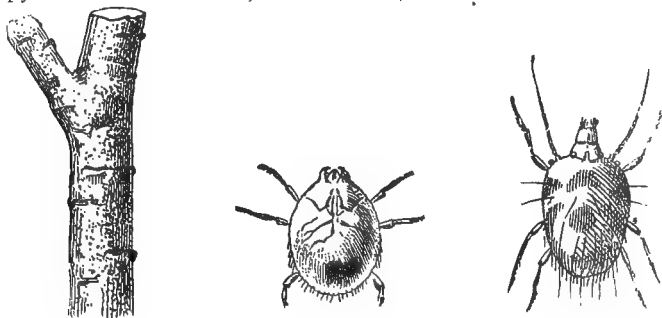

Red Spider: Young and Mature, Highly Magnified.

phur 10 pounds of caustic soda 98 per cent, and it will boil the sulphur just like lime slaking; have 20 gallons of water to add to it as it boils to prevent its burning. This is a stock solution, and when ready to spray put 40 gallons of water in another barrel, and take one-half gallon of the stock solution and add to it, straining it to prevent sediment from getting into the spray.

Phylloxera.—This pest of the grape-vine is closely allied to the aphides, and lives both upon the root and leaf, though in this State the root type prevails and the leaf form is seldom

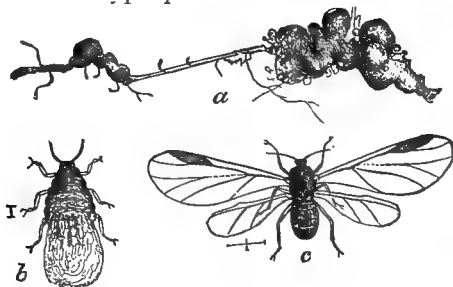

Woolly Aphis and Injured Roots.

seen. No remedy has yet been found effectual, but escape is had by using roots resisting the insects, as described in Chapter XXIV. The insects are recognized, by the aid of a magnifier, as minute yellow lice, chiefly on the rootlets.

The Woolly Aphis.—A louse of dark red color, occurring in groups, covered with a woolly substance which exudes from the bodies of the insects. In the engraving, *a* is the gall or swelling produced on the rootlets by their presence; *b* is the insect, showing the outgrowth of woolly matter; *c* is the winged female. The woolly aphid is an almost universal pest of the apple, though as shown by experience, some varieties are practically exempt from it. As the pest lives both upon root and top, its annihilation is impossible, but it may be reduced so that the fruitfulness and vigor of the tree are not impaired. The use of wood ashes around the tree close to the trunk has been beneficial. Removing the earth from the root-crown and applying from two to five pounds of tobacco dust—a refuse from cigar factories—destroys the insects at this point and prolongs the effective life of the tree. The insect on the branches and twigs can be reduced by spraying with the summer washes soon to be given for scale insects, or the clusters of the insect can be touched with a swab dipped in kerosene, but the kerosene should not be allowed to spread upon the bark. Ladybirds often clear away the woolly aphid of the tree above ground.

Much attention is now being given to trial of resistant roots and it is likely that such roots will be generally used here as in Australia.

Scale Insects.—This is a large group of pests which occasion greater loss and trouble to our fruit growers than all other pests combined. There are many species, and no orchard tree is exempt from the attacks of one or more of them, though some trees are apparently more popular with the pests than others. The fruit grower should study their life history and classification as laid down in the works on entomology. It will only be possible in this connection to introduce a few engravings, by which some of the most prominent pests can be recognized, and to give some of the remedies which are now being most successfully employed against them.

San Jose Scale (Aspidiotus perniciosus).—This was formerly one of the worst and most widespread of the species of scales preying on deciduous fruit trees in California, but at present, owing to friendly insects which prey upon it, has become of minor importance, and, in fact, has practically disappeared from some regions where it was formerly most injurious. The work of this species is generally readily distinguished from other species of scale by the red blotches which are formed wherever it stings any part of the tree—either branch, leaf, or fruit. These red blotches are more pronounced in some varieties than in others. When the scales are present in large numbers, it causes a complete discoloration of the bark clear to the sap-wood.

This scale has its preference among the deciduous fruits. The apricot is apparently proof against it; certain varieties of cherries and plums are but little affected. The engravings show a pear affected by the scale; also the insect, natural size, on a twig;

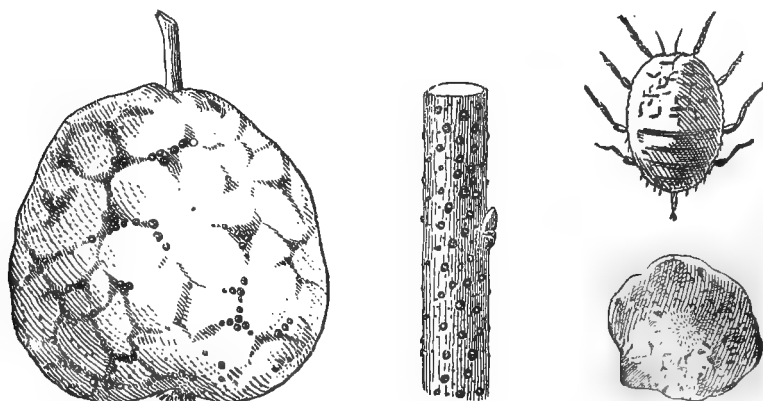

San Jose Scale on Fruit and Twig. Young Scale and Mature Female.

also the form of the young, and the mature female, found by lifting the scale, the color of the insects being lemon yellow. The scale of the female is about one-sixteenth of an inch in diameter, with a yellowish center, and gray or black margin.

The Greedy or Pear Scale (Aspidiotus rapax).—This species affects many kinds of trees, deciduous as well as evergreens. Scale, about one-sixteenth of an inch in length; form, ovoid; color, drab; female, bright yellow. This insect is found in many places along the coast. It infests, chiefly, pear trees, hence its

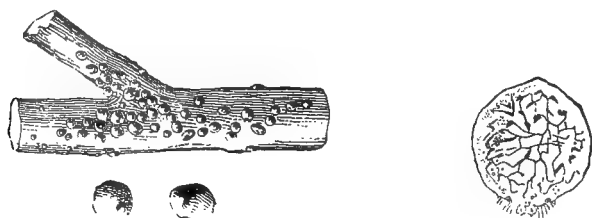

Pear Scale on Twig, and Mature Female.

name. It is distinguishable easily from the *Aspidiotus perniciosus* by its whitish-yellow color, contrasting with the dark color of the latter. Generally this scale has only one brood in the season, and, as compared with the San Jose scale, it is of little danger, owing to its slow-breeding propensities.

Oyster Shell Scale of Apple (*Mytilaspis pomorum*).—This is one of the few insects which the northeastern States have in common with us. Like the preceding one, it has only one brood during the season. It affects the apple chiefly, although sometimes the pear also. Owing to the thickness of the armor,



Oyster Shell Scale.

it is one of the most difficult of the scales to exterminate. It can be easily recognized by the engraving, which shows a piece of bark covered with it.

Rose and Berry Scale (*Diaspis rosae*).—This scale has such striking forms that it can be readily recognized. The round white scale is that of the female, the elongated one with ridges is the male. The rose scale infests, besides roses, various fruit bushes, especially blackberries and raspberries. Remedy: For raspberries and blackberries the cutting down of the canes to the ground should be adopted, and the stumps sprayed or washed with kerosene emulsion, recommended under the head of general remedies for scale insects.

Oleander Scale (*Aspidiotus nerii*).—This scale is small, flat, yellowish-white. It affects a great many trees, especially evergreens. Lemon trees become badly affected, and the fruit is sometimes completely covered. The olive is also subject, and the fruit of the olive when infested does not mature well, and wherever a scale is found, a green blotch shows its appearance.

Red Scale of Orange and Lemon (*Aonidia aurantii*).—This scale affects citrus trees in both the coast and interior regions. The scale fully grown is one-twelfth of an inch or a little more in diameter, center yellow, margin light brown. The appearance of trees infested with this pest is very striking, very much resembling those diseased from other causes, such as bad drainage, the leaf presenting a mottled appearance, a light blotch around the scale contrasting with the natural green of the leaf. The branches are but little troubled, but the fruit, like the leaf, becomes completely covered with the insects. An orange tree infested with this scale gradually becomes sickly and languishes.

Other Citrus Tree Scales.—Two scales more recently brought into this State from Florida are the "purple scale," *Aspidiotus citricola*, and the "long scale," *Aspidiotus gloverii*. The red and purple scales of citrus trees are only treated successfully by fumigation with hydrocyanic acid gas. This treatment is an elaborate one, requiring special appliances which are fully illustrated and described in Bulletin 122, which can be had

free by application to the Agricultural Experiment Station at Berkeley.

The Black Scale (Lecanium oleae).—This scale is almost a universal pest, especially in regions adjacent to the coast, though it has recently demonstrated its ability to endure interior valley conditions. It affects citrus fruit trees and some deciduous trees as well, and a fungus growing on its exudation causes the black smut, which renders tree and fruit unsightly; but this smut accompanies other scale insects as well as this one. It is especially troublesome on the olive, and will quickly spread to ornamental plants and vines in the garden. It is a very difficult scale to subdue. On citrus trees the fumigation method is the only practical recourse. On deciduous fruits it requires both winter and summer spraying to hold it in check. In spite of the fact that immense numbers are killed by parasites, and perhaps by fungi as well, it is still a grievous pest, and should be fought unceasingly.

Soft Orange Scale (Lecanium Hesperidum).—This scale is a pest of citrus trees the world over. The scale is ovoid, a little wider at one end than the other; length, from one-twelfth to one-seventh of an inch; color, dark brown on convex part, and a lighter brown surrounding margin; it has two indentations on each side, and one on posterior end. The engraving does not bring out these characters well, but shows the way in which the scale is seen on the leaf. It fortunately is usually held in check by natural agencies.

Brown Apricot Scale.—The apricot tree, though defying the most ruinous scales of some other trees, is beset by scales of the *lecanium* family. The black scale is one and the brown apricot

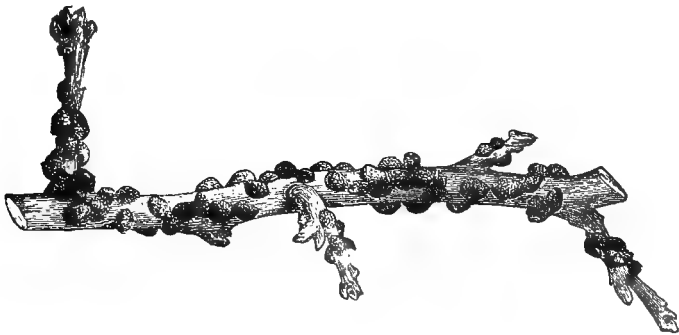

Brown Apricot Scale of Deciduous Fruit Trees.

scale another. It is *Lecanium Armeniacum*. This scale is boat-shaped; when reaching maturity, wrinkled; the color is a shiny brown, darker in the center, lighter at the edges. A full-sized

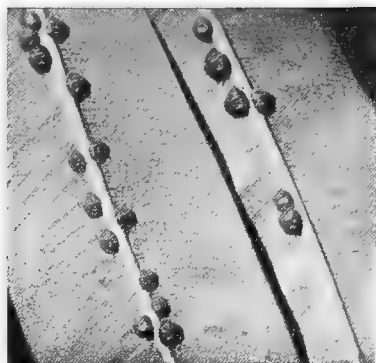

Black Scale (*Lecanium oleæ*).



Brown Apricot Scale (*L. armeniacum*).



Soft Orange Scale (*L. hesperidum*).

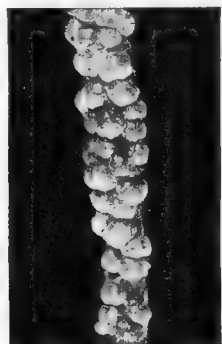

Cherry Scale (*L. insignicola*).

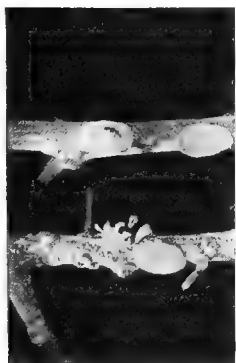

Frosty Scale (*L. pruniosum*).



Filbert Scale (*L. hemisphaericum*).

GROUP OF LECANIUM SCALES FROM THE UNIVERSITY COLLECTION.

scale has a length of a quarter of an inch, and a width of one-eighth of an inch. This scale attacks nearly all kinds of deciduous fruits, but especially the prune and apricot. It is a very hardy scale, and the remarks about the black scale apply to it also.

Other Lecaniums.—There are several other *lecaniums* on fruit trees: The filbert scale (*hemisphericum*), which is common in greenhouses and occurs to limited extent on citrus trees; the frosted scale (*prunosum*), very large, oval and convex, covered with dense, whitish bloom, occurs on deciduous fruit trees.

Cottony Cushion Scale or Fluted Scale (Icerya purchasi).—This promised at one time to be the most grievous of all scales in its rapid increase and wide range of food plants, but it was speedily reduced by an Australian ladybird, *Novius (Vedalia) cardinalis*, introduced by Albert Koebele, with such success that specimens are now rarely seen.

Mealy Bugs.—Closely allied to the scales are the mealy bugs (species of *dactylopius*), soft and of a pale pink color, generally covered with a whitish mealy powder, hence the name. The common species is found in nearly every greenhouse in the

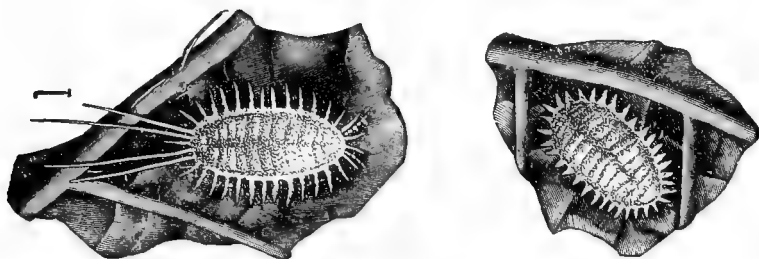

Mealy Bugs, Chiefly upon Citrus Trees.

world, and in California climate lives in the open air on many kinds of plants, and has at various times proved quite troublesome. Unless checked by natural enemies, the mealy bugs multiply very rapidly, and mass themselves in the corners of the leaves. The plants turn black from the fungus growth growing on the honeydew, and the bush presents the same appearance as a scale-infested plant. With the aid of a magnifier the appearance of the mealy bugs, as shown in the engraving, can be readily recognized.

Remedies for Scale Insects.—Though most of the scale insects are attacked by parasitic and predacious insects, as already stated, these natural agencies have only in certain cases proved rapid enough to cope with the increase of the scales, and insecticides have to be employed to save the fruit and trees. There is a vast number of these washes, many of which will do good

work if thoroughly applied, which is usually the secret of success. A few which have proved of special value will be given herewith:—

A WINTER WASH FOR DECIDUOUS TREES WHEN LEAFLESS.

Lime, Salt and Sulphur Remedy.—The following formula has been used with great success throughout the State: Forty pounds of unslaked lime, twenty pounds of sulphur, fifteen pounds common stock salt, water to make sixty gallons. Boil ten pounds of lime and the twenty pounds of sulphur in twenty gallons of water for an hour and a half, or until both lime and sulphur are dissolved. The sulphur must be thoroughly dissolved and mixed with the lime; the mixture will then be of an amber color. Then slake in an empty half-barrel thirty pounds of lime with soft hot water, using enough water to thoroughly slake the lime, and while it is boiling add fifteen pounds of common stock salt. When the salt is well dissolved, add the contents of the half-barrel to the hot mixture in the boiler and boil the whole for half an hour and add water enough to make a total of sixty gallons of spraying material, which will then be a thin whitewash. The material should be strained, after being thoroughly mixed, through a fine wire strainer. Apply the wash milk-warm or warmer, with a spray pump. Use only when foliage is off the tree.

WASHES FOR ALL TREES WHEN IN LEAF.

Kerosene Emulsion.—Take kerosene, two gallons; common soap, or whale-oil soap, one-half pound; water, one gallon. Dissolve the soap in the water and add it boiling hot to the kerosene. Churn the mixture by means of a force pump and spray nozzle for five or ten minutes. The emulsion, if perfect, forms a cream which thickens on cooling. Dilute before using, one part of the emulsion with nine parts of cold water. To obtain this emulsion in proper form violent agitation is necessary, the time required depending on the violence of the agitation and temperature of the mixture. Professor Cook's formula is this: "Dissolve in two quarts of water one-fourth pound of hard soap by heating to the boiling point, then add one pint of kerosene oil and stir violently from three to five minutes." This is best done by use of the force pump. This mixes the oil permanently, so that it will never separate. Add seven pints of water and the wash is ready for use.

Resin Soap.—Take twenty pounds of resin, two and one-half pints of fish oil, three and one-half pounds of caustic soda (98 per cent), and enough water to make one hundred gallons. Place all the ingredients together in the boiler with water enough to cover them three or four inches. Boil from one to two hours, occasionally adding water until the compound resembles very black coffee. Dilute to one-third the final bulk with hot water, or, if cold water is used, add very slowly over the fire, making a stock mixture to be diluted to the full amount as used. When spraying, the mixture should be perfectly fluid and without sediment. This mixture can be used twice or three times as strong on deciduous trees when dormant.

INSECTS BORING IN TWIG, STEM, OR ROOT.

The Common Borer.—An insect which has done vast injury in this State is the "flat-headed apple borer" (*Chrysobothris femorata*). It affects chiefly apples, peaches, and plums, which have been injured by sunburn. It is a pale-colored grub with

a brown head, the forepart of the body being greatly flattened. The matured beetle is greenish black or bronze colored, copper colored on the under side. If any tree receives any damage to the bark, either by sunburn or other causes, the borer is sure to find it, and it works itself into the tree, its castings being the only guide to its presence. The best remedy is prevention by

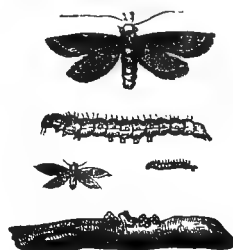

Flat-head Borer and Beetle.

Sun-scald
Borer.

Peach Moth and Its Boring Larva.

protection from sunburn, as described in Chapter XI. Whenever a borer is removed, the *debris* and dead wood should be entirely cleaned out and the smooth surface left, taking care to preserve the bark as much as possible. Then the wound should be smeared over with grafting wax, and a rag tied about it. In this manner young trees have been saved, but if seriously attacked, it is better to put in a sound tree and protect it.

Sun-Scald Borer.—Another borer which delights in sunburned trees is a minute beetle, making a burrow hardly larger than a pin-hole. It is known as the sun-scald beetle (*Xyloborus xylographus*). The remedy, as in the former case, is to prevent injury to the bark, for this precedes the attack of the beetle.

Peach Twig-Borer.—This grub is the larva of a moth (*Anarsia lineatella*), about half an inch in length when fully grown, and of a light reddish color. The moth, the worm (natural size and enlarged), and the manner of its working in the peach, prune or apricot twigs, are shown in the engraving. The first brood of worms bore into fresh young shoots of peach trees, the second into the fruit. Any infested shoots should be cut off and burned, and no hiding-places for the insects allowed. It is in the spring that they show their work most plainly by the withering young shoots. These must be cut off and destroyed. The most effective treatment, however, is winter spraying. The value of the lime, salt and sulphur wash for this purpose has been long known, but why it was successful was not known until Ed. M. Ehrhorn, horticultural commissioner for Santa Clara County, found that the larvae passed the winter ensconced in shallow burrows in the crotches of the limbs all through the

trees. The wash penetrates the borings which cover them, and kills. If it is not desirable to use this wash for scales or fungi in addition to the peach moth, kerosene emulsion, diluted with one part of the stock emulsion to six parts of water, is a cheaper treatment. It can be used from December onward through the winter. The kerosene reaches the worms in their winter quarters very successfully.

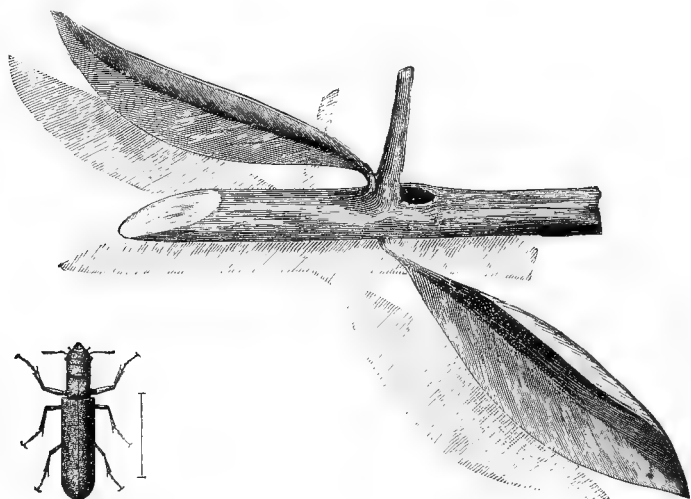

The Olive Twig-borer and Its Work.

The Olive Twig-Borer.—A reddish brown beetle boring into twigs of olive and other orchard trees, and grape canes, at the axils of the leaves. The insect is shown in the engraving, somewhat enlarged, as the line on the right shows the natural length of the insect. It is *Polycaon confertus*, and it breeds in decaying logs and stumps and old grape-vines, apparently visiting the fruit trees merely to gratify its appetite. Its work is not fatal to the tree, but unless proper pruning and attention be afterwards given, it may spoil the shape of a young tree. Remove the affected branches below the burrow of the beetle, or if it would be difficult to replace a branch, see that the beetle is destroyed and the entrance to the hole stopped up—this to prevent decay and a weak branch following. Spraying with ill-smelling solutions may prevent their attack, but the insect has not been sufficiently abundant to invite serious effort thus far.

Peach Crown-Borer.—A grub boring into peach trees just below the ground surface, its presence being shown by copious gumming. The insect, which has become quite troublesome in Santa Clara County, resembles the Eastern crown-borer of the peach, but is a distinct species (*Sannania pacifica*, Riley). The

best methods of suppressing this insect are two. A preventive treatment consists in coating the base of the tree a few inches below the surface and a foot above with a whitewash, with a pint of coal tar to each five pounds of quicklime, put in while



California Peach-borer.

the lime is slaking. This should be done in April. A killing treatment which has proved effective and safe to the tree is carbon bisulphide, when wisely used. Mr. Ehrhorn gives these precautions:—

Carbon bisulphide should not be applied when the soil is wet or just before a rain, nor just after cutting out borers and putting on lime and other preventives. Avoid putting it on the bark of the tree. Procure a machine oiler which will hold about eight ounces of carbon bisulphide, remove the soil around the trunk of the tree about six inches wide and six inches deep, being sure to detach all soil adhering to the trunk of the tree. After this is done, fill in this space with loose soil to the level again. Now squirt the liquid a few times from one to one and one-half inches away from the bark around the tree, and cover immediately with six inches of soil. Borers have been killed in from twenty hours to three days; after they are found to be dead, the soil should be removed from around the trees so that any remaining fumes of bisulphide can be dissipated.

Strawberry Root-Borer.—The larva of another clear-winged moth (*Acgeria impropria*), boring into the root of strawberry

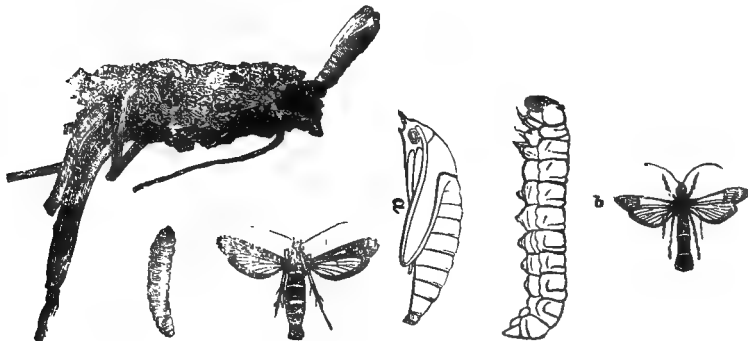

Strawberry Root-borer; Pupa, Grub and Moth. Currant Borer (enlarged) and Moth.

plants, found in various portions of the State, and doing considerable damage, forcing the growers to resort to replanting much

earlier than otherwise would be necessary. Flooding the vines has a great tendency to kill out the worms, and if the water was retained, say four or five days during the winter, all over the plants, doubtless all the larvae would be killed.

Currant and Gooseberry Borer.—A white worm eating out the central pith of currant and gooseberry plants—the larva of another clear-winged moth (*Aegeria tipuliformis*). Spraying with whale-oil soap after the crop is gathered, pruning out and burning in the fall of all old wood which can be spared, will reduce the evil.

INSECTS DEVOURING THE PULP OF FRUITS.

The Apple Worm.—The codlin moth (*Carpocapsa pomonella*) is one of the great pests of the State. Its appearance and manner of work are sufficiently shown by the engraving. It preys chiefly upon the apple and pear, but the quince and other large fruits are sometimes invaded by it. The first moths appear at some time after the blossoming of the apple, and deposit their eggs on the young fruit, or on adjacent leaves. The young worm hatches in from seven to ten days, generally seeks the eye or calyx, and eats its way into the fruit, and in twenty days

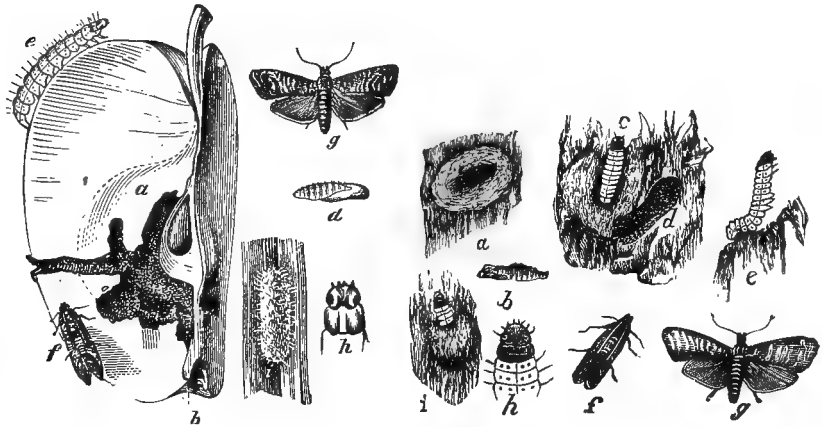

Codlin Moth in Various Stages in Fruit, and Wintering in Rough Bark.

its full growth is attained, and it goes out through the side of the apple, and, by means of its spinneret, reaches the ground or some large branch. If landed on the ground, it usually seeks the trunk, which it ascends and soon finds a hiding-place under the loose bark, where it spins its cocoon, and in eight or ten days comes forth a moth, ready to lay eggs anew. The egg is laid all over the fruit, and especially at a point where two fruits touch. Usually we have in this State two broods, at least, but

more often three, and, naturally, if unchecked, the increase from the first to the last is enormous. The worms escaping from the fruit in the fall hibernate as larvae under the loose bark of the tree, or in storehouses, or in any available dry place.

There is one sovereign remedy for the codlin moth, and that is the spray of Paris green. Its efficacy, when properly done and pure material is used, is demonstrated beyond question. It is possible to secure from 80 to 90 per cent of sound fruit where, without treatment, not 10 per cent would escape the worms.

It is essential that the poison go from a fine nozzle in a mist or cloud, and as soon as the mist covers the fruit and leaves with a film of moisture stop the spray on those surfaces. Let the fine particles of poison be planted by the medium of the mist upon every point of the surface. There must be *constant* stirring of the water in which the poison is suspended. An occasional stirring will not prevent settling and unequal distribution.

One spraying may suffice for an early apple or pear, but medium or late fruit should have two or three sprayings to reach the offspring of later broods of moths. The first spraying should be done, as a rule, later than was formerly advised, because it is now known that the moth does not visit the blossom, but the fruit after it has attained some size. It is a fact, however, that the little worms, on emerging from the eggs, generally seek the calyx or eye of the fruit for entrance, and it is important to have poison there. For this reason the first spraying should be done before the sepals close over the eye of the apple. The worm will make its way through these turned-down sepals and its poison should be ready for it inside. It is easier to thoroughly poison this cavity if the spraying is done while the little fruit still stands upright. Subsequent sprayings must be done, however, without regard to the position of the fruit. The later hatchings of the worms are more apt to enter through the sides of the well-grown fruit, especially at the point where the fruits are in contact with each other, and it is necessary to have the fruit continually covered with a film of the poison while these later broods are hatching out, spraying at intervals of three or four weeks, to be continued, less or more in number, according to the lateness of maturity of the variety.

Paris green often contains an undue amount of free arsenic, which is likely to injure the foliage seriously. For this reason a formula which guards against it is desirable: Stir one pound of Paris green and one pound of powdered lime, with a little water, into a thin paint, and then thoroughly mix this paint with cold water, so that the strength shall be one pound of Paris green to 160 gallons of water.

The Peach Worm.—As already stated, the larva of the peach moth, which early in the spring bores into the twigs, is sometimes found later in the season in the flesh of the peach. Hence the importance of saving the fruit by proper winter treatment of the hibernating worms.

ANTS AND YELLOW JACKETS.

These insects are often of serious trouble during fruit drying. Ants are most effectually disposed of by slightly opening their holes in the ground by thrusting down a crowbar and pouring in a couple of ounces of carbon bisulphide and closing again with earth. Yellow jackets also nest in the ground in old squirrel or gopher holes, and they too can be suffocated with carbon bisulphide or by pouring in gasoline or kerosene and firing it. Hornets which nest in trees are troublesome, but are much less numerous than the cave-dwelling species.

To destroy yellow jackets by trapping and poison is also feasible. W. F. Moyer, of Napa, proceeds in this way:—

Make a thin fruit syrup by mashing the boiling ripe fruit, strain it and add a little sugar. Place the syrup dishes on the drying ground where the "jackets" are thickest. When the top of the syrup is covered with drowned and drowning "jackets," scoop them out with the hand, and crush them with the foot. They won't sting unless you pinch them. As the syrup evaporates fill up the dishes with water. If a day or two should elapse when no fruit is cut, be sure the traps are well cared for, as they will swarm around them thicker than ever, especially if the weather is hot. For dishes to place the syrup in, cut kerosene cans so as to make two cans, each about six and one-half inches deep.

Poisoning to carry destruction to the young brood is also practicable. Dr. J. H. Miller, of San Leandro, saved his fruit in this way:—

I bought half a dozen beef livers, five pounds of arsenious acid and several pounds of baling wire. Cutting the liver into pieces as large as a man's fist, I put them into a hot solution of arsenious acid, and, bending the wire into a hook at each end, I suspended the pieces from the lower limbs of trees all around my drying-ground. The fruit was soon deserted, and the little insects busily working at the fragrant liver. The insects carried pieces of the liver to their nests, and besides causing the death of those that had been destroying my fruit, the next generation of yellow jackets was also destroyed, and so complete was the destruction that there were not enough of the little pests in that neighborhood the following year to require a repetition of the treatment. There is no risk in so using the poison, for the yellow jackets will not return to the fruit, and bees will not go near the meat.

The Diabrotica.—A light green beetle with twelve spots on his back (*Diabrotica soror*), is sometimes very injurious to early fruit, by eating into it when ripe. The insect also eats leaves and blossoms. As the insect attacks the fruit just as it is ready to pick, it is impossible to apply any disagreeable or poisonous

spray. Sometimes the insects are driven away by dense smoke from fires in and around the orchard.

The Dried Fruit Worm.—Dried fruit is often seriously injured after packing, by a small worm, larva of a moth not yet determined. The eggs are deposited on the fruit either while drying or while in the packing-house, or through the cloth of the sacks, or seams of the package. The eggs may be killed on the fruit before packing, by dipping in boiling water, or by heating in an oven and after that preventing the access of the moth. Infested fruit can also be treated by bisulphide vapor, the method being the same as described for nursery stock below.

DISINFECTING NURSERY STOCK.

Cuttings, scions, young trees and vines, etc., can be freed from insects by inclosing in a tight box or cask and placing a saucerful of carbon bisulphide on the top of them, covering it with canvas or any tight-fitting cover. The bisulphide vapor will destroy all insect life in forty minutes.

Disinfecting such materials on a larger scale is done by Alexander Crow, State quarantine officer, in this way:—

Use square canvas sheets, sixteen to twenty feet in diameter, made of the best ducking, double stitched and then painted with boiled linseed oil to make it gas proof. The canvas must be perfectly dry before it is rolled up, or it is liable to be destroyed by spontaneous combustion. To fumigate evergreen stock use one ounce of cyanide of potassium (in lumps, not pulverized), one fluid ounce of commercial sulphuric acid, and two fluid ounces of water to one hundred cubic feet of enclosed space. For deciduous and hardy trees, when dormant, use one-fourth more of each of the above. When the canvas has been placed over the stock to be fumigated, prepare the charge. Take a three or four-gallon glazed earthenware jar, into which pour the necessary quantity of water, then the sulphuric acid, and place it well under the canvas, the edges of which are secured with soil or in some way so as to prevent the gas escaping, with the exception of the edge immediately in front of the jar. The proper amount of cyanide of potassium is then dropped into the jar from a long scoop, and the tent is immediately closed, and remains so for one hour.

It is hoped that this chapter will convey useful hints in the warfare against insects. Whenever questions arise which are not met thereby, appeal should be made to the University Experiment Station at Berkeley.

CHAPTER XXXVII.

DISEASES OF TREES AND VINES.

A few suggestions concerning pathological conditions which arise in trees and vines and prescription of treatment and remedies may be helpful: First, diseases demonstrated to be caused by fungi and bacteria; second, abnormal conditions, of which the causes are not yet clear.

Powdery Mildews.—Fungi which bring upon the leaf surface the appearance of a whitish powder and afterwards cause the leaf to curl and dry without producing marked swelling, perforation or discoloration, can be checked by the use of sulphur. The chief of these is the mildew of the grape, the mildew of the apple, appearing chiefly on the young growth, etc. The way to use sulphur for these fungi is described in Chapter XXV.



Apple and Pear Scab on Fruit, Wood and Foliage.

Leaf-Spotting, Puncturing or Deforming Fungi.—These classes are usually distinguishable by the results they produce. The mildew of the peach produces dense, whitish patches on the leaves and growing fruit; the curl-leaf fungus of the peach pro-

duces swellings and contortions of the leaf; the scab of the apple and pear produces first a smoky appearance on the leaf and afterwards causes black scabby patches on the fruit and on the young twigs; the shot-hole fungus of the apricot, plum, cherry, and almond cuts roundish holes in the leaves as though a shotgun had been discharged through the foliage, and then, in the case of the apricot, produces roundish, dark red pustules on the fruit; the rust fungi of the prune, blackberry, etc., produce eruptions on the under sides of the leaves, first of a yellowish or orange color, changing to dark brown or black, and causing the leaf to fall. These fungi are only slightly, if at all, checked by the dry sulphur treatment, and are best subdued by the use of copper solutions:—

The Bordeaux Mixture.—Lime, four pounds; bluestone (sulphate of copper), four pounds; water, forty gallons. Use part of the water to slake the lime and dissolve the bluestone, which should be done in separate vessels. The bluestone should not be put in a metal vessel. If put into a bag and suspended near the surface of the water, it will dissolve more readily, or hot water may be used in making the solution. Both should be cold when mixed, and the resultant mixture will be a beautiful blue wash. If mixed hot, a black compound (copper oxide) is produced, which reduces the value of the wash. After thorough mixing of the solutions, water should be added to bring the bulk up to forty gallons.

This is safe to use on foliage. It may be used much stronger when trees are dormant,—as strong as ten pounds of lime and ten pounds of bluestone to forty gallons of water to kill spores of fungi on the bark. This is a successful preventive of curl-leaf on the peach, shot-hole on the apricot, scab on the apple and pear, rust on the prune, etc. It should be followed by the weaker Bordeaux in the summer, as early as indications of the diseases may appear. In spraying for apple and pear scab, the addition of one pound of Paris green to each one hundred and fifty gallons of the Bordeaux Mixture makes the application answer also for the codlin moth.

Ammoniacal Copper Carbonate.—Copper carbonate, four ounces; ammonia, forty ounces; water forty gallons. When it is desirable to use a fungicide on fruit near the picking season, or on ornamental plants, which would be disfigured with the lime wash, the ammoniacal copper carbonate may be substituted for the Bordeaux Mixture.

The usual way of making this wash is to dissolve copper carbonate in ammonia, and then dilute. If the carbonate is not fully dissolved before the water is added, it can not be further dissolved, and not only is the carbonate wasted, but the fluid will not be up to standard strength. It is well, therefore, to give the ammonia ample time to act, say overnight, before adding the water.

It is cheaper to make copper carbonate as follows: Bluestone, six ounces; sal-soda, eight ounces; ammonia, forty ounces; water, forty gallons. Dissolve the bluestone and sal-soda separately in small quantities of hot water, the former in a wooden or earthenware vessel. After cooling, mix and dissolve the copper carbonate thus produced in the ammonia and add the remainder of the water to make forty gallons.

Lime, Salt and Sulphur.—This mixture, already prescribed for scale insects in the preceding chapter, is an active fungicide for winter use. It is a very satisfactory curl-leaf preventive in the interior valleys.

Toadstool Destruction.—Trees are often destroyed through invasion by toadstool fungi from decaying roots or wood with which their roots come in contact. The injury is often not detected until the tree is ruined and it is too late for treatment. If only part is affected, the disease may sometimes be arrested by cutting away the diseased parts and disinfection of the exposed tissue with the Bordeaux Mixture.

Moss, Lichens, etc., on the Bark.—It has been clearly shown by investigation at the University Experiment Station that the growth of moss, etc., upon the bark of fruit trees is a decided injury. All trees should be assisted to maintain clean, healthy bark. This is accomplished by the use of the lime, salt and sulphur mixture already prescribed for scale insects. It can also be done by winter spraying with caustic soda or potash, one pound to six gallons of water.

Blights and Decays.—There are several blights which are traceable to bacteria, parasitic growths which are not discernible as are the fungi, and not usually amenable to spray treatment, because they exist wholly within the tissues of the plant and are not reached by applications. The blights of the pear, the black-heart of the apricot, etc., are instances. Cutting back to healthy wood and burning all removed parts is the best treatment which can at present be prescribed.

A local disease which has been demonstrated by Newton B. Pierce, of Santa Ana, is the bacteriosis of the English walnut. The disease is recognized by black sunken spots on the hull of the young walnut; generally worst at the blossom end and usually first seen there early in the season; later the spots run together and encompass considerable areas of the surface. As the disease progresses the nut is transformed into a hateful black mass and is utterly destroyed. The disease also affects the leaves and young wood. The fallen nuts and leaves should be plowed under deeply or gathered and destroyed. The tree should receive careful pruning to remove all diseased parts. It may be well to spray young trees in the winter with the Bordeaux Mixture for the purpose of disinfecting the tree as perfectly as possible.

DISEASES NOT TRACEABLE TO PARASITIC GROWTHS.

There are a number of prominent troubles which are not traceable to parasitic invasion of any kind, and yet may be in some cases promoted by bacterial growth invited by preceding conditions.

Sour Sap.—There is a fermentation of the sap, quite noticeable by its odor, which may be found in all parts of the tree, from the root to the topmost twigs; sometimes in one part and not in another. Sour sap in the root is generally due to standing

water in the soil, and the remedy is drainage. Trees thus affected make an effort to grow and then the young growth shrivels. Severe cutting back of the top to reduce evaporation until the roots can restore their feeding fibers is the only treatment of the tree, and its success depends upon the extent of the root injury. Sour sap may also be caused in the branches by the occurrence of frost after the sap flow has actually started. Cutting back the diseased parts, as soon as discovered, to sound wood, is the proper treatment.

Die-Back.—Dying back of twigs or branches may occur without parasitic invasion through root-weakness or partial failure. It may be due to standing water or to lack of soil moisture, either of which will destroy the root-hairs and bring the tree into distress. The treatment is cutting back to sound wood and correcting the soil conditions, either by irrigation or drainage, as one or the other may be needed to advance vigorous growth in the tree.

Gummosis.—This is a convenient term to designate the gumming which is seen on many kinds of trees. As has been said of die-back, gumming may result from excess of water or of drouth in the soil. Gumming is, therefore, not considered in itself a disease, but rather an indication of conditions unfavorable to the thrifty growth of the tree. It has been usually found by investigation that trees in perfect condition of health, with the moisture just enough and not excessive, are not troubled with gumming; but there are cases in which this statement does not wholly apply. There is very much in this connection which is not fully demonstrated as yet. Many treatments are proposed. It is a good thing to cleanly remove all the unhealthy bark—cutting clean to sound bark and covering the wound with paint or wax to exclude the air. Some report success with an antiseptic wash—diluted crude carbolic acid and the Bordeaux Mixture have both been used, and reported upon favorably.

Root Knots.—These are excrescences upon the roots or at the root crown of various trees and of grape-vines, and they have been a serious trouble in this State for a good many years. Although the knot has been studied by experts in plant pathology, no exact cause of the trouble has yet been found. A satisfactory treatment has, however, been discovered. If the knot has not increased in size sufficiently to seriously interfere with the growth of the tree it can be smoothly removed, the wound treated with the Bordeaux Mixture, and the knot will not reappear at the same place. Success has also been had with boring a hole into the knot and filling the hole with bluestone solution. Bluestone can be used with least danger when the tree is dormant.

CHAPTER XXXVIII.

SUPPRESSION OF INJURIOUS ANIMALS AND BIRDS.

The beasts of the field and the fowls of the air are sometimes such grievous trespassers upon the fruit plantation that protection has to be sought against them. The animals which figure in this evil work are mainly species of *rodentia*, some of them burrowers, as, for example, the ground-squirrel and gopher; others, surface dwellers, like the hare or jackass rabbit. Occasionally there is injury done by deer in the orchard and vineyard, and coons in the melon patch, but these larger animals may usually be left to the hunters and the dogs.

RABBITS.

Though there are three species prevalent, none are burrowers. This fact has led to united efforts at their suppression by driving them, with mounted horsemen, from a wide stretch of country into a narrow, fenced inclosure, where they are killed with clubs. During the last few years tens of thousands have been killed in this way, and comparatively few are now found in the localities where the method has been adopted. Still, however, there are plenty at large to vex the fruit planter, and he must protect himself against them.

Rabbit Fences.—The surest protection against rabbits is a fence which prevents their entrance, and many miles of such fence have been built in this State. Several styles prevail. The ordinary board fence, with the boards running horizontally, is made rabbit-proof by placing the lower boards close together, with openings of but about two inches between them. A barbed wire, with barbs about two and one-half inches apart, can be used to advantage by running it along at or a little below the surface of the ground to prevent scratching under.

The cost of board fences has led to the use of barbed wire and wire netting, or of perpendicular slats interwoven with wire. Such materials are sold in large quantities. A very effective combination of barbed wire and netting, which is used in the upper San Joaquin Valley, is described as follows:—

The tall posts are regular split redwood posts. The intermediate small ones are made by sawing in two the regular posts and splitting

them into eight small posts, or rather, large stakes. The netting is of galvanized wire, No. 19 gauge, and one and one-half-inch mesh. This netting is stapled to the posts and stakes on the inside, or toward the field. This is of prime importance, as it will not serve the purpose if it is placed on the outside. The bottom of the netting is to come down to the ground, and the ground must be left hard, and not plowed, to prevent burrowing or scratching the dirt from underneath, which can be easily done if the dirt is softened up. It is not at all necessary to

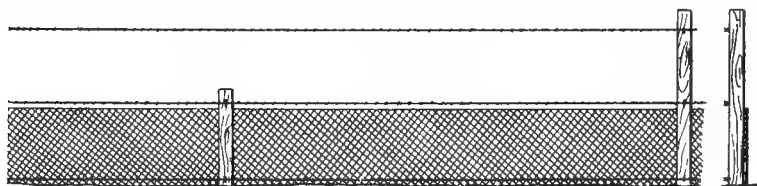

A Rabbit-proof Fence in Successful Use in Miramonte Colony, Kern County.

set the netting below the ground. In the sketch are shown three barbed wires, with barbs two and a half inches apart. These wires must be placed on the outside of the posts. This position is also a prime necessity. The lower wire is stretched just clear of the surface of the ground. The middle wire is one inch higher than the top of the netting, and the top wire, which is intended only as against cattle, is at a height suitable for the purpose. The rabbit-proof portion is comprised in the netting and the two lower wires. Hence, if cattle are not feared, and rabbits are the only foe, the top wire can be dispensed with, and the posts can be all short with a greater proportion of stakes, having only enough stout posts to stand the strain of the wires. The theory of this construction is that a rabbit can only pass the fence over the top or under the bottom of the netting, and this is effectually prevented by the barbed wires, which tear the animal if it attempts either to leap or climb over, or to scratch under.

Smears Distasteful to Rabbits.—Where the expense of a fence can not be assumed, measurable protection can be had by sprinkling the leaves or smearing the stems of plants with substances distasteful to the animals, which are quite dainty in this respect. Commercial aloes, one pound to four gallons of water, both sprinkled on leaves and painted on the bark, gives a bitter taste, which repels rabbits. A tea made by steeping quassia chips is said to produce the same effect. Rancid grease, liquid manure, putrescent flesh or blood, have been approved as a daub for tree trunks, but the efficacy is only of limited duration.

Rabbit Poison.—Pieces of watermelon, cantaloupe, or other vegetable of which they are very fond, may be poisoned with strychnine and then scattered around the orchard. Rabbits will not touch the bark as long as they can find this bait, and one meal is effective, for the rabbit never gets far away from it. The same results can be attained by the following mixture. To one hundred pounds of wheat take nine gallons of water and one pound of phosphorus, one pound of sugar, and one ounce oil of

rhodium. Heat the water to boiling point and let it stand all night. Next morning stir in flour sufficient to make a sort of paste. The rabbits eat it with avidity if scattered about.

Another preparation is half a teaspoonful of powdered strychnine, two teaspoonfuls of fine salt, and four of granulated sugar. Put all in a tin box and shake well. Pour in small heaps on a board. It hardens into a solid mass. They lick it for the salt, and the sugar disguises the poison, which kills great numbers.

GROUND-SQUIRRELS.

Ground-squirrels are poisoned by the use of the poisoned wheats which are sold in the markets, or by use of bisulphide of carbon, or "smokers," which are arranged to force smoke into the holes. A small quantity of bisulphide of carbon poured into the hole, and the hole closed with dirt, is probably the most effective squirrel killer, when the ground is wet, so that the vapor is held in the burrow. Smokers are also most effective when the soil is moist. When the ground is dry, poison is the best means of reducing squirrels. The following is an exceedingly effective preparation, of which a few grains should be placed in or near each hole:—

Take strychnine, one ounce; cyanide of potassium, one and one-half ounces; eggs, one dozen; honey, one pint; vinegar, one and one-half pints; wheat or barley, thirty pounds. Dissolve strychnine in the vinegar; and you will have to pulverize it in the vinegar, or it will gather into a lump. See that it is all dissolved. Dissolve the cyanide of potassium in a little water. Beat the eggs. Mix all the ingredients together thoroughly before adding to the barley. Let it stand twenty-four hours, mixing often. Spread to dry before using, as it will mold if put away wet.

To keep squirrels from gnawing fruit trees, or climbing and getting the fruit, tying a newspaper around the trunk of the tree, letting the paper extend out four inches at the upper edges, is said to be effective. The rattle of the paper when the squirrels attempt to get over it will frighten them.

GOPHERS.

Gophers can often be destroyed by the use of poisoned wheat, especially if prepared with a little oil of rhodium, which seems to be very attractive to all rodents. Pieces of fruits or vegetables into which a few grains of strychnine have been inserted by making a cut with a knife-blade and then squeezing it together again, are also handy conveyors of death to gophers. There are two ways to put poisoned materials into a gopher runway. One is to look for fresh open holes and put in the poison as far as possible with a long-handled spoon; another is to take a round, pointed stick and shove it in the ground near the

gopher mounds until it strikes their runway, then drop in the poisoned bait. Close up the hole with some grass; level down mounds, so that if the poison does not kill all the gophers, you will soon discover their new mounds. If there are many mounds, put the poison in a number of places.

Bisulphide of carbon is also successfully used in killing gophers, while the ground is wet, using an injector which is furnished with the poison to force the vapor through the long burrows.

Trapping Gophers.—Some are very successful in using gopher traps, of which there are several styles sold. Gophers come to the surface in the night, and generally close their holes soon after daybreak. They frequently emerge again about noon, and a third time late in the afternoon. It is best to set the trap in an open hole; still, the holes may be opened if the dirt is still fresh, with a good prospect of the gopher's return. Therefore, the trapper may make his rounds three times a day, as above indicated. Care should be exercised in preparing the hole for the insertion of the trap, a straight hole for a distance of at least ten inches, with no lateral branches, otherwise the gopher in pushing out the dirt will likely enough thrust the trap to one side, cover it up, or spring it, without being exposed to its grasp. The trapper should be supplied with at least two varieties of traps—one for the larger gophers, and the other for the smaller ones. The common iron gopher trap, which springs downward, is excellent for the former, and the small wire trap, which springs upward, is generally successful with the latter. The size of the hole is indicative of the size of the gopher. Either trap should be inserted nearly its full length into the hole, pressed down firmly, and a little dirt piled at the outer end to prevent its being easily pushed out. After the trap is set, it is well to cover the opening with some grass or weeds. Sometimes the holes require a little enlarging, but care should be taken to make the fit as close as possible, that the body of the gopher may be kept near the center, and thus more exposed to the prongs of the trap. In the fourth place, the trapper should have a small spade and a little gouge-shaped implement for trimming the hole.

Gopher Pitfalls.—If gophers are abundant, large numbers can be captured in this way: Dig a trench around the orchard or vineyard about the width of a spade and from fourteen to sixteen inches deep. In the bottom of the ditches, about a hundred feet apart, sink five-gallon oil cans, leaving the tops level with the ditch bottom. The gophers migrate in the night, and in attempting to come into the inclosure will fall into the ditch and then run along the bottom until they drop into the cans. Of course the ditch must not be wider than the cans. As many as fifteen live gophers have been found in one can. The cats

soon learn to help themselves out of the cans. The ditch must be kept clean, and if any roads cross the tract, set up a board at night, to compel the gophers to tumble in the ditch. This ditch should be constructed about the first of June, when the outside feed begins to dry up, and the pests rush for the cultivated ground. With such protection from the outside, and the use of poison and traps inside, the trees and vines can be saved.

DESTRUCTIVE BIRDS.

Fruit growers generally appreciate the value of insectivorous birds, but there are feathered pests which do such ruinous work in disbudding the trees in spring-time, and in destroying ripe fruit, that productive measures have to be adopted against them. The so-called "California linnnet," which is not a linnnet, but a finch (*Carpodacus frontalis*), a persistent destroyer of buds, and the English sparrow, infamous the world over, are probably the most grievous pests, though there are other destructive birds, including the beautiful California quail, which is protected by law, and yet must be destroyed in some parts of the State or the grape crop must be abandoned.

For the killing of the smaller birds poison is usually employed, and it is best administered in water. Poisoned water made of one-eighth ounce strychnine to three gallons of water and placed in shallow tin pans in the trees, has been widely approved. Cutting oranges in halves, spreading strychnine over the cut surface and empaling the half-oranges on twigs high up in the apricot trees, has destroyed hundreds of linnnets. Some advocate the use of the shotgun, No. 30 caliber, with a small charge of good powder and No. 10 shot. As many as five hundred linnnets have been killed in two days. The advantage of this plan is that one kills linnnets and not other birds, while poison kills both friends and foes.

CHAPTER XXXIX.

PROTECTION FROM WIND AND FROSTS.

Though the climate of California renders unnecessary the protection against rigorous weather which fruit growers in some other parts of the world have to provide, there is often advantage in securing shelter from winds and protection from late frosts.

The general subject of forest planting in California, and the effect of preservation and extension of our forest area upon our fruit industries, has received the attention of our best-informed growers. The planting of shelter belts at intervals across our broad valleys at right angles to the courses of prevailing or most violent winds, has also been urged with great force. These greater enterprises and projects are beyond the scope of this treatise. It is rather concerning the planting of trees to shelter individual possessions that a few suggestions will be offered.

It has been already remarked that on the immediate coast the successful growth of fruit will sometimes be wholly dependent upon proper shelter from prevailing winds, and in regions farther from the ocean the topography may induce strong currents of air which will illy affect trees and vines. In all such places the fruit grower should plant windbreaks, and will find himself well repaid for the ground they occupy, by the successful production on the protected area.

In the interior valleys there is also need of shelter from occasional high winds which may visit the orchards either in summer or winter, and prove destructive both to trees and fruit. In some cases long lines of sheltering trees have been cut down because they affected the fruiting of orchard trees planted too near them, and afterwards the losses through lack of protection were far greater than would have been incurred by retaining them.

What Kind of Trees to Plant.—This is a question concerning which there is much to be learned. Data is accumulating in the growth of trees planted to test their suitability, and the future planter will have more certain ground to proceed upon than is now available. Mention will be made, however, of a few trees, which are now most widely grown.

The most widely-planted shelter tree is the *Eucalyptus globulus*, or Australian blue gum. It is a rapid grower and voracious feeder, and wonderful for root extension, for which it has been roundly abused. It is doubtful, however, whether we have a better tree for high growth, and consequent large area over which its shelter will be felt. It is deficient in undergrowth, and if a close screen is desired, the planting of eucalyptus and Monterey cypress (*Cupressus macrocarpa*) is a common practise. The latter also attains good height, but its broad, thick base fills the gaps between the bare stems of the gum trees. . Another tree which has often been planted with the blue gum, to supply a thick, low growth, is the pepper tree (*Schinus molle*). It is also grown in rows by itself. It makes a dense head, grows rapidly, and flourishes without much care. Trees planted eighteen feet apart will soon come together and make a dense wall of very beautiful, bright, light-green foliage. The pepper is not only a good windbreak, but also an excellent dust-catcher. Unlike most trees which are used for this purpose, it does not become laden with dust. The leaves are smooth and glossy, and therefore repel the dust particles, which, stopped in their flight by the dense foliage of the tree, instead of clinging to it drop to the ground. The growth of the pepper tree near the coast is much slower than that of the Monterey cypress. The eucalyptus and the cypress for the coast, and the eucalyptus and pepper for the interior valleys, make, probably, as perfect a wall of foliage all the year round as can be had. The blue gum is, however, somewhat subject to frost killing, especially when young, and in very frosty places is objected to on that account. A number of other species of eucalyptus are now being planted, and are being found more hardy than the blue gum. The *polyanthema*, *amygdalina*, and *viminalis* are of this character.

The Monterey pine (*Pinus insignis*) is a rapid, high-growing tree, and, though a native of the coast, has proved itself well adapted to the interior valleys of the central portion of the State. Its foliage is dense for a pine, and its shelter, therefore, the more complete. A native white cedar (*Libocedrus accurrens*) has also been employed as a shelter tree in the San Joaquin Valley, and is commended as rapid a grower in the interior as on the coast. Its ability to stand drouth, heat and frost is said to exceed that of any of the conifers of the seacoast. It stands well in the most exposed situations, as its roots run very deep into the earth, and it is claimed that it does not sap the fertility from the soil around its base, as with the blue gum. It is also said to be less subject to frost injury than the Monterey cypress and pine.

All the foregoing are evergreen trees, and therefore afford protection summer and winter alike. Of deciduous trees there are many which may be well employed. The California black

walnut makes a very satisfactory growth both in the interior and upon the coast, and is largely used for roadside planting. The California broad-leaved maple (*Acer macrophylla*) is very beautiful, rapid in growth, and dense in foliage, and the same is true of the box elder (*Acer negrundo*), but probably both trees are especially suited to the coast regions. Of the poplars, the Carolina (*Populus monilifera*) is best, because of its breadth, density of foliage, and comparative freedom from suckering. The locust (*Robinia pseudacacia*) is used to some extent, but its suckering is very objectionable.

Quite a number of the larger-growing deciduous fruit trees are used to some extent along the exterior lines of orchards for the protection of the inclosure. The fig, the walnut, the chestnut, seedling almonds, and apricots are especially commended for such use.

Growing Trees from Seed.—Much that has been said in Chapter VIII will be suggestive to one who desires to grow his own shelter trees from seed. Trees from small seeds are best grown in boxes, and in many cases, as with eucalyptus and cypress especially, do best when put in permanent place when quite small. Whether put at once in permanent place, or in nursery, the land should be deeply worked and the young plant well planted and cared for.

Cultivation of Shelter Trees.—If one desires rapid growth of shelter trees, they should be cultivated the first few years as thoroughly as an orchard. Much disappointment results from allowing roadside trees to shift for themselves in a hard, dry soil. With such treatment the root extension is naturally most rapid into the cultivated orchard ground, which is undesirable. Cultivate and enrich the roadside, and the tree will grow chiefly on the waste land. At the same time the roadside will be prevented from producing vast quantities of weed seed, to be blown over the fence, and the place will have a name for neatness, which is too rare even in California.

PROTECTION FROM FROSTS.

Much attention has been given during recent years to the protection of citrus fruits as they approach maturity, and of deciduous fruits as they are starting on their growth, from occasional fall of the mercury a few degrees below the freezing point. It has been shown by ample experience that fruits may escape injury by a temperature of 28° if the ground surface is wet and the exposure be but of short duration. Fruit has, therefore, been saved by irrigation, while that over dry ground has been nipped by the same temperature. About the same result has been secured by checking radiation of heat by covering the orchard or vineyard with a cloud of smoke. Both these pro-

tective measures fail when the temperature falls a few degrees below 28° or when such freezing temperature is continued several hours. During the last few years, at Riverside, systematic invention and trial of frost prevention has proceeded, and the most satisfactory results are thus described by E. W. Holmes:—

Satisfactory results have been gained by the use of soft coal, burned in wire baskets suspended under or between the trees. When twenty to forty of these to the acre were used, we occasionally raised the temperature from three to five degrees. More has been claimed; but this is all that I am sure has been achieved. However, in a section where the temperature would not go below twenty-five or twenty-six degrees for a few hours, this method was ample. The outfit costs about ten cents a basket, or four dollars an acre if forty baskets are used, and the coal about two and one-half dollars an acre per night. The objection is the labor of replenishing the baskets in case of their being used the second night, because even if kerosene is poured upon the kindling, it is no easy task to light four hundred fires with a torch. Four men will be required to do this in proper time. Still, this is the system more generally approved here, and because definite and certain results have been achieved through it.

This refers to the protection of citrus fruits, the value of which as the crop is maturing will warrant the cost. With deciduous fruits thus far only smoke and steam clouds from burning piles of damp rubbish have been employed, except in irrigated regions where, if the frost threatens while the ground is dry, the limited efficacy of running water is resorted to. There is ample field for farther experiment in all lines of frost prevention.

Where there is trouble from early activity of deciduous trees the trees may be kept dormant for a limited time by winter spraying with whitewash, which reflects heat and thus prevents activity. Experiment has shown that heat upon the aerial parts of the tree start the growth; it does not come from the root as was formerly supposed.

PART TENTH: MISCELLANEOUS.

CHAPTER XL.

UTILIZATION OF FRUIT WASTES.

Some progress has been recently attained in the securing of horticultural by-products from various kinds of fruit wastes. There is a considerable product of cream of tartar from the pomace and lees of the wineries in central California. In southern California citric acid factories are largely using lemons rejected in packing, and some other by-products of citrus fruits have been secured in small quantities. Vinegar from wine and cider are, of course, made here as everywhere in fruit countries.

There has arisen also a profitable demand for fruit pits and apricot and peach pits, which formerly were burned, are now selling profitably—machinery for cheap extraction of the kernels having been contrived by California inventors. The kernels are bought by agents of European manufacturers of oils and essences.

The disposition of waste fruit by growers must, however, always lie chiefly in the line of feeding animals, and refuse fresh fruits of all kinds, and especially refuse dried fruits have nutritive value which should not be lost. A statement of the value of various fruits as compared with various cattle foods has been prepared by Prof. M. E. Jaffa, of the University Experiment Station, in the table upon the next page.

A good average of the pitted fresh fruits is represented by prunes. Using the equivalents in the table below for computation, it appears that if wheat bran costs \$15 per ton, fresh prunes would be worth as a substitute \$3 per ton; likewise, if cottonseed meal is selling for \$21 per ton, the prune value would be about \$2.75. At the market price of oat hay, the figure for fresh prunes should be nearly \$3 per ton.

The dried fruits naturally rank far above the fresh material as stock feed. Of the dried fruits represented in the table, raisins lead in food value; containing one and one-fourth to one

and one-half times the nutritive ingredients of alfalfa and oat hays, respectively; 100 pounds of the fruit being practically equal to the same quantity of grain, but to only eighty-two and fifty-nine pounds respectively of rice bran and cotton-seed meal.

COMPARATIVE VALUE OF FRUITS, AND HAY, GRAINS MEALS, ETC.

	100 POUNDS FRUIT EQUIVALENT TO POUNDS OF											
	Wheat Straw ..	Alfalfa Hay ..	Oat Hay	Corn	Barley	Oats	Wheat	Wheat Bran ..	Wheat Mid- dlings	Rice Bran	Cotton-seed Meal	Coconut Cake Meal
FRESH FRUITS.												
Apples.....	34	20	24	15	15	17	16	18	16	13	9	13
Oranges.....	33	19	23	14	14	16	15	17	15	12	8	12
Pears.....	40	23	30	17	18	20	19	20	19	15	11	15
Plums.....	50	30	36	22	24	25	24	26	24	20	14	20
Prunes.....	46	27	33	20	22	23	22	24	22	18	13	18
Apricots.....	40	23	29	17	18	20	19	20	19	15	11	15
Nectarines	43	26	30	19	20	22	21	23	21	17	12	17
Figs.....	50	30	37	23	24	26	25	27	25	20	14	20
Grapes.....	50	30	37	23	24	26	25	27	25	20	14	20
Watermelons.....	22	13	16	10	10	11	11	12	11	8	6	8
Nutmeg Melons	19	11	13	8	9	9	9	10	9	7	5	7
DRIED FRUITS.												
Dried prunes.....	175	104	125	78	82	88	84	92	84	67	48	68
Dried apricots.....	194	115	138	86	90	97	93	102	93	74	53	76
Dried peaches.....	190	113	135	85	88	95	91	100	91	72	51	74
Dried figs.....	186	110	132	83	85	93	89	97	89	71	50	72
Raisins.....	216	128	153	97	100	108	103	111	103	82	59	84

Dried apricots rank slightly lower than raisins, because they contain more water. Apricots are, however, of equal value as a feeding stuff with wheat bran, that is, the unsalable dried apricots are worth to the orchardist about fifteen dollars per ton for feeding purposes.

Prune-fed or raisin-fed pork is indeed an accomplished fact in California. As to the acceptability of the fruit diet to the hog what could be more pertinent and more fitting appendix to this treatise than this little tale? It is stated that Mr. Balaam, of Farmersville, used to have a pet pig that ran under the fig trees near the house. When the fruit began to drop, he ate figs and rested in the shade until he finally grew too fat to move about to gather the sweet morsels. By this time his owner became so much interested in the case as to carry him his regular figs three times daily. Gradually, he grew so fat that his eyes closed entirely and he was blind and helpless.

INDEX.

	PAGE.		PAGE.
Acorns, edible.....	43	Rome Beauty.....	196
Alkaline Soils.....	40, 49	Smith's Cider.....	196
Alligator Peat.....	387	Stark.....	197
Almond, The.....	406	Swaar.....	196
growing from seed.....	71	Twenty-ounce.....	194
hulling and bleaching.....	408	Vandevere.....	195
pruning.....	406	Wagener.....	199
situations and soils.....	406	White Astracan.....	194
wild.....	43	White Bellflower.....	195
varieties.....	409	White Winter Pearmain.....	196
Animals, injurious.....	459	Winesap.....	195
Ants, killing.....	452	Yellow Bellflower.....	196
Apple in California.....	187	Yellow Newtown Pippin.....	197
drying.....	427	VARIETIES: <i>Californian.</i>	
exposures for.....	189	Cook's Seedling.....	198
localities for.....	187	Marshall's Red.....	197
mildew.....	455	Skinner's Seedling.....	197
native crab.....	39	VARIETIES: <i>Crabs.</i>	
planting, distance.....	190	Hyslop.....	197
pruning.....	179, 190	Large Red Siberian.....	197
scab or smut.....	455	Large Yellow Siberian.....	197
second crop.....	188	Montreal Beauty.....	197
seedlings, growing.....	69	Transcendant.....	197
shipping.....	193	Whitney's.....	197
soils for.....	189	Apricot.....	200
Southern California.....	188	diseases of.....	208
storehouse for.....	191	distances for.....	204
summer and fall.....	193	drying.....	427
table of varieties.....	199	exposures for.....	200, 203
thinning.....	191	growing seedlings.....	70
varieties.....	192	irrigation.....	208
when to pick.....	191	localities for.....	200
winter.....	193	old trees.....	200, 207
worm.....	451	on almond root.....	203
VARIETIES: <i>Introduced.</i>		pruning.....	204
Alexander.....	194	shot-hole fungus.....	456
Baldwin.....	195	stocks and soils for.....	202
Ben Davis.....	195	table of varieties.....	210
Carolina Red June.....	194	thinning.....	207
Cayuga Red Streak.....	194	VARIETIES: <i>Introduced.</i>	
Duchess of Oldenburg.....	194	Bergetti.....	212
Early Harvest.....	194	Blenheim.....	211
Early Strawberry.....	194	Early Golden.....	210
Esopus Spitzenburg.....	196	Early Moorpark.....	211
Fall Pippin.....	194	Hemskirke.....	212
Fameuse.....	195	Large Early.....	210
Gloria Mundi.....	195	Large Early Montgamet.....	211
Gravenstein.....	194	Luizet.....	211
Hoover.....	195	Moorpark.....	212
Jonathan.....	195	Oullin's Early.....	211
King of Tompkins County.....	195	Peach.....	212
Lady.....	196	Royal.....	210
Lawyer.....	196	Shipley.....	211
Maiden's Blush.....	194	St. Ambrose.....	211
Missouri Pippin.....	196	VARIETIES: <i>Californian.</i>	
Newton Spitzenburg.....	195	Newcastle.....	212
Nickajack.....	196	Routier's Peach.....	212
Northern Spy.....	196	Sparks' Mammoth.....	212
Ortley.....	195	Army worms.....	435
Rambo.....	195	Banana, The.....	381
Rawles Janet.....	197	Barberry, native.....	42
Red Astracan.....	194	Berries and currants.....	389
Red Bietigheimer.....	194	Birds, poisoning.....	463
Rhode Island Greening.....	195	Blackberry, The.....	390
Romanite.....	196	cultivation.....	391

	PAGE.		PAGE.
distances for	390	Napoleon Bigarreau	226
longevity of	393	Oxheart	226
propagation	390	Pontiac	226
pruning	391	Reine Hortense	226
wild	40	Rockport Bigarreau	225
VARIETIES: <i>Introduced.</i>		<i>Royal Ann</i>	226
Crandall's Early	393	Schmidt's Bigarreau	226
Kittatinny	393	Tradescant's Black Heart	225
Lawton	393	Werder's Early Black	225
Wilson	393	White Tartarian	225
VARIETIES: <i>Californian.</i>		Yellow Spanish	225
Evergreen	393	VARIETIES: <i>Pacific Coast.</i>	
Mammoth	394	Bing	226
Borers	448	Black Republican	227
Bones, treatment of	158	California Advance	227
Bordeaux Mixture	456	Centennial	226
Budding, common method	76	Lewelling	227
June	78	Oregon	227
over old trees	85	Chestnut, The	409
spring	78	Choco or Cayota	382
Bud, cutting to a	133	Citron, The	380
Buds, dormant	85	Clearing land for fruit	57
Cactus fruits	43	brushy	61
Canned fruit product	421	cost of	58
Canker worms	435	steam puller	60
Caterpillars	436, 438	stump puller	61
Chain for hexagonal laying out	98	with powder	61
Chamisal and chaparral	58	time to cut to kill	63
Charcoal making	62	Climate, divisions of California	12
Cherimoyer	382	of California, characteristics of	9
Cherry	214	of California, why mild	11
delayed fruiting of	216	foot-hill	16
distances for	217	mountain	17
exposures for	217	coast	13
gum disease	222	valley	15
grafting the	221	value of	25
localities for	215	Cloudiness, east and west	23
old trees	214	Coast pests and diseases	14
pests and diseases	222	Codlin moth	451
pruning the	218	Composting	161
seedlings growing	69	Corner, to find true	94
slug	435	Cranberries	394
soils for the	215	wild	41
stocks for the	217	Crops between trees or vines	142
tables of varieties	224	Crystallizing fruit	422
wild	39	Cultivation	138
VARIETIES: <i>Introduced.</i>		hillside	147
American Amber	225	methods of	145
American Heart	225	shallow, results of	141
Arch Duke	226	summer	149
Baumann's May	225	to retain moisture	138
Belle d' Orleans	225	without plowing	150
Belle Magnifique	226	Currants	395
Black Eagle	225	culture of	395
Black Spanish	226	regions for	395
Black Tartarian	225	varieties grown	396
Burr's Seedling	226	wild	41
Cleveland Bigarreau	225	Custard apple	382
Coe's Transparent	225	Cutworms	435
Early Black Guigne	225	Cuttings, fruit trees from	73
Early Lamaurie	225	Dates	316
Early Purple Guigne	225	at the missions	316
Early Richmond	226	bearing age of	319
Early White Heart	225	bearing in Solano County	316
Elkhorn	226	blooming of	319
Elton	225	first fruit	316
English Morello	226	from seed	318
Governor Wood	225	from suckers	319
Grafton	225	propagation of	318
Great Bigarreau	226	requirements of	318
Guigne Marbree	225	transplanting	319
Guigne Noir Luisante	226	Dewberry	394
Kentish	226	Diabroticas	433
Knight's Early Black	225	Die-back	458
Late Duke	226	Drainage desirable	185
May Duke	226	Dried fruit (see fruits)	
Monstrueuse de Mezel	226	boxes for	427

	PAGE.		PAGE.
covering.....	424	from seed.....	283
cutting sheds.....	424	grafting.....	289, 293
dipping.....	426	mildew.....	307
grading and cleaning.....	426	planting devices.....	294, 296
packing.....	426	planting in rows.....	295
product of.....	421	products.....	54, 56
sulphuring.....	424	pruning.....	298, 307
sweating.....	426	pruning, long.....	302, 304
trays for.....	124	pruning, short.....	301
worm.....	433	resistant.....	293
Elderberries.....	40	rooting in nursery.....	287, 292, 295
Fertilizers, in California.....	154	soils for.....	282
caution in use of.....	163	stakes, twine, etc.....	305
for trees and vines.....	156	sulphuring.....	307
methods of applying.....	163	summer pruning.....	305
value of green.....	164	syrup.....	433
when necessary.....	155	varieties.....	309
Fig.....	321	wild.....	40
bearing age.....	327	wine, varieties of.....	315
budding.....	324	VARIETIES: <i>Introduced.</i>	
caprification.....	328	Almeria.....	314
drying.....	428	Black Corinth.....	314
foes of.....	329	Black Cornichon.....	313
from cuttings.....	322	Black Ferrara.....	313
from seeds.....	326	Black Hamburg.....	312
grafting.....	326	Black Malvoise.....	310
planting and pruning.....	327	Black Morocco.....	313
regions for.....	322	Black Muscat.....	313
size of old trees.....	321	Canon Hall Muscat.....	314
soils for.....	322	Chasselas de Fontainebleau.....	309
varieties, full list of.....	329, 330, 331	Chasselas Rose.....	310
Filbert growing.....	410	Chasselas Victoria.....	310
Frosts, protection from.....	466	Cinsaut.....	314
Fruit gardens, early.....	50	Early Black July.....	309
Fruit interest, extent of.....	54	Early Madeleine.....	309
Fruit tree acreage.....	55	Emperor.....	313
Fruit products, value of.....	56	Fehér Szagos.....	311
Fruits, crystallizing.....	422	Flame Tokay.....	312
drying.....	423	Golden Chasselas.....	310
drying floors.....	424	Gros Colman.....	313
graders.....	424	Huasco Muscat.....	311
grafted, first in California.....	48	Larga Bloom.....	311
value as stock food.....	469	Mission.....	310
Fruits, locations for.....	10	Muscat of Alexandria.....	310
Fruits, native.....	38	Muscatel.....	310
Fruit shipments, eastern.....	54	Muscatel Gordo Blanco.....	311
Fruit trees, dwarf.....	50	Muscat Frontignan.....	310
Gooseberry, The.....	396	Palomino.....	310
culture of.....	397	Purple Cornichon.....	313
requirements of.....	397	Purple Damascus.....	313
VARIETIES: <i>Introduced.</i>		Rose of Peru.....	312
Berkeley.....	397	Sabalskanski.....	314
Champion.....	398	<i>Sweetwater</i>	309
wild.....	41	Sultana.....	311
Gophers, killing.....	461	Thompson's Seedless.....	311
pitfall for.....	462	Verdal.....	314
trapping.....	462	White Champion.....	314
Grafting.....	79, 86	White Cornichon.....	313
bark.....	86	White July.....	309
cleft.....	81	White Malaga.....	311
root.....	82	White Tokay.....	314
side.....	82, 88	VARIETIES: <i>Californian.</i>	
top.....	86	Isabella Regia.....	314
whip.....	82	Grasshoppers, killing.....	440
wax for.....	80, 87	Growing season, long.....	25
waxed bands.....	80	Guava, The.....	383
Graft, time to.....	88	Gummosis.....	458
Grafts, planting out.....	83	Gypsum, uses of.....	160
Granadilla.....	383	Hard-pan, breaking up.....	146
Grape, area of.....	55, 281	Heat, deficient on coast.....	14
budding.....	285	importance of.....	19
conditions of ripening.....	22, 281	summer, records of.....	20
diseases of.....	307	Heeling in young trees.....	105
distance.....	294	Hexagonal planting.....	97
from cuttings.....	285, 296	Hillside, rows on.....	95
from layers.....	284	use of triangle on.....	98
		Huckleberries, wild.....	41

	PAGE.		PAGE.
Humidity, atmospheric	23	instead of cultivation	153
east and west	24	Nectarine	245
deficient	26	compared with peach	245
excessive	26	dried	246
Insects, injurious	434	future of	246
Irrigation	167	VARIETIES: <i>Introduced.</i>	
distributing manure by	164	Advance	246
ditches	173	Boston	247
drainage and	186	Downton	246
flooding	175	Early Newington	246
for citrus fruits	169	Hardwicke	247
for deciduous fruits	170	Humboldt	246
flume building for	174	Lord Napier	247
how much	168	New White	247
in early days	51	Stanwick	247
in basins or checks	175	Nitrogen for fruits	159
in furrows	174, 177	Nursery	66
in nursery	75	growing seedlings	69
leveling for	178	laying out and planting	83
locating contour lines	179	pruning in	84
manurial value of	164	selection of site for	67
measuring	183	soil, preparation of	68
methods of	173	soil, proper for	66
nursery	75	trees, ages of	84
reservoirs, small	179	trees, digging	104
running ditches for	177	trees, disinfecting	454
subirrigation	185	trees, selecting	103
suggestions for	184	when to plant in	73
summer	172	Nuts growing in California	406
taken from ditches	173	growing from seed	71
wells and pumps for	181, 182	Olives	333
wheels for	181	at old missions	46
when desirable	167, 171	budding	336
winter	171	climate for	334
Jajoba	43	from cuttings	334
Jujube of commerce	383	from seed	334
Jujube, native	42	grafting	338
Kai Apple	388	localities for	334
Knife for cling peaches	429	oil making	342
Lemon, The	373	planting	339
curing	376	pruning	339
planting and pruning	374	pickling	344
propagation	374	small cuttings	335
situations and soils for	374	soils for	334
VARIETIES: <i>Introduced.</i>	373	truncheons	336
Genoa	379	wild	43
Lisbon	379	VARIETIES: <i>Introduced.</i>	
Villa Franca	379	Ascolano	350
VARIETIES: <i>Californian.</i>	379	Columbella	349
Bonnie Brae	380	Corregliolo	350
Eureka	379	Empeltre	350
Lemon berry	42	Frantoio	350
Lice, leaf	439	Grossaio	350
Lime, The	380	Lecchino	350
VARIETIES: <i>Introduced.</i>		Lucques	349
Mexican	380	Macrocarpa	350
Imperial	380	Manzanillo	348
Lime, uses of	159	Mission	346
Loganberry	400	Nevadillo Blanco	349
Loquat, The	383	Oblonga	347
Manure, care of	160	Oblitza	349
Manuring at planting	109	Pendulina	349
Manzanita berries	42	Pendoulier	347
Map of orchard and vineyard	111	Polymorpha	349
Marls	159	Razzo	350
Mealy bugs	446	Redding Picholine	346
Melon shrub	386	Regalis	350
Melon tree	386	Rubra	348
Mission fruits	44	Sevillano	349
Moisture lost by weed growth	141	Uvaria	348
retained by cultivation	141	Orchard land, preparation of	90
Morning glory, killing	153	laying out in squares	92
Mulberry, The	398	alternating squares	92
Mulching after planting	111	double squares	92
		measure and sight	93
		measuring wire	93
		quincunx planting	95

	PAGE.		PAGE.
time for planting.....	106	Strawberry.....	240
Orange.....	351	Steady.....	243
budding.....	356	Stump the World.....	241
diseases.....	367	Susquehanna.....	242
distances for.....	358	Tuskena.....	240
from cuttings.....	73, 352	Wager.....	241
from layers.....	352	Wheatland.....	241
from seed.....	352	Yellow St. John.....	240
nursery.....	352	VARIETIES: Californian.	
planting in orchard.....	358	Albright's Cling.....	243
product.....	351	Briggs' Red May.....	240
pruning.....	361	California.....	243
seedlings, care of.....	352	Decker.....	244
situation and soils for.....	351, 352	Early Imperial.....	240
transplanting.....	359	Edward's Cling.....	243
VARIETIES, Introduced.		General Bidwell.....	243
Australian Navel.....	370	George's Late Cling.....	243
Bahia.....	369	Honest Abe.....	240
Kincquat.....	372	Lovell.....	242
St. Michael.....	370	McCowan's Cling.....	242
Maltese Blood.....	370	Muir.....	241
Mediterranean Sweet.....	370	McDevitt's Cling.....	243
Paper Rind St. Michael.....	370	McKevitt's Cling.....	242
Riverside Navel.....	369	Newhall.....	241
Ruby.....	370	Nichol's Orange Cling.....	241
Satsuma.....	371	Peck's Orange Cling.....	241
Tangerine.....	371	Persian's Cling.....	243
Valencia Late.....	371	Phillips' Cling.....	243
Washington Navel.....	369	Runyon's Orange Cling.....	241
		Sellers' Golden Cling.....	241
Palm nuts.....	43	Staley.....	243
Peach.....	228	Stilson.....	242
approved lists of.....	239	Wylie Cling.....	243
curl-leaf.....	236	Yellow Tuscany.....	243
diseases.....	236	Peanut growing.....	411
distance in planting.....	232	Pear.....	248
dormant buds.....	232	Bartlett, why popular.....	249
drying.....	428	characteristics in California.....	249
early bearing.....	229	diseases.....	255
grafting.....	236	distances for the.....	253
growing season of.....	25, 238	drying.....	428
localities for.....	229	for alkali soil.....	252
longevity of.....	232	irrigation.....	255
mildew.....	236	largest on record.....	248
moth.....	448	localities for.....	249
"peach-almond".....	232	on quince stock.....	252
pitting clings.....	544	propagation of.....	252
pruning.....	122, 233	pruning.....	253, 254
seedlings.....	70	seedlings, growing.....	69
soils for.....	230	slug.....	438
stocks for.....	231	soils for.....	250
tables of varieties.....	238	storing and ripening.....	256
thinning.....	235	tables of varieties.....	252, 257
VARIETIES: Introduced.		thinning.....	255
Alexander.....	240	VARIETIES: Introduced.	
Amsden.....	240	Bartlett.....	258
Bilyeu's Late October.....	244	Beurre Rosc.....	259
Crawford's Early.....	240	Beurre Clairgeau.....	259
Crawford's Late.....	241	Beurre d'Anjou.....	259
Elberta.....	241	Beurre Diel.....	258
Foster.....	240	Beurre Hardy.....	258
George Fourth.....	240	Bloodgood.....	258
Hale's Early.....	240	Clapp's Favorite.....	258
Hardy Yellow Tuscany.....	243	Comet.....	258
Health.....	243	Dana's Hovey.....	259
Henrietta.....	244	Dearborn's Seedling.....	258
La Grange.....	243	Doyenne du Comice.....	259
Lemon Clingstone.....	241	Duchess d'Angouleme.....	258
Levy's Late.....	244	Easter Beurre.....	260
Mary's Choice.....	240	Flemish Beauty.....	258
Morris' White.....	241	Glout Morceau.....	259
Oldmixon Free.....	240	Harvest.....	257
Orange Clingstone.....	241	Howell.....	258
Picquet's Late.....	243	Kieffer.....	260
Red Cheek Melocoton.....	240	Lawson.....	258
Salway.....	243	Leconte.....	260
Smock Free.....	243	Louise Bonne de Jersey.....	258
Snow.....	240	Madeline.....	257

	PAGE.		PAGE.
Onondaga	259	Red June	270
Pound	260	Red Egg	273
Seckel	258	Red Magnum Bonum	276
Souvenir du Congress	258	Robe de Sergeant	271
Vicar of Winkfield	259	Royale Hative	273
White Doyenné	259	Satsuma	270
Wilder Early	257	Simon	275
Winter Bartlett	259, 257	Victoria	272
Winter Nelis	259	Washington	272
VARIETIES: <i>Californian</i> .		Wickson	273
Block's Acme	259	Yellow Egg	273
P. Barry	260	VARIETIES: <i>Pacific Coast</i> .	
Pecan, The	411	Burbank's Seedlings	360
Persimmon, Japanese	384	California Red	271
Persimmon, Virginian	384	Clyman	270
Phosphates	157	Giant	275
Pineapple	385	Golden prune	276
Pine nuts	43	Silver prune	276
Pistachio, The	412	Splendor	276
Planting, conditions favoring	90	Sugar prune	276
cutting back after	112, 119	Tragedy prune	270
depth of	110	Pomegranate, The	385
operation of	108	Pomelo	372
preparing land for	90	Potash	158
speed in	110	Prickly Pear	43, 586
time for	106	Pruning	113
use of manure	109	bearing trees	126
Plowing, devices for	149	California style	116
orchard and vineyard	145	effects of	115
on hillside	147	gathering brush	133
to break hard-pan	146	influenced by location	117
without dead furrows	91	low, advantages of	114
Plow, laying off with	93	nursery	84
Plums and Prunes	261	purposes of	114
California false	39	saws, California	132
drying	429	times for	128
from the root	264	tools	131
in southern California	262	to renew old trees	130
localities for	261	vase form, origin of	117
myrobalan	263	vase form, securing	118
planting	265	wounds, covering	133
pruning the	265	Quince	278
seedlings	70	demand for	278
stocks and soils	262	propagation	278
table of varieties	270	pruning	279
wild	39	soils for	279
VARIETIES: <i>Introduced</i> .		VARIETIES: <i>Introduced</i> .	
Abundance	271	Apple	280
Agen, Prune d'	276	Champion	280
Bavay's Green Gage	277	Chinese	280
Botan	271	Orange	280
Bradshaw	271	Portugal	280
Bulgarian	276	Rea's Mammoth	280
Burbank	272	VARIETIES: <i>Californian</i> .	
Columbia	273	Pineapple	280
Coe's Golden Drop	276	West's Mammoth	280
Coe's Late Red	276	Quincunx planting	95
Damson	273	Rabbit fences	459
Duane's Purple	272	Rabbits, destroying	460
Fallenberg	277	poisons for	460
German prune	273	smears for	460
Green Gage	271	Rainfall, records of	12
Grosse Prune d' Agen	275	Raisin making	431
Hungarian prune	273	Raspberry, The	398
Ickworth Imperatrice	277	black-caps	400
Imperial Epineuse	276	culture of	399
Imperial Gage	273	varieties, popular	399, 400
Italian prune	277	wild	40
Jefferson	273	Red Spider	441
Kelsey Japan	273	Root-knots	458
Normand	271	Russian introduction of fruits	47
Peach	271	Salal	42
Petite Prune d' Agen	276	Scale Insects	442
Pond's Seedling	275	black	445
Prince Engelbert	273	brown apricot	445
Prune d' Agen	276	cottony cushion	446
Prunus Simoni	270		
Quackenbos	275		

	PAGE.		PA
filbert	446	wild	41, 42
pear	443	Strawberry tree	386
oleander	444	Sunburn, protection from	89, 112
orange, red	444	Sunlight, value of direct	21
orange, soft	445	Sunshine, records of	22
oyster shell	443	Temperature, lowest	20
rose and berry	444	Temperature, records of	12
San Jose	443	Thinning fruit	134
remedies for	446	Tomato tree	388
Salmon berry	40	Toyon	42
Sapota, white	387	Trees, activity and rest of	18
Scions, care of	79	healing in	105
selection of	80	selecting	103
Seed, growing trees from	70	Tree-setters	102
Seedlings, imported	72	Triangle for laying out	98
Service berry	42	Tussock moth	437
Soils for fruits	27	Vine (see grape)	
adobe	35	Walnut, black	414
alkali	37	Walnut, English	412
alluvial	32	bacteriosis	457
bed-rock or hard-pan	36	bleaching	418
Characteristics of California	28	blossoms of	416
classification of	30	culture and soils	414
clay	35	gathering and drying	417
defective	36	propagation and planting	414
granitic	35	pruning	415
loams	31	VARIETIES:	
mesa	32	Common or Los Angeles	418
plains	31	French varieties	418
red	32	Japanese	418
river bottom	32	Kaghazi	419
sand-hill ridge	32	Soft Shell	418
sedimentary or silty	33	Weed killing by cultivation	153
Sour sap	457	Weeds, evaporation by	141
Squirrels, destroying	461	Wild fruits of California	38
Strawberry	401	Windbreaks	464
care of	404	trees for	465
continuous bearing	401	Wine grapes	315
irrigating	403	Winery refuse as manure	162
laying out for	402	Winter-killing, unknown	20
planting	403	Wire, measuring	93
propagation	402	Woolly aphid	442
situations and soils	401	Yellow jackets, killing	452
varieties, popular	405		

PACIFIC RURAL PRESS

And California Fruit Bulletin

ESTABLISHED 1870

Thirty Years of Uninterrupted Success

THE ONLY WEEKLY PUBLISHED IN CALIFORNIA DEVOTED TO
AGRICULTURE AND KINDRED PURSUITS

The Standard Authority
on all branches of Pacific
rural life.

The author of this book
has been the horticultural
editor of the Pacific Rural
Press for the last 25 years.

Fruit growers the world
over have long learned to
look to the Pacific Rural
Press for reliable, practical
information, and experi-
ence of individual fruit
growers.

A High-Class Illustrated Paper

Sent Post-paid to Any Part of America for One Year—52 Issues—for

\$2.00

PACIFIC RURAL PRESS

330 Market St.

San Francisco, Cal.

TRUMBULL & BEEBE

GROWERS, IMPORTERS
and DEALERS in

Seeds, Trees and Plants



Catalogue on Application

419-421 SANSOME ST.

San Francisco, Cal.

Growers of Choice Vegetable Seeds

COX SEED CO.

INCORPORATED 1890

Importers and Exporters of 

VEGETABLE, FLOWER
FIELD and TREE SEEDS
CLOVER and GRASS SEEDS

OFFICE AND WAREHOUSE

411, 413, 415
Sansome St., San Francisco

Branch, 34 Gansevoort St., New York

The Name "Oliver"

Is a Guarantee of
Excellence



OLIVER'S ORCHARD and VINEYARD

Plows are Everywhere Acknowledged to be the BEST. They are Strong, Durable, Light Draft, Easy to Handle, Made of the Best Material, and First-Class in Every Respect.

We Supply Perfect Fitting Duplicate Parts

BEWARE OF IMITATIONS. Take none but the genuine, made only by the Oliver Chilled Plow Works, and sold only by our authorized agents.



Oliver Chilled Plow Works

13 and 15 Main St., San Francisco, Cal.

FANCHER CREEK NURSERY

FRESNO, CALIFORNIA

Offer a Complete Line of Deciduous Fruit, Olives, Citrus Trees, Ornamental Trees and Grape-Vines. A well-selected assortment of Palms, Roses, and Greenhouse Plants

We Offer Many New and Valuable Novelties

Send for Price List and Descriptive Catalogue_____



GEO. C. ROEDING, Proprietor

POTASH

is as necessary to plants as bread is to man. Some crops need more potash than others, but none can do without it.

The character of soils must also be considered, some soils being more deficient in plant food (potash, phosphoric acid and nitrogen) than others.

Every farmer should read our pamphlets containing full particulars of the large number of experiments made by Experiment Stations with fertilizers on different soils and crops.

These pamphlets can be had free on application.

GERMAN KALI WORKS, 93 Nassau St., N. Y.

Messrs. Meyer, Wilson & Co., of San Francisco, Calif., are our agents for the Pacific Coast



This is a Plow

And a GOOD ONE, Too

It will do better work and more of it than any other tool ever put into the ground.

Lightning Weeders get all the weeds. We have 'em 6, 8, 10 ft. cut.

DON'T FAIL to see our California Special "Handy" Fruit and Farm Truck. We make a specialty of tools for orchard cultivation

Write or call _____

**Allison, Neff & Co., 222 MISSION STREET
San Francisco**

Byron Jackson Machine Works

625 Sixth St., San Francisco, Cal.

Manufacturers
of _____

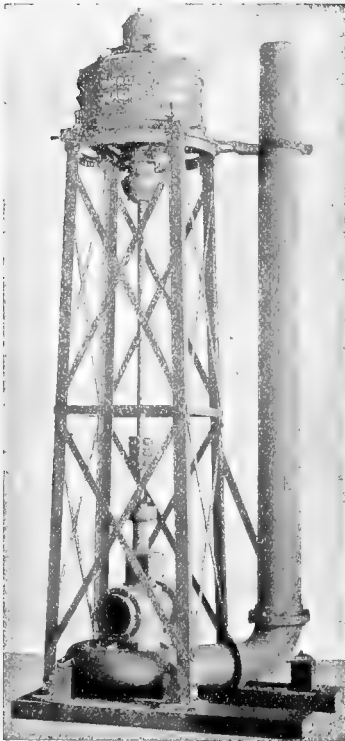

Wrought Iron Frame Supporting Motor,
Direct Connected to 8-inch Jackson Pat-
ent Balanced Vertical Centrifugal Pump.

CENTRIFUGAL PUMPS

Single and Compound, both Vertical and Horizontal, for city water works, irrigating, reclaiming, mining, dredging, pumping rocks, pulp, etc. We make special pumps either Single or Compound, Vertical or Horizontal, for direct connection to high-speed electric motors or water wheels, for any speed, capacity or head. Our pumps are all fitted with our

**Latest Improved
End Thrust
...Counter Balance...**

requiring no collars or thrust bearings on either Vertical or Horizontal Pumps. Our Patent Self-Oiling Bearings, either Vertical or Horizontal, are just adapted for Centrifugal Pumps, Dynamos, Water Wheels, or line shafting, and require no attention after once filled with oil.

Send For
Catalogue....



California Stump Puller

IS ECONOMICAL AND RAPID
FOR CLEARING OLD ORCHARDS



In the improved form in which it is now offered to the public, it is universally admitted to be the most practical, powerful, and successful machine of this kind in America, and the only machine in existence that can be successfully operated on hill-land. This stump puller is doing good work in many places throughout the Pacific States and Territories, Mexico, Central America and the Hawaiian Islands.

FIRST PRIZE AWARDED AT ALL
EXHIBITIONS

PATENT STEEL SNATCH BLOCKS
PATENT STEEL DRAFT HOOKS

An Illustrated Catalogue with full particulars will be sent for the asking.

A. BARNES, Manager

16, 18 Zoe St., San Francisco

PACIFIC

NURSERIES

Nurseries at
MILBRAE, SAN MATEO CO.

Office and Greenhouses and Sale Yard

BAKER and LOMBARD STREETS

San Francisco, Cal.

THE LARGEST STOCK on the Pacific Coast of Azaleas, Camellias, Rhododendrons, Roses, Palms, both hardy and indoor varieties; Araucarias and Ferns, Evergreen and Deciduous Shade Trees and Shrubbery for parks and gardens, in the best varieties. Coniferous trees consisting of Cypress, Pines, Spruce, Abies, Juniperus, Taxus Arbor Vitas, Cedrus, Retinosphora and Cryptomerias in small and large specimen trees.

F. LUDEMANN

2740 Lombard St., San Francisco, Cal.

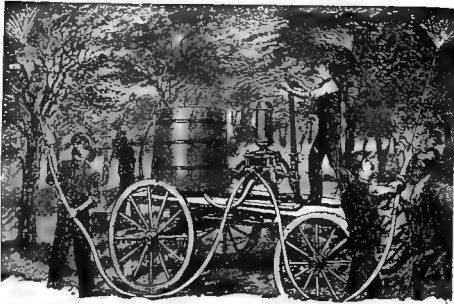

CHAMPION Spray and Whitewash

PUMP

The cut herewith illustrates our spraying pump—the "Champion"—and its adaptability to the work for which it is especially designed. As will be seen from the illustration, the pump is very complete and strong. It is perfectly double acting and has a brass-lined cylinder. The motion of the piston is horizontal. The handle is so arranged that the leverage is very powerful, and the movement is easy and natural. The air chamber is unusually large, admitting of the continuous discharge necessary for good and thorough spraying. We carry everything connected with spraying; also many other pumps. Send for special catalogue.

Webster 2 1-2 Horse-Power Gasoline Engine

\$185

2½ H. P. Simplest and Cheapest Gasoline Engine made. It requires no engineer. All expense stops when engine stops. Ready on five minutes' notice. No Ashes, Smoke or Dirt. Engine can be left alone, while running, for hours. It is designed for running Pumps, Printing Presses, Blowers, Grinding Mills, Fanning Mills, Machinery of all kinds—in fact, for general farm and other purposes. This size engine with the proper size pump will irrigate from 10 to 20 acres of fruit. Send for Special Catalogue and Prices—Mailed Free.

We carry 5, 8, 12 and 15 Horse-Power Gasoline Engines in Stock

...SEND FOR CATALOGUE

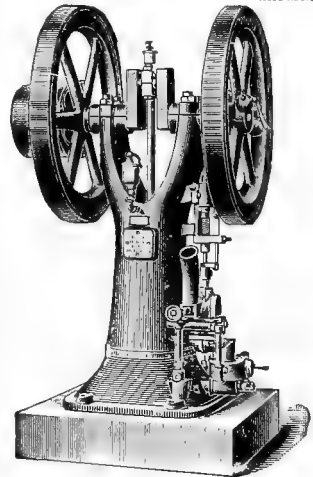

TANKS—All Sizes

Send for
Catalogue
Mailed Free

GEM

With Ball-bearing Bed Plate and Divided Boxes

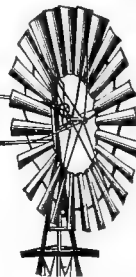

Send for Our Catalogue—Mailed Free

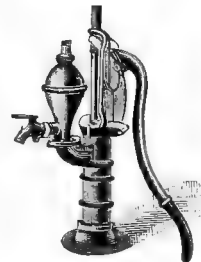

We also carry Tanks, Iron Pipe and Fittings, Brass Goods, Horse Powers, Deep Well Pumps, Power Pumps, Electric Pumps, Hose, Etc.

WOODIN & LITTLE, 312 and 314 MARKET STREET
San Francisco, Cal.

INCORPORATED 1884
500 ACRES

CALIFORNIA NURSERY CO.

Niles, Alameda Co., Cal.

TREES and PLANTS—Fruit Trees, Nut Trees, Wine,
Raisin and Table Grapes, Ornamentals, Shade Trees,
Evergreens, Shrubs, Roses, Climbing
Plants, &c.

SEMI-TROPICAL FRUITS:

OLIVES—A large collection of French, Italian and Spanish Varieties
ORANGE AND LEMON TREES of All Leading Sorts

For Complete List, Send for Our Catalogues



JOHN ROCK, Manager

California Nursery Co.,

Niles, Alameda Co., Cal.

The Sun Always Shines

on the Fruits and Flowers which
come from

BURBANK'S EXPERIMENT FARMS

For the whole world of horticulture acknowledges their great value. No establishment, public or private, since the dawn of history, has produced so many Vegetables, Trees, Plants, Grasses, Fruits and Flowers of

**ACKNOWLEDGED
UNIVERSAL VALUE**

The BEST are yet to come

Catalogue FREE to all



Luther Burbank

Santa Rosa, Cal., U. S. A.

COMMERCIAL MACHINE WORKS

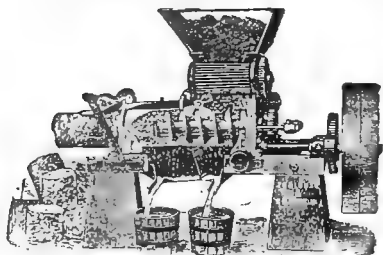

Continuous Wine Press—Saves its cost the first season.

..The California Wine Press..
(Patented)

Crushers and Stemmers Combined

✦
OLIVE OIL MACHINERY ^a *Specialty*

✦
TOULOUSE & DELORIEUX
Manufacturers

620-622 Commercial St., San Francisco, Cal.

G. G. WICKSON & CO.

34 & 36 MAIN ST.

SAN FRANCISCO.

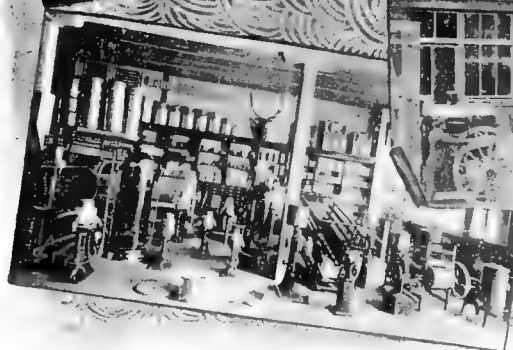

11 SOUTH BROADWAY
LOS ANGELES.

141 FRONT ST.
PORTLAND OREG.

SPRAYING PLANT

For Trees and Vines

This plant consists of a "Union" gasoline engine with oil tank, battery circulating tank and pump, complete; also a plunger pump for forcing the spraying mixture into the receiver—or compression chamber—a pressure gauge, a solution tank and pipes and fittings, all on a galvanized iron pan fastened to a wooden base, ready to be put on a wagon and connect hose. This outfit will do the work of a dozen men at trifling cost. Any desired pressure up to 250 lbs. may be had. The engine can be taken off and used for other purposes. It is a $2\frac{1}{2}$ h. p. with sensitive governor and all latest improvements.

..WRITE..
FOR
PARTICULARS

Union
Gas
Engine
Co.

316

Howard St.
S. F.

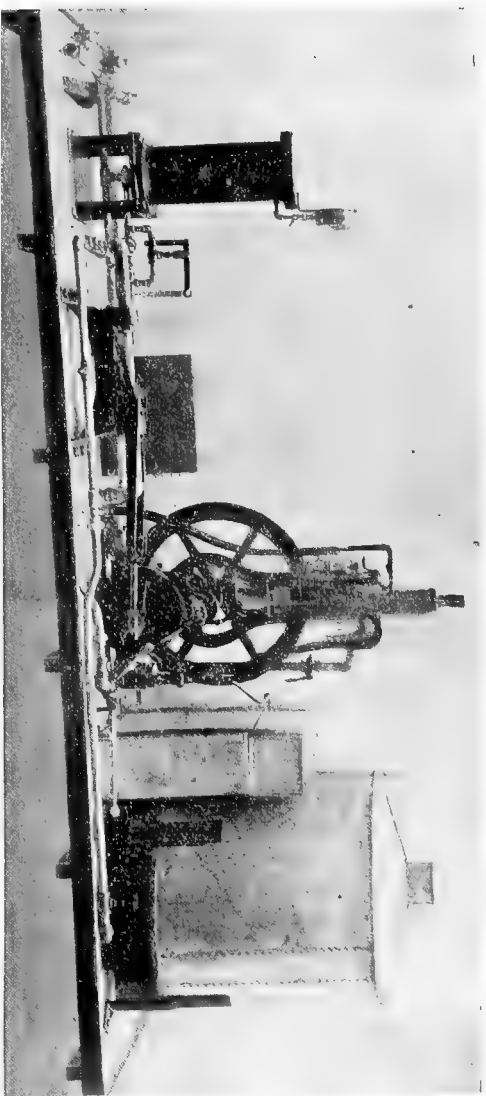

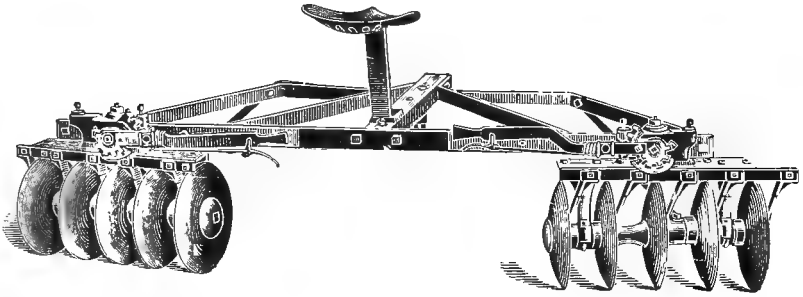

Pacific Reversible Disc Harrow

Showing Extension Head and Low Down Levers

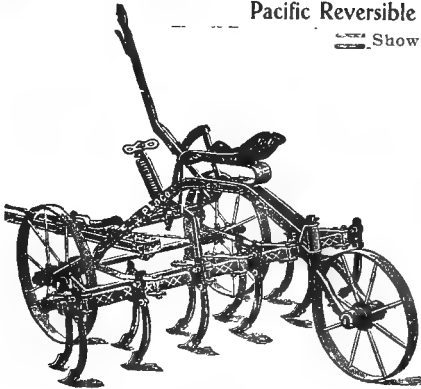

Canton Orchard Cultivator



Eclipse 5-Tooth Cultivator

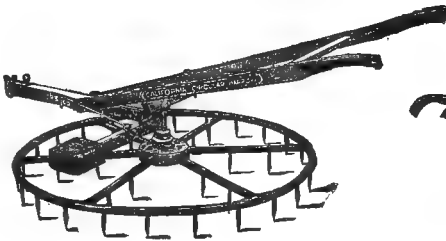

.. California ..
Circular Orchard Harrow

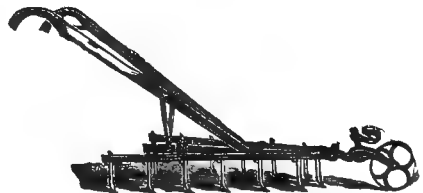

Eclipse 14-Tooth Vineyard Harrow

106

HOOKER & CO.

16 and 18 Drumm St.

San Francisco

